

Control

### PR02 PS/2 Switch with On-Screen Display Control up to 16 computers from one PS/2 console!

**EN** Switch with On-Screen Display - Control up to 16 computers from one PS/2 console

**FR** Switch avec affichage à l'écran - Contrôlez jusqu'à 16 ordinateurs à partir d'une console PS/2!

**DE** Masterswitch mit Bildschirmmenü - Zur Kontrolle von bis zu 16 Computern mit nur einer PS/2-Konsole!

**NL** Switch met On-Screen Display - Tot 16 computers beheren met slechts één PS/2-console!

**ES** Conmutador con OSD (menús en la pantalla) - Controla hasta 16 ordenadores desde una sola consola PS/2!

**IT** Switch con On-Screen Display - Per gestire fino a 16 computer da una console PS/2!

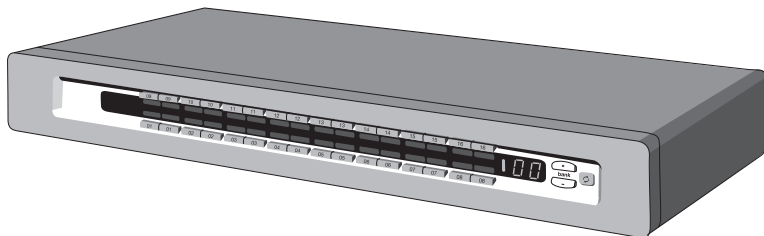

**User Manual • Manuel de l'utilisateur  
Benutzerhandbuch • Handleiding  
Manual del usuario • Manuale utente**

# Table of Contents

---

1	<b>Overview</b>	
	Feature Overview . . . . .	2
2	Equipment Requirements . . . . .	3
	Operating Systems . . . . .	4
3	Unit Display Diagrams . . . . .	5
	Specifications . . . . .	7
4		
5	<b>Installation</b>	
	Pre-Configuration . . . . .	8
	Step-by-Step Installation Guide . . . . .	9
6	Single PRO2 PS/2 Installation . . . . .	10
	Connecting Multiple PRO2 PS/2s (Daisy-Chaining) . . . . .	12
7	Powering up the Systems. . . . .	16
8		
9	<b>Using your PRO2 PS/2</b>	
	Selecting a Computer Using Keyboard Hot Key Commands . . . . .	17
	AutoScan Mode . . . . .	18
10	Selecting a Computer Using Direct-Access Port Selectors . . . . .	18
	Bank Up and Bank Down Scroll Buttons. . . . .	18
	On-Screen Display Menu Control . . . . .	20
	<b>Belkin KVM Switches and Accessories</b>	
	OmniView KVM Switches . . . . .	23
	OmniView All-In-One KVM Cables . . . . .	25
	OmniView Accessories and Adapters . . . . .	26
	<b>PRO2 PS/2 Series FAQs . . . . .</b>	<b>27</b>
	<b>Troubleshooting . . . . .</b>	<b>30</b>
	<b>Information . . . . .</b>	<b>34</b>

# Overview

---

Congratulations on your purchase of this Belkin OmniView PRO2 PS/2 Series KVM Switch

(the PRO2 PS/2). Our diverse

line of KVM solutions exemplifies the Belkin commitment to delivering high-quality, durable products at a reasonable price. Designed to give you control over multiple computers and servers from one console, Belkin PRO2 PS/2s come in a variety of capacities suitable for all configurations, large or small.

Offering intuitive port indicators, direct-access port selectors, high video resolution support, and flash upgradeable firmware.

The PRO2 PS/2 also comes with an unparalleled Belkin Three-Year Warranty.

This manual will provide details about your new PRO2 PS/2, from installation and operation to troubleshooting—in the unlikely event of a problem.

For quick and easy installation, please refer to the Quick Installation Guide included in your PRO2 PS/2 packaging.

## Package Contents

- OmniView PRO2 PS/2 Series KVM Switch
- Adjustable Rack-mount Brackets with Screws
- USB Flash Cable
- User Manual
- Quick Installation Guide
- 12-Volt DC, 1-Amp Power Supply
- Registration Card

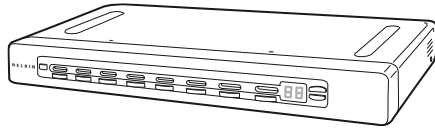

<b>1</b>	<b>section</b>
2	
3	
4	
5	
6	
7	
8	
9	
10	

1

The PRO2 PS/2s allow you to control up to a maximum of 256 PS/2 computers with one keyboard, monitor, and mouse. They support PS/2 input devices (keyboard and mouse) as well as VGA, SVGA, XGA, and XGA-2 video.

2

3

## **Feature Overview**

### **Hot Keys:**

Hot key functionality allows you to select a desired port using designated key commands. By using a simple hot key sequence on your keyboard, selecting one computer from as many as 256 computers is instantaneous. For a listing of complete hot key instructions and commands, see pages 17-19

4

5

6

### **AutoScan:**

The AutoScan feature allows you to set your PRO2 PS/2 to scan and monitor the activities of all operating computers connected to the switch—one by one. The time interval allotted for each computer can be defined or adjusted through the On-Screen Display (OSD) menu. For complete instructions on AutoScan usage, please refer to page 18.

7

8

9

### **Video Resolution:**

Through a 400MHz bandwidth, the PRO2 PS/2s support video resolutions of up to 2048x1536@85Hz. To preserve signal integrity at these higher resolutions, your PRO2 PS/2 requires 75-Ohm coaxial VGA cabling

10

### **Flash Upgrade:**

Flash upgradeable firmware allows you to install the latest firmware for your PRO2 PS/2. This enables your PRO2 PS/2 to maintain consistent compatibility with the latest devices and computers. Firmware upgrades are free for the life of your PRO2 PS/2. Refer to the enclosed flash upgrade instruction document or visit us at [belkin.com](http://belkin.com) for complete upgrade information and support.

### **On-Screen Display (OSD):**

The OSD feature simplifies server management by allowing you to assign individual names to each connected server throughout the system. It provides a visual means of switching between computers and setting the time interval for the AutoScan function.

## **Front-Panel Push Button:**

Direct-access port selectors, located conveniently on the front panel of the PRO2 PS/2, allow for simple, manual port-selection. Each button controls a port.

## **LED Display:**

An LED display on the face of the PRO2 PS/2 serves as a status monitor. An LED next to each direct-access port selector illuminates to indicate that the console currently controls the corresponding computer. As a port selector is pushed, the LED next to it will light up. A flashing port LED indicates that there is no computer connected to that port.

## **Seven-Segment LED Display:**

When daisy-chaining multiple PRO2 PS/2s together, the seven-segment LED display serves as a quick indicator of the selected BANK.

## **Equipment Requirements Cables:**

To connect to the PRO2 PS/2, each PS/2 computer requires one VGA cable, one PS/2 keyboard cable, and one PS/2 mouse cable. Keyboard and mouse cables must have PS/2 male-to-PS/2 male connectors. Video resolution support of up to 2048x1536@85Hz requires use of a 75-Ohm coaxial VGA cable to preserve signal integrity. VGA cables must have HDB15 female-to-HDB15 male connectors.

Belkin highly recommends that you use OmniView All-In-One PRO Series Plus Cables. These cables offer the highest quality possible to ensure optimal data transmission. All-In-One Cables are molded together for a clean and organized setup; are double-shielded to reduce EMI/RFI interference; have strain-relief construction for added durability; come with a ferrite bead for noise immunity; and include PC99 color-coded connectors for easy identification and connection. The PRO Series Plus Cables include an industry-standard, 14-pin, coaxial VGA cable and nickel-plated connectors for high-resolution applications.

# Overview

---

1

The following cables are recommended for your PRO2 PS/2:

2

## **OmniView All-In-One PRO Series Plus**

F3X1105b-XX (PS/2 Style)

(-XX denotes length in feet)



3

## **Operating Systems**

4

**OmniView PRO2 PS/2 Series KVM Switches are for use on CPUs using:**

5

### **Platforms:**

6

- Windows® 95/98/2000/Me/NT®/XP
- DOS
- Turbolinux® and all Linux® distributions
- Novell® NetWare® 4.x/5.x

7

8

### **Keyboards:**

- Supports 101-/102-/104-key keyboards

9

### **Mice:**

10

- Microsoft® system-compatible PS/2 mice having 2, 3, 4, or 5 buttons
- Microsoft system-compatible PS/2 wireless or optical mice

### **Monitor:**

- VGA
- SVGA
- MultiSync®

## Side View of the PR02 PS/2:

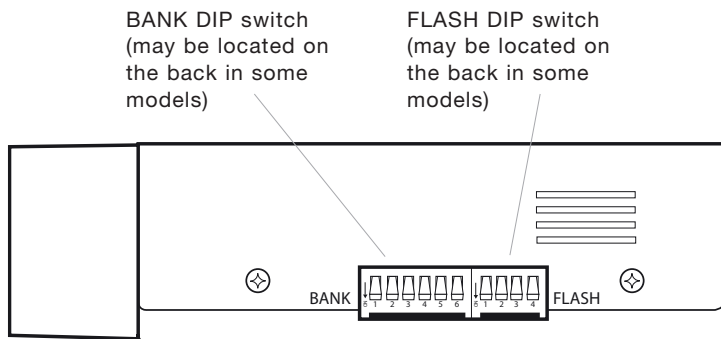

# Overview

section

1

## Front View of the PR02 PS/2:

F1DA108Pea

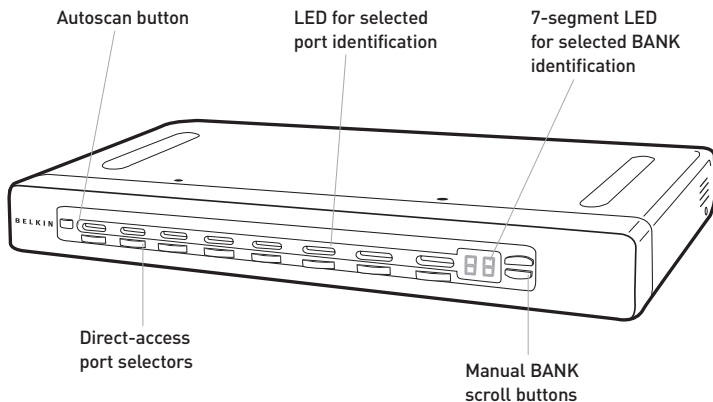

3

4

5

6

7

8

9

10

## Back View of the PR02 PS/2:

F1DA108Pea

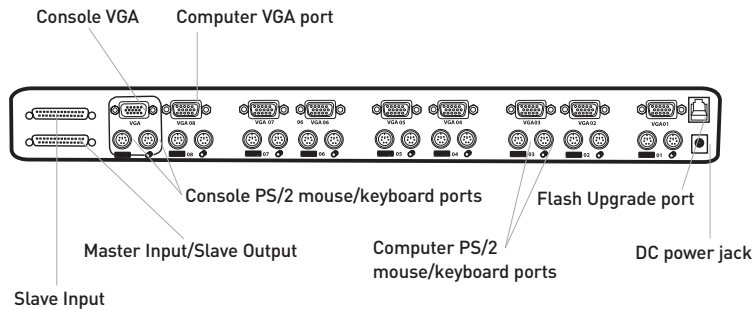



## Specifications

**Part No.:** F1DA104Pea, F1DA108Pea & F1DA116Pea

**Power:** 12-Volt DC, 1-Amp power adapter with center-pin positive

**polarity Daisy-Chain:** Maximum of 16 KVM Switches

**Computer Connections Supported:**

4 (F1DA104Pea)

8 (F1DA108Pea)

16 (F1DA116Pea)

**Keyboard Emulation:** PS/2

**Mouse Emulation:** PS/2

**Monitors Supported:** VGA, SVGA, MultiSync, and LCD (optional adapter may be required)

**Max. Resolution:** 2048x1536@85Hz

**Bandwidth:** 400MHz

**Keyboard Input:** 6-pin miniDIN (PS/2)

**Mouse Input:** 6-pin miniDIN (PS/2)

**VGA Port:** 15-pin HDDB type

**Port LED Indicators:**

4 (F1DA104Pea)

8 (F1DA108Pea)

16 (F1DA116Pea)

**Enclosure:** Metal enclosure with high-impact plastic faceplate

**Dimensions:**

(F1DA104Pea) 11 x 1.75 x 6 inch (279mm x 44.5mm x 150mm)

(F1DA108Pea) 17.25 x 1.75 x 7.5 inch (438mm x 44.5mm x 190mm)

(F1DA116Pea) 17.25 x 3.5 x 7.5 inch (438mm x 89mm x 190mm)

**Weight:**

(F1DA104Pea) 5.3 lbs. (2414.5 grams)

(F1DA108Pea) 9.2 lbs. (4181.5 grams)

(F1DA116Pea) 12 lbs. (5472.5 grams)

**Operating Temp.:** 32° to 104° F (0~40° C)

**Storage Temp.:** -4° to 140° F (20~60° C)

**Humidity:** 0-80% RH, non-condensing

**Warranty:** 3 years

**Note:** Specifications are subject to change without notice.

# Installation

---

1

## Pre-Configuration

2

### Where to Place the PRO2 PS/2:

The enclosure of the PRO2 PS/2 is designed for standalone or rack-mount configuration. The 8- and 16-port PRO2 PS/2s are natively rack-mountable in standard 19-inch server racks. Rack-mount hardware is included with these switches for a study rack installation. An optional rack-mount kit (F1D005) is available for use with the 4-Port PRO2 PS/2.

3

4

5

### Consider the following when deciding where to place the PRO2 PS/2:

6

- whether or not you intend to use the direct-access port selectors;
- the lengths of the cables attached to your keyboard, monitor, and mouse;
- the location of your CPUs in relation to your console;
- and the lengths of the cables you use to connect your computers to the PRO2 PS/2.

7

8

9

### Cable Distance Requirements:

VGA signals transmit best up to 25 feet. Beyond that length, the probability of video degradation increases. For this reason, we recommend that the length of the cables between the PRO2 PS/2 and the connected computers does not exceed 25 feet.

10

**Note:** If you need your console to reside further than 25 feet from the PRO2 PS/2, we recommend using the Belkin CAT5 Extender (F1D084vea2) with a standard CAT5 UPT cable. By using this device, you may increase the distance between your PRO2 PS/2 and your keyboard, mouse, and monitor by as much as 300 feet without risking signal degradation.

### Cautions and Warnings:

Avoid placing cables near fluorescent lights, air conditioning equipment, or machines that create electrical noise (e.g., vacuum cleaners).

## Step-by-Step Installation Guide

### Cautions and Warnings:

Before attempting to connect anything to the PRO2 PS/2 or your computer(s), please ensure that everything is powered off. Plugging and unplugging cables while computer(s) are powered on may cause irreversible damage to the computer(s) and/or the PRO2 PS/2(s). Belkin Components is not responsible for damage caused in this way.

### Installing the PRO2 PS/2 into a Server Rack:

#### Bracket Installation (F1DA108Pea and F1DA116Pea only)

Eight- or 16-Port PRO2 PS/2s include adjustable mounting brackets ideal for

installation in 19-inch racks. The mounting brackets feature three adjustment positions to allow the faceplate of the PRO2 PS/2 to mount flush to your rack-mounted servers, or to the rack. Please follow these simple steps to achieve the desired adjustment. The 4-Port PRO2 PS/2 requires an optional mounting kit (F1D005).

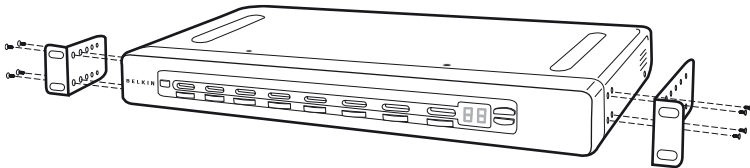

1. Remove the adjustable brackets from the box. (The adjustable brackets allow you to set the PRO2 PS/2's face flush with the ends of the rails or to extend the PRO2 PS/2 past the front of the rails).
2. Determine how far you would like the PRO2 PS/2 to protrude from the rack. Select a bracket-hole scheme.
3. Attach the bracket to the side of your PRO2 PS/2 using the Phillips screws provided. (Refer to diagram above).
4. Mount the PRO2 PS/2 to the rack rail assembly.

**Note:** If this PRO2 PS/2 will be daisy-chained to another PRO2 PS/2, set the BANK address prior to installing on a rack. Refer to the section in this user manual labeled "Connecting Multiple PRO2 PS/2s (Daisy-Chaining)".

1

2

3

4

5

6

7

8

9

10

Your PRO2 PS/2 is now mounted securely into the bracket and you are ready to connect cables to the back of the unit.

## Single PRO2 PS/2 Installation

This section provides complete instructions for the hardware setup of a single PRO2 PS/2. (F1DA104Pea, F1DA108Pea, and F1DA116Pea)  
PS/2 Installation: Keyboard, Video, and Mouse Connections

### Connect the Console:

1. Connect the monitor to the PRO2 PS/2. Attach your monitor cable to the HDDB15 female port on the back of the PRO2 PS/2 labeled “Console VGA”.
2. Connect the PS/2 keyboard cable to the keyboard port on the back of the PRO2 PS/2 in the “Console” section.
3. Connect the PS/2 mouse cable to the mouse port on the back of the PRO2 PS/2 in the “Console” section.

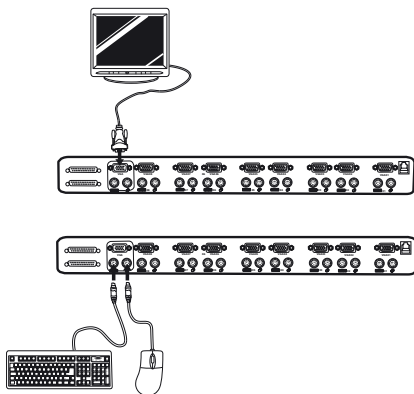

Attach the power supply to the DC power jack labeled “DC 12V, 1A” located on the rear of the PRO2 PS/2. Once the power is connected to a power source, the LED for port 01 will begin flashing. Sequentially push the direct-access port selectors for ports 01 through 08 (04 for F1DA104Pea and 16 for F1DA116Pea). The corresponding LED should flash as each button is pressed, indicating that the port is ready for connecting your servers (computer connection).

## Connect the Computer:

1. Using an OmniView KVM Cable (Belkin part# F3X1105b-XX, plug in the male VGA connector to the VGA port on the computer. Connect the other end (the female connector) of the VGA cable to the back of the PRO2 PS/2 labeled "VGA 01".
2. Connect the PS/2 keyboard and PS/2 mouse connectors of the cable to the keyboard and mouse ports on the computer. Connect the other ends of the cables to the keyboard and mouse ports located directly underneath VGA 01 on the PRO2 PS/2 (Belkin part # F3X1105b-XX).

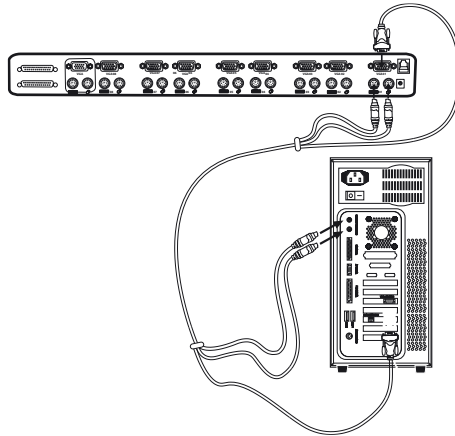

3. Repeat steps 1 and 2 for each additional PS/2 computer you wish to connect.

1

2

3

4

5

6

7

8

9

10

## Connecting Multiple PRO2 PS/2s (Daisy-Chaining)

You can daisy-chain up to 16 PRO2 PS/2s together, giving a server administrator control over a maximum of 256 computers. When daisy-chained together, each unit is referred to as a “BANK” and assigned an address. The Console keyboard, mouse, and monitor connects to BANK 00 and is referred to as the “Master” switch. BANKs 01 through 15 are referred to as “Slave” switches.

Note: A daisy-chain cable (F1D108-CBL) is required to daisy-chain each PRO2 PS/2 and is available through your Belkin reseller or online at [belkin.com](http://belkin.com).

All PRO2 PS/2s feature a “BANK DIP” switch. The BANK DIP switch is used for proper identification and use of PRO2 PS/2s in a single-unit or daisy-chain configuration.

- For a single-unit configuration, set the BANK DIP switch on the PRO2 PS/2 to the “Master” (BANK address 00) setting. This is the factory default setting.
- For multi-unit configuration, the BANK DIP switch on the Master unit must be set to “BANK address 00”. Slave units must be set to a unique BANK address (from 01 through 15). Refer to the chart below for BANK DIP switch settings.

## BANK DIP Switch Configuration Chart

DIP SWITCH#						BANK ADDRESS
1	2	3	4	5	6	
ON	ON	ON	ON	ON	ON	BANK 00 MASTER (default)
ON	ON	OFF	ON	ON	ON	BANK 01 SLAVE
ON	ON	ON	OFF	ON	ON	BANK 02 SLAVE
ON	ON	OFF	OFF	ON	ON	BANK 03 SLAVE
ON	ON	ON	ON	OFF	ON	BANK 04 SLAVE
ON	ON	OFF	ON	OFF	ON	BANK 05 SLAVE
ON	ON	ON	OFF	OFF	ON	BANK 06 SLAVE
ON	ON	OFF	OFF	OFF	ON	BANK 07 SLAVE
ON	ON	ON	ON	ON	OFF	BANK 08 SLAVE
ON	ON	OFF	ON	ON	OFF	BANK 09 SLAVE
ON	ON	ON	OFF	ON	OFF	BANK 10 SLAVE
ON	ON	OFF	OFF	ON	OFF	BANK 11 SLAVE
ON	ON	ON	ON	OFF	OFF	BANK 12 SLAVE
ON	ON	OFF	ON	OFF	OFF	BANK 13 SLAVE
ON	ON	ON	OFF	OFF	OFF	BANK 14 SLAVE
ON	ON	OFF	OFF	OFF	OFF	BANK 15 SLAVE

**Note:** “On” is the down position.

### Example:

Four 8-Port PRO2 PS/2s (F1DA108Pea) are daisy-chained together for controlling up to 32 computers. The DIP switch on the Master unit is set to “BANK 00” (factory default) and the Slave units are each set to a unique BANK (between 01 and 15).

1  
2  
3  
4  
5  
6  
7  
8  
9  
10

1

2

3

4

5

6

7

8

9

10

## **Before You Begin:**

1. Make sure that all computers are powered off and that each PRO2 PS/2 has been assigned a unique BANK address.
2. Place Master and Slave switches in the desired location. Make sure all are turned off and unplugged from the power source.
3. Connect the Console monitor, keyboard, and mouse to the Console ports of the Master switch or Bank 00, as described previously in this installation guide.

## **Connecting the Master Switch to the First Slave Switch:**

4. Using the daisy-chain cable (F1D108-CBL), connect one end of the cable to the “Master Input/Slave Output” port on the Master switch (BANK 00).
5. Connect the other end of the daisy-chain cable to the “Master Input/Slave Output” port of the first Slave switch (BANK 01).

## **Adding Additional Slave Units:**

6. Using the daisy-chain cable (F1D108-CBL), connect one end of the cable to the available daisy-chain port labeled “Slave Input” on the Slave switch (for example, BANK 01).
7. Connect the other end of the daisy-chain cable to the “Master Input/Slave Output” port of the Slave switch that you are adding (for example, BANK 02).
8. Repeat steps 6 and 7 for additional PRO2 PS/2s you wish to daisy-chain together.



## Example of Daisy-Chain Configuration:

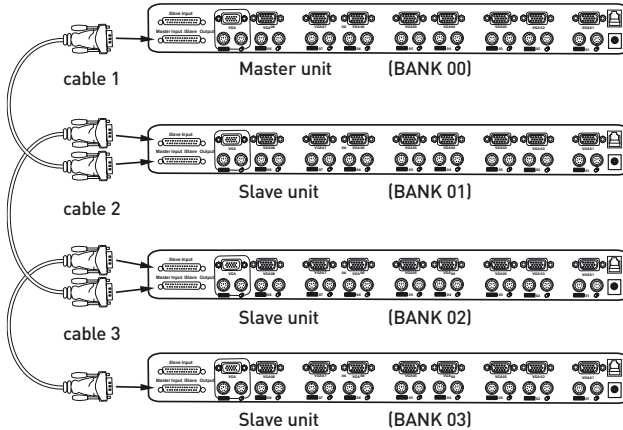

## Connecting the Computers:

9. Connect all computers to the Master and Slave switches. Refer to “Single PRO2 PS/2 Installation” on page 10 for instruction on how to connect the Console and the computers to the PRO2 PS/2.
10. Connect the power supply to the Master switch. Power up the Master switch. You should see the Master switch light up and display the digits “00”, indicating its BANK address.
11. Power up the Slave switches sequentially, beginning with Bank 01, by connecting each unit’s power supply. Each switch should display its corresponding BANK address number as it is powered up.

**Note:** If the PRO2 PS/2s do not enumerate correctly, reset the Master switch (BANK 00) by simultaneously pressing the “BANK +” and “BANK -” buttons. You can also reset the Master switch to detect newly added Slave switches. If the switches still do not enumerate correctly, check that all switches have the correct BANK address assigned to them and that all daisy-chain cables are connected properly.

12. Verify that the Master unit has detected all Slave switches by scrolling through the BANKS using the BANK up and BANK down buttons. If all Slave switches are detected properly, the LED display on the Master switch will register and display the attached Slave switch’s BANK address.

# Using your PRO2 PS/2

---

1

## Powering up the Systems

Once all cables have been connected, power up the computers that are attached to the PRO2 PS/2. All computers can be powered on simultaneously. The PRO2 PS/2 emulates both a mouse and keyboard on each port and allows your computer to boot normally.

2

3

The computer connected to port “1” will be displayed on the monitor. Check to see that the keyboard, monitor, and mouse are working normally. Proceed to do this with all occupied ports to verify that all computers are connected and responding correctly. If you encounter an error, check your cable connections for that computer and reboot. If the problem persists, please refer to the Troubleshooting section in this manual.

4

5

6

## Using Your PRO2 PS/2:

Now that you have connected your Console and computers to your PRO2 PS/2, it is ready for use. Select connected computers by either the direct-access port selectors, located on the front panel of the PRO2 PS/2, using the On-Screen Display, or by using hot key commands through the Console keyboard. It takes approximately 1-2 seconds for the video signal to refresh after switching computers. Re-synchronization of the mouse and keyboard signals also occurs. This is normal operation and ensures that proper synchronization is established between the Console and the connected computers.

7

8

9

10

## Selecting a Computer Using Keyboard Hot Key Commands:

Switch to the next or previous port with simple keyboard key sequences using the “Scroll Lock” key and either the up or down arrow keys. To send commands to the PRO2 PS/2, the “Scroll Lock” key must be pressed twice within two seconds. The PRO2 PS/2 will beep, confirming that it is in hot key mode. Next, press the up or down arrow keys, and the PRO2 PS/2 will switch to either the prior port or the next port.

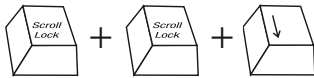

Switch to next active port—Down arrow

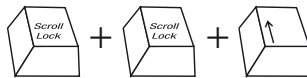

Switch to next active port—Up arrow

With a single-switch configuration (no daisy-chained switches), you can switch directly to any port by entering the two-digit number of the port you wish to access. For example, if you press “Scroll Lock”, “Scroll Lock”, “02”, the PRO2 PS/2 will switch to the computer on port 2 located on BANK 00.

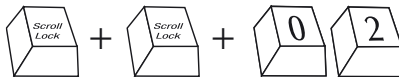

Switch to BANK 00, Port 2—[02]

**Note:** You will have approximately five seconds to complete each hot key sequence.

With daisy-chain switch configuration, you can switch between BANKS by pressing “Scroll Lock”, “Scroll Lock”, “Page Up”, to switch to the previous BANK. Press “Scroll Lock”, “Scroll Lock”, “Page Down”, to switch to the next BANK.

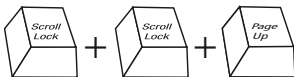

Switch to previous BANK—Page Up

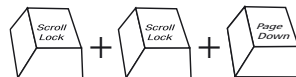

Switch to next BANK—Page Down

1

2

3

4

5

6

7

8

9

10

1

2

3

4

5

6

7

8

9

10

With a daisy-chain switch configuration, you can switch directly to any port on any BANK by pressing “Scroll Lock”, “Scroll Lock”, BANK address, and port number. For example, if you press “Scroll Lock”, “Scroll Lock”, “03”, “05”, the computer on BANK 03, Port 5 will become active.

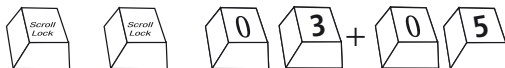

### AutoScan Mode:

Pressing the AutoScan button on the PRO2 PS/2 will activate the AutoScan function. In AutoScan mode, the PRO2 PS/2 remains on one port for a pre-set number of seconds, before switching to the next computer. This time interval can be adjusted via the On-Screen Display menu.

Note: There is no mouse or keyboard control in AutoScan mode. This is necessary to prevent data and synchronization errors. If the user is using the mouse or keyboard when the PRO2 PS/2 is switching between ports, data flow may become interrupted and could result in erratic mouse movement and/or wrong-character input when using the keyboard.

Press any button on the front panel or any key on the keyboard to disable AutoScan.

### Selecting a Computer Using Direct-Access Port Selectors:

You can directly select which computer you wish to control by pressing the direct-access port selector next to the corresponding port. The LED will illuminate to indicate the port is currently selected. If you are installing multiple PRO2 PS/2s that are daisy-chained, use the BANK scroll keys located on the front panel of the Master switch to access other computers that are connected to the Slave switches.

### BANK Up and BANK Down Scroll Buttons:

Pressing the BANK + and BANK – scroll buttons on the Master switch will allow you to switch between the daisy-chained PRO2 PS/2s. Pressing both buttons simultaneously will reset the PRO2 PS/2.

The BANK + button will take you to the next BANK. For example, when you are at the Master switch (BANK 00) and want to check computers on BANK 02, pressing the BANK + button will take you to BANK 02. As a default, the first active computer will be displayed on the Console monitor. Use the direct-access port selectors to go to the desired computer on BANK 02.

The “BANK –” button will take you to the previous BANK. For example, when you are at BANK 02 and want to check computers in BANK 01. Pressing the “BANK –” button will take you to BANK 01. As default, the first active computer will be displayed on the Console monitor. Use the direct-access port selectors to go to the desired computer on BANK 01.

### Keyboard Hot Key Commands:

Conveniently command the PRO2 PS/2 to switch ports through simple keyboard key sequences. To send commands to the PRO2 PS/2, the “Scroll Lock” key must be pressed twice within two seconds. You will hear a beep for confirmation. Below is a complete list of hot key commands:

**Note:** you will have approximately five seconds to complete each hot key sequence.

SL	SL	Up Arrow	Switch to PREVIOUS ACTIVE port
SL	SL	Down Arrow	Switch to NEXT ACTIVE port
SL	SL	Page Up	Switch to PREVIOUS BANK (By default, selects first active port on the BANK)
SL	SL	Page Down	Switch to NEXT BANK (By default, selects first active port on the BANK)
SL	SL	Y	Directly switches to PORT Y on BANK 00 (Single-Switch Configuration) Y=01 to 16
SL	SL	X Y	Directly switches to PORT Y on BANK X (Daisy-Chain Configuration) (X=00 to 15) (Y=01 to 04 for F1DA104T) (X=00 to 15) (Y=01 to 08 for F1DA108T) (X=00 to 15) (Y=01 to 16 for F1DA116T)
SL	SL	Delete	Reset On-Screen Display menu
SL	SL	S	Disable sound in AutoScan mode
SL	SL	Space Bar	Activate On-Screen Display
SL	SL	A	Enable AutoScan mode (Refer to AutoScan button)

1

## On-Screen Display Menu Control:

2

To access the On-Screen Display (OSD) menu, press “Scroll Lock”, “Scroll Lock”, and the space bar. Immediately, the OSD overlay screen will appear. The superimposed menu screen is generated by the PRO2 PS/2, and does not affect your computers or software function in any way.

3

4

The main OSD menu is shown below. It displays the current selected BANK. If you have only one PRO2 PS/2, it will display “BANK 00”.

5



6

7

8

9

10



A “\*” symbol indicates that the computer is powered.

If a computer is connected and is powered up, but the OSD menu does not display a \* symbol, you will have to reset the PRO2 PS/2 to re-detect the powered computer. This is done by simultaneously pressing the “BANK +” and “BANK -” buttons on the front panel.

(↑↓): SELECT: Navigate to different computers in the same BANK.

(PGUP/DN): BANK: Select previous BANK by pressing the “Page Up” key and next BANK by pressing the “Page Down” key.

(Insert): RENAME: Name each computer (up to 15 characters).

(ENTER): SAVE: Save the content input.

(TAB): SETUP: Open “Setup” menu.

(ESC): EXIT: Exit the On-Screen Display.

## AutoScan Time:

Specifies the amount of time the PRO2 PS/2 remains on a port before switching to the next port while in AutoScan mode. You may select different time intervals—7, 15, 30, or 60 seconds. Use the OSD to set the AutoScan time interval.

## OSD Display Time:

Specifies the amount of time the OSD menu is displayed. Also specifies the amount of time the “Port Identification” tag displays on-screen after making a port selection. You may choose 7, 15, 30, or 60 seconds. For both settings, you may use the arrow keys to navigate. After you have selected the desired time intervals, push “Enter” key to save the entry. Press the “ESC” key to go back to the original OSD menu screen. Press the “ESC” key again to exit the On-Screen Display completely. Once you have selected a computer on the menu, press “Enter” to switch to that port.

**Note:** If there are Slave units connected, and the AutoScan time and OSD display time settings are set on the Master unit, the settings will also apply to all slave units.

## Updating Firmware:

To update your firmware, download the appropriate firmware file and utility from **belkin.com**. The utility automatically guides you through the process of updating the firmware on your PRO2 PS/2.

## Cautions and Warnings:

We strongly recommend that you update your firmware only if you are currently experiencing mouse and keyboard problems with your PRO2 PS/2, as reconfiguring software may lead to unexpected operational problems. Please contact Belkin Tech Support if you need assistance.

## To update the firmware, you will need the following items:

1. A separate computer running Windows 95, 98, or Me. This computer must not be connected to the CPU ports on the PRO2 PS/2.
2. An available parallel port on the computer.
3. A flash cable that connects between the PRO2 PS/2 and the computer.
4. Firmware update files available at [belkin.com](http://belkin.com).

1

## Connecting Computers:

1. Connect a keyboard, monitor, and mouse to the computer you prepared for firmware update. It must run Windows 95, 98, or Me.
2. Connect the power adapter to the PRO2 PS/2. Be sure that all connected computers are powered off at this moment.
3. Connect the flash cable.

2

3

4

5

## Setting the PRO2 PS/2 into Flash Mode:

The PRO2 PS/2 has four Flash DIP switches:

DIP Switch				Firmware
1	2	3	4	
ON	OFF	OFF	OFF	Main
OFF	ON	OFF	OFF	OSD
ON	ON	OFF	OFF	Keyboard 1
OFF	OFF	ON	OFF	Mouse 1
ON	OFF	ON	OFF	(F1DA116Pea Only) Keyboard 2
OFF	ON	ON	OFF	(F1DA116Pea Only) Mouse 2

6

7

8

9

10

The DIP switch should be set to the specified settings when you are attempting to update a particular firmware. For example, set DIP switch 1 to “ON” to flash update the main firmware of the switch.

Note: F1DA116P requires that you flash update two firmwares for the mouse and keyboard, separately.

1. Once the above steps have been completed, run the Flash software executable. Make sure that the appropriate Flash DIP switch is set to the “on” position. Only one firmware can be flashed at one time.
2. After the Flash update has been completed unplug the power supply from the PRO2 PS/2.
3. Set all DIP switches to the Off position.
4. You are now ready to use your PRO2 PS/2 or continue flashing a different component if necessary.



## OmniView KVM Switches

**OmniView E Series.** This series of desktop OmniView KVM Switches allows you to control two or four PS/2 computers from one Console and makes switching between computers more convenient. Designed for compatibility with your PS/2 platform, it reduces desktop clutter and provides a simple, reliable solution at a lower price point.

The E Series KVM Switch supports high-quality resolution of up to 2048x1536@85Hz through a 400MHz bandwidth when used with coaxial VGA cabling. This means that Belkin OmniView products offer the highest resolution without compromising the quality of the display. Power for the KVM Switch draws off the keyboard, so that the Switch requires no additional power supply and fewer cables. Standard E Series features include: hot key functionality; keyboard and PS/2 emulations for error-free boot up; and a Belkin Two-Year Warranty.

F1DB102P E Series 2-Port KVM Switch PS/2 Only

F1DB104P E Series 4-Port KVM Switch PS/2 Only

**OmniView SOHO Series with Audio.** This innovative design provides built-in cable management and saves space, while adding a whole new sculpted look to your desktop. The SOHO Series Switches allow you to control two or four PS/2 computers from one Console. You'll enjoy the greatest interface flexibility with PS/2 and USB combination Switches. They offer you expanded compatibility with either interface, or both, along with the additional convenience of manual push-button port selection on the face of the device. Switch between speakers and microphones without having to unplug and re-plug them when switching computers. The flash feature allows users to download firmware updates and ensure compatibility with the latest computers and devices. The enclosure design builds in cable management and the Switches are self-powered, so they require no external power supply and work with fewer cables. High-quality resolution of up to 2048x1536@85Hz is supported through a 400MHz bandwidth by the OmniView SOHO Series with Audio KVM Switch when used with coaxial VGA cabling, offering the highest resolution without compromising the quality of the display. Other standard features found on this unit include: hot key functionality; keyboard and PS/2 emulations for error-free boot up; and a Belkin Three-Year Warranty.

## Belkin KVM switches and accessories

---

1

F1DS104P SOHO Series 4-Port KVM Switch with Audio PS/2 Only

2

F1DS102T SOHO Series 2-Port KVM Switch with Audio PS/2 & USB

3

F1DS104T SOHO Series 4-Port KVM Switch with Audio PS/2 & USB

4

OmniView PRO2 PS/2 Series. The OmniView PRO2 PS/2 Series KVM Switches deliver reliability, performance, and centralized control necessary for today's enterprise environment. This series of KVM Switches enables you to control multiple platform servers from a single Console. Available in the desktop-style, 4-port, and the 19-inch rack-mountable 8- and 16-port models, the OmniView PRO2 PS/2 Series KVM Switch expands easily for full control of as many as 256 CPUs through dedicated daisy-chain ports. Video resolutions of up to 1600x1200@65Hz are supported through a 400MHz bandwidth. On-Screen Display allows you to name and select attached servers using an on-screen interface. Switch between ports by using hot key commands or direct-access port selectors. The Omniview PRO2 PS/2 Series KVM Switches use standard cables for easy installation; include a 12-Volt DC, 1-Amp power supply; and are backed by a Belkin Five-Year Warranty.

5

6

7

8

9

F1DA104T PRO2 PS/2 Series 4-Port KVM Switch PS/2 & USB

F1DA108T PRO2 PS/2 Series 8-Port KVM Switch PS/2 & USB

10

F1DA116T PRO2 PS/2 Series 16-Port KVM Switch PS/2 & USB

## OmniView All-In-One KVM Cables

OmniView All-In-One KVM Cables provide you with the quality connections necessary to set up your KVM solution. Each kit provides the proper cables and connectors to complete the installation of a Belkin OmniView KVM Switch.

OmniView All-In-One KVM Cables feature sturdy construction, with strain-relief construction and PVC overmolding to prevent data loss. Use of 20-gauge wire delivers the high-performance cable that users have come to identify with the Belkin name. A ferrite bead reduces electromagnetic and radio frequency interference (EMI/RFI). PC99 color-coded connectors and modified thumbscrews have been added for easier installation.

**PRO Series Plus.** The PRO Series Plus Cables are high-performance cables built to exacting standards. They receive and transmit data through nickel-plated connectors. The industry-standard 14-pin, coaxial VGA cabling was designed to support image clarity for high-resolution applications. The gray jacket bends into even the tightest crawl spaces for an excellent fit. The PRO2 PS/2 Series Plus Cable is available in PS/2- and USB-style cable kits.

F3X1105b-XX PS/2 (available in lengths of 6, 10, 15, and 25 feet)

F3X1962-XX USB (available in lengths of 6, 10, and 15 feet)

(-XX denotes length in feet)

## PRO2 PS/2 series FAQs

---

1

Q: What operating systems does the PRO2 PS/2 support?

A: The PRO2 PS/2 will support any operating system that runs on a PS/2 platform.

3

Q: What does flash upgradeable mean?

A: With flash upgrade capability, you can update your PRO2 PS/2 firmware at any time through a simple parallel connection. Internet upgrade capability ensures that your PRO2 PS/2 is always the most current version on the market with the latest features and enhancements. See the section on firmware updates in this manual (page 21) and when to use them.

6

Q: Does the PRO2 PS/2 support Microsoft IntelliMouse®?

A: The PRO2 PS/2 supports mice from Microsoft, Logitech®, Kensington®, etc., and Belkin. Please contact Belkin Technical Support for compatibility issues you may experience.

8

9

Q: How does the PRO2 PS/2 allow the user to switch between ports?

A: The PRO2 PS/2 supports three methods of port selection. The user **can** select computers using specially designated keyboard hot keys, through On-Screen Display, or can independently access the desired port by pushing the direct-access port selectors.

10

- Q: How far can the computer be from the PRO2 PS/2?
- A: When using PS/2 connections, the PRO2 PS/2 can be up to 25 feet away from your computer. If your computer needs to be more than 25 feet (7.5 meters) from the PRO2 PS/2, you can use the Belkin CAT5 Extender to extend your PS/2 keyboard, PS/2 mouse, and monitor up to 300 feet away using a standard CAT5 UTP cable.
- Q: What is the maximum video resolution that the PRO2 PS/2 supports?
- A: The advanced video circuit in the PRO2 PS/2 supports a maximum resolution of 2048x1536@85Hz.
- Q: What video bandwidth does the PRO2 PS/2 support?
- A: The PRO2 PS/2 supports 400MHz of video bandwidth.
- Q: Do I have to install any software to use the PRO2 PS/2?
- A: No, the PRO2 PS/2 does not require any drivers or software to be installed in your computers. Simply connect all your computers to the PC ports on the PRO2 PS/2, then attach one keyboard, monitor, and mouse to the Console port and it is ready for use.

## PRO2 PS/2 series FAQs

---

1

Q: Does the PRO2 PS/2 require an AC adapter?

2

A: Yes, the PRO2 PS/2 requires a 12-Volt DC, 1-Amp power adapter in order to function properly.

3

Q: Can I use the PRO2 PS/2 to switch video signals only?

4

A: Yes, you may use the PRO2 PS/2 to switch between video signals only without having to connect the keyboard and mouse. The keyboard and mouse should be connected directly to the computer that the video signal is taken from to ensure that your computer functions properly.

5

6

Q: How long is the warranty for the PRO2 PS/2?

7

A: The PRO2 PS/2 comes with a three-year limited warranty.

8

9

10

## General

**My computer does not boot when connected to the PRO2 PS/2 but works fine when I connect the keyboard, video, and mouse directly to the computer.**

- Make sure that the keyboard and mouse cables are connected tightly between the PRO2 PS/2 and the computer.
- Check that the keyboard and mouse cables are not crossed.

## Video

**I am getting ghosting, shadowing, or fuzzy images on my monitor.**

- Check that all video cables are inserted properly.
- Check that the monitor you are using supports the resolution and refresh-rate setting on your computer.
- Check that the graphics card you are using supports the resolution and refresh-rate setting on your computer.
- Connect the monitor directly into the computer you are having trouble with to see if the problem still appears.

**I am getting a black screen on my monitor.**

- Check that all video cables are inserted properly.
- If you are not using a power adapter, check that the keyboard cable is connected and inserted properly between the computer and PRO2 PS/2 for the appropriate port.
- Connect your monitor directly to the computer to verify that your monitor is functioning properly.

1

## Keyboard

2

### **The computer does not detect a keyboard and I get a keyboard error reported at boot up.**

3

- Check that the keyboard cable between the PRO2 PS/2 and the computer is completely connected. Tighten any loose connections.

4

- Try using a different keyboard.

5

- Try connecting the computer to a different port.

6

- If you are using the keyboard software that was included with your keyboard, uninstall it and then reinstall the standard Microsoft keyboard driver.

7

## Mouse

8

### **The mouse is lost when I switch to a different port.**

9

- Check that the mouse you are using is connected properly to the Console of the PRO2 PS/2.

10

- If you are using a mouse driver that was included with your mouse, uninstall it and install the standard Microsoft mouse driver.

- Disconnect and reconnect the mouse cable attached to the channel with which you are experiencing problems to re-synchronize the mouse connection.

- Make sure the mouse works when directly plugged into the computer.

- If the computer is coming out of standby mode, allow up to one minute to regain mouse function.

- De-activate power-management schemes on the PC with which you are experiencing problems.

- Try a different mouse.



## **The mouse is not detected at boot-up.**

- Check the cables and make sure that they are inserted correctly.

## **The computer boots up, but the mouse does not work.**

- Make sure the mouse is plugged in properly.
- Make sure the mouse works when directly plugged into the computer. Rebooting may be necessary when trying this.
- Try a different mouse.

## **When I switch from one port to another, mouse movement is completely erratic.**

- Make sure you do not have more than one mouse driver installed. Make sure that the driver is either for a standard PS/2 mouse or a Microsoft computer-compatible PS/2 mouse.
- Make sure you do not have any mouse drivers loaded in your CONFIG.SYS or AUTOEXEC.BAT files.
- Avoid moving the mouse or pressing the mouse button when switching ports on the PRO2 PS/2.
- You can reset the mouse and resume proper mouse movement simply by unplugging the mouse from the front of the PRO2 PS/2 for about 2-3 seconds, and then plugging it in again.

# Warranty, FCC, CE, ICES Statement

---

## FCC Statement

### DECLARATION OF CONFORMITY WITH FCC RULES FOR ELECTROMAGNETIC COMPATIBILITY

We, Belkin Components, of 501 West Walnut Street, Compton CA 90220, declare under our sole responsibility that the products:

#### F1DA104P, F1DA108P, F1DA116P

to which this declaration relates: Comply with Part 15 of the FCC Rules. Operation is subject to the following two conditions: (1) this device may not cause harmful interference, and (2) this device must accept any interference received, including interference that may cause undesired operation.

## CE Declaration of Conformity

We, Belkin Components, declare under our sole responsibility that the F1DA104P, F1DA108P, and F1DA116P to which this declaration relates, are in conformity with Emissions Standard EN55022 and with Immunity Standard EN55024, LVP EN61000-3-2, and EN61000-3-3.

## ICES

This Class B digital apparatus complies with Canadian ICES-003. Cet appareil numérique de la classe B est conforme à la norme NMB-003 du Canada.

## Belkin Components Limited Three-Year Product Warranty

Belkin Components warrants this product against defects in materials and workmanship for its warranty period. If a defect is discovered, Belkin will, at its option, repair or replace the product at no charge provided it is returned during the warranty period, with transportation charges prepaid, to the authorized Belkin dealer from whom you purchased the product. Proof of purchase may be required. This warranty does not apply if the product has been damaged by accident, abuse, misuse, or misapplication; if the product has been modified without the written permission of Belkin; or if any Belkin serial number has been removed or defaced.

THE WARRANTY AND REMEDIES SET FORTH ABOVE ARE EXCLUSIVE IN LIEU OF ALL OTHERS, WHETHER ORAL OR WRITTEN, EXPRESSED OR IMPLIED. BELKIN SPECIFICALLY DISCLAIMS ANY AND ALL IMPLIED WARRANTIES, INCLUDING, WITHOUT LIMITATION, WARRANTIES OF MERCHANTABILITY AND FITNESS FOR A PARTICULAR PURPOSE.

No Belkin dealer, agent, or employee is authorized to make any modification, extension, or addition to this warranty.

## Warranty, FCC, CE, ICES Statement

---

BELKIN IS NOT RESPONSIBLE FOR SPECIAL, INCIDENTAL, OR CONSEQUENTIAL DAMAGES RESULTING FROM ANY BREACH OF WARRANTY, OR UNDER ANY OTHER LEGAL THEORY, INCLUDING BUT NOT LIMITED TO, LOST PROFITS, DOWNTIME, GOODWILL, DAMAGE TO OR REPROGRAMMING, OR REPRODUCING ANY PROGRAM OR DATA STORED IN OR USED WITH BELKIN PRODUCTS.

Some states do not allow the exclusion or limitation of incidental or consequential damages or exclusions of implied warranties, so the above limitations of exclusions may not apply to you. This warranty gives you specific legal rights, and you may also have other rights that vary from state to state.

section

1

2

3

4

5

6

**7**

8

9

10

# BELKIN®

## OmniView® KVM-Switch PR02 PS/2

# BELKIN®

[www.belkin.com](http://www.belkin.com)

Belkin Ltd.  
Express Business Park, Shipton Way  
Rushden, NN10 6GL, United Kingdom  
+44 (0) 1933 35 2000  
+44 (0) 1933 31 2000 fax

Belkin B.V.  
Boeing Avenue 333  
1119 PH Schiphol-Rijk, The Netherlands  
+31 (0) 20 654 7300  
+31 (0) 20 654 7349 fax

Belkin GmbH  
Hanebergstrasse 2  
80637 Munich, Germany  
+49 (0) 89 143405 0  
+49 (0) 89 143405 100 fax

Belkin SAS  
130 rue de Silly  
92100 Boulogne-Billancourt, France  
+33 (0) 1 34 58 14 00  
+33 (0) 1 39 46 62 89 fax

Belkin Tech Support  
Europe: 00 800 223 55 460

## Free Manuals Download Website

<http://myh66.com>

<http://usermanuals.us>

<http://www.somanuals.com>

<http://www.4manuals.cc>

<http://www.manual-lib.com>

<http://www.404manual.com>

<http://www.luxmanual.com>

<http://aubethermostatmanual.com>

Golf course search by state

<http://golfingnear.com>

Email search by domain

<http://emailbydomain.com>

Auto manuals search

<http://auto.somanuals.com>

TV manuals search

<http://tv.somanuals.com>