

Xerox: XDL23/XDL33/XDL33D

User Guide

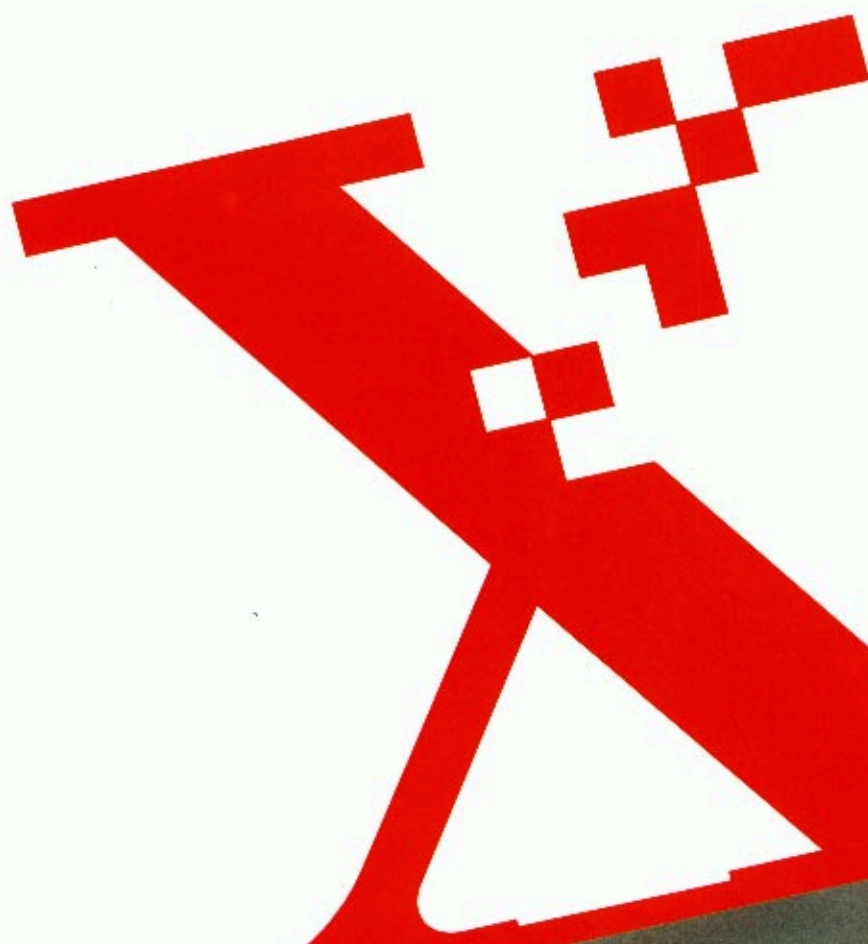

THE DOCUMENT COMPANY
XEROX

FCC compliance in the USA

This equipment was tested and complies with the Class B digital device as pursuant to part 15 of the FCC Rules. These limits provide reasonable protection against harmful interference in a residential installation. This equipment generates, uses, and can radiate radio frequency energy, and if not installed and used in accordance with the instructions, may cause harmful interference to radio communications. However, there is no guarantee that interference will not occur in a particular installation. If this equipment does cause harmful interference to radio or television reception, which can be determined by turning the equipment off and on, the user is encouraged to correct the interference by one or more of the following measures:

- Reorient or relocate the receiving antenna.
- Increase the separation between the equipment and receiver.
- Connect the equipment into an outlet which is on a different circuit from the circuit of which the receiver is connected.
- Consult the dealer or an experienced radio/TV technician for help.

Any changes or modifications made to this equipment which are not specifically approved by the Xerox Corporation may void the authority granted by the FCC to operate this equipment.

EME compliance in Canada

This Class B Digital apparatus meets all the requirements of the Canadian Interference - Causing Equipment Regulations.

©1998 by Xerox Corporation. All rights reserved.

XEROX®, The Document Company®, the stylized X, XDL23, XDL33, XDL33D, and identifying product names and numbers herein are trademarks of XEROX Corporation.

Introduction

Welcome

Congratulations on acquiring your new XEROX copier. The features, ease of operation, and reliability of your copier allow you to concentrate on your business and leave the copying to your new XEROX copier.

Supplies

To order supplies for your copier, contact your local dealer or call XEROX SupplyNet at 1-800-822-2200.

Toner cartridge:	6R918
Drum cartridge:	13R555
Staples:	8R7907

Service

To obtain answers to any questions you may have regarding your copier or if your copier requires service, please call your local dealer.

Or in the United States and Canada call:

1-800-TEAM-XRX (1-800-832-6979)
or visit the XEROX web site at: <http://www.teamxrx.com>.

NOTES:

Table of contents

Safety notes	1
How to obtain	3
Another paper tray different in size.....	3
How to use this guid	4
Manual terminology	4
Helpful hints	6
Floor space requirements	7
Getting to know your copier	8
Identifying the external parts	8
Copier	8
Copier right side.....	10
Identifying the internal parts.....	11
Identifying the control panel components	12
About the copier information system	16
Message display (XDL23/XDL33).....	16
Message display (XDL33D)	17
Copier diagram	18
Labels	18
Normal copy mode	19
Power saver mode.....	20
XDL23/XDL33.....	20
XDL33D	20
Paper	21
Helpful hints.....	21
Specification chart for the trays	22
Specification chart for the ADF/DADF.....	23
Specification chart for the 10-bin sorter stapler.....	24
Loading the paper trays	25
Paper trays 1, 2 and 3	25
Paper tray 5.....	26
Bypass tray.....	27
Standard paper stock.....	27
Special paper stock	28
Switching the paper trays	29
Making copies	30
Originals	30
What is an original?	30
Check the originals	30
Using the document glass.....	31
Using the automatic document feeder (ADF).....	32
Using the duplex automatic document feeder (DADF).....	33
Making copies with mixed-size originals.....	34
Using the bypass tray	35
How to use the basic copying features	37

Paper supply.....	38
Manual	39
Auto.....	40
Reduce/enlarge	41
Auto.....	42
Preset.....	43
Variable.....	44
Copy density	45
Exposure mode.....	46
Photo	46
Manual.....	47
Auto exposure	48
Copy lighter/darker.....	49
Original →copy (XDL33D)	50
2→1	51
2→2.....	52
1→2.....	53
1→1	54
Manual 2 sided copying	55
Job interrupt.....	57
How to use the added copying features.....	58
Special features.....	59
Stapling.....	60
Auto stapling	60
Manual stapling.....	61
Stapling without copying	61
Collated	62
Book mode	63
Margin shift.....	64
Edge deletion.....	65
Customizing your copie.....	66
Identifying the special features	66
How to change the special feature settings.....	68
Total copycounter.....	72
Copier care.....	73
Ordering supplies	73
Replacing the drum cartridge	73
Replacing the toner cartridge	75
Toner cartridge yield	77
Cleaning the document glass and cover	78
Adding staples	79
Cleaning the ADF/DADF belt.....	81
Problem solving.....	82
Problem solving charts	83
General	83
Misfeeds.....	84

Copy quality	85
XDL33D problem solving messages	86
Status code list	87
Clearing the status codes	89
A1-A3 (XDL23/XDL33)	89
A1-A3 (XDL33D)	91
C1-C4, C8	93
C9	95
E1-E3	96
F1	98
F9	99
Calling for service	101
Relocating the copier	101
Technical data	102
Warranty	106
It's illegal	108
XEROX total satisfaction guarantee	109
Material safety data sheet	110

NOTES:

Safety notes

Your copier and supplies meet strict safety requirements. These requirements include safety agency examination and approval and compliance to any established environmental standards. Please read the following instructions carefully before operating the copier, and refer to these instructions, as required, in order to ensure the continued safe operation of your copier.

Follow all the warnings and instructions which are marked on or supplied with the product.

Unplug the copier from the wall outlet before cleaning it. Always use the materials which are specifically designated for the copier. Use of any other materials may result in poor performance and may create a hazardous situation.

Do not use aerosol cleaners. Follow the instructions in this user guide for the proper cleaning methods.

Never use any supplies or cleaning materials for purposes other than what they are intended. Keep all supplies and materials out of the reach of children.

Do not use the copier near water, wet locations, or outdoors.

Do not place the copier on an unstable cart, stand, or table. The copier may fall, and thereby cause personal injury or serious damage to the copier.

This product is equipped with a three-wire, grounding-type plug (in other words, a plug having a third grounding pin). This plug fits into a grounding-type power outlet only. This is a safety feature. If you cannot insert the plug into the outlet, contact your electrician in order to replace the receptacle; this ensures that you will avoid the risk of electric shock. Never use a ground adapter plug to connect the copier to a power source receptacle which lacks a ground connection terminal.

This copier should be operated from the type of power source which is indicated on the marking label. If you are uncertain as to the available power type, consult your local power company.

Do not allow anything to rest on the power cord. Do not locate the copier where persons will step on the cord.

The power supply cord is the disconnect device for this equipment. Ensure that the installation of the copier is near the outlet and that the outlet is easily accessible.

Your copier is equipped with an energy saving device which conserves power when the copier is not in use. The copier may be left on continuously.

Slots and openings in the copier cabinet provide ventilation; these slots and openings are located in the back and the sides of the copier cabinet. In order to ensure the reliable operation of the copier and to protect it from overheating, these openings must not be blocked or covered. Do not place the copier near or over a radiator or heat register. Do not place the copier in a built-in installation unless proper ventilation is provided.

Never push objects of any kind into the slots of the copier; these objects may touch dangerous voltage points or cause parts to short out. The resulting affect may be a risk of fire or electric shock.

Never spill liquid of any kind on the copier.

Never remove any covers or guards which require a tool for removal. There are no operator serviceable areas within these covers.

Never defeat the interlock switches. These copiers do not allow the operator access to any unsafe areas. Covers, guards, and interlock switches are provided in order to ensure that the copier does not operate with the covers opened.

The use of an extension cord with this copier is NOT recommended or authorized. If an extension cord must be used, always check the building codes and insurance requirements first. Ensure that the total ampere ratings of the products plugged into the extension cord do not exceed the extension cord ampere rating. Also, ensure that the total amperage of all the products plugged into the wall outlet does not exceed the outlet rating.

Avoid viewing directly the document lights. The lamps are bright and while not harmful, may cause an annoying afterimage. Always keep the document cover closed.

Avoid exposing the drum cartridge to light for extended periods of time.

Do not touch the red photoreceptor. Scratches or smudges on the photoreceptor result in poor copy quality and may shorten the service life.

Do not put your hands into the fuser area, which is located inside the exit tray area. Inserting your hands into the fuser area may cause burns.

Ozone: This product produces ozone during normal operation. The produced ozone depends on the copy volume, and the produced ozone is heavier than air. Providing the correct environmental parameter, such as specified in the XEROX installation procedures, ensures that the concentration levels meet the safe limits.

If additional information concerning ozone is required, request the XEROX publication number **600P83222**, "Ozone." Obtain this publication by calling (in the United States and Canada) **1-800-828-6571**.

If you need additional safety information concerning the copier or any XEROX supplied materials, call the following toll-free number:

In the United States and Canada: **1-800-828-6571**

How to obtain

Another paper tray different in size

In order to obtain another paper tray for a different paper size, or to obtain instructions on how to adjust your paper tray, contact your local dealer.

Additional paper trays are available in the following sizes:

- 5.5x8.5in.SEF
- 5.5x8.5in.LEF
- 11x17in.SEF
- A4 SEF
- A4 LEF
- other
- A5 SEF
- A5 LEF
- B4 SEF
- B5 LEF
- A3 SEF

How to use this guide

Most information applies to all models. When information applies to a specific model, the model number is shown in parentheses following the unique information.

Some copier models may have optional accessories. Any one or more of these accessories may or may not be installed on your copier model.

Manual terminology

This section identifies and defines the specific words, symbols, and acronyms which are used in this guide. Read this section in order to become familiar with the terminology used in this guide.

Original

An original is the document or documents from which a copy or copies are made. These documents can be paper, magazine, photograph, or book.

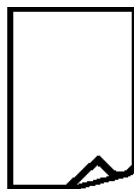

Long edge feed (LEF)

This symbol indicates that your originals or copy paper must be placed in the long edge feed direction. When the symbol on the left or the acronym LEF is shown, arrange your originals or copy paper in the long edge feed direction.



Short edge feed (SEF)

This symbol indicates that your originals or copy paper must be placed in the short edge feed direction. When the symbol on the left or the acronym SEF is shown, arrange your originals or copy paper in the short edge feed direction.

ADF (available on some models)

The automatic document feeder (ADF) is an optional accessory which automatically feeds one-sided originals on to the document glass.

DADF (XDL33D)

The XDL33D duplex automatic document feeder (DADF) automatically feeds 1 or 2 sided originals on to the document glass.



Image

Image refers to the information area on your original or copy which contains text or graphics.

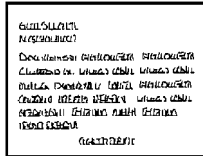

Landscape

This term refers to the orientation of the lines or type or the top of an illustration on your original as being parallel to the long edge of the paper.



Portrait

The term refers to the orientation of the lines or type or the top of an illustration on your original as being parallel to the short edge of the paper.

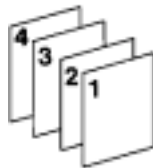

Collated

Collated refers to copy sets which are delivered to the output area in the same sequence as the original set.



1 sided

1 sided implies that the originals or copies have an image on one side only.



2 sided

2 sided implies that the originals or copies have an image on both sides.

Helpful hints

- Care of your copier:**
- Do not place heavy objects on any surface of the copier.
 - Ensure that liquids are not placed near or spilled onto the copier.
 - Do not place paper clips or staples on the copier surface.
 - As required, refer to the section entitled *Copier care*.
- Maintenance:**
- Clean the document glass daily.
 - Do not apply cleaning liquids or sprays directly on to the copier; first apply the liquid onto a cloth.
 - Store copy paper on a flat surface in a dry area and in an enclosed cabinet.
 - Tightly wrap any partially used reams of paper.
- Copier location:**
- For reliable copier operation and copy quality, XEROX recommends the following:
 - Place your copier in a well-ventilated room.
 - Ensure that the environmental conditions are:
 - Temperature: 50°F-95°F(10°C-35°C)
 - Relative humidity: 15-85%

Note: If the temperature is at 95°F(35°C), humidity should be below 47.5%; if humidity is at 85% temperatures should be below 82°F(27.8°C).
 - Place the copier on a flat level surface:
 - Ensure that the copier is level; this provides optimum performance
 - Avoid locations that subject the copier to:
 - Direct sunlight
 - Extreme changes in the temperature or humidity
 - After selecting a location that meets the conditions listed above, ensure there is sufficient floor space around the copier for service (refer to the section entitled *Floor space requirements*, in this section).

Floor space requirements

When choosing a new location, specific floor requirements must be met in order to allow room for service. Consider the following guidelines:

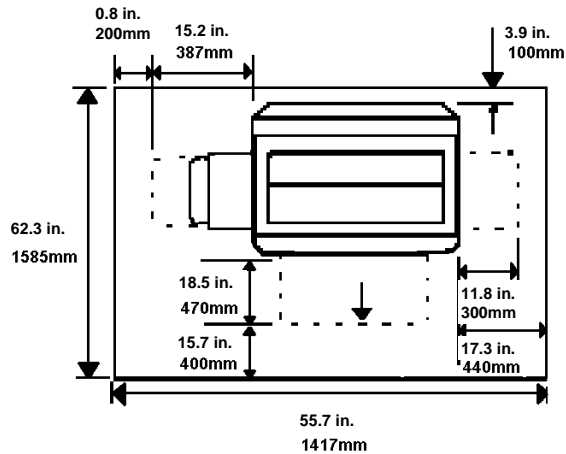

- The new location must provide minimum clearances around the copier. These clearances are shown in the diagram.
- The flooring in the new location must be adequate to support the weight of the copier and accessories, and be reasonably level.
- The new location must be well ventilated and maintain an even temperature. Extreme temperature or humidity changes can affect the copy quality.
- Avoid locations where the copier will be exposed to direct sunlight.
- Power source receptacles must be properly grounded.

Getting to know your copier

This section discusses the location, name, and function of the various copier components. The following copier components are discussed:

- External parts
- Control panel
- Internal parts
- Information system

Identifying the external parts

Copier

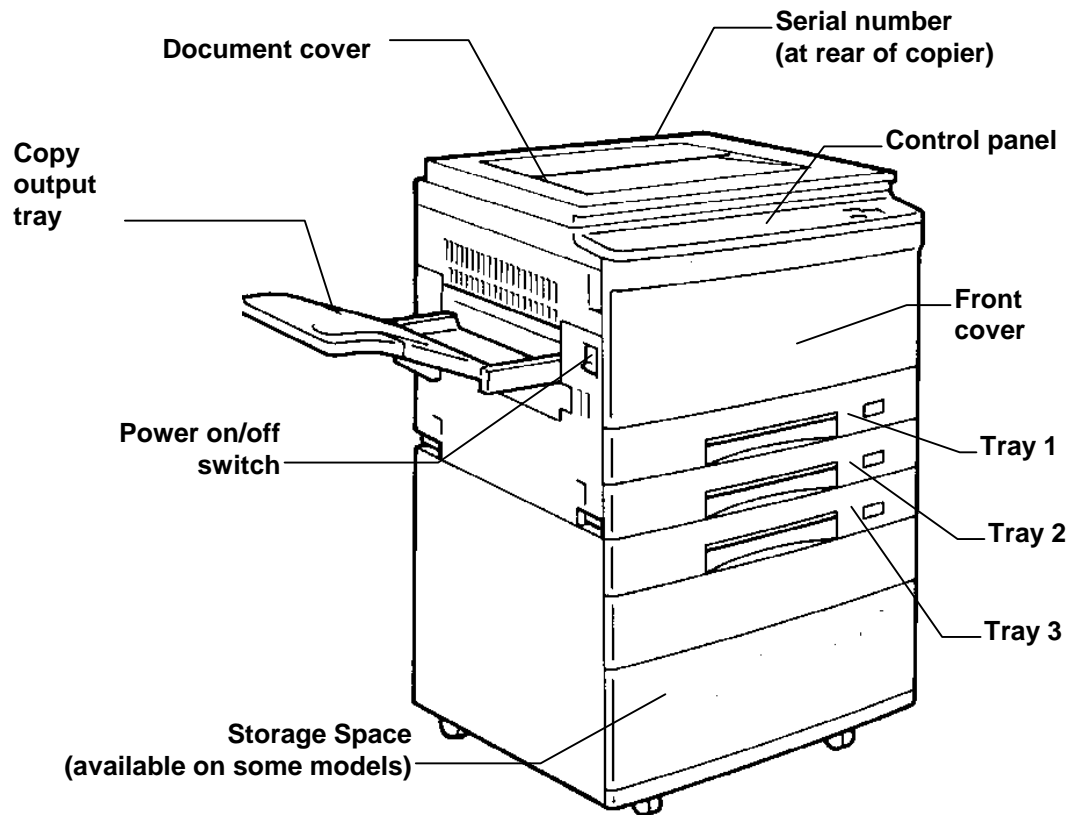

Copier

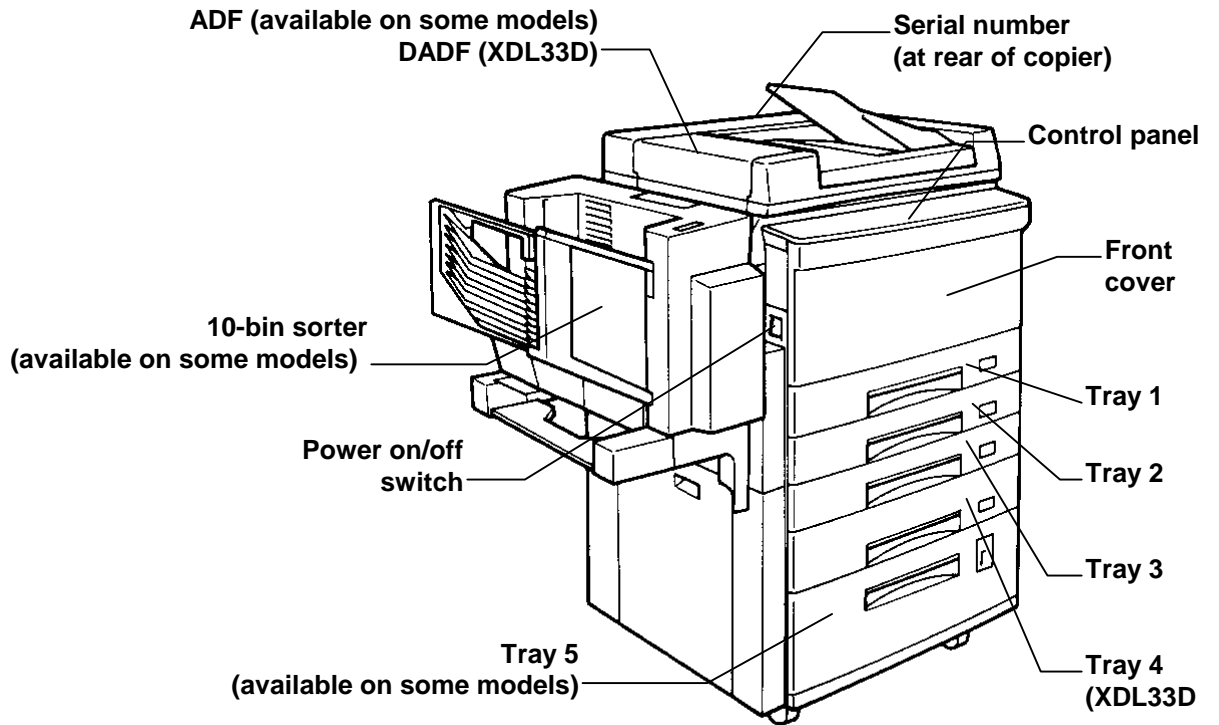

Copier right side

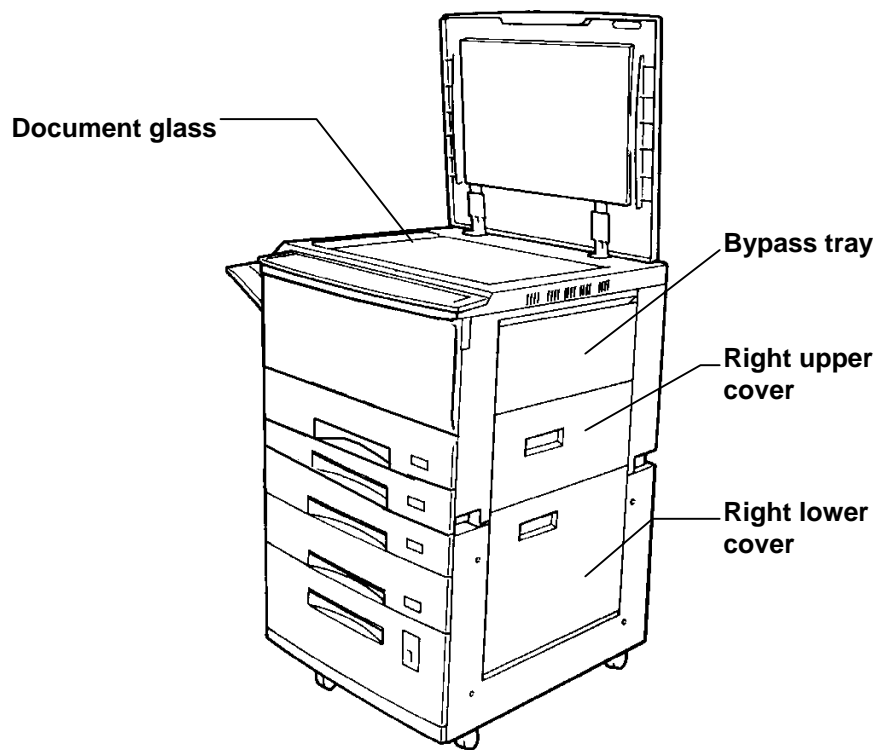

Identifying the internal parts

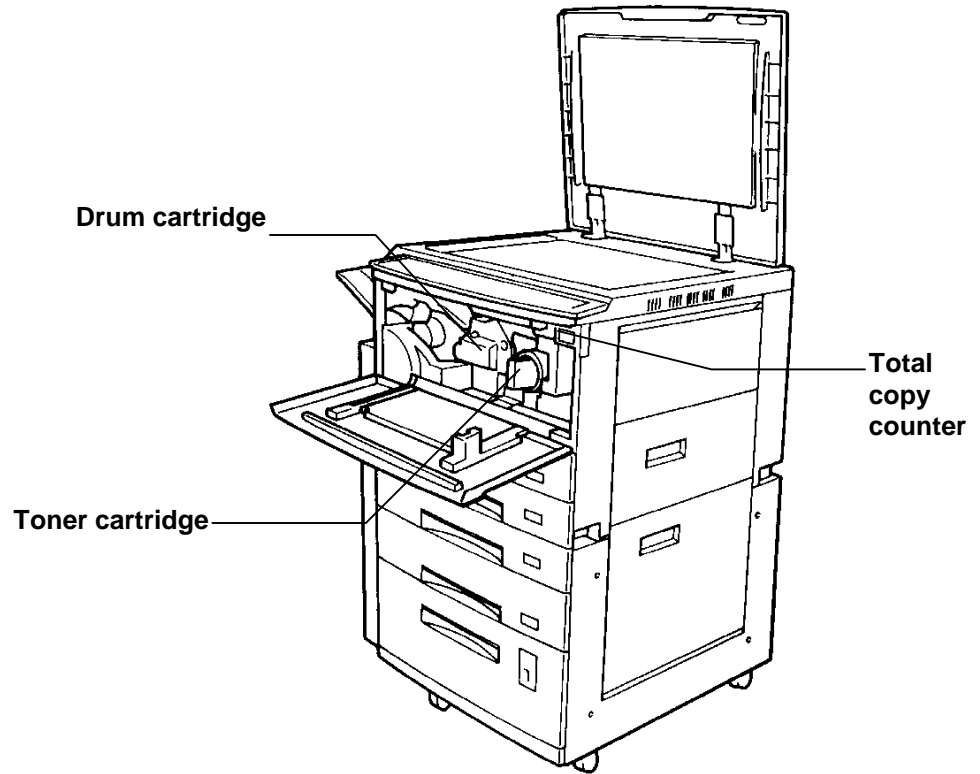

Identifying the control panel components

The control panel contains buttons and indicator lights which control and display the conditions of the copier.

When an indicator light becomes lit, this informs you of your control panel selections.

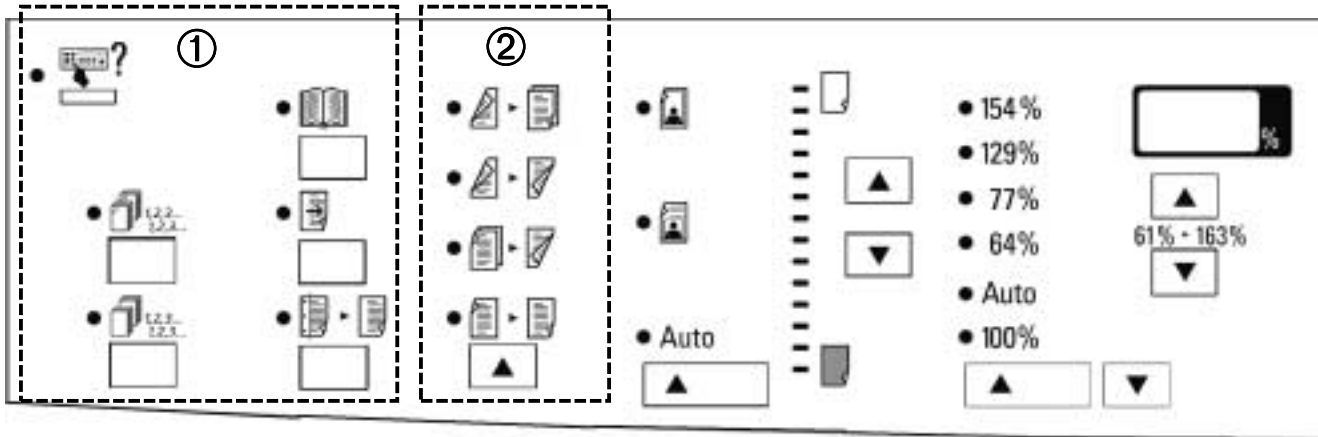

① Added features area

Note: To select a feature in the added feature area, press the button below the feature.



Special features: Select this feature to access, view, or change the copier default settings.



Stapling: Select this feature to automatically staple and collate copy sets; the copy sets are delivered to the sorter/stapler. This feature is enabled only on machines with the 10-bin sorter stapler.



Collated: Select this feature to collate the output copies. This feature is enabled only on machines which have the 10-bin sorter stapler.



Book mode: Select this feature to copy both pages of an open book or magazine.



Margin shift: Select this feature in order to produce a left-binding margin on the copy.



Edge deletion: Select this feature to delete any unwanted images from the edge of the copy.

② Original to copy area (XDL33D only)



Original to copy button: Press this button to select the desired copy output option.



2 to 1: Select this option for one-sided copies from two-sided originals.



2 to 2: Select this option for two-sided copies from two-sided originals.







1 to 2: Select this option for two-sided copies from one-sided originals.

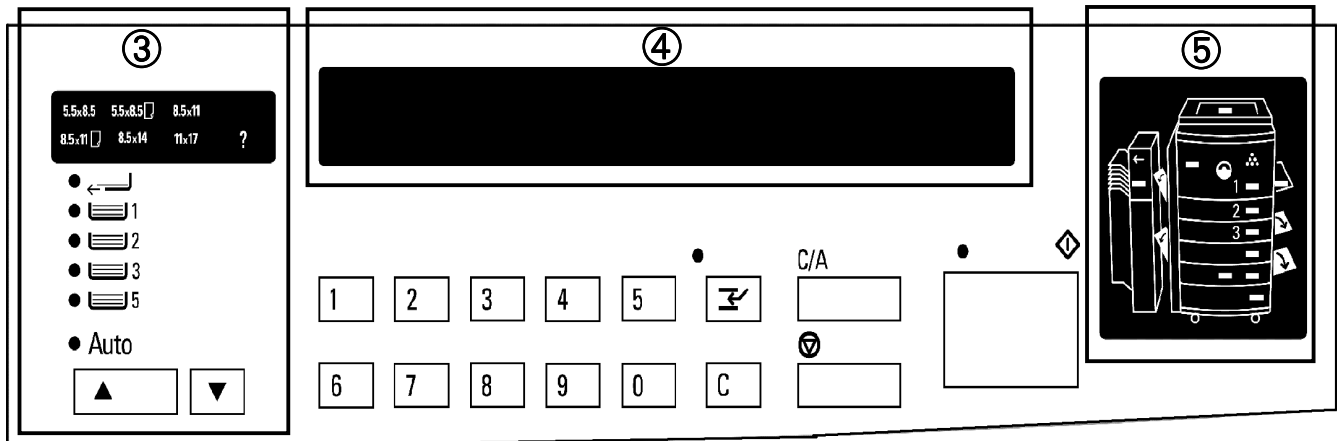

1 to 1: Select this option for one-sided copies from one-sided originals.



③ Paper supply area

- Paper supply buttons:** Press either one of these buttons to select the desired paper tray.
-  **Bypass tray:** Select this option when using special paper stock.
-  **Tray 1:** Select this option when using copy paper from tray 1.
-  **Tray 2:** Select this option when using copy paper from tray 2.
-  **Tray 3:** Select this option when using copy paper from tray 3.
-  **Tray 5 (available on some models):** Select this option when using copy paper from tray 5.

- ④ **Message display:** This area displays the following information: copy quantity, icon messages (for XDL23/XDL33) or word messages (for XDL33D), or instructions about the copier operation, copier maintenance, and status codes.

- ⑤ **Copier diagram:** When a specific copier area requires attention, this diagram displays the specific copier area with a flashing indicator light.

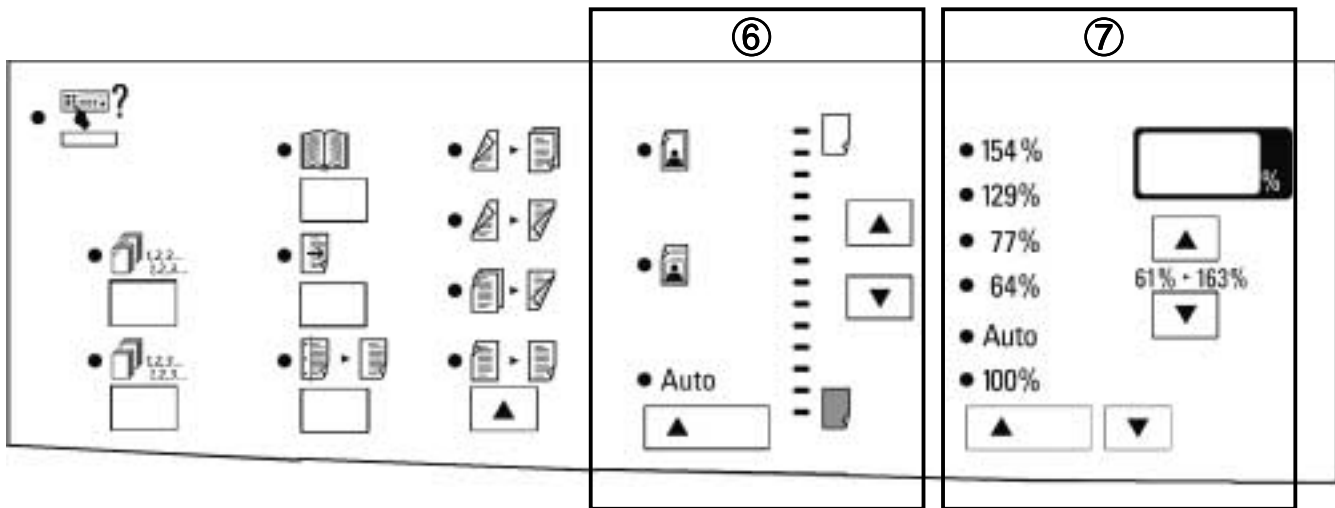

⑥ Copy density area



Exposure mode button: Press this button to select the desired exposure mode.



Photo mode: Select this mode when using originals which are photographs, magazine pages, or newspaper pages.



Manual mode: Select this mode when your originals contain mainly text.

Auto

Auto mode: Select this mode when your originals contain color or dark backgrounds.



Copy lighter/darker buttons: Press either one of these two buttons in order to have lighter or darker copies; this is especially useful when your originals are colored paper or contain light or dark areas on them.



⑦ Reduce/enlarge area



Preset buttons: Press either one of these two buttons to select a specific, preset, reduce/enlarge (R/E) ratio.



61% - 163%



Variable buttons: Press either one of these buttons in order to increase or decrease the reduce/enlarge (R/E) ratio; each press of the button increases or decreases the percentage in 1% increments.



Variable window display: This area displays the selected R/E percentage.

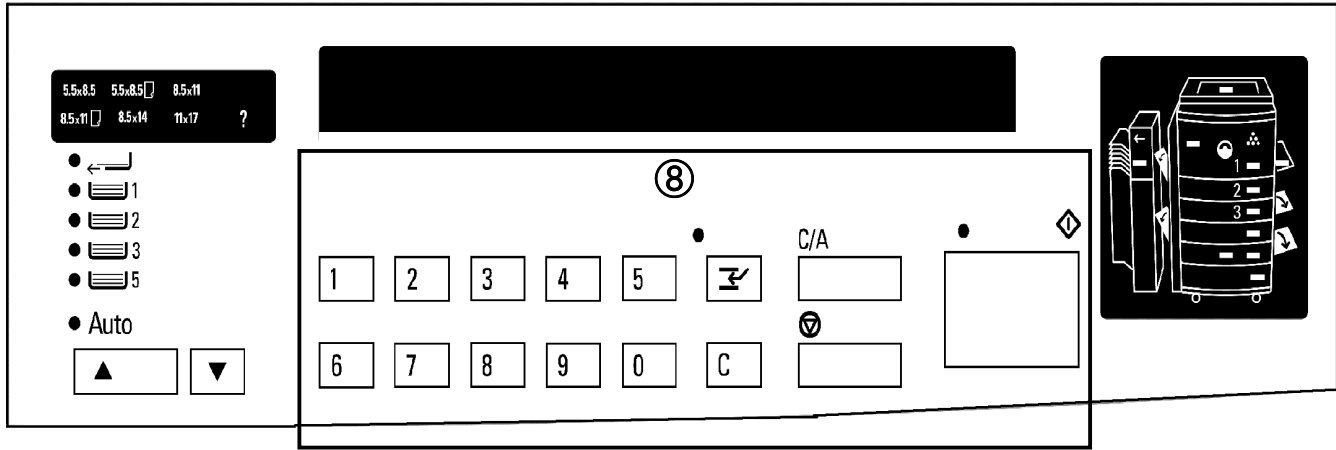

⑧ **Ten-key panel:** Press one or more number buttons in order to select the desired number of copies; you may choose a maximum of 99 copies.



Interrupt button: Press this button in order to interrupt a copy job which is currently in progress.



Clear button: Press this button in order to clear the copy quantity.

C/A



Clear All button: Press this button in order to clear all current copier selections.

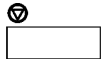

Stop button: Press this button in order to stop the operation of the copier.

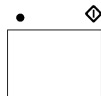

Start button: Press this button in order to begin the copy process.

About the copier information system

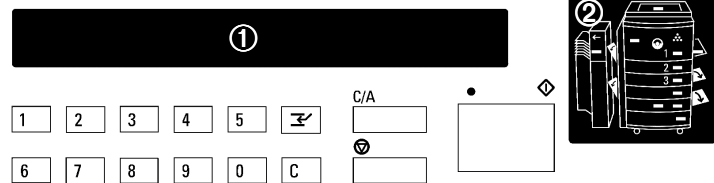

Your copier has a comprehensive information system which makes your job easier. Read this section to become familiar with its components and how they work together.

The information system contains the following components:

1. Message display
2. Copier diagram

Message display (XDL23/XDL33)



The XDL23/XDL33 copier message display above provides the main source of information to you.

It displays the copy quantity, provides you with icon information on the copier maintenance and operation. It also displays status codes that assist you with fixing a copier problem.

If an icon becomes lit, it provides status information about the copier. Ensure all the icon information is performed. For detailed description of the icons, refer to the *Icon descriptions* in this section.

When status code information appears on the message display, refer to the section entitled [Problem solving](#) for information and instructions.











Icon descriptions



Reload the originals in the ADF/DADF.



When the toner supply becomes low, the toner indicator flashes. When the indicator is lit continuously you must change the toner cartridge.

-  When the drum cartridge has 5000 copies remaining, the drum indicator becomes lit. When the indicator flashes you must change the drum cartridge.
-  The current paper tray that is being used has a paper misfeed. Clear the misfeed.
-  There is a paper misfeed inside the copier or in the paper exit area. Clear the misfeed.
-  Turn the original clockwise.
-  Select a reduce or enlarge ratio.
-  Select paper tray.
-  Add copy paper to the indicated paper tray. (Refer to the flashing indicator on the copier diagram)
-  The 10-bin sorter stapler is out of staples. Add staples.
-  Please wait; the copier is warming up.
-  Close the indicated cover. (Refer to the flashing indicator on the copier diagram)
-  Ready to copy.

Message display (XDL33D)

1

Press Start to continue

The XDL33D 2x40 LCD copier message display above provides the main source of information.

It displays the copy quantity and provides you with information and instructions on copier operation, maintenance, and status codes.

The message information is displayed, as needed, to let you know the status of the copier. Always perform all messages.

When problem messages appear, refer to the section entitled [Problem solving](#).

Copier diagram



XDL33D

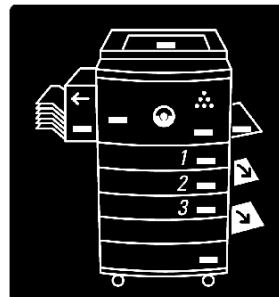

XDL23/XDL33

The copier diagram illustrates the various areas of the copier and contains various location indicators.

When a location indicator lights, it informs you of an area that requires attention.

The location indicators provide information on the following items:

- paper jams
- cartridge replacement
- empty paper trays
- open covers

Labels

There are many labels located throughout the copier and paper trays that provide instructions to assist you with a variety of tasks.

Normal copy mode

XDL23/XDL33 only

When the copier is switched on, the copier enters a warm-up

cycle and the **Please wait** icon becomes lit, . During the warm up cycle, the copier does not respond to the **Start** button. Copying may begin when the **Ready to copy** icon

becomes lit, , this icon indicates that the copier is in the normal copy mode.

XDL33D only

When the copier is switched on, the copier enters a warm-up cycle and the message "**Please wait...Copier warming up**" appears on the message display.

During the warm up cycle, the copier does not respond to the **Start** button. Copying may begin when the message "**Ready to Copy**" appears on the message display; this message indicates that the copier is in the normal copy mode.

Automatic Clear

This copier automatically returns to the normal copy mode approximately sixty (60) seconds after a job is completed; the automatic clear feature is enabled at the factory. The feature can be deactivated by referring to the section entitled *Customizing your copier*.

The automatic clear settings are preset at the factory and are as follows:

Copy density	• Auto
Reduce/enlarge	• 100%
Paper supply	• Auto
Copy quantity	• 1

Note: The factory default settings may be changed in order to meet your specific copying needs. Refer to the section entitled *Customizing your copier* for more information.

Power saver mode

In the power saver (low power) mode, the copier automatically switches to low power after the copier is idle for a predetermined time period. This feature is not activated when shipped from the factory. You can activate this mode and set a desired time period; refer to the section entitled [Customizing your copier](#). When the copier is in the power saver mode, simply press the **Start** button, and the copier enters the warm-up cycle.

For detailed information on your specific copier model, refer to the appropriate copier model below.

XDL23/XDL33



When the XDL23/XDL33 power saver mode occurs, this symbol "- -" appears in the copy quantity area of the message display.

Press the **Start** button, , to return to the normal copy mode.

XDL33D

When the XDL33D power saver mode occurs, the message shown to the left appears in the message display area.

Press the **Start** button, , to return to the normal copy mode.

Press Start to continue

Paper

This section provides useful paper hints and paper specification information on the following copier components:

- Paper trays
- ADF/DADF
- 10-bin sorter stapler

Helpful hints

Note: Humidity curls paper, and curled paper may cause jams and copy quality problems.

For reliable copier operation and good copy quality, XEROX recommends the following:

Store paper:

- on a flat surface.
- in a low humidity area.
- in a closed container.
- if the ream is partially used, tightly wrap the unused portion.

Paper handling:

- Do not load loose paper which has not been stored in a tightly wrapped container.
- Do not use folded or wrinkled paper.
- Ensure that the paper loaded in the tray is the same size as that which is indicated on the tray.
- Ensure that the paper is loaded correctly into the proper paper tray.

The following materials cannot be loaded in the trays:

- Paper with ripped or torn edges, paper containing pasted areas;
- Paper containing staples or paper clips;
- Paper with embossed letterhead;
- Carbon-backed materials;
- Transparencies;
- Vellum paper;
- Multipart forms;
- Bound documents such as books or magazines.

Specification chart for the trays

The paper specification chart provides information about the paper size and paper feed direction for each paper tray. Refer to the appropriate specification chart.

Note:

- XEROX recommends using 20 lb. bond paper for optimal performance.
- The XDL23/XDL33 copier is not equipped with paper tray 4.
- The XDL33D copier uses paper tray 4 for the 2 sided copy operation only.

Copy paper	Tray 1	Tray 2	Tray 3	Tray 5	Bypass Tray
Paper size range	5.5x8.5in./A5 to 11x17in./A3	5.5x8.5in./A5 to 11x17in./A3	5.5x8.5in./A5 to 11x17in./A3	5.5x8.5in./A5 to 11x17in./A3	5.5x8.5in./A5 to 11x17in./A3
Default setting	8.5x11in. LEF	8.5x14in. SEF	8.5x11in. SEF	8.5x11in. LEF	N/A
Additional paper trays*	5.5x8.5in. SEF, 5.5x8.5in. LEF, 11x17in. SEF, B4 SEF, B5 LEF, A5 SEF, A5 LEF, A3 SEF, A4 SEF, A4 LEF, other**.				
Paper weights					
Optimum	20lb/80gm ²	20lb/80gm ²	20lb/80gm ²	20lb/80gm ²	20lb/80gm ²
Range	16-24lb/60-90gm ²	16-24lb/60-90gm ²	16-24lb/60-90gm ²	16-24lb/60-90gm ²	16-32lb/60-120gm ²
Paper capacity	250 sheets	250 sheets	250 sheets	1000 sheets	50 sheets
8.5x11in./A4 20lb(80gm ²)					
Labels and transparencies ***	No	No	No	No	Yes (fan the labels or transparencies before placing them in the Bypass Tray.)

* Additional paper tray sizes available, call your local dealer.

** "Other" indicates that odd-size papers can be accommodated.

*** XEROX recommends the use of labels and transparencies which are designed for copiers (high temperatures) only.

Specification chart for the ADF/DADF

This specification chart provides information about the paper types which may be used with the ADF/DADF multisheet feeder.

Note:

- ADF (available on some models)
- DADF (XDL33D)

	ADF	DADF
Paper size	5.5x8.5in./A5 to 11x17in./A3	5.5x8.5in./A5 to 11x17in./A3
Paper weights	16-24lb/60-90gm ²	16-24lb/60-90gm ²
Paper capacity	30 sheets	50 sheets
Copy quantity	99 max	99 max for: 1→1 one-sided to one-sided 2→1 two-sided to one-sided 30 max for: 1→2 one-sided to two-sided 2→2 two-sided to one-sided
Labels and transparencies	No; Use the document glass for copying.	No; Use the document glass for copying.
Bound books or magazines	No; Use the document glass for copying.	No; Use the document glass for copying.

Specification chart for the 10-bin sorter stapler

This specification chart provides information about the paper types which may be used with the 10-bin sorter stapler.

Note: The 10-bin sorter stapler is available on some models.

Top bin capacity	Paper size	Stapled sheet capacity	Paper weights
100 sheets	5.5x8.5in./A5 to 10x14in./B4 11x17in./A3	15 sheets max 10 sheets max	16-24lb/60-90gm ²
Bins 2- 10 capacity	Paper size	Stapled sheet capacity	Paper weights
30 sheets	5.5x8.5in./A5 to 8.5x11in./A4	15 sheets max	16-24lb/60-90gm ²
25 sheets	8.5x14in./216x355mm to 10x14in./B4	15 sheets max	
10 sheets	11x17in./A3	10 sheets max	

Loading the paper trays

Paper trays 1, 2 and 3

When making copies, you can add paper to any tray that is not in use. When a paper tray is empty, the paper tray indicator flashes until the tray is loaded with paper.

For detailed information on the paper specifications for trays 1, 2 and 3, refer to the section entitled *Paper*.

Note: Each paper tray is fixed to a specific paper size. To change the paper size of a tray, contact your local dealer.

Procedure:

1. Pull open the desired paper tray.
2. Press on the bottom plate until it clicks.
3. Place the copy paper in the tray. Ensure that the paper is placed under the two snubbers.

Note: Do not fill the tray above the **MAX** line.

4. Close the paper tray.

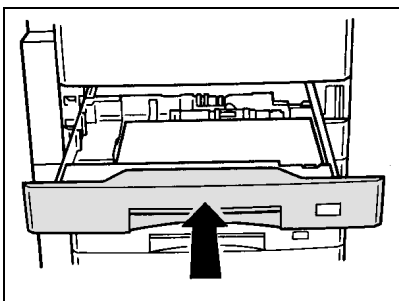
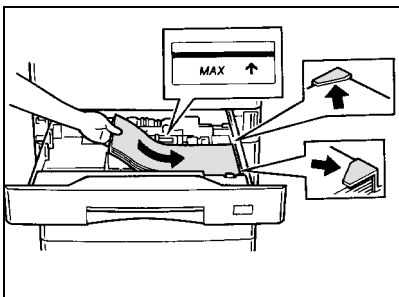
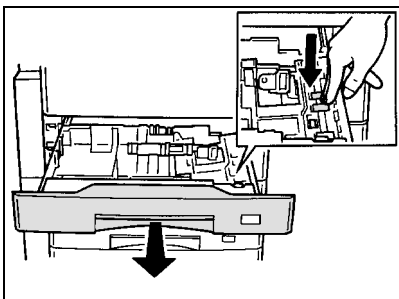

Paper tray 5

Paper tray 5 stores and feeds a maximum of 1000 sheets of 20lb/80gm² paper. Use this tray when running high volume copy jobs; in other words, use this tray when you have to make a large quantity of copies. The 1000 sheet capacity reduces the number of times that paper must be added to the tray.

For detailed information on the paper specifications for paper tray 5, refer to the section entitled *Paper*.

Note: Paper tray 5 is available on some models.

Note: The factory default setting for paper tray 5 is 8.5x11in. LEF. To change the paper size of a tray, contact your local dealer.

Procedure:

1. Pull open the paper tray.

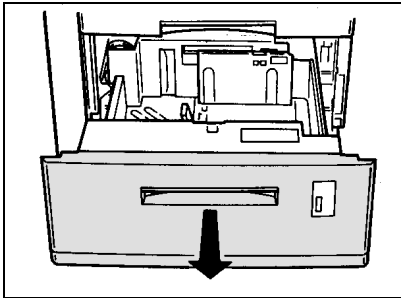

2. Place the copy paper into the tray.

Note: Do not fill the tray above the **MAX** line.

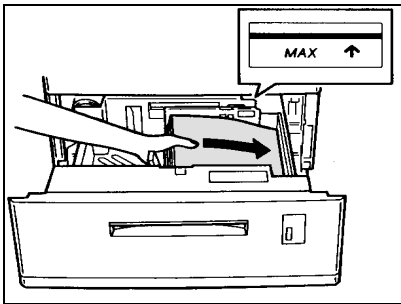

3. Close the paper tray.

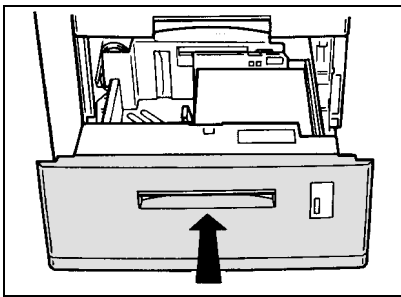

Bypass tray

The bypass tray allows you to make copies on standard or special paper stock. Refer to the appropriate paper stock for the specific loading procedure. For detailed information on the bypass tray paper specifications, refer to the section entitled *Paper*.

Standard paper stock

Procedure:

1. Open the bypass tray door.
2. Slide out the extension tray until you reach the desired paper length.
3. Adjust the paper guide to the desired paper width.
4. Place only the recommended amount of copy paper into the tray. Ensure the copy paper is placed along the paper guide, gently slide the stack into the copier until the stack stops.

Note: Do not fill the tray above the **MAX** line.

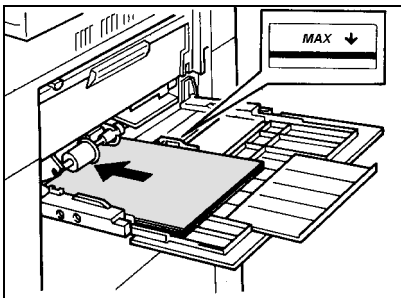
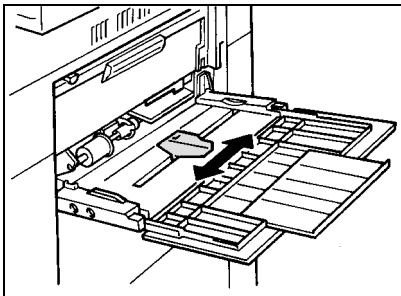
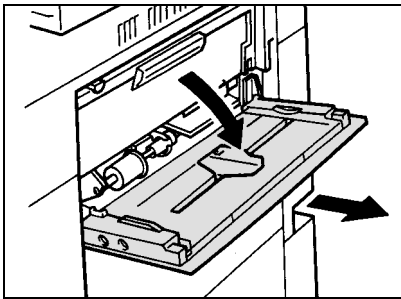

Special paper stock

The bypass tray can hold a small stack of the following special paper stock:

- Transparencies
- Labels

Use transparencies and labels specifically designed for copiers(high temperature).

Note: The stack of special paper stock must be fanned before loading it in the Bypass Tray.

Do not fill above the MAX line.

Procedure:

1. Open the bypass tray door.
2. Slide out the extension tray until you reach the desired paper length.
3. Adjust the paper guide to the desired paper width.
4. Fan a small stack of the special paper stock *before* loading it in the Bypass Tray.
5. Place the small stack of the special paper stock onto the tray, along the paper guide, and then gently slide the sheet into the copier until it stops.

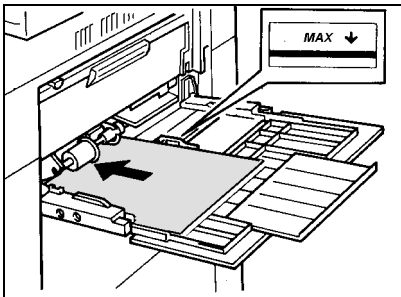
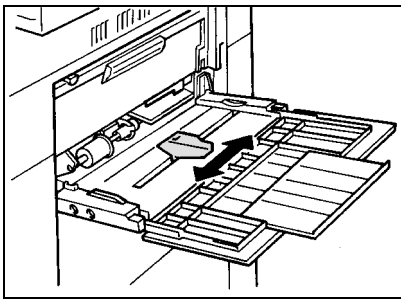
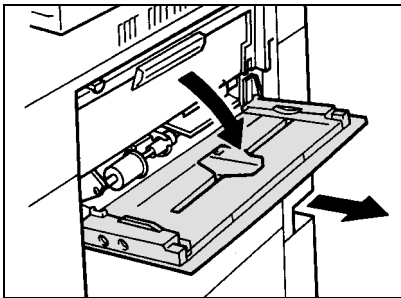

Switching the paper trays

Change the paper size of a tray by ordering an additional paper tray that is set to another size and placing that tray into your desired tray location.

To order another paper size tray contact your local dealer.

Use the following procedure in order to switch a tray.

Procedure:

Note: Paper trays 1, 2, and 3 are interchangeable.

1. Slide out the tray to be changed until it stops.
2. Lift the front side of the tray and remove it.
3. Store the tray in a convenient location.
4. While holding the front side of the desired tray, insert the tray under both guides of the empty tray slot.
5. Close the tray.

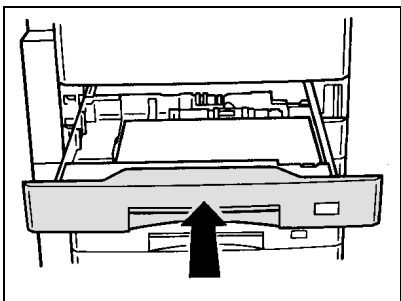
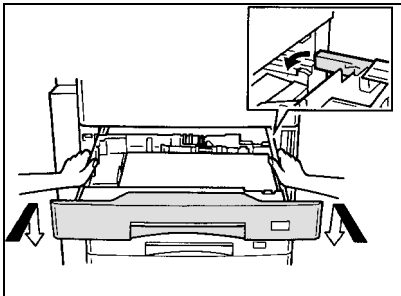
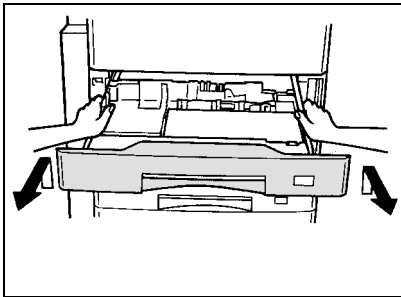

Making copies

Originals

What is an original?

Originals are documents that are used to make copies. These documents can be in the form of paper, magazine, photograph, or book.

Check the originals

Before you make copies, always check the originals for the following:

- any damage
- unusual weight
- unusual size
- unusual shape
- staples
- paper clips

If you would like to use the ADF or DADF, ensure the originals are in good condition and that all staples and paper clips have been removed. Use the document glass to make copies from transparencies, facsimile paper, or originals having other unusual characteristics. For reliable copier operation, use originals within the following ranges:

Paper weight range: 16 to 24 lb. (60 to 90 gsm)

Paper size range: 5.5 x 8.5 inch to 11 x 17 inch (A5 to A3)

Using the document glass

You can use the document glass to make a copy of a delicate or damaged original or to make copies of a reliable original.

Note: The ADF is available on some models, the DADF is available with the XDL33D model only.

Procedure:

1. Open the document cover or ADF/DADF.
2. Place the original, *face down*, on the document glass and register it against the left rear corner of the glass.

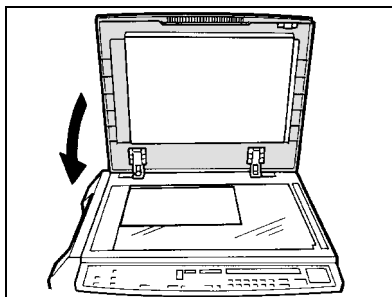
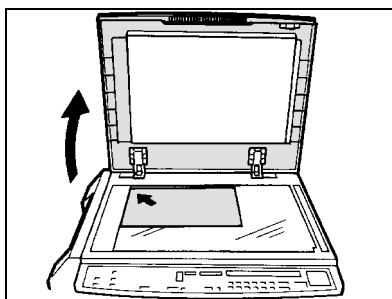

3. Close the document cover or ADF/DADF.

Caution: When copying a thick original, do not use excessive force to press down on the document cover or ADF/DADF.

4. Select any desired basic and/or added copy features.

(Refer to the sections entitled [How to use the basic copying features](#) or [How to use the added copying features](#).)

5. Enter the copy quantity.

Note: 99 maximum

6. Press the **Start** button, .

Using the automatic document feeder (ADF)

Use the automatic document feeder (ADF) to copy a stack of 1 sided originals. Once the **Start** button is pressed, the originals feed automatically to the document glass from the ADF. The bottom original is fed first.

Note: The ADF is available on some models.

For the reliable operation of the ADF, use standard size paper; refer to the section entitled *Paper*. See the specification chart for the *ADF*.

Procedure:

1. Raise the original catch tray.
2. Adjust the guide to the desired paper width.

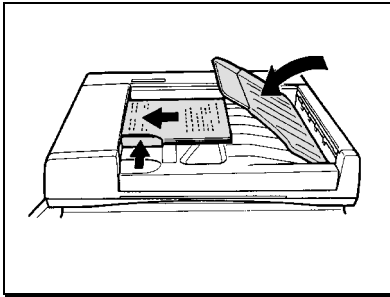
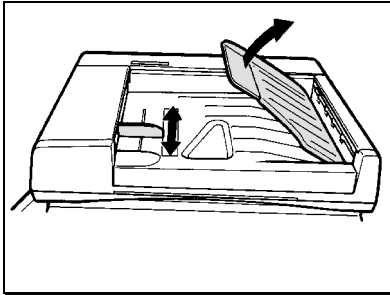

3. Place the originals, *face up*, in the ADF.
4. Lower the original catch tray.

Note: When the original catch tray is lowered, the ADF indicator becomes lit.

5. Ensure that the guide touches the edge of the originals.
6. Select the desired basic and/or added copy features.

(Refer to the sections entitled *How to use the basic copying features* or *How to use the added copying features*.)

7. Enter the copy quantity.

Note: 99 maximum

8. Press the **Start** button, .

Using the duplex automatic document feeder (DADF)

Use the duplex automatic document feeder (DADF) to copy a stack of 1 sided or 2 sided originals. Once the **Start** button is pressed, the originals feed automatically to the document glass from the DADF. The bottom original is fed first.

For reliable operation of the DADF, use standard size paper; refer to section entitled [Paper](#). See the specification chart for the [DADF](#).

Procedure:

1. Raise the original catch tray.
2. Adjust the guide to the desired paper width.

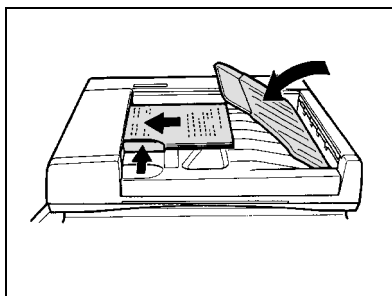
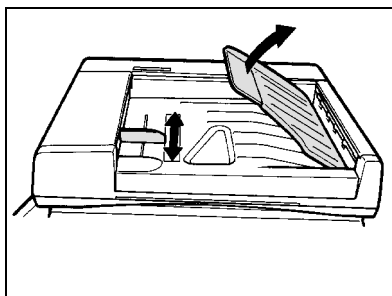

3. Place the originals, *face up*, in the DADF.
4. Lower the original catch tray.

Note: When the original catch tray is lowered, the DADF indicator becomes lit.

5. Ensure the guide touches the edge of the originals.
6. Select the desired basic and/or added copy features.

(Refer to the sections entitled [How to use the basic copying features](#) or [How to use the added copying features](#).)

7. Enter the copy quantity.

Note: 99 maximum for 1→1 and 2→1 copying

30 maximum for 1→2 and 2→2 copying

8. Press the **Start** button, .

Making copies with mixed-size originals

The ADF and DADF allows you to copy a stack of originals which contain different paper sizes (this stack of originals must be on standard paper stock).

Note: In order to copy a stack of originals which contain different paper sizes, you must activate the “**Multisheet feeder mixed sizes**” special feature (program 32). Refer to the section entitled [Customizing your copier](#) in order to activate this copier setting.

Procedure:

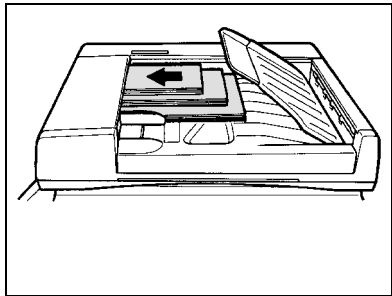
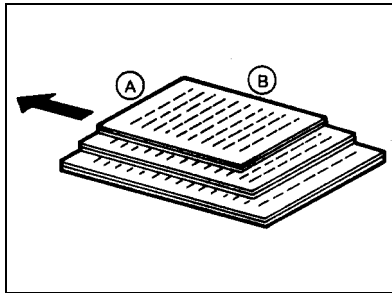

1. Align the originals at edges **A** and **B** (as shown in the illustration to the left).
2. Raise the original catch tray.
3. Place the stack of originals, *face up*, in the ADF/DADF; ensure that the stack of originals is in the SEF direction.
4. Lower the original catch tray.

Note:

- In order to have each copy on the same paper size as each original, select **100%** and select the **paper supply auto** option.
- In order to have all the copies on the same paper size, select the **reduce/enlarge auto** option and then select a specific **paper tray** (not auto).
- The bypass tray cannot be selected for this copy operation.

5. Select the desired basic and/or added copy features.
(Refer to the sections entitled [How to use the basic copying features](#) or [How to use the added copying features](#).)

6. Enter the copy quantity.

Note: 99 maximum for 1→1 and 2→1 copying
30 maximum for 1→2 and 2→2 copying

7. Press the **Start** button, .

Using the bypass tray

Use the bypass tray to run short copy jobs, to use a different copy paper size, or to copy onto special paper stock.

For detailed information on how to load copy paper into the bypass tray, refer to the section entitled [Loading the trays](#) and for the paper specifications, refer to the section entitled [Paper](#).

Procedure:

1. Open the document cover or ADF/DADF.
2. Place the original, *face down*, on the document glass and register it against the left rear corner of the glass.
3. Open the bypass tray door.
4. Slide out the extension tray to the desired paper length.
5. Adjust the paper guide to the desired paper width.

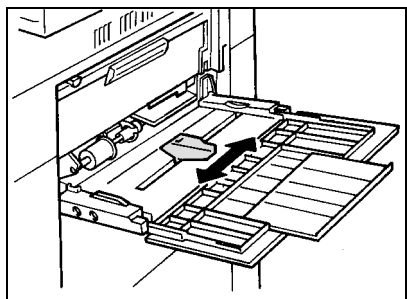
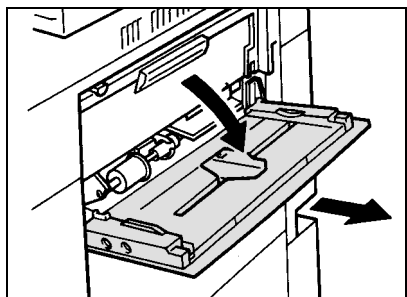
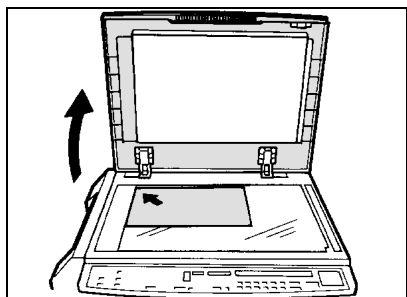

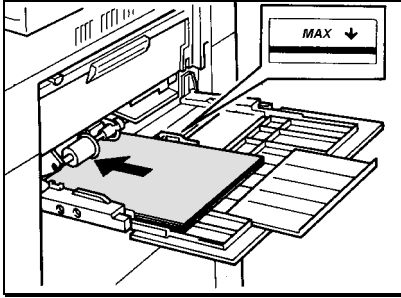

6. Place the required amount of copy paper into the bypass tray until it stops (do not force).

Note: Do not fill above the **MAX** line.

7. If required, select the desired basic copying features.

(Refer to the section entitled [How to use the basic copying features.](#))

Note: When using the bypass tray the following copier features become inactive:

- Added copying features
- Reduce/enlarge auto option
- Original→copy feature

8. Enter the copy quantity.

9. Press the **Start** button, .

10. When the copy job is complete, ensure the extension tray is pushed back into the bypass tray.

11. Close the bypass tray door.

How to use the basic copying features

With the copier default settings you can make copies by loading originals, entering the copy quantity, and pressing the **Start** button.

Before pressing the **Start** button, you can select various basic copying features that will enhance your copy jobs.

This section provides detailed information on how to use the basic copying features.

The following basic copying features are discussed:

- Paper supply
- Reduce/enlarge
- Copy density
- Original→copy
- Manual 2 sided copying
- Job interrupt

Paper supply



- 
-  1
-  2
-  3
-  5
- Auto



Use this feature to select the paper tray of your choice or to have the copier automatically select the appropriate tray.

This feature has the following options:

- Manual
- Auto

Note: When one of the paper size indicators below becomes lit, it informs you of the paper size that is in your tray selection. When an odd-paper size tray is selected the question mark becomes lit.



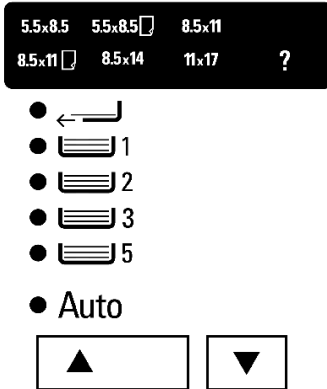



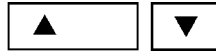

Manual





Select this option when you require a specific paper tray.

This option has the following selections:

- Bypass tray, 
- Tray 1, 
- Tray 2, 
- Tray 3, 
- Tray 5, 

Note: Paper tray 5 is available on some models.

Procedure:

1. Ensure your originals are loaded in the appropriate copier location.
2. Press the **Paper supply** button,  , to select the desired paper tray.
3. If required, select the desired basic and/or added copying features.
(Refer to the sections entitled [How to use the basic copying features](#) or [How to use the added copying features](#).)
4. Enter the copy quantity.
5. Press the **Start** button, .

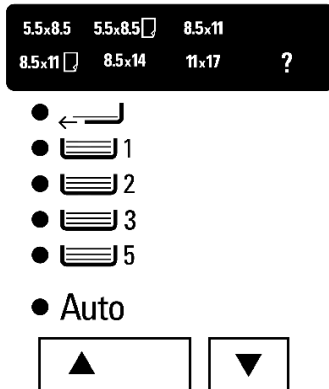

Auto

- Auto

Select this option when you desire the copier to select the appropriate paper tray size.

The automatic tray selection depends on the size of the original and the selected reduce/enlarge ratio.

Note: With this option you cannot select the **reduce/enlarge auto** option.

Procedure:

1. Ensure your originals are loaded in the appropriate copier location.
2. Ensure the **Paper supply** is set to ● Auto.
3. If required, select the desired basic and/or added copying features.

(Refer to the sections entitled [How to use the basic copying features](#) or [How to use the added copying features](#).)

4. Enter the copy quantity.
5. Press the **Start** button, .

Reduce/enlarge

- 154 %
- 129 %
- 77 %
- 64 %
- Auto
- 100 %



61 % ▶ 163 %



Use this feature to reduce or enlarge the image on the copies.

This feature has the following options:

- Auto
- Preset
- Variable

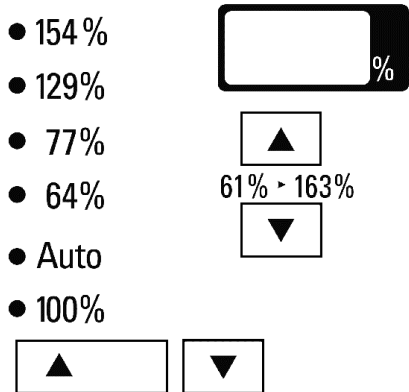



Auto

- Auto

Select this option when you desire the copier to automatically select the reduce/enlarge ratio to match the selected paper size.

Procedure:

1. Ensure your originals are loaded in the appropriate copier location.
2. Press the **Reduce/enlarge** button,  , to ● Auto.
3. If required, select the desired basic and/or added copying features.

Note: You cannot select the ● Auto option if one of the following is selected:

- The bypass tray
- A tray with a special size paper
- The book mode feature
- Paper supply auto option, ● Auto.

(Refer to the sections entitled [How to use the basic copying features](#) or [How to use the added copying features](#).)

4. Enter the copy quantity.
5. Press the **Start** button, .

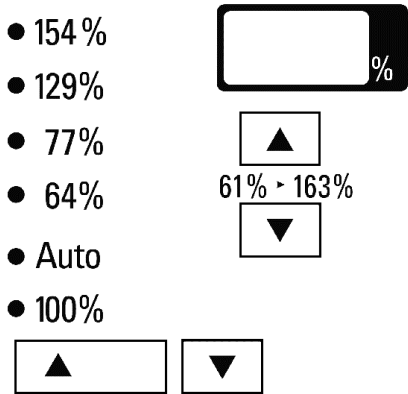

Preset



The preset set option provides you with five preset ratios. Select a preset ratio when your copy job requires one of the five following reduce/enlarge ratios (refer to the preset ratio chart below):

- 154%
- 129%
- 77%
- 64%
- 100%

Procedure:

1. Ensure your originals are loaded in the appropriate copier location.
2. Press the **Preset ratio** button, , to select the desired preset ratio.
3. If required, select the desired basic and/or added copying features.
(Refer to the sections entitled [How to use the basic copying features](#) or [How to use the added copying features](#).)
4. Enter the copy quantity.
5. Press the **Start** button, .

Preset Ratio Chart

Preset	Original	Output
154%	5.5x8.5 LEF	8.5x11 LEF
	8.5x11 SEF	11x17 SEF
129%	5.5x8.5 SEF	8.5x11 SEF
77%	8.5x11 SEF	5.5x8.5 SEF
64%	8.5x11 LEF	5.5x8.5 LEF
	11x17 SEF	8.5x11 SEF

- 154 %
- 129 %
- 77 %
- 64 %
- Auto
- 100 %



61 % - 163 %



Variable



61 % - 163 %



Select this option when you need to increase or decrease the reduction or enlargement ratio by 1% increments. You may select any percentage from 61% to 163%.

This option is useful when your original and/or copy paper size is not a standard size.

Procedure:

1. Ensure your originals are loaded in the appropriate copier location.



2. Press the **Variable** button, , to the desired increment.

Note: The variable ratio is displayed in the window display (example the ratio 78).

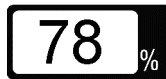

61 % - 163 %



3. If required, select the desired basic and/or added copying features.

(Refer to the sections entitled [How to use the basic copying features](#) or [How to use the added copying features](#).)

4. Enter the copy quantity.

5. Press the **Start** button, .

Copy density

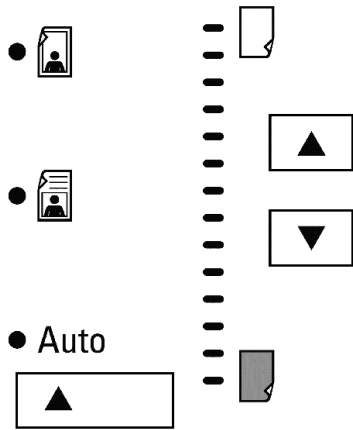

Originals may be poor in quality or printed on colored paper. Use this feature to improve the copies of these documents.

This feature has the following options:

- Exposure mode
- Copy lighter/darker

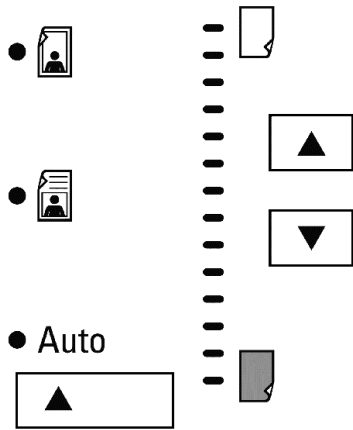

Exposure mode



The exposure mode option improves the copy quality of your originals by adjusting the copy density.

This option has three mode selections:

- Photo
- Manual
- Auto exposure

Note: Along with the appropriate mode selection you can also improve the quality of your copies by using the Copy lighter/darker option. If needed, refer to the section entitled *Copy lighter/darker*.

Photo



Select the photo mode to enhance the copies of photographs, magazines and newspapers.

Procedure:

1. Ensure your originals are loaded in the appropriate copier location.

2. Press the **Exposure mode** button, , to the photo mode, .

3. If required, select the desired basic and/or added copying features.

(Refer to the sections entitled [How to use the basic copying features](#) or [How to use the added copying features](#).)

4. Enter the copy quantity.

5. Press the **Start** button, .

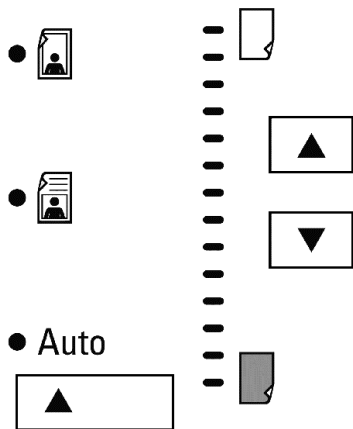



Manual



Select the manual mode when your originals mainly contain text. The manual mode allows you to adjust the background areas to your desired copy density.

Procedure:

1. Ensure your originals are loaded in the appropriate copier location.
2. Press the **Exposure mode** button, , to the manual mode, .
3. If required, select the desired basic and/or added copying features.
(Refer to the sections entitled [How to use the basic copying features](#) or [How to use the added copying features.](#))
4. Enter the copy quantity.
5. Press the **Start** button, .

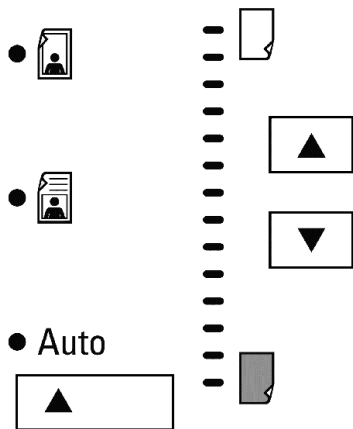

Auto exposure

- Auto

When the auto exposure mode is selected the copier automatically adjusts the copy contrast to the copy density of the original. Use this option when copying originals with a colored or dark background.

Procedure:

1. Ensure your originals are loaded in the appropriate copier location.
2. Ensure the **Exposure mode** is set to • Auto.
3. If required, select the desired basic and/or added copying features.

(Refer to the sections entitled [How to use the basic copying features](#) or [How to use the added copying features.](#))

4. Enter the copy quantity.

5. Press the **Start** button, .

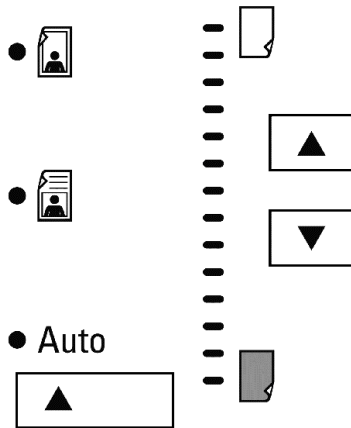

Copy lighter/darker



You can vary the copy contrast of your copies in small increments. Select this option to lighten or darken the contrast of your copies.

Procedure:

1. Ensure your originals are loaded in the appropriate copier location.



2. Press the **Copy lighter/darker** button, , to the desired light or dark selection.

3. If required, select the desired basic and/or added copying features.

(Refer to the sections entitled [How to use the basic copying features](#) or [How to use the added copying features](#).)

4. Enter the copy quantity.



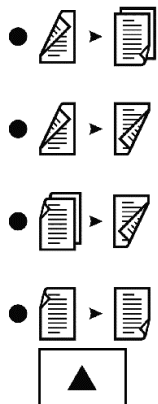

5. Press the **Start** button, .

Original → copy (XDL33D)



The XDL33D copier allows you to use 1 or 2 sided originals to create either 1 or 2 sided copies.

This feature has the following options:

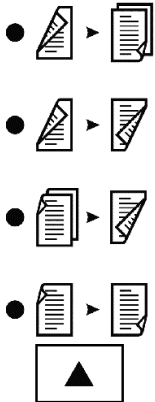

-  2→1 two-sided to one-sided
-  2→2 two-sided to two -sided
-  1→2 one-sided to two -sided
-  1→1 one-sided to one-sided

2→1



Select this option when you are copying 2-sided originals to 1-sided copies.

Procedure:

1. Ensure your originals are loaded in the DADF.
2. Press the **Original→copy** button, , to 2→1, .
3. If required, select the desired basic and/or added copying features.
(Refer to the sections entitled [How to use the basic copying features](#) or [How to use the added copying features](#).)
4. Enter the copy quantity.
5. Press the **Start** button, .

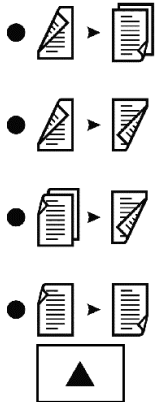



2→2



Select this option when you are copying 2-sided originals to 2-sided copies.

Procedure:

1. Ensure your originals are loaded in the DADF.
2. Press the **Original→copy** button, , to 2→2, .
3. If required, select the desired basic and/or added copying features.

(Refer to the sections entitled [How to use the basic copying features](#) or [How to use the added copying features](#).)



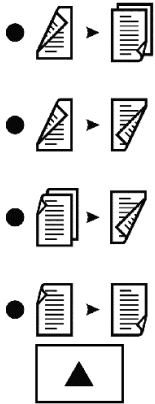

4. Enter the copy quantity.
5. Press the **Start** button, .

1→2



Select this option when you are copying 1-sided originals to 2-sided copies.

Procedure:

1. Ensure your originals are loaded in the DADF.
2. Press the **Original→copy** button, , to 1→2, .
3. Enter the number of the originals.
4. Press the **Start** button, .
5. If required, select the desired basic and/or added copying features.
(Refer to the sections entitled [How to use the basic copying features](#) or [How to use the added copying features](#).)
6. Enter the copy quantity.
7. Press the **Start** button, .

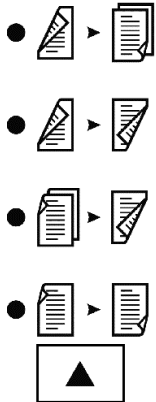



1→1



Select this option when you are copying 1-sided originals to 1-sided copies.

Procedure:

1. Ensure your originals are loaded in the DADF.
2. Press the **Original→copy** button, , to 1→1, .
3. If required, select the desired basic and/or added copying features.

(Refer to the sections entitled [How to use the basic copying features](#) or [How to use the added copying features](#)).

4. Enter the copy quantity.
5. Press the **Start** button, .

Manual 2 sided copying

Copiers which are equipped with an ADF can produce multiple 2 sided copies from 1 sided originals.

The ADF is available on certain models; for more information, call your local dealer.

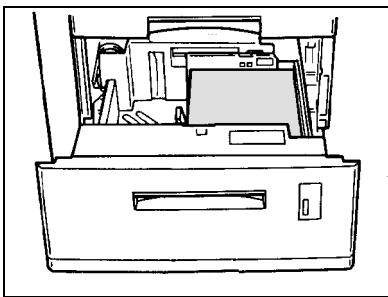
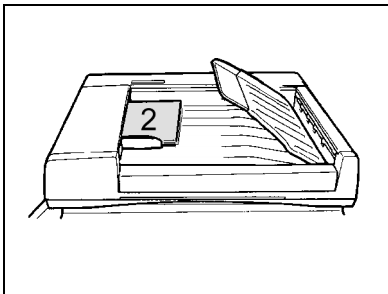
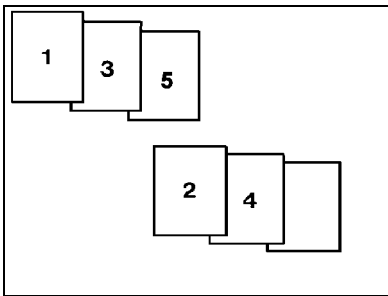
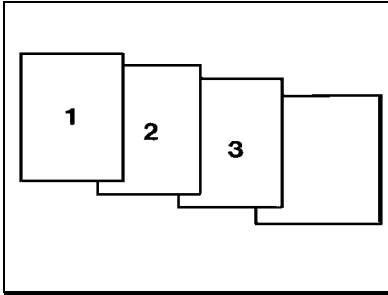

1. Count the number of originals. If you have an odd number of originals, add a blank sheet of paper to the end of the stack (as shown in the illustration to the left).

2. Separate into two piles the odd-numbered originals from the even-numbered originals (for example: 1, 3, 5...; 2, 4, 6...).

Note: The “odd-numbered originals” and “even-numbered originals” (shown in the illustration to the left) **do not** refer to actual page numbers which may be printed on the originals. The terms refer to the total number of documents in your document stack.

3. Place the even-numbered originals (2, 4, 6...) in the ADF. Ensure that the originals are *face up*.

4. Select a paper tray which contains the same size as your originals. Ensure that the paper in the tray is in the same direction as your originals. (If your originals are SEF the paper in the tray must be SEF. If your originals are LEF the paper in the tray must be LEF.)

5. Enter the desired copy quantity.

6. Press the **Start** button, .

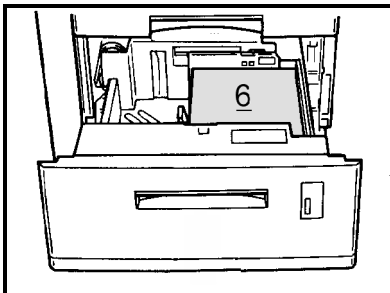
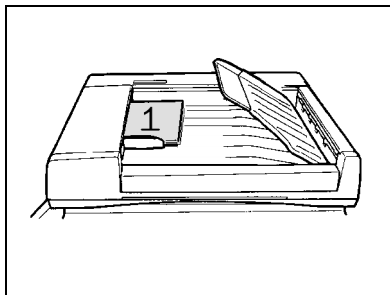
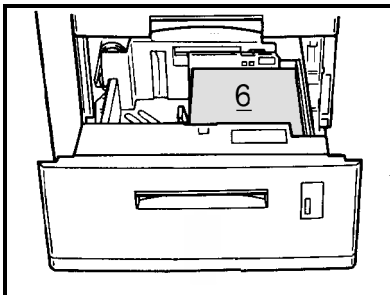
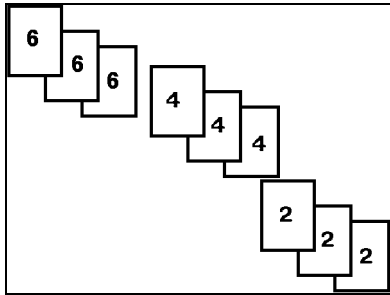
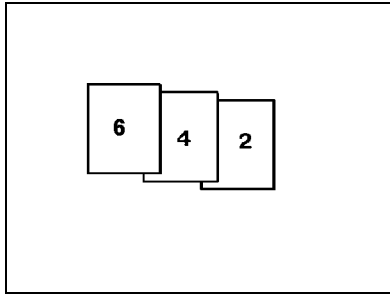

7. Remove the copies from the output device, and reorder them so that the last copy is first and the first copy is last: ...6, 4, 2.

Note: If your copy quantity is more than one copy, you must reorder the copies as follows: 6, 6, 6..., 4, 4, 4..., 2, 2, 2... Ensure that all the last copies (6, 6, 6...) are on the top of the stack.

8. Load the reordered copies into the same paper tray as the one used in Step 4. The copies must be *face up* and the bottom of the image must be placed toward the front of the tray.

9. Place the odd-numbered originals (1, 3, 5...) in the ADF. Ensure that the originals are *face up* and in the same direction as your even numbered originals were.

10. Select the paper tray which contains the reordered, even-numbered copies.

11. Select the same copy quantity as you did in Step 5.

12. Press the **Start** button, .

13. Remove your 2 sided copies from the output device.

Job interrupt



Select this feature when you need to interrupt the job you are running to perform a different job, and desire to go back to the first running job without reprogramming it.

Note: You cannot interrupt a copy job that has the auto stapling feature selected, .

Procedure:

1. Press the **Interrupt** button,  and wait for the copier to come to a complete stop.

Note: If you are using the ADF/DADF some uncopied originals may be delivered to the original catch tray.

2. Remove your original from the document glass or unload the **uncopied** originals from the ADF/DADF and place in a convenient location.
3. If you are using the ADF/DADF, remove the copied originals from the original catch tray making sure they do not get mixed up with the uncopied originals.
4. Place the second copy job original on the document glass or in the ADF/DADF.
5. If needed, select the desired basic and/or added copying features.

(Refer to the sections entitled [How to use the basic copying features](#) or [How to use the added copying features](#).)

6. Enter the copy quantity.

7. Press the **Start** button, .

8. Press the **Interrupt** button, .

9. Remove the second copy job original and copies.

10. Replace your original on the document glass or reload all **uncopied** originals from the first copy job into the ADF/DADF. Ensure the **uncopied** original order sequence is correct.

11. Press the **Start** button, .

How to use the added copying features

Along with the basic copying features, the XDL23/ XDL 33/ XDL 33D copier also provides additional copying features you can include with your copy jobs.

This section provides detailed information on how to use the added copying features.

The following added copying features are discussed:

- Special features
- Stapling
- Collated
- Book mode
- Margin shift
- Edge deletion

Special features

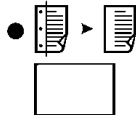
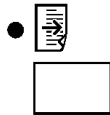
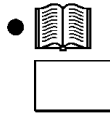
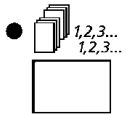
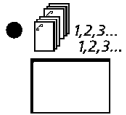

Select this feature to access, view or change the factory default settings.

For detailed information about each of the copier default settings and how to change them, refer to the section entitled [Customizing your copier](#).

Stapling

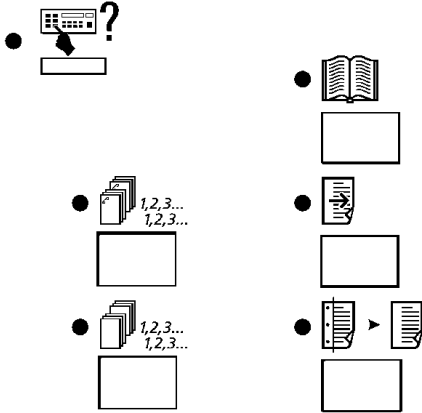

This copier operation allows you to staple copy sets that are sent to the 10-bin sorter stapler.

For detailed information about the sorter bin capacity and paper specifications, refer to the sections entitled [Paper](#) or [Technical data](#).

The 10-bin sorter stapler provides the following stapling operations:

- Auto stapling
- Manual stapling
- Stapling without copying

Note: The 10-bin sorter stapler is available on some models.

Auto stapling

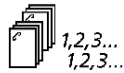

Select this operation when you desire the sorter to automatically staple the copy sets that are sent to the sorter bins.

Note: The auto stapling mode also requires the copier to be equipped with an ADF/DADF.

Procedure:

1. Ensure your originals are placed in the ADF/DADF.

Note: 5.5x8.5in./A5 to 10x14in./B4 15 sheets max
11x17/A3 10 sheets max
2. If needed, select the desired basic and/or added copying features.

(Refer to the sections entitled [How to use the basic copying features](#) or [How to use the added copying features](#).)

Note: You cannot use the auto stapling operation when using the document glass or when the bypass tray is selected.

3. Select the **Stapling** button, 
4. Enter the copy quantity.

Note: 10 max

5. Press the **Start** button, .

Manual stapling



Select this operation when you need to have the copy sets stapled after the copy job has been completed and the copy sets are still in the sorter bins.

Procedure:

1. Ensure the copy job is complete.
2. Do not remove the copy sets from the sorter bins.
3. Press the **Manual stapler** button, , on the sorter.

Caution: Do not remove any copy sets until the staple operation is complete.

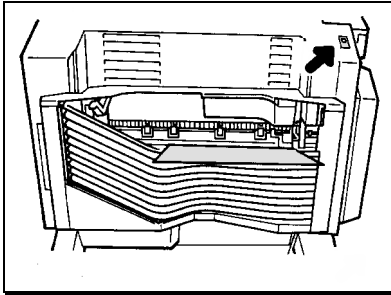

Stapling without copying



Select this operation when you need to staple a set of sheets quickly, or need to test the stapler.

Procedure:

1. Place a set of sheets up against the front edge of the top sorter bin.

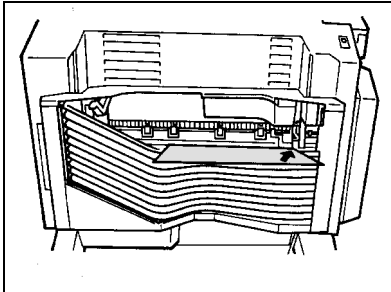

2. Press the **Manual stapler** button, , on the sorter.

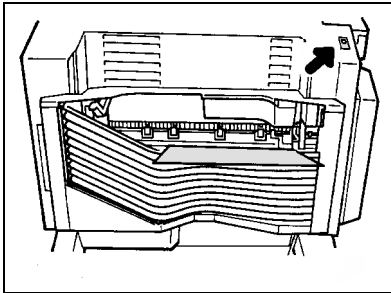

Collated

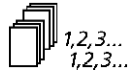
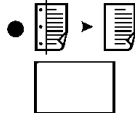
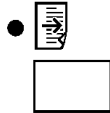
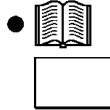
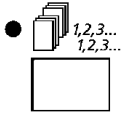
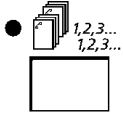

Select this feature when you need to have collated copy sets delivered to the sorter bins. Each copy set is delivered in the order the originals were placed in the ADF/DADF or from the document glass.

For detail information on the sorter bin capacity refer to the sections entitled *Paper* or *Technical data*.

Note: The collated feature requires the copier to be equipped with the 10-bin sorter stapler.

Procedure:

1. Ensure your originals are placed in the ADF/DADF.
2. If needed, select the desired basic and/or added copying features.

(Refer to the sections entitled *How to use the basic copying features* or *How to use the added copying features*.)

3. Press the **Collated** button, 
4. Enter the copy quantity.

Note:

5.5x8.5in./A5 to 8.5x11in./A4	30 max
8.5x14in./216x353mm to 10x14in./B4	25 max
11x17in./A3	10 max

5. Press the **Start** button, .

Book mode

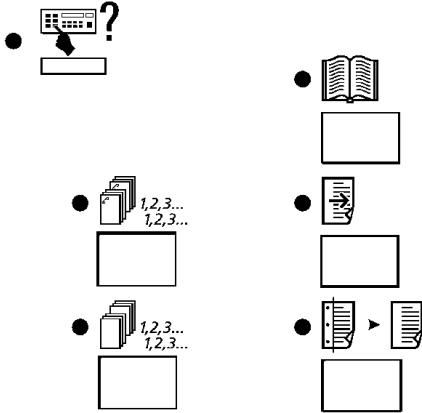

Select this feature to copy facing pages of a book or magazine.

To change the fixed paper size of a tray, contact **1-800-TEAM XRX (1-800-832-6979)**.

Note: The **paper supply auto** or the **reduce/enlarge auto** options cannot be activated when the book mode feature is selected.

Procedure:

1. Raise the document cover or ADF/DADF cover.
2. Place the book or magazine, face down, on the document glass and register it with the spine of the book lined up with 8.5 and against the top of the glass.

3. Lower the document cover or ADF/DADF cover. **Do not** force the document cover or the ADF/DADF cover onto the book or magazine.

4. Select the desired paper tray.

Note: The bypass tray can not be selected.

5. If needed, select the desired basic and/or added copying features.

(Refer to the sections entitled [How to use the basic copying features](#) or [How to use the added copying features](#).)

6. Press the **Book mode** button, .

7. Enter the copy quantity.

8. Press the **Start** button, .

Margin shift

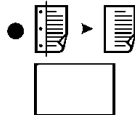
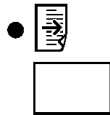
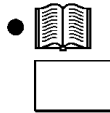
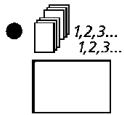
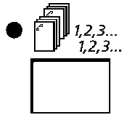

Select this feature to move the copy image to the right and leave a staple or punch margin on the left edge of the copy.

Note: The factory default is set to a 10mm margin shift. To change the default, refer to the section entitled [Customizing your copier](#).

Procedure:

1. Ensure your originals are loaded in the appropriate copier location.

2. Press the **Margin shift** button, .

Note: The bypass tray can not be selected.

3. If required, select the desired basic and/or added copying features.

(Refer to the sections entitled [How to use the basic copying features](#) or [How to use the added copying features](#).)

4. Enter the copy quantity.

5. Press the **Start** button, .

Edge deletion

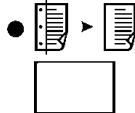
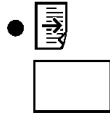
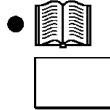
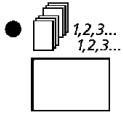
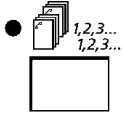

Select this feature to delete unwanted images on the edge of a copy (example: punched holes).

Note: The factory default is set to a 10mm edge deletion. To change the default, refer to the section entitled [Customizing your copier](#).

Procedure:

1. Ensure your originals are loaded in the appropriate copier location.

2. Press the **Edge deletion** button, .

Note: The bypass tray can not be selected.

3. If required, select the desired basic and/or added copying features.

(Refer to the sections entitled [How to use the basic copying features](#) or [How to use the added copying features](#).)

4. Enter the copy quantity.

5. Press the **Start** button, .

Customizing your copier

The XDL23/XDL33/XDL33D copier allows you to customize the special features. The special features contain various copier settings that are set in the factory.

This section provides a description of the special feature settings and how to change them.

Identifying the special features













Special feature	Program Number	Option number and option (default is in bold)
<p>Tray</p> <p>This default sets the tray that is selected when the copier is in the normal copy mode or when the Clear all button is pressed.</p>	20	Bypass Tray 1 Tray 2 Tray 3 Tray 5 Auto
<p>Automatic clear</p> <p>This default allows you to activate or deactivate the time (60 seconds) it takes the copier to return to the normal copy mode after the copy cycle is complete.</p>	21	0 - Deactivate 1 - Activate
<p>Auto tray switch</p> <p>This default allows you to activate or deactivate the copier from automatically switching to two or more trays loaded with the same paper size for continuous feeding.</p>	22	0 - Deactivate 1 - Activate
<p>Power saver</p> <p>This default allows you to change the period of idle time required for the copier to go into the low power mode.</p>	24	0 - deactivate 1 - 4min. 2 - 6min. 3 - 10min. 4 - 18min. 5 - 32min. 6 - 62min. 7 - 122min. 8 - 242min. 9 - 482min.
<p>Copy cartridge life</p> <p>This displays the remaining drum cartridge life on the message display.</p>	81	N/A
<p>Enable accessory kits</p> <p>Enables the Card Reader (XEROX or 3rd party)</p>	91	0 - Deactivate 1 - Activate







Special feature	Program number	Option number and option (default is in bold)
Reduce/enlarge This default sets the reduce/enlarge ratio that is selected when the copier is in the normal copy mode or when the Clear all button is pressed.	25	154% 129% 77% 64% Auto 100%
Original size This default sets the paper tray that is used when no original size is detected by the paper supply auto or reduce/enlarge auto options.	28	Auto 8.5x11in. SEF 8.5x11in. LEF 8.5x14in. SEF 11x17in. SEF
Multisheet feeder mixed sizes This default allows you to activate or deactivate the feature of copying different size originals with the ADF or DADF.	32	0 - Deactivate 1 - Activate
Default priority tray This default sets the paper tray that is used when the paper supply auto option is selected.	33	Bypass Tray 1 Tray 2 Tray 3 Tray 5 Auto
Density mode This default sets the density mode that is selected when the copier is in the normal copy mode or when the Clear all button is pressed.	45	0 - Auto 1 - Manual 2 - Photo
Edge delete This default allows you to change the edge deletion setting by 1mm increments from 0-16mm.	52	10mm
Margin shift This default allows you to change the margin shift setting by 1mm increments from 0-16mm.	51	10mm



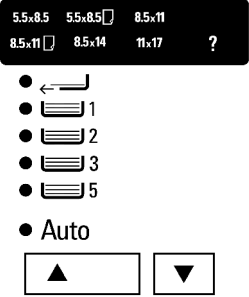



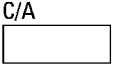

How to change the special feature settings





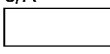



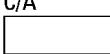

To change the special features, find the name of the feature and follow the associated instructions.

Note: To customize more than one feature, follow the instructions of the other special feature before exiting to the normal copy mode.

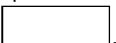
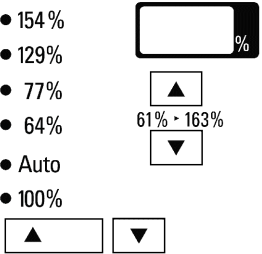
Program	Special feature name	Option	Instructions on how to change the setting
20 33	Tray Default priority tray	 <ul style="list-style-type: none"> ●  1 ●  2 ●  3 ●  5 ● Auto <div style="display: flex; justify-content: center; gap: 10px;"> <input style="width: 40px; height: 20px; border: 1px solid black;" type="text" value="▲"/> <input style="width: 40px; height: 20px; border: 1px solid black;" type="text" value="▼"/> </div>	<ol style="list-style-type: none"> 1. Press the Special features button,  ?. 2. Enter the program number. 3. Press the Start button, . 4. Press the Paper supply button,  , to the desired tray. 5. Press the Start button, . 6. Press the Special features button,  ? ,or the Clear all button,  C/A, to program the setting and exit to the normal copy mode.

Program	Special feature name	Option	Instructions on how to change the setting
28	Original Size		<ol style="list-style-type: none"> 1. Press the Special features button,  ?. 2. Enter the program number. 3. Press the Start button, . 4. Press the Paper supply button,  , and watching the size LED, select the desired original size. Note: When Auto is selected, the select paper tray icon or message will appear. 5. Press the Start button, . 6. Press the Special features button,  ? or the Clear all button,  C/A, to program the setting and exit to the normal copy mode.

Program	Special feature name	Option	Instructions on how to change the setting
<p>21 22 91 32</p>	<p>Automatic clear Auto tray switch Enable accessory kits Multisheet feeder mixed sizes</p>	<p>0 to deactivate 1 to activate</p>	<p>1. Press the Special features button,  ?.</p> <p>2. Enter the program number.</p> <p>3. Press the Start button, .</p> <p>4. Press 0 to deactivate or press 1 to activate.</p> <p>5. Press the Start button, .</p> <p>6. Press the Special features button,  ?, C/A or the Clear all button, , to program the setting and exit to the normal copy mode.</p>
<p>81</p>	<p>Copy cartridge life</p>	<p>N/A</p>	<p>1. Press the Special features button,  ?.</p> <p>2. Enter the program number.</p> <p>3. Press the Start button, . The remaining copy life of the cartridge is displayed on the message display.</p> <p>4. Press the Special features button,  ?, C/A or the Clear all button, , to exit to the normal copy mode.</p>

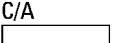
Program	Special feature name	Option	Instructions on how to change the setting																						
24	Power saver	<table border="0"> <tr> <td>Number</td> <td>Selection</td> </tr> <tr> <td>0</td> <td>deactivate</td> </tr> <tr> <td>1</td> <td>4min.</td> </tr> <tr> <td>2</td> <td>6min.</td> </tr> <tr> <td>3</td> <td>10min.</td> </tr> <tr> <td>4</td> <td>18min.</td> </tr> <tr> <td>5</td> <td>32min.</td> </tr> <tr> <td>6</td> <td>62min.</td> </tr> <tr> <td>7</td> <td>122min.</td> </tr> <tr> <td>8</td> <td>242min.</td> </tr> <tr> <td>9</td> <td>482min.</td> </tr> </table>	Number	Selection	0	deactivate	1	4min.	2	6min.	3	10min.	4	18min.	5	32min.	6	62min.	7	122min.	8	242min.	9	482min.	<ol style="list-style-type: none"> Press the Special features button,  ? Enter the program number. Press the Start button, . To change the preset value, press the desired number using the keypad, (0-9). Press the Start button, .
Number	Selection																								
0	deactivate																								
1	4min.																								
2	6min.																								
3	10min.																								
4	18min.																								
5	32min.																								
6	62min.																								
7	122min.																								
8	242min.																								
9	482min.																								
45	Density mode	<table border="0"> <tr> <td>Number</td> <td>Selection</td> </tr> <tr> <td>0</td> <td>Auto</td> </tr> <tr> <td>1</td> <td>Variable</td> </tr> <tr> <td>2</td> <td>Photo</td> </tr> </table>	Number	Selection	0	Auto	1	Variable	2	Photo	<ol style="list-style-type: none"> Press the Special features button,  ? Press the Special features button,  ? , or the Clear all button,  , to program the setting and exit to the normal copy mode. 														
Number	Selection																								
0	Auto																								
1	Variable																								
2	Photo																								
52	Edge delete	0 - 16mm																							
51	Margin shift	0 - 16mm																							
25	Reduce/enlarge	<ul style="list-style-type: none"> • 154% • 129% • 77% • 64% • Auto • 100% 	<ol style="list-style-type: none"> Press the Special features button,  ? Enter the program number. Press the Start button, . Press the Reduce/enlarge button,  , to the desired ratio. Press the Start button, . Press the Special features button,  ? , or the Clear all button,  , to program the setting and exit to the normal copy mode. 																						

Total copy counter

The XDL23/XDL33/XDL33D copier is equipped with a total copy count meter. The counter allows the operator to access the total number of copies made on the copier.

To view the total number of copies made, open the front cover and locate the total copy counter.

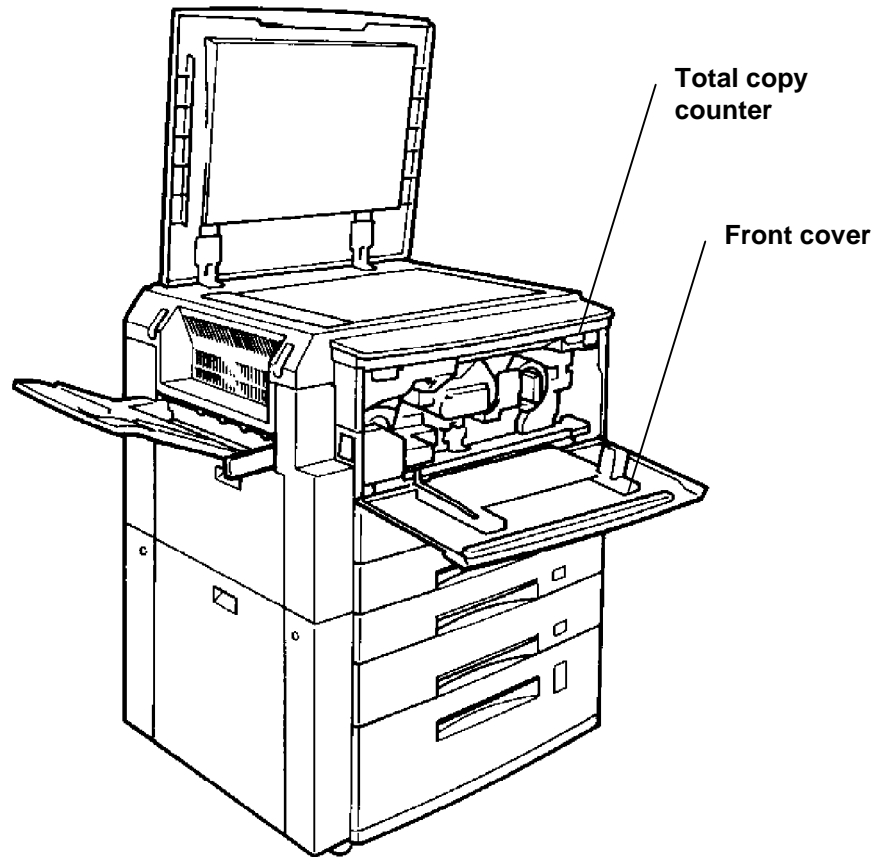

Copier care

Ordering supplies

To order supplies for your copier, contact your local dealer or (in the US and Canada) XEROX supply net toll free at: **1-800-822-2200**

Toner cartridge: 6R918

Drum cartridge: 13R555

Staples: 8R7907

Replacing the drum cartridge

When the drum cartridge nears its end of life, the drum indicator becomes lit; . This occurs when the drum cartridge has approximately 5000 copies remaining.

You can continue to make copies until the indicator begins to flash and a J7 status code is displayed. When this occurs the copier will not operate until the cartridge is replaced. Use the following procedure to change the cartridge.

Procedure:

1. Switch the copier off.
2. Open the copier front cover.
3. Lift up on the copier release lever and open the copier.
4. Press the drum cartridge release button and gently slide the cartridge out halfway.

Caution: Never touch the fuser area. It is extremely hot.

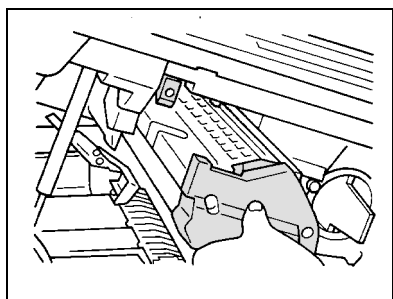
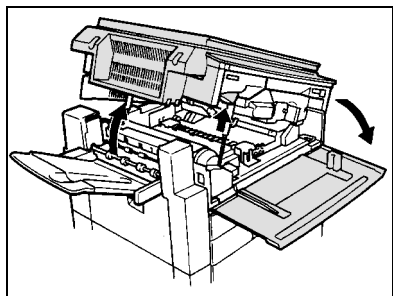

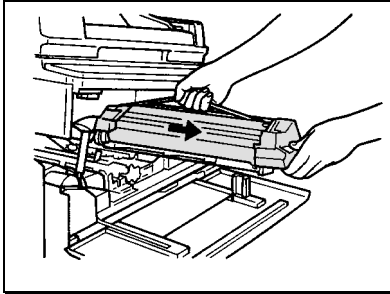

5. Hold onto the drum cartridge handle and slide the cartridge out of the copier.

Note: Help the environment by recycling your used drum cartridge. Refer to the XEROX green team brochure packed with the drum cartridge for instructions on how to return the used cartridge to XEROX.

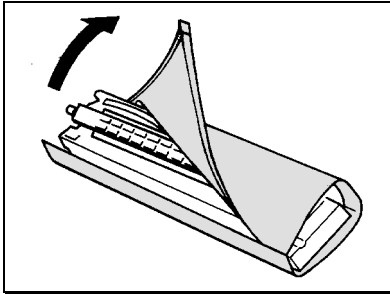

6. Unpack the new drum cartridge and place on a flat surface.
7. Remove the protective material.

Note: To help prevent copy quality problems, never touch the shiny surface of the drum.

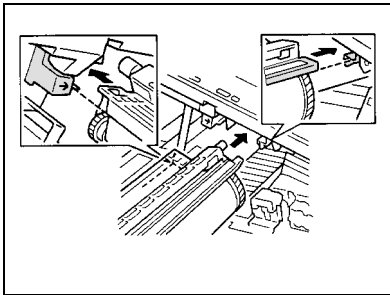

8. Position the drum cartridge guide onto rail, making sure not to touch the surface of the drum.

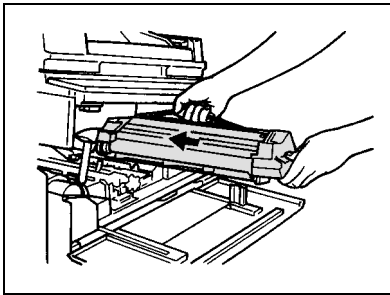

9. Slide the cartridge into the copier. Ensure the cartridge is installed correctly.

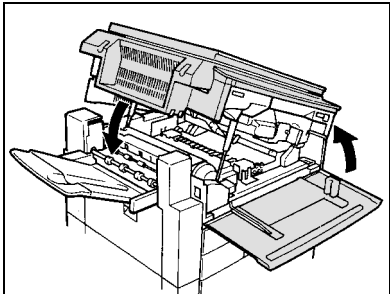

10. Close the copier
11. Close the copier front cover.
12. Switch the copier on.
13. Ensure the drum indicator is off, .

Replacing the toner cartridge

When the toner supply becomes low, the toner indicator flashes, . You can continue to make copies until the toner indicator is lit continuously and a J1 status code is displayed. When this occurs the copier will not operate until the cartridge is replaced. Use the following procedure to change the cartridge.

Note: For toner consumption information, refer to *Toner cartridge yield* in this section.

Procedure:

1. Switch the copier off.
2. Open the copier front cover.
3. Place a sheet of paper on top of the cover to catch any loose toner.
4. Press and hold the toner cartridge release button.
5. Rotate the empty cartridge in the direction of the arrow until it stops.
6. Slide the cartridge out gently.

Note: Help the environment by recycling your used toner cartridges. Refer to the XEROX green team brochure packed with the toner cartridges for instructions on how to return the used cartridges to XEROX.

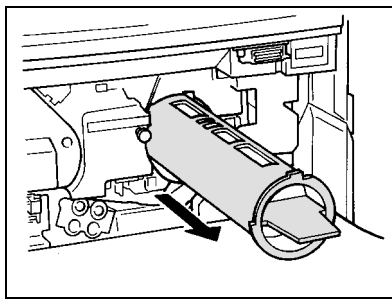
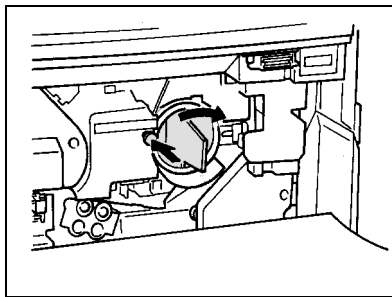
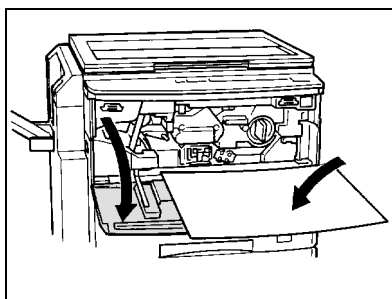

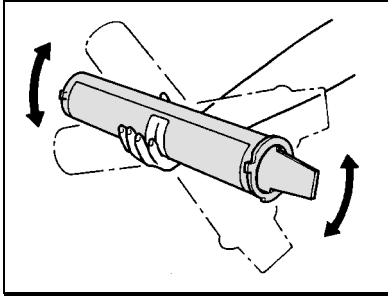

7. Unpack the new toner cartridge and shake it several times.

Note: Do not pull the protective seal off at this time.

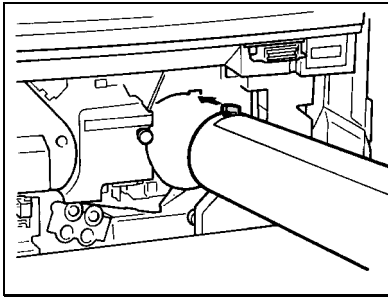

8. Place the new cartridge on the holder and insert the tab on the end of the cartridge into the cutout.

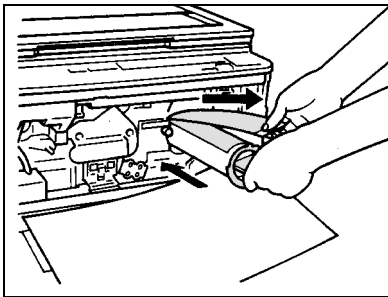

9. While holding the cartridge with the protective seal up in one hand, remove the seal toward you and slide in the cartridge halfway.

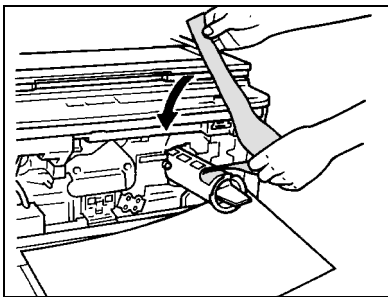

10. When you have peeled the seal as far as the line position, fold back the seal and remove the folded seal toward you.

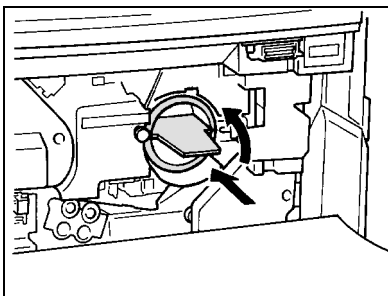

11. Hold the tab and push the cartridge all the way in, then rotate it counterclockwise until it clicks.

Note: You can not rotate the cartridge until it is pushed in all the way.

12. Remove the sheet of paper on the copier front cover.

13. Switch the copier on.

14. Ensure the toner indicator is off, .

Note: If the toner indicator did not turn off, do not pull the cartridge out and try to reinsert it. Please call 1-800-TEAM-XRX (in the United States and Canada) for further assistance.

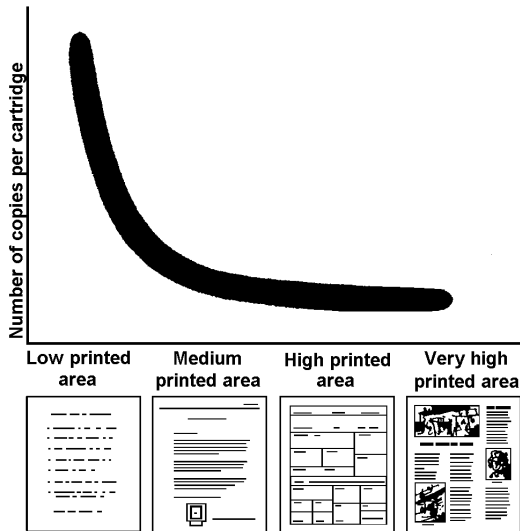

Toner cartridge yield

The main factor affecting toner cartridge yield is the printed area of a document. The graph is a sample representation of how the number of copies per cartridge decreases as the printed area increases.

- Other factors which can affect the toner cartridge yield are:
- The size of the document being copied.
- Dark backgrounds.
- Leaving the platen cover open.
- The number of times the copier is switched on and off.
- Double sided copying will use more toner per ream of paper.
- High humidity.

To get the most from your toner cartridge:

- Always copy with the document cover closed.
- Leave the copier on during the day. Switch off the copier at the end of the working day.
- Copy with the exposure control set to Auto exposure unless you need to adjust for the background of your original.
- Operate the copier in a dry environment whenever possible.

Cleaning the document glass and cover

Keeping the document glass and document cover clean helps ensure the best possible copies. XEROX suggests that you clean the document glass at the start of each day and during the day as needed.

Caution: Do not pour or spray water directly onto any part of the copier.

Note: For copiers equipped with the ADF/DADF refer to the ADF/DADF belt cleaning section to clean the belt.

Procedure:

1. Slightly dampen a soft lint-free cloth or paper towel with water.
2. Open the document cover or ADF/DADF.
3. Wipe the surface of the document glass until it is clean and dry.
4. Wipe the underside of the document cover until it is clean and dry (skip this step if there is an ADF/DADF on the copier).
5. Close the document cover or ADF/DADF.

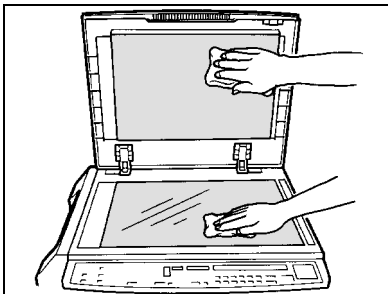
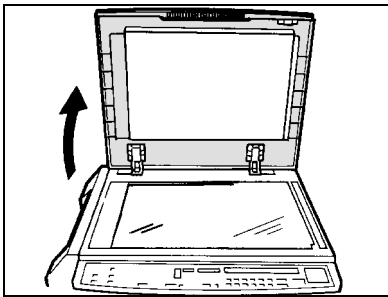
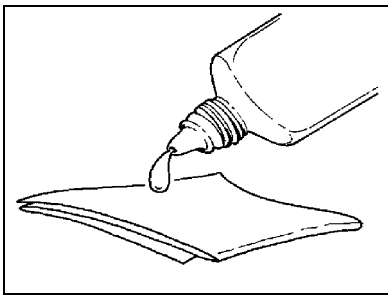

Adding staples

This section provides you with detailed information on how to add staples to the 10-bin sorter stapler. If needed, use the spare staple compartment, inside the sorter front cover, to store up to five boxes of staples.

Spare staple compartment

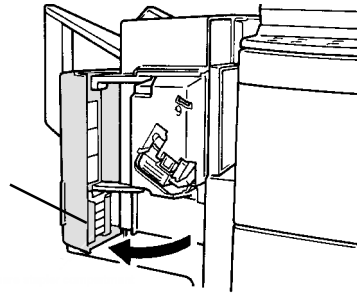

To order staples for your copier, (in the United States and Canada) call XEROX SupplyNet toll at: **1-800-822-2200**

Procedure:

Note: XEROX recommends that you use staples which are designed for the 10-bin sorter stapler (reorder part number 8R7907).

1. Switch the copier off.
 2. Open the sorter stapler front cover.
 3. Press the stapler release handle to unlock the stapler.
 4. Slide out the stapler until it stops.
 5. Open the upper stapler section and load the staples.
- Note:** You can load a maximum of 100 staples.

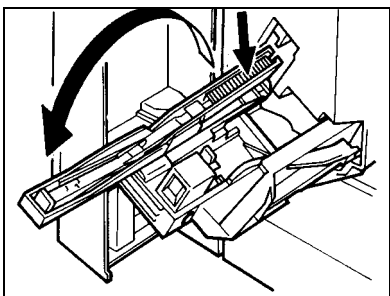
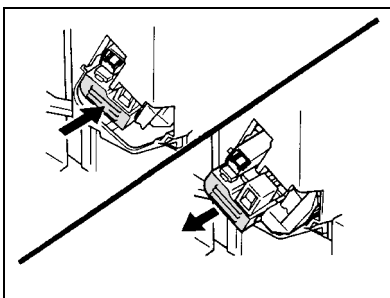
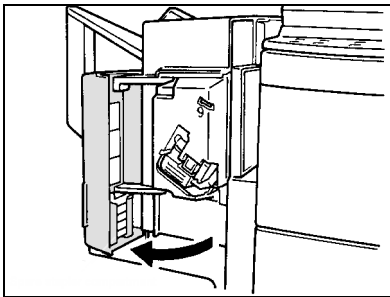

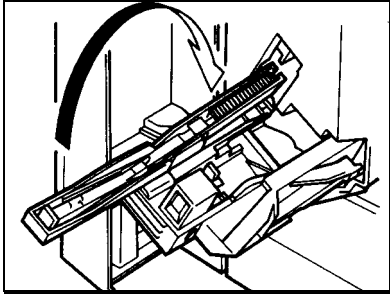

6. Close the upper stapler section.

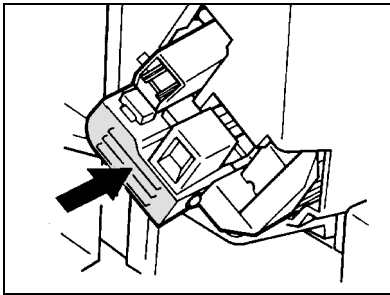

7. Slide the stapler back into the sorter until it clicks. Ensure the stapler is in the correct position.

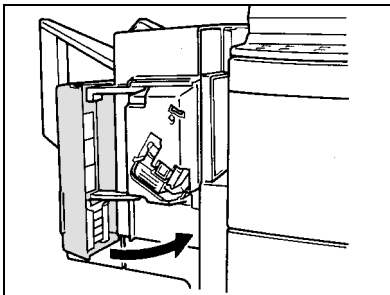

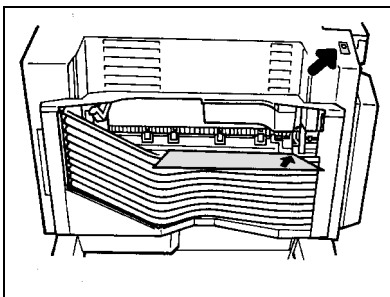

8. Close the sorter stapler front cover.

9. Switch the copier on.



10. Position a sheet of paper along the front edge of the top bin.

11. Press the **Manual stapler** button, . Ensure the paper is stapled properly.

Note: If needed, press the **Manual stapler** button, , repeatedly until the stapler operates.

Cleaning the ADF/DADF belt

Keeping the ADF/DADF belt clean helps prevent ADF/DADF misfeeds. XEROX suggests that you clean the belt as needed.

Note: This procedure is for copiers which are equipped with the ADF/DADF.

Caution: Do not pour or spray water directly on the belt.

Procedure:

1. Switch the copier off.
2. Slightly dampen a soft lint-free cloth or paper towel with water.
3. Raise the ADF/DADF.
4. Cover the document glass to prevent water from spilling on the glass.
5. Wipe the exposed surface of the belt until it is clean.
6. Pull the belt from the right to left to expose dirty sections of the belt.
7. Repeat the cleaning procedure until the entire belt is clean and dry.
8. Close the ADF/DADF.
9. Switch the copier on.

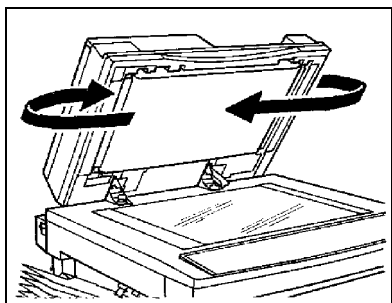
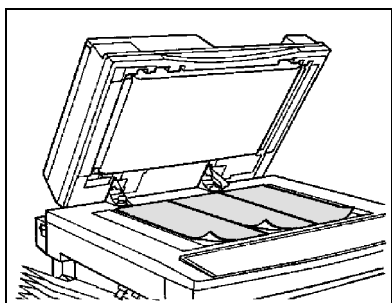
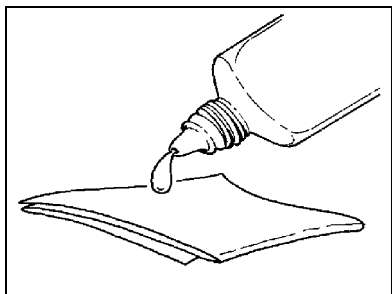

Problem solving

This section provides you with copier problems that may occur, their recommended solutions, and other information to assist you when solving problems.

The following topics are discussed:

- Problem solving charts
- XDL33D problem solving messages
- Status code list
- Clearing the status codes
- Call for service
- Relocating the copier

Problem solving charts

The problem solving charts list copier problems that may occur and their suggested solutions.

Follow the suggested solutions until the problem is corrected. If the problem persists, call for service.

The following charts are available:

- General
- Misfeeds
- Copy quality

General

Problem	Suggested solutions
<p>(XDL23/XDL33)</p> <p>The Ready to copy indicator light does not come on.</p>	<ul style="list-style-type: none"> • Ensure the power cord is plugged into the receptacle correctly. • Ensure the power switch is set to the on position. • Check that the GFI is in the on position and try resetting.
<p>(XDL33D)</p> <p>The message Ready to copy or Press Start to continue does not appear.</p>	<ul style="list-style-type: none"> • Ensure the power cord is plugged into the receptacle correctly. • Ensure the power switch is set to the on position. • Check that the GFI is in the on position and try resetting.
<p>Copies are not copied on the desired paper size.</p>	<p>If the Auto option is selected in paper supply, then:</p> <ul style="list-style-type: none"> • Clean the document glass. • Clean the underside of the document cover, or the ADF/DADF belt. • If your original is a transparency, place a sheet of white copy paper over the original. <p>If the Auto option is not selected in paper supply, then:</p> <ul style="list-style-type: none"> • Ensure the original is correctly positioned against the registration guide on the document glass. • Select the desired paper tray and reduce/enlarge ratio, press the Start button.

Misfeeds

Problem	Suggested solutions
Documents or paper is misfed.	<ul style="list-style-type: none"> • If a status code appears (XDL23/XDL33) or a message (XDL33D), refer to the appropriate section entitled Clearing the status codes (XDL23/XDL33) or XDL33D problem solving messages (XDL33D). • Ensure the paper trays and bypass trays are firmly in place.
Paper misfeeds or wrinkles occur repeatedly.	<ul style="list-style-type: none"> • Ensure the paper trays and the bypass tray are not filled above the MAX lines. • Turn the paper stack around and/or over in the selected paper tray. • Replace the paper in the selected paper tray with paper from a new package. • If there are corner snubbers in the selected paper tray ensure the paper is under the snubbers. • Remove any partially feed paper from the trays. • Fan all four edges of the paper in the selected paper tray. • Ensure the proper paper specifications are used in the trays, refer to the section entitled Paper. • Remove a few sheets from the top and the bottom of the stack in the selected paper tray. • Do not leave the paper in high humidity areas for extended periods of time. • Paper should be kept in the original wrapper and stored flat in a dry environment when not in use.
Documents do not feed in when using the ADF/DADF.	<ul style="list-style-type: none"> • If a status code appears (XDL23/XDL33) or message (XDL33D), refer to the appropriate procedure in the section entitled Clearing the status codes (XDL23/XDL33) or XDL33D problem solving messages (XDL33D). • Ensure all the ADF/DADF covers are closed. • Ensure the proper original paper specifications are used in the ADF/DADF, refer to the section entitled Paper.
The corner of a document is folded when using the ADF/DADF.	<ul style="list-style-type: none"> • Ensure the originals are not curled. Make a copy of any damaged original and reload the new and uncurled original in the ADF/DADF.
Documents misfed repeatedly when using the ADF/DADF.	<ul style="list-style-type: none"> • Ensure the guide in the ADF/DADF is touching the edge of the originals. • Ensure the proper original paper specifications are used in the ADF/DADF, refer to the section entitled Paper.

Copy quality

Problem	Suggested solutions
Copies appear dark.	<ul style="list-style-type: none"> • Clean the document glass. • Ensure the proper exposure mode is selected, refer to the section entitled <i>How to use the basic copying features</i>. • Lighten the copy, press the copy lighter/darker button to a lighter selection. If needed, refer to the section entitled <i>How to use the basic copying features</i>. • If your original is a transparency, place a sheet of white copy paper over the original.
Copies are light overall.	<ul style="list-style-type: none"> • Ensure the proper exposure mode is selected, refer to the section entitled <i>How to use the basic copying features</i>. • Darken the copy, press the copy lighter/darker button to a darker selection. If needed, refer to the section entitled <i>How to use the basic copying features</i>.
Copy images are partially deleted.	<ul style="list-style-type: none"> • Inspect the original, ensure the original is good. • Turn the stack of paper over in the selected paper tray. • Replace the paper in the selected paper tray with paper from a new package. • Clean the document glass. • Do not leave the paper in high humidity areas for extended periods of time.
Copy images are distorted or skewed.	<ul style="list-style-type: none"> • Inspect the original, ensure the original is good. • Ensure the position of the original is placed on the document glass or the ADF/DADF correctly. • Ensure the paper is loaded correctly in the selected paper tray. Reload the paper. • Ensure all the paper trays and the bypass tray are firmly in place. • If using the ADF/DADF, ensure the guide is touching the edge of the originals.

XDL33D problem solving messages

If a problem occurs, a typed message is displayed on the message display and an indicator starts to flash on the control panel.

The flashing indicator informs you of the area that needs attention. Follow all the messages to correct the problem.

You can also view the status code that is associated with the copier problem by pressing the **0** button.

Once the status code appears you can refer to the status code procedure in the section entitled *Clearing the status codes* to solve the copier problem.

Note: When the status code appears, use the first two characters to identify the status code. (Example F1-1, you would go to the F1 status code procedure.)







Status code list

The status code list provides you with a list of all the copier status codes, identifies the problem, and provides suggested solutions for the code.

Follow the suggested solutions until the problem is corrected. If the problem persists, call for service.

Status code	Problem and suggested solutions
A1-A3	Document misfeed in the ADF/DADF, refer to the appropriate A1-A3 status code procedure in the section entitled <i>Clearing the status codes</i> .
A5	The ADF/DADF cover is open. Close the cover.
A6	Remove originals from the ADF/DADF. Reorder and reload the originals and press the Start button.
A8	The ADF/DADF original catch tray is in the raised position. Lower the original catch tray.
C1-C4	Paper misfeed, refer to the C1-C4 status code procedure in the section entitled <i>Clearing the status codes</i> . If the status code remains perform the E1-E3 status code procedure.
C8	Paper misfeed, refer to the C8 status code procedure in the section entitled <i>Clearing the status codes</i> . If the status code remains perform the E1-E3 status code procedure.
C9	Paper misfeed in the bypass tray, refer to the C9 status code procedure in the section entitled <i>Clearing the status codes</i> .
E1-E3	There is a paper misfeed inside the copier or in the paper exit area, refer to the E1-E3 status code procedure in the section entitled <i>Clearing the status codes</i> .
E5	The copier front cover is open. Close the cover.
E6	The copier right upper or right lower cover is open. Close the cover.
F1	Remove the misfed sheet in the sorter, refer to the F1 status code procedure in the section entitled <i>Clearing the status codes</i> .
F5	The sorter is unlatched to the copier or the sorter stapler cover is open. Latch the sorter and/or close the sorter stapler cover.
F9	<ul style="list-style-type: none"> • An excessive number of sheets to be stapled by the 10-bin sorter stapler, remove the sets of copies. Reduce the number of sheets and try again. • The stapler is not correctly set in position. Open the sorter front cover and reset the stapler, refer to the F9 status code procedure in the section entitled <i>Clearing the status codes</i>.

Status code list (continued)

H1	Problem with paper tray 5. Try reloading the paper. Do not fill above the MAX line. Switch the copier off and then on. You can use another tray for copying. If status code continues, call for service.
H6	Problem in the ADF/DADF. Remove all the originals. Switch the copier off and then on. Reload the originals. You can use the document glass for copying. If status code continues, call for service.
	When the toner cartridge replacement indicator flashes, the toner cartridge will need to be replaced soon. Be sure to have a replacement cartridge in stock.
J1 	Replace the toner cartridge, refer to the appropriate procedure in the section entitled <i>Copier care</i> .
J3	The drum cartridge is not in place. Open the front cover and reinstall the cartridge, refer to the J7,  , procedure in the section entitled <i>Copier care</i> .
	When the drum cartridge replacement indicator appears, the drum cartridge will need to be replaced in approximately 5,000 copies. After the approximate 5,000 copies, the J7 status code will appear and the copier will stop.
J7 	Replace the drum cartridge, refer to the appropriate procedure in the section entitled <i>Copier care</i> .
J8	The wrong drum cartridge was installed. Open the front cover and install the proper cartridge, refer to the J7,  , procedure in the section entitled <i>Copier care</i> . Ensure drum cartridge, 13R555 is installed.
L6	XEROX card or key counter is not loaded. Install the XEROX card or key counter.
U1-U4, U6-U8	Switch the copier off. Wait approximately one (1) minute, then switch the copier on. If the status code continues, call for service.

Clearing the status codes

Refer to the appropriate procedure to clear the displayed status code. If the problem persists, call for service.

A1-A3 (XDL23/XDL33)

A codes appear whenever the ADF has trouble feeding an original.

1. Raise the original catch tray.

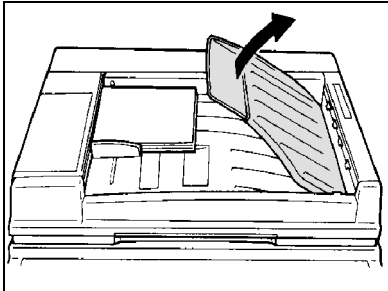

2. Remove the originals from the ADF.

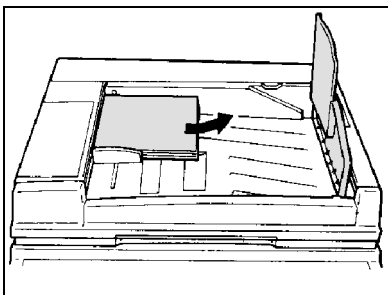

3. Remove any misfed original.

4. Lower the original catch tray.

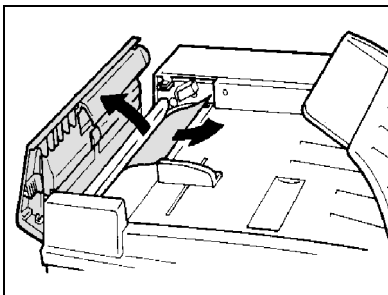

5. Open the left ADF cover.

6. Remove any misfed original.

7. Close the left ADF cover.

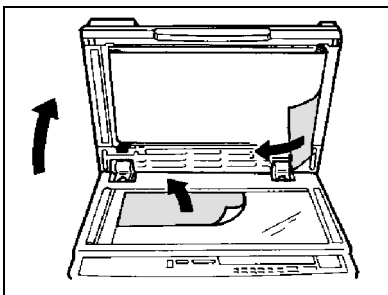

8. Raise the ADF.

9. Remove any misfed original from the document glass or in the ADF.

10. Close the ADF.

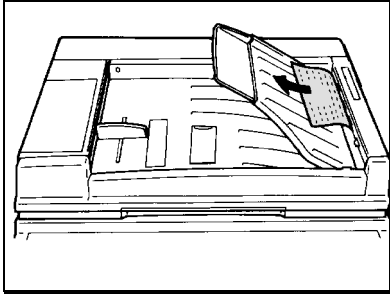

11. Remove any misfed original in the ADF exit area.

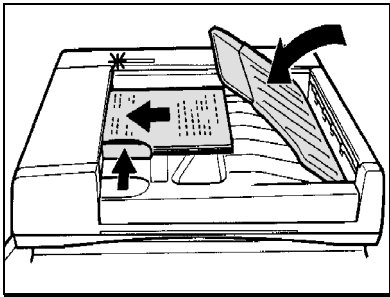

12. Reload the originals.

Note: Do not reload any damaged original in the ADF. Make a new copy of any damaged original.

13. Ensure the ADF guide is touching the edge of the originals.

14. Lower the original catch tray.

15. Ensure the **Ready to copy** lamp on the ADF is lit.

A1-A3 (XDL33D)

A codes appear whenever the DADF has trouble feeding an original.

1. Open the left DADF cover.
2. Remove any misfed original.

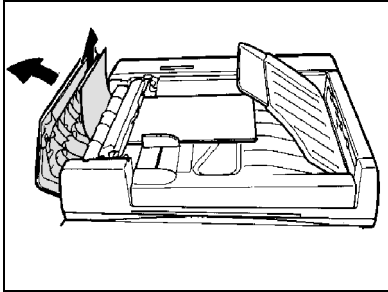

3. Open the left inside cover.

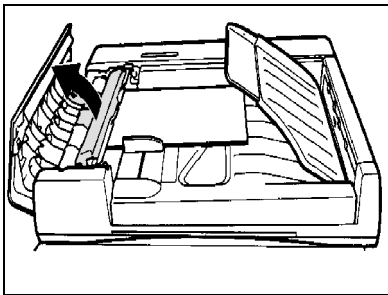

4. Raise the original catch tray.
5. Remove all the originals.
6. Lower the original catch tray.
7. Close the left inside cover.

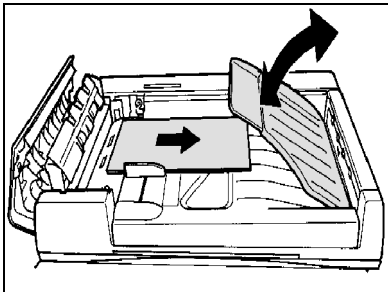

8. Close the left DADF cover.

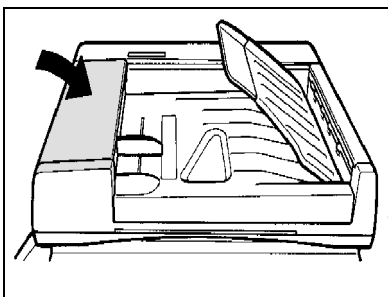

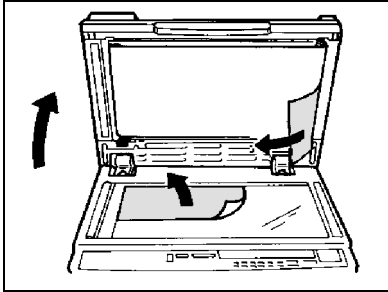

9. Raise the DADF.
10. Remove any misfed original from the document glass or in the DADF.
11. Close the DADF.

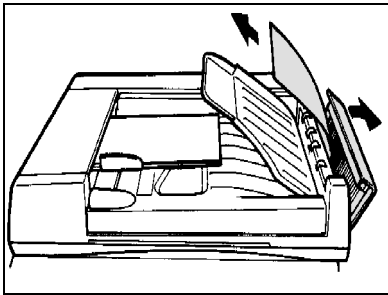

12. Open the right DADF cover.
13. Remove any misfed original in the DADF exit area.
14. Close the right DADF cover.

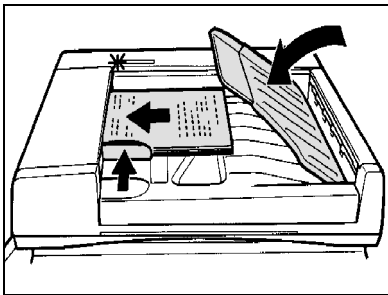

15. Reload the originals.
Note: Do not reload any damaged original in the DADF. Make a new copy of any damaged original.
16. Ensure the DADF guide is touching the edge of the originals.
17. Lower the original catch tray.
18. Ensure the **Ready to copy** lamp on the DADF is lit.

C1-C4, C8

C codes appear whenever the copier has trouble feeding a sheet of paper from a paper tray.

For XDL23/XDL33/XDL33D

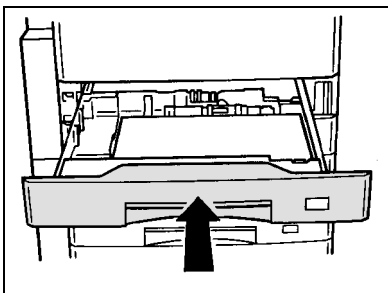
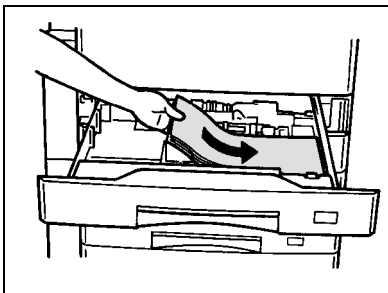
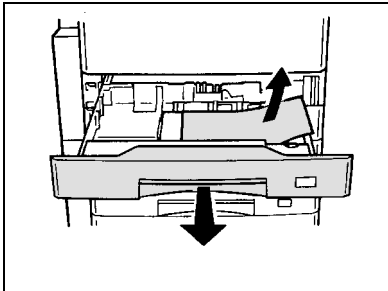
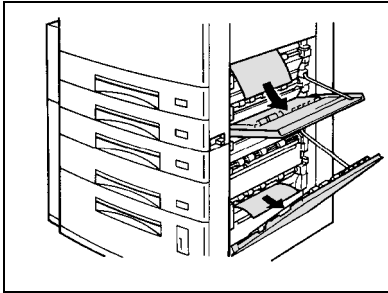

1. If one of the right cover indicators is flashing, open the appropriate cover.

Note: If the paper is not accessible from the right upper cover opening, open the copier front cover and remove the misfed paper.

2. Close any open cover.

3. Open the appropriate tray (refer to the flashing indicator on the copier diagram).

Note: For XDL33D only: If the tray 4 indicator is flashing, perform step 2 (the tray 4 procedure, next page). When completed continue to step 4 on this page.

4. Remove any misfed paper.

5. Reload the paper in the misfed paper tray. This is for trays 1, 2, 3, and 5 only.

6. Ensure the paper is loaded correctly.

7. Close the paper tray.

Note: If status code C3 remains, perform the E1-E3 status code procedure.

For XDL33D only

Note: Perform all steps for the XDL33D copier.

1. If a left cover indicator is flashing, perform the following:

- If the machine is equipped with a sorter, pull back on the sorter release lever and move the sorter to the left until it stops.

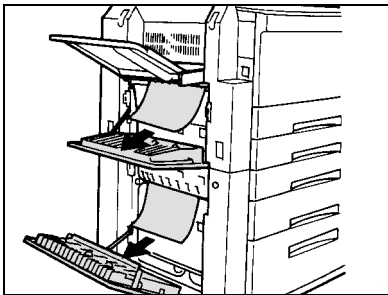
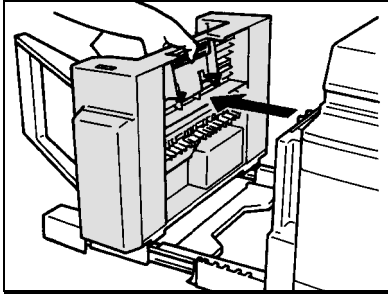

- If needed, open the appropriate left side cover (refer to the flashing indicator on the copier diagram).
- Remove any misfed paper.
- Close any open cover.
- Ensure the sorter is in its original position. Pull back on the sorter release lever and slide the sorter to the original position.

2. If the paper tray 4 indicator is flashing perform the following:

- Open tray 4.

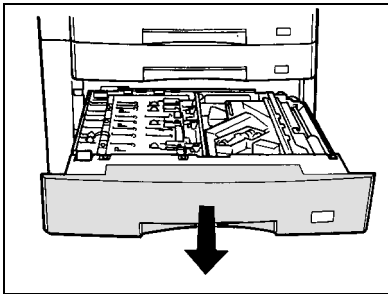

- Open the metal cover (on left side of tray).
- Remove any misfed paper.
- Close the metal cover.

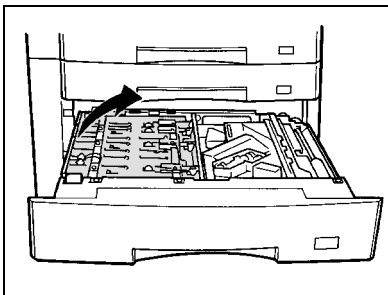

- Open the plastic cover (on right side of tray).
- Remove any misfed paper.
- Close the plastic cover.
- Close tray 4.

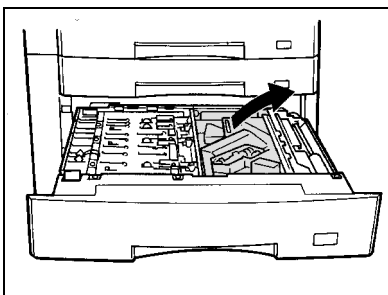

C9

C codes appear whenever the copier has trouble feeding a sheet of paper from the paper tray. The C9 code appears when there is a feeding problem with the bypass tray.

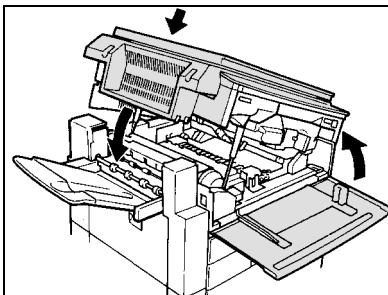
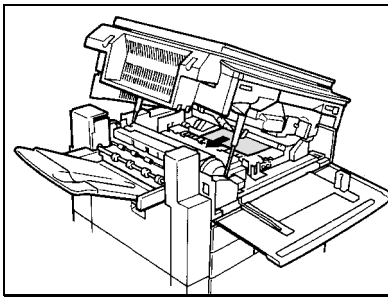
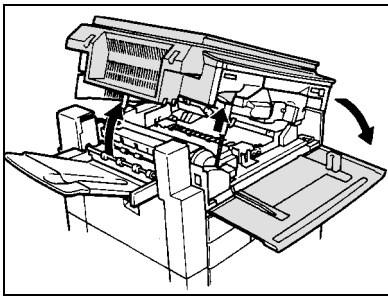
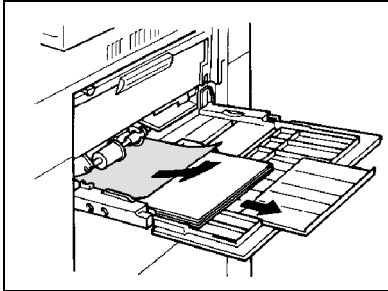

1. Remove any misfed paper in the bypass tray and remove any remaining paper from the tray.
2. Open the copier front cover.
3. Lift up on the copier release lever and open the copier.
4. If there is any misfed paper inside the copier, pull it out toward the copy output device.
5. Close the copier.
6. Close the copier front cover.
7. Reload the copy paper into the bypass tray correctly.

Note: Ensure the copy paper is not above the **MAX** line.

E1-E3

E codes appear whenever the copier has trouble feeding a sheet of paper inside the copier or trouble feeding paper through the copier exit area.

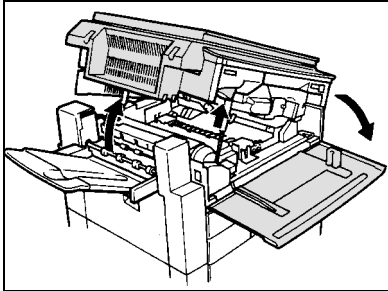

1. Open the copier front cover.
2. Lift up on the copier release lever and open the copier.

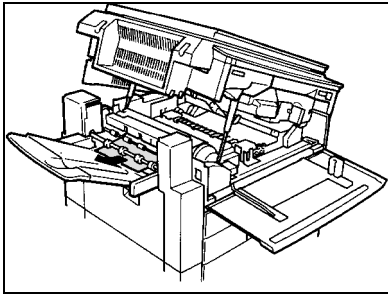

3. If the lead edge of the misfed paper is accessible from the copy output tray, pull the paper out toward the tray.

Caution: The fuser area is extremely hot, allow the machine to cool before removing the misfed paper.

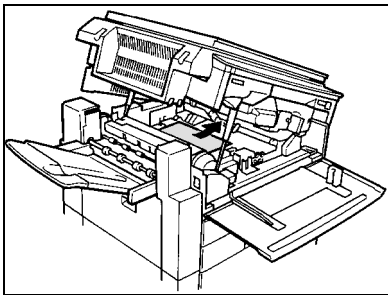

4. If the trail edge of the misfed paper is accessible from the inside, pull it out toward the bypass tray.

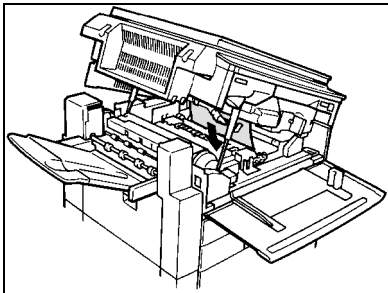

5. If the misfed paper is in the location shown in the figure to the left, pull it out in the direction of the arrow.

Note: To help prevent copy quality problems, never touch the shiny surface of the drum.

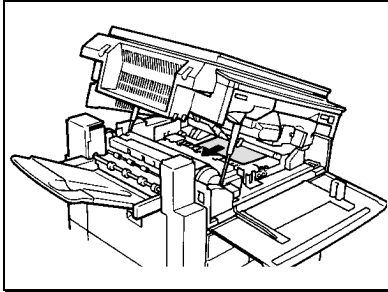

6. If the misfed paper is shown in the figure to the left, pull it out toward the copy output tray.

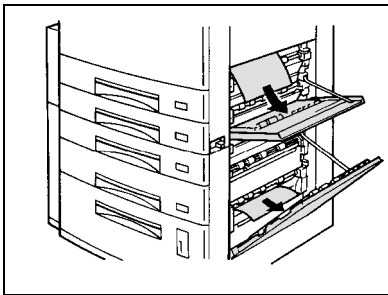

7. Open the copier right upper cover or right lower cover, remove any misfed paper.

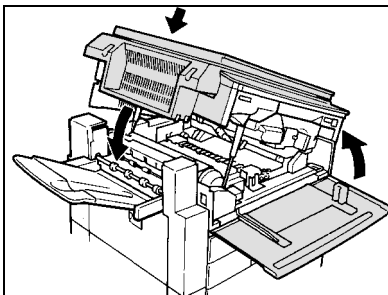

8. Close the copier.
9. Close the copier front cover.

F1

F codes appear whenever the 10-bin sorter stapler has trouble with the stapler or the 10-bin sorter stapler has trouble with feeding paper. The F1 code appears when there is a feeding problem with the 10-bin sorter stapler.

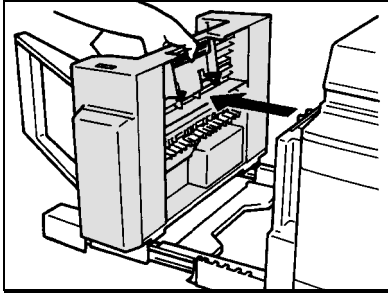

1. Pull back the sorter release lever, then slide the sorter to the left until it stops.

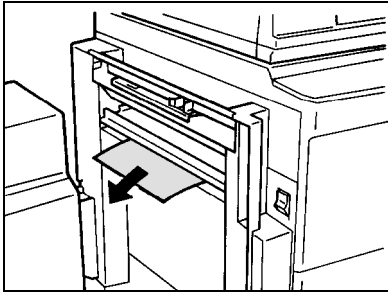

2. Remove any misfed paper in the exit area of the copier.

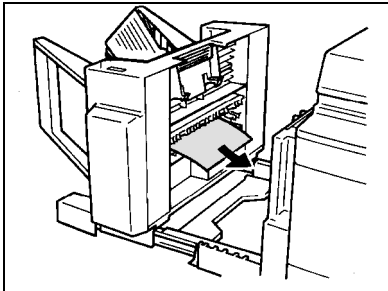

3. Remove any misfed paper in the sorter.

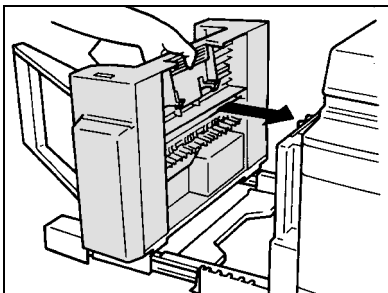

4. Pull back the sorter release lever and slide the sorter to its original position.

F9

F codes appear whenever the 10-bin sorter stapler has trouble with the stapler or trouble with feeding paper. The F9 code appears when there is a problem with the sorter stapler.

1. Remove all paper from the sorter bins.

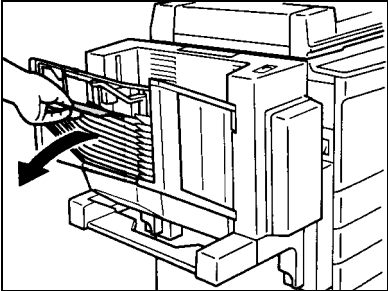

2. Open the sorter stapler cover.

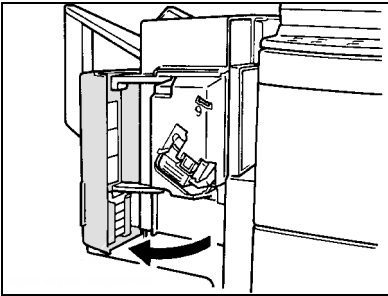

3. Press the stapler release handle to unlock the stapler.

4. Slide the stapler out until it stops.

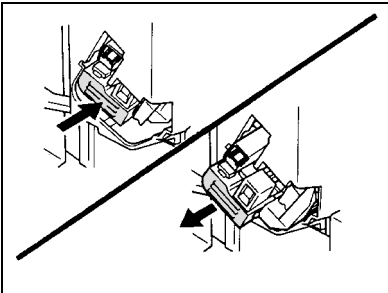

5. Open the upper stapler section and remove any jammed staples.

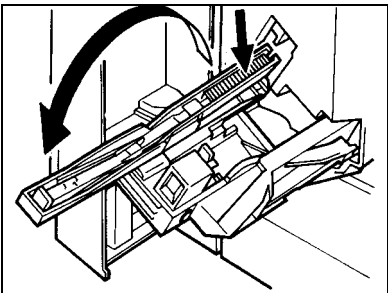

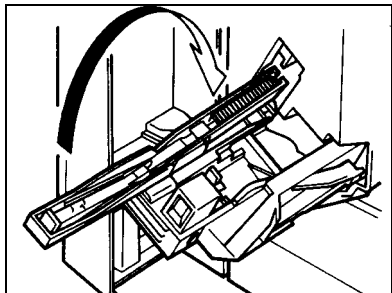

6. Close the upper stapler section.

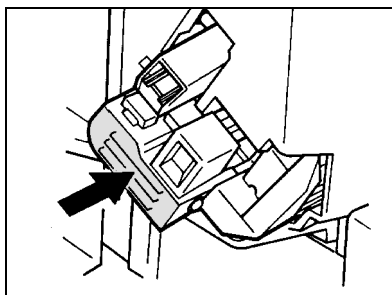

7. Slide the stapler back into the sorter until it clicks. Ensure the stapler is in the correct position.

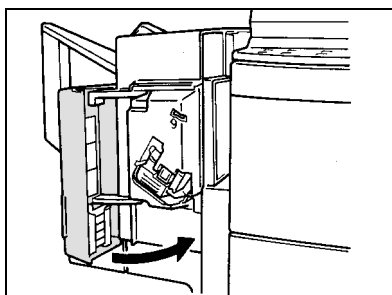

8. Close the sorter stapler cover.

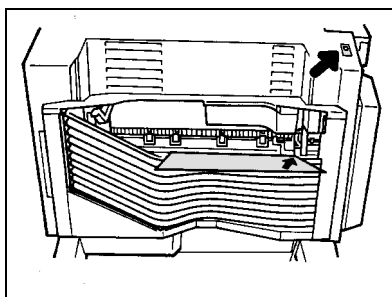

9. Position a sheet of paper along the front edge of the top bin.

10. Press the **Manual stapler** button, , and ensure the paper is stapled properly.

Note: If needed, press the **Manual stapler** button, , repeatedly until the stapler operates.

Calling for service

In the USA and Canada

Should you be unable to resolve a problem after using the Problem solving section of this manual, place a call your local dealer.

- Machine type: **XDL** _____
(on the control panel)
- Machine serial number: _____
(Refer to the rear of the copier for the serial number).
- A description of the problem.
- The status code that is displayed or the problem message (XDL33D), if any.

Relocating the copier

1. If you are relocating the machine ensure the following:
 - Only move the machine to a floor surface of the same level.
 - **Do not** tilt the machine more than 30 degrees from the floor surface.
 - Before moving the machine unlock the four castors and then relock the castors after placing the machine to the new location.

If you need to relocate the machine to a different floor level (example: up the stairs), XEROX recommends that you call your local dealer.

Technical data

Machine

Original size	Maximum 11x17in./A3	
Copy paper size and weight		
Tray 1, 2, 3, 5	5.5x8.5in./A5 to 11x17in./A3	16-24lbs./60- 90gm ²
Bypass tray	5.5x8.5in./A5 to 11x17in./A3	16-32lbs./60- 120gm ²
Paper tray default settings		
Tray 1	8.5x11in./A4 LEF	
Tray 2	8.5x14in./216x355mm SEF	
Tray 3	8.5x17in./A3 SEF	
Tray 5 (available on some models)	8.5x11in./A4 LEF	
Additional paper tray sizes available.	5.5x8.5in. SEF, 5.5x8.5in. LEF, 11x17in. SEF, B4 SEF, B5 LEF, A5 SEF, A5 LEF, A4 SEF, A4 LEF, A3 SEF, *other. *Other for odd-sized paper.	
Copy rate		
XDL23	22/23 CPM (8.5x11in./A4 LEF)	
XDL33	32/33 CPM (8.5x11in./A4 LEF)	
XDL33D	32/33 CPM (8.5x11in./A4 LEF)	
2→2 copying	25/29 CPM (8.5x11in./A4 LEF)	
Copy ratio percentage	1:1±1%	
	Presets:	64%, 77%, 100%, 129%, 154%
	Variable:	61%-163%
Maximum number of copies		
XDL23/XDL33	99 copies	
XDL33D	99 copies for 1→1 and 2→1 copying 30 copies for 1→2 and 2→2 copying	
Paper tray capacity		
Tray 1	250 sheets	
Tray 2	250 sheets	
Tray 3	250 sheets	
Tray 4 (XDL33D only)	30 sheets	
Tray 5	1000 sheets	
Bypass	50 sheets	

Machine (continued)

Warm up time	35 seconds
Electrical requirements	AC 120V \pm 10%, 50/60hz
First copy output time	6.8 seconds for 8.5x11in./A4 LEF from paper tray 1 to the document glass.
Power consumption	1.5kw maximum
Machine dimensions	(W x D x H)
XDL23/XDL33	22.4in.x24.2in.x18.6in./570x615x474mm
XDL33D	25.1in.x24.2in.x18.6in./640x615x474mm
XDL23/XDL33 with ADF	22.4in.x24.2in.x22.0in./570x615x560mm
XDL33D with DADF	25.1in.x24.2in.x26.1in./640x615x664mm
XDL23/XDL33 with ADF and 10-bin sorter stapler	35.5in.x24.2in.x22.0in./903x615x560mm
XDL33D with DADF and 10-bin sorter stapler	38.2in.x24.2in.x26.1in./973x615x664mm
1 tray module (Stand - XDL23/XDL33)	22.4in.x24.2in.x19.6in./570x615x500mm
2 tray module (Stand - XDL23/XDL33)	22.4in.x24.2in.x19.6in./570x615x500mm
Duplex module (Stand - XDL33D)	25.1in.x24.2in.x19.6in./640x615x500mm

Machine (continued)

Machine weight	
XDL23	110.0lbs./50kg
XDL33	114.4lbs./52 kg
XDL33D	123.2lbs./56 kg
XDL23 with ADF	132.0lbs./60kg
XDL33 with ADF	136.4lbs./62kg
XDL33D with DADF	158.4lbs./72kg
XDL23 with ADF and 10-bin sorter stapler	151.8lbs./69kg
XDL33 with ADF and 10-bin sorter stapler	156.2lbs./71kg
XDL33D with DADF and 10-bin sorter stapler	178.2lbs./81kg
1 tray module (Stand - XDL23/XDL33)	48.4lbs./22kg
2 tray module (Stand - XDL23/XDL33)	88.1lbs./40kg
Duplex module (Stand - XDL33D)	118.8lbs./54kg

ADF

Original size	5.5x8.5in./A5 to 11x17in./A3 16-24lb./60-90gm ²
Original capacity	30 sheet maximum
Dimensions	22.4in.x24.2in.x3.4in./570x615x86mm
Weight	22.0lbs./10kg
Power	100 watts or less

DADF (XDL33D only)

Original size	5.5x8.5in./A5 to 11x17in./A3 16-24lb./60-90gm ²
Original capacity	50 sheet maximum
Dimensions	25.1in.x24.2in.x3.4in./640x615x86mm
Weight	35.24lbs./16kg
Power	120 watts or less

10-bin sorter stapler

Top bin sheet capacity	100 sheets of 5.5x8.5in./A5 to 11x17in./A3 16-24lbs./60-90gm ²
staple capacity	15 sheets of 5.5x8.5in./A5 to 10x14in./B4 16-24lbs./60-90gm ² 10 sheets of 11x17in./A3 16-24lbs./60-90gm ²
Bins 2-10 sheet capacity	30 sheets of 5.5x8.5in./A5 to 8.5 x 11in./A4 16-24.0lbs./60-90gm ² 25 sheets of 8.5x14in./216x356mm to 10x14in./B4 16-24.0lbs./60-90gm ² 10 sheets of 11x17in./A3 16-24.0lbs./60-90gm ²
staple capacity	15 sheets of 5.5x8.5in./A5 to 10x14in./B4 16-24.0lbs./60-90gm ² 10 sheets of 11x 7in./A3 16-24.0lbs./60-90gm ²
Dimensions	13.1in.x 22.2in.x14.1in./333x566x358mm
Weight	19.8lbs/9kg
Power	40 watts or less

Xerox 90 Day Limited Warranty

What the Warranty Covers

Xerox warrants that your Xerox copier will be free from defects in materials and workmanship for a period of ninety (90) days from your date of purchase.

This limited warranty applies only to Xerox copiers purchased and used in the United States. This limited warranty is only offered to the first end-user purchaser of the copier and is not transferable to any subsequent purchaser.

What the Warranty Does Not Cover

This limited warranty does not cover copier damage or malfunction from misuse, abuse, accident, act of God, defect in non-Xerox supplies, or non-Xerox alteration, modification or upgrade. Also, this limited warranty does not cover the replacement of dry ink (toner) cartridges or drum (copy) cartridges, or the performance of required user maintenance described in the User Guide provided with your copier, such as preventative or routine maintenance, cleaning the unit and clearing of paper misfeeds.

Repair Is Your Only Remedy

Your only remedy under limited warranty is the repair of your copier as described herein. Xerox will not be liable for any incidental or consequential damages resulting from your use of, or inability to use, your copier even if we know such damages are possible.

No Other Warranty Is Made By Xerox

No other warranty is made by Xerox. Any implied warranty of merchantability is limited to the duration of this limited warranty and thereafter is disclaimed. No other warranty of any kind or type, whether express or implied, will apply after the 90 day limited warranty period. Xerox expressly disclaims any implied warranty of fitness for a particular purpose.

No dealer or reseller is authorized to modify the terms of this limited warranty. Any additional warranty offered by a dealer or reseller is the sole responsibility of the dealer or reseller.

How to Obtain Warranty Repairs

Proof of Purchase

To obtain warranty repair, proof of purchase (your original receipt or Bill of Sale) is required to establish your date of purchase.

If You Have a Problem

The first step is to call the Xerox Authorized Dealer from whom you purchased your copier. Your Xerox Authorized Dealer, if service authorized, is responsible for your satisfaction and equipment repairs for copiers sold in his/her local service authorized territory. If the unit is in an area not serviced by the Xerox Authorized Dealer, then call the Xerox Customer Support Representative at 1-800-TEAM-XRX (1-800-832-6979). Before you call, please be ready to provide the model of your copier, its serial number, date of purchase, and a description of the problem. The Xerox Customer Service Representative will explain how to obtain repair service under this limited warranty.

What You Must Do:

Your copier is designed to perform with a minimum amount of user maintenance. You are, however, responsible for the required user maintenance in the User Guide provided with your copier. This required user maintenance includes the replacement of dry ink (toner) cartridges, drum (copy) cartridges and clearing paper misfeeds, cleaning the unit and other routine and preventative maintenance.

Service After Your 90 Day Warranty Expires

After your 90 day limited warranty expires, you may obtain a Maintenance Agreement from the local Xerox Authorized Dealer from whom you purchased your copier. Alternatively, you may contact Xerox Corporation by calling 1-800-TEAM-XRX (1-800-832-6979). We recommend that you arrange for a Maintenance Agreement 90 days prior to warranty expiration to assure continuous service coverage.

It's illegal

In the USA

It is against US law to copy copyrighted material without permission of the copyright owner unless the copying falls within the "Fair Use" or library reproduction rights of the copyright law. Further information on these U.S. provisions may be obtained from the Copyright Office, Library of Congress, Washington, D.C. 20550, or telephone the Copyright Office at (202) 707-9100 and ask for circular 21. Copying of other items may be prohibited. If you have any questions, seek legal advice.

Xerox Authorized Dealer Total Satisfaction Guarantee

At Xerox, we are committed to the highest quality in the design, manufacturer and service of what we sell. We measure our success by one standard: Total Customer Satisfaction.

Taking this commitment one step further, we now offer this exclusive Xerox Total Satisfaction Guarantee:

If you are not satisfied with your Xerox equipment, at your request, Xerox will replace it without charge to you with an identical model or a machine with comparable features and capabilities.

The term of the Xerox Total Satisfaction Guarantee is three years from purchase date.

This Xerox Total Satisfaction Guarantee applies to Xerox equipment acquired by you from a Xerox Authorized Dealer and continuously maintained by Xerox or its authorized representatives under our manufacturers warranty or a Maintenance Agreement. This guarantee is not applicable to equipment damaged or destroyed due to reasons beyond the control or responsibility of Xerox.

We make this extraordinary offer to clearly demonstrate that at Xerox our measure of quality is our customer's satisfaction.

Material safety data sheet



THE DOCUMENT COMPANY
XEROX

Material Safety Data Sheet

Public

NEPA 	WHS 	DOT
----------	---------	---------

Section 1. Chemical Product and Company Identification									
FOR EMERGENCIES Health: (716) 422-2177 Transportation: (716) 422-1230 In Quebec: 1-800-463-5080	FOR INFORMATION Customer Safety: Tel: 1-800-828-6571 Internet: customer_safety@wb.xerox.com MSDS Webpage: http://www.xerox.com/ehs/msds								
<table border="1" style="width: 100%;"> <tr> <td>MSDS#</td> <td>A-0507</td> </tr> <tr> <td>Eng. Drawg. No.</td> <td>602E33060</td> </tr> <tr> <td>Date</td> <td>1/16/98</td> </tr> <tr> <td>Revision Date</td> <td>4/27/98</td> </tr> </table>		MSDS#	A-0507	Eng. Drawg. No.	602E33060	Date	1/16/98	Revision Date	4/27/98
MSDS#	A-0507								
Eng. Drawg. No.	602E33060								
Date	1/16/98								
Revision Date	4/27/98								
Manufacturer(s)	Trade secret								
Supplier(s)	Xerox Corporation Rochester, NY 14544								
Material Uses	Xerographic imaging media.								
Trade Name(s)	XC23, XC33, XC33D, XDL23, XDL33, XDL33D Black Toner								
Chemical name	None.								
Synonym	None.								
Part No.	Dealer: 6R918 WH: 6R910, 6R913								

Section 2. Composition, Information on Ingredients				
Common Name	CAS #	% by Weight	Exposure Limits PEL/TLV/XEL	LC ₅₀ /LD ₅₀
Styrene/acrylate copolymer	25767-47-9	40-50	Not applicable.	Not applicable.
Iron ferrite	1317-61-9	45-55	Not applicable.	Not applicable.
Polypropylene wax	9003-07-0	2-3	Not applicable.	Not applicable.

Section 3. Hazards Identification	
Acute Health Effects	Non-irritant for skin. Non-sensitizer for skin. Non-irritant for eyes.
Chronic Health Effects	CARCINOGENIC EFFECTS: None present. MUTAGENIC EFFECTS: None detected in Ames assay.
Primary Routes of Entry	Inhalation.
Medical Conditions Aggravated by Overexposure:	None when used as described by product literature.
Signs and Symptoms of Overexposure:	Minimal respiratory tract irritation may occur as with exposure to large amounts of any non-toxic dust.

Continued on Next Page

A-0607

Page Number: 2

Section 4. First Aid Measures

Eye Contact	Rinse with water for a few minutes.
Skin Contact	Wash with soap and water.
Inhalation	Remove from exposure.
Ingestion	Dilute stomach contents with several glasses of milk or water.

Section 5. Fire and Explosion Data

Flammability	Combustible.
Auto-Ignition Temperature	Not applicable.
Flash Point	Not applicable.
Flammable Limits	Not applicable.
Products of Combustion	Products of combustion may be toxic. Avoid breathing smoke.
Fire Hazards	None.
Explosion Hazards	Toner is a combustible powder. Like most organic materials in powder form, it can form explosive mixtures when dispersed in air.
Fire Fighting Media and Instructions	Use DRY chemicals, CO2, water spray or foam. Avoid inhalation of smoke. Wear protective clothing and self-contained breathing apparatus.
Special Remarks on Fire Hazards	No additional remarks.
Special Remarks on Explosion Hazards	No additional remarks.

Section 6. Accidental Release Measures

Spill or Leakage	Sweep up or vacuum spilled toner and carefully transfer into sealable waste container. Sweep slowly to minimize generation of dust during clean-up. If a vacuum is used, the motor must be rated as dust tight. A conductive hose bonded to the machine should be used to reduce static build-up. Residue can be removed with soap and cold water. Garments may be washed or dry cleaned after removal of loose toner.
-------------------------	--

Section 7. Handling and Storage

Handling	Avoid prolonged inhalation of excessive dust. Use with adequate ventilation.
Storage	Keep container tightly closed.

Section 8. Exposure Controls/Personal Protection

Engineering Controls	Use process enclosures, local exhaust ventilation, or other engineering controls to keep airborne levels below recommended exposure limits. If user operations generate dust, fume or mist, use ventilation to keep exposure to airborne contaminants below the exposure limit.
Personal Protection Equipment	None required when used as intended in Xerox equipment. For use such as in bulk toner processing facilities, goggles, gloves, and respirators may be required. For more information contact Xerox Safety.
Final Product Exposure Limits PEL/TLV/XEL	ACGIH (TLV-TWA): 10 (mg/m ³) Total. OSHA (PEL-TWA): 15 (mg/m ³) Total. OSHA (PEL-TWA): 5 (mg/m ³) Respirable. Xerox (XEL-TWA): 2.5 (mg/m ³) Total. Xerox (XEL-TWA): 0.4 (mg/m ³) Respirable. Reported values are for particulates not otherwise classified (PNOC). XEL - Xerox exposure limit.

Continued on Next Page

A-0607

Page Number: 3

Section 9. Physical and Chemical Properties

Physical state and appearance	Solid. (Powder)	Color	Black
pH	Not applicable.	% Volatile	60-170 ppb
Boiling Point	Not applicable.	VOC	Not applicable.
Melting Point	Not applicable.	Evaporation rate	Not applicable.
Specific Gravity	~1	Viscosity	Not applicable.
Vapor Pressure	Not applicable.	Solubility in water	Insoluble in water.
Vapor Density	Not applicable.	Odor	Slight.
Softening Range	43.3 - 60 °C (110 - 140 °F)	Other	Not applicable.



Section 10. Stability and Reactivity Data

Chemical Stability	This product is stable.
Incompatibility with various substances	None known.
Hazardous Decomposition Products	Not available.
Hazardous Polymerization	Will not occur.

Section 11. Toxicological Information

Acute Effects	
Eye Irritant	Non-irritating to the eyes.
Skin Sensitizer	Non-sensitizer for skin.
Skin Irritant	Non-irritant for skin.
Human Skin Patch	Non-irritating, non-sensitizing
	Oral (LD50): >5000 mg/kg [Rats]. Dermal(LD50): >5000 mg/kg [Rabbits]. Inhalation (LC50): >5 mg/l (Rats) 4hr. Inhalation (LC50): >20 mg/l (Rats) 1hr. calculated
Chronic Effects	CARCINOGENIC EFFECTS: None. MUTAGENIC EFFECTS: None detected in Ames assay.
Additional Information	<p>The results obtained from a Xerox sponsored Chronic Toner Inhalation Study, demonstrated no lung change in rats for the lowest (1 mg/m³) exposure level (i.e. the level most relevant to potential human exposure). A very slight degree of fibrosis was noted in 25% of the animals at the middle (4 mg/m³) exposure level, while a slight degree of fibrosis was noted in all the animals at the highest (16 mg/m³) exposure level. These findings are attributed to "lung overloading", a generic response to excessive amounts of any dust retained in the lungs for a prolonged period. This study was conducted using a special test toner to comply with EPA testing protocol. The test toner was ten times more respirable than commercially available Xerox toner, and would not be functionally suitable for Xerox equipment.</p>
Special Remarks	This material has been evaluated by Xerox Corporation. The toxicity data listed in this section is based on the test results of similar xerographic toners.
Toxic Effects in Humans	No human data available.

Continued on Next Page

A-0607		Page Number: 4								
Section 12. Ecological Information										
Ecotoxicity	Aquatic (LC50): >1125 mg/l (rainbow trout) 96 hr.									
BOD and COD	Not available.									
Products of Biodegradation	Not available.									
Bioaccumulation	Not available.									
Toxicity of the Products of Biodegradation	Not available.									
Special Remarks on the Products of Biodegradation	No additional remark.									
Section 13. Disposal Considerations										
Waste information	This material is not a hazardous waste according to Federal Regulation 40 CFR 261 when disposed. Consult with the appropriate state and local waste authorities for additional information. Incinerate only in close container.									
Waste stream	Not available.									
Section 14. Transport Information										
USA/DOT										
Proper Shipping Name	Not applicable.									
Hazard Class	Not regulated.									
DOT Identification Number	Not applicable.									
Packing Group	Not applicable.									
Canada/TDG										
PIN number	Not applicable.									
TDG Classification	Not controlled under TDG (Canada).									
IMO/IMDG Classification	Not controlled under IMDG.									
IATA Classification	Not controlled under IATA.									
Section 15. Regulatory Information										
US Federal and State Regulations	TSCA inventory: All ingredients are listed									
WHMIS (Canada)	Not controlled under WHMIS (Canada).									
Canadian Federal and Provincial Regulations	No products were found.									
Section 16. Other Information										
HMIS (U.S.A.)	<table border="1"> <tr><td>Health Hazard</td><td>0</td></tr> <tr><td>Fire Hazard</td><td>3</td></tr> <tr><td>Reactivity</td><td>0</td></tr> <tr><td>Personal Protection</td><td>3</td></tr> </table>	Health Hazard	0	Fire Hazard	3	Reactivity	0	Personal Protection	3	National Fire Protection Association (U.S.A.) 704
Health Hazard	0									
Fire Hazard	3									
Reactivity	0									
Personal Protection	3									
		 <p>Health: 0, Fire Hazard: 3, Reactivity: 0, Specific Hazard: 0</p>								
Special Remarks	No additional remark.									
Notice to Reader										
<i>This product has been classified in accordance with OSHA and the hazard criteria of the CPR. The MSDS contains all the information required by OSHA and the CPR. Preparation of this document was completed by Xerox Corporation, Environment, Health and Safety.</i>										

This MSDS may not be the latest version. To obtain the latest version you may call 1-800-828-6571, or visit their Web site at: <http://ids.xbs.xerox.com/ehs/msds/>

Xerox Corporation
800 Phillips Road
Bldg. 845-17S
Webster, NY 14580-9791

701P98019

5/98

Free Manuals Download Website

<http://myh66.com>

<http://usermanuals.us>

<http://www.somanuals.com>

<http://www.4manuals.cc>

<http://www.manual-lib.com>

<http://www.404manual.com>

<http://www.luxmanual.com>

<http://aubethermostatmanual.com>

Golf course search by state

<http://golfingnear.com>

Email search by domain

<http://emailbydomain.com>

Auto manuals search

<http://auto.somanuals.com>

TV manuals search

<http://tv.somanuals.com>