

UDW10055 Video Surveillance System

User's Manual

What's in the Box



Portable receiver with a
3-1/2-inch color LCD display



UWDC25 wireless
weatherproof camera (2)

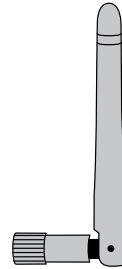

Antenna (2)

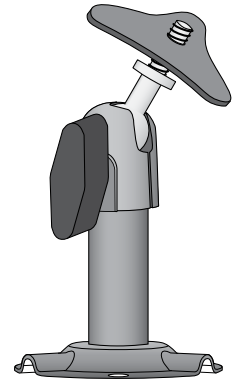

Camera stand (2)



AC adapter -
Receiver (1)



AC Adapters -
Cameras (2)



Software CD



AV cables



USB cable

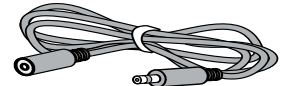

Extension cord (2)

***If any items are missing or damaged, contact our Customer Care Line immediately.
Never use damaged products!***

Need Help? Get answers 24/7 at our website: www.uniden.com.

If You...	Contact Uniden's...	Phone Number
have a question or problem	Customer Care Line*	817-858-2929 or 800-297-1023
need a replacement part or accessory	Parts Department*	800-554-3988
need special help due to a disability	Accessibility Help Line	800-874-9314 (voice or TTY)

* During regular business hours, Central Standard Time. Visit our website for detailed business hours.

Important Safety Instructions!

This manual contains important information about this product's operation. If you are installing this product for others, you must leave this manual or a copy with the end user.

When using your equipment, always follow basic safety precautions to reduce the risk of fire, electric shock and injury to persons, including the following:

- ▶ This equipment is NOT waterproof. DO NOT expose it directly to rain or moisture.
- ▶ DO NOT immerse any part of the product in water. Do not use this product near water, e.g., near a bath tub, wash bowl, kitchen sink or laundry tub, in a wet basement or near a swimming pool.
- ▶ To avoid any risk of electric shock from lightning, avoid handling any electronic devices (except battery powered ones) during an electrical storm.
- ▶ Use only the power cord provided with this equipment. Never dispose of this equipment in a fire; it may explode. Check with local codes for possible special disposal instructions for electronics and batteries.
- ▶ Never tug or pull on any power cord; be sure to leave some slack in the cord when placing your equipment, and always use the plug to unplug cord from the wall outlet.
- ▶ Never leave power cords where they can become crushed, cut, or frayed; when running power cords, avoid letting them rub against any sharp edges or lie across any high traffic areas where people might trip over them.
- ▶ Do not use the device if the adapter cords or plugs have been damaged, the unit has been exposed to liquids, or the unit has been dropped or is damaged.

Warnings to Parents and Other Users

Failure to follow these warnings and the assembly instructions could result in serious injury or death. This product is not designed or intended for use as a medical monitor, nor should this product be used as a substitution for medical or parental supervision. Always be sure that both the transmitter and receiver are working properly and are within range of each other.

- ▶ STRANGULATION HAZARD. Keep the adapter cords out of the reach of children.
- ▶ WARNING: KEEP OUT OF THE REACH OF CHILDREN. This product is not a toy and is not intended for use by any children under the age of 13. If you are between the ages of 13 and 18, review these terms, conditions and safety warnings with your parents or guardian to make sure that you and your parent or guardian understand these terms, conditions, and safety warnings.
- ▶ Allow for proper ventilation when units are in use. Do not cover the camera or receiver with any object such as a blanket. Do not place it in a drawer or in any location which would muffle the sound or interfere with the normal flow of air.

SAVE THESE INSTRUCTIONS!

For best results:

To avoid damage to your equipment, follow these simple precautions:

- ▶ Do not drop, puncture or disassemble any part of the equipment. There are no user-serviceable parts inside.
- ▶ Do not expose the equipment to high temperatures, and avoid leaving the equipment in direct sunlight for more than a few minutes. Heat can damage the case or electrical parts.
- ▶ Do not place heavy items on top of the equipment or expose the equipment to heavy pressure.
- ▶ Remove the power adapter during long periods between usages.
- ▶ Clean only with a dry cloth.

Failure to follow the instructions in this operating manual will void the warranty. Uniden assumes no liability for damages to property or injury to persons caused by improper handling or failure to comply with these safety instructions.

Contents

Important Safety Instructions!	2	Using Zoom Mode	12	Resetting Your System	21
Warnings to Parents and Other Users	2	Pan and tilt in zoom mode.....	12	Additional Information	22
For best results:	3	Understanding Night Vision.....	12	Product Specifications.....	22
Getting Started	4	Connecting to Your TV	13	Lithium-Polymer Battery Warning	23
Connect the Power	4	Reducing pixellation	13	Recycling and Disposal Information.....	23
Check the Video Signal	5	Multiple Camera Features.....	14	FCC Compliance Information	23
Learning Your System	6	Pairing Cameras.....	14	Part 15 Compliance Statement	23
Get to Know the Camera	6	Some things to know about pairing cameras:.....	14	RF Exposure Information	24
What the lights mean.....	6	Changing to a Different Camera.....	15	IC Compliance Information.....	24
Using the Camera Stand.....	6	Setting Up a Scan	16	Radio Equipment Notice.....	24
Switch the bracket	7	Using Quad Display	17	CE Compliance Information.....	24
Mount the stand	7	To enter quad display	17	One-year Limited Warranty	24
Attach the camera.....	8	To exit quad display	17		
Adjusting the Sun Shield	8	Solving Problems.....	18		
Get to Know the Receiver.....	9	Unstable or Weak Signal.....	19		
What the buttons do.....	9	Weak signal and video performance.....	19		
What the lights mean.....	10	Noise or Static.....	20		
What the connections do	10				
Using the Menu.....	11				

Getting Started

Connect the Power

1. Connect the standard AC adapter to the receiver's power input.

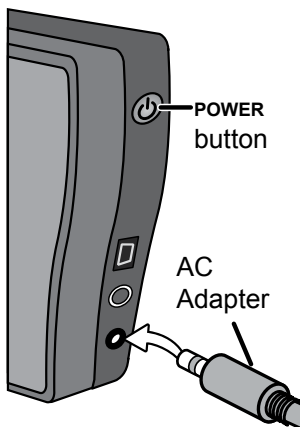

2. Attach an antenna to the rear of each camera and connect an AC adapter to the camera's power input pigtail. (If necessary, connect the extension cord to the camera's pigtail and connect the AC adapter to the extension cord.)

3. Connect the other end of each adapter to a 120 volt AC (standard indoor) power outlet, and press the **POWER** button on the side of the receiver.

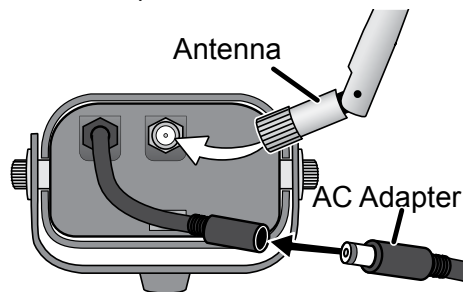

4. Make sure the *Power status* lights on the front of the receiver and each camera all turn on.

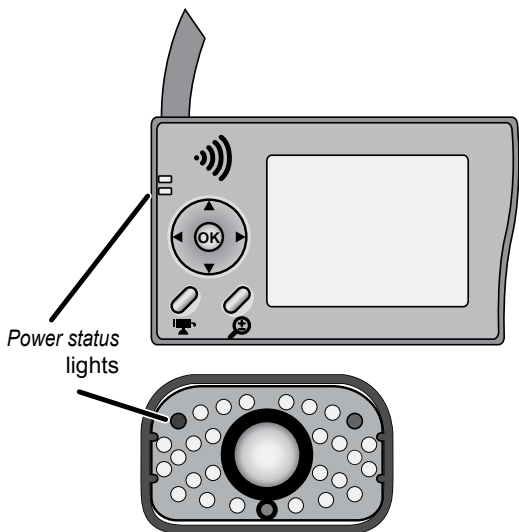

If...	Try...
a <i>Power status</i> light doesn't come on	- reconnecting the AC adapter - seeing if the power outlet is controlled by a wall switch

Check the Video Signal

As soon as the receiver powers on, it detects the camera and shows the video on the display. The icons at the top of the screen tell you what's going on with the camera and receiver.

The table below shows the different status icons and what they mean. Since the icons appear based on the state of the camera and receiver, you won't see all of these icons at the same time.

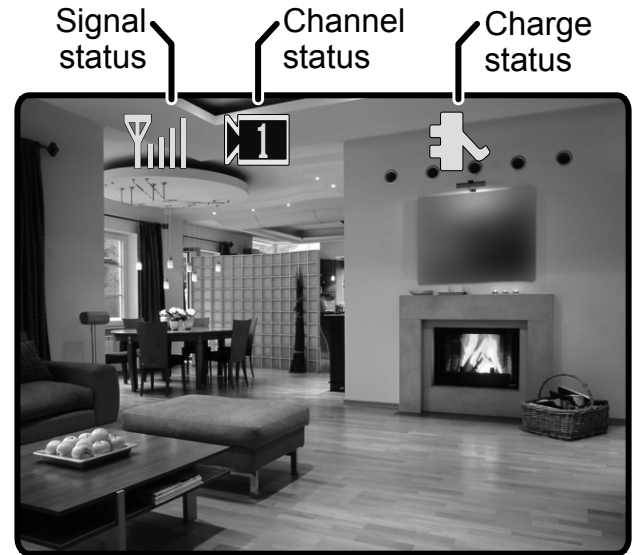

Icon	What it means
	The signal from the camera is 1-low, 2-fair, 3-good, or 4-strong.
	There is no signal from the camera.
	The video currently on the display comes from the camera connected to channel 1, 2, 3, or 4.
	The video is currently zoomed in.

If...	Try...
the signal status icon shows no bars or the display says <i>No Signal</i>	- making sure the camera is turned on. - re-pairing the camera and receiver (see page 14).
the signal status icon shows one or two bars or the video quality is poor	seeing page 19 for tips on improving video quality.
there is a lot of static on the receiver	seeing page 20 for tips on avoiding interference.

Learning Your System

Get to Know the Camera

Front view

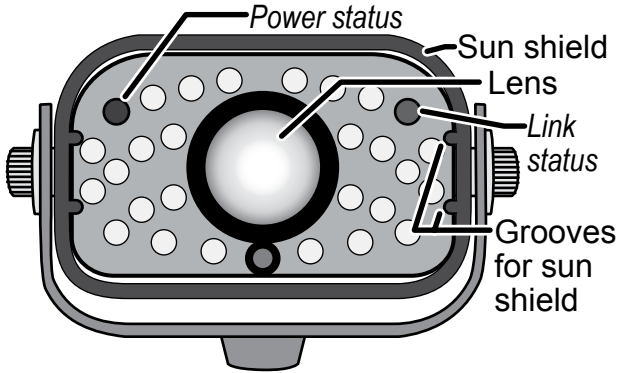

Back view

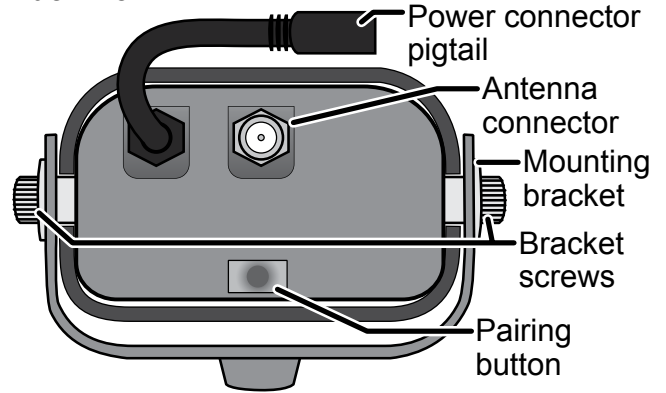

What the lights mean

Light	State	What it means
Power status	On	The camera is on.
	Off	The camera is off.
Link status	Flashing	The camera is in pairing mode.
	Green	The camera is connected to the receiver.
	Off	The camera is in standby.

Using the Camera Stand

You can mount the camera with the stand on the bottom (on a wall or table-top) or on the top (on the ceiling).

When you are positioning the camera, you might want to bring the receiver along; it's much easier to get the camera into the right position when you have the display handy.

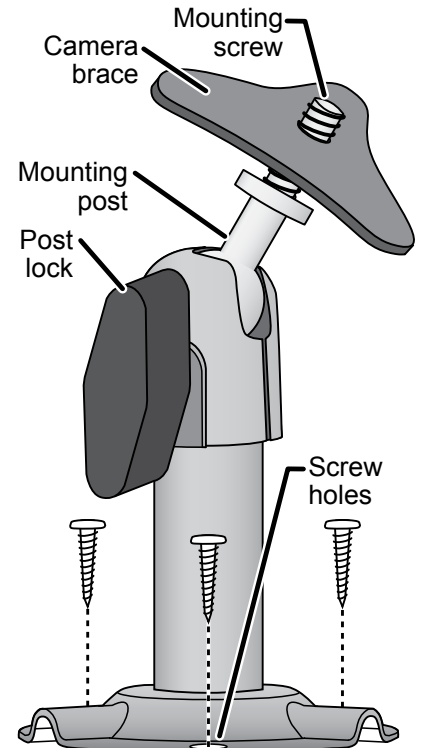

Switch the bracket

If you want to mount the camera in a hanging position, you'll need to flip the bracket to the top of the camera:

1. Remove the bolts on the side of the mounting bracket.
2. Carefully slide the bracket off of the camera and sun shield.
3. Rotate the bracket 180° and slide it back onto the camera.
4. If necessary, adjust the camera angle, then replace and tighten the bolts.

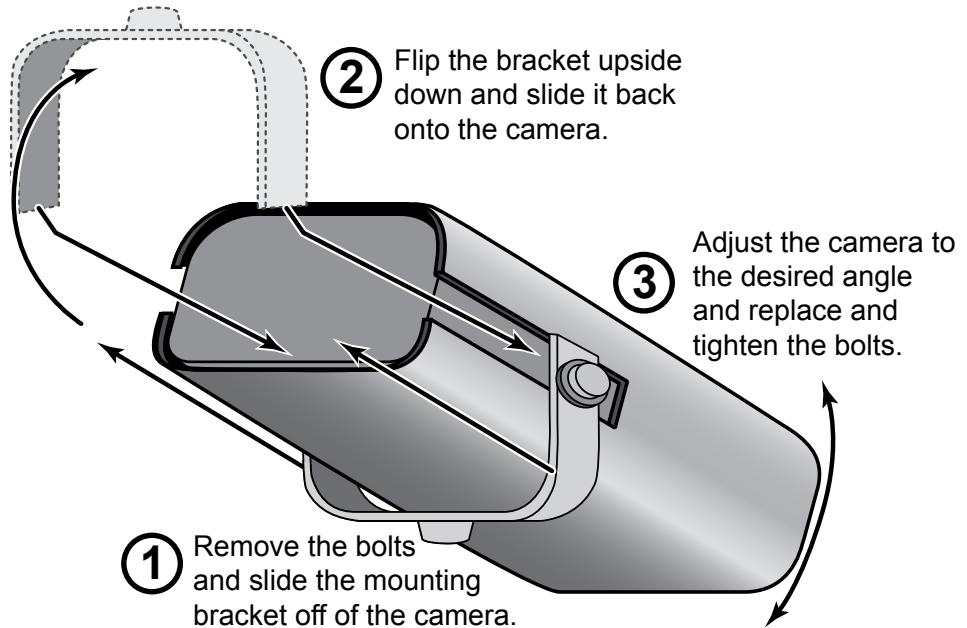

Mount the stand

1. Hold the base of the camera stand where you want to mount it, and mark the location of the screw holes.
2. Use the included screws and anchors to attach the base to the wall or ceiling.
3. Before attaching the camera, tug gently on the stand to make sure it is securely in place.

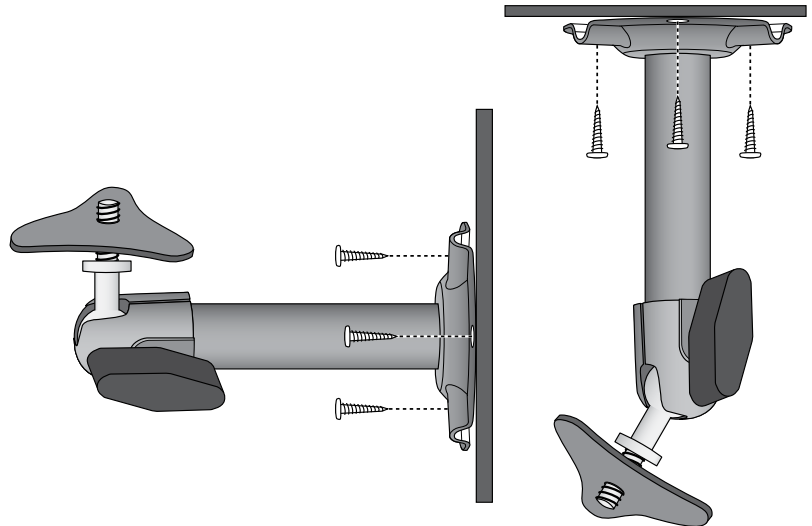

Attach the camera

1. Attach the camera bracket to the mounting screw. Tighten it a few turns, then turn the camera to face the direction you want.

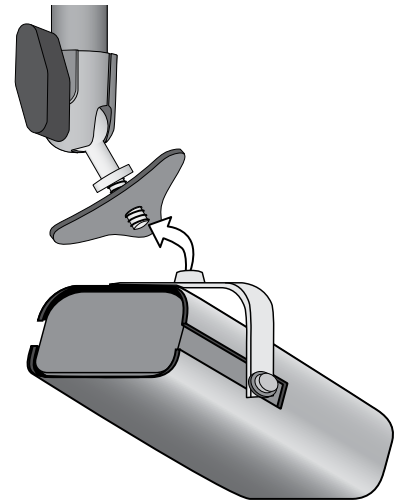
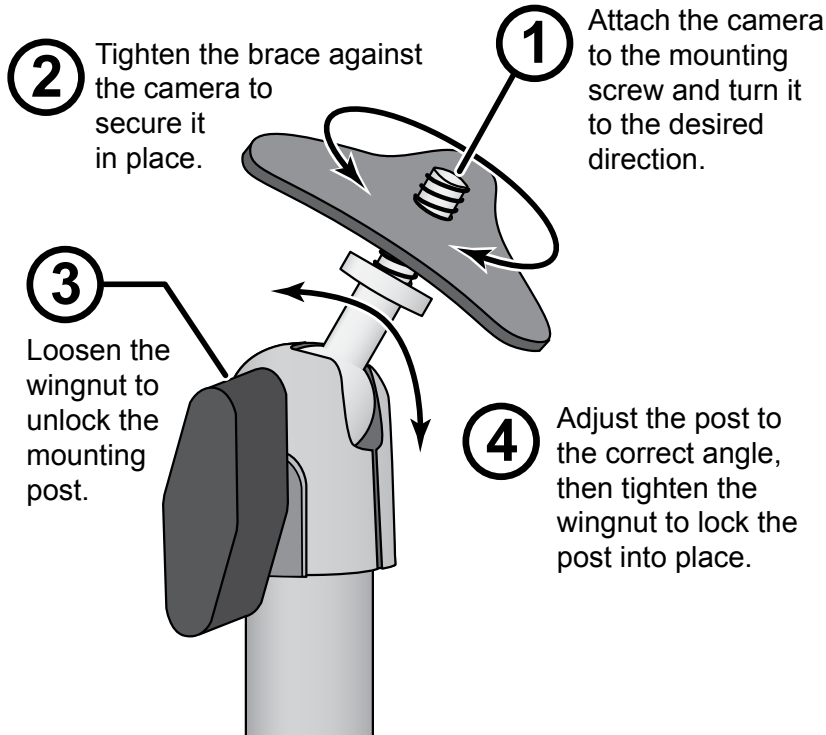

2. Tighten the camera brace up against the bracket to secure it into place.
3. Unlock the mounting post by turning the wingnut to the left a few turns.
4. Set the mounting post to the correct angle, then tighten the wingnut until the post is locked into place.

Adjusting the Sun Shield

If there is too much glare in the camera, you can move the sun shield forward to provide more shade for the lens. If the top of the picture is cut off, try moving the sun shield back.

To adjust the sun shield, loosen the bolts on the side of the mounting bracket (see page 7). Slide the sun shield forward or back, then check the picture in the receiver display. When the picture is satisfactory, tighten the bolts again.

Get to Know the Receiver

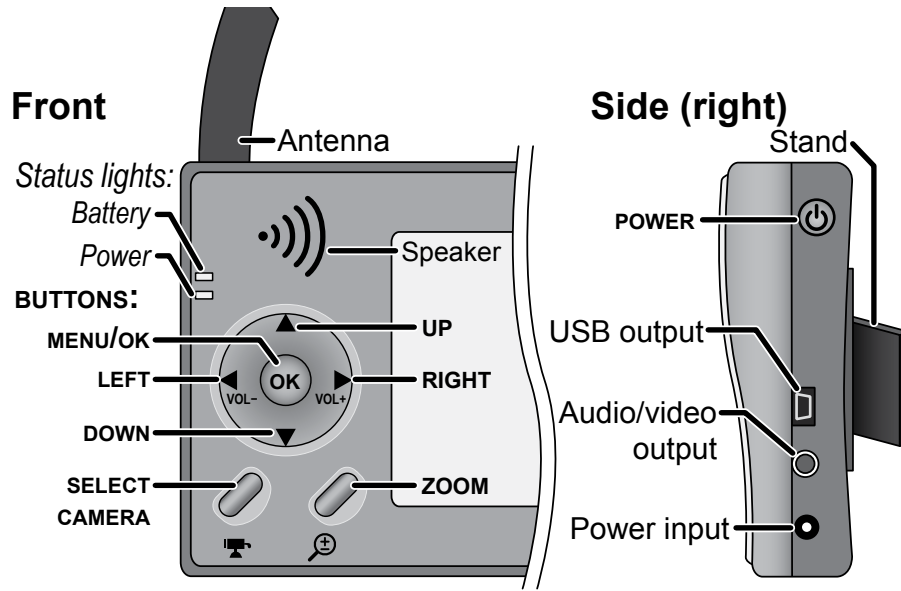

What the buttons do

Button	What it does
MENU/OK	- Open and close the menu
LEFT	- Decrease volume. - In zoom mode: pan to the left side of the zoom area. - In the menu: cycle through the available options for the selected menu item. - In quad display: go to channel 4.
RIGHT	- Increase volume. - In zoom mode: pan to the right side of the zoom area. - In the menu: cycle through the available options for the selected menu item. - In quad display: go to channel 3.
UP	- In zoom mode: pan to the top of the zoom area. - In the menu: move the cursor up one line. - In quad display: go to channel 1.

Button	What it does
DOWN	- In zoom mode: pan to the bottom of the zoom area. - In the menu: move the cursor down one line. - In quad display: go to channel 2.
SELECT CAMERA	- Cycle through the active cameras. - From the pairing menu: link to the selected camera.
ZOOM	- Enter and exit zoom mode.
POWER	- Turn the receiver on. Press and hold to turn it off.

What the lights mean

Light	State	What it means
<i>Power status</i>	On	The receiver is on.
	Off	The receiver is off.
<i>Battery status</i>	Flashing	The receiver is in pairing mode.
	Green	The battery is charging.
	Red	The battery is low; the receiver will turn off in 3 minutes.
	Off	The battery is fully charged.

What the connections do

Connector	Use it to
USB output	Connect the receiver to your computer for use with the Uniden Surveillance System Software. (See the software manual for more information.)
Audio/video output	Send the signal from the camera to a standard TV (see page 13).

Using the Menu

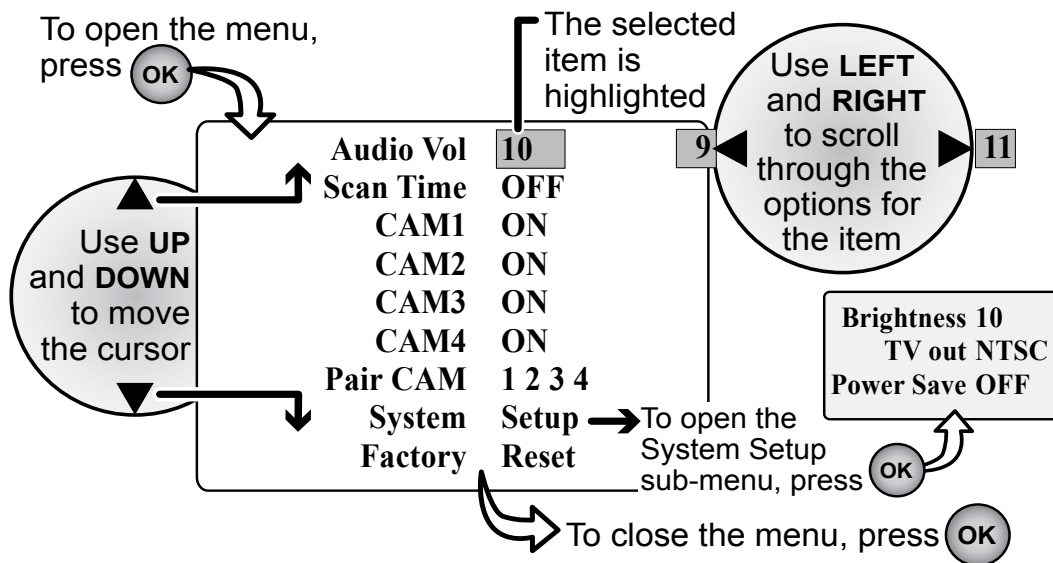

Item	Use it to
<i>Audio Vol</i>	Adjust the volume of the audio from the camera. Choose a value from 0 (off) through 20 (maximum).
<i>Scan Time</i>	Set the length of time the receiver spends on each active camera during a scan (see page 16) or activate quad display (see page 17).
<i>CAM1 – CAM4</i>	Turn each of the four camera channels <i>On</i> (enabled) or <i>Off</i> (disabled).
<i>Pair CAM</i>	Pair a camera to the selected channel (see page 14).
<i>System Setup sub-menu</i>	
<i>Brightness</i>	Adjust the brightness of the display. Choose a value from 1 (min) through 15 (max).
<i>TV out</i>	Change the video output format from <i>NTSC</i> (North America) to <i>PAL</i> (Europe).
<i>Power Save</i>	Turn on power save mode. If you set this field to <i>Auto</i> , the display turns off if it's idle for more than one minute. (The audio will remain active.) To turn the display back on, press OK .
<i>Factory Reset</i>	Reset the receiver to factory defaults. Any changes or settings will be lost.

Using Zoom Mode

The receiver can zoom in so you can see the video better. In zoom mode, the receiver increases the pixel size and focuses on the center of the picture. You will also see the **ZOOM** icon in the upper right corner of the display.

Normal view



Zoomed-in view



Pan and tilt in zoom mode

Once in zoom mode, you can pan and tilt the camera to see the outside edges of the zoomed in area. Use the arrow buttons to pan right and left or tilt up and down.

Pan and tilt features are only available in zoom mode.

Understanding Night Vision

The weatherproof cameras included with your receiver have 24 infrared LEDs for low-light conditions.

- ▶ The infrared LED automatically turns on when the ambient light gets too dim (around twilight); the LED provides enough light for the camera to capture clear images in deep twilight or under a very bright full moon. (See page 23 for lux specifications.)
- ▶ For the best night vision results, place the camera no closer than about 10 feet (3 meters) and no further than about 30 feet (9 meters) from the point you want to monitor.

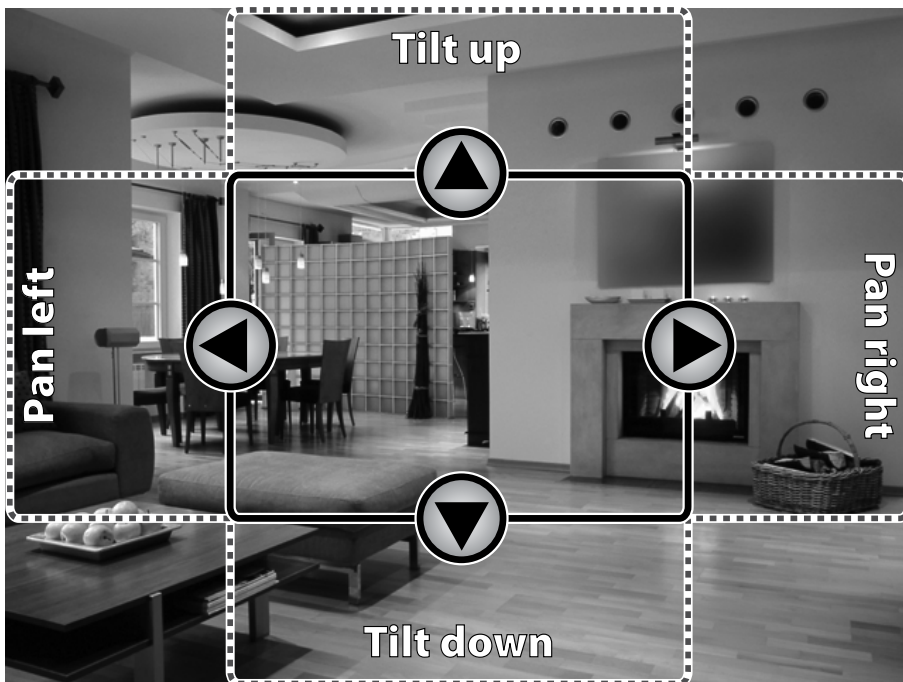

Connecting to Your TV

You can connect the receiver to any standard television with RCA composite video inputs.

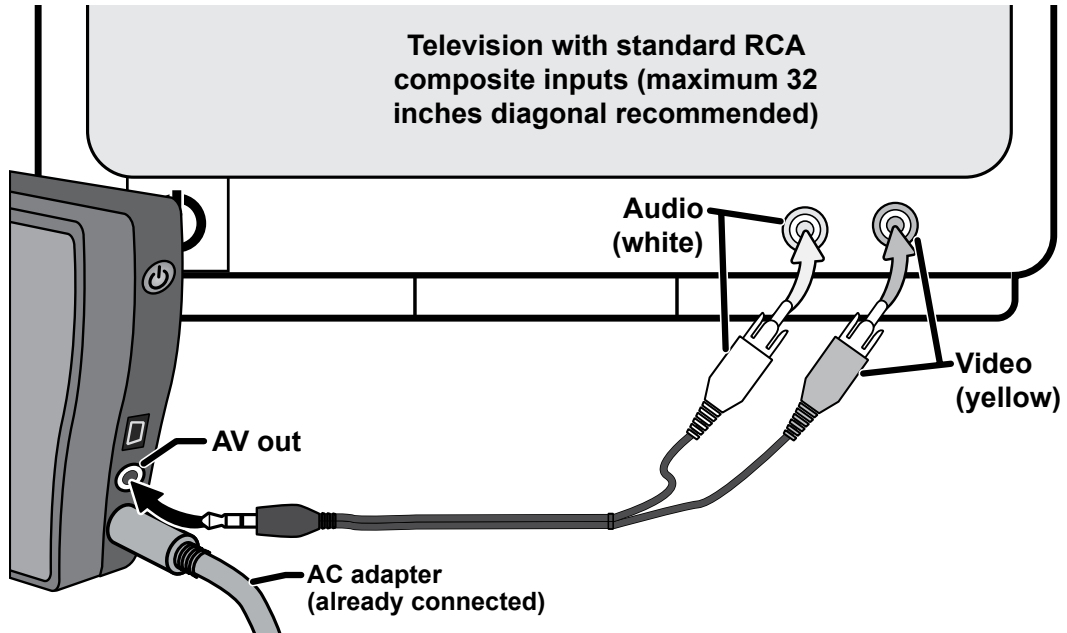

To use bandwidth efficiently, the system compresses the video signal using Motion-JPEG; the system then digitizes the signal before transmitting it to provide a secure video link. This method is optimized for wireless connections, but it can cause an indented image line ("ghosting" or JPEG artifacts) on larger television displays or plasma screens.

Reducing pixellation

When video is put on a very large screen, you can often see the edges of each pixel in the image. There are a few ways to reduce the amount of pixellation on your TV:



- ▶ Zoom out on the receiver: at the zoomed in size, some pixellation will always occur.
- ▶ Don't use a television larger than 32 inches (32-inch diagonal display).
- ▶ Don't use a "stretch" or "zoom" setting on your television; set your television to display the image as it receives it from the system.

Multiple Camera Features

Your receiver supports a total of four active cameras at a time. You can mix and match any of the accessory cameras. (See our website for compatible camera options.)

Pairing Cameras

Pairing is like introducing the camera and the receiver so they can communicate. You'll perform the pairing procedure if you want to add a new camera to your system or if you are having trouble with a camera.

1. Make sure the camera is powered on.
2. On the receiver, open the menu and scroll down to *Pair CAM*.
3. Use **RIGHT** or **LEFT** to highlight the channel you want to use for this camera.
4. Press . The receiver goes into pairing mode for 60 seconds.
5. On the back of the camera, press **PAIRING KEY** to put it into pairing mode, also. The position of this button varies from camera to camera; see the manual that came with your camera.
6. On the receiver, open the menu.
7. Scroll down to *CAM1* through *CAM4* and select the channel assigned to the new camera.
8. Use **RIGHT** or **LEFT** to enable the channel (set it to *On*).
9. Press  to cycle through the channels, and verify that the video signal from the new camera appears on the correct channel.

Some things to know about pairing cameras:

- ▶ As soon as the receiver detects a camera in pairing mode, it links to that camera and assigns it to the selected channel.
- ▶ If a camera is already assigned to the selected channel, the receiver overwrites that camera link with the new one.
- ▶ Make sure you enable the channel after you pair the camera. If a channel is set to *Off*, the receiver skips that camera during a scan and leaves that camera's position blank in quad view.
- ▶ Only pair one camera at a time! The receiver links to the first camera it detects. If two or more cameras are in pairing mode, you can't control which camera the receiver will detect first.

Changing to a Different Camera

- ▶ On the receiver, press  to cycle through the enabled channels from CAM1 through CAM4. After the last enabled channel, the receiver goes back to the first camera.



- ▶ Each time you press , the receiver goes to the next enabled channel, regardless of whether there is a camera present on that channel. If there is no camera signal on a particular channel, the receiver shows a black screen with the message *No Signal*.



- ▶ You should only turn a channel *On* if you have a camera paired to that channel.
- ▶ The receiver skips any channels that are set to *Off* in the menu.



Setting Up a Scan

You can have the receiver automatically cycle through the enabled channels.

1. Open the menu, and scroll down to select *Scan time*.
 2. Use **RIGHT** or **LEFT** to select the amount of time you want the receiver to stay on each camera. Choose *5 seconds*, *10 seconds*, *15 seconds*, or *20 seconds*. To turn off the scan and stay on the current channel, select *Off*. To set the receiver into quad display, select *Quad* (see Using Quad Display on page 17).
 3. Double-check the channel settings (*CAM1* through *CAM4*) to make sure the correct channels are enabled.
- ▶ The receiver stays on each camera channel for the selected number of seconds, then switches to the next active channel.
 - ▶ The receiver starts the scan at the currently selected channel, then scans the remaining channels in order.
 - ▶ The receiver will only scan channels that are enabled in the menu.
 - ▶ The receiver does not go into quad display during a scan.
 - ▶ If you press  to manually switch channels, the receiver turns off the scan. Follow the procedure above to turn it back on.

If...	Try...
The display says <i>No Signal</i> when the receiver switches to a particular channel.	- Making sure there is a camera assigned the channel. - Making sure the camera is in range of the receiver. - Troubleshoot the camera assigned to that channel.
The receiver won't switch to a particular channel.	- Making sure the channel is enabled (set to <i>On</i> in the menu).
The receiver won't scan channels.	- Making sure <i>Scan Time</i> is not set to <i>Off</i> or <i>Quad</i> . - Making sure more than one channel is enabled.
I can't switch channels manually.	- Making sure more than one channel is enabled. - Making sure you are not in quad display.

Using Quad Display

In quad display, the receiver puts all four channels on the screen at the same time. The channels appear in the positions shown to the right:

- ▶ If a channel is disabled or there is no signal from the camera, that channel's section of the quad display will be blank.

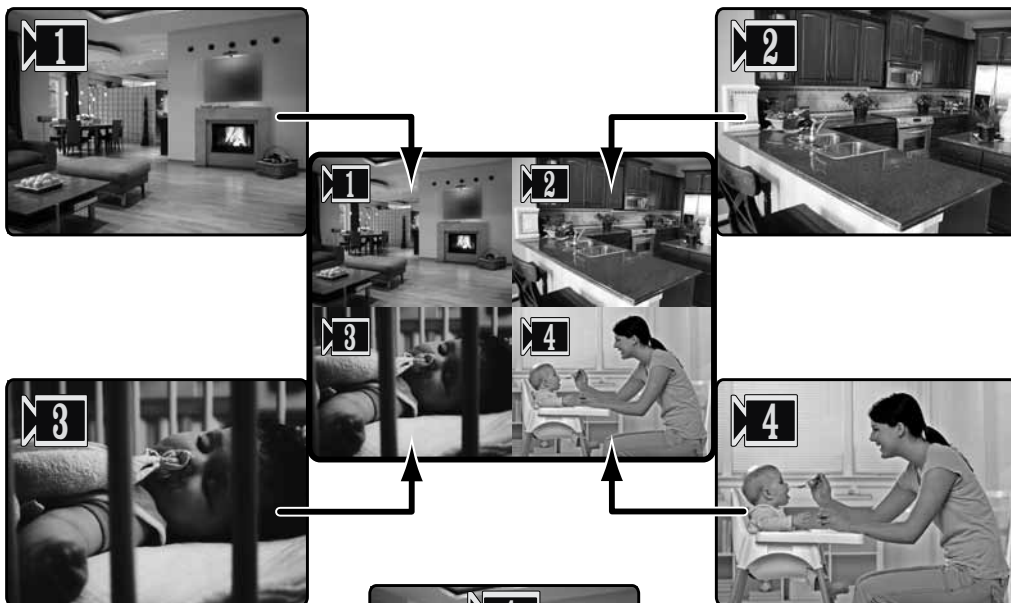

To enter quad display

1. Open the menu.
2. Scroll down to select *Scan time*.
3. Use **RIGHT** or **LEFT** to select *Quad*.

To exit quad display

Press the arrow keys to go to the channel you want.

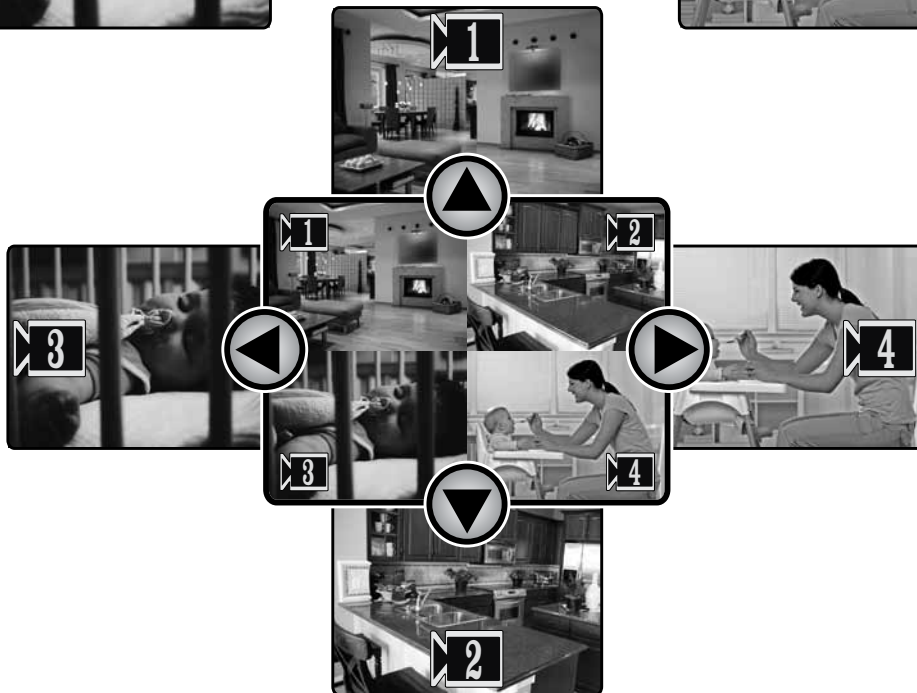

Solving Problems

If you have any trouble with your system, try these simple steps first. If you still have a question, call our Customer Care Line listed on the front cover.

If...	Try..
The image on the display is too bright.	<ul style="list-style-type: none"> - Adjusting the brightness on the receiver (in the <i>System Setup</i> sub-menu). - Moving the camera's sun shield over the lens.
The image on the display is too dim.	<ul style="list-style-type: none"> - Adjusting the brightness on the receiver (in the <i>System Setup</i> sub-menu). - Making sure the camera is at the right distance for low-light conditions.
The image on my television is too bright/dark.	<ul style="list-style-type: none"> - Adjusting the brightness on your television. (The receiver brightness setting does not affect the television.)
The image does not fit my TV screen.	<ul style="list-style-type: none"> - Changing the <i>TV out</i> setting on the receiver (in the <i>System Setup</i> sub-menu).
The display is completely blank.	<ul style="list-style-type: none"> - Making sure the AV output cable is not connected. - Making sure the receiver is plugged in. - Switching to a different camera. (If the receiver is in quad display mode and the cameras are not working, the screen could be blank.) - Resetting the receiver.
The display just says <i>No Signal</i> .	<ul style="list-style-type: none"> - Switching to a different channel. - Checking the channel status icon at the top of the screen to see which channel the receiver is on. Make sure the camera assigned to this channel is powered on. - Re-pair the camera to the receiver.
The display just says <i>USB PC Camera Mode</i> .	<ul style="list-style-type: none"> - Disconnecting the USB cable.
The image on the screen is frozen.	<ul style="list-style-type: none"> - Resetting the camera. - Resetting the receiver.
None of the buttons on the receiver respond when I press them.	<ul style="list-style-type: none"> - Resetting the receiver.



Unstable or Weak Signal



If the video seems to lag and or the audio sounds weak, the camera and the receiver do not have a strong, clear signal between them. There are several causes for a weak signal:

Possible Cause	Solution
The camera might be too far from the receiver.	<ul style="list-style-type: none"> - Adjust the antennas on the receiver and the camera. Often, changing the angle of the antenna can improve the signal strength. - Try moving the camera closer to the receiver.
The battery in the receiver may be low.	Make sure the battery in the receiver is fully charged.
There may be too many obstacles between the camera and receiver.	<ul style="list-style-type: none"> - Adjust the antennas on the receiver and the camera. - Remove as many obstacles from the signal path as possible, especially any large metal objects that might reflect the signal. - Avoid placing the camera and receiver where the signal path crosses a high-traffic area or body of water. For example, place the camera on the same side of a hallway as the receiver or mount the camera at least 7 feet up. - Relocate the camera and receiver so that there is a clear line of sight between them. - Try moving the camera closer to the receiver.

Weak signal and video performance

The video performance is directly affected by the signal quality. As the signal weakens degrades, the amount of data transferred decreases, and the video frame rate goes down. The table below shows a breakdown of the performance you can expect at the different levels of signal quality.

Signal Level	Icon	Data Rate (kbps)	Frames per second (approx)	
			QVGA (Zoom)	VGA (Normal)
Strong		1062~1280	15~20	5~10
Good		725~1062	12~16	3~5

Signal Level	Icon	Data Rate (kbps)	Frames per second (approx)	
			QVGA (Zoom)	VGA (Normal)
Fair		543~725	8~12	2~4
Low		250~543	0~5	0~1
Zero		0~250	0	0

If the suggestions above don't provide enough improvement in the the signal quality, you may want to run the camera at QVGA or zoom mode. When the camera is in zoom mode, it sends fewer pixels to the receiver, so the video performance is not as affected by the weak signal.

Noise or Static

The most likely cause of noise (flickering image) or static is interference. There are many common sources of interference:

- ▶ electrical appliances, especially microwave ovens
- ▶ computer equipment, especially wireless LAN equipment
- ▶ other radio-based wireless devices, such as cordless telephones
- ▶ wireless controllers, or wireless headphones or speakers
- ▶ large florescent light fixtures (especially if they give off a buzzing noise)
- ▶ working motors (hair dryers, heater/air conditioners, water pumps)

If the static is only on 1 camera	If the static is on all cameras
<ul style="list-style-type: none"> - Check near the camera for one of the common interference sources. - Try moving the camera away from a suspected source, or try moving the suspected source so it's not between the camera and the receiver. - Try moving closer to the receiver. There is always more noise at the edges of the receiver's range. 	<ul style="list-style-type: none"> - Check near the receiver for the source of interference. - Try moving the receiver away from a suspected source, or turn off the source if possible. - Try raising the receiver's antenna so it stands straight up.

Resetting Your System

Resetting the camera or receiver will erase any changes and set all values back to the default.

You should only reset your system under the following conditions:

Resetting the camera	Resetting the receiver
<ul style="list-style-type: none"> - You are unable to pair the camera to the receiver. - The image on the screen is frozen. 	<ul style="list-style-type: none"> - The buttons on the receiver are not responding. - The image on the screen is frozen, and resetting the camera did not help.

To reset the camera, unplug the AC adapter. Wait at least 15 seconds, then reconnect the AC adapter.

To reset the receiver:

1. Unplug the AC adapter and make sure the power is off.
2. Extend the antenna and locate the hole for the reset button.
3. Insert a small object (like a pencil point or an unbent paper clip) into the hole and gently press in.
4. Reconnect the AC adapter and let the battery charge fully.

Additional Information

Product Specifications

Radio Frequency Transceiver	
RF Frequency	2402 Mhz ~ 2483.5 Mhz
Modulation	GFSK
Spread spectrum	Frequency Hopping
Anti Interference	Clean Channel Dynamic Select
Selectable camera channel	4
Data rate	2 Mbps
Channel bandwidth	2 MHz
Transmitting range	500 feet (150 meters) in an open area (line of sight)

Image Specification	
Output Image resolution	640 x 480 (VGA)/ 320 x 240 (QVGA)
Image processing	Motion JPEG
Exposure	Auto
White balance	Auto

System Specifications	Camera	Receiver
Weight	240 g	195 g
Dimension	175 x 64 x 42 mm	133 x 87 x 27 mm
Operating temperature	-10° C (+14° F) to +50° C (122° F)	
Battery charging temp.	0° C (32° F) to +45° C (113° F)	
Input voltage	100-240 V AC @ 60 or 50 Hz	
Operating voltage	5 V DC @ 1 Amp	5 V DC @ 1 Amp

System Specifications	Camera	Receiver
Power consumption	650 mA max	650 mA max
Low light solution	24 IR LEDs, 1 Low light sensor	
Low light sensitivity	1-8 lux	
Picture sensor	OV7725 1/4' Color CMOS	
Lens	F3.6mm H:53 V:40	
Output Jacks		AV OUT : 3.5 mm headset jack to RCA USB : USB 1.1 or above

Lithium-Polymer Battery Warning

- ▶ The receiver contains a non-removeable rechargeable lithium-polymer battery.
- ▶ Do not try to charge the battery in temperatures below 0° C (32° F) or higher than 45° C (113° F)
- ▶ Dispose of this equipment according to the instructions.
- ▶ Do not open the receiver or mutilate the battery.
- ▶ The rechargeable battery contained in this receiver may explode if disposed of in a fire.
- ▶ Do not short-circuit the battery.
- ▶ Do not charge the rechargeable battery with any AC adapter other than the one provided. Using another adapter may damage the battery or cause the battery to explode.

Rechargeable Batteries Must Be Recycled or Disposed of Properly.

Recycling and Disposal Information

- ▶ Do not dispose of electronic devices or any of their components (especially batteries and LCD displays) in your municipal trash collection.

- ▶ Consult your local waste management authority or a recycling organization like Earth911.com to find an electronics recycling facility in your area.
- ▶ If you are unable to locate proper recycling facilities in your area, please return this product to Uniden for recycling.

FCC Compliance Information

Part 15 Compliance Statement

This device complies with Part 15 of the FCC Rules. Operation is subjected to the following two conditions: (1) this device may not cause harmful interference, and (2) this device must accept any interference received, including interference that may cause undesired operation.

This equipment has been tested and found to comply with limits for a Class B digital device, pursuant to Part 15 of the FCC rules and ETSI (EN) 300328. These limits are designed to provide reasonable protection against harmful interference in residential installations. This equipment generates, uses, and can radiate radio

frequency energy, and if not installed and used in accordance with the instructions, may cause harmful interference to radio communications.

However, there is no guarantee that interference will not occur in a particular installation. If this equipment does cause interference to radio or television equipment reception, which can be determined by turning the equipment off and on, the user is encouraged to try to correct the interference by one or more of the following measures:

- ▶ Reorient or relocate the receiving antenna.
- ▶ Move the equipment away from the receiver.
- ▶ Plug the equipment into an outlet on a circuit different from that to which the receiver is connected.
- ▶ Consult the dealer or an experienced radio/television technician for additional suggestions.

CAUTION! Any changes or modifications to this equipment not expressly approved by the party responsible for compliance could void your authority to operate the equipment.

RF Exposure Information

The antenna used for this transmitter must be installed to provide a separation distance of at least 20 cm (7.9") from all persons and must not be collocated or operating in conjunction with any other antenna or transmitter.

IC Compliance Information

Radio Equipment Notice

The term "IC:" before the radio certification number only signifies that Industry Canada technical specifications were met. Operation is subject to the following two conditions: (1) this device may not cause interference, and (2) this device must accept any interference, including interference that may cause undesired operation of the device. "Privacy of communications may not be ensured when using this device".

CE Compliance Information

Products with CE Marking comply with EMC Directive (2004/108/EC); Low Voltage Directive (73/23/EEC); R&TTE(1999/5/EC) issued by the Commission of the European Community. Compliance with these directives implies conformity to the following European Norms:

- ▶ EMC: EN 301 489
- ▶ LVD: EN 60950
- ▶ Radio: EN 300 328

One-year Limited Warranty

Important: Evidence of original purchase is required for warranty service.

WARRANTOR: UNIDEN AMERICA CORPORATION (“Uniden”) ELEMENTS OF WARRANTY: Uniden warrants, for one year, to the original retail owner, this Uniden Product to be free from defects in materials & craftsmanship with only the limitations or exclusions set out below.

WARRANTY DURATION: This warranty to the original user shall terminate & be of no further effect 12 months after the date of original retail sale. The warranty is invalid if the Product is (A) damaged or not maintained as reasonable or necessary, (B) modified, altered, or used as part of any conversion kits, subassemblies, or any configurations not sold by Uniden, (C) improperly installed, (D) serviced or repaired by someone other than an authorized Uniden service center for a defect or malfunction covered by this warranty, (E) used in any conjunction with equipment or parts or as part of any system not manufactured by Uniden, or (F) installed or programmed by anyone other than as detailed by the owner’s manual for this product.

STATEMENT OF REMEDY: In the event that the product does not conform to this warranty at any time while this warranty is in effect, warrantor will either, at its option, repair or replace the defective unit & return it to you without charge for parts, service, or any other cost (except shipping & handling) incurred by warrantor or its representatives in connection with the performance of this warranty. Warrantor, at its option, may replace the unit with a new or refurbished unit.

THE LIMITED WARRANTY SET FORTH ABOVE IS THE SOLE & ENTIRE WARRANTY PERTAINING TO THE PRODUCT & IS IN LIEU OF & EXCLUDES ALL OTHER WARRANTIES OF ANY NATURE WHATSOEVER, WHETHER EXPRESS, IMPLIED OR ARISING BY OPERATION OF LAW, INCLUDING, BUT NOT LIMITED TO ANY IMPLIED WARRANTIES OF MERCHANTABILITY OR FITNESS FOR A PARTICULAR PURPOSE. THIS WARRANTY DOES NOT COVER OR PROVIDE FOR THE REIMBURSEMENT OR PAYMENT OF INCIDENTAL OR CONSEQUENTIAL DAMAGES. Some states do not allow this exclusion or limitation of incidental or consequential damages so the above limitation or exclusion may not apply to you.

LEGAL REMEDIES: This warranty gives you specific legal rights, & you may also have other rights which vary from state to state. This warranty is void outside the United States of America & Canada.

PROCEDURE FOR OBTAINING PERFORMANCE OF WARRANTY: If, after following the instructions in the owner’s manual you are certain that the Product is defective, pack the Product carefully (preferably in its original packaging). Disconnect the battery from the Product & separately secure the battery in its own separate packaging within the shipping carton. The Product should include all parts & accessories originally packaged with the Product. Include evidence of original purchase & a note describing the defect that has caused you to return it. The Product should be shipped freight prepaid, by traceable means, to warrantor at:

Uniden America Service
4700 Amon Carter Blvd.
Fort Worth, TX 76155

Free Manuals Download Website

<http://myh66.com>

<http://usermanuals.us>

<http://www.somanuals.com>

<http://www.4manuals.cc>

<http://www.manual-lib.com>

<http://www.404manual.com>

<http://www.luxmanual.com>

<http://aubethermostatmanual.com>

Golf course search by state

<http://golfingnear.com>

Email search by domain

<http://emailbydomain.com>

Auto manuals search

<http://auto.somanuals.com>

TV manuals search

<http://tv.somanuals.com>