

SHARP®

POS TERMINAL

MODEL

UP-3300

INSTRUCTION MANUAL

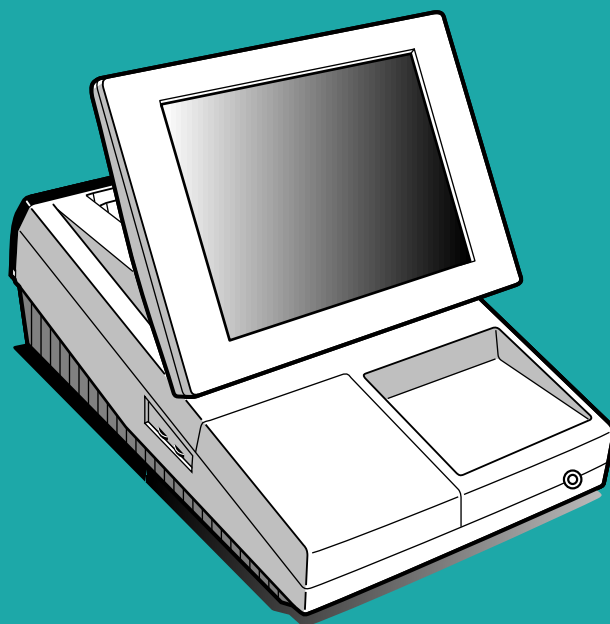

CAUTION:

The drawer unit should be securely fitted to the supporting platform to avoid instability when the drawers are open.

CAUTION:

The socket-outlet shall be installed near the equipment and shall be easily accessible.

VORSICHT:

Die Netzsteckdose muß nahe dem Gerät angebracht und leicht zugänglich sein.

ATTENTION:

La prise de courant murale devra être installée à proximité de l'équipement et devra être facilement accessible.

AVISO:

El tomacorriente debe estar instalado cerca del equipo y debe quedar bien accesible.

WARNING:

Det matande vägguttaget skall placeras nära apparaten och vara lätt åtkomligt.

CAUTION:

For a complete electrical disconnection pull out the mains plug.

VORSICHT:

Zur vollständigen elektrischen Trennung vom Netz den Netzstecker ziehen.

ATTENTION:

Pour obtenir une mise hors-circuit totale, débrancher la prise de courant secteur.

AVISO:

Para una desconexión eléctrica completa, desenchufar el enchufe de tomacorriente.

WARNING:

För att helt koppla från strömmen, dra ut stickproppen.

This equipment complies with the requirements of Directives 89/336/EEC and 73/23/EEC as amended by 93/68/EEC.

Dieses Gerät entspricht den Anforderungen der EG-Richtlinien 89/336/EWG und 73/23/EWG mit Änderung 93/68/EWG.

Ce matériel répond aux exigences contenues dans les directives 89/336/CEE et 73/23/CEE modifiées par la directive 93/68/CEE.

Dit apparaat voldoet aan de eisen van de richtlijnen 89/336/EEG en 73/23/EEG, gewijzigd door 93/68/EEG.

Dette udstyr overholder kravene i direktiv nr. 89/336/EEC og 73/23/EEC med tillæg nr. 93/68/EEC.

Quest' apparecchio è conforme ai requisiti delle direttive 89/336/EEC e 73/23/EEC, come emendata dalla direttiva 93/68/EEC.

Η εγκατάσταση αυτή ανταποκρίνεται στις απαιτήσεις των οδηγιών της Ευρωπαϊκής Ένωσης 89/336/ΕΟΚ και 73/23/ΕΟΚ, όπως οι κανονισμοί αυτοί συμπληρώθηκαν από την οδηγία 93/68/ΕΟΚ.

Este equipamento obedece às exigências das directivas 89/336/CEE e 73/23/CEE, na sua versão corrigida pela directiva 93/68/CEE.

Este aparato satisface las exigencias de las Directivas 89/336/CEE y 73/23/CEE, modificadas por medio de la 93/68/CEE.

Denna utrustning uppfyller kraven enligt riktlinjerna 89/336/EEC och 73/23/EEC så som komplette ras av 93/68/EEC.

Dette produktet oppfyller betingelsene i direktivene 89/336/EEC og 73/23/EEC i endringen 93/68/EEC.

Tämä laite täyttää direktiivien 89/336/EEC ja 73/23/EEC vaatimukset, joita on muutettu direktiivillä 93/68/EEC.

Warning

This is a Class A product. In a domestic environment this product may cause radio interference in which case the user may be required to take adequate measures.

Warnung

Dies ist eine Einrichtung der Klasse A. Diese Einrichtung kann im Wohnbereich Funkstörungen verursachen; in diesem Fall kann vom Betreiber verlangt werden, angemessene Maßnahmen durchzuführen und dafür aufzukommen.

Avertissement

Ceci est un produit de Classe A. Dans un environnement domestique ce produit risque de provoquer une interférence radio, auquel cas l'utilisateur sera obligé d'observer les mesures adéquates.

Advertencia

Este es un producto de la clase A. En un ambiente doméstico es posible que este producto cause radiointerferencia. En este caso se solicita al usuario que tome medidas adecuadas.

FOR CUSTOMERS IN U.K.

IMPORTANT

The wires in this mains lead are coloured in accordance with the following code:

GREEN-AND-YELLOW:	Earth
BLUE:	Neutral
BROWN:	Live

As the colours of the wires in the mains lead of this apparatus may not correspond with the coloured markings identifying the terminals in your plug proceed as follows.

The wire which is coloured **GREEN-AND-YELLOW** must be connected to the terminal in the plug which is marked by the letter **E** or by the safety earth symbol \perp or coloured green or green-and-yellow.

The wire which is coloured **BLUE** must be connected to the terminal which is marked with the letter **N** or coloured black.

The wire which is coloured **BROWN** must be connected to the terminal which is marked with the letter **L** or coloured red.

Ensure that your equipment is connected correctly – if you are in any doubt, consult a qualified electrician.

“WARNING: THIS APPARATUS MUST BE EARTHED.”

Environment Protection

The device is supported by a battery. To dispose the battery safely to protect the environment, please note the following points:

- Take the used battery to your local waste depot, dealer or customer service centre for recycling.
- Do not throw the used battery into fire, into water or into the household waste!

Umweltschutz

Das Gerät wird durch eine Batterie gestützt. Um die Batterie sicher und umweltschonend zu entsorgen, beachten Sie bitte folgende Punkte:

- Bringen Sie die leere Batterie zu Ihrer örtlichen Mülldeponie, zum Händler oder zum Kundenservice-Zentrum zur Entsorgung.
- Werfen Sie die leere Batterie niemals ins Feuer, ins Wasser oder in den Hausmüll.

Protection de l'environnement

L'appareil est supporté sur pile. Afin de protéger l'environnement, nous vous recommandons de traiter la pile usagée la façon suivante:

- Apporter la pile usagée à votre centre de traitement des ordures ménagères le plus proche ou, à votre revendeur ou, au service après-vente, pour recyclement.
- Ne jamais jeter la pile usagée dans une source de chaleur, dans l'eau ou dans les vide-ordures.

Miijöskydd

Denna produkt nöddrivs av batteri.

Vid batteribyte skall följande iakttas:

- Det förbrukade batteriet skall inlämnas till er lokala handlare eller till kommunal miljöstation för återinsamling.
- Kasta ej batteriet i vattnet eller i hushållssoporna. Batteriet får ej heller utsättas för öppen eld.

INTRODUCTION

Thank you very much for your purchase of the SHARP POS Terminal Model UP-3300. Please read this Manual carefully before operating your machine in order to gain full understanding of functions and features. Please keep this manual for future reference. It will help you if you encounter any operational problems.

IMPORTANT

- **Install your POS terminal in a location that is not subject to direct radiation, unusual temperature changes, high humidity or exposure to water sources.**
Installation in such locations could cause damage to the cabinet and the electrical components.
- **The POS terminal should not be operated by an individual with wet hands.**
The water could seep into the interior of the POS terminal and cause component failure.
- **Do not apply excessive pressure to the display.**
Do not use a sharp-pointed object on the display.
The LCD display will be damaged easily.
- **When cleaning your POS terminal, use a dry, soft cloth. Never use solvents, such as benzine and/or thinner.**
The use of such chemicals will lead to discoloration or deterioration of the cabinet.
- **The POS terminal plugs into any standard wall outlet (official (nominal) voltage).**
Other electrical devices on the same electrical circuit could cause the POS terminal to malfunction.
- **If the POS terminal malfunctions, call your authorized SHARP dealer for service - do not try to repair the POS terminal yourself.**

PRECAUTION

This POS terminal has a built-in memory protection circuit which is operated by a rechargeable battery pack. It should be known that all batteries will, in time, dissipate their charge even if not used. Therefore to insure an adequate initial charge in the protection circuit and to prevent any possible loss of memory upon installation, it is recommended that each unit be allowed to be recharged for a period of 24 to 48 hours prior to use by the customer.

In order to charge the battery pack, the machine must be plugged in and its power switch must be set to the "ON" position. This recharging precaution can prevent unnecessary initial service calls.

CONTENTS

INTRODUCTION	1
IMPORTANT	1
PRECAUTION	1
1. Part Names and Functions	7
External View	7
Front view	7
Rear view	7
Display	8
Operator display (touch panel)	8
Screen save mode	9
Clerk keys	10
2. Before Operating the POS Terminal	11
Display Adjustment	11
Connecting the Printer and Installing the Paper Rolls	11
3. Selecting an Operating Mode	12
Operating Modes	12
Mode Selection	13
Selecting a mode	13
Returning to the mode selection window	13
4. Receipts	14
Type of Receipts	14
Addition receipt type	14
Addition without payment receipt type	14
Single/double receipt type	15
Single/double + addition receipt type	15
Addition + single receipt type	16
Double addition receipt type	16
Double (addition + single) receipt type	16
Sorted Receipt Function	17
5. Prior to Entries	20
Preparations for Entries	20
Error Warning	20
Sample Receipt	20
6. Entries	21
Function Key Description	21
Touch-panel keyboard	21
Function keys list	29
How to Use the Touch Panel	32
Cursor control by touching option(s) or item(s) in the window	32
Clerk Assignment	34
Item Selection from the Menu Window	34
Starting Cash Memory Entry	35
Item Entries	36
Single item entries	36
Repeat entries	38
Multiplication entries	38
Split-pricing entries	39
Single item cash sale (SICS)/single item finalize (SIF) entries	40
Scale entries	41
Non-turnover sales	43
Special Entries for PLUs	44
Promotion (normal selling) function	44
Promotion (set selling) function	45

Link PLU entries	46
Combo meal entries	46
With/without entries	47
PLU level shift (for direct PLUs)	48
PLU price level shift	50
Condiment entries	51
Happy hour	53
Department shift	53
Pint entries	54
Display of Subtotals	55
Subtotal	55
Difference subtotal (Differ ST)	55
Finalization of Transaction	56
Cash or check tendering	56
Mixed tendering (check + cash)	57
Cash or check sale that does not need any tender entry	57
Credit sale	58
Mixed-tender sale (cash or check tendering + credit tendering)	58
Computation of VAT (Value Added Tax)/Tax	59
VAT/tax system	59
Vat shift entries	60
Guest Check (GLU/PBLU)	61
GLU/PBLU system	61
Drive-through function	64
Deposit entries	68
Transferring guest checks out or in (Transfer-in/out)	69
Bill printing	70
Intermediate GLU reading (only for GLU system)	71
Bill totalizing/bill transfer	71
Bill separating	73
Transaction migration	75
Auxiliary Entries	76
Percent calculations (premium or discount)	76
Discount entries	77
Refund entries	78
Return entries	78
Printing of non-add code numbers	79
Printing of free text	79
Entertainment bill	80
Payment Treatment	81
Tip-in entries	81
Currency exchange	82
Received-on-account entries	83
Paid-out entries	84
No-sale (exchange)	85
Transferring cash	85
Cashing a check	86
Service charge	87
VIP sales	87
WASTE mode	88
Employee Function	89
Clerk/manager sign-on	89
Employee's working time recording	89
TRAINING Mode	91
Supervisor Clerk	92
Overlapped Clerk Entry	93
7. Correction	94
Correction of the Last Entry (Direct Void)	94
Correction of the Next-to-Last or Earlier Entries (Indirect Void)	95
Subtotal Void	96
Correction of Incorrect Entries Not Handled by the Direct, Indirect or Subtotal Void Function	96

8. Special Printing Function	97
Copy Receipt Printing	97
Guest Check Copy	98
Validation Printing Function	98
9. Manager Mode	99
Entering the Manager Mode	99
Override Entries	99
Tip Paid Entries	100
Bill recording/Bill void	100
10. Correction after Finalizing a Transaction	101
11. Reading (X) and Resetting (Z) of Sales Totals	102
How to take a X1/Z1 or X2/Z2 report	102
Daily Sales Totals	105
General report	105
Department report	108
Individual group total report on departments	108
Full group total report on departments	108
PLU report by designated range	109
Combo sales report	110
PLU report by associated department	111
Individual group report on PLUs	112
Full group total report on PLUs	112
PLU stock report	112
PLU cost report	113
PLU top 20 report	114
PLU zero sales report (full)	115
PLU zero sales report (by dept.)	115
PLU minimum stock report	115
PLU group total report by hour	116
Total in drawer report	116
Transaction report	116
Commission sales report	117
Tax report	117
Chief report	117
Full clerk report	118
Individual clerk report	119
Clerk report (Drink dispenser misoperation)	121
Drink dispenser error reading report	121
Drink dispenser resetting report	121
Employee active status report	122
Hourly report	122
Drive-through service time report	122
Labor cost % report	123
Ingredient stock report	123
GLU/PBLU report	123
GLU/PBLU report by clerk	124
Drive-through report	124
Drive-through report by clerk	125
Balance report	125
Bill report	125
X1/Z1 stacked reports	125
Periodic Consolidation	126
General information	126
Employee report	127
Over time report	127
Employee time adjustment report	128
Daily net report	128
X2/Z2 stacked report	128
Compulsory Cash/Check Declaration	129

12. How to Use the Programming Keyboard	131
Programming Keyboard Layout	131
How to Program Alphanumeric Characters	132
Using character keys on the keyboard	132
Entering character codes	133
13. Programming	134
Basic Instructions	134
Programming example	134
Article Programming	136
Department	137
PLU	139
PLU range	142
PLU stock	143
Ingredient	144
Ingredient stock	145
PLU menu key	146
Combo meal	147
Link PLU table	148
Condiment table	149
Promotion table (normal selling)	151
Promotion table (set selling)	152
Recipe table	153
Scale table	154
Department shift	155
Happy hour	155
Direct Key Programming	156
Direct PLU/dept. key	157
Functional Programming	158
Discount key ([-1] thru [-9])	159
Percent key (%1 thru %9)	160
Commission	160
Service charge	161
Tip	161
Deposit	162
RA	162
PO	163
Media Key Programming	164
Cash key	165
Check key (CHK through CHK4)	166
Credit key (CR1 through CR8)	167
Hotel transfer key	168
Cash in drawer	169
Check change	169
Check cashing	170
Currency Programming	171
Currency exchange key (EXCHANGE1 through EXCHANGES)	171
Foreign drawer	171
Text Programming	172
Function text	173
Department group text	176
PLU group text	176
PLU hourly group text	177
Personnel Programming	178
Clerk	179
Manager	181
Employee	182
Job location table	183
Terminal Programming	184
Date/Time Setting	185
Date/time	185
Optional Feature Selection	186
Function prohibition	187

Function selection	188
Printing selection	190
Report Programming	193
Zero skip	194
General report format	195
Hourly report	195
Stacked report	196
Message Programming	199
Receipt logo	200
Free text	200
Validation printing text	201
Slip text	201
Slip footer	201
Entertainment bill message	202
Payee name	202
Funktion Key Programming	203
Device Configuration Programming	204
Journal printer	205
Receipt printer	205
Slip printer	206
Report printer	207
Remote printer (KP#1 through KP#9)	207
Scale/Drink dispenser/On-line	208
Drive-through Code Programming	209
Drive-through code	209
Tax Programming	210
IR Data Send Programming	211
IR data send	211
IR Data Receive Programming	212
IR data receive	212
Drink Dispenser Programming	213
Drink dispenser preset	214
Drink dispenser operator	215
Downloading	215
On-line Configuration Programming	216
Price Mode Programming	217
Automatic Sequencing Key Programming	218
Reading of Stored Programs	219
Program reading sequence	219
Sample printouts	221
14. Drink Dispenser	235
Drink dispenser misoperation and misoperation file	236
Causes of drink dispenser misoperation	236
Description of misoperation	237
Misoperation file reading	237
Correction of drink dispenser articles in a drink dispenser misoperation file	238
15. Electronic Journal/Data Clear	239
16. EURO Migration Function	240
17. Operator Maintenance	241
Replacing the Backup Battery Pack	241
In Case of Power Failure	243
Before Calling for Service	243
18. Options	244
List of Options	244
19. Specifications	245

1

Part Names and Functions

This chapter describes the part names and functions of this POS terminal.

External View

■ Front view

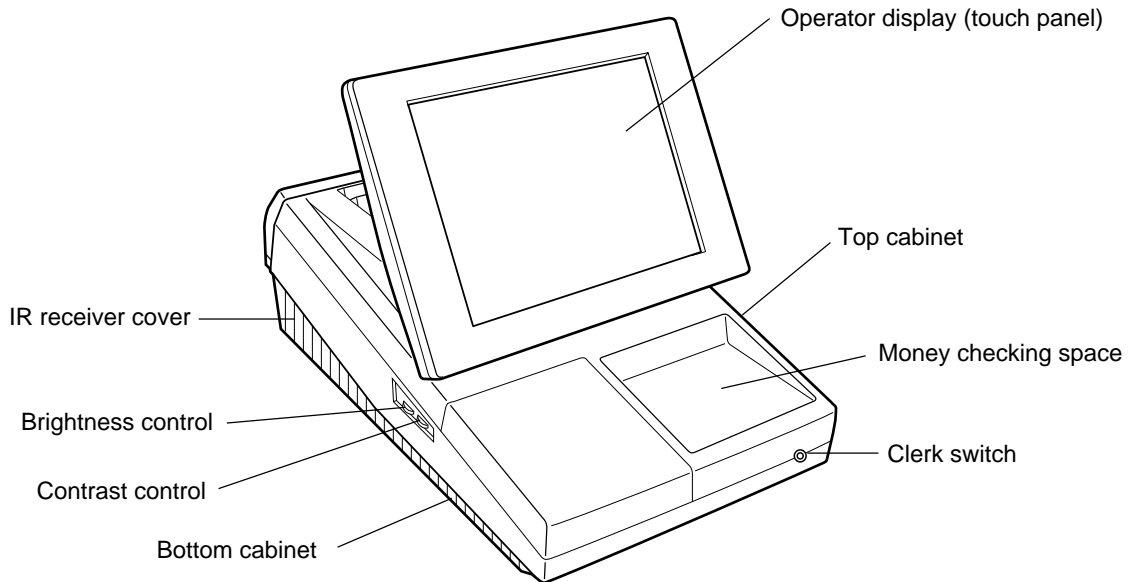

■ Rear view

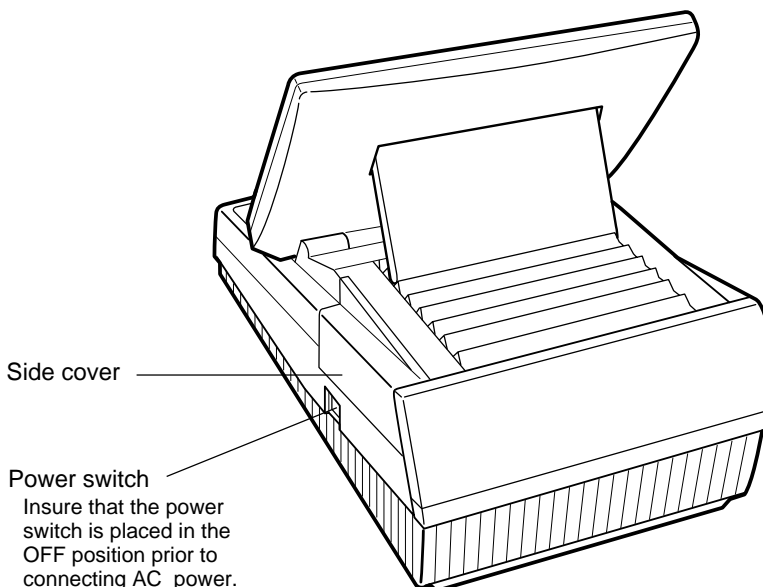

Display

This POS terminal is equipped with a color LCD operator display.

The operator display is a touch panel.

The operations can be performed by touching the screen (that shows keys or items in the receipt window) of the operator display.

■ Operator display (touch panel)

The display can be tilted to the best viewing angle by sliding the rear stand.

Be sure to push the button on the rear stand when sliding it.

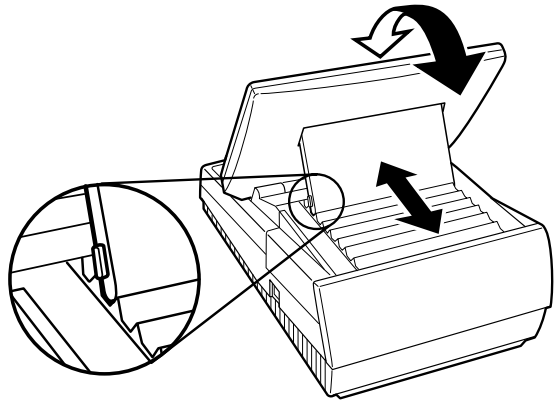

• Screen example (REG mode)

		Time	Mode caption				
CLERR0001		0001	MAIN-1(HOME)				
		20:43	REG				
1	PL000001	1.10	MODE	MENU01	MENU02	MENU03	MENU04
1	PL000003	1.75					
1	PL000002	2.50					
CASH		5.35	UATSFT	MENU05	MENU06		
		[J]	L1	DPT.01	DPT.02	DPT.03	DPT.04
***TOTAL		5.35	L2	000001	000006		
CASH		5.35					
		P1L01					
MGR FU	7	8	9	ENTER	SUB	000002	000007
VOID	4	5	6	OPEN T	TEXT1	000003	000008
CANCEL	1	2	3	NBAL	AUTO	000004	000009
CLEAR	⊙	+MORE	MORE>	NEXT C	PAYMEN	000005	000010

NOTE Once the internal clock unit is started at the correct time, it continues to run as long as the battery pack is charged and will also update the date properly.

Touch-panel keyboard

Numeric entry: An entered figure appears at the cursor position.

Window

NOTE The size of a display area depends on the layout of a touch-panel keyboard (ex. key size) or the function mode (ex. drive-through function).

• **Display example 1 (REG mode)**

The screenshot shows the REG mode interface with the following data and annotations:

Clerk name	Time	Mode caption
CLERK0003	20:53	REG
0003		
1 PL000001	1.10	Clerk code
1 PL000005	2.80	
1 PL000002	2.50	
CASH	6.40	Stock indicator (!): Appears when the stock value become to less than minimum stock.
***TOTAL		Department shift status indicator (D1-D4): Shows the department shift status currently selected.
CASH	6.40	VAT shift status indicator (V): Appears when the VAT status is shifted.
		E-Mail indicator (M): Appears when the E-mail data exist.
		Sentinel mark (X): Appears in the lower right corner of the screen when the cash in drawer exceeds a programmed sentinel amount. The sentinel check is performed for the total cash in drawer.
		Receipt ON/OFF status indicator (R): Appears when the receipt ON-OFF function is set to OFF. The indication disappears when the function signs ON.
		PLU level shift indicator (L01 - L10): Shows the PLU level currently selected.
		Price level shift indicator (P1 - P7): Indicates the PLU price level currently selected.

Numeric entry:
An entered figure appears at the cursor position.

Received media type

Window: In the REG mode, the window shows item information you have just entered such as items and media types.

• **Display example 2 (PGM mode)**

The screenshot shows the PGM mode interface with the following data and annotations:

Clerk name	Time	Mode caption
CLERK0001	20:56	PGM2
0001		
01		Clerk code
PRICE	5.00	
GROUP No.	01	
DESCRIPTION	DPT. =0=1	
KEY DESCRIPTION	DPT.01	
KEY COLOR	CYAN	
ITEM UP	NON-COMPULSORY	
TARE TABLE No.	0	
SCALE	INHIBIT	
SIF/SICS-NORMAL	NORMAL	
RECEIPT TYPE	SINGLE	
AMT. ENTRY TYPE	OPEN & PRESET	
CANCEL ENTER		

Window:
In the PGM mode, programmable items are listed.

Double-size character mode indicator (W):
Appears when the double-size character mode is selected during text programming.

■ **Screen save mode**

To save the electrical power or the display's life, your POS terminal is provided with the screen save function. This function can turn the LCD backlight off when the POS terminal is left idle for an extended period of time. You can program the time for which your POS terminal should keep the normal status (in which the backlight is "ON") before it goes into the screen save mode.

To exit the screen save mode, touch a key.

Clerk Keys

This POS terminal allows the operator to use the following four clerk identification systems:

- Real clerk keys (standard 6 clerks/max. 126 clerks)
- Clerk code entry (max. 255 clerks)
- Clerk entry keys (max. 10 clerks)
- WMF clerk keys (max. 127 clerks)

The standard POS terminal has been shipped with the real clerk key system being programmed. If you want to change the clerk identification system, contact your authorized SHARP dealer.

Real clerk keys (1, 2, 3, 4, 5, and 6)



These keys serve to identify clerks. Put one of the 1 through 6 keys in the clerk switch.

Clerk code entry (1 through 9999)

Enter the clerk code by using the following procedure:

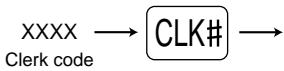

Clerk entry keys



These keys identify clerks. Touch any one of these keys.

WMF clerk keys

Put one of the WMF clerk keys in the WMF clerk switch.

2

Before Operating the POS Terminal

This chapter describes those steps required prior to using the POS terminal for the first time.

Display Adjustment

You can adjust the brightness and contrast of the display by using the corresponding controls.

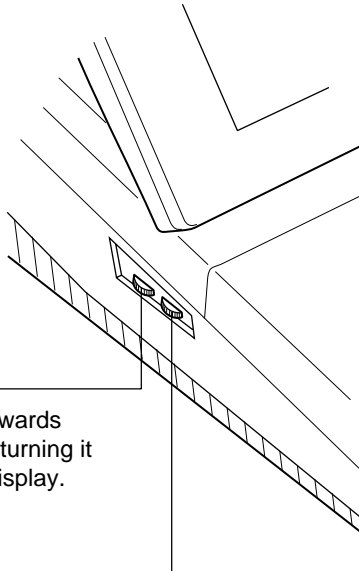

- **Brightness control**

Turning the control backwards darkens the display and turning it forwards brightens the display.

- **Contrast control**

Turning the control backwards darkens the display and turning it forwards lightens the display.

The backlight in the display is a consumable part.

When the LCD display may no longer be adjusted and becomes darker, you should change the backlight. Consult your authorized SHARP dealer for further details.

Connecting the Printer and Installing the Paper Rolls

This POS terminal may be configured with multiple types of printers offered in the market. For specific instructions related to the handling and care of the printer, please refer to the applicable printer instruction manual.

3

Selecting an Operating Mode

The POS terminal will display the following listing by touching the **MODE** key.

Mode selection window

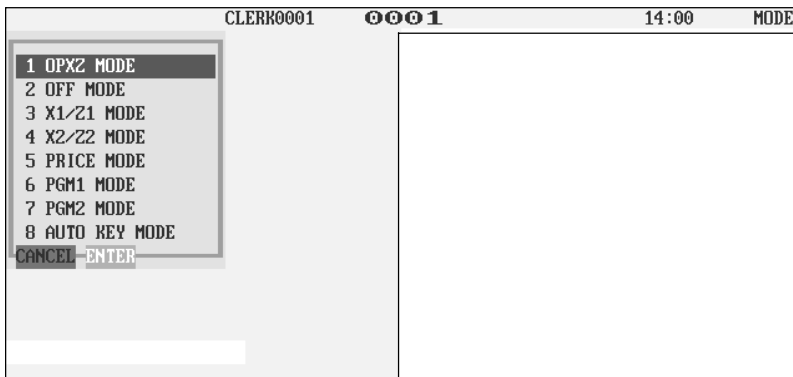

Operating Modes

You can select any mode other than REG from the list in the mode selection window. Your POS terminal supports the following 9 operating modes:

REG mode	This mode allows you to enter various sales information. The mode selection window does not list this mode. To select this mode from the mode selection window, touch the CANCEL key.
OPXZ mode	This mode allows clerks to take X or Z reports on their sales information. It can also be used for employee time function.
OFF mode	This mode locks all operations of the POS terminal. When you select this mode, the window will disappear. Touching any key turns the POS terminal ON.
X1/Z1 mode	This mode is used to take various daily reports (X1/Z1 reports).
X2/Z2 mode	This mode is used to take various weekly or monthly reports (X2/Z2 reports).
PRICE mode	This mode allows you to program unit price of PLUs.
PGM1 mode	This mode allows you to program those items which need to be changed often such as unit prices and discount percentages.
PGM2 mode	This mode allows you to program those items which can be programmed in the PGM1 mode and do not require frequent changes such as date, time, and terminal functions.
AUTO KEY mode	This mode allows you to program automatic sequencing keys.

Mode Selection

Procedure

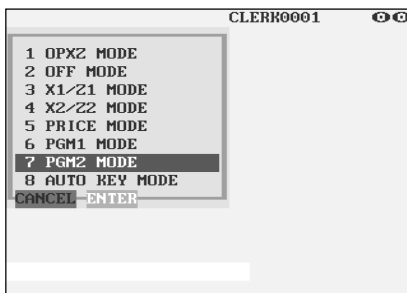
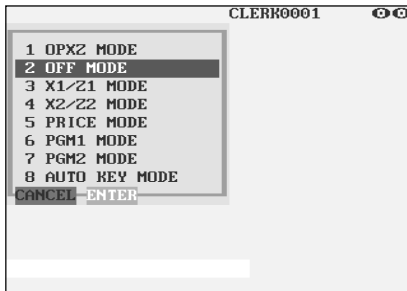

Procedure

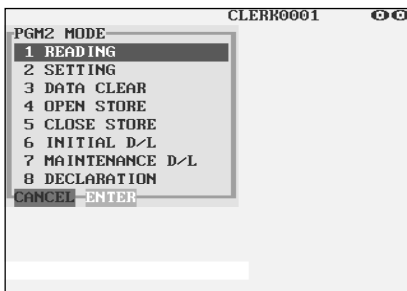

■ Selecting a mode

Use one of the following three methods:

1. Touch the desired option line in the window.
2. Move the cursor to a desired option by using the or key. Then touch the key.
3. Enter the desired option number by using a numeric key. Then touch the key.

NOTE

When you want to enter the REG mode, simply touch the key.

■ Returning to the mode selection window

To return to the mode selection window, use the following procedure:

1. Touch the or key with the menu screen of the selected mode displayed.
 - You will enter the REG mode.
2. Touch the key.
 - You will return to the mode selection window.

4

Receipts

Type of Receipts

You can select one of the following 7 types of receipts. These types of receipts are available in the REG, MGR or VOID mode. By default, the addition receipt type is selected. If you want to change the type of receipts, contact your authorized SHARP dealer.

- Addition receipt type
- Addition without payment receipt type
- Single/double receipt type
- Single/double + addition receipt type
- Addition + single receipt type
- Double addition receipt type
- Double (addition + single) receipt type

■ Addition receipt type

The addition receipt is a standard type. Several items can be printed on one receipt.

Addition receipt

15/12/99	123456
10:27	
JACK	
PL000001	*1.20
PL000003	*5.00
CASH	*6.20

■ Addition without payment receipt type

Your POS terminal prints in the same manner as for the addition receipt type. However, it does not print the total part which shows payment methods such as "CASH" and "CHECK" with the total amount.

Addition without payment receipt

15/12/99	123456
10:40	
JACK	
PL000001	*1.20
PL000003	*5.00
SUBTOTAL	*6.20

■ Single/double receipt type

When you select this type:

- One receipt is issued and the transaction is finalized each time you enter an item.
- A single receipt or a double receipt is issued depending on the PGM2 programming for the department.
- Each sales transaction is automatically handled as a cash deal.
- Items specified as SICS or SIF are treated as a single type.
- PBLU entry is allowed. (However, the receipt type is regarded as the single/double + addition mode receipt type.)
- Only the top logo is printed on the first part of the double receipt and the single receipt.
No logo is printed on the second part of the double receipt.

Double receipt		Single receipt
15/12/99 123456 10:50 JACK PL000001 *1.20 <hr style="border-top: 1px dashed black;"/> 15/12/99 123456 10:50 JACK PL000001 *1.20	← Perforation	15/12/99 123456 10:47 JACK PL000001 *1.20

■ Single/double + addition receipt type

When you select this type:

- Each item receipt is issued in series after you finalize the transaction.
- A single receipt or a double receipt is issued depending on the PGM2 programming for the department.
- PBAL receipts and a total part of receipt are not issued in a PBLU entry.
- Items specified as SICS or SIF are treated as single type.
- Only the top logo is printed on the first part of the double receipt and the single receipt.
No logo is printed on the second part of the double receipt.

Double receipt		Single receipt
15/12/99 123456 10:53 JACK PL000001 *1.20 <hr style="border-top: 1px dashed black;"/> 15/12/99 123456 10:53 JACK PL000001 *1.20	← Perforation	15/12/99 123456 10:53 JACK PL000001 *1.20

■ Addition + single receipt type

When you select this type:

- An addition receipt and each single receipt are issued in series after you finalize the transaction.
- Footer logo message is printed at the end of the addition receipt part.
- PBAL receipts and a total part of receipt are not issued in a PBLU entry.
- The information on multiplication entry will be printed on a single receipt.
- Only the top logo is printed on each single receipt.

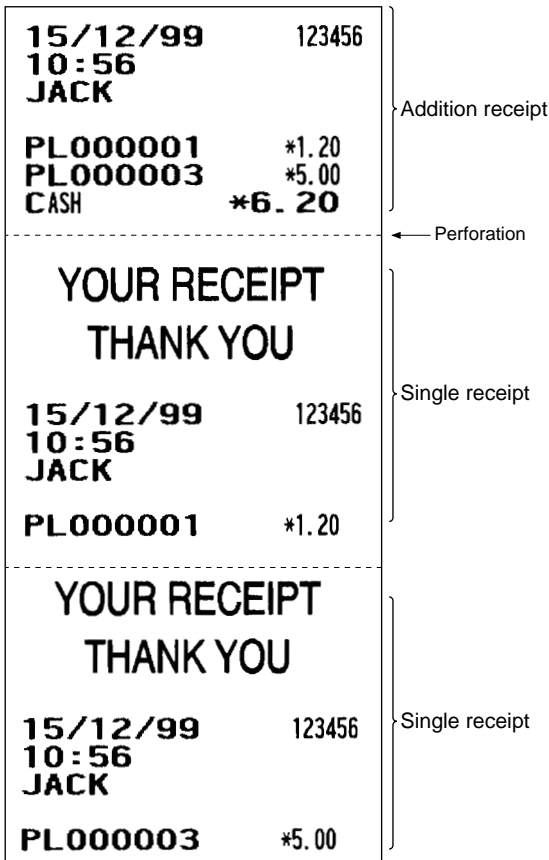

■ Double addition receipt type

The contents of this type of receipt is same as the addition receipt type. However, the same receipt will be issued two times.

■ Double (addition + single) receipt type

The contents of this type of receipt is same as the (addition + single) receipt type. However, the same receipt will be issued two times.

Sorted Receipt Function

When the sorted receipt function is programmed for your POS terminal, PLUs are printed in sorted form by PLU group regardless of the order that you entered items.

If you want to use this function, contact your authorized SHARP dealer.

NOTE

This function is ineffective when the single/double receipt type is selected.

Example

It is assumed that you enter the items in the following order:

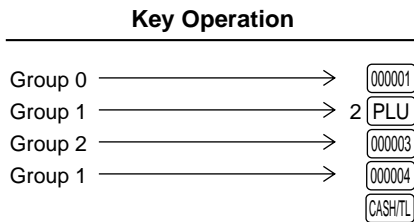

The print format differs depending on the programmed receipt type as follows:

• Addition receipt type

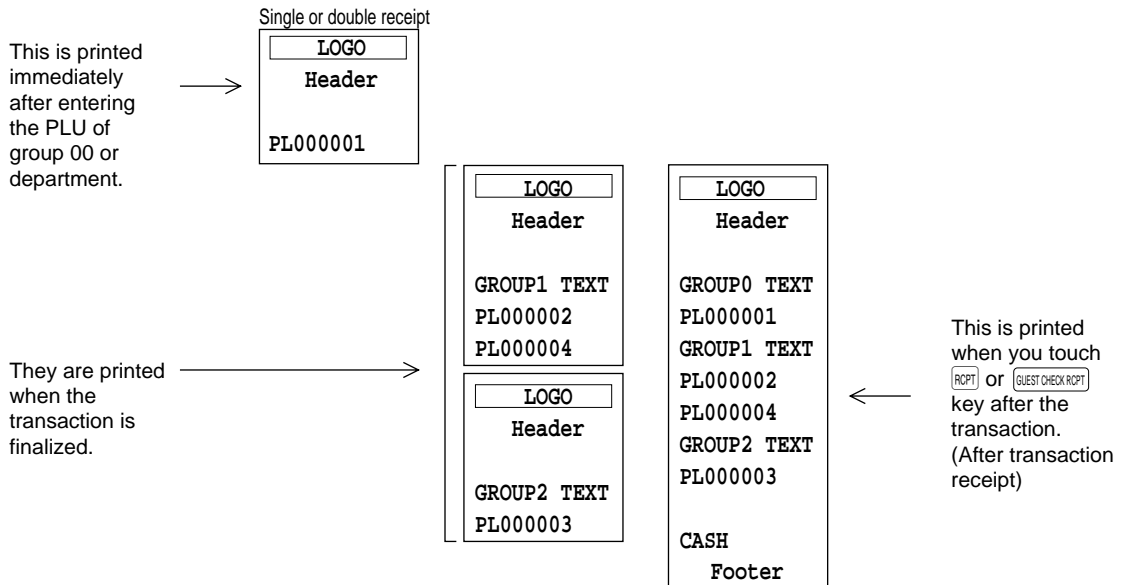

• **Addition without payment receipt type**

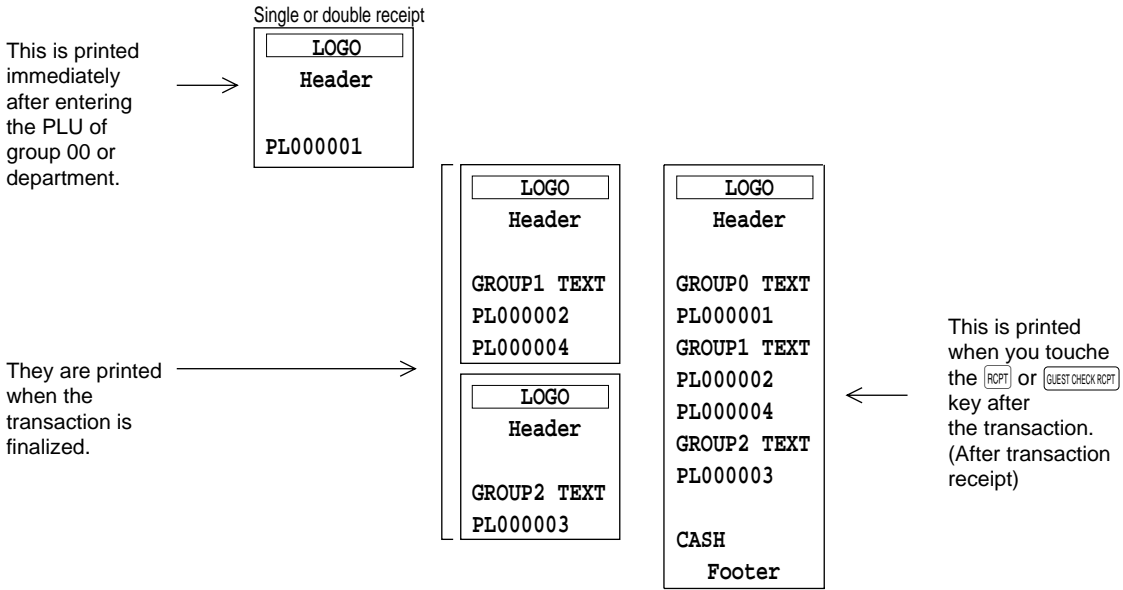

• **Single/double + addition receipt type**

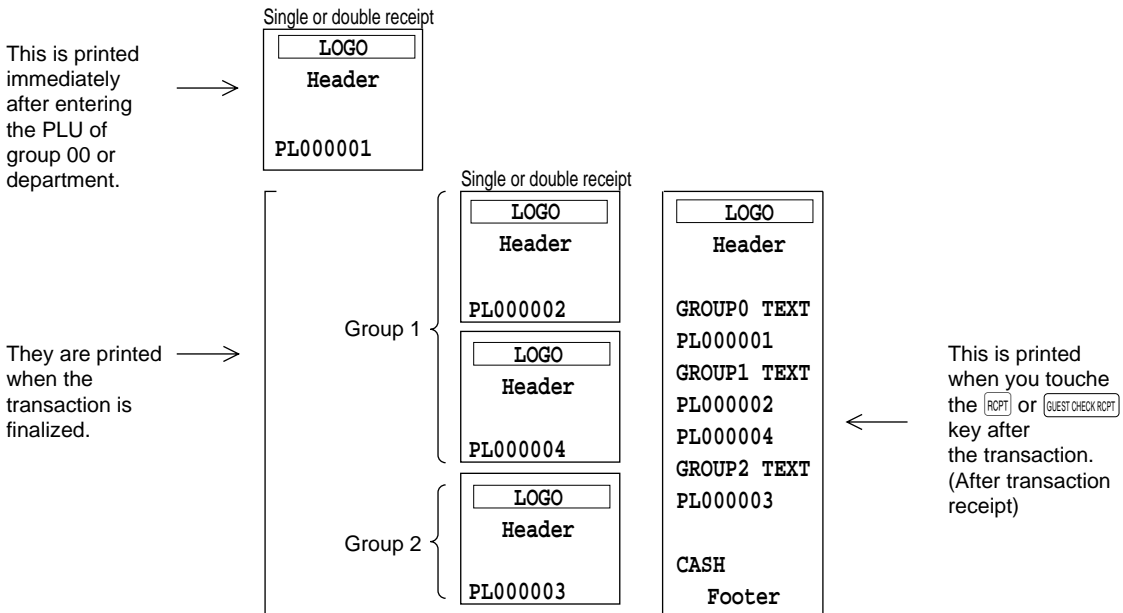

• Addition + single receipt type

This is printed immediately after entering the PLU of group 00 or department.

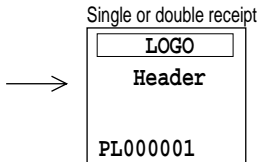

They are printed when the transaction is finalized.

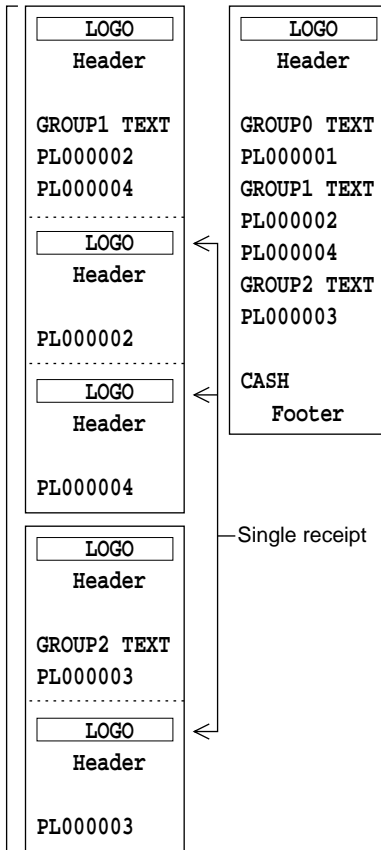

This is printed when you touch the RCPT or GUEST CHECK RCPT key after the transaction. (After transaction receipt)

5

Prior to Entries

REG MODE

Preparations for Entries

1. Select the REG mode from the mode selection menu by touching the **CANCEL** key.
2. Insure that all printers in your system have adequate paper rolls prior to beginning entries. For more information, please refer to the applicable printer's manual.

Error Warning

In the following examples, your POS terminal will go into an error state accompanied with a warning beep and the error message on the display. Clear the error state by touching the **CLEAR** key and take the proper action.

- When you exceed a 32-digit number (entry limit overflow):
Cancel the entry and re-enter a correct number.
- When you make an error in key operation:
Clear the error and try the entry again.
- When you make an entry beyond a programmed amount entry limit:
Check to see if the entered amount is correct. If it is correct, it can be rung up in the MGR mode.
Contact your manager.
- When an including-tax subtotal exceeds eight digits:
Delete the subtotal by touching the **CLEAR** key and touch a media key to finalize the transaction.

Sample Receipt

YOUR RECEIPT			
THANK YOU			
Date	15/12/99	123456	Machine no.
Consecutive no.	#1027	0001	Clerk code
Clerk name	JACK	11:02	Time
Item entry	PL000001	*1.20	
	2x 5.00		
	PL000003	*10.00	
	***TOTAL	*11.20	Sales total
	CASH	*12.00	Cash amount tendered
	CHANGE	*0.80	Change due

Function Key Description

■ Touch-panel keyboard

This POS terminal provides the following types of keyboards for various functions or modes.

- Main-1 (Home) keyboard
- Main-2 keyboard
- Main-3 keyboard
- Sub-1 keyboard
- Sub-2 keyboard
- Sub-3 keyboard
- Condiment-1 keyboard
- Condiment-2 keyboard
- Condiment-3 keyboard
- Menu-1 keyboard
- Menu-2 keyboard
- Menu-3 keyboard
- Function menu 1 keyboard (blank)
- Function menu 2 keyboard (blank)
- Function menu 3 keyboard
- Function menu 4 keyboard
- Function menu 5 keyboard
- Payment menu keyboard
- Bill separate/Bill total keyboard
- Drive thru keyboard
- PGM mode keyboard
- PGM COMMAND keyboard
- X/Z mode keyboard
- X/Z COMMAND keyboard
- Character keyboard

NOTE If you want to change the layout, consult your authorized SHARP dealer.

Transition of the keyboard

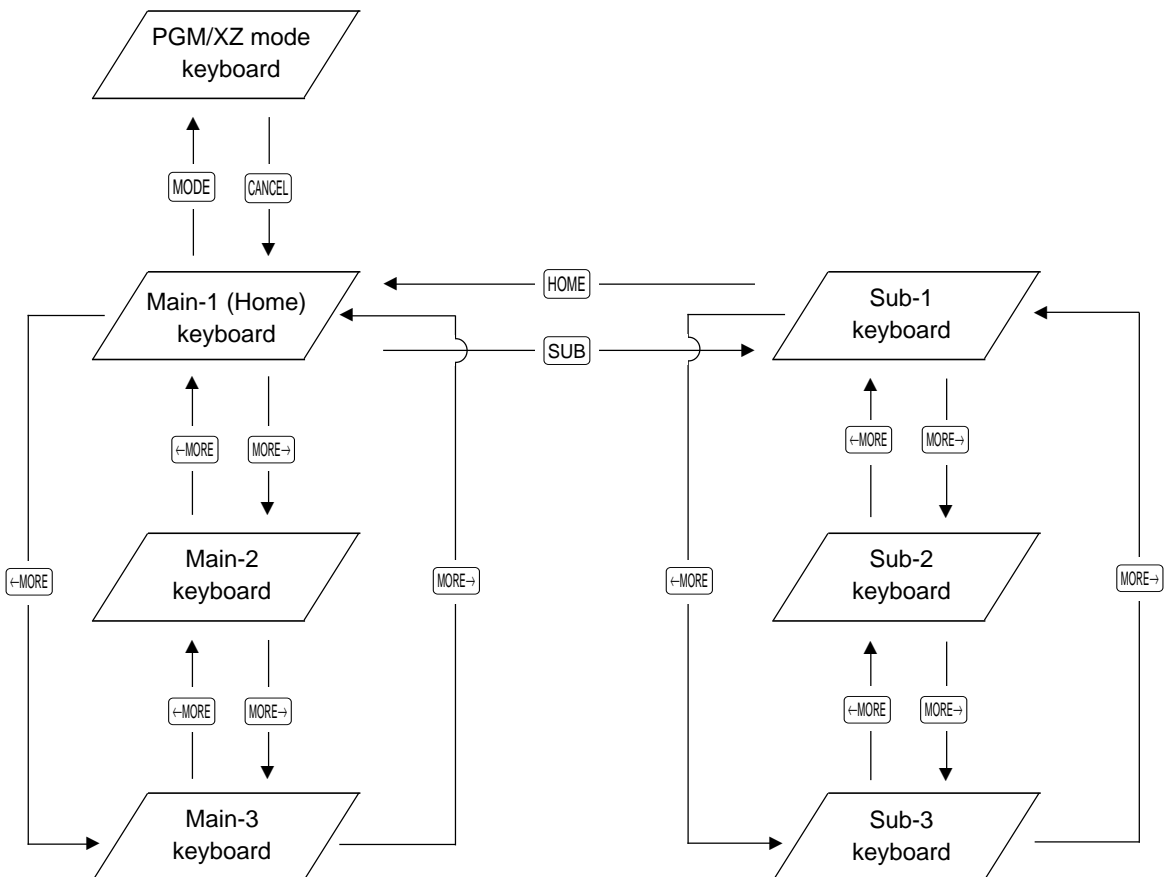

Keyboard layout (default)

- **Main-1 (Home) keyboard**

This keyboard appears when you touch the

HOME key.

					MODE	MENU01	MENU02	MENU03	MENU04
					VATSFT	MENU05		MENU06	
					L1	DPT.01	DPT.02	DPT.03	DPT.04
					L2	000001		000006	
MGR FU	7	8	9	ENTER	SUB	000002	000007		
VOID	4	5	6	OPEN T	TEXT1	000003	000008		
CANCEL	1	2	3	NBAL	AUTO	000004	000009		
CLEAR	0	←MORE	MORE→	NEXT C	PAYMEN	000005	000010		

- **Main-2 keyboard**

This keyboard appears when you touch the

MORE→ key on the Main-1 (Home) keyboard.

					HOME	MENU01	MENU02	MENU03	MENU04
					VATSFT	MENU05		MENU06	
					L1	DPT.01	DPT.02	DPT.03	DPT.04
					L2	000011		000016	
MGR FU	7	8	9	ENTER	TEXT1	000012	000017		
VOID	4	5	6	OPEN T	SUB	000013	000018		
CANCEL	1	2	3	NBAL	AUTO	000014	000019		
CLEAR	0	←MORE	MORE→	NEXT C	PAYMEN	000015	000020		

- **Main-3 keyboard**

This keyboard appears when you touch the

MORE→ key on the Main-2 keyboard.

					HOME	MENU01	MENU02	MENU03	MENU04
					VATSFT	MENU05		MENU06	
					L1	DPT.01	DPT.02	DPT.03	DPT.04
					L2	000021		000026	
MGR FU	7	8	9	ENTER	TEXT1	000022	000027		
VOID	4	5	6	OPEN T	SUB	000023	000028		
CANCEL	1	2	3	NBAL	AUTO	000024	000029		
CLEAR	0	←MORE	MORE→	NEXT C	PAYMEN	000025	000030		

• **Sub-1/Sub-2/Sub-3 keyboard**

The Sub-1 keyboard appears when you touch the **SUB** key.

The Sub-2 keyboard appears when you touch the **MORE→** key on the Sub-1 keyboard.

The Sub-3 keyboard appears when you touch the **MORE→** key on the Sub-2 keyboard.

MGR FU	7	8	9	ENTER	HOME	MENU10	MENU11	MENU12	MENU13
VOID	4	5	6	OPEN T	VATSFT	MENU14		MENU15	
CANCEL	1	2	3	NBAL	AUTO	000031		000037	
CLEAR	0	←MORE	MORE→	NEXT C	TEXT2	000032		000038	
					TEXT1	000033		000039	
						000034		000040	
					AUTO	000035		000041	
					PAYMEN	000036		000042	

• **Condiment-1 keyboard**

This keyboard appears when you touch the MENU key in a condiment PLU entry.

MGR FU	7	8	9	ENTER	HOME	MENU10	MENU11	MENU12	MENU13
VOID	4	5	6	OPEN T	VATSFT	MENU14		MENU15	
CANCEL	1	2	3	NBAL	TEXT2	KEY001		KEY004	
CLEAR	0	←MORE	MORE→	NEXT C	TEXT1	KEY002		KEY005	
					SUB	KEY003		KEY006	
					AUTO	KEY002		KEY005	
					PAYMEN	KEY003		KEY006	

• **Condiment-2 keyboard**

The Condiment-2 keyboard appears when you touch the **MORE→** key on the Condiment-1 keyboard.

MGR FU	7	8	9	ENTER	HOME	MENU10	MENU11	MENU12	MENU13
VOID	4	5	6	OPEN T	VATSFT	MENU14		MENU15	
CANCEL	1	2	3	NBAL	TEXT2	KEY007		KEY013	
CLEAR	0	←MORE	MORE→	NEXT C	TEXT1	KEY008		KEY014	
					TEXT1	KEY009		KEY015	
					SUB	KEY010		KEY016	
					AUTO	KEY011		KEY017	
					PAYMEN	KEY012		KEY018	

- Condiment-3 keyboard

The Condiment-3 keyboard appears when you touch the **MORE→** key on the Condiment-2 keyboard.

					HOME	MENU10	MENU11	MENU12	MENU13
					VATSFT	MENU14		MENU15	
						KEY019	KEY025		
					TEXT2	KEY020	KEY026		
MGR FU	7	8	9	ENTER	TEXT1	KEY021	KEY027		
VOID	4	5	6	OPEN T	SUB	KEY022	KEY028		
CANCEL	1	2	3	NBAL	AUTO	KEY023	KEY029		
CLEAR	0	←MORE	MORE→	NEXT C	PAYMEN	KEY024	KEY030		

- Menu-1/Menu-2/Menu-3 keyboard

The Menu-1 keyboard appears when you touch the **MENU01** thru **MENU09** key.

The Menu-2 keyboard appears when you touch the **MORE→** key on the Menu-1 keyboard.

The Menu-3 keyboard appears when you touch the **MORE→** key on the Menu-2 keyboard.

					HOME	MENU10	MENU11	MENU12	MENU13
					VATSFT	MENU14		MENU15	
						KEY001	KEY007		
					TEXT2	KEY002	KEY008		
MGR FU	7	8	9	ENTER	TEXT1	KEY003	KEY009		
VOID	4	5	6	OPEN T	SUB	KEY004	KEY010		
CANCEL	1	2	3	NBAL	AUTO	KEY005	KEY011		
CLEAR	0	←MORE	MORE→	NEXT C	PAYMEN	KEY006	KEY012		

- Function menu 3 (MGR FUNCTION) keyboard

This keyboard appears when you touch the **MGR FUNCTION** key.

					HOME	EMPL#	RCP.SW		
					VATSFT	CLK#	GCCOPY		
					BILL S	TIME-IN	MISC FUNCTIONS		
					BILL T	TIME-OUT	TRANS IN		
P1	7	8	9	ENTER		BREAK	TRANS OUT		
P2	4	5	6	OPEN THE TABLE		WASTE	VIP		
CANCEL	1	2	3	NBAL		RA	PO		
CLEAR	0	00	•	MGR#	D-THRU	RA2	PO2		

• **Bill separate/Bill total keyboard**

This keyboard appears when you touch the

BILL SEPARATE or BILL TRANS/TOTAL key.

7	8	9	0	CLEAR	ENTER	CR1	CR2	CR3	CHK
4	5	6	BILL S	OPEN T	AUTO		EXCHAN	EXCHAN	SUB TO
1	2	3	BILL T	NBAL	ENTERTAINMENT		NON CA	CASH T	CASH/T

• **Function menu 4 (TEXT1) keyboard**

This keyboard appears when you touch the

TEXT1 function menu key.

		HOME	VOID	TEXT14
		TEXT8		TEXT15
		TEXT9		TEXT16
		TEXT10		TEXT17
TEXT1	TEXT5	TEXT11		TEXT18
TEXT2	TEXT6	TEXT12		TEXT19
TEXT3	TEXT7	TEXT13		TEXT20
TEXT4	000001	000002	000003	000004

• **Function menu 5 (TEXT2) keyboard**

This keyboard appears when you touch the

TEXT2 function menu key.

		HOME	VOID	TEXT32
		TEXT25	TEXT33	
		TEXT26	TEXT34	
		TEXT27	TEXT35	
TEXT21	TEXT23	TEXT28		TEXT36
		TEXT29		TEXT37
TEXT22	TEXT24	TEXT30		TEXT38
		TEXT31		TEXT39

• **PGM COMMAND keyboard**

This keyboard appears when you touch the

PGM COMMAND key on the PGM mode keyboard.

	↑	AUTO10
	↓	AUTO11
	CANCEL	AUTO12
	CLEAR	AUTO13
		AUTO14
		AUTO15
		AUTO16
		AUTO17

• **X/Z COMMAND keyboard**

This keyboard appears when you touch the

X/Z COMMAND key on the X/Z mode keyboard.

	↑	AUTO18
	↓	AUTO19
	CANCEL	AUTO20
	CLEAR	AUTO21
		AUTO22
		AUTO23
		AUTO24
		AUTO25

• **Payment menu (PAYMENT) keyboard**

This keyboard appears when you touch the

PAYMENT key.

	HOME	DEPO	RA	PO			
	VATSFT	DEP.RF	EXCHANGE2				
	BILL S	%1	EXCHANGE1				
	BILL T	(-)1	CR3				
MGR FU	7	8	9	ENTER	H.T.	CR2	
VOID	4	5	6	OPEN THE TABLE	NON CASH TIP	CR1	
CANCEL	1	2	3	NBAL	AUTO	CASH TIP	CHK
CLEAR	0	00	•	ST VOI	ENTERT	SUB TOTAL	CASH/TL

• **PGM mode keyboard**

This keyboard appears when you select the PGM mode.

	↑	P UP	CLK#	MGR#	AUTO21	
	↓	P DOWN	EMPL#		AUTO22	
	CANCEL		LIST		AUTO23	
	CLEAR		MODE		AUTO24	
	7	8	9	X/QTY	AUTO25	
PREVIOUS		NEXT	4	5	6	PGM COMMAND
			1	2	3	ENTER
DELETE		CALL	0	00	•	CASH/TL

• **X/Z mode keyboard**

This keyboard appears when you select the X/Z mode.

	↑	P UP	CLK#	MGR#	AUTO21
	↓	P DOWN	EMPL#	VOID	AUTO22
	CANCEL		LIST		AUTO23
	CLEAR		MODE		AUTO24
	7	8	9	X/QTY	AUTO25
	4	5	6	XZ COMMAND	
	1	2	3	ENTER	
	0	00	•	CASH/TL	

• **Drive thru (D-THRU) keyboard**

This keyboard appears when you touch the  key.

HOME	CANCEL	CLEAR		WAIT	NEW CAR ENTRY
SUB	↑	P UP		RECALL	OPEN THE CAR
	↓	P DOWN		VATSFT	ENTER

• **Character keyboard**

This keyboard is used when you need to enter text data during PGM2 mode entries.

(Page 1)

1	2	3	4	5	6	7	8	9	0
Q	W	E	R	T	Y	U	I	O	P
A	S	D	F	G	H	J	K	L	B
Z	X	C	V	B	N	M	^	U	U
SHIFT					SHIFT				

INS	DEL	CALL	MODE	
PREU	NEXT	P DOWN	↑	P UP
CANCEL	BS	←	↓	→
CLEAR	DOUBLE	PAGE	CODE	
ENTER	—	—	&	
€	¼	½	¾	
à	â	é	ê	ù

1	2	3	4	5	6	7	8	9	0
q	w	e	r	t	y	u	i	o	p
a	s	d	f	g	h	j	k	l	B
z	x	c	v	b	n	m	ä	ö	ü
SHIFT					SHIFT				

INS	DEL	CALL	MODE	
PREU	NEXT	P DOWN	↑	P UP
CANCEL	BS	←	↓	→
CLEAR	DOUBLE	PAGE	CODE	
ENTER	—	—	&	
ç	ñ	ñ	*	.
à	â	é	ê	ù

(Page 2)

Å	ß	Á	Ã	Ç	Ð	È	É	Ê	Ë	Ø
à	â	ã	è	é	í	ì	î	ï	í	€
í	ì	ï	ÿ	ó	ù	ú	õ	ö	ø	
ó	ò	ó	ú	ù	ú	û	ü	ý	ÿ	
SHIFT					SHIFT					

INS	DEL	CALL	MODE	
PREU	NEXT	P DOWN	↑	P UP
CANCEL	BS	←	↓	→
CLEAR	DOUBLE	PAGE	CODE	
ENTER	—	+	÷	
<	>	¥	()
:	;	,	?	=

þ	Þ	ð	æ	f	µ	¶	ø	«	»
=	—	÷	—	—	—	—	—	—	—
—	—	—	—	—	—	—	—	—	—
—	—	—	—	—	—	—	—	—	—
SHIFT					SHIFT				

INS	DEL	CALL	MODE	
PREU	NEXT	P DOWN	↑	P UP
CANCEL	BS	←	↓	→
CLEAR	DOUBLE	PAGE	CODE	
ENTER	—	—	—	
±	√	§	f	c
#	§	×	⊗	⊗
—	—	—	—	—
—	—	—	—	—
—	—	—	—	—

■ Function keys list (default keyboard and labels)

Caption (default)	Function
HOME	Used to return to HOME keyboard.
CANCEL	Used to cancel your current operation or menu or return to previous menu.
CLEAR	Used to clear the entered data (amounts/rates/parameters, etc.) and the error state.
MODE	Used to go to MODE selection window or to return to HOME keyboard.
↑	Used to control the cursor (up arrow).
↓	Used to control the cursor (down arrow).
←MORE	Used to change the keyboard.
MORE→	Used to change the keyboard.
ENTER	Used to select item/menu or entered data.
SUB	Used to go to the sub-keyboard.
CASH/TL	Used to enter the direct cash/amount tendered operation, or to finalize the PGM job.
0 thru 9	Used to enter a numeric data (0 thru 9).
00	Used to enter a numeric data (00).
000	Used to enter a numeric data (000).
•	Used to enter a fractional part, or to toggle between two or more options.
X/QTY	Used to enter a quantity or times.
SUB TOTAL	Used to display subtotals.
P UP	Used to scroll page up.
P DOWN	Used to scroll page down.
BKSPC	Used to backs up the cursor for deleting the character or figure at the left of the cursor.
DELETE	Used to delete a character or figure in the cursor position.
DIF ST	Used to calculate the difference subtotal.
#	Used to enter a non-add code.
NS	Used to execute a no-sale function.
SCALE	Used to enter a weight for the item entry.
OPN TR	Used to enter the open tare.
PLU	Used to enter a PLU/subdepartment from the list by using a code.
GCCOPY	Used to take a copy of guest check.
VP	Used to perform the validation print.
SLIP	Used to print the slip.
RCPT	Used to print the receipt after transaction.
VOID	Used to void a last item, or used for the cursor void function.
ST VOID	Used to void an entire transaction (subtotal void).
REFUND	Used to enter the refund item.
RETURN	Used to enter the returned item
OPEN THE TABLE	Used to lookup the guest check.
OPEN THE CAR	Used to lookup the guest check (for drive-thru function).
NEW CAR ENTRY	Used to open a new guest check (for drive-thru function).
NBAL	Used to calculate a new balance.

Caption (default)	Function
FINAL	Used to finalize the guest check temporarily (with the tax calculation).
H.T.	Used to perform the hotell transfer function.
RA and RA2	Used to enter the received-on-account (RA 1 and 2).
PO and PO2	Used to enter the paid-out (PO 1 and 2).
1/2	Used to enter half penny.
AMOUNT	Used to enter an item amount.
PINT	Used to perform the pint entry.
VATSFT	Used to perform the VAT shift entry.
VIP	Used to enter the vip sale.
GUEST#	Used to enter the guest number.
DEPO	Used to enter the deposit.
DEP.RF	Used to refund the deposit.
BILL TRANS/TOTAL	Used to perform the bill transfer/bill totalizing function.
BILL SEPARATE	Used to perform the bill separate function.
TRANS OUT	Used to enter the transfer-out function.
TRANS IN	Used to enter the transfer-in function.
C.BILL	Used to print the bill.
GUEST CHECK RCPT	Used to print the details of the guest check on the receipt.
CASH TIP	Used to enter the cash tip.
NON CASH TIP	Used to enter the non-cash tip.
TIP PAID	Used to execute the tip paid function.
WITH	Used to add a PLU to the set PLU.
W/O	Used to delete a linked PLU from the set PLU.
CHK PR	Used to print the check.
MGR#	Used to enter the manager code.
EMPL#	Used to enter the employee code.
REPEAT	Used to repeat a last item entry.
PERSN#	Used to enter the person number.
I.PAY	Individual payment key
MISC FUNCTIONS	Used to display the miscellaneous function menu.
RCP.SW	Used to switch the receipt printing state (ON/OFF).
TIME-IN	Used to enter time-in operation.
TIME-OUT	Used to enter time-out operation.
BREAK	Break key
D.SFT1 thru D.SFT4	Used to change the department code for a PLU (department shift 1 thru 4).
L1 thru L10	Used to shift the direct PLU key level (level 1 thru 10).
P1 thru P7	Used to shift the PLU price level (level 1 thru 7).
FUNCTION MENU1	Used to go to the function menu 1 keyboard.
FUNCTION MENU2	Used to go to the function menu 2 keyboard.
MGR FUNCTION	Used to go to the function menu 3 keyboard (the manager function keyboard).
TEXT1	Used to go to the function menu 4 keyboard (text entry).
TEXT2	Used to go to the function menu 5 keyboard (text entry).



Caption (default)	Function
PAYMENT	Used to go to the payment menu keyboard.
WAIT	Used to shift the corresponding guest check to the wait mode (for drive-thru).
RECALL	Used to re-call the corresponding guest check to the registration mode (for drive-thru).
WASTE	Used to enter/release the WASTE mode.
NEXT CONDIMENT	Used to skip the next table of condiments.
D-THRU	Used to go to the drive-thru menu keyboard (guest check entry for drive-thru).
ENTERTAINMENT	Used to print the entertainment bill.
CASH2	Used to enter the cash 2 payment.
CHK thru CHK4	Used to enter the check payment (check 1 thru 4).
CR1 thru CR8	Used to enter the credit sale (credit 1 thru 8).
EXCHANGE1 to EXCHANGE9	Used to creates a subtotal in foreign currency (exchange 1 thru 9).
%1 thru %9	Used to enter the percent calculation (percent 1 thru 9).
(-)1 thru (-)9	Used to execute the discount entry (discount 1 thru 9).
VAT	Used to enter the manual VAT.
CLK#	Used to enter the clerk code.
CLK01 thru CLK10	Used to assign the clerk.
AUTO to AUTO25	Used to ente the automatic sequencing (auto 1 thru auto 25).
MENU01 to MENU50	Used to go to the direct PLU menu (menu 1 thru 50).
TEXT#	Used to enter the text number to print the free text.
TEXT1 thru TEXT40	Used to print the free text (free text 1 thru 40).



How to Use the Touch Panel

Operations can be performed by touching corresponding key(s) and/or selecting option(s) or item(s) in the window.

NOTE Do not use extreme force when touching the display or the keyboard.
Do not use any sharp or pointed objects, and avoid using your fingernails to touch them.

■ Cursor control by touching option(s) or item(s) in the window

You can select an option or item by using the ,  and  keys.

To move the cursor, touch the  or  key. To select an option or item, touch the  key.

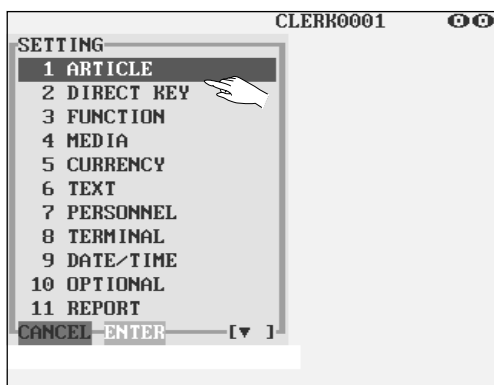

You can also select option(s) or item(s) by touching corresponding line(s) in the window as follows:

• In the PGM/XZ mode

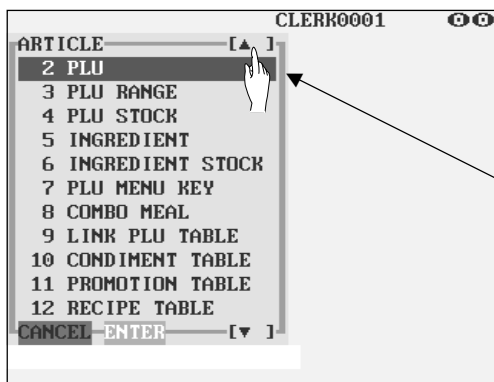

1. To select an option, touch a corresponding line.
(When you release the touch panel, the option will be selected.)



2. To scroll up or down the window, touch the bottom or top of the frame ( or ).

To scroll down the window

• In the REG mode

CLERK0001		[J] [▼]
1 PL000001	1.10	
1 PL000002	2.50	
1 PL000003	1.75	
1 PL000004	3.50	
1 PL000010	2.00	
1 PL000009	1.80	
1 PL000008	5.50	
***TOTAL		51.70
1 PL000012	6.20	
P1L01		

1. To select item(s), touch corresponding line(s).
(If you touch a selected item again, it will be deselected.)

To select items

CLERK0001		[▲] [J]
1 PL000005	2.80	
1 PL000006	7.20	
1 PL000007	1.25	
1 PL000008	5.20	
1 PL000009	2.20	
1 PL000010	3.10	
1 PL000011	5.60	
***TOTAL		51.70
1 PL000012	6.20	
P1L01		

2. Dragging:

Touch a corresponding line, and drag the cursor to a target line.
(The touched item will be selected.)

Dragging

CLERK0001		[▲] [J]
1 PL000003	1.75	
1 PL000004	3.50	
1 PL000010	2.00	
1 PL000009	1.80	
1 PL000008	5.50	
1 PL000005	2.80	
1 PL000006	7.20	
***TOTAL		51.70
1 PL000012	6.20	
P1L01		

3. To scroll up or down the window, touch the bottom or top of the frame (▼ or ▲).

(The selected item will remain unchanged.)

To scroll down the window

To scroll up the window

NOTE

- To deselect all of selected items, touch the [CANCEL] key.
- To deselect a selected item, touch a corresponding line again.
- To display the journal image during the transaction, touch the [J].

1 PL000009	2.20	
1 PL000010	3.10	
1 PL000011	5.60	
***TOTAL		51.70
1 PL000012	6.20	
P1L01		

Clerk Assignment

Clerks can be assigned on four systems: real clerk key, clerk code entry, clerk entry key and WMF clerk key systems. Contact your authorized SHARP dealer for their selection.

① Real clerk key system (factory-set)

If you select this system, clerks can be assigned by inserting corresponding real clerk keys. Any registration cannot be performed unless a real clerk key is inserted.

② Clerk code entry system

If you select this system, clerks can be assigned by entering his or her clerk code in advance.

Procedure

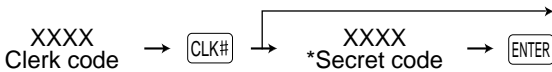

* The pop-up window for entering a secret code will appear after touching the [CLK#] key.

If the item entry is made when the clerk have been signed off, the clerk entry pad will be opened in the window and the clerk entry will be compelled.

The sign-off operation can be performed by using the following procedure in the REG or MGR mode:

To sign off a clerk: → [CLK#]

③ Clerk entry key system

If you select this system, clerks can be assigned by touching corresponding clerk keys on the keyboard.

④ WMF clerk key system

If you select this system, clerks can be assigned by inserting WMF clerk keys.

NOTE

If another clerk is signed on while a clerk is signed on, the latter will automatically be signed off.

Item Selection from the Menu Window

Your POS terminal allows you to select functions from a menu window. For example, if you want to enter an item for Paid-out 1, select the option "PO" from the "MISC FUNCTIONS" menu instead of touching the [PO] key.

The menu window can be opened as follows:

• Miscellaneous menu window

[MISC FUNCTIONS] →

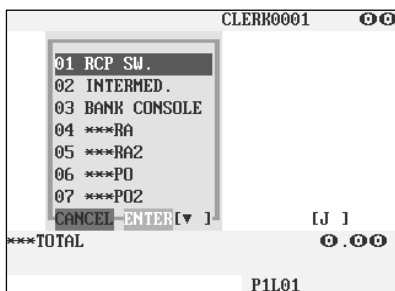

Starting Cash Memory Entry

If you enter the amount of the cash for the change due (starting cash) in the drawer before starting entry operations, you can discriminate that amount from the sales amount when reports are generated. Your POS terminal can be programmed to enforce the entry of starting cash into memory. For details, contact your authorized SHARP dealer.

Procedure

Select the OP X/Z mode and perform the following operation:

Select SCM(+) or SCM(-) → XXXXXXXX → ENTER
Amount
(max. 8 digits)

15/12/99	[0001]123456
#1032	11:09 JACK
CLK#0001	JACK
	*0.00
SCM (+)	*33.00
SCM TTL	*33.00

Item Entries

Single item entries

Department entries

Enter a unit price and touch a department key.

If you use a programmed unit price, touch a department key only.

Procedure

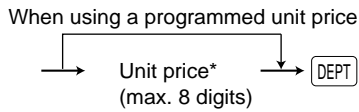

*Less than the programmed upper limit amount

Example

Key Operation

1200 [6]
[7]
[CASH/TL]

Display

CLERK0001	
1 DPT.06	12.00
1 DPT.07	2.50
CASH	14.50
[J]	
***TOTAL	14.50
CASH	14.50
P1L01	

NOTE

When those departments for which the unit price has been programmed as zero (0) are entered with the preset unit price, only the sales quantity is added.

Direct PLU entries (PLU entries and subdepartment entries)

Follow this procedure:

Procedure

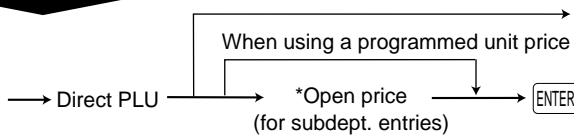

*Less than the programmed upper limit amount

Example

Key Operation

[000010]
[CASH/TL]

Display

CLERK0001	
1 PL000010	12.75
CASH	12.75
[J]	
***TOTAL	12.75
CASH	12.75
P1L01	

PLU menu-based entries (PLU entries and subdepartment entries)

Follow this procedure:

Procedure

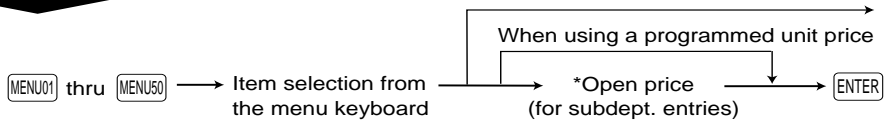

*Less than the programmed upper limit amount

Example

Key Operation	Display
<div style="display: flex; justify-content: center; align-items: center; gap: 10px;"> <div style="border: 1px solid black; padding: 2px;">MENU01</div> <div style="font-size: 2em;">}</div> <div style="text-align: left;"> Select PLU code 15 from the menu keyboard. </div> <div style="border: 1px solid black; padding: 2px;">MENU01</div> </div> <div style="display: flex; justify-content: center; align-items: center; margin-top: 10px;"> <div style="border: 1px solid black; padding: 2px;">CASH/TL</div> </div>	

PLU code entries (PLU entries and subdepartment entries)

Follow this procedure:

Procedure

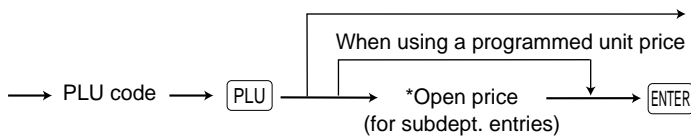

*Less than the programmed upper limit amount

Example

Key Operation	Display
<div style="display: flex; justify-content: center; align-items: center; gap: 10px;"> <div style="font-size: 2em;">60</div> <div style="border: 1px solid black; padding: 2px;">PLU</div> <div style="font-size: 2em;">750</div> <div style="border: 1px solid black; padding: 2px;">PLU</div> <div style="border: 1px solid black; padding: 2px;">ENTER</div> </div> <div style="display: flex; justify-content: center; align-items: center; margin-top: 10px;"> <div style="font-size: 2em;">2</div> <div style="border: 1px solid black; padding: 2px;">PLU</div> <div style="border: 1px solid black; padding: 2px;">ENTER</div> <div style="border: 1px solid black; padding: 2px;">CASH/TL</div> </div>	

NOTE

When those PLUs for which the unit price has been programmed as zero (0) are entered, only the sales quantity is added.

Repeat entries

You can use this function for repetitive entries of the same items.

Example

Key Operation	Display
Repeated department entry	
Repeated PLU entry (indirect)	
Repeated PLU entry (direct)	
Repeated subdepartment entry	

NOTE

You can use the **REPEAT** key for repeat entries instead of the department key, **PLU** key, or direct PLU key.

Multiplication entries

Use this feature when you need to enter two or more the same items.

This feature helps you when you sell a large quantity of items or need to enter quantities that contain decimals.

Procedure

FF method (for speedy entries in the fast food restaurants)

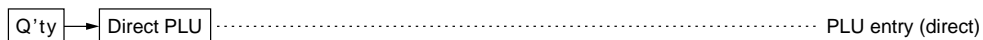

Normal method

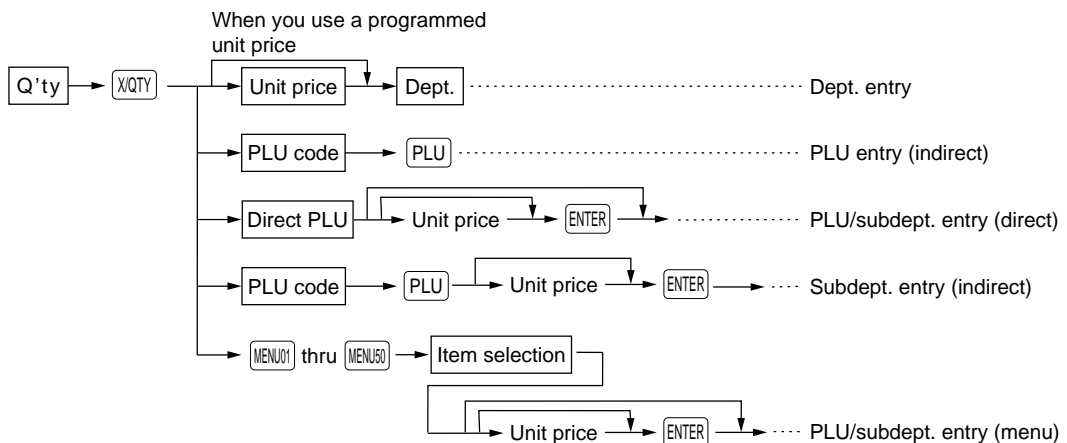

- Q'ty: Up to four-digit integer + three-digit decimal
- Unit price: Less than a programmed upper limit
- Q'ty x unit price: Up to seven digits

Example

Key Operation

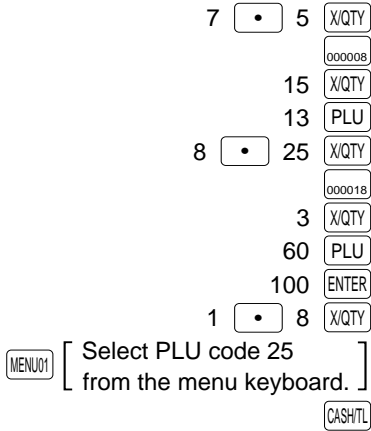

Display

CLERK0001		[▲]
15	PL000013	7.50
8.250x	0.80	
	PL000018	6.60
3	PL000060	3.00
1.800x	0.60	
	PL000025	1.08
CASH		23.43
		[J]
***TOTAL		23.43
CASH	23.43	
P1L01		

Split-pricing entries

You will use this function when your customer wants to purchase more or less than the base quantity of a loose item.

Procedure

FF method

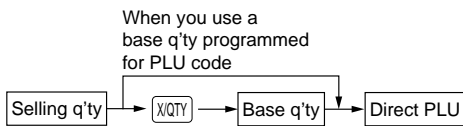

Normal method

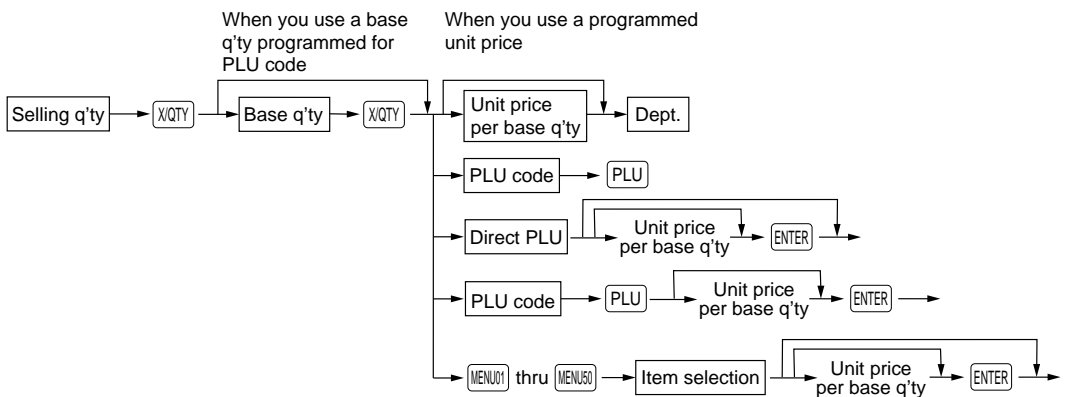

- Selling quantity: Up to four-digit integer + three-digit decimal
- Base quantity: (Programmed)

Example

Key Operation	Display
10 [X/QTY] 7 [X/QTY]	CLERK0001 00
7 [PLU]	10x 7/ 6.00
600 [ENTER]	PL000007 8.58
5 [X/QTY] 8 [X/QTY]	5x 8/ 2.00
35 [PLU]	PL000035 1.25
3 [X/QTY] 5 [X/QTY]	3x 5/ 8.00
[MENU01] [Select PLU code 50 from the menu keyboard.]	PL000050 4.80
[CASH/TL]	CASH 14.63
	[J 1] 14.63
	***TOTAL 14.63
	CASH 14.63 P1L01

Single item cash sale (SICS)/single item finalize (SIF) entries

The operation is the same as that for normal department/PLU entries. The SICS and SIF functions can be available only when the receipt type is "addition receipt type."

SICS entries

- This function is useful when a sale is for only one item and is for cash; such as a pack of cigarettes. This function is applicable only to those departments that have been set for SICS or to their associated PLUs or subdepartments.
- The transaction is finalized and the drawer opens as soon as you touch the department key, [PLU] key or the direct PLU key.

Example

Key Operation	Display
250	CLERK0001 00
For finishing the transaction → [9]	1 DPT.09 2.50
	CASH 2.50
	[J 1]
	***TOTAL 2.50
	CASH 2.50 P1L01

NOTE

If a ring-up to a department or PLU/subdepartment set for SICS follows the ones to departments or PLUs/subdepartments not set for SICS, it does not finalize and results in a normal sale.

SIF entries

- If a ring-up to a department or PLU/subdepartment set for SIF follows the ones to departments or PLUs/subdepartments not set for SIF, the transaction is finalized immediately as a cash sale.
- Like the SICS function, this function is available for single-item cash settlement.

Example

Key Operation

1745
 1500
 For finishing the transaction →

Display

CLERK0001	
1 DPT. 08	17.45
1 DPT. 09	15.00
CASH	32.45
[J]	
***TOTAL	32.45
CASH	32.45
P1L01	

Scale entries

You have a choice of either the manual or automatic method for scale entry.

If the first method is chosen, the clerk needs to enter the reading of the scale manually. If the second one is chosen, the weight is automatically read from the connected scale (option) and appears in the POS terminal display. If you need auto scale entries, contact your authorized SHARP dealer.

Manual scale entries

Procedure

FF method

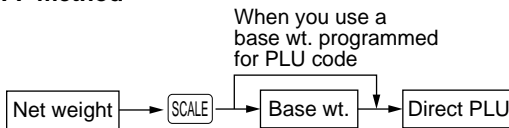

Normal method

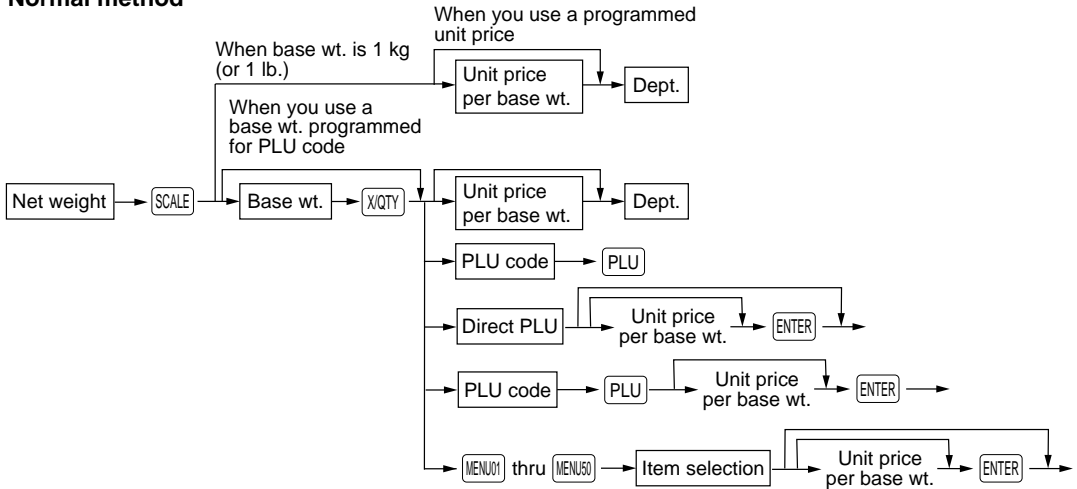

- Net weight: Up to 5 digits (integer + decimal)
- Base weight: Up to 2 digits (integer)

NOTE

The net weight is automatically calculated using the programmed tare weight.

Example

Key Operation

3 [SCALE] 000010
[CASH/TL]

Display

```

CLERK0001
3.000kg x 12.75 /kg
  PL000010          38.25
CASH                38.25

[J ]
***TOTAL          38.25
CASH                38.25
P1L01
  
```

Auto scale entries

Procedure

FF method

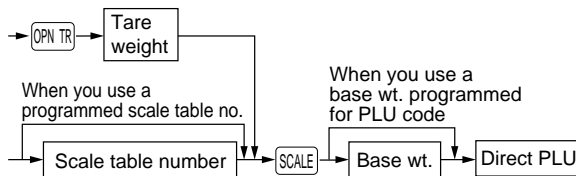

Normal method

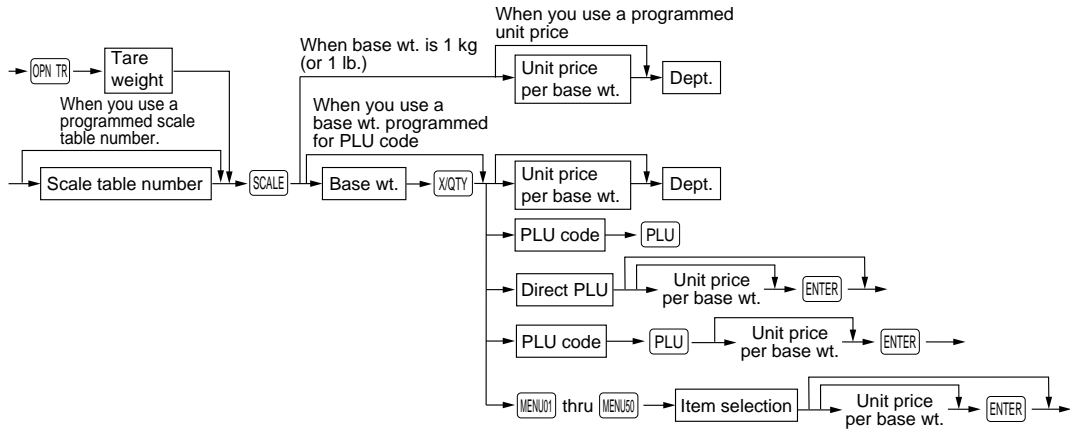

- Tare weight: Up to 4 digits (integer + decimal)
- Net weight: Up to 5 digits (integer + decimal)
- Base weight: Up to 2 digits (integer)
- Scale table number: 1 to 9

NOTE

- The POS terminal can be programmed with up to nine scale tables and allows different tares to be assigned to them.
- When the [SCALE] key is touched, the net weight is automatically read from the connected scale (option) and appears in the POS terminal display.
- When the PLU is programmed for "Compulsory scale entry," it is not necessary to touch the [SCALE] key.
- To issue a receipt which shows only a tare weight, touch [OPN TR], enter a tare weight, then touch [SCALE] and [CASH/TL].

Example

Key Operation

SCALE 8 PLU
 200 ENTER
 SCALE 000010
 CASH/TL

Display

```

CLERK0001
3.000kg x 2.00 /kg
  PL000008 6.00
5.000kg x 12.75 /kg
  PL000010 63.75
CASH 69.75

[J ]
***TOTAL 69.75
CASH 69.75
P1L01
  
```

■ Non-turnover sales

This function is used to perform transaction other than ordinary sales (turnover) as is the case when cigarettes or bouquets are ordered in a restaurant and the like. In this case, a clerk once pays the bill and demands together with other payment.

It is performed by entering a department belonging to the non-turnover group or PLU belonging to the department. If you need this function, contact your authorized SHARP dealer.

Example

Key Operation

2700 4
 Non-turnover sale → 200 5
 CASH/TL

Display

```

CLERK0001
1 DPT.04 27.00
1 DPT.05 2.00
NON-TURN 2.00
CASH 29.00

[J ]
***TOTAL 29.00
CASH 29.00
P1L01
  
```

Special Entries for PLUs

■ Promotion (normal selling) function

This function is convenient for matching several PLU items and selling them in a lump (e.g. value meal, etc.). Operation is the same as for normal PLUs. The promotion table consists of the discount amount, the trip level for discount (satisfying count of entered item), and the text for a table. One table can be assigned max. 5 kind of items. If the transaction that the promotion item is registered is finalized, the sales amount may be discounted as follows:

Promotion items of table no. 1: Item-A (*2.30), Item-B (*3.10), Item-C (*2.50)
 Trip level for discount: 3
 Discount amount: *1.00

<Sale 1>		<Sale 2>	
Item-A	*2.30	Item-C	*2.50
Item-B	*3.10	Item-C	*2.50
Item-C	*2.50	Item-C	*2.50
<hr/>		<hr/>	
Subtotal	*7.90	Subtotal	*7.50
Discount	-1.00	Discount	-1.00
<hr/>		<hr/>	
Total	*6.90	Total	*6.50

Example

In the case of <Sale 1> above

Key Operation	
Treated as *2.30 item →	<input type="text" value="000010"/>
Treated as *3.10 item →	<input type="text" value="000011"/>
Treated as *2.50 item →	<input type="text" value="000012"/>
	<input type="text" value="CASH7L"/>

Display	
CLERR0001	
1 PL000010	2.30
1 PL000011	3.10
1 PL000012	2.50
1 VALUE MEAL	-1.00
CASH	6.90
[J]	
***TOTAL	6.90
CASH	6.90
P1L01	

Promotion discount

■ Promotion (set selling) function

This function is convenient for matching several PLU items and selling them in a lump (e.g. value meal etc.). Operation is the same as for normal PLUs. The promotion table consists of the text for a table, the discount amount, and the trip level for discount (satisfying count of entered item) for each PLU. One table can be assigned max. 5 kind of items. If the transaction is finalized under the following condition, the sales amount may be discounted as follows:

- The total quantity of the sales meet the trip level which is programmed in the promotion table.
- Items of the sales are programmed in the promotion table.

Promotion items of table no. 2: Item-A (*3.00), Item-B (*2.50), Item-C (*2.10)
 Trip level for each item: Item-A (1), Item-B (1), Item-C (2)
 Discount amount: *4.00

<Sale 1>	
Item-A	*3.00
Item-B	*2.50
Item-C	*2.10
Item-C	*2.10
<hr/>	
Subtotal	*9.70
Discount	-4.00
Total	*5.70

<Sale 2>	
Item-A	*3.00
Item-A	*3.00
Item-B	*2.50
Item-C	*2.10
<hr/>	
Subtotal	*10.60
Discount	-0.00
Total	*10.60

Discount is not allowed.
 (Q'ty of the item-C should be two.)

Example

In the case of <Sale 1> above

Key Operation

- Treated as *3.00 item →
- Treated as *2.50 item →
- Treated as *2.10 item →
- Treated as *2.10 item →
-

Display

CLERK0001	
1 PL000010	3.00
1 PL000011	2.50
2 PL000012	4.20
1 VALUE MEAL	-4.00
CASH	5.70
<hr/>	
***TOTAL	5.70
CASH	5.70
P1L01	

Promotion discount

■ Link PLU entries

Operation is the same as that for normal PLU entries. When a link PLU is entered, the linked PLU's amount is included and the linked PLU's label is printed automatically. Only the 1st-ranking PLU is affected by the VAT shift key. The percent calculation is in effect for the amount of the 1st-ranking PLU.

Example

Key Operation	Display																														
<div style="border: 1px solid black; padding: 2px; width: fit-content; margin: 0 auto;">000021</div> <div style="border: 1px solid black; padding: 2px; width: fit-content; margin: 0 auto;">CASH TL</div>	<div style="border: 1px solid black; padding: 5px;"> <table style="width: 100%; border-collapse: collapse;"> <tr> <td colspan="2" style="text-align: right;">CLERK0001</td> <td style="text-align: right;">00</td> </tr> <tr> <td style="width: 5%;">1</td> <td style="width: 85%;">PL000021</td> <td style="text-align: right;">5.50</td> </tr> <tr> <td>1</td> <td>PL000025</td> <td style="text-align: right;">2.85</td> </tr> <tr> <td>1</td> <td>PL000026</td> <td style="text-align: right;">2.00</td> </tr> <tr> <td>1</td> <td>PL000027</td> <td style="text-align: right;">8.00</td> </tr> <tr> <td></td> <td>CASH</td> <td style="text-align: right;">18.35</td> </tr> <tr> <td></td> <td></td> <td style="text-align: right;">[J]</td> </tr> <tr> <td colspan="2">***TOTAL</td> <td style="text-align: right;">18.35</td> </tr> <tr> <td>CASH</td> <td style="text-align: right;">18.35</td> <td></td> </tr> <tr> <td></td> <td style="text-align: right;">P1L01</td> <td></td> </tr> </table> </div>	CLERK0001		00	1	PL000021	5.50	1	PL000025	2.85	1	PL000026	2.00	1	PL000027	8.00		CASH	18.35			[J]	***TOTAL		18.35	CASH	18.35			P1L01	
CLERK0001		00																													
1	PL000021	5.50																													
1	PL000025	2.85																													
1	PL000026	2.00																													
1	PL000027	8.00																													
	CASH	18.35																													
		[J]																													
***TOTAL		18.35																													
CASH	18.35																														
	P1L01																														

■ Combo meal entries

Operation is the same as that for normal PLU entries.

When a combo meal is entered with the Combo PLU, the labels of those PLUs linked to the Combo PLU are printed automatically. The sum of all adjusted prices (of those PLUs linked to the Combo PLU) becomes the "combo meal" price setting.

Example

Key Operation	Display																											
<div style="border: 1px solid black; padding: 2px; width: fit-content; margin: 0 auto;">000020</div> <div style="border: 1px solid black; padding: 2px; width: fit-content; margin: 0 auto;">CASH TL</div>	<div style="border: 1px solid black; padding: 5px;"> <table style="width: 100%; border-collapse: collapse;"> <tr> <td colspan="2" style="text-align: right;">CLERK0001</td> <td style="text-align: right;">00</td> </tr> <tr> <td style="width: 5%;">1</td> <td style="width: 85%;">PL000020</td> <td style="text-align: right;">3.30</td> </tr> <tr> <td></td> <td>PL000003</td> <td></td> </tr> <tr> <td></td> <td>PL000005</td> <td></td> </tr> <tr> <td></td> <td>CASH</td> <td style="text-align: right;">3.30</td> </tr> <tr> <td></td> <td></td> <td style="text-align: right;">[J]</td> </tr> <tr> <td colspan="2">***TOTAL</td> <td style="text-align: right;">3.30</td> </tr> <tr> <td>CASH</td> <td style="text-align: right;">3.30</td> <td></td> </tr> <tr> <td></td> <td style="text-align: right;">P1L01</td> <td></td> </tr> </table> </div>	CLERK0001		00	1	PL000020	3.30		PL000003			PL000005			CASH	3.30			[J]	***TOTAL		3.30	CASH	3.30			P1L01	
CLERK0001		00																										
1	PL000020	3.30																										
	PL000003																											
	PL000005																											
	CASH	3.30																										
		[J]																										
***TOTAL		3.30																										
CASH	3.30																											
	P1L01																											

NOTE

When combo meal is registered, q'ty totalizer of the combo PLU and amount totalizer of each PLU are updated.

■ With/without entries

A maximum of 20 linked PLUs of the combo PLU can be modified (added or deleted) temporarily by using **W/O** and **WITH** keys.

With: To add a PLU to the combo PLU.

Without: To delete a linked PLU from the combo PLU.

Procedure

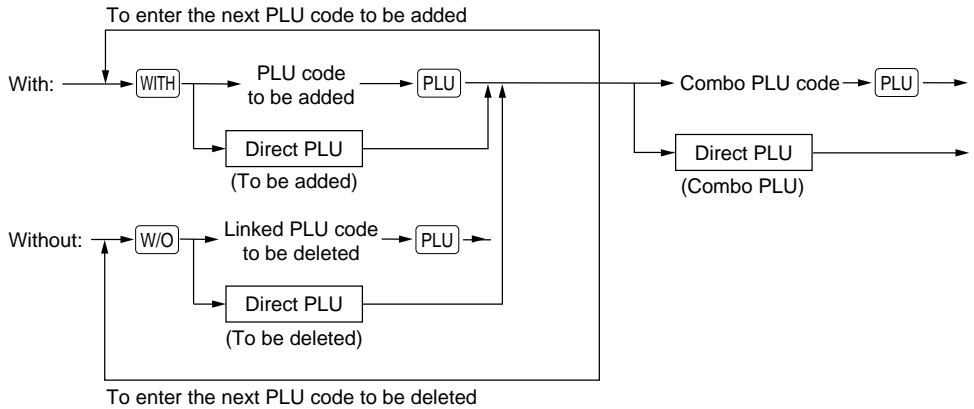

NOTE

The "with" and "without" operation is allowed a total of 20 times.

Example

Key Operation

W/O	16	PLU
WITH	17	PLU
	22	PLU
		CASH/TL

Display

CLERK0001		ⓄⓄ
1	PL000022	2.45
	PL000007	
	PL000017	
CASH		2.45
		[J]
***TOTAL		2.45
CASH	2.45	
		P1L01

■ PLU level shift (for direct PLUs)

This shift can double or triple the number of direct PLUs on your POS terminal without adding additional direct PLU keys. You can use direct PLUs in ten levels by utilizing the PLU level shift keys **L1** thru **L10**. Level key shifts the PLU level from the other nine to the required level. (The normal level is the level 1.) You must program your machine in the PGM mode to select one of the two PLU level shift modes — automatic return mode* and lock shift mode** — and decide whether to allow PLU level shift in both the REG and MGR modes or in the MGR mode alone.

* The automatic return mode automatically shifts the PLU level back to level 1 after touching a direct PLU key or finalizing each transaction.

** The lock shift mode holds the current PLU level until a PLU level shift key is touched.

Automatic return mode (for PLU levels)

If your terminal has been programmed for PLU level in the automatic return mode, touch a desired PLU level shift key before a numeric entry.

Procedure

(Returning every item entry)

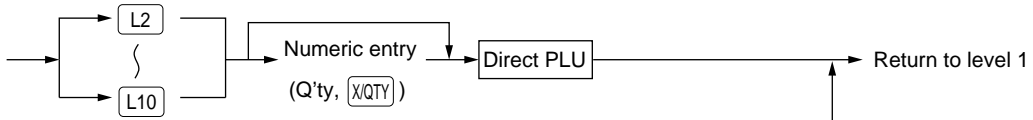

(Returning every transaction)

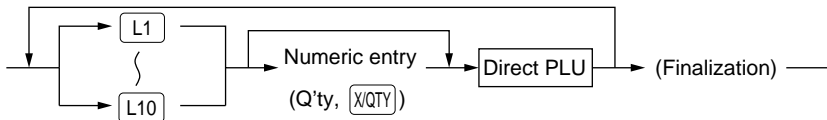

NOTE

When you use the FF method, you need not touch the **X/QTY** key for multiplication entries.

Lock shift mode (for PLU levels)

If your terminal has been programmed for PLU level in the lock shift mode, touch a desired PLU level shift key before a numeric entry.

Procedure

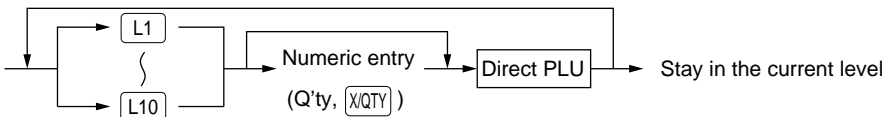

NOTE

- If you select the automatic return mode (Returning every item entry), it is not necessary to use the **L1** key on the keyboard.
- When you use the FF method, you need not touch the **X/QTY** key for multiplication entries.

Example

Level 1 : PLU code 1, PLU code 2

Level 2 : PLU code 101, PLU code 102

- When your POS terminal has been programmed for the automatic return mode:

Key Operation	Display																
<div style="display: flex; flex-direction: column; align-items: center;"> <div style="border: 1px solid black; padding: 2px; margin-bottom: 5px;">L2</div> <div style="border: 1px solid black; padding: 2px; margin-bottom: 5px;">000001</div> <div style="border: 1px solid black; padding: 2px; margin-bottom: 5px;">000101</div> <div style="border: 1px solid black; padding: 2px; margin-bottom: 5px;">000002</div> <div style="border: 1px solid black; padding: 2px;">CASH/TL</div> </div>	<div style="border: 1px solid black; padding: 5px;"> <p style="text-align: right;">CLERK0001 00</p> <table style="width: 100%; border-collapse: collapse;"> <tr> <td style="width: 80%;">1 PL000001</td> <td style="text-align: right;">1.10</td> </tr> <tr> <td>1 PL000101</td> <td style="text-align: right;">5.10</td> </tr> <tr> <td>1 PL000002</td> <td style="text-align: right;">1.50</td> </tr> <tr> <td>CASH</td> <td style="text-align: right;">7.70</td> </tr> <tr> <td colspan="2" style="text-align: right;">[J 1</td> </tr> <tr> <td>***TOTAL</td> <td style="text-align: right;">7.70</td> </tr> <tr> <td>CASH</td> <td style="text-align: right;">7.70</td> </tr> <tr> <td colspan="2" style="text-align: right;">P1L01</td> </tr> </table> </div>	1 PL000001	1.10	1 PL000101	5.10	1 PL000002	1.50	CASH	7.70	[J 1		***TOTAL	7.70	CASH	7.70	P1L01	
1 PL000001	1.10																
1 PL000101	5.10																
1 PL000002	1.50																
CASH	7.70																
[J 1																	
***TOTAL	7.70																
CASH	7.70																
P1L01																	

- When your POS terminal has been programmed for the lock shift mode:

Key Operation	Display																
<div style="display: flex; flex-direction: column; align-items: center;"> <div style="border: 1px solid black; padding: 2px; margin-bottom: 5px;">L1</div> <div style="border: 1px solid black; padding: 2px; margin-bottom: 5px;">L2</div> <div style="border: 1px solid black; padding: 2px; margin-bottom: 5px;">000001</div> <div style="border: 1px solid black; padding: 2px; margin-bottom: 5px;">000101</div> <div style="border: 1px solid black; padding: 2px; margin-bottom: 5px;">000102</div> <div style="border: 1px solid black; padding: 2px;">CASH/TL</div> </div>	<div style="border: 1px solid black; padding: 5px;"> <p style="text-align: right;">CLERK0001 00</p> <table style="width: 100%; border-collapse: collapse;"> <tr> <td style="width: 80%;">1 PL000001</td> <td style="text-align: right;">1.10</td> </tr> <tr> <td>1 PL000101</td> <td style="text-align: right;">5.10</td> </tr> <tr> <td>1 PL000102</td> <td style="text-align: right;">2.10</td> </tr> <tr> <td>CASH</td> <td style="text-align: right;">8.30</td> </tr> <tr> <td colspan="2" style="text-align: right;">[J 1</td> </tr> <tr> <td>***TOTAL</td> <td style="text-align: right;">8.30</td> </tr> <tr> <td>CASH</td> <td style="text-align: right;">8.30</td> </tr> <tr> <td colspan="2" style="text-align: right;">P1L02</td> </tr> </table> </div>	1 PL000001	1.10	1 PL000101	5.10	1 PL000102	2.10	CASH	8.30	[J 1		***TOTAL	8.30	CASH	8.30	P1L02	
1 PL000001	1.10																
1 PL000101	5.10																
1 PL000102	2.10																
CASH	8.30																
[J 1																	
***TOTAL	8.30																
CASH	8.30																
P1L02																	

■ PLU price level shift

Seven different price levels can be programmed for each PLU.

The price levels can be changed for PLU registrations.

You can shift the PLU price level (level 1 thru 7) by utilizing the PLU price shift keys **P1** thru **P7**.

You must program a PLU price level shift mode (i.e. automatic return mode* or lock shift mode**) and the operating modes to be used for PLU price level shift (i.e. both RED and MGR modes or MGR mode alone).

* The automatic return mode automatically shifts the PLU price level back to level 1 after a PLU entry. You can select whether the PLU price level should return each time you enter one item or each time you finalize one transaction.

** The lock shift mode holds the current PLU price level until touching a price level shift key.

Automatic return mode (for price shifts)

If your terminal has been programmed for PLU price level in the automatic return mode, touch a desired price level shift key before a numeric entry.

Procedure

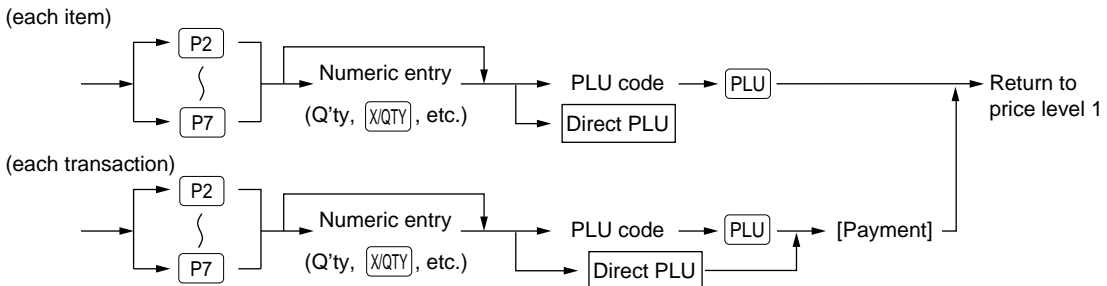

NOTE

When you use the FF method, you need not touch the **X/QTY** key for multiplication entries.

Lock shift mode (for price shifts)

If your terminal has been programmed for PLU price level in the lock shift mode, touch a desired price level shift key before a numeric entry.

Procedure

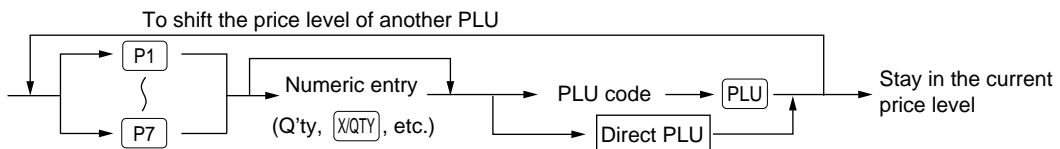

NOTE

- If you select the automatic return mode, it is not necessary to use the **P1** key on the keyboard, but if you select the lock shift mode, it is necessary to use the key.
- When you use the FF method, you need not touch the **X/QTY** key for multiplication entries.

Example

PLU price level 1: PLU code 1 (@1.10), PLU code 2 (@1.50)

PLU price level 2: PLU code 1 (@3.00), PLU code 2 (@2.40)

- When your POS terminal has been programmed for the automatic return mode:

Key Operation	Display

- When your POS terminal has been programmed for the lock shift mode:

Key Operation	Display

Condiment entries

Your terminal may be programmed for prompting condiment and preparatory instructions for a menu-item PLU.

Example:

When you enter a menu-item PLU, a prompting message such as "HOWCOOK?" and a list of the "Following PLUs" will appear. You must specify one of the "Following PLUs" such as "without mustard" to meet a special order of the guest. In an example of the condiment table shown below, it is assumed that the condiment table no.1 is assigned to PLU code 21 (programmed text "STEAK") and table no. 4 is assigned to table no. 1 as the next table no. When you enter the PLU code 21, the message "HOWCOOK?" will appear to prompt you to specify one of "RARE," "MED.RARE," and "WELLDONE." If the guest chooses "RARE," select it from the list. Then the next message "POTATO?" will appear to prompt you to specify one of "P.CHIPS," "MASHED.P," and "BAKED.P." If the guest chooses "MASHED.P," select it. Then touch the key to end this entry.

Here is an example of how to perform a condiment entry when your condiment table is as shown below.

Table number	PLU codes for condiment entry (programmed text, price)				Next table no.
1	(HOWCOOK?)	23 (RARE 0.00)	25 (MED.RARE 0.00)	27 (WELLDONE 0.00)	4
4	(POTATO?)	33 (P. CHIPS 0.60)	37 (MASHED.P 0.60)	38 (BAKED.P 0.50)	—

Menu-item
PLUs

Message text

PLUs

Example

Key Operation

000021
 [Select "RARE"]
 [from the key list.]
 [Select "MASHED.P"]
 [from the key list.]
CASH/TL

Display

CLERK0001	
1 PL000021	10.00
<div style="border: 1px solid gray; padding: 5px; width: fit-content; margin: auto;"> PL000021 HOWCOOK? </div>	
[J]	
***TOTAL	
1 PL000021	10.00
P1L01	



CLERK0001	
1 PL000021	10.00
1 RARE	
<div style="border: 1px solid gray; padding: 5px; width: fit-content; margin: auto;"> PL000021 POTATO? </div>	
[J]	
***TOTAL	
1 RARE	0.00
P1L01	



CLERK0001	
1 PL000021	10.00
1 RARE	
1 MASHED.P	0.60
CASH	10.60
[J]	
***TOTAL	
CASH	10.60
P1L01	

NOTE

- Your POS terminal will continue to operate for the condiment entry until you finish the entire condiment entry programmed for the PLU. During the condiment entry, if you enter a normal PLU, which is not in the condiment table, an error message will appear.
- When REPEAT TIMES of the condiment table is programmed either of 2 thru 9, its table shows repeatedly until accomplishment of a programmed times, then the next table will show.
- When the NEXT CONDIMENT key is touched, the entry skips to the next table which is programmed.
- When the CANCEL key is touched, its condiment entry is canceled in the programmed mode (REG/MGR or MGR).
- When you enter a PLU priced at "0.00," only the text will be printed on the receipt.
- No multiplication entry is possible for any condiment entries.
- No refund entry is possible for any condiment entries. When you perform a refund entry with a menu-item PLU and the condiment PLUs assigned to the menu-item PLU are automatically registered as a refund entry.
- You may omit the compulsory condiment entry by touching the CANCEL key.
- The cursor void entry is allowed for those PLUs that are entered as condiments (menu and condiment).
- The multiplication entry can be made for each condiment item independently. However, sum of the entered quantity per condiment table have to be same or below as menu PLU registration. When no multiplication entry is made, the quantity is decided automatically to reach number of menu PLU registration.

■ Happy hour

If a time range is programmed for a price level, the price corresponding to the price level is automatically registered within the time range. When the entry time becomes to be out of the time range, the price level returns to the following levels:

Shift by price level shift key

The price level returns to the level before the time range.

Shift by clerk

The price level returns to the level which is programmed for an assigned clerk.

The following examples show that between 9:00 AM and 11:00 AM are programmed for price level 2.

Example

- Between 9:00 AM and 11:00 AM

Key Operation

000001
CASH/TL

Display

```

CLERK0001 00
1 PL000001 1.00
CASH 1.00

***TOTAL [J ] 1.00
CASH 1.00
P2L01
  
```

- Excepting the time range from 9:00 AM to 11:00 AM

Key Operation

000001
CASH/TL

Display

```

CLERK0001 00
1 PL000001 1.10
CASH 1.10

***TOTAL [J ] 1.10
CASH 1.10
P1L01
  
```

■ Department shift

This shift can change the preset department to which a PLU belongs temporarily. When the D.SFT1 through D.SFT4 key is entered at the start of a transaction, the department codes to which all PLUs used in the transaction belong are changed to those which have been assigned to the D.SFT1 through D.SFT4 key used.

The following example shows that the PLU code 1 belongs to the department 1 and the D.SFT2 key is programmed for the department 10.

Example

Key Operation	Display
<div style="display: flex; flex-direction: column; align-items: center;"> <div style="border: 1px solid black; padding: 2px; margin-bottom: 2px;">D.SFT2</div> <div style="border: 1px solid black; padding: 2px; margin-bottom: 2px;">000001</div> <div style="border: 1px solid black; padding: 2px;">CASH/TL</div> </div>	<div style="border: 1px solid black; padding: 5px;"> <p style="text-align: right;">CLERK0001 00</p> <p>1 PL000001 1.10</p> <p>CASH 1.10</p> <p style="text-align: right;">[J]</p> <p>***TOTAL 1.10</p> <p>CASH 1.10</p> <p style="text-align: right;">P1L01</p> </div> <p>Dept. 10 totalizers are updated. (Original preset (dept. 1) is ignored.)</p>

■ Pint entries

Using this function, you can sell an item with the desired quantity such as a half and a double. To perform this function, touch the **PINT** key and enter an item assigned a PLU code for which you have programmed a pint price and a pint quantity. The price for the pint quantity will appear on the receipt. For details, contact your authorized SHARP dealer.

Procedure

FF method

PINT → **Direct PLU** PLU entry (direct)

Normal method

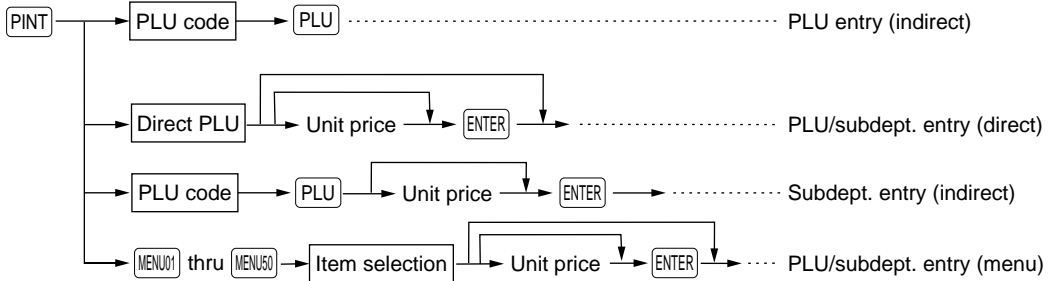

- Unit price: Less than a programmed upper limit

Example

Key Operation	Display
<div style="display: flex; flex-direction: column; align-items: center;"> <div style="display: flex; gap: 10px;"> <div style="border: 1px solid black; padding: 2px;">PINT</div> <div style="border: 1px solid black; padding: 2px;">2</div> <div style="border: 1px solid black; padding: 2px;">X/QT</div> <div style="border: 1px solid black; padding: 2px;">000001</div> </div> <div style="display: flex; gap: 10px; margin-top: 5px;"> <div style="border: 1px solid black; padding: 2px;">PINT</div> <div style="border: 1px solid black; padding: 2px;">000002</div> </div> <div style="border: 1px solid black; padding: 2px; margin-top: 5px;">CASH/TL</div> </div>	<div style="border: 1px solid black; padding: 5px;"> <p style="text-align: right;">CLERK0001 00</p> <p>2 PL000001 1.60</p> <p>1 PL000002 1.00</p> <p>CASH 2.60</p> <p style="text-align: right;">[J]</p> <p>***TOTAL 2.60</p> <p>CASH 2.60</p> <p style="text-align: right;">P1L01</p> </div>

Display of Subtotals

Your POS terminal provides the following types of subtotals:

■ Subtotal

Touch the **SUB TOTAL** key at any point during a transaction. The sales subtotal including tax will appear in the display.

■ Difference subtotal (Differ ST)

Touch the **DIF ST** key at any point during a transaction. When you touch it first, the subtotal of all entries which have been made is displayed and printed. If you touch it second, you will get the subtotal of entries which have been made after you got the first subtotal. Taxes are calculated each time you touch the **DIF ST** key, and taxes and taxable subtotals are displayed and printed on the receipt.

Example

Key Operation

000001
000002
DIF ST
000012
CASH/TL

Display

```
CLERK0001 00
  1 PL000001      1.10
  1 PL000002      1.50
DIFF ST          2.60
  1 PL000012      2.50
DIFF ST          2.50
CASH             5.10
                [J 1
***TOTAL                5.10
CASH                5.10
                P1L01
```

Finalization of Transaction

■ Cash or check tendering

Touch the **SUB TOTAL** key to get an including-tax subtotal, enter the amount tendered by your customer, then touch the **CASH1** or **CASH2** key if it is a cash tender or touch the **CHK** thru **CHK4** key if it is a check tender. When the amount tendered is greater than the amount of the sale, your POS terminal will show the change due amount and the symbol "CHANGE." Otherwise your POS terminal will show the symbol "DUE" and a deficit. Make a correct tender entry.

NOTE

- Touch the **PAYMENT** key and select a pertinent medium key.

Example

Cash tendering

Key Operation	Display
<pre> } SUB TOTAL 1000 CASH1</pre>	<pre>CLERK0001 00 1 PL000001 1.10 1 PL000002 1.50 CASH 10.00 CHANGE 7.40 [J] ***TOTAL 2.60 CHANGE 7.40 P1L01</pre>

Check tendering

Key Operation	Display
<pre> } SUB TOTAL 1000 CHK</pre>	<pre>CLERK0001 00 1 PL000001 1.10 1 PL000002 1.50 CHECK 10.00 CHANGE 7.40 [J] ***TOTAL 2.60 CHANGE 7.40 P1L01</pre>

■ Mixed tendering (check + cash)

Example

Key Operation

}
 SUB TOTAL
 1000 [CHK]
 500 [CASH]

Display

```

CLERK0001 00
  1 PL000005      10.00
  1 PL000006       1.00
  2 PL000002       3.00
CHECK             10.00
CASH              5.00
CHANGE            1.00

[J ]
***TOTAL                14.00
CHANGE            1.00
P1L01
  
```

■ Cash or check sale that does not need any tender entry

Enter items and touch the [CASH] or [CASH2] key if it is a cash sale or touch the [CHK] thru [CHK4] keys if it is a check sale. Your POS terminal will display the total sales amount.

Example

Key Operation

000006
 10 [PLU]
 [CASH]

Display

```

CLERK0001 00
  1 PL000006       7.20
  1 PL000010       2.30
CASH              9.50

[J ]
***TOTAL                9.50
CASH              9.50
P1L01
  
```

In the case of check sale

```

CLERK0001 00
  1 PL000006       7.20
  1 PL000010       2.30
CHECK             9.50

[J ]
***TOTAL                9.50
CHECK             9.50
P1L01
  
```

■ Credit sale

Enter items and touch the corresponding credit keys (CR1 thru CR8).

Example

Key Operation	Display														
<div style="border: 1px solid black; padding: 2px; display: inline-block; margin-bottom: 2px;">000006</div> <div style="border: 1px solid black; padding: 2px; display: inline-block; margin-bottom: 2px;">000007</div> <div style="border: 1px solid black; padding: 2px; display: inline-block;">CR1</div>	<div style="border: 1px solid black; padding: 5px;"> <div style="text-align: right; font-size: small;">CLERK0001</div> <table style="width: 100%; border-collapse: collapse;"> <tr> <td style="width: 80%;">1 PL000006</td> <td style="text-align: right;">7.20</td> </tr> <tr> <td>1 PL000007</td> <td style="text-align: right;">5.00</td> </tr> <tr> <td>CREDIT1</td> <td style="text-align: right;">12.20</td> </tr> <tr> <td colspan="2" style="padding-top: 10px;"> <div style="text-align: right; font-size: small;">[J]</div> </td> </tr> <tr> <td>***TOTAL</td> <td style="text-align: right;">12.20</td> </tr> <tr> <td>CREDIT1</td> <td style="text-align: right;">12.20</td> </tr> <tr> <td colspan="2" style="text-align: right; font-size: small;">P1L01</td> </tr> </table> </div>	1 PL000006	7.20	1 PL000007	5.00	CREDIT1	12.20	<div style="text-align: right; font-size: small;">[J]</div>		***TOTAL	12.20	CREDIT1	12.20	P1L01	
1 PL000006	7.20														
1 PL000007	5.00														
CREDIT1	12.20														
<div style="text-align: right; font-size: small;">[J]</div>															
***TOTAL	12.20														
CREDIT1	12.20														
P1L01															

NOTE

- Amount tendering operations (i.e. change calculations) can be achieved by the CR1 thru CR8 key when PGM2-mode programming allows them.
- Touch the PAYMENT key and select a pertinent credit key.

■ Mixed-tender sale (cash or check tendering + credit tendering)

Example

Key Operation	Display																
<div style="text-align: center;">}</div> <div style="border: 1px solid black; padding: 2px; display: inline-block; margin-bottom: 2px;">SUB TOTAL</div> 950 <div style="border: 1px solid black; padding: 2px; display: inline-block; margin-bottom: 2px;">CASH TL</div> <div style="border: 1px solid black; padding: 2px; display: inline-block;">CR2</div>	<div style="border: 1px solid black; padding: 5px;"> <div style="text-align: right; font-size: small;">CLERK0001</div> <table style="width: 100%; border-collapse: collapse;"> <tr> <td style="width: 80%;">10 PL000001</td> <td style="text-align: right;">11.00</td> </tr> <tr> <td>1 PL000003</td> <td style="text-align: right;">1.75</td> </tr> <tr> <td>CASH</td> <td style="text-align: right;">9.50</td> </tr> <tr> <td>CREDIT2</td> <td style="text-align: right;">3.25</td> </tr> <tr> <td colspan="2" style="padding-top: 10px;"> <div style="text-align: right; font-size: small;">[J]</div> </td> </tr> <tr> <td>***TOTAL</td> <td style="text-align: right;">12.75</td> </tr> <tr> <td>CREDIT2</td> <td style="text-align: right;">3.25</td> </tr> <tr> <td colspan="2" style="text-align: right; font-size: small;">P1L01</td> </tr> </table> </div>	10 PL000001	11.00	1 PL000003	1.75	CASH	9.50	CREDIT2	3.25	<div style="text-align: right; font-size: small;">[J]</div>		***TOTAL	12.75	CREDIT2	3.25	P1L01	
10 PL000001	11.00																
1 PL000003	1.75																
CASH	9.50																
CREDIT2	3.25																
<div style="text-align: right; font-size: small;">[J]</div>																	
***TOTAL	12.75																
CREDIT2	3.25																
P1L01																	

NOTE

Touch the CHK thru CHK4 keys or the CR1 thru CR8 keys in place of the CASH TL key when your customer makes payment by checks or by credit account.

Computation of VAT (Value Added Tax)/Tax

■ VAT/tax system

The POS terminal may be programmed for the following six tax systems by your authorized SHARP dealer.

Automatic VAT 1 through 6 system (Automatic operation method using programmed percentages)

This system, at settlement, calculates VAT for taxable 1, taxable 2, taxable 3, taxable 4, taxable 5, and taxable 6 subtotals by using the corresponding programmed percentages.

Automatic tax 1 through 6 system (Automatic operation method using programmed percentages)

This system, at settlement, calculates taxes for taxable 1, taxable 2, taxable 3, taxable 4, taxable 5, and taxable 6 subtotals by using the corresponding programmed percentages, and also adds the calculated taxes to those subtotals, respectively.

Manual VAT 1 through 6 system (Manual entry method using programmed percentages)

Procedure



This system provides the VAT calculation for taxable 1, taxable 2, taxable 3, taxable 4, taxable 5, and taxable 6 subtotals. This calculation is performed using the corresponding programmed percentages when the **VAT** key is touched just after the **SUB TOTAL** key.

Manual VAT 1 system (Manual entry method for subtotals that uses VAT 1 preset percentages)

Procedure

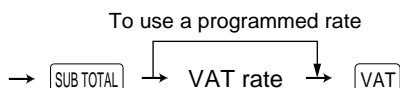

This system enables the VAT calculation for the then subtotal. This calculation is performed using the VAT 1 preset percentages when the **VAT** key is touched just after the **SUB TOTAL** key. For this system, the keyed-in tax rate can be used.

Manual tax 1 through 6 system (Manual entry method using programmed percentages)

Procedure



This system provides the tax calculation for taxable 1, taxable 2, taxable 3, taxable 4, taxable 5, and taxable 6 subtotals. This calculation is performed using the corresponding programmed percentages when the **VAT** key is touched just after the **SUB TOTAL** key. After this calculation, you must finalize the transaction.

Automatic VAT 1 through 3 and tax 4 through 6 system

This system enables the calculation in the combination with automatic VAT 1 through 3 and tax 4 through 6. This combination can be any of VAT 1 through 3 and tax 4 through 6. The tax amount is calculated automatically with the percentages previously programmed for these taxes.

NOTE

VAT/tax assignment is printed at the fixed right position of the amount on the receipt and bill as follows:

VAT1/tax1 —————> A
 VAT2/tax2 —————> B
 VAT3/tax3 —————> C
 VAT4/tax4 —————> D
 VAT5/tax5 —————> E
 VAT6/tax6 —————> F

When the multiple VAT/tax is assigned to a department or a PLU, a smaller number of the VAT/tax will be printed. For details, contact your authorized SHARP dealer.

Example**Key Operation**

(When the manual VAT 1 through 6 system is selected)

000008
 SUB TOTAL
 VAT
 CASH/TL

Display

CLERR0001		00
1 PL000008		5.20
SUBTOTAL		5.20
TAX1 ST		5.20
VAT 1		0.36
NET 1		4.84
CASH		5.20
		[J 1
***TOTAL		5.20
CASH	5.20	
		P1L01

■ VAT shift entries

This feature is intended to shift the tax status of a particular department (or PLU) programmed for taxable 1 or taxable 1 and taxable 3.

1. When the VAT shift entry is made for a particular department or PLU programmed for taxable 1, their tax status shifts to taxable 2.
2. When this entry is made for a particular department (or PLU) programmed for taxable 1 and taxable 3, the tax status "taxable 1" remains unchanged, but the other, "taxable 3" is ignored.

Procedure

Touche the **VATSFT** key to activate the VAT shift prior to entering department(s) or PLU(s) concerned. It is also possible to activate the VAT shift at the end of a transaction.

Example**Key Operation**

VATSFT
 000008
 SUB TOTAL
 VAT
 CASH/TL

Display

CLERR0001		00
1 PL000008		5.20
SUBTOTAL		5.20
TAX2 ST		5.20
VAT 2		0.15
NET 2		5.05
CASH		5.20
		[J 1
***TOTAL		5.20
CASH	5.20	
		P1L01

Guest Check (GLU/PBLU)

Two different guest check entry systems are available: the guest lookup (GLU) and previous balance lookup (PBLU) systems. It depends on how your POS terminal has been programmed which of these is used. (Contact your authorized SHARP dealer for this selection.)

GLU system: If this system is selected, the balance due and the details of the order are placed in the guest check file. The information can be automatically recalled by entering a guest check code (= a GLU code) when additional ordering occurs.

PBLU system: If this system is selected, the previous balance is stored in the previous balance lookup file (PB lookup file). The information can be automatically recalled by entering a previous balance lookup code (= a PBLU code) when additional ordering occurs.

■ GLU/PBLU system

New guest

For a new guest, open a new guest check and assign a GLU/PBLU code.

Procedure

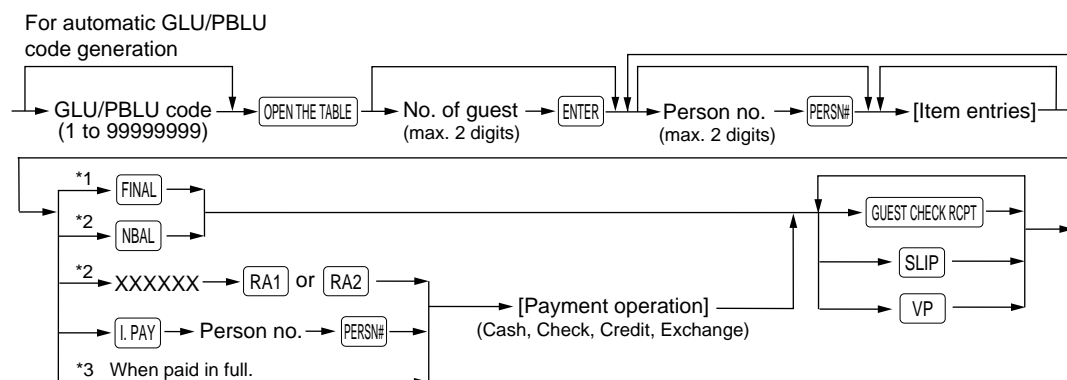

NOTE

- The GLU/PBLU code refers to a code that will be used whenever the guest check must be accessed for re-ordering or final payment.
- The person number is assigned to each person. When you make registration by each person, the person number has to be entered.
- Your POS terminal can be programmed GLU/PBLU codes in a sequential fashion. If your POS terminal has not been programmed to do so, each GLU/PBLU code can be entered manually.

*1 This is the optional function (Temporary finalization).

You can temporarily finalize a guest check by touching the **FINAL** key. This prints out a guest check to show the current balance, including tax. The guest check, however, is still "open." This means you can still make additional orders to it. The tax is calculated but is not added to the tax totalizer.

*2 The tax is not calculated.

*3 The tax is calculated and is added to the tax totalizer.

Example

Key Operation

11

No. of guests → 2

Display

```

GLU# 1 1          CLERR0001  00
GUEST
  1 PL000002          2.80
  1 PL000003          5.00

                                     IJ 1
***TOTAL              7.80  7.80
***NBAL              7.80
                                     P1L01
    
```

Additional ordering

For making additional guest check entries, enter the GLU/PBLU code first for automatic guest lookup.

Procedure

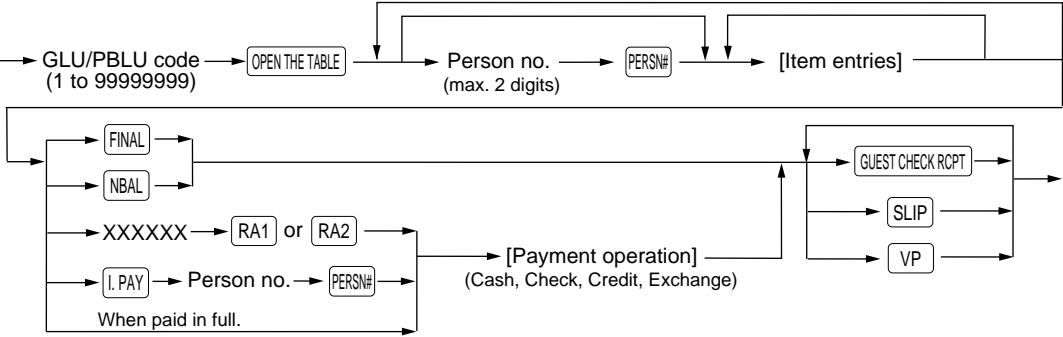

Example

Key Operation

11

Display

```

GLU# 1 1          CLERR0001  00
GUEST
  1 PL000002          2.80
  1 PL000003          5.00
  2 PL000007         13.20

                                     IJ 1
***TOTAL              21.00  21.00
***NBAL              21.00
                                     P1L01
    
```

Settlement

Use the following procedure:

Procedure

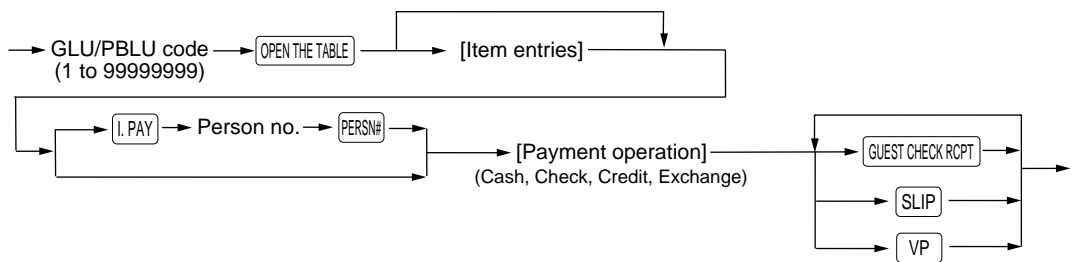

Example

Key Operation

```

11 [OPEN THE TABLE]
2000 [CHK]
400 [CASHTL]
  
```

Display

```

GLU# 11          CLERK0001  00
GUEST
  1 PL000002          2.80
  1 PL000003          5.00
  2 PL000007         13.20
CHECK                20.00
CASH                  4.00
CHANGE                3.00
                    [J ]
***TOTAL              21.00
CHANGE                3.00
                    P1L01
  
```

■ Drive-through function

A second GLU/PBLU function can be used as the drive-through function. This system looks up drive-through codes automatically (First In/First Out).

This drive-through system provides three types of POS terminal functions (Order taker, cashier station and counter).

Drive-through screen

The drive-through screen can be displayed by touching the **D-THRU** key or by finalizing the drive-through registration (refer to PGM: FUNC.SELECTING).

When the HOME, SUB or Function menu key is touched, the screen is changed to the ordinary screen from the drive-through screen. The screen can also be changed to the ordinary screen by beginning the drive-through registration with touching the **NEW CAR ENTRY** key.

Order taker machine

CAR#	CLERK	0001	DRIVE TRU	11:15	REG
CAR#2	CLERK0001	0001	DRIVE TRU	11:15	REG
2	PL000001	2.20			
2	PL000002	3.00			
***TOTAL		[J] 5.20			
CAR#1	1	PL000002	1.50		
	1	PL000003	5.00		
***TOTAL		6.50			

For the current code

For the previous code

Cashier station machine

For the next code

CAR#	CLERK	0001	DRIVE TRU	11:56	REG
CAR#28	CLERK0001	0001	DRIVE TRU	11:56	REG
1	PL000006				
1	PL000005				
CAR#29	5	PL000001			
	2	PL000002			
CAR#31	3	PL000001			
	4	PL000002			
CAR#32	5	PL000002			
	1	PL000005			
(02:17)	(01:48)	(01:12)	(00:33)		
(25)(26)(27)			

For the current code

The drive-through codes in the WAIT state

Waiting time count

Counter machine

For the previous code

CAR#	CLERK	0001	DRIVE TRU	11:37	REG
CAR#16	CLERK0001	0001	DRIVE TRU	11:37	REG
1	PL000005	5.20			
1	PL000001	1.10			
1	PL000002	1.50			
***TOTAL		[J] 7.80			

For the current code

The order entry and settlement operation can be performed only for the current code.

The window of desired drive-through code is saved to the wait state by using the **WAIT** key.

[Select the drive-through code.]
(Touch the pertinent window)

CLERK0001 0001 DRIVE TRU 11:57 REG			
CAR#28 1 PL000006 1 PL000005	CAR#29 5 PL000001 2 PL000002	CAR#31 3 PL000001 4 PL000002	CAR#32 5 PL000002 1 PL000005
(03:40) (25)((03:11) (26)((02:35) (27)	(01:56)

→ **WAIT**

CLERK0001 0001 DRIVE TRU 11:58 REG			
CAR#29 5 PL000001 2 PL000002	CAR#31 3 PL000001 4 PL000002	CAR#32 5 PL000002 1 PL000005	
(04:31) (25)((03:55) (26)((03:16) (27)((28)

The window of desired drive-through code is released from the wait state by using the **RECALL** key.

→ **RECALL**

Selective codes

CLERK0001 0001 DRIVE TRU 12:01 REG			
CAR#29 5 PL000001 2 PL000002	CAR#31 3 PL000001 4 PL000002	CAR#32 5 PL000002 1 PL000005	
(07:04) (25)((06:28) (26)((05:49) (27)((28)

25
26
27
28

CANCEL ENTER

[Select the drive-through code.]

ENTER

CAR#27 CLERK0001 00	
2 PL000001	2.20
1 PL000002	1.50
1 PL000005	5.20
[J]	
***TOTAL	8.90
***PBAL2	8.90
P1L01	

New car

For a new car, open a new drive-through balance (the code is automatically generated).

Procedure

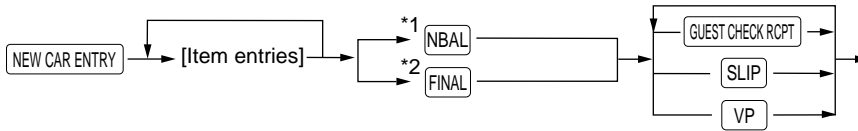

NOTE

The drive-through code refers to a code that will be used whenever the guest check must be accessed for re-ordering or final payment.

*1 The tax is not calculated.

*2 This is the optional function (Temporary finalization).

You can temporarily finalize a guest check by touching the **FINAL** key. This prints out a guest check to show the current balance, including tax. The guest check, however, is still “open.” This means you can still make additional orders to it. The tax is calculated but is not added to the tax totalizer.

Example

Key Operation



Display

CAR#35		CLERK0001	00
1	PL000002	1.50	
1	PL000003	2.30	
			[J 1
***TOTAL			3.80
***NBAL2	3.80		
			P1L01

Additional ordering

For making additional drive-through entries, use the following procedure:

Procedure

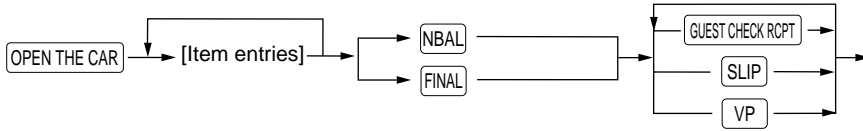

Example

Key Operation

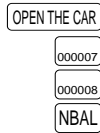

Display

CAR#35		CLERK0001	00
1	PL000002		1.50
1	PL000003		2.30
1	PL000007		6.20
1	PL000008		5.00
			[J]
***TOTAL			15.00
***NBAL2		15.00	
P1L01			

Settlement

Use the following procedure:

Procedure

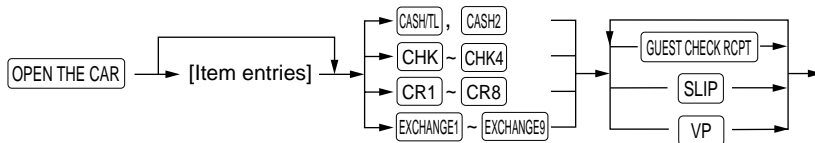

Example

Key Operation

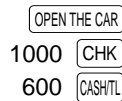

Display

CAR#35		CLERK0001	00
1	PL000002		1.50
1	PL000003		2.30
1	PL000007		6.20
1	PL000008		5.00
CHECK			10.00
CASH			6.00
CHANGE			1.00
			[J]
***TOTAL			15.00
CHANGE		1.00	
P1L01			

■ Deposit entries

Deposit refers to a prepayment on a guest check. It can be received in cash, by check or credit. You can make a deposit entry only when entering a guest check. It cannot be done during handling of a tendered amount.

A received deposit can be refunded by touching the **DEP.RF** key. You cannot attempt to refund an amount larger than the deposit balance.

Procedure

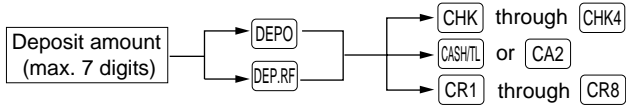

Example

Key Operation

```

11 OPEN THE TABLE
5000 DEPO
      CASH/TL
      NBAL
  
```

Display

```

GLW 1 1 CLERK0001 00
CASH
DEPOSIT 50.00

      [ J ]
***TOTAL -50.00
***NBAL -50.00
      P1L01
  
```

Example

Key Operation

```

11 OPEN THE TABLE
5000 DEP.RF
      CASH/TL
      NBAL
  
```

Display

```

GLW 1 1 CLERK0001 00
CASH
DEPOSIT 50.00
CASH
DEPO. (-) -50.00

      [ J ]
***TOTAL 0.00
***NBAL 0.00
      P1L01
  
```

■ Transferring guest checks out or in (Transfer-in/out)

Transferring guest checks out

At the end of a clerk shift or whenever a clerk is relieved, one or more open guest checks can be transferred from the clerk to the open check file until the responsibility for the check(s) is assigned to another clerk. Also, all open guest checks of this clerk can be transferred at one time.

Procedure

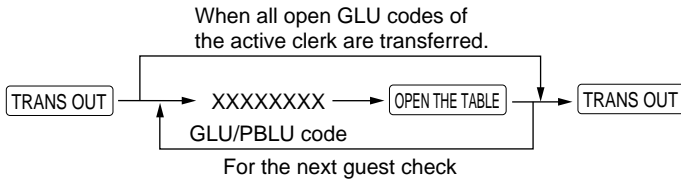

Example

Key Operation

```

    TRANS OUT
    11 OPEN THE TABLE
    TRANS OUT
  
```

Display

```

    CLERK0001
    G L U #111
    ***PBAL                22.30
    [ ]
    ***TOTAL                0.00
    TRAN.OUT
    P1L01
  
```

Transferring guest checks in

When the second clerk is assigned to be responsible for guest checks that have been transferred out:

Procedure

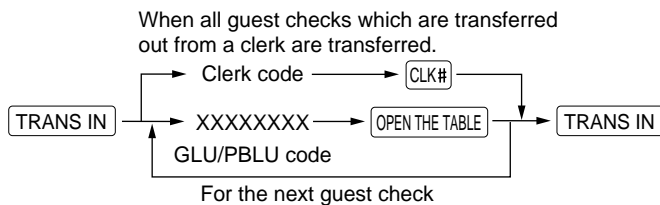

Example

Key Operation

```

    TRANS IN
    11 OPEN THE TABLE
    TRANS IN
  
```

Display

```

    CLERK0001
    G L U #111
    ***PBAL                22.30
    [ ]
    ***TOTAL                0.00
    TRAN.IN
    P1L01
  
```

■ Bill printing

This function is used for issuing the bill to the guest. Your POS terminal can print the bill (normal bill or cumulated bill) on the slip, receipt, or journal printer. For selecting these printers, contact your authorized SHARP dealer.

Procedure

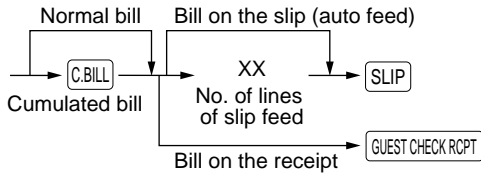

NOTE

This function is available immediately after the finalization of transaction (including after touching the **[NBAL]** or the **[FINAL]** key).

Example

- When you select normal bill printing:

Key Operation	Print
<div style="border: 1px solid black; padding: 2px; display: inline-block;">GUEST CHECK RCPT</div>	<div style="border: 1px solid black; padding: 5px;"> <p>15/12/99 [0001] 123456 #1033 11:24 JACK BILL NUMBER 0001</p> <p style="text-align: center;">*BILL*</p> <p>PL000001 *1.20 PL000002 *2.80</p> <p>CASH *4.00</p> </div>

- When you select cumulated bill printing:

Key Operation	Print
<div style="border: 1px solid black; padding: 2px; display: inline-block;">C.BILL</div> <div style="border: 1px solid black; padding: 2px; display: inline-block;">GUEST CHECK RCPT</div>	<div style="border: 1px solid black; padding: 5px;"> <p>15/12/99 [0001] 123456 #1035 11:27 JACK BILL NUMBER 0003</p> <p style="text-align: center;">*BILL*</p> <p>ALL FOODS & DRINKS *4.00</p> <p>CASH *4.00</p> </div>

■ Intermediate GLU reading (only for GLU system)

This function is used for temporary inspection of the guest check. The details of the guest check can be printed on the receipt or the slip. For selecting these printers, contact your authorized SHARP dealer.

Procedure

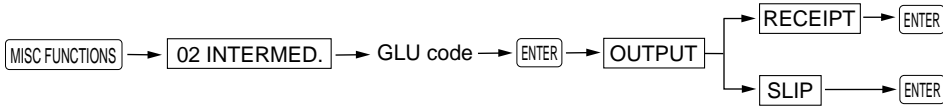

NOTE

This function is available after finishing the guest check entry.

Example

Key Operation	Print
[Select "02 INTERMED."] 21 <input type="button" value="MISC FUNCTIONS"/> <input type="button" value="ENTER"/> <input type="button" value="ENTER"/>	<pre> 15/12/99 123456 11:37 JACK *INTERMED.* GLU#21 ***PBAL *0.00 PL000003 *5.00 PL000002 *2.80 PL000005 *7.20 ***NBAL *15.00 </pre>

■ Bill totalizing/bill transfer

Bill totalizing

The bill totalizing function is used to totalize multiple bills when, for example, a particular guest pays not only his or her bill, but also the bills of other guests.

Procedure

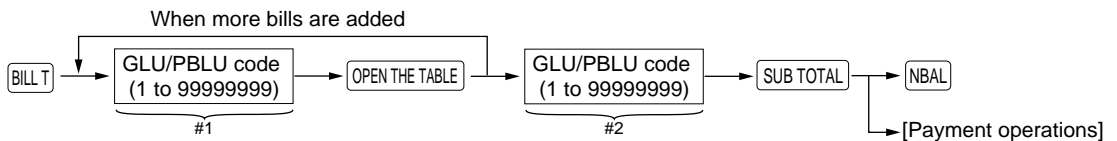

NOTE

- All #1 bills are added to a #2 bill. A maximum of 5 bills is available for #1.
- The GLU/PBLU code of #1 must be in use. If the guest check(s) of #1 or #2 has already been handled by another clerk, the guest check(s) must have been made "Transferring out."
- After the bill totalizing operation, the individual payment is not allowed.

Example

Key Operation	Display
<p>BILL T</p> <p>12 OPEN THE TABLE</p> <p>13 OPEN THE TABLE</p> <p>11 SUB TOTAL</p> <p>NBAL</p>	<pre> SLUW#11 CLERK0001 0001 BS&BT 11:54 B.T. 1 PL000005 7.20 1 PL000007 6.60 1 PL000002 2.80 [J] ***TOTAL 16.60 ENTER NBAL KEY P1L01 </pre>

Bill transfer

This function is used to change the GLU/PBLU code of a particular bill.

Procedure

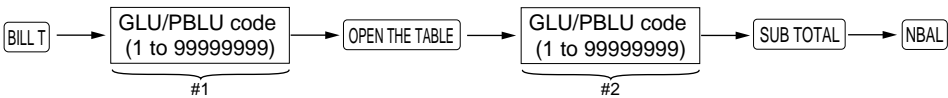

NOTE

- This function requires that the current GLU/PBLU code be entered for #1 and a new GLU/PBLU code be entered for #2.
- A #1 bill is transferred to a #2 bill. The #1 bill is then cleared and set free.

Example

Key Operation	Display
<p>BILL T</p> <p>11 OPEN THE TABLE</p> <p>12 SUB TOTAL</p> <p>NBAL</p>	<pre> SLUW#12 CLERK0001 0001 BS&BT 11:57 B.T. 1 PL000005 7.20 1 PL000007 6.60 1 PL000002 2.80 [J] ***TOTAL 16.60 ENTER NBAL KEY P1L01 </pre>

■ Bill separating

This function is used when each guest of a group pays his or her own order. With this function, you can select some items from a guest check and make an entry for the payment. Also, you can transfer the items you have selected to other guest checks. This function is available only in the GLU system.

Procedure

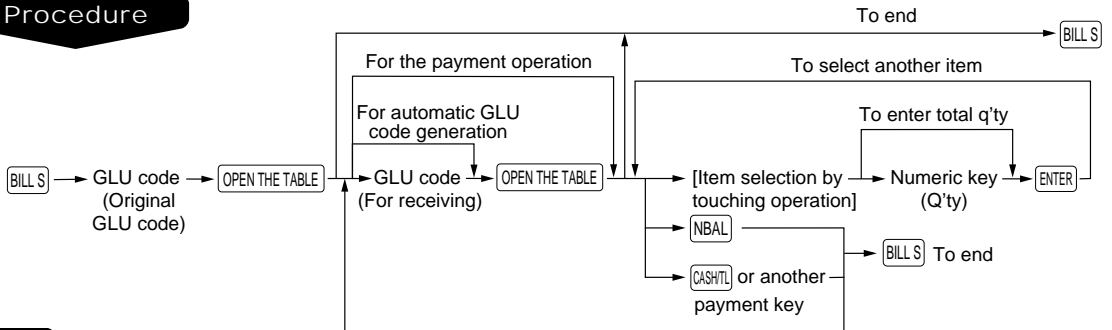

NOTE

- The items can be transferred from the original windows to the destination (receiving) window.
- The items which are refunded or discounted can not be separated.
- If the receiving GLU code is not entered during the bill separating operation, it is considered that the payment function has been made by touching the CASH/TL or other payment key.
- You cannot specify the quantity of an item for selection when the stored quantity has decimal fraction.

Example

In this example, it is assumed that you receive payment from a group for two “MEAT”s and five “EGG”s stored in a guest check (GLU code 22).

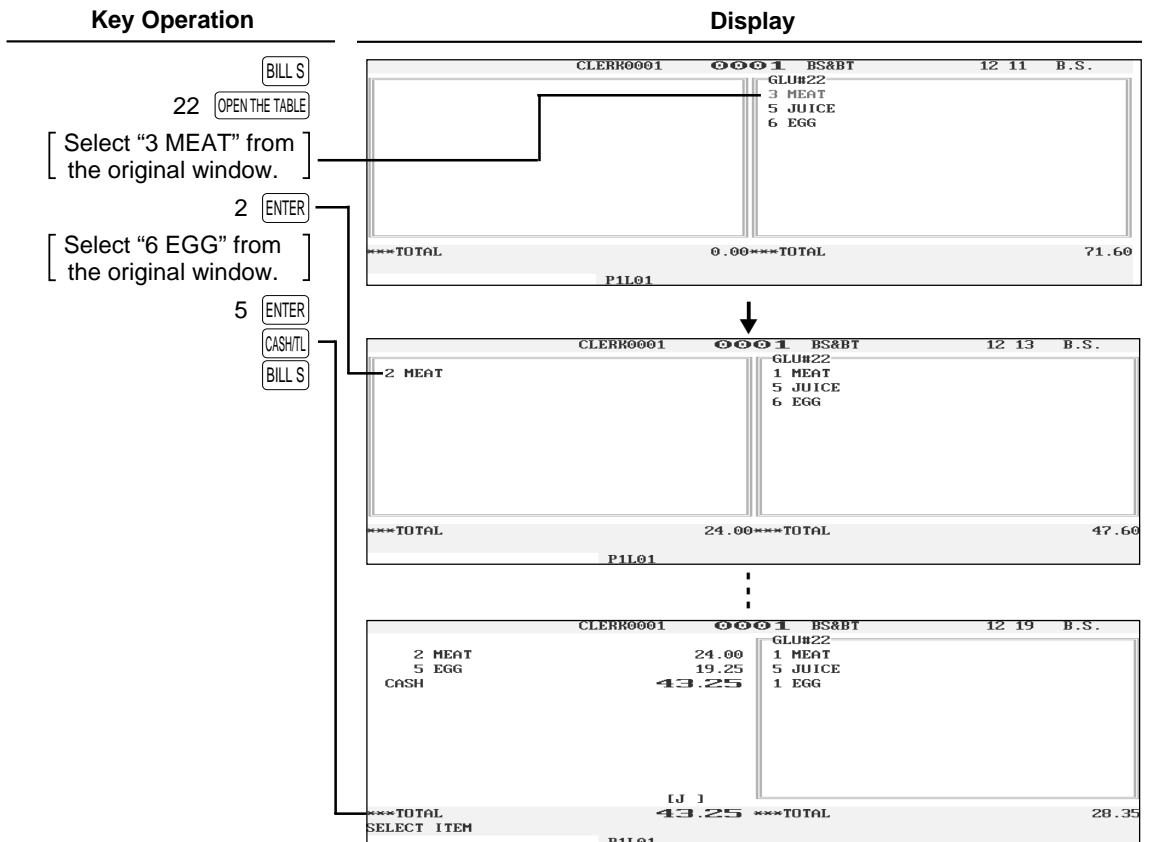

Example

In this example, it is assumed that you transferred three "MEAT"s and five "EGG"s stored in a guest check (GLU code 25) to a new guest check (GLU code 31).

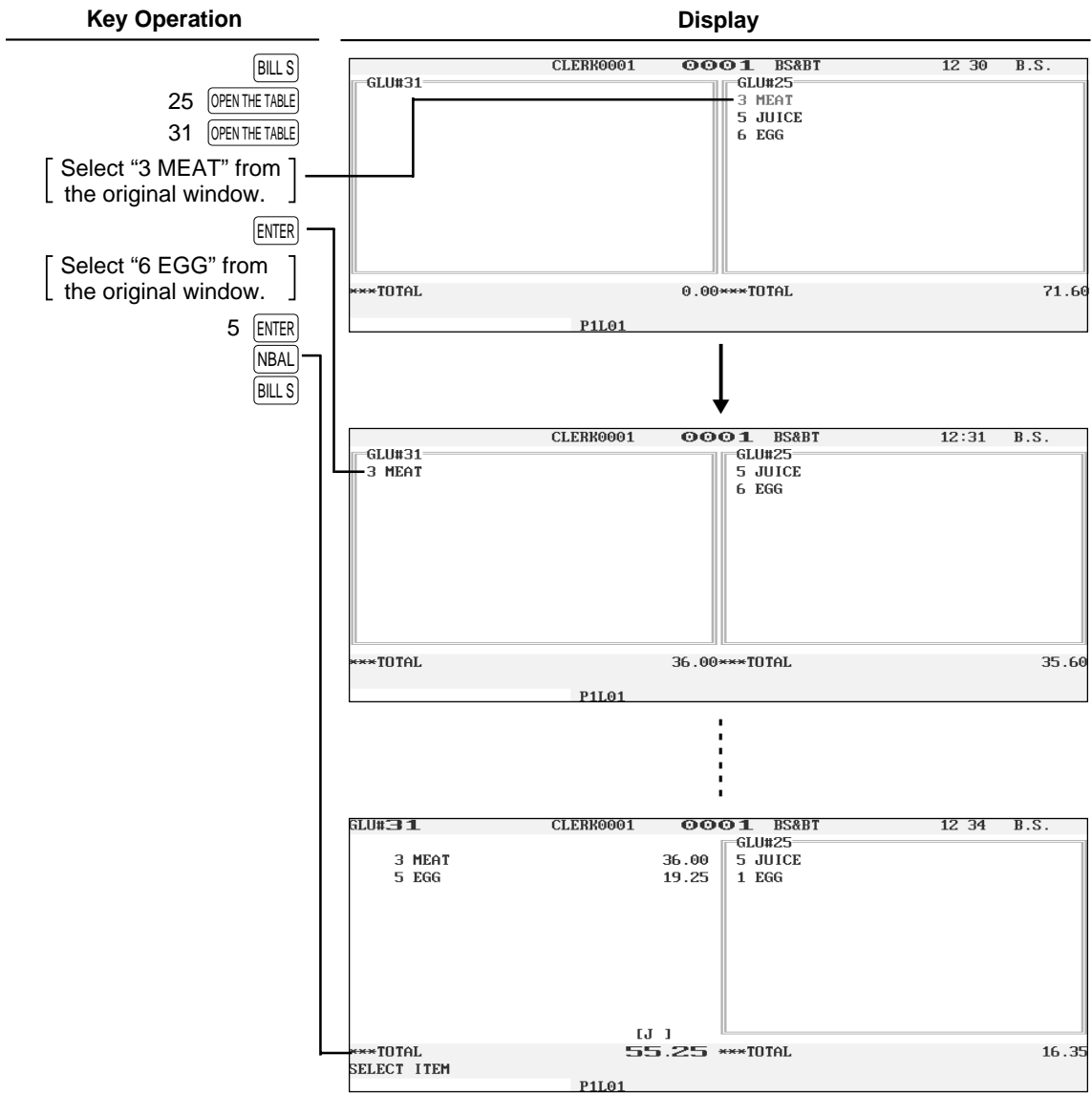

Transaction migration

This POS terminal allows you to migrate the transaction of non-GLU type to the GLU file.

Procedure

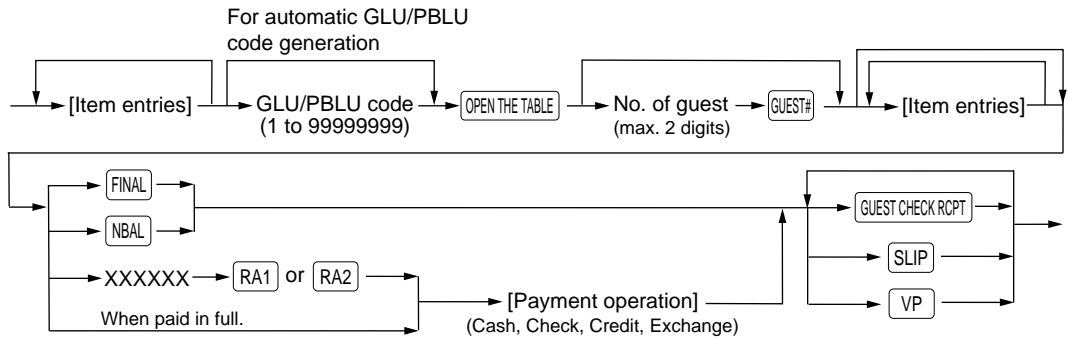

Example

Key Operation

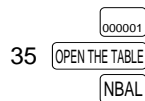

Display

Key Operation		Display	
35	000001	GLU#35	CLERK0001
OPEN THE TABLE	NBAL	1 PL000001	1.20
		***TOTAL	[J] 1.20
		***NBAL	1.20
			P1L01

NOTE

- The transaction migration can be operated before payment operation was made.
- This function can not be used when individual payment system is selected.
- This function can be made for GLU entry, not for drive-through entry.

Auxiliary Entries

■ Percent calculations (premium or discount)

- Your POS terminal provides percent calculations for a subtotal or each item entry. You need to specify in advance for which of a subtotal and each item entry your POS terminal should perform a percent calculation.
- For percent calculations (premium, discount, subtotal or individual), you may use the [%1] through [%9] key.
- Percentage: 0.01 to 100.00%

Percent calculation for a subtotal

Example

Key Operation

(When a discount of 10% is programmed for the [%1] key.)

4 [X/QTY]
 [000003]
 [000005]
 [000005]
 [SUB TOTAL]
 [%1]
 [CASH/TL]

Display

CLERK0001	
4 PL000003	5.60
2 PL000005	4.50
SUBTOTAL	10.10
%1	-10.00%
CASH	9.09
[J 1]	
***TOTAL	9.09
CASH	9.09
P1L01	

Percent calculation for item entries

Example

Key Operation

(When a premium of 10% is programmed for the [%2] key.)

90 [PLU]
 7 [.] 5 [%2]
 [CASH/TL]

Display

CLERK0001	
1 PL000006	8.00
%2	10.00%
1 PL000090	5.00
	7.50%
%2	0.38
CASH	14.18
[J 1]	
***TOTAL	14.18
CASH	14.18
P1L01	

■ Discount entries

Your POS terminal allows you to deduct a certain amount less than a programmed upper limit after the entry of an item or the computation of a subtotal.

Discount for a subtotal

Example

Key Operation

000006
 80 [PLU]
 [SUB TOTAL]
 100 [(-)2]
 [CASH TL]

Display

```

CLERK0001 00
  1 PL000006          2.80
  1 PL000080          7.50
( - )2              -1.00
CASH                9.30

                                     [J ]
***TOTAL                                     9.30
CASH                9.30
                                     P1L01
  
```

Discount for item entries

Example

Key Operation

7 [PLU]
 75 [(-)1]
 [CASH TL]

Display

```

CLERK0001 00
  1 PL000007          6.60
( - )1              -0.75
CASH                5.85

                                     [J ]
***TOTAL                                     5.85
CASH                5.85
                                     P1L01
  
```

■ Refund entries

If a returned item is the one entered into a department, enter the amount of the return, then touch the **REFUND** key and a corresponding department key in this order; and if an item entered into a PLU is returned, enter a corresponding PLU code, then touch the **REFUND** and **PLU** keys, or touch the **REFUND** and direct PLU keys in this order without entering any PLU code.

Example

Key Operation	Display
<div style="display: flex; flex-direction: column; align-items: center;"> <div style="display: flex; gap: 10px;"> REFUND 000003 </div> <div style="display: flex; gap: 10px;"> 7 X/QTY </div> <div style="display: flex; gap: 10px;"> 7 REFUND PLU </div> <div style="display: flex; gap: 10px;"> CASH/TL </div> </div>	<div style="border: 1px solid black; padding: 5px;"> <p style="text-align: right;">CLERR0001 00</p> <p>-1 PL000003 R-5.00</p> <p>-7 PL000007 R-46.20</p> <p>CHANGE 51.20</p> <p style="text-align: right;">[J]</p> <p>***TOTAL -51.20</p> <p>CHANGE 51.20</p> <p style="text-align: right;">P1L01</p> </div>

■ Return entries

If a refunded item is to be entered into a department, enter the amount of the refund, then touch the **RETURN** key and a corresponding department key in this order; and if an item entered into a PLU is returned, enter a corresponding PLU code, then touch the **RETURN** and **PLU** keys, or touch the **RETURN** and direct PLU keys in this order without entering any PLU code.

Example

Key Operation	Display
<div style="display: flex; flex-direction: column; align-items: center;"> <div style="display: flex; gap: 10px;"> RETURN 000005 </div> <div style="display: flex; gap: 10px;"> 7 000004 </div> <div style="display: flex; gap: 10px;"> 7 RETURN X/QTY </div> <div style="display: flex; gap: 10px;"> PLU </div> <div style="display: flex; gap: 10px;"> CASH/TL </div> </div>	<div style="border: 1px solid black; padding: 5px;"> <p style="text-align: right;">CLERR0001 00</p> <p>1 PL000005 7.20</p> <p>-1 PL000004 RT-1.25</p> <p>-7 PL000007 RT-46.20</p> <p>CHANGE 40.25</p> <p style="text-align: right;">[J]</p> <p>***TOTAL -40.25</p> <p>CHANGE 40.25</p> <p style="text-align: right;">P1L01</p> </div>

■ Printing of non-add code numbers

Enter a non-add code number such as a guest code number and credit card number within a maximum of 16 digits and touch the **#** key at any point during the entry of a sale.

Example

Key Operation	Display
1230 # 000001 CR2	<pre> CLERK0001 #000000000000001230 1 PL000001 1.10 CREDIT2 1.10 [J] ***TOTAL 1.10 CREDIT2 1.10 P1L01 </pre>

■ Printing of free text

Free text programmed in the PGM mode can be printed out by entering the corresponding text code and touching the **TEXT#** key or by touching a corresponding direct text key. You can describe your item together with departments and PLUs.

Procedure

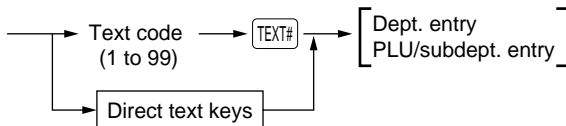

Example

Key Operation	Display
1 TEXT# 000011 CASHTL	<pre> CLERK0001 1 BOIL.EG 1.00 HARD CASH 1.00 [J] ***TOTAL 1.00 CASH 1.00 P1L01 </pre>

■ Entertainment bill

This function is used to print sales data on guest checks (Entertainment bill) on a receipt printer.

Procedure

→ ENTERTAINMENT →

Print sample

YOUR RECEIPT THANK YOU

15/12/99 [0001]123456
#0324 13:14 CLERK0001
BILL NUMBER 0004

BILL
PL000005 *15.00
CASH *15.00

Angaben
zum Nachweis der Höhe und der
betrieblichen Veranlassung von
Bewirtungsaufwendungen

Bewirtete Person(en) :

Anlass der Bewirtung:

Höhe der Aufwendungen
***15.00**

bei Bewirtung im Restaurant

in anderen Fällen

Ort Datum
TOWNNAMETOWNNAME 15/12/99

Unterschrift

Payment Treatment

■ Tip-in entries

Your POS terminal allows the entry of tips that your guests give to clerks in cash or other media (check or credit). The tip in entry assumes that it is carried out in the following system:

- Tip paid by a guest to a clerk is entered in the POS terminal by tip entry, and the restaurant pays the tip amount to the clerk later in cash.
- Tip amount entry to the POS terminal is normally performed by a clerk.

The entry is allowed before payment operation is performed. After the tip entry is performed, item entry is not allowed. The transaction operation must be finalized by payment operation. Two types of tip, cash tip and non-cash tip, are not allowed to be mixed in entry during one transaction operation. Tip entry only in either of them is allowed.

Cash tip entry: In a transaction in which cash tip entry is made, when payment operation is started, the process is as follows:

Cash tender (which may be foreign money) is compulsory until total cash tender exceeds or equals to cash tip amount. Then, check (or credit) tender operation is allowed.

Non-cash tip entry: In a transaction in which non-cash tip entry is made, when payment operation is started, the process is as follows:

Check (or credit) tender is compulsory until total check (or credit) tender exceeds or equals to non-cash tip amount. Then, cash tender operation is allowed.

Procedure

Cash tip entry

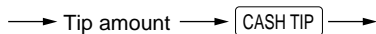

Non-cash tip entry

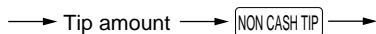

Example

Key Operation

11
 300
 300
 1380

Display

SLU#11	CLERK0001	00
1 PL000003		10.00
1 PL000002		3.80
CASH TIP		3.00
CASH		3.00
CHECK		13.80
CHANGE		0.00
	[J]	
***TOTAL		16.80
CHANGE		0.00
	P1L01	

■ Currency exchange

Your POS terminal allows payment entries in foreign currency. Touching the **EXCHANGE1** through **EXCHANGE9** key creates a subtotal in foreign currency. Cash alone can be handled after currency exchange.

Procedure

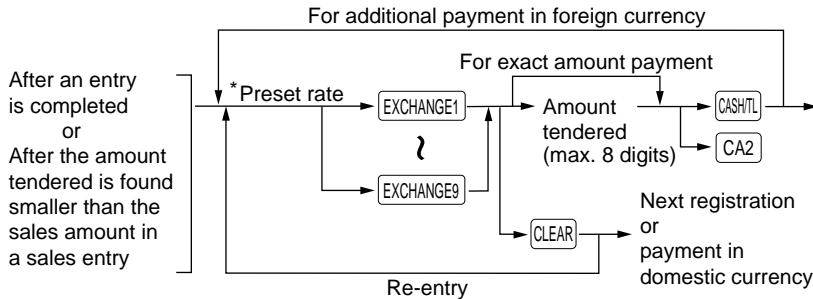

*Preset rate: 0.000000 to 999.999999

NOTE

- When the amount tendered is short, its equivalent in deficit is shown in domestic currency.
- Change amount will be displayed in domestic currency.

Example

Preset rate : 0.6068

Currency exchange key used : EXCHANGE1

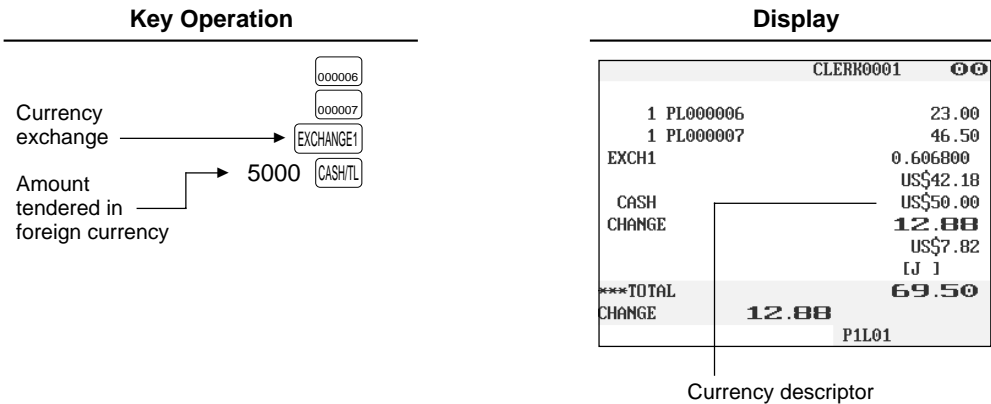

NOTE

Case of opening foreign currency drawer:

- At the timing of issuing receipt after tendering exchange amount.
- At the timing of issuing X/Z report (included CCD)
- The **Exchange drawer open function** is executed.

When the **EXCHANGE(n)** key is touched simply out of transaction, the foreign currency drawer is opened.

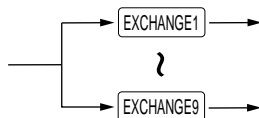

Received-on-account entries

Procedure

Direct key entries

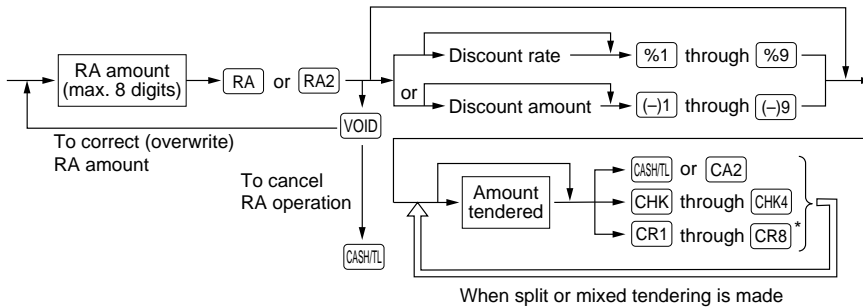

Menu-based entries

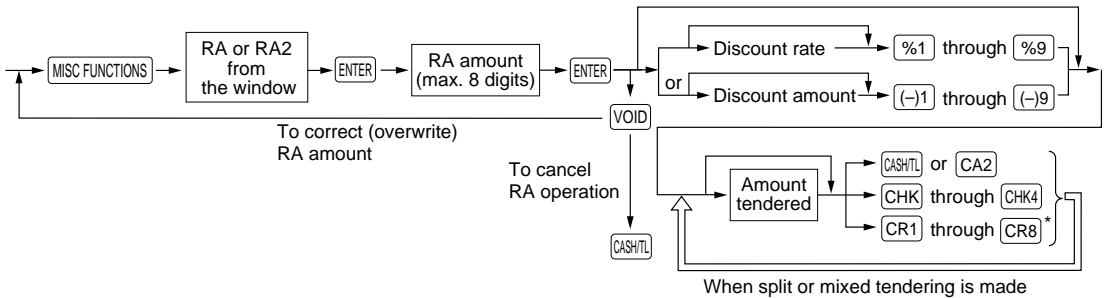

NOTE

- Of the CR1 through CR8 keys, you may use only the one that is programmed to be capable of entering amounts tendered.

Example

Key Operation	Display
12345 #	CLERK0001
4800 RA	#00000000000012345
4000 CHK	***RA 48.00
800 CASH/TL	CHECK 40.00
	CASH 8.00
	CHANGE 0.00
	[J]
	***TOTAL 48.00
	CHANGE 0.00
	P1L01

NOTE

You may also choose the RA procedure instead of the above procedure only for cash payment. Contact your authorized SHARP dealer to change the procedure.

Procedure

Direct key entries (cash-only entry)



Menu-based entries (cash-only entry)

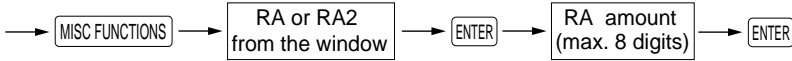

■ Paid-out entries

Procedure

Direct key entries

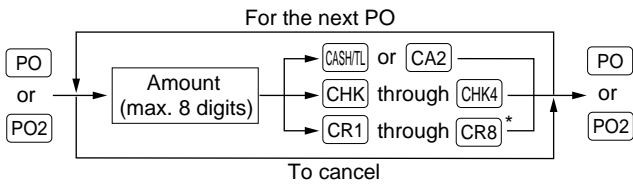

Menu-based entries

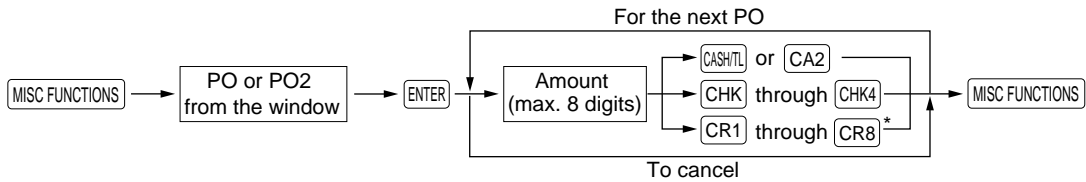

NOTE

- Of the **CR1** through **CR8** keys, you may use only the one that is programmed to be capable of entering amounts tendered.

Example

Key Operation	Display
6789 #	CLERR0001 00
PO	#0000000000006789
3000 CHK	***PO
PO	CHECK 30.00
	***PO 30.00
	[J 1
	***TOTAL 30.00
	***PO 30.00
	P1L01

NOTE

You may also choose the **PO** procedure instead of the above procedure only for cash payment. Contact your authorized SHARP dealer to change the procedure.

Procedure

Direct key entries (cash-only entry)

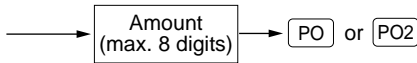

Menu-based entries (cash-only entry)

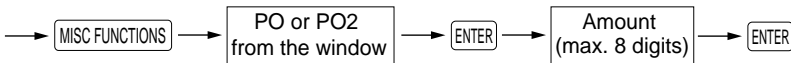

■ No-sale (exchange)

Simply touch the **NS** key without any entry. The drawer will open and the printer will print the caption “NO SALE.” If you let your POS terminal print a non-add code number before touching the **NS** key, a no-sale entry will be achieved with a non-add code number printed.

Display

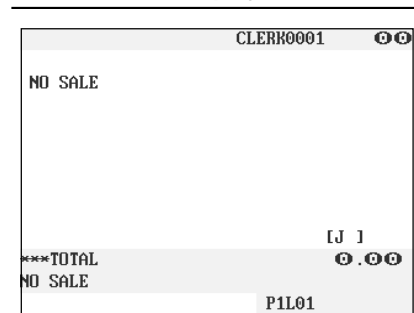

NOTE

You can also enter “No-sale” from the miscellaneous menu window. Touching the **MISC FUNCTIONS** key and select “08 NO SALE” from the window.

■ Transferring cash

This function is used to change cash sales amount for credit or check sales amount. For example, you can use this function when your guest asks you to credit the payment or to receive payment with check after entering the payment as cash.

Procedure

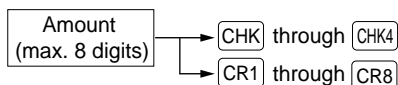

Example

Key Operation

2000 [CHK]

Display

```

CLERR0001 00
TRANSFER
CHECK                20.00

[J ]
***TOTAL                20.00
CHECK                20.00
P1L01
  
```

■ Cashing a check

Enter the check amount, then touch the [CHK] through [CHK4] keys. You cannot use this function when your POS terminal is set for “cash transferring is available.” For selecting cash transfer or check cashing, contact your authorized SHARP dealer.

Procedure

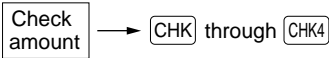

Example

Key Operation

6789 [#]
3000 [CHK]

Display

```

CLERR0001 00
#0000000000006789
CA/CHK                30.00

[J ]
***TOTAL                30.00
CA/CHK                30.00
P1L01
  
```

■ Service charge

When the payment operation is made for sales registrations, the service charge amount is calculated and printed. You can program a percent rate for calculating the service charge. If the percent rate is programmed as 0%, the POS terminal does not print any service charge. Service charge is available in automatic VAT 1-6, automatic tax 1-6, automatic VAT 1-3 and automatic tax 4-6 system.

Example

Key Operation	Display
<div style="text-align: center;"> <input type="text" value="000002"/> <input type="text" value="000003"/> <input type="text" value="SUB TOTAL"/> <input type="text" value="CASH/TL"/> </div>	<pre> CLERK0001 00 1 PL000002 2.80 1 PL000003 5.00 CASH 8.58 [J] ***TOTAL 8.58 CASH 8.58 PIL01 </pre>

■ VIP sales

This function is used for transaction for the important guest who is free of charge. In this mode, any unit price is not counted.

Procedure

→ → [Item entries] →

Example

Key Operation	Display
<div style="display: flex; align-items: center;"> <div style="border-left: 1px solid black; border-right: 1px solid black; padding: 5px; margin-right: 10px;"> Unit price programmed for PLU1: 1.15 Unit price programmed for PLU2: 15.00 </div> <div style="margin-right: 10px;">3</div> <div style="text-align: center;"> <input type="text" value="X/QTY"/> <input type="text" value="VIP"/> <input type="text" value="000001"/> <input type="text" value="000002"/> <input type="text" value="CASH/TL"/> </div> </div>	<pre> CLERK0001 00 1 PL000001 0.00 3 PL000002 0.00 CASH 0.00 [J] ***TOTAL 0.00 CASH 0.00 PIL01 </pre>

WASTE mode

This mode is used to throw away an article which has already been prepared and is no longer serviceable.

Procedure

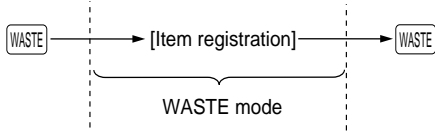

NOTE

- PLU entries are only allowed in the WASTE mode, and direct and indirect void operations are also allowed in this mode.
- When a WASTE-mode transaction is finalized, the drawer does not open.
- The consecutive number is incremented every WASTE-mode transaction.
- When the WASTE mode is activated by touching the **WASTE** key, the mode caption "WASTE" is displayed.

Example

Key Operation

WASTE
 000010
 000011

Display

CLERR0001	00001	MAIN-2	19 10	WASTE
1 PL000010		2.60		
1 PL000011		1.00		
		[J]		
***TOTAL		3.60		
1 PL000011	1.00			
		P1L01		

Mode caption

WASTE

CLERR0001	00001	SUB-1	19:13	REG
1 PL000010		2.60		
1 PL000011		1.00		
		[J]		
***TOTAL		3.60		
1 PL000011	1.00			
		P1L01		

Employee Function

You can use the following functions by using employee codes:

■ Clerk/manager sign-on

Clerks or managers can be signed on by entering employee codes, or they can be signed on by using employee cards. To use an employee card, you need a magnetic card reader (MCR). Contact your authorized SHARP dealer.

Use the following procedures:

• Clerk sign-on

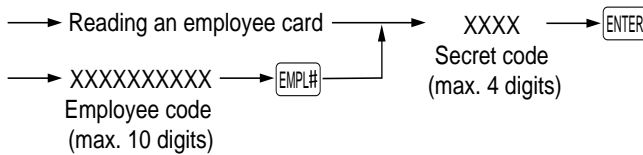

NOTE

In the case of "real clerk key system," sign-on cannot be done by this procedure.

• Manager sign-on

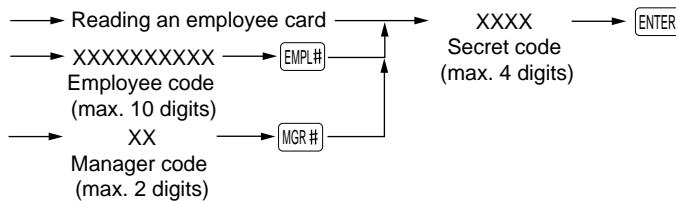

■ Employee's working time recording

You can manage the number of hours for which employees work.

The working time can be recorded by the following operations:

Time-in/out and break-in/out operations

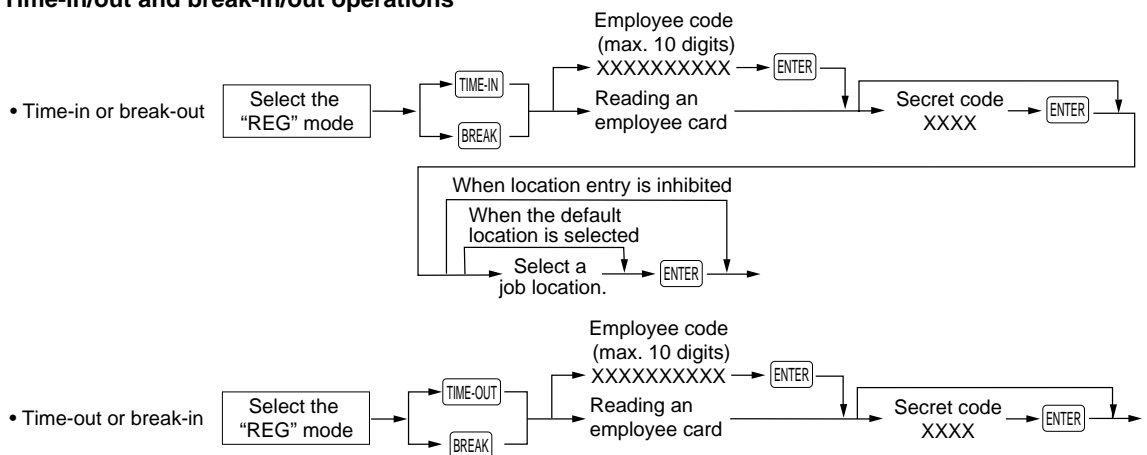

NOTE

- You can select a job location by using the key or list the selections by touching the key.
- The POS terminal allows a clerk to sign-on or off without checking the clerk's time-in or out.

Example

Key Operation

Employee code → 3 [TIME-IN] [ENTER]

Secret code → 1357 [ENTER]

[ENTER]

Display

```

CLERK0001
TIME-IN
ENTER EMPLOYEE# 0000000000
CANCEL ENTER
***TOTAL [J ]
0.000
P1L01
    
```

```

CLERK0001
ENTER SECRET#
ENTER SECRET#
CANCEL ENTER
***TOTAL [J ]
0.000
P1L01
    
```

```

CLERK0001
ENTER LOCATION#
ENTER LOCATION# CASHIER
CANCEL ENTER
***TOTAL [J ]
0.000
P1L01
    
```

Time-edit operation

A manager can edit employee's time-in/out data to record his or her time correctly.

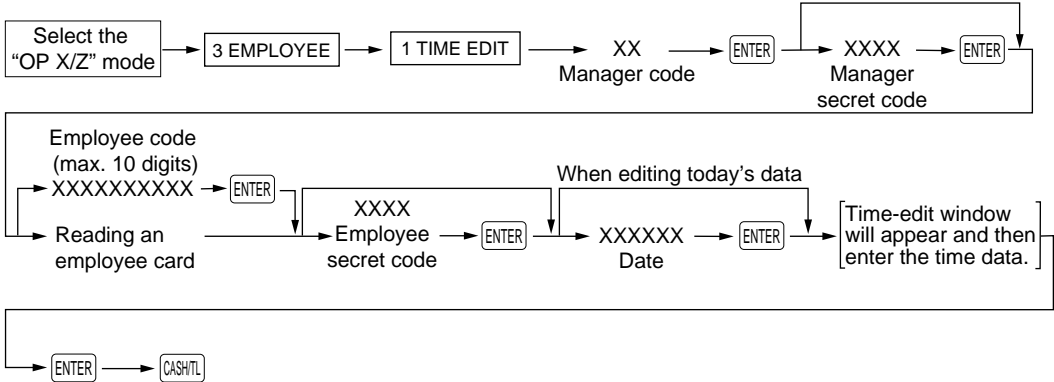

TRAINING Mode

The training mode is used when the operator or the manager practices POS terminal operations.

When a clerk set in training is selected, the POS terminal automatically enters the training mode. When a clerk not set in training is selected, the POS terminal automatically enters the ordinary REG mode. A training text and a maximum of two training clerks can be programmed. For programming of training clerk, contact your authorized SHARP dealer.

The training operations are valid in all modes.

A mark which is identifying a training receipt is printed on the receipt which is issued in the training mode.

The journal report completely stops in the training mode. The consecutive number is not updated. The preceding number is repeated in printing.

The memory in clerk is updated in the training mode. Other memories are not updated.

The GLU codes which are opened in the training mode are also printed on the GLU report. In this case, those GLU codes are distinguished from others by the character of "T." The data of training GLU codes are not added to the total.

The reading and resetting of training clerks is printed on the clerk reports. However, the sales total of training clerks is not included in the clerk total on the full clerk report.

Key Operation	Print
<div style="border: 1px solid black; padding: 5px; display: inline-block;">Selecting the clerk set in training</div>	
3	
000005	
X/QTY	
000003	
CASH/TL	
	<div style="border: 1px solid black; padding: 5px;"><p>15/12/99 123456 11:40 TOM</p><p style="text-align: center;">TRAINING</p><p>PL000005 *7.20 3x 5.00 PL000003 *15.00</p><p>CASH *22.20</p></div>

Supervisor Clerk

This function is used to substitute a supervisor clerk for an ordinary clerk. The supervisor clerk can make entry as an ordinary clerk by assigning the ordinary clerk code. You can use the supervisor clerk function only for substituting for an ordinary clerk. This function is available only in the real clerk key system.

To use this function, insert a real clerk key assigned supervisor clerk, enter the ordinary clerk code and touch the **CLK#** key. When you insert a supervisor clerk key and open an existing guest check, the original clerk who usually controls the guest check will automatically be assigned.

NOTE

This function is unavailable when the "overlapped clerk function" is enabled.

Procedure

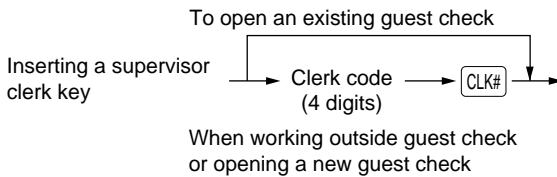

Example

- When opening a new guest check (GLU code 11) with this function:

Key Operation	Display																		
Inserting a supervisor clerk key 1 CLK# 11 OPEN THE TABLE 000001 NBAL	<table border="1" style="width: 100%; border-collapse: collapse;"> <tr> <td style="font-size: small;">GLU# 1 1</td> <td style="font-size: small;">CLERR0001</td> <td style="font-size: small;">00</td> </tr> <tr> <td style="text-align: center;">1 PL000001</td> <td></td> <td style="text-align: right;">1.20</td> </tr> <tr> <td colspan="3" style="text-align: right;">[J 1</td> </tr> <tr> <td>***TOTAL</td> <td></td> <td style="text-align: right;">1.20</td> </tr> <tr> <td>***NBAL</td> <td style="text-align: right;">1.20</td> <td></td> </tr> <tr> <td colspan="3" style="text-align: right;">P1L01</td> </tr> </table>	GLU# 1 1	CLERR0001	00	1 PL000001		1.20	[J 1			***TOTAL		1.20	***NBAL	1.20		P1L01		
GLU# 1 1	CLERR0001	00																	
1 PL000001		1.20																	
[J 1																			
***TOTAL		1.20																	
***NBAL	1.20																		
P1L01																			

- When receiving payment for the order stored in the GLU code 11:

Key Operation	Display																								
Inserting a supervisor clerk key 11 OPEN THE TABLE 120 CASH TL	<table border="1" style="width: 100%; border-collapse: collapse;"> <tr> <td style="font-size: small;">GLU# 1 1</td> <td style="font-size: small;">CLERR0001</td> <td style="font-size: small;">00</td> </tr> <tr> <td style="text-align: center;">1 PL000001</td> <td></td> <td style="text-align: right;">1.20</td> </tr> <tr> <td>CASH</td> <td></td> <td style="text-align: right;">1.20</td> </tr> <tr> <td>CHANGE</td> <td></td> <td style="text-align: right;">0.00</td> </tr> <tr> <td colspan="3" style="text-align: right;">[J 1</td> </tr> <tr> <td>***TOTAL</td> <td></td> <td style="text-align: right;">1.20</td> </tr> <tr> <td>CHANGE</td> <td style="text-align: right;">0.00</td> <td></td> </tr> <tr> <td colspan="3" style="text-align: right;">P1L01</td> </tr> </table>	GLU# 1 1	CLERR0001	00	1 PL000001		1.20	CASH		1.20	CHANGE		0.00	[J 1			***TOTAL		1.20	CHANGE	0.00		P1L01		
GLU# 1 1	CLERR0001	00																							
1 PL000001		1.20																							
CASH		1.20																							
CHANGE		0.00																							
[J 1																									
***TOTAL		1.20																							
CHANGE	0.00																								
P1L01																									

Overlapped Clerk Entry

This function allows to switch from one clerk to another clerk and to interrupt the first clerk's entry. So the second clerk can do his or her entry in this mode. Interrupt handling is possible only in the overlapped clerk entry. For actual use of this function, contact your authorized SHARP dealer.

NOTE

- The overlapped clerk entry is not effective while the tendering sale is going on.
- If any clerk is still making an entry (or has not finalized the transaction yet), the POS terminal does not run in any mode other than REG and MGR, and no X/Z reports can be printed. The message "CLERK REMAINED" is displayed at this time.

Example

- ① The entry by clerk1 is started.
- ② Clerk change (1 to 2), interrupt initiated
- ③ The transaction by clerk2 is finished.
- ④ Clerk change (2 to 1), entry restarted, transaction finished

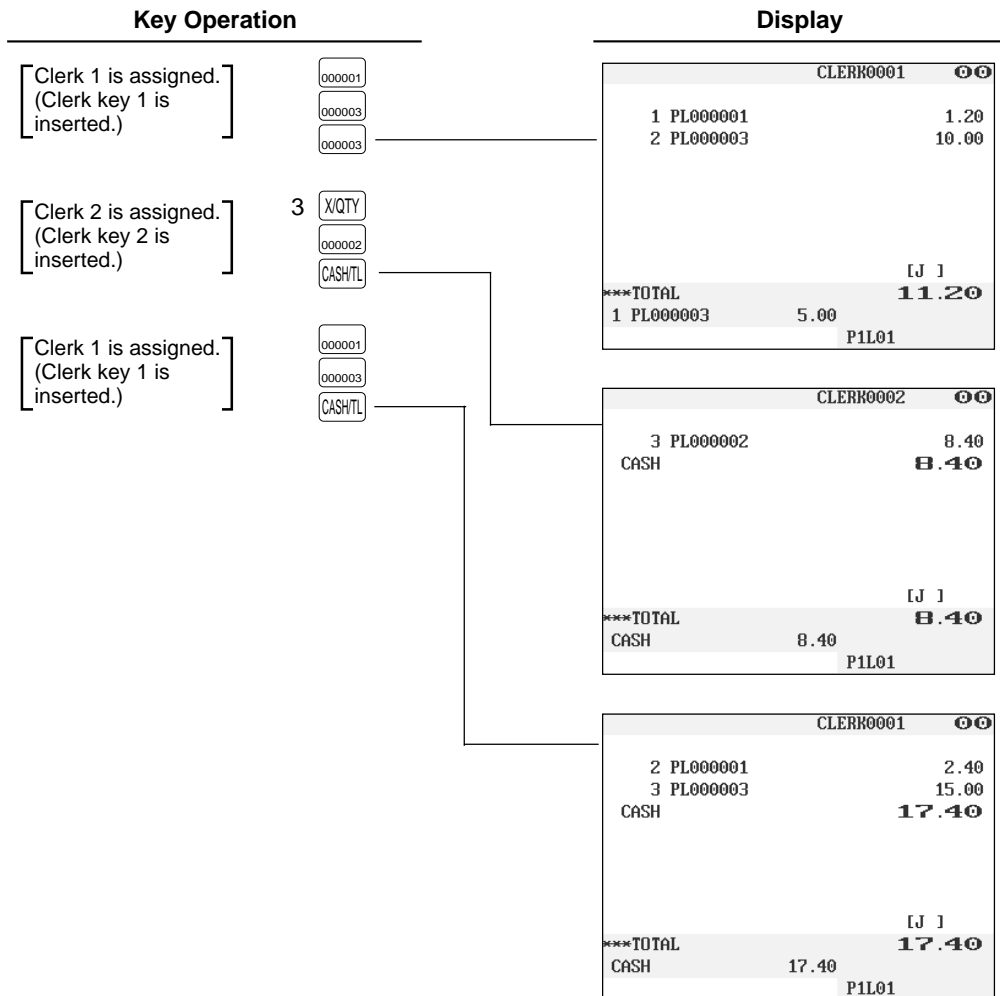

7

Correction

REG MODE

MGR MODE

Correction of the Last Entry (Direct Void)

If you make an incorrect entry relating to a department, PLU/subdepartment, percentage (%1 through %9), discount ((-1) through (-9)), item refund, or tip, you can void this entry by touching the VOID key immediately.

Example

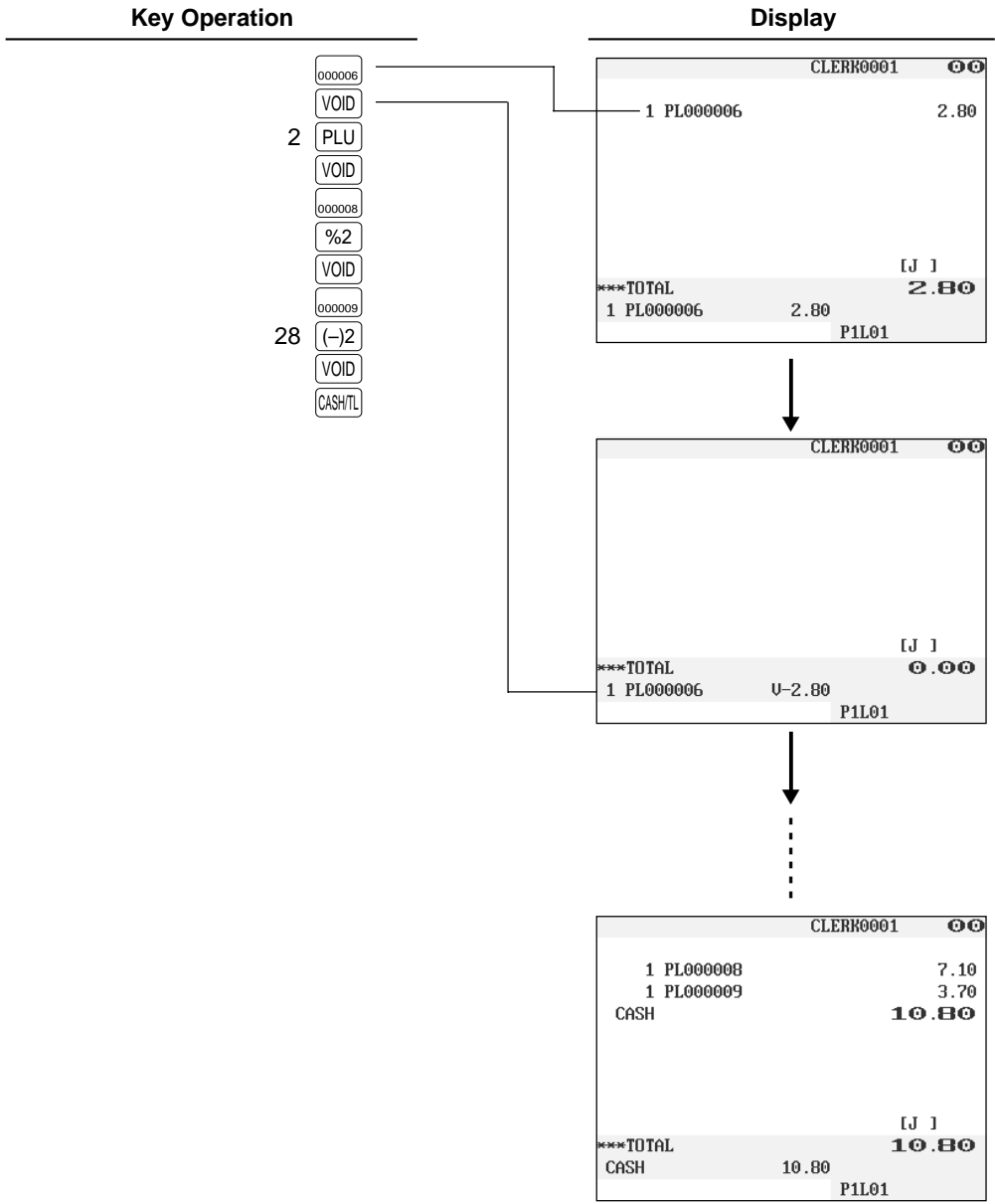

Correction of the Next-to-Last or Earlier Entries (Indirect Void)

With the **VOID** key you can void any incorrect plus department, plus PLU/subdepartment, or item refund entry made during a transaction if you find it before finalizing the transaction (e.g. before touching the **CASH/TL** key). This function is applicable to plus department, PLU/subdepartment, and item refund entries only.

Example

Indirect void by cursor control (Cursor Void)

Key Operation

000006
 000007
 10 **PLU**
 000008
 58 **PLU**
 000007

Display

CLERK0001		00
1	PL000006	2.80
2	PL000007	13.20
1	PL000010	2.60
1	PL000008	7.10
1	PL000058	5.00
		[J]
***TOTAL		30.70
1	PL000007	6.60
		P1L01

(Selected items)

[Selection by touch operation]

CLERK0001		00
1	PL000006	2.80
2	PL000007	13.20
1	PL000010	2.60
1	PL000008	7.10
1	PL000058	5.00
		[J]
***TOTAL		30.70
1	PL000007	6.60
		P1L01

VOID

CASH/TL

CLERK0001		00
1	PL000006	2.80
1	PL000007	6.60
1	PL000010	2.60
	CASH	12.00
		[J]
***TOTAL		12.00
	CASH	12.00
		P1L01

NOTE

The amount discount/premium entry and percent entry can be voided by cursor void operation.

Subtotal Void

You can void an entire transaction. Once subtotal void is executed, the transaction is aborted and the POS terminal issues a receipt.

Example

Key Operation	Display
	CLERK0001
	1 PL000001 1.20
	1 PL000006 2.80
10 [PLU]	1 PL000010 2.60
35 [PLU]	1 PL000035 2.00
[SUB TOTAL]	SBTL VD -8.60
[ST VOID]	***TOTAL 0.00
[SUB TOTAL]	[J]
	***TOTAL 0.00
	***TOTAL 0.00
	P1L01

Correction of Incorrect Entries Not Handled by the Direct, Indirect or Subtotal Void Function

Any errors found after the entry of a transaction has been completed or during an amount tendered entry cannot be voided. These errors must be handled by the manager.

The following steps should be taken.

1. If you are making an amount tendered entry, finalize the transaction.
2. Hand the incorrect receipt to your manager for its cancellation.

8

Special Printing Function

REG MODE

Copy Receipt Printing

If your customer wants a receipt after you have finalized a transaction with the receipt ON-OFF function in the "OFF" status (no receipting), touch the **RCPT** key for receipting. Your POS terminal can also print a copy receipt when the receipt ON-OFF function is in the "ON" status.

NOTE

To toggle the receipt ON-OFF status, use one of the following procedures:

- Select "01 RCP SW." from the window which is opened by touching the **MISC FUNCTIONS** key.
- Touch the **RCP SW** key to open the "RCP SW." window.

Example

Printing a receipt after making the entries shown below with the receipt ON-OFF function "OFF" status

Key Operation

000002
3 X/QTY
000001
CASH/TL

Print on the journal

Print

```

15/12/99      123456
11:53
JACK
PL000002      *2.80
3x 1.20
PL000001      *3.60
CASH          *6.40
    
```

For receipting → **RCPT**

Print on the receipt

```

15/12/99      123456
11:53
JACK
PL000002      *2.80
3x 1.20
PL000001      *3.60
CASH          *6.40
    
```

"COPY" is printed on the copy receipt.

```

15/12/99      123456
11:53
JACK
          *COPY*
PL000002      *2.80
3x 1.20
PL000001      *3.60
CASH          *6.40
    
```

Guest Check Copy

You can use this function when you want to take a copy of guest check. Touch the **GCCOPY** key and make a desired entry.

Procedure

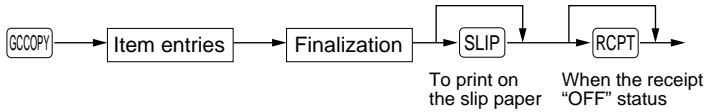

NOTE

- The guest check copy has nothing to do with the memory.
- The operation is the same as normal entry. But the validation printing is disabled and the drawer does not open.

Example

Key Operation	Print
<p>GCCOPY</p> <p>000001</p> <p>CASH/TL</p>	<pre> 15/12/99 123456 11:55 JACK *G. C COPY* PL000001 *1.20 CASH *1.20 </pre>

Validation Printing Function

The POS terminal can perform validation printing when it is connected with the slip printer. For the details of slip printer, contact your authorized SHARP dealer.

1. Set a validation slip to the slip printer.
2. Touch the **VP** key. The validation printing will start.

NOTE

Programmed compulsory validation printing can be overridden by performing the following operation. If you need this function, contact your authorized SHARP dealer.

1. Touch the **CANCEL** key in the special window.
2. Enter the manager code and touch the **ENTER** key, then enter the secret code and touch the **ENTER** key if applicable.

9

Manager Mode

MGR MODE

The manager mode is used when managerial decisions must be made concerning POS terminal entries, for example, for overriding limitations and for other various non-programming managerial tasks.

NOTE

Normal POS terminal operations may also be performed in this mode.

Entering the Manager Mode

To enter the manager mode, select the REG mode from the mode selection menu, then use the following procedure:

Procedure

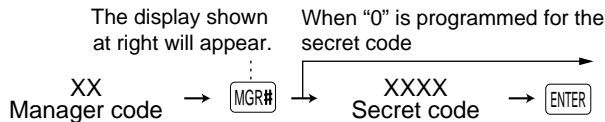

The manager code is stored in the manager file in advance. If the code entered is not found in this file, an error occurs. If the code is correct, it is printed on the journal and the POS terminal enters the manager mode.

Display

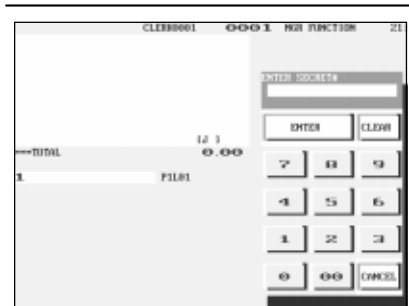

Override Entries

Programmed limits (such as maximum amounts) for functions can be overridden by placing the POS terminal in the manager mode.

Example

This example presumes that the POS terminal has been programmed not to allow coupon entries over 2.00.

Key Operation

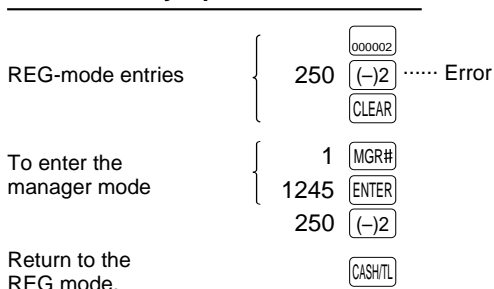

Display

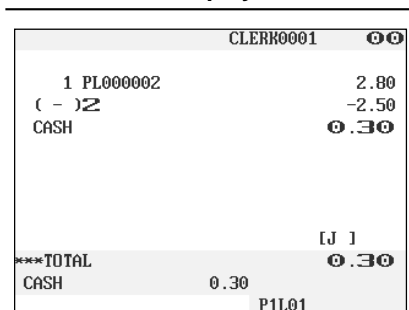

Tip Paid Entries

This operation is used when tips that guests have paid by using media other than cash (check or credit) are paid to respective clerks in cash.

You can make tip paid entries in the MGR mode only. The tips are paid to corresponding clerks according to their portions.

Procedure

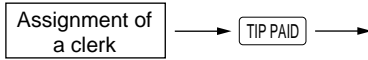

Example

Key Operation

(The clerk key is inserted.)

[TIP PAID]

Display

CLERK0001		00
TIP PAID		6.00
		[J]
***TOTAL		6.00
TIP PAID	6.00	
	P1L01	

Bill recording/Bill void

This bill information have to be recorded when BILL REPORT FILE was created (**Bill recording**). Each record contains "bill consecutive number", "clerk number", "issued date", and "amount".

The bill record can be voided from BILL REPORT FILE (**Bill void**). The voided bill number will be used on newly issuing bill to filling bill report completely.

Procedure

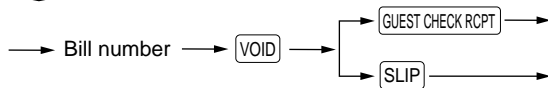

Example

Key Operation

5 [VOID]
[GUEST CHECK RCPT]

Print on the journal

15/12/99	123456
12:03	
JACK	
BILL VOID	0005

10

Correction after Finalizing a Transaction

MGR MODE

When you need to void incorrect entries that clerks cannot correct (incorrect entries that are found after finalizing a transaction or cannot be corrected by direct, indirect or subtotal void), follow this procedure in the MGR mode.

1. Enter the manager code and touch the **MGR#** key, then enter the secret code if applicable.
2. Touch the **VOID** key to put your POS terminal in the VOID mode. (Note the indication on the display.)
3. Repeat the entries that are recorded on an incorrect receipt. (All data in the incorrect receipt is removed from POS terminal memory; the voided amounts are added to the void mode totalizer.)

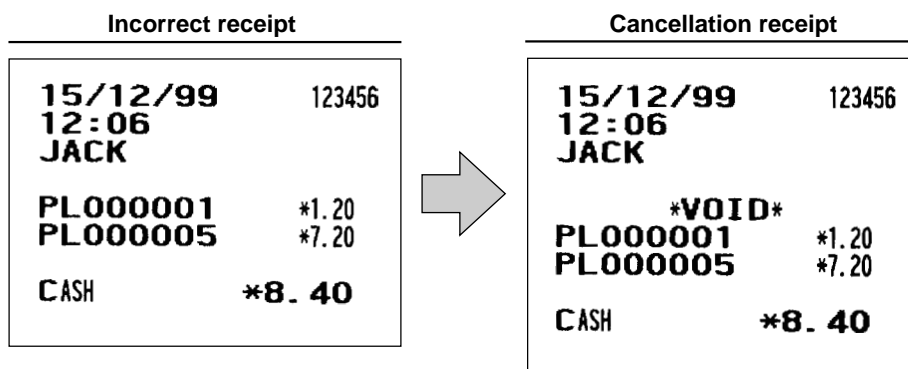

NOTE

Your POS terminal leaves the VOID mode whenever a transaction is canceled (i.e. finalized in the VOID mode). To void additional transactions, repeat steps **2.** and **3.** above.

11

Reading (X) and Resetting (Z) of Sales Totals

X1 / Z1 MODE

X2 / Z2 MODE

OPXZ MODE

- Use the reading function (X) when you need to take the reading of sales information entered after the last resetting. You can take this reading any number of times. It does not affect the POS terminal's memory.
- Use the resetting function (Z) when you need to clear the POS terminal's memory. Resetting prints all sales information and clears the entire memory except for the GT1 through GT3, reset count, and consecutive number.
- X1 and Z1 reports show daily sales information. You can take these reports in the X1/Z1 mode.
- X2 and Z2 reports show periodic (monthly) consolidation information. You can take these reports in the X2/Z2 mode.
- If your POS terminal is set "X1/Z1 report in the X2/Z2 mode" is "ENABLE," you can select the X1/Z1 report from the X2/Z2 mode. For details, contact your authorized SHARP dealer.

■ How to take a X1/Z1 or X2/Z2 report

[To take a X1 or X2 report:]

1. Select "1 READING" in the X1/Z1 or X2/Z2 mode menu window to display the items list.
2. Select an item listed in the table shown later.
3. If needed, enter corresponding values described in the "Data to be entered" column on the table shown later.
4. Select a device ("DISPLAY" or "REPORT PRINTER") to receive the output.

[To take a Z1 or Z2 report:]

1. Select "2 RESETTING" in the X1/Z1 or X2/Z2 mode menu window to display the items list.
2. Select an item listed in the table shown later.
3. If needed, enter corresponding values described in the "Data to be entered" column on the table shown later.
4. Select a device ("DISPLAY" or "REPORT PRINTER") to receive the output.
5. After the report has been taken, the message "ARE YOU SURE ?" will appear.
Select one of the following actions:
 - Select "YES" to reset the sales information.
 - Select "NO" to save the sales information.

Item	Description	Available report type in each mode		Data to be entered
		X1/Z1	X2/Z2	
1 GENERAL	General	X1, Z1	X2, Z2	
2 DEPT./GROUP	Department by designated range	X1	X2	Starting department code/ ending department code
3 DEPT.IND. GROUP	Individual group total of departments	X1	X2	Department group no.
4 DEPT.GROUP TOTAL	Full group total of departments	X1	X2	
5 PLU	PLU by designated range	X1, Z1	X2, Z2	Starting PLU code/ending PLU code
6 COMBO SALES	Combo sales	X1	X2	Starting PLU code/ending PLU code
7 PLU BY DEPT	PLU by associated dept.	X1, Z1	X2, Z2	Department code
8 PLU IND. GROUP	Individual group of PLUs	X1	X2	PLU group no.
9 PLU GROUP TOTAL	Full group total of PLUs	X1	X2	
10 PLU STOCK	PLU stock	X1		Starting PLU code/ending PLU code
11 PLU COST	PLU cost	X1	X2	Starting PLU code/ending PLU code
12 PLU TOP 20	PLU top 20	X1	X2	Amount or q'ty
13 PLU ZERO SALES	PLU zero sales	X1	X2	All
	PLU zero sales by department	X1	X2	Department code
14 PLU MIN. STOCK	PLU minimum stock	X1		Starting PLU code/ending PLU code
15 PLU HOURLY GROUP	PLU group by hour	X1, Z1		Start time/ending time
16 TRANSACTION	Transaction	X1	X2	
17 TL-ID	Total in drawer	X1		
18 COMMISSION SALES	Commission sales	X1	X2	
19 TAX	Tax	X1	X2	
20 CHIEF	Chief	X1		
21 ALL CLERK	Full clerk	X1, Z1	X2, Z2	
22 IND. CLERK	Individual clerk	X1, Z1	X2, Z2	
		(OP X/Z mode)	X, Z	

Item	Description	Available report type in each mode		Data to be entered
		X1/Z1	X2/Z2	
23 DD ERROR	Drink dispenser error reading	X1, Z1		
24 DD RESET	Drink dispenser resetting	Z1		
25 EMPLOYEE	Employee		X2, Z2	Start employee code/ ending employee code
26 EMP. ADJUSTMENT	Employee time adjustment		X2	Start employee code/ ending employee code
27 EMP. ACTIVE STS.	Employee active status		X2	Start employee code/ ending employee code
28 HOURLY	Hourly (full)	X1, Z1		
	Hourly (by range)	X1		Start time/ending time
29 LABOR COST%	Labor cost %	X1		
30 OVER TIME	Over time		X2, Z2	Start employee code/ ending employee code
31 DAILY NET	Daily net		X2, Z2	
32 INGREDIENT STOCK	Ingredient stock	X1		Ingredient no.
33 GLU	GLU/PBLU	X1, Z1		Start GLU/PBLU code/ ending GLU/PBLU code
34 GLU BY CLERK	GLU/PBLU by clerk	X1, Z1		
35 BILL	Bill report	X1, Z1		
36 DRIVE THRU	Drive-through	X1, Z1		Start drive-through code/ ending drive-through code
37 D-THRU BY CLERK	Drive-through by clerk	X1, Z1		
38 SERVICE TIME	Drive-through service time	X1, Z1		
39 BALANCE	Balance	X1	X2	
40 STACKED REPORT	Stacked report 1	X1, Z1	X2, Z2	
	Stacked report 2	X1, Z1	X2, Z2	

Daily Sales Totals

General report

Sample X report

16/12/99 [0001] 123456		
#2015	21:33	CLERK0001
X1		
DEPT. /GROUP		
D01	533.000 Q	70.21%
DPT.01		*1234.71
D02	5.000 Q	1.31%
DPT.02		*22.98
GROUP1	538.000 Q	71.51%
		*1257.69
D03	97.000 Q	27.29%
DPT.03		*479.91
GROUP2	97.000 Q	27.29%
		*479.91
D04	4.000 Q	1.20%
DPT.04		*21.09
GROUP9	4.000 Q	1.20%
		*21.09
*DEPT TL	639.000 Q	100.00%
		*1758.69

D05	4.000 Q	-15.71
DPT.05		
DEPT(-)	4.000 Q	-15.71
D06	1.000 Q	*4.25
DPT.06		
*HASH TL	1.000 Q	*4.25
D07	2.000 Q	-2.66
DPT.07		
HASH(-)	2.000 Q	-2.66
D08	2.000 Q	-0.29
DPT.08		
*NT TL1	2.000 Q	-0.29
D09	3.000 Q	*4.27
DPT.09		
*NT TL2	3.000 Q	*4.27

Sample Z report

16/12/99 [0001] 123456		
#2094	23:30	CLERK0001
Z1		
GENERAL Z1		0006
GT1	*00000004995.61	
GT2	*00000011859.22	
GT3	-00000006863.61	
BAL	*00000000180.55	
TR	*00000000071.20	

↓
The subsequent printout occurs in the same format as in the sample X1 report.

- Read symbol
- Report title
- Dept. code
- Sales q'ty
- Ratio of dept. 1 sales amount to "+" dept. total
- Sales amount
- Dept. description
- Ratio of dept. group 1 sales amount to "+" dept. total
- Group 1 total amount
- Group 1 total q'ty
- Group 1 text
- "+" dept. sales q'ty and total
- "-" dept. counter and total
- "+" hash dept. counter and total
- "-" hash dept. counter and total
- Non-turnover 1 counter and total
- Non-turnover 2 counter and total
- Reset counter
- Net grand total (GT2-GT3)
- Grand total of plus registration
- Grand total of minus registration
- Order - paid total
- Grand total of training-mode registrations

D10 2.000 Q
DPT. 10 *4.20
***NT TL3** 2.000 Q *4.20

} Non-turnover 3 counter and total

TRANSACTION

Report title

(-) 1 1 Q -0.25
(-) 2 1 Q -0.15
(-) 3 2 Q -0.46
(-) 4 1 Q -0.11
%1 2 Q -5.20
%2 1 Q *6.32
%3 1 Q -5.81
%4 1 Q -5.12
NET 1 *1732.20

Subtotal (-) counter and total

Subtotal % counter and total

Net sales total

TAX1 ST *1266.58
VAT 1 *88.37
TAX2 ST *22.60
VAT 2 *0.66
TAX3 ST *90.10
VAT 3 *3.47
TAX4 ST *50.40
VAT 4 *2.40
TAX5 ST *105.60
VAT 5 *2.07
TAX6 ST *106.50
VAT 6 *1.05
TTL TAX *98.02
NET *1634.18
VAT SFT *7.60
TAX DELE *3.70
SER. CHRG *0.27

Taxable 1 total

VAT 1 total

Tax total

Net sales total without VAT

VAT shift total

Tax delete total

Service charge total

(-) 5 1 Q -0.15
(-) 6 1 Q -0.12
(-) 7 1 Q -0.10
(-) 8 1 Q -0.21
%5 1 Q -0.08
%6 1 Q -0.17
%7 1 Q -0.35
%8 1 Q -0.14

Item (-) counter and total

Item % counter and total

DISCOUNT 0 Q *0.00
CP PLU 2 Q -0.72
REFUND 2 Q *4.00
VD 0 Q *0.00
VOID 1 Q *9.00
MGR VD 3 Q *9.00
SBTL VD 1 Q *9.00
WASTE TL 37 Q *90.40
RETURN 2 Q *6.20
HASH VD 0 Q *0.00
HASH RF 1 Q *1.20
HASH RT 1 Q *1.50
NOTURNVD 0 Q *0.00
NOTURNRF 1 Q *5.20
NOTURNRT 1 Q *3.20

Coupon-like PLU counter and total

Refund counter and total

REG-mode item void counter and total

Void-mode transaction counter and total

Manager item void counter and total

Subtotal void counter and total

Waste mode transaction

Return counter and total

Hash item void counter and total

Hash item refund counter and total

Hash item return counter and total

Non-turnover item void counter and total

Non-turnover item refund counter and total

Non-turnover item return counter and total

VP CNT	0 Q		Validation print counter
BILL CNT	2 Q		Bill print counter
NO SALE	2 Q		No-sale (exchange) counter
***PBAL	10 Q		GLU/PBLU counter
***PBAL2	4 Q		Drive-through counter
***NBAL	6 Q		NBAL counter (for GLU/PBLU)
***NBAL2	3 Q		NBAL counter (for drive-through)
G. C. CNT	2 Q		Guest check copy counter
GUEST	89 Q		Guest counter
ORDER TL		*1734.06	Order total
PAID TL		*1697.96	Paid total
AVE.		*19.08	Paid total average per guest
O-P		*36.10	Order total - paid total
TRAN. OUT	2 Q	*14.20	Trans out counter and total
TRAN. IN	1 Q	*9.00	Trans in counter and total
BILL BAL	1 Q	*5.20	Bill balance (Trans out - trans in) counter and total
SCM (+)		*805.00	Starting cash memory (+)
SCM (-)		-400.00	Starting cash memory (-)
SCM TTL		*405.00	Starting cash memory total
***RA	4 Q	*375.25	Received-on-account counter and total
***RA2	1 Q	*100.00	
(-) 9	1 Q	-1.00	Received-on-account (-) counter and total
%9	1 Q	-0.75	Received-on-account % counter and total
***PO	1 Q	*100.00	Paid-out counter and total
***PO2	1 Q	*150.00	
CA/CHK	1 Q	*12.00	Check cashing counter and total
CA/CHK4	1 Q	*7.00	
DEPOSIT	1 Q	*12.00	Deposit (+) counter and total
DEPO. (-)	1 Q	-10.00	Deposit (-) counter and total
CASH TIP	2 Q	*2.10	Cash tip counter and total
NOCA TIP	1 Q	*1.50	Non-cash tip counter and total
TIP PAID	1 Q	*3.60	Tip paid counter and total
HOTEL TRANS.	0 Q	*0.00	Hotel transfer counter and total
CASH	76 Q	*1375.30	Cash counter and total
CASH2	0 Q	*0.00	Cash 2 counter and total
CHECK	7 Q	*83.40	Check sale counter and total
CHECK4	1 Q	*9.00	
CREDIT1	1 Q	*78.42	Credit 1 sale and tendering counter and total
CREDIT8	1 Q	*16.00	
EXCH1	2 Q	24.15	Exchange 1 counter and total
DOM. CUR1		*39.80	
EX1CH+CR	1 Q	21.37	
DOM. CHK/CR 1		*35.21	
EXCH8	0 Q	0.00	
DOM. CUR8		*0.00	
EXCH9	1 Q	12.00	
DOM. CUR9		*14.80	
***CID		*1953.67	Cash in drawer
*CH ID		*159.90	Check in drawer
CA/CK ID		*2113.57	Cash+check in drawer
CHK/CG		*9.60	Change total for check tendering

■ Department report

• Sample X report

16/12/99 [0001] 123456		
#2020 21:35 CLERK0001		
X1		
DEPT./GROUP		Dept. code
D01	533.000 Q	70.21%
DPT. 01		*1234.71
D02	5.000 Q	1.31%
DPT. 02		*22.98
GROUP1	538.000 Q	71.51%
		*1257.69
D03	97.000 Q	27.29%
DPT. 03		*479.91
GROUP2	97.000 Q	27.29%
		*479.91
D04	4.000 Q	1.20%
DPT. 04		*21.09
GROUP9	4.000 Q	1.20%
		*21.09
*DEPT TL	639.000 Q	100.00%
		*1758.69
D05	4.000 Q	-15.71
DPT. 05		
DEPT (-)	4.000 Q	-15.71
D06	1.000 Q	*4.25
DPT. 06		
*HASH TL	1.000 Q	*4.25
D07	2.000 Q	-2.66
DPT. 07		
HASH (-)	2.000 Q	-2.66
D08	2.000 Q	-0.29
DPT. 08		
*NT TL1	2.000 Q	-0.29
D09	3.000 Q	*4.27
DPT. 09		
*NT TL2	3.000 Q	*4.27
D10	2.000 Q	*4.20
DPT. 10		
*NT TL3	2.000 Q	*4.20

■ Individual group total report on departments

16/12/99 [0001] 123456		
#2021 21:36 CLERK0001		
X1		
DEPT. IND. GROUP		Dept. code
D01	533.000 Q	
DPT. 01		*1234.71
D02	5.000 Q	
DPT. 02		*22.98
GROUP1	538.000 Q	
		*1257.69

■ Full group total report on departments

16/12/99 [0001] 123456		
#2022 21:36 CLERK0001		
X1		
DEPT. GROUP TOTAL		Dept. code
GROUP1	538.000 Q	71.51%
		*1257.69
GROUP2	97.000 Q	27.29%
		*479.91
GROUP9	4.000 Q	1.20%
		*21.09
*DEPT TL	639.000 Q	100.00%
		*1758.69
DEPT (-)	4.000 Q	-15.71
*HASH TL	1.000 Q	*4.25
HASH (-)	2.000 Q	-2.66
*NT TL1	2.000 Q	-0.29
*NT TL2	3.000 Q	*4.27
*NT TL3	2.000 Q	*4.20

■ PLU report by designated range

• Sample X report

16/12/99 [0001] 123456
#2025 21:43 CLERK0001

X1

PLU

PLU code
Description (price-1)
PLU range

PLU	Description	QTY	PRICE
000001-000020			
P000001			
PLO00001	175.000 Q		*209.34
WASTE	-3.000 Q		-3.60
PLO00001	10.000 Q		*17.50
WASTE	-1.000 Q		-1.75
PLO00001	8.000 Q		*14.40
WASTE	-2.000 Q		-3.60
PLO00001	12.000 Q		*30.00
WASTE	-3.000 Q		-7.50
PLO00001	12.000 Q		*27.00
WASTE	-2.000 Q		-4.50
PLO00001	12.000 Q		*37.20
WASTE	-3.000 Q		-9.30
PLO00001	12.000 Q		*26.16
WASTE	-2.000 Q		-4.36
P000002			

Sales q'ty and total for price level 1
Waste q'ty and total for price level 1
Sales and waste for price level 7

• Sample Z report

16/12/99 [0001] 123456
#2095 23:31 CLERK0001

Z1

PLU

↓
The subsequent printout occurs in the same format as in the sample X report.

P000020			
PLO00020	2.000 Q		*3.30
***TOTAL			
L1	466.000 Q		*1307.16
WASTE	-6.000 Q		-14.20
L2	18.000 Q		*38.10
WASTE	-3.000 Q		-6.75
L3	16.000 Q		*28.40
WASTE	-3.000 Q		-5.35
L4	25.000 Q		*83.95
WASTE	-4.000 Q		-11.65
L5	24.000 Q		*65.40
WASTE	-6.000 Q		-17.30
L6	24.000 Q		*64.56
WASTE	-6.000 Q		-16.14
L7	24.000 Q		*47.76
WASTE	-7.000 Q		-13.36

Total sales q'ty and total for price level 1
Total waste q'ty and total for price level 1
Total for price level 7

COMBO MEAL			
P000014			
PLO00014	6.000 Q		*14.10
WASTE	-1.000 Q		-2.35
P000017			
PLO00017	7.000 Q		*19.80
WASTE	-1.000 Q		-3.30
***TOTAL			
L1	13.000 Q		*33.90
WASTE	-2.000 Q		-5.65
L2	0.000 Q		*0.00
WASTE	0.000 Q		*0.00
L3	0.000 Q		*0.00
WASTE	0.000 Q		*0.00
L4	0.000 Q		*0.00
WASTE	0.000 Q		*0.00
L5	0.000 Q		*0.00
WASTE	0.000 Q		*0.00
L6	0.000 Q		*0.00
WASTE	0.000 Q		*0.00
L7	0.000 Q		*0.00
WASTE	0.000 Q		*0.00

Combo meal PLU sales
Total for combo meal PLU sales

■ Combo sales report

• Sample X report

16/12/99 [0001] 123456		
#2026	21:50	CLERK0001
X1		
COMBO SALES		
		000001-000020
P000015		
PL000015	0.000 Q	*0.00
COMBO	12.000 Q	*13.20
COMBO WASTE	-2.000 Q	-2.20

PLU code
Description (price-1)
PLU range

Combo sales counter and total

Combo waste counter and total

P000018			
PL000018	1.000 Q	*0.00	
COMBO	6.000 Q	*13.20	
COMBO WASTE	-1.000 Q	-2.20	
***TOTAL			
L1	2.000 Q	*0.00	} Total for price level 1
WASTE	0.000 Q	*0.00	
COMBO	24.000 Q	*33.90	
COMBO WASTE	-4.000 Q	-5.65	
L2	0.000 Q	*0.00	} Total for price level 7
WASTE	0.000 Q	*0.00	
COMBO	0.000 Q	*0.00	
COMBO WASTE	0.000 Q	*0.00	
L3	0.000 Q	*0.00	
WASTE	0.000 Q	*0.00	
COMBO	0.000 Q	*0.00	
COMBO WASTE	0.000 Q	*0.00	
L4	0.000 Q	*0.00	} Total for price level 7
WASTE	0.000 Q	*0.00	
COMBO	0.000 Q	*0.00	
COMBO WASTE	0.000 Q	*0.00	
L5	0.000 Q	*0.00	
WASTE	0.000 Q	*0.00	
COMBO	0.000 Q	*0.00	
COMBO WASTE	0.000 Q	*0.00	
L6	0.000 Q	*0.00	} Total for price level 7
WASTE	0.000 Q	*0.00	
COMBO	0.000 Q	*0.00	
COMBO WASTE	0.000 Q	*0.00	
L7	0.000 Q	*0.00	
WASTE	0.000 Q	*0.00	
COMBO	0.000 Q	*0.00	
COMBO WASTE	0.000 Q	*0.00	

■ PLU report by associated department

• Sample X report

16/12/99 [0001]123456		
#2027 21:53 CLERK0001		
X1		
PLU BY DEPT		
DPT.		D03
P000003		
PL000003	58.000 Q	*289.65
WASTE	-1.000 Q	-5.00
PL000003	1.000 Q	*3.10
P000006		
PL000006	18.000 Q	*50.40
P000007		
PL000007	16.000 Q	*105.60
***TOTAL		
L1	92.000 Q	*445.65
WASTE	-1.000 Q	-5.00
COMBO	0.000 Q	*0.00
COMBO WASTE	0.000 Q	*0.00
L2	1.000 Q	*3.10
WASTE	0.000 Q	*0.00
COMBO	0.000 Q	*0.00
COMBO WASTE	0.000 Q	*0.00
L3	0.000 Q	*0.00
WASTE	0.000 Q	*0.00
COMBO	0.000 Q	*0.00
COMBO WASTE	0.000 Q	*0.00
L4	0.000 Q	*0.00
WASTE	0.000 Q	*0.00
COMBO	0.000 Q	*0.00
COMBO WASTE	0.000 Q	*0.00
L5	0.000 Q	*0.00
WASTE	0.000 Q	*0.00
COMBO	0.000 Q	*0.00
COMBO WASTE	0.000 Q	*0.00
L6	0.000 Q	*0.00
WASTE	0.000 Q	*0.00
COMBO	0.000 Q	*0.00
COMBO WASTE	0.000 Q	*0.00
L7	0.000 Q	*0.00
WASTE	0.000 Q	*0.00
COMBO	0.000 Q	*0.00
COMBO WASTE	0.000 Q	*0.00

• Sample Z report

16/12/99 [0001]123456		
#2097 23:33 CLERK0001		
Z1		
PLU BY DEPT		

↓

The subsequent printout occurs in the same format as in the sample X report.

■ Individual group report on PLUs

16/12/99 [0001]123456		
#2034	22:00	CLERK0001
X1		
PLU IND. GROUP		
P000008		PLU code
PL000008	15.000 Q	*106.50
P000009		Sales q'ty and amount for price level 1
PL000009	12.000 Q	*44.40
PLU GR99	27.000 Q	8.58%
		*150.90
		Group 99 sales q'ty and total
*DEPT TL	639.000 Q	100.00%
		*1758.69
		Plus dept. total

■ PLU stock report

16/12/99 [0001]123456		
#2036	22:03	CLERK0001
X1		
PLU STOCK		
	000001-000020	Range
P000001		PLU code
PL000001	62.000 S	Stock q'ty
P000002		Description
PL000002	18.000 S	
P000003		
PL000003	4.000 S	
P000020		
PL000020	18.000 S	

■ Full group total report on PLUs

16/12/99 [0001]123456		
#2035	22:01	CLERK0001
X1		
PLU GROUP TOTAL		
PLU GRO0	0.000 Q	0.00%
		*0.00
PLU GRO1	294.000 Q	31.51%
		*554.08
PLU GRO2	265.000 Q	49.06%
		*862.85
PLU GRO3	0.000 Q	0.00%
		*0.00
PLU GR99	27.000 Q	8.58%
		*150.90
*DEPT TL	639.000 Q	100.00%
		*1758.69
		Plus dept. total

■ PLU cost report

16/12/99 [0001] 123456		
#2037 22:05 CLERK0001		
X1		
PLU COST		
	000001-000020	PLU code Range
P000001		Item cost for price level 1
PLO00001	175.000 Q	*209.34 Sales amount for price level 1
COST	*0.95	*166.25 Usage cost for price level 1 = Item cost x Sales q'ty
COST%		85.37% PLU cost% for price level 1 = Usage cost/Sales amount-VAT-Service charge
PLO00001	10.000 Q	*17.50
COST	*1.15	*11.50
COST%		70.64%
PLO00001	8.000 Q	*14.40
COST	*1.10	*8.80
COST%		65.67% Sales q'ty for price level 3
PLO00001	12.000 Q	*30.00
COST	*1.05	*12.60
COST%		45.15% Description
PLO00001	12.000 Q	*27.00
COST	*1.10	*13.20
COST%		52.55%
PLO00001	12.000 Q	*37.20
COST	*1.20	*14.40
COST%		41.62%
PLO00001	12.000 Q	*26.16
COST	*1.12	*13.44
COST%		55.24% Sales q'ty and amount for price level 7
P000002		
P000020		
PLO00020	2.000 Q	*3.30
COST	*0.95	*1.90
COST%		61.89%
***TOTAL	621.000 Q	*1669.23 Total sales q'ty and total sales amount
TTL COST		*473.23 Total cost
COST%		29.55% Cost%
COMBO MEAL		
P000014		
PLO00014	6.000 Q	*14.10
COST	*0.95	*5.70
COST%		43.45%
P000017		
PLO00017	7.000 Q	*19.80
COST	*0.95	*6.65
COST%		36.10%
***TOTAL	13.000 Q	*33.90
TTL COST		*12.35
COST%		39.16%

■ PLU top 20 report

• By amount

16/12/99 [0001] 123456
#2038 22:09 CLERK0001

X1
PLU TOP 20
AMOUNT

Ranking	PLU code	Sales q'ty for price level 1	Sales amount for price level 1	Description
	01			
	P000002			
	PL000002	142.000 Q	*397.29	
	PL000002	7.000 Q	*17.50	
	PL000002	8.000 Q	*14.00	
	PL000002	13.000 Q	*53.95	
	PL000002	12.000 Q	*38.40	
	PL000002	12.000 Q	*27.36	
	PL000002	12.000 Q	*21.60	
	02			
	P000001			
	PL000001	175.000 Q	*209.34	
	PL000001	10.000 Q	*17.50	
	PL000001	8.000 Q	*14.40	
	PL000001	12.000 Q	*30.00	
	PL000001	12.000 Q	*27.00	
	PL000001	12.000 Q	*37.20	
	PL000001	12.000 Q	*26.16	

20

P000019			
PL000019	2.000 Q	-0.72	
PL000019	0.000 Q	*0.00	
PL000019	0.000 Q	*0.00	
PL000019	0.000 Q	*0.00	
PL000019	0.000 Q	*0.00	
PL000019	0.000 Q	*0.00	
PL000019	0.000 Q	*0.00	
PL000019	0.000 Q	*0.00	
***TOTAL	503.000 Q	*1374.96	
L2	18.000 Q	*38.10	
L3	16.000 Q	*28.40	
L4	25.000 Q	*83.95	
L5	24.000 Q	*65.40	
L6	24.000 Q	*64.56	
L7	24.000 Q	*47.76	

Total sales q'ty for price level 1
Total sales amount for price level 1

• By q'ty

16/12/99 [0001] 123456
#2039 22:13 CLERK0001

X1
PLU TOP 20
QUANTITY

Ranking	PLU code	Sales q'ty for price level 1	Sales amount for price level 1	Description
	01			
	P000001			
	PL000001	175.000 Q	*209.34	
	PL000001	10.000 Q	*17.50	
	PL000001	8.000 Q	*14.40	
	PL000001	12.000 Q	*30.00	
	PL000001	12.000 Q	*27.00	
	PL000001	12.000 Q	*37.20	
	PL000001	12.000 Q	*26.16	
	02			
	P000002			
	PL000002	142.000 Q	*397.29	
	PL000002	7.000 Q	*17.50	
	PL000002	8.000 Q	*14.00	
	PL000002	13.000 Q	*53.95	
	PL000002	12.000 Q	*38.40	
	PL000002	12.000 Q	*27.36	
	PL000002	12.000 Q	*21.60	

20

P000013			
PL000013	0.000 Q	*0.00	
PL000013	0.000 Q	*0.00	
PL000013	0.000 Q	*0.00	
PL000013	0.000 Q	*0.00	
PL000013	0.000 Q	*0.00	
PL000013	0.000 Q	*0.00	
PL000013	0.000 Q	*0.00	
PL000013	0.000 Q	*0.00	
***TOTAL	503.000 Q	*1374.96	
L2	18.000 Q	*38.10	
L3	16.000 Q	*28.40	
L4	25.000 Q	*83.95	
L5	24.000 Q	*65.40	
L6	24.000 Q	*64.56	
L7	24.000 Q	*47.76	

■ PLU zero sales report (full)

16/12/99 [0001]123456	
#2040	22:16 CLERK0001
X1	
PLU ZERO SALES	
P000010	PL000010
P000011	PL000011
P000012	PL000012
P000013	PL000013

PLU code
Description

■ PLU minimum stock report

16/12/99 [0001]123456	
#2042	22:19 CLERK0001
X1	
PLU MIN. STOCK	
	000001-000020
P000003	
PL000003	4.000 S
P000008	
PL000008	3.000 S
P000010	
PL000010	7.000 S
P000011	
PL000011	11.000 S
P000012	
PL000012	16.000 S
P000014	
PL000014	15.000 S
P000015	
PL000015	16.000 S

Range
PLU code
Stock q'ty
Description

■ PLU zero sales report (by dept.)

16/12/99 [0001]123456	
#2041	22:17 CLERK0001
X1	
PLU ZERO SALES	
DPT. 01	D01
P000010	PL000010
P000011	PL000011

Description of dept.
Associated dept. code
PLU code

■ PLU group total report by hour

• Sample X report

16/12/99 [0001] 123456		
#2043	22:20	CLERK0001
X1		
PLU HOURLY GROUP		
14:00		
HOUR GR1	39.000 Q	*92.40
HOUR GR2	26.000 Q	*55.75
HOUR GR3	39.000 Q	*92.40
HOUR GR4	26.000 Q	*55.75
HOUR GR5	39.000 Q	*92.40
HOUR GR6	26.000 Q	*55.75
HOUR GR7	29.000 Q	*129.60
HOUR GR8	29.000 Q	*129.60
HOUR GR9	29.000 Q	*129.60
14:30		
HOUR GR1	14.000 Q	*28.20
HOUR GR2	9.000 Q	*23.65
HOUR GR3	14.000 Q	*28.20
HOUR GR4	9.000 Q	*23.65
HOUR GR5	14.000 Q	*28.20
HOUR GR6	9.000 Q	*23.65
16:00		
HOUR GR1	97.000 Q	*206.90
HOUR GR2	88.000 Q	*240.00
HOUR GR3	97.000 Q	*206.90
HOUR GR4	88.000 Q	*240.00
HOUR GR5	97.000 Q	*206.90
HOUR GR6	88.000 Q	*240.00
HOUR GR7	1.000 Q	*7.20
HOUR GR8	1.000 Q	*7.20
HOUR GR9	1.000 Q	*7.20

Time
Transaction counter
Sales total

• Sample Z report

16/12/99 [0001] 123456		
#2098	23:35	CLERK0001
Z1		
PLU HOURLY GROUP		

↓
The subsequent printout occurs in the same format as in the sample X report.

■ Total in drawer report

• Sample X report

16/12/99 [0001] 123456		
#2046	22:25	CLERK0001
X1		
TL-ID		
EXCH1	2 Q	24.15
DOM. CUR1		*39.80
EX1CH+CR	1 Q	21.37
DOM. CHK/CR 1		*35.21
EXCH2	0 Q	0.00
DOM. CUR2		*0.00
EXCH3	0 Q	0.00
DOM. CUR3		*0.00
EXCH4	0 Q	0.00
DOM. CUR4		*0.00
EXCH5	0 Q	0.00
DOM. CUR5		*0.00
EXCH6	0 Q	0.00
DOM. CUR6		*0.00
EXCH7	0 Q	0.00
DOM. CUR7		*0.00
EXCH8	0 Q	0.00
DOM. CUR8		*0.00
EXCH9	1 Q	12.00
DOM. CUR9		*14.80
****CID		*1953.67
*CH ID		*159.90
CA/CK ID		*2113.57

Exchange 1 counter
Currency exchange 1 total
Domestic currency for currency exchange 1 total
Total in drawer
Check in drawer
Cash + check in drawer

■ Transaction report

• Sample X report

16/12/99 [0001] 123456		
#2047	22:25	CLERK0001
X1		
TRANSACTION		
*DEPT TL	639.000 Q	*1758.69
DEPT (-)	4.000 Q	-15.71
*HASH TL	1.000 Q	*4.25
HASH (-)	2.000 Q	-2.66
*NT TL1	2.000 Q	-0.29
*NT TL2	3.000 Q	*4.27
*NT TL3	2.000 Q	*4.20

Plus dept. total
Minus dept. total
Hash dept. total
Hash minus total
Non-turnover 1 total

↓
In this report, the same transaction data as those printed in the general report are printed.

■ Commission sales report

16/12/99	[0001] 123456
#2048 22:27	CLERK0001
X1	
COMMISSION SALES	
COM. SAL1	*29.23
COM. AMT1	*0.58
COM. SAL2	*86.40
COM. AMT2	*2.59
COM. SAL3	*50.40
COM. AMT3	*0.76
COM. TTL	*3.93
NON COM.	*1586.72
NET 1	*1732.20

Commission sale 1 total
 Commission amount 1 = Commission sale x Commission rate
 Commission amount total
 Non-commission sales amount

■ Chief report

16/12/99	[0001] 123456
#2050 22:29	CLERK0001
X1	
CHIEF	
T. TABLE	*34.68
T. GUEST	*1734.06 50 Q
T. GUEST	*1734.06 89 Q
T. BILL	*173.41
I. GUEST	*1734.06 10 Q
I. GUEST	639.000 Q 89 Q
I. BILL	639.000 Q 10 Q
AVE. ITEM	*1758.69 639.000 Q

Turnover amount per table
 Order total/used guest check
 Turnover amount per guest
 Order total/guest counter
 Turnover amount per bill
 Order total/new check q'ty
 Item q'ty per guest
 "+" dept. q'ty /guest q'ty
 Item q'ty per bill
 "+" dept. amount/new check q'ty
 Average of item amount
 "+" dept. amount/ "+" dept. q'ty

■ Tax report

16/12/99	[0001] 123456
#2049 22:28	CLERK0001
X1	
TAX	
NET 1	*1732.20
TAX1 ST	*1266.58
VAT 1	*88.37
TAX2 ST	*22.60
VAT 2	*0.66
TAX3 ST	*90.10
VAT 3	*3.47
TAX4 ST	*50.40
VAT 4	*2.40
TAX5 ST	*105.60
VAT 5	*2.07
TAX6 ST	*106.50
VAT 6	*1.05
TTL TAX	*98.02
NET	*1634.18

Net sales total
 Taxable 1 total
 VAT 1 total
 Tax total
 Net sales total without tax

■ Full clerk report

• Sample X report

16/12/99 [0001] 123456		
#2051	22:29	CLERK0001
X1		
ALL CLERK		
CLK#0001	CLERK0001	
ORDER TL		*1589.77
COM. SAL1		*25.48
CA/CK ID *1974.48		
CHK/CG		*9.60
1000#	Open GLU/PBLU code	
1003#		
FREE GLU	Free GLU code (GLU/PBLU code which has been transferred out by this clerk)	
1002#		
CLK#0002	CLERK0002	
ORDER TL		*139.09
COM. SAL1		*3.75
CLK#0010	CLERK0010	
PAID TL		*0.00
***TOTAL		
ORDER TL		*1728.86
COM. SAL1		*29.23
CREDIT8	1 Q	*16.00
EXCH1	2 Q	24.15
DOM. CUR1		*39.80
EX1CH+CR	1 Q	21.37
DOM. CHK/CR 1		*35.21
EXCH9	1 Q	12.00
DOM. CUR9		*14.80
****CID		*1953.67
*CH ID		*159.90
CA/CK ID		*2113.57
CHK/CG		*9.60

• Sample Z report

16/12/99 [0001] 123456		
#2106	23:43	CLERK0001
Z1		
ALL CLERK		

↓
The subsequent printout occurs in the same format as in the sample X report.

■ Individual clerk report

• Sample X report

16/12/99 [0001]123456	
#2052	22:42 CLERK0001
X1	
IND. CLERK	
CLK# 0001	CLERK0001
ORDER TL	*1589.77
COM. SAL1	*25.48
COM. AMT1	*0.51
COM. SAL2	*57.60
COM. AMT2	*1.73
COM. SAL3	*39.20
COM. AMT3	*0.59
COM. TTL	*2.83
NON COM.	*1491.42
PAID TL	*1558.87
AVE.	*18.34
O-P	*30.90
*NT TL1	-0.29
*NT TL2	*4.27
*NT TL3	*4.20
TRAN. OUT	2 Q *14.20
TRAN. IN	1 Q *9.00
BILL BAL	1 Q *5.20
REFUND	3 Q *5.20
VOID	1 Q *9.00
MGR VD	3 Q *9.00
SBTL VD	1 Q *9.00
WASTE TL	37 Q *90.40
RETURN	3 Q *7.70
***PBAL	10 Q
***PBAL2	4 Q
***NBAL	6 Q
***NBAL2	3 Q
G. C. CNT	2 Q
GUEST	85 Q
DEPOSIT	1 Q *12.00
DEPO. (-)	1 Q -10.00
SCM (+)	*805.00
SCM (-)	-400.00
SCM TTL	*405.00

- Clerk code
- Clerk name
- Order total
- Commission sale 1 total
- Commission amount 1
- Commission amount total
- Non-commission sales amount
- Paid total
- Paid total average per guest
- Order total-paid total
- Non-turnover 1 total
- Trans out counter and total
- Trans in counter and total
- Bill balance (Trans out-trans in)
- Refund counter and total
- Void-mode transaction counter and total
- Manager item void counter and total
- Subtotal item void counter and total
- Waste mode transaction
- Return counter and total
- GLU/PBLU counter
- Drive-through counter
- NBAL counter (for GLU/PBLU)
- NBAL counter (for drive-through)
- Guest check copy counter
- Guest counter
- Deposit (+) counter and total
- Deposit (-) counter and total
- Starting cash memory (+)
- Starting cash memory (-)
- Starting cash memory total

• Sample Z report

16/12/99 [0001]123456	
#2107	23:44 CLERK0001
Z1	
IND. CLERK	



The subsequent printout occurs in the same format as in the sample X report.

SER. CHRG		*0.23	
CASH	72 Q	*1236.21	Cash counter and total
CHECK	7 Q	*83.40	} Check 1 sale counter and total
CHECK2	1 Q	*15.00	
CHECK3	2 Q	*17.00	
CHECK4	1 Q	*9.00	
CREDIT1	1 Q	*78.42	} Credit 1 sale and tendering and total
CREDIT2	1 Q	*27.21	
CREDIT8	1 Q	*16.00	
EXCH1	2 Q	24.15	} Exchange 1 counter and total
DOM. CUR1		*39.80	
EX1CH+CR	1 Q	21.37	
DOM. CHK/CR 1		*35.21	
EXCH9	1 Q	12.00	
DOM. CUR9		*14.80	
****CID		*1814.58	} Cash in drawer
*CH ID		*159.90	} Cash + check in drawer
CA/CK ID		*1974.48	
CHK/CG		*9.60	} Change total for check tendering
1000#			} Open GLU/PBLU code
1003#			
FREE GLU			} Free GLU code
1002#			

■ Clerk report (Drink dispenser misoperation)

16/12/99 [0001] 123456	
#2056	22:45 CLERK0001
X1	
ALL CLERK	
CLK#0001	CLERK0001
ORDER TL	*49.50
COM. SAL1	*20.00
CA/CK ID *21.50	
CHK/CG	*55.00
00000001#	
DD NOP READ	
GLU#00001234	
1 x 5.00	
COFFEE	*5.00
2 x 4.50	
CHOCOLATE	*9.00
3 x 3.00	
PLO00003	*9.00
MISOP TL	6.000 Q *23.00
CLK#0003	CLERK0003
ORDER TL	*87.18
COM. SAL1	*82.68
CHK/CG	*0.50
CLK#0006	CLERK0006
ORDER TL	*76.45
COM. SAL1	*70.30
CHK/CG	*32.32

Ordinary clerk report

Contents of misoperation

Q'ty total and amount of misoperation for a clerk

Nothing is printed for a clerk who has made no misoperation

■ Drink dispenser error reading report

16/12/99 [0001] 123456	
#2057	22:45 CLERK0001
X1	
DD ERROR	
CLK#?001	?????????
GLU#00001234	
3 x 5.00	
COFFEE	*15.00
2 x 4.50	
CHOCOLATE	*9.00
GLU#00009999	
1 x 5.00	
COFFEE	*5.00
MISOP TL	6.000 Q *29.00

GLU code relating to misoperation

Contents of misoperation

Q'ty total and amount for a clerk

■ Drink dispenser resetting report

16/12/99 [0001] 123456	
#2058	22:45 CLERK0001
Z1	
DD RESET	
CLK#0001	CLERK0001
GLU#00001234	
3 x 5.00	
COFFEE	*15.00
2 x 4.50	
CHOCOLATE	*9.00
RST SBTL	5.000 Q *24.00
CLK#0003	CLERK0003
GLU#00009999	
2 x 4.50	
CHOCOLATE	*9.00
RST SBTL	2.000 Q *9.00
RESET TL	7.000 Q *33.00

Contents of misoperation

Q'ty total and amount for a clerk

Q'ty total and amount for all clerks

Employee active status report

16/12/99	[0001] 123456
#2072 22:57	CLERK0001
X2	
EMP. ACTIVE STS.	
#0000000001	- #9999999999
#0000000001	CLERK0001
TIME-IN	17:13
#0000000002	CLERK0003
TIME-IN	22:56 *
#0000000003	CLERK0002
TIME-IN	--:--

Employee code
Range
Employee name
* indicates that the employee is under break.
Indicates that the employee is not timed in.

Hourly report

Sample X report

16/12/99	[0001] 123456
#2074 23:00	CLERK0001
X1	
HOURLY	
13:30	5 Q *77.75
AVE.	*15.55
SUBTOTAL	5 Q *77.75
14:00	13 Q *540.86
AVE.	*41.60
14:30	13 Q *57.76
AVE.	*4.44
SUBTOTAL	26 Q *598.62
23:00	2 Q *9.00
AVE.	*4.50
SUBTOTAL	2 Q *9.00

Time
Transaction counter
Sales total
Average of sales amount

Drive-through service time report

16/12/99	[0001] 123456
#2073 22:59	CLERK0001
X1	
SERVICE TIME	
17:00	1Q 93:41
AVE.	93:41
18:00	1Q 70:32
AVE.	70:32

Transaction counter
Total time
Service average per 1 hour

Sample X report

16/12/99	[0001] 123456
#2108 23:46	CLERK0001
Z1	
HOURLY	

↓
The subsequent printout occurs in the same format as in the sample X report.

■ Labor cost % report

16/12/99 [0001] 123456			
#2076 23:05 CLERK0001			
X1			
LABOR COST%			
13:00	7 Q	*41.30	Time
LABOR%		*12.00	Transaction counter
		29.06%	Employee cost
14:00	24 Q	*206.55	Labor cost %
LABOR%		*12.00	
		5.81%	
15:00	29 Q	*369.30	Sales total
LABOR%		*12.00	
		3.25%	
23:00	3 Q	*24.60	
LABOR%		*0.24	
		0.98%	

■ Ingredient stock report

16/12/99 [0001] 123456			
#2081 23:12 CLERK0001			
X1			
INGREDIENT STOCK			
		001-999	Range
I 001			Ingredient no.
EGG		73.000 S	Stock q'ty
I 002			
CARROT		230.000 S	Description of ingredient
I 022			
BEEF		26.000 S	

■ GLU/PBLU report

• Sample X report

16/12/99 [0001] 123456			
#2084 23:15 CLERK0001			
X1			
GLU			
		1-99999999	GLU/PBLU code
		0001	Range
1000#			Clerk code
***PBAL		*1.20	PBAL
DEPOSIT		*0.00	Deposit (+) total
DEPO. (-)		*0.00	Deposit (-) total
1003#		0001	
***PBAL		*9.00	
DEPOSIT		*0.00	
DEPO. (-)		*0.00	
2000T		0004	"T": This GLU/PBLU code was used in the training mode.
***PBAL		*10.20	
DEPOSIT		*0.00	
DEPO. (-)		*0.00	
FREE GLU			
1002#			Free GLU/PBLU code
***PBAL		*5.20	(This code has been transferred out.)
DEPOSIT		*0.00	
DEPO. (-)		*0.00	
***TOTAL			
***PBAL		*15.40	Total
DEPOSIT		*0.00	
DEPO. (-)		*0.00	

• Sample Z report

16/12/99 [0001] 123456			
#2109 23:47 CLERK0001			
Z1			
GLU			

↓
The subsequent printout occurs in the same format as in the sample X report.

■ GLU/PBLU report by clerk

• Sample X report

16/12/99	[0001]123456	
#2083	23:13	CLERK0001
X1		
GLU BY CLERK		
CLK#0001	CLERK0001	
1000#		
***PBAL	*1.20	PBAL
DEPOSIT	*0.00	Deposit (+) total
DEPO. (-)	*0.00	Deposit (-) total
1003#		
***PBAL	*9.00	
DEPOSIT	*0.00	
DEPO. (-)	*0.00	
FREE GLU		
1002#		
***PBAL	*5.20	Free GLU/PBLU code (This code has been transferred out.)
DEPOSIT	*0.00	
DEPO. (-)	*0.00	
***TOTAL		
***PBAL	*15.40	} Total
DEPOSIT	*0.00	
DEPO. (-)	*0.00	

• Sample Z report

16/12/99	[0001]123456	
#2110	23:50	CLERK0001
Z1		
GLU BY CLERK		

↓

The subsequent printout occurs in the same format as in the sample X report.

■ Drive-through report

• Sample X report

16/12/99	[0001]123456	
#2086	23:19	CLERK0001
X1		
DRIVE THRU		
1#	1-99999999	Drive-through code
	0001	Range
***PBAL2	*13.00	Clerk code
DEPOSIT	*0.00	PBAL
DEPO. (-)	*0.00	Deposit (+) total
	*0.00	Deposit (-) total
2T	0004	"T": This drive-through code has been used in the training mode.
***PBAL2	*9.00	
DEPOSIT	*0.00	
DEPO. (-)	*0.00	
***TOTAL		
***PBAL2	*13.00	} Total
DEPOSIT	*0.00	
DEPO. (-)	*0.00	

• Sample Z report

16/12/99	[0001]123456	
#2111	23:51	CLERK0001
Z1		
DRIVE THRU		

↓

The subsequent printout occurs in the same format as in the sample X report.

■ Drive-through report by clerk

• Sample X report

16/12/99	[0001] 123456	
#2087	23:20	CLERK0001
X1		
D-THRU BY CLERK		
CLK#0001	CLERK0001	
1#		
***PBAL2		*13.00
DEPOSIT		*0.00
DEPO. (-)		*0.00
***TOTAL		
***PBAL2		*13.00
DEPOSIT		*0.00
DEPO. (-)		*0.00

Labels for Sample X report:

- Clerk code: CLERK0001
- Clerk name: CLERK0001
- Drive-through code: 1#
- PBAL: *13.00
- Deposit (+) total: *0.00
- Deposit (-) total: *0.00
- Total: *13.00 (sum of PBAL, DEPOSIT, and DEPO. (-))

• Sample Z report

16/12/99	[0001] 123456
#2112	23:53 CLERK0001
Z1	
D-THRU BY CLERK	

↓
The subsequent printout occurs in the same format as in the sample X report.

■ Balance report

16/12/99	[0001] 123456	
#2088	23:21	CLERK0001
X1		
BALANCE		
OLD BAL.		*144.45
ORDER TL		*1744.26
PAID TL		*1708.16
BALANCE		*180.55

Labels for Balance report:

- Grand total balance of the previous day: *144.45
- Order total: *1744.26
- Paid total: *1708.16
- Old balance + today's balance: *180.55

■ Bill report

• Sample X report

16/12/99	[0001] 123456	
#2089	23:22	CLERK0001
X1		
BILL		
#0006	16/12/99	0001
#0007	16/12/99	0001
		*9.00
		*4.00

Labels for Bill report:

- Bill number: #0006, #0007
- Date: 16/12/99
- Clerk number: 0001
- Amount: *9.00, *4.00

■ X1/Z1 stacked reports

You can print multiple X1/Z1 reports in sequence under a single transaction. In this case, you need to program in advance which X1/Z1 reports should be printed. Refer to "Stacked report" under Section "Report Programming" in Chapter 13 "Programming."

Periodic Consolidation

Your POS terminal allows you to take consolidation X and Z reports of a chosen period (the period is usually one week or month).

■ General information

The periodic reading or resetting reports are the same in format as those in the X1/Z1 report for daily sales information except mode indication ("X2" or "Z2").

• Sample X report

```
17/12/99 [0001] 123456
#2116    0:13 CLERK0001

  *X2*
DEPT./GROUP
```

Read symbol

Report title

• Sample Z report

```
17/12/99 [0001] 123456
#2117    0:14 CLERK0001

  *Z2*

GENERAL Z1          0005
GENERAL Z2          0004
GT1                 *00000004995.61
GT2                 *00000011859.22
GT3                 -00000006863.61
BAL                 *00000000152.15
TR                  *00000000071.20

DEPT./GROUP
```

Reset symbol

Reset counter of daily total

Reset counter of periodic consolidation

Grand totals

Report title

The subsequent printouts are the same in format as those in the X/Z report on daily totals.

■ Employee report

• Sample X report

17/12/99	[0001] 123456	
#2148	6:38	CLERK0001
X2		
EMPLOYEE		Employee code
#000000001 - #999999999		Range
#000000001	CLERK0001	Employee code
16/12/99		Date
TIME-IN	17:13	Time-in operation time
	#01 CASHIER	Job location no.
BREAK-IN	0:18	Job location name
BREAK-OUT	2:30	Break-in
	#01 CASHIER	Break-out
BREAK-IN	2:35	
BREAK-OUT	4:30	* Edited time
	#02 KITCHEN	
BREAK-IN	6:32	
LOC#01	CASHIER	Total break time per location
BREAK TL	4:07H	
***TOTAL	7:10H	Total working time per location
L. COST	*4650.00	Total cost per location
LOC#02	KITCHEN	Total cost per location
BREAK TL	0:00H	
***TOTAL	2:02H	
L. COST	*3050.00	
BREAK TL	4:07H	Total hour
TTL HOUR	9:12H	Overtime
OVR TIME	3:12H	Total labor cost
TTL COST	*7700.00	
#000000002	CLERK0003	Employee name
16/12/99		Date
TIME-IN	22:56	
	#01 CASHIER	
BREAK-IN	22:56	
BREAK-OUT	0:17	
	#01 CASHIER	
BREAK-IN	6:37	Time-out
TIME-OUT	6:37	
LOC#01	CASHIER	
BREAK TL	1:21H	
***TOTAL	6:20H	
L. COST	*4200.00	
BREAK TL	1:21H	
TTL HOUR	6:20H	
OVR TIME	1:20H	
TTL COST	*4200.00	

• Sample Z report

17/12/99	[0001] 123456
#2150	6:40 CLERK0001
Z2	
EMPLOYEE	

↓
The subsequent printout occurs in the same format as in the sample X2 report.

■ Over time report

• Sample X report

16/12/99	[0002] 000000
#2078	23:10 CLERK0002
X2	
OVER TIME	
#000000001 - #999999999	Range
#000000001	Employee code
15/12/99	Date
OVR TIME	1:08H
OVR COST	*16.32
	Over time (Hour)
	Over time cost

• Sample Z report

16/12/99	[0002] 000000
#2079	23:11 CLERK0002
Z2	
OVER TIME	

↓
The subsequent printout occurs in the same format as in the sample X2 report.

Employee time adjustment report

17/12/99	[0001]123456	
#2151	6:41	CLERK001
X2		
EMP. ADJUSTMENT		
#000000001 - #999999999		Range
#000000001	CLERK001	
16/12/99		Date
TIME-IN	17:13	Operation
BREAK-IN	0:18	Operation time before time editing
BREAK-OUT	2:30	
BREAK-IN	2:38 - 2:35	Edited time
	17/12/99 6:35	
BREAK-OUT	4:30	
BREAK-IN	6:32	
TIME-OUT	6:39	
#000000002	CLERK003	
16/12/99		Date
TIME-IN	22:56	Operation
BREAK-IN	22:56	Operation time before time editing
BREAK-OUT	0:17	
BREAK-IN	6:37	
TIME-OUT	6:37	
#000000003	CLERK002	

Daily net report

Sample X report

30/11/99	[0001]123456	
#0852	21:10	CLERK001
X2		
DAILY NET		
01/11	17 Q	*236.00
02/11	23 Q	*350.40
03/11	33 Q	*496.40
29/11	23 Q	*326.80
30/11	30 Q	*420.00
***TOTAL	195 Q	*2988.80

Labels for Sample X report:

- Date: 30/11/99
- Guest q'ty: 195 Q
- Sales total: *2988.80
- Guest total: 195 Q
- Net amount total: *2988.80

Sample Z report

30/11/99	[0001]123456	
#0853	21:12	CLERK001
Z2		
DAILY NET		

↓
The subsequent printout occurs in the same format as in the sample X2 report.

X2/Z2 stacked report

You can print multiple X2/Z2 reports in sequence under a single transaction. In this case you need to program in advance which X2/Z2 reports should be printed. Refer to "Stacked report" under Section "Report Programming" in Chapter 13 "Programming."

Compulsory Cash/Check Declaration

If your POS terminal has been programmed for compulsory cash/check declaration, you must declare cash/check in drawer in advance according to the type of the declaration when you take clerk Z reports.

Use the procedure shown in “Key operation” below for this declaration.

Types of compulsory cash/check declaration

- Compulsive when individual clerk resetting is taken
- Compulsive when full clerk resetting is taken

NOTE

Compulsory cash/check declaration is available in the above two types. You can choose either of these. Contact your authorized SHARP dealer for details.

Key operation

• Individual clerk Z report

OP X/Z mode



X1/Z1 mode

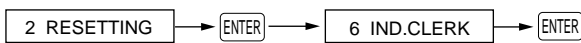

XXXX
Clerk code entry -> ENTER

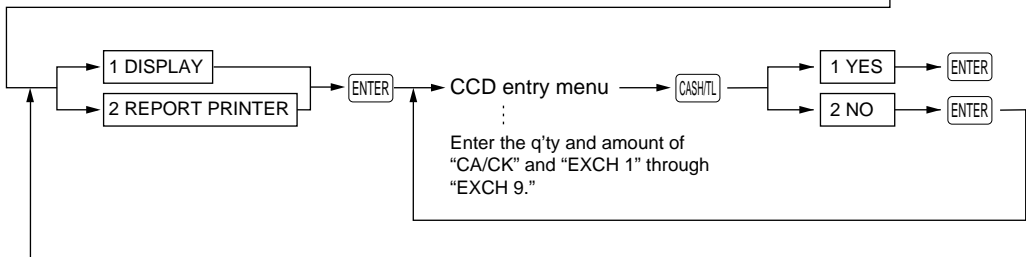

• Full clerk Z report

X1/Z1 mode

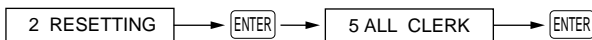

17/12/99 [0001]123456
 #2115 0:07 CLERK0001

OPZ
 CCD

CA/CK IS	*0.00	} CCD entry amount
CA/CK IS	*2013.08	
EXCH1 IS	24.15	
EXCH2 IS	0.00	
EXCH9 IS	12.00	

IND. CLERK

CLK#0001	CLERK0001	— Clerk code/clerk name
ORDER TL	*1605.17	} Order total
COM. SAL1	*25.48	
COM. AMT1	*0.51	} Commission sale 1 total
COM. SAL2	*57.60	
COM. AMT2	*1.73	
COM. SAL3	*39.20	
COM. AMT3	*0.59	
COM. TTL	*2.83	
NON COM.	*1501.62	

PAID TL	*1597.47
AVE.	*17.36
O-P	*7.70
*NT TL1	-0.29
*NT TL2	*4.27
*NT TL3	*4.20
TRAN. OUT	2 Q *14.20
TRAN. IN	2 Q *14.20
REFUND	3 Q *5.20
VOID	1 Q *9.00
MGR VD	3 Q *9.00
SBTL VD	1 Q *9.00
WASTE TL	37 Q *90.40
RETURN	3 Q *7.70
***PBAL	12 Q
***PBAL2	4 Q
***NBAL	7 Q
***NBAL2	3 Q
G. C. CNT	2 Q
GUEST	92 Q

DEPOSIT	1 Q	*12.00
DEPO. (-)	1 Q	-10.00
SCM (+)		*805.00
SCM (-)		-400.00
SCM TTL		*405.00

SER. CHRG		*0.23
CASH	79 Q	*1274.81
CHECK	7 Q	*83.40
CHECK2	1 Q	*15.00
CHECK3	2 Q	*17.00
CHECK4	1 Q	*9.00
CREDIT1	1 Q	*78.42
CREDIT2	1 Q	*27.21
CREDIT8	1 Q	*16.00
EXCH1	2 Q	24.15
EXCH1 IS		24.15
CCD DIF.		0.00
DOM. CUR1		*39.80
EX1CH+CR	1 Q	21.37
DOM. CHK/CR 1		*35.21
EXCH9	1 Q	12.00
EXCH9 IS		12.00
CCD DIF.		0.00
DOM. CUR9		*14.80

****CID		*1853.18
*CH ID		*159.90
CA/CK ID		*2013.08
CA/CK IS		*2013.08
CHK/CG		*9.60

Cash in drawer to be obtained

Check in drawer to be obtained

Cash/check in drawer to be obtained

Total of entered (declared) cash/check in drawer

Change total for check tendering

12

How to Use the Programming Keyboard

When the PGM1 or PGM2 mode is selected, the programming keyboard will appear.

Programming Keyboard Layout

			↑	P UP	CLK#	MGR#	AUTO21
			↓	P DOWN	EMPL#		AUTO22
			CANCEL		LIST		AUTO23
			CLEAR		MODE		AUTO24
			7	8	9	X/QTY	AUTO25
PREVIOUS		NEXT	4	5	6	PGM COMMAND	
			1	2	3	ENTER	
DELETE		CALL	0	00	•	CASH/TL	

DELETE : Deletes a character or figure in the cursor position.



Used to move the cursor.

CALL : Used to call up a desired code.

PREVIOUS : Used to go back to the previous record, e.g., from the department 2 programming window back to the department 1 programming window.

NEXT : Used to go to the next record, for example, in order to program unit prices for sequential departments.

ENTER : Used to program each setting.

CLEAR : Used to clear the last setting you have programmed or clear the error state.

CANCEL : Used to cancel programming and to get back to the previous screen.

P UP : Used to scroll the window to go back to the previous page.

P DOWN : Used to scroll the window to go to the next page.

MODE : Used to go back to the MODE screen.

• : Used to toggle between two or more options.

LIST : Used to list those options which you can toggle by the **•** key.

PGM COMMAND : Used to go to the PGM COMMAND keyboard.

CASH/TL : Used to finalize programming.

Numeric keys: Used for entering figures.

For more information about using these keys, see the “Basic Instructions” selection in Chapter 13 “Programming.”

How to Program Alphanumeric Characters

This section discusses how to program alphanumeric characters such as “DESCRIPTION,” “NAME” and “TEXT.”

Character Keyboard

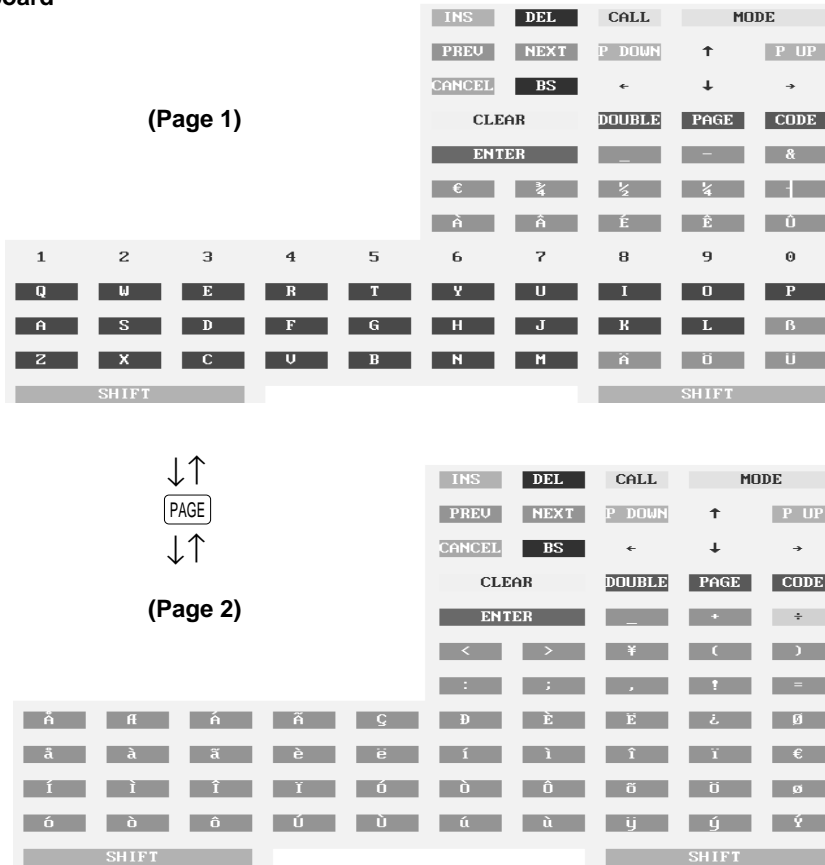

■ Using character keys on the keyboard

Entering alphanumeric characters

To enter a character, simply touch a corresponding character key on the character keyboard.

Entering upper-case letters

SHIFT : You can enter an upper-case letter by using this key. Touch this key just before you enter the upper-case letter. You should touch this key each time you enter an upper-case letter.

Entering double-size characters

DOUBLE : This key toggles the double-size character mode and the normal-size character mode. The default is the normal-size character mode. When the double-size character mode is selected, the letter “W” appears at the bottom of the display.

Editing text

You can edit the text you have entered by deleting and/or inserting characters.

To select a text editing mode: Use the **INS** key. (Editing mode: the insert mode (“_”) and the overwrite mode (“■”))

To move the cursor: Use the **←** or **→** key.

To delete a character or figure: Use the **DEL** (Delete) or **BS** (Back space) key.

■ Entering character codes

Numerals, letters and symbols are programmable by touching the **CODE** key and character codes. Use the following procedure with the cursor placed at the position where you want to enter characters:

CODE → XXX XXX: Character code (3 digits)

Character code:

032 - 047	032	033	034	035	036	037	038	039	040	041	042	043	044	045	046	047
		!	"	#	\$	%	&	'	()	*	+	,	-	.	/
048 - 063	048	049	050	051	052	053	054	055	056	057	058	059	060	061	062	063
	0	1	2	3	4	5	6	7	8	9	:	;	<	=	>	?
064 - 079	064	065	066	067	068	069	070	071	072	073	074	075	076	077	078	079
	P	A	B	C	D	E	F	G	H	I	J	K	L	M	N	O
080 - 095	080	081	082	083	084	085	086	087	088	089	090	091	092	093	094	095
	P	Q	R	S	T	U	V	W	X	Y	Z	[\]	^	_
096 - 111	096	097	098	099	100	101	102	103	104	105	106	107	108	109	110	111
	`	a	b	c	d	e	f	g	h	i	j	k	l	m	n	o
112 - 127	112	113	114	115	116	117	118	119	120	121	122	123	124	125	126	127
	p	q	r	s	t	u	v	w	x	y	z	{		}	~	Δ
128 - 143	128	129	130	131	132	133	134	135	136	137	138	139	140	141	142	143
	Ç	ü	é	â	ã	à	ä	ç	ê	ë	è	ï	î	ì	ä	å
144 - 159	144	145	146	147	148	149	150	151	152	153	154	155	156	157	158	159
	É	æ	ƒ	ô	ö	ò	û	ù	ÿ	ö	ü	ø	£	Ø	×	ƒ
160 - 175	160	161	162	163	164	165	166	167	168	169	170	171	172	173	174	175
	á	í	ó	ú	ñ	Ñ	ª	º	¿	®	¬	½	¼	¡	«	»
176 - 191	176	177	178	179	180	181	182	183	184	185	186	187	188	189	190	191
	⋮	⋮	⋮		†	Á	Â	À	©	¶	¶	¶	¶	¢	¥	⌋
192 - 207	192	193	194	195	196	197	198	199	200	201	202	203	204	205	206	207
	L	L	T	†	-	†	ã	Ã	ℓ	¶	¶	¶	¶	=	¶	ø
208 - 223	208	209	210	211	212	213	214	215	216	217	218	219	220	221	222	223
	ð	Ð	Ê	Ë	È	ı	Í	Î	Ï	J	Γ	■	■	ı	ì	■
224 - 239	224	225	226	227	228	229	230	231	232	233	234	235	236	237	238	239
	ó	ß	ô	ò	õ	õ	µ	þ	þ	ú	û	ù	ý	ý	-	'
240 - 255	240	241	242	243	244	245	246	247	248	249	250	251	252	253	254	255
	-	±	=	¼	¶	§	÷	ˆ	°	ˆˆ	.	ı	3	2	■	(DC)

*(DC) : Double-size character code

13

Programming

PRICE MODE
PGM1 MODE
PGM2 MODE
AUTO KEY MODE

This chapter explains how to program various items. Before you start programming, select the PRICE, PGM1, PGM2, or AUTO KEY mode from the mode selection window depending on the item you are going to program.

Basic Instructions

This section illustrates the basic programming by using an example of programming for departments.

Procedure

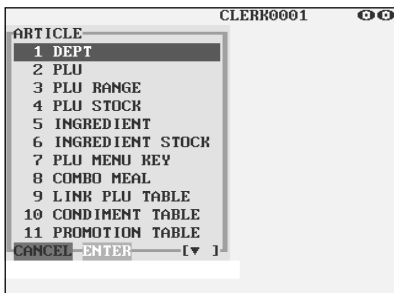
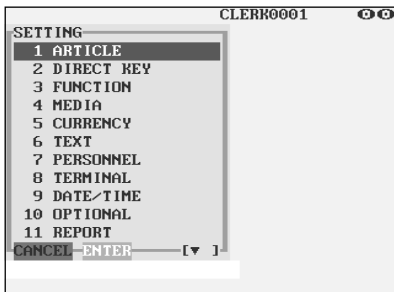
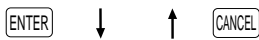
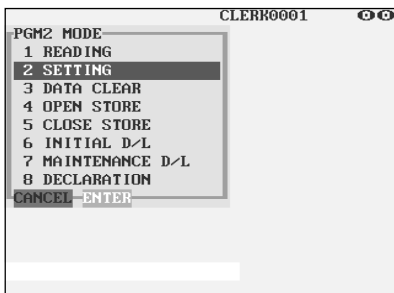

Programming example

The following example shows how to program 2.00 for the unit price, "ABCDE" for the description, and the scale entry to be enabled for department 1.

- In the PGM2 MODE window, select "2 SETTING" by using the or key and touch the key.
 - The SETTING window will appear.

NOTE

- You can also select "2 SETTING" simply by touching a corresponding line in the window.
- You can also select "2 SETTING" by touching the and keys.
- If you return to the previous screen, touch the key.

- Select "1 ARTICLE."

 - The ARTICLE window will appear.

NOTE

The mark (▼) in the lower-right corner of the window shows that the window contains more options than are now on the screen. To scroll the window, touch the key. To return to the previous page, touch the key.

- Select "1 DEPT."

 - The DEPT window will appear, listing programmable departments.

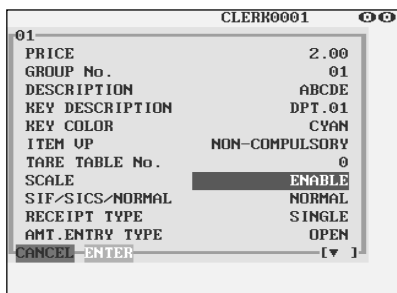
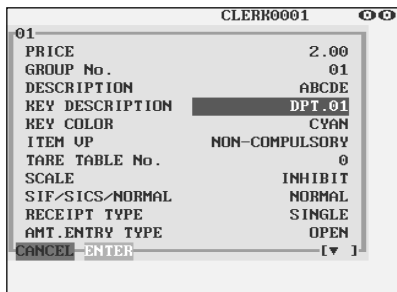
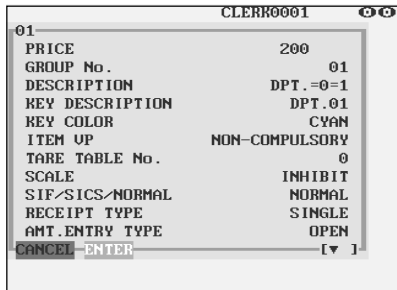
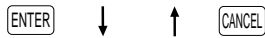
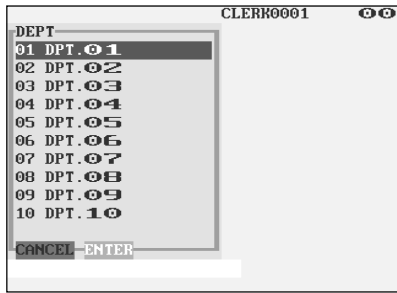

4. Select “01” to program for department 1.

- The “01” window will appear.

5. On the first page of the “01” window, program the unit price and description as follows:

NOTE

There are three entry patterns for the programming: the numeric entry, character entry, and selective entry.

- Move the cursor to “PRICE,” enter “200” by using numeric keys, then touch the **ENTER** key. → **Numeric entry**
- Move the cursor to “DESCRIPTION,” enter “ABCDE” by using character keys, then touch the **ENTER** key. → **Character entry**

If you want to clear the setting, touch the **CLEAR** key before you touch the **ENTER** key.

6. On the first page of the “01” window, program the machine to enable the scale entry as follows:

- Move the cursor to “SCALE,” touch the **•** key until “ENABLE” appears, then touch the **ENTER** key. → **Selective entry**

NOTE

*The **•** key toggles between three options as follows: INHIBIT → ENABLE → COMPULSORY → INHIBIT → Touching the **LIST** key displays all pertinent options.*

7. Select one of the following actions:

- To cancel the programming, touch the **CANCEL** key. Select “YES” in the “ARE YOU SURE ?” window.
- To finalize the programming, touch the **CASH/TL** key, then touch the **CANCEL** key. You will return to the “DEPT” window.
- To program for the following department, touch the **NEXT** key. The “02” window will appear. To return to the “01” window, touch the **PREVIOUS** key.

The following sections describe how to program each item which is contained in a programming group.

Article Programming

Use the following procedure to select any option included in the article programming group.

Procedure

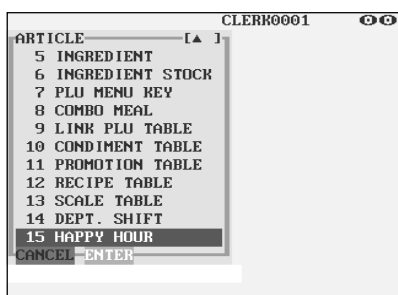
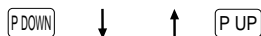
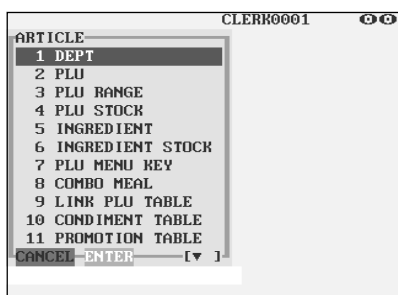
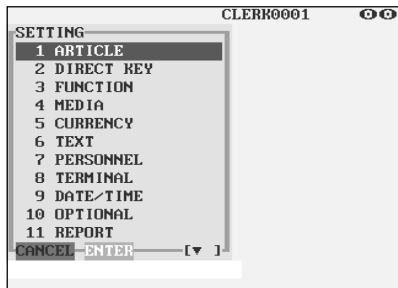

1. In the SETTING window, select "1 ARTICLE."
 - The ARTICLE window will appear.

2. Select any option from the following options list:

1 DEPT:	Departments
2 PLU:	PLUs
3 PLU RANGE:	A range of PLUs
4 PLU STOCK:	PLU stock quantity
5 INGREDIENT:	Ingredients of PLUs
6 INGREDIENT STOCK:	Ingredient stock quantity
7 PLU MENU KEY:	PLU menu key
8 COMBO MEAL:	Combo meal
9 LINK PLU TABLE:	Link PLU table
10 CONDIMENT TABLE:	Condiment table
11 PROMOTION TABLE:	Promotion table
12 RECIPE TABLE:	Recipe table
13 SCALE TABLE:	Scale table
14 DEPT. SHIFT:	Department shift
15 HAPPY HOUR:	Happy hour

The following illustration shows those options included in the article programming group.

1 ARTICLE	1 DEPT	➔ See "■ Department" on page 137.
—	2 PLU	➔ See "■ PLU" on page 139.
—	3 PLU RANGE	➔ See "■ PLU range" on page 142.
—	4 PLU STOCK	➔ See "■ PLU stock" on page 143.
—	5 INGREDIENT	➔ See "■ Ingredient" on page 144.
—	6 INGREDIENT STOCK	➔ See "■ Ingredient stock" on page 145.
—	7 PLU MENU KEY	➔ See "■ PLU menu key" on page 146.
—	8 COMBO MEAL	➔ See "■ Combo meal" on page 147.
—	9 LINK PLU TABLE	➔ See "■ Link PLU table" on page 148.
—	10 CONDIMENT TABLE	➔ See "■ Condiment table" on page 149.
—	11 PROMOTION TABLE	➔ See "■ Promotion table" on page 151.
—	12 RECIPE TABLE	➔ See "■ Recipe table" on page 153.
—	13 SCALE TABLE	➔ See "■ Scale table" on page 154.
—	14 DEPT. SHIFT	➔ See "■ Department shift" on page 155.
—	15 HAPPY HOUR	➔ See "■ Happy hour" on page 155.

■ Department

Your POS terminal is equipped with 10 standard departments.
Use the following procedure to program for departments.

Procedure

Select a pertinent dept. code from the departments list.

The screen continues.

Program each item as follows:

NOTE

For more information about the entry patterns, see the “Basic Instructions” section.

- **PRICE (Use the numeric entry)**
Unit price (max. 6 digits)
- **GROUP No. (Use the numeric entry)**
 - 01-09: Plus department
 - 10: Minus department
 - 11: Plus hash department
 - 12: Minus hash department
 - 15-17: Non-turnover 1-3
 - If the “Hash” and “non-turnover” functions are disabled, you are not allowed to select any hash or non-turnover department.
- **DESCRIPTION (Use the character entry)**
Description for a department. Up to 16 characters can be entered.
- **KEY DESCRIPTION (Use the character entry)**
Description of the key label for a department.
Up to 16 characters can be entered.
- **KEY COLOR (Use the selective entry)**
Select a key color from the colors list (16 different colors).
BLACK/BLUE/LIGHT BLUE/MAGENTA/LIGHT MAGENTA/
GREEN/LIGHT GREEN/RED/LIGHT RED/CYAN/LIGHT
CYAN/GRAY/LIGHT GRAY/YELLOW/BROWN/WHITE
- **ITEM VP (Use the selective entry)**
 - COMPULSORY: Makes item validation printing compulsory.
 - NON-COMPULSORY: Makes item validation printing non-compulsory.
- **TARE TABLE No. (Use the numeric entry)**
Scale table number associated with scale entry (1 through 9).
- **SCALE (Use the selective entry)**
 - COMPULSORY: Makes a scale entry compulsory.
 - ENABLE: Enables a scale entry.
 - INHIBIT: Inhibits a scale entry.

■ Department (continued)

- **SIF/SICS/NORMAL (Use the selective entry)**

Department type selection

SIF: SIF department

SICS: SICS department

NORMAL: Department other than SIF or SICS department

- **RECEIPT TYPE (Use the selective entry)**

Receipt type selection (When the receipt type is “single/double” or “single/double + addition.”)

DOUBLE: Double receipt type

SINGLE: Single receipt type

- **AMT. ENTRY TYPE (Use the selective entry)**

Type of unit price entry for departments

OPEN & PRESET: Open & preset

PRESET: Preset only

OPEN: Open only

INHIBIT: Inhibited

- **TAXABLE 1 through 6 (Use the selective entry)**

Tax status

YES : Taxable

NO : Non-taxable

NOTE

- *The tax system of your POS terminal has been factory-set to automatic VAT1 - 6. If you desire to select any of automatic tax 1 - 6, manual VAT1 - 6, manual VAT1, manual tax 1 - 6, and the combination of the automatic VAT 1 - 3 and the automatic tax 4 - 6, contact your authorized SHARP dealer.*
- *When the combination of the automatic VAT1 - 3 and automatic tax 4 - 6 system is selected, one of the taxable 1 - 3 can be selected in combination with taxable 4 - 6.*

- **HALO (Use the numeric entry)**

- You can set an upper limit amount (HALO) for each department. The limit is effective for the REG-mode operations and can be overridden in the MGR mode.

- AB is the same as $A \times 10^B$

A: Significant digit for HALO (1 through 9)

B: Number of zeros to follow the significant digit for HALO (0 through 8)

- **COMMIS. Gr. No. (Use the numeric entry)**

Commission group number (1 through 3)

If the number “0” is entered, no commission group number will be assigned to a department.

You can assign each department to a commission group.

- **OUTPUT KP No. 1 and No. 2 (Use the numeric entry)**

ID number of the network remote printer 1 or 2 (1 through 9)

If the number “0” is entered, no remote printer will operate.

- **RECEIPT PRINT (Use the selective entry)**

YES: Prints the department sales information on the receipt.

NO: Prints nothing on the receipt.

- **PRNT ON CLK REPO (Use the selective entry)**

YES: Prints the department sales information on the clerk report.

NO: Skip the department sales information on the clerk report.

■ PLU

Procedure

Select a pertinent PLU code from the PLUs list.

```

000001 CLERK0001
000001
ASSOCIATION DEPT. 01
SIGN +
PRICE 1 0.00
PRICE 2 0.00
PRICE 3 0.00
PRICE 4 0.00
PRICE 5 0.00
PRICE 6 0.00
PRICE 7 0.00
DESCRIPTION1 PL000001
KEY DESCRIPTION1 000001
CANCEL-ENTER [v]
  
```

```

000001 CLERK0001
000001 [A]
KEY COLOR YELLOW
AMT. ENTRY TYPE PRESET
BASE QTY 0
MINIMUM STOCK 0.00
PRICE SHIFT ALLOWED
MENU TYPE NORMAL
COMBO/LINK TBL# 00
PROMOTION TBL# 00
CONDIMENT TBL# 00
CONDIMENT TYPE NO
CONDIMENT ENTRY NON-COMPULSORY
CANCEL-ENTER [v]
  
```

```

000001 CLERK0001
000001 [A]
RECIPE TBL#1 000
RECIPE TBL#2 000
RECIPE TBL#3 000
RECIPE TBL#4 000
RECIPE TBL#5 000
RECIPE TBL#6 000
RECIPE TBL#7 000
TARE TABLE No. 0
SCALE INHIBIT
TAXABLE 1 NO
TAXABLE 2 NO
CANCEL-ENTER [v]
  
```

The screen continues.

Program each item as follows:

- **ASSOCIATION DEPT. (Use the numeric entry)**

Department code to be associated with the entered PLU (01 through 99)

When a PLU is associated with a department, the following functions of the PLU depend on the programming for the department.

- Grouping (group 1 through 17)
- Item validation print compulsory/non-compulsory
- Single item cash sale/Single item finalize
- Single receipt/double receipt
- HALO (only for subdepartments)

- **SIGN (Use the selective entry)**

+ : Plus PLU/subdepartment

- : Minus PLU/subdepartment

The function of every PLU/subdepartment varies according to the combination of its sign and the sign of its associated department as follows:

Department: +
 PLU/subdept.: + } Serves as a normal plus PLU/subdepartment.

Department: -
 PLU/subdept.: - } Serves as a normal minus PLU/subdepartment.

Department: +
 PLU/subdept.: - } Accepts store coupon entries, but not split-pricing entries.

Department: -
 PLU/subdept.: + } Not valid; not accepted

- **PRICE 1 through 7 (Use the numeric entry)**

Unit price of each price level (max. 6 digits).

By default, only a price for PRICE 1 can be entered. If you want to enter a price for PRICE 2 through 7, contact your authorized SHARP dealer.

- **DESCRIPTION 1 through 7 (Use the character entry)**

Description of a PLU for each price level. Up to 16 characters can be entered.

- **KEY DESCRIPTION 1 thru 7 (Use the character entry)**

Description of the key label for each price level. Up to 16 characters can be entered.

- **KEY COLOR (Use the selective entry)**

Select a key color from the colors list (16 different colors).
 BLACK/BLUE/LIGHT BLUE/MAGENTA/LIGHT MAGENTA/
 GREEN/LIGHT GREEN/RED/LIGHT RED/CYAN/LIGHT
 CYAN/GRAY/LIGHT GRAY/YELLOW/BROWN/WHITE

■ PLU (continued)

- **AMT. ENTRY TYPE (Use the selective entry)**

Mode parameter
OPEN & PRESET: PLU/subdepartment mode
PRESET: PLU mode
OPEN: Subdepartment mode
INHIBIT: Inhibit mode

- **BASE QTY (Use the numeric entry)**

Base quantity for each PLU/subdepartment that should be applied only to split-pricing entries (max. 2 digits: 0.0 to 9.9)

- **MINIMUM STOCK (Use the numeric entry)**

Minimum stock quantity for a PLU (max. 7 digits)

- **PRICE SHIFT (Use the selective entry)**

COMPULSORY: Makes PLU price level shift compulsory.
INHIBIT: Inhibits PLU price level shift.
ALLOWED: Allows PLU price level shift.

- **MENU TYPE (Use the selective entry)**

PLU menu type selection
COMBO: Combo PLU
LINK: Link PLU
NORMAL: Normal PLU

- **COMBO/LINK TBL# (Use the numeric entry)**

Table number for combo PLUs/link PLUs (1 through 99)

- **PROMOTION TBL# (Use the numeric entry)**

Table number for promotion (1 through 99)

- **CONDIMENT TBL# (Use the numeric entry)**

Table number for condiment entry (1 through 99)

- **CONDIMENT TYPE (Use the selective entry)**

YES: Condiment type
NO: Non-condiment type

- **CONDIMENT ENTRY (Use the selective entry)**

COMPULSORY: Makes a condiment entry compulsory.
NON-COMPULSORY: Makes a condiment entry non-compulsory.

- **RECIPE TBL#1 through #7 (Use the numeric entry)**

Table number for recipe (1 through 999)

- **TARE TABLE No. (Use the numeric entry)**

Scale table number associated with scale entry (1 through 9)

- **SCALE (Use the selective entry)**

COMPULSORY: Makes a scale entry compulsory.
ENABLE: Enables a scale entry.
INHIBIT: Inhibits a scale entry.

■ PLU (continued)

- **TAXABLE 1 through 6 (Use the selective entry)**

YES: Makes the PLU taxable.

NO: Makes the PLU non-taxable.

NOTE

- *The tax system of your POS terminal has been factory-set to automatic VAT1 - 6. If you desire to select any of automatic tax 1 - 6, manual VAT1 - 6, manual VAT1, manual tax 1 - 6, and the combination of the automatic VAT1 - 3 and the automatic tax 4 - 6, contact your authorized SHARP dealer.*
- *When the combination of the automatic VAT1 - 3 and automatic tax 4 - 6 system is selected, one of the taxable 1 - 3 can be selected in combination with taxable 4 - 6.*
- *A PLU not programmed for any of these tax status is registered depending on the tax status of the department which the PLU belongs to.*

- **HOURLY Gr.#1 through #3 (Use the numeric entry)**

PLU hourly group number to classify PLUs for PLU hourly group reports (1 through 9)

- **GROUP (Use the numeric entry)**

PLU group number (00 through 99)

- **COMMIS. Gr. No. (Use the numeric entry)**

You can assign a PLU to a commission group (1 through 3).

If the number "0" is entered, no commission group number will be assigned to a PLU.

- **OUTPUT KP No.1 and No.2 (Use the numeric entry)**

ID number of the network remote printer 1 or 2 (1 through 9)

If the number "0" is entered, no remote printer will operate.

- **RECEIPT PRINT (Use the selective entry)**

YES: Prints the PLU sales information on the receipt.

NO: Prints nothing on the receipt.

- **PINT PRICE1 through 7 (Use the numeric entry)**

Pint price of each price level (max. 6 digits)

- **PINT BASE QTY (Use the numeric entry)**

Base quantity for each PLU/subdepartment that should be applied only to half/double pint entries (max. 2 digits: 0.0 to 9.9)

■ PLU range

You can program PLUs by range as follows:

Procedure

```
CLERK0001
PLU RANGE
START      000000
END        000000
OPERATION  NEW&MAINTENANCE
CANCEL ENTER
```



```
CLERK0001
000001-000020
ASSOCIATION DEPT. 01
SIGN
PRICE 1
PRICE 2
PRICE 3
PRICE 4
PRICE 5
PRICE 6
PRICE 7
DESCRIPTION1
KEY DESCRIPTION1
CANCEL ENTER
```

The screen continues in the same format as screens shown in section “■ PLU.”

Enter a value or select an option for each item as follows:

- **START (Use the numeric entry)**
Starting PLU code (max. 6 digits)
- **END (Use the numeric entry)**
Ending PLU code (max. 6 digits)
- **OPERATION (Use the selective entry)**
 - MAINTENANCE: Enables you to change the setting you have programmed.
 - NEW&MAINTENANCE: Enables you to change the current setting when the specified codes have already been created or to create new codes when the specified codes have not been created yet.
 - DEL: Enables you to delete a specified range of PLUs.

■ PLU stock

You can assign a stock quantity to each PLU code.

Shown below is an example of selecting "1 OVER WRITE."

Procedure

```
PLU STOCK          CLERK0001
1 OVER WRITE
2 ADD
3 SUB
CANCEL ENTER
```

Select a pertinent PLU code from the PLUs list.

```
000001          CLERK0001
1 CURRENT STOCK  0.000
2 NEW STOCK      0.000
CANCEL ENTER
```

After selecting "1 OVER WRITE," select a pertinent PLU code. Then the next screen will appear to show the following items:

• CURRENT STOCK

The current stock is displayed.

• NEW STOCK (Use the numeric entry)

Enter a new stock quantity (max. 7 digits: 1 to 9999.999(9999999))

NOTE

- If you need to add or subtract a stock quantity to or from the current stock quantity, select "2 ADD" or "3 SUB" and enter a value to be added or subtracted.
- You cannot enter any values for the item marked with "!".
- The entry of a new stock value will update to the PLU stock counter.

■ Ingredient

You can program an ingredient number, description and cost for the ingredients of each PLU. The ingredient numbers can be assigned to each recipe table. The cost needs to be programmed to analyze the food cost of each item.

Procedure

Selected ingredient no. →

Program each item as follows:

- **INGREDIENT (Use the numeric entry)**
Ingredient number (1 through 999)

NOTE

- When you create a new number, enter the number, then touch the key.
- If the key is touched on the ingredient number selection menu, the ingredient in the cursor position will be deleted.

- **DESCRIPTOR (Use the character entry)**

Description for each ingredient. Up to 12 characters can be entered.

- **COST (Use the numeric entry)**

Cost for each ingredient (max. 6 digits)

NOTE

Food cost is calculated by the following equations:

Food cost (PLU cost) = $\Sigma(\text{Ingredient cost} \times \text{Usage})$

Food cost% = $(\text{Sales q'ty} \times \text{Food cost}) / (\text{Sales amount} - \text{*VAT amount} - \text{**Service charge})$

* The VAT amount is calculated by using a VAT rate which is programmed for each PLU.

VAT amount = $\text{Sales amount} \times r / (1+r)$

**The service charge is calculated by using a service charge rate which is preset in the PGM2 mode. The service charge rate is shared by all PLUs.

Service charge = $\text{Sales amount} \times \text{Service charge rate}$

■ Ingredient stock

You can assign a stock quantity to each ingredient.
Shown below is an example of selecting “2 ADD.”

Procedure

```
INGREDIENT STOCK          CLERK0001
1 OVER WRITE
2 ADD
3 SUB
CANCEL ENTER
```

Selected ingredient no. → ENTER

```
001          CLERK0001
*CURRENT STOCK  0.000
ADD VALUE      0.000
CANCEL ENTER
```

Program each item as follows:

- **CURRENT STOCK**

The current stock is displayed.

- **ADD VALUE (Use the numeric entry)**

Enter a value to be added (max. 7 digits: 1 to 9999.999(9999999)).

NOTE

- If you need to overwrite or subtract a stock quantity to or from the current stock quantity, select “1 OVER WRITE” or “3 SUB” and enter a value to be overwritten or subtracted.
- You cannot enter any values for the item marked with “!”.

■ PLU menu key

When you enter PLUs, using the PLU menu key makes it easy to find categorized PLU items from the menu list.

Your POS terminal allows you to program a max. of 50 PLU menu keys. You can program a max. of 36 PLUs/sub-menus for each PLU menu key.

Procedure



Selected PLU menu key no. → ENTER

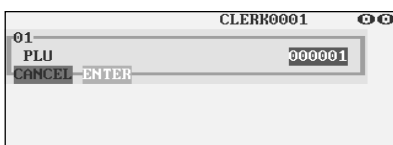
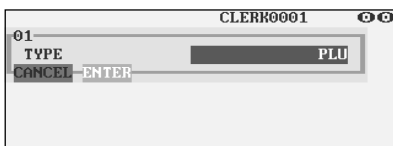
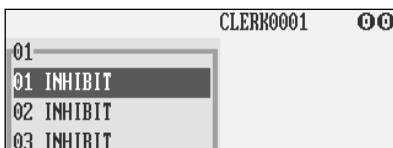
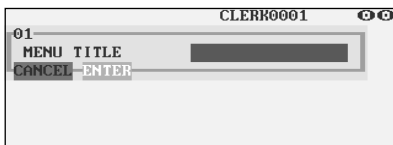

Use the following procedure to program a PLU menu key:

In the ARTICLE window, select “7 PLU MENU KEY” and program each item as follows:

- **PLU MENU KEY (Use the numeric entry)**
 PLU menu key number (1 thru 50)
 1 thru 50 : For the direct PLU menu key.
- **MENU TITLE (Use the character entry)**
 Description for the PLU menu key.
 Up to 16 characters can be entered.
- **TYPE (Use the selective entry)**
 PLU: Selects to program a PLU.
 MENU: Selects to program a sub-menu.
- **PLU or MENU (Use the numeric entry)**
 Select a menu PLU or sub-menu from the list.

NOTE

When selecting a sub-menu, the screen on which a sub-menu number is to be entered (the message “MENU”) will appear.

NOTE

- PLU code should be defined before programming a PLU menu key.
- If the **DELETE** key is touched on the menu key number selection menu, the menu list will be canceled.
- If the **DELETE** key is touched on the menu PLU code selection menu, the menu in the cursor position will be deleted.

■ Combo meal (Combo PLU)

When two or more menu items, consisting of PLUs related to a special offered, are to be programmed together, combo PLUs should be specified. Up to 25 PLUs can be linked to each combo PLU.

Procedure



Selected combo
meal no. →

ENTER

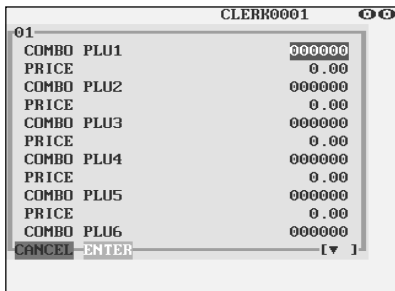

The screen continues.

Program each item as follows:

- **COMBO MEAL (Use the numeric entry)**
Combo meal number (1 through 99)
- **COMBO PLUXX**
Enter tied PLU codes (max. 25 PLUs).
- **PRICE (Use the numeric entry)**
Enter the unit price of each combo menu (max. 6 digits)

NOTE

- *PLU codes should be defined before programming a combo PLU.*
- *If the **DELETE** key is touched on the meal number selection menu, the combo PLU in the cursor position will be deleted.*

■ Link PLU table

It is possible to link PLUs together so that all PLUs linked together are rung up upon a single key touch. However, the number of links is a maximum of five. Even if more than five PLUs are linked, the sixth or higher link is not actualized.

Procedure



Selected link
PLU table no.



ENTER

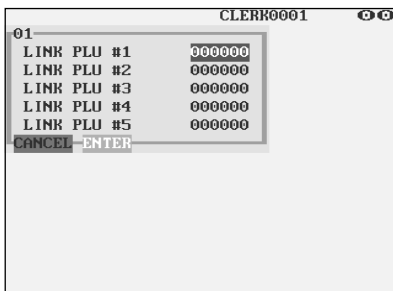

Program each item as follows:

- **LINK PLU TABLE (Use the numeric entry)**

Link PLU table number (1 through 99)

- **LINK PLU #X**

Enter linked PLU codes (max. 5 PLUs).

NOTE

- *PLU codes should be defined before programming a link PLU table.*
- *If the **DELETE** key is touched on the table number selection menu, the selected table will be deleted.*

■ Condiment table

The “condiment entry” is intended to guide the operator in making menu entries which require special cooking instructions. For example, a clerk can make such entries as “garnishing potato,” “with salad,” and “grilling steak rate.” When a clerk enters a menu-item PLU to which PLUs for the condiment entry have been assigned, these orders (such as “garnishing potato”) will be printed on the receipt and conveyed to the kitchen.

Before you program for the condiment entry, prepare a condiment table. The following shows an example of a condiment table:

Condiment table

Table number	PLU codes for condiment entry (programmed text)					
01	Message text (HOWCOOK?)	23 (RARE)	25 (MED.RARE)	27 (WELLDONE)	02
02	Message text (WITH?)	44 (SALAD)	45 (FRUITS)		
.....
04	Message text (POTATO?)	33 (P.CHIPS)	37 (MASHED.P)	38 (BAKED.P)		99
99	Message text (DRINK?)	63 (TEA)	65 (MILK)	67 (A.JUICE)	

PLUs (Up to 20)
Next condiment table number

Condiment tables (Up to 99)

The condiment table should contain the following:

Condiment table: The condiment table is a group of condiment PLUs, which is assigned to each menu-item PLU. A table consists of a message text and up to 20 PLUs. Also, you can assign the next condiment table number to a condiment table to link them.

The message text is used for displaying a prompting message. The PLU is used for the special order setting. For example, when a clerk enters a menu-item PLU, a display message programmed for the message text such as “HOWCOOK?.” will appear. Then specify one of the PLU programmed for text such as “RARE.”

Table number: The table number is intended to identify each condiment table.

NOTE

*The condiment PLU programmed in a condiment table can be linked with condiment table (**Item link method**).*

For example, if PLU 44 (SALAD) in a table of the above is linked with condiment table 10 (SAUCE), when the condiment PLU 44 (SALAD) is registered, items of the condiment table 10 (SAUCE) will be appeared.

Table number	PLU codes for condiment entry (programmed text)				
10	Message text (SAUCE)	51 (ITALIAN)	53 (FRENCH)	12

Next condiment table number

Procedure

CONDIMENT TABLE
CLERK0001
NOTHING
CANCEL ENTER

Selected
condiment
table number → ENTER

01
CONDIMENT PLUXX
CLERK0001
MESSAGE
NEXT LINK TBL# 00
CONDIMENT PLU01 000000
CONDIMENT PLU02 000000
CONDIMENT PLU03 000000
CONDIMENT PLU04 000000
CONDIMENT PLU05 000000
CONDIMENT PLU06 000000
CONDIMENT PLU07 000000
CONDIMENT PLU08 000000
CONDIMENT PLU09 000000
CANCEL ENTER [▼]

The screen continues.

Program each item as follows:

- **CONDIMENT TABLE (Use the numeric key)**
Condiment table number (1 through 99)
- **MESSAGE (Use the character entry)**
Description for a condiment menu.
Up to 16 characters can be entered.
- **NEXT LINK TBL# (Use the numeric key)**
Enter the next condiment table number (max. 2 digits).
- **CONDIMENT PLUXX**
Enter condiment PLU codes (max. 60 PLUs).

NOTE

- *The message text is used as the display prompt.*
- *PLU codes should be defined before programming a condiment table.*
- *If the **DELETE** key is touched on the table number selection menu, the table in the cursor position will be deleted.*

■ Promotion table (normal selling)

There are two types of promotion tables: a normal selling type and a set selling type. If you want to change the type, please contact your authorized SHARP dealer.

Procedure

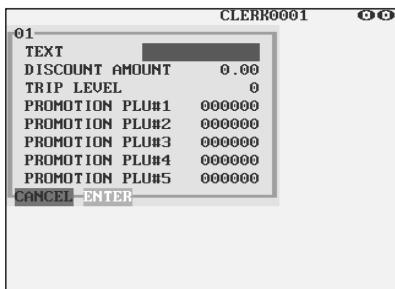
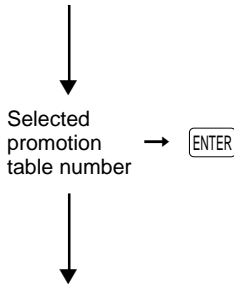

Program each item as follows:

- **PROMOTION TABLE (Use the numeric entry)**
Promotion table number (1 through 99)
- **TEXT (Use the character entry)**
Description for each promotion table (max. 12 characters)
- **DISCOUNT AMOUNT (Use the numeric entry)**
Discount amount for each promotion table (max. 6 digits)
- **TRIP LEVEL (Use the numeric entry)**
Trip level for discount (satisfying count of entered item)
- **PROMOTION PLU #1 through #5 (Use the numeric entry)**
Enter promotion PLU codes.

NOTE

- *PLU codes should be defined before programming a promotion table.*
- *If the **DELETE** key is touched on the table number selection menu, the table in the cursor position will be deleted.*

■ Promotion table (set selling)

Procedure



Selected promotion
table number

→

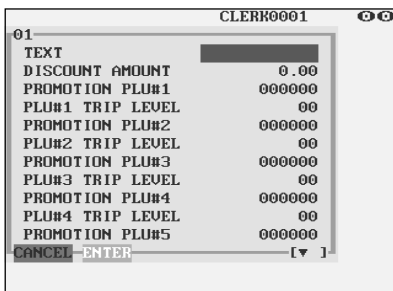

The screen continues.

Program each item as follows:

- **PROMOTION TABLE (Use the numeric entry)**
Promotion table number (1 through 99)
- **TEXT (Use the character entry)**
Description for a promotion PLU (max. 12 characters)
- **DISCOUNT AMOUNT (Use the numeric entry)**
Discount amount for a promotion table (max. 6 digits)
- **PROMOTION PLU#1 through #5 (Use the numeric entry)**
Enter promotion PLU codes.
- **PLU#1 through #5 TRIP LEVEL (Use the numeric entry)**
Trip level for discount (satisfying count of entered item) for each promotion PLU (max. 2 digits)

NOTE

- *PLU codes should be defined before programming a promotion table.*
- *If the key is touched on the table number selection menu, the table in the cursor position will be deleted.*

■ Recipe table

You can make a recipe table which contains up to ten ingredients.

Procedure



Selected
recipe table
number

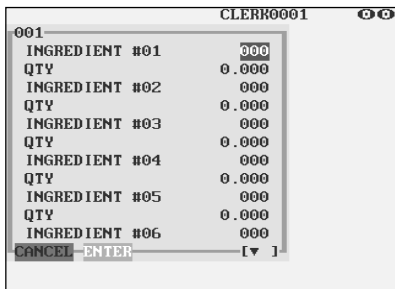

The screen continues.

Program each item as follows:

- **RECIPE TABLE (Use the numeric entry)**
Recipe table number (1 through 999)
- **INGREDIENT #XX (Use the numeric entry)**
Enter ingredient numbers (max. 10 ingredients).
- **QTY (Use the numeric entry)**
Enter the usage of each ingredient.
(max. 7 digits: 0 to 9999.999 (9999999)).

NOTE

- *Ingredient numbers should be defined before programming a recipe table.*
- *If the **DELETE** key is touched on the table number selection menu, the table in the cursor position will be deleted.*

■ Scale table

You can program up to nine scale tables and allows different tares to be assigned to them.

Procedure



A screenshot of a POS terminal screen showing the 'SCALE TABLE' menu. The screen title is 'CLERK0001'. The menu lists scale table numbers 1 through 9. At the bottom, there are 'CANCEL' and 'ENTER' options.

Selected
scale table
number

→ ENTER



A screenshot of a POS terminal screen showing the 'WEIGHT' entry screen for scale table 1. The screen title is 'CLERK0001'. The menu shows '1' at the top, followed by 'WEIGHT' and a text input field containing '0.000kg'. At the bottom, there are 'CANCEL' and 'ENTER' options.

Program each item as follows:

- **SCALE TABLE (Use the numeric entry)**

Scale table number (1 through 9)

- **WEIGHT (Use the numeric entry)**

Enter a tare weight for the scale table number (max. 4 digits:
1 to 9.999 kg (1 to 99.99 lbs.)).

NOTE

Your POS terminal may also be set to accommodate 1-integer +3-decimal weights. For more details, please contact your authorized SHARP dealer.

■ Department shift

Procedure

```
CLERK0001
DEPT. SHIFT
DEPT. SHIFT1 00
DEPT. SHIFT2 00
DEPT. SHIFT3 00
DEPT. SHIFT4 00
CANCEL ENTER
```

Program the item as follows:

- **DEPT. SHIFT 1 through 4 (Use the numeric entry)**

Enter an associated department code for each department shift key (max. 2 digits).

NOTE

If an associated department code which was changed by the [D.SFT1] through [D.SFT4] keys is "00," it will not change. In this case, an error will occur.

■ Happy hour

You can program a time range for each price level. When a clerk enters a PLU code, the price level for which you have programmed a time range will be automatically entered. For example, if you program the time range 9:00 AM to 11:00 AM for price level 2, only the price programmed for price level 2 is entered from 9:00 AM to 11:00 AM.

Procedure

```
CLERK0001
HAPPY HOUR
SFT1 START TIME 0000
SFT1 END TIME 0000
SFT2 START TIME 0000
SFT2 END TIME 0000
SFT3 START TIME 0000
SFT3 END TIME 0000
SFT4 START TIME 0000
SFT4 END TIME 0000
SFT5 START TIME 0000
SFT5 END TIME 0000
SFT6 START TIME 0000
SFT6 END TIME 0000
CANCEL ENTER [v]
```

Program the item as follows:

- **SFT1 through SFT7 START TIME and END TIME (Use the numeric entry)**

Enter the starting and ending times for each price level (time range: 0000 to 2359).

NOTE

When the starting and ending times are set at "0000," the "Happy hour" function is not available.

The screen continues.

Direct Key Programming

Use the following procedure to select direct-key programming:

Procedure

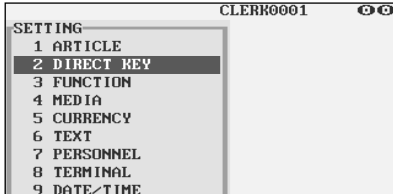

1. In the SETTING window, select "2 DIRECT KEY."
 - The DIRECT KEY window will appear.

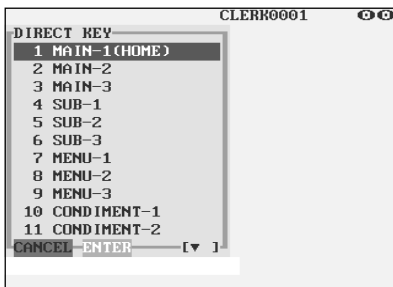

2. Select desired the keyboard to program from the keyboard list.

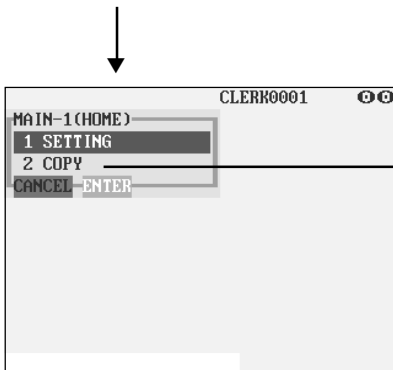

3. Select SETTING or COPY. If SETTING is selected, the programming can be performed.

When COPY is selected, the key layout data can be copied from the keyboard list.

Select copied key layout from the list.

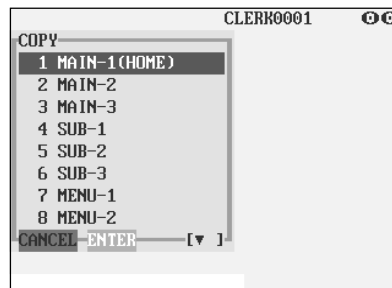

Leads to the programming for each key

■ Direct PLU/dept. key

You can assign PLUs and departments directly to the keyboard. In the case of PLUs, you may assign up to 10-levels to be accessed directly on the keyboard.

Procedure

Take **STEP 1** thru **STEP 3** shown above to open the window for programming each direct key.

Touch a pertinent key.

061 CLERK0001

TYPE	PLU
------	-----

CANCEL ENTER

061 CLERK0001

LEVEL1	000001
LEVEL2	000101
LEVEL3	000000
LEVEL4	000000
LEVEL5	000000
LEVEL6	000000
LEVEL7	000000
LEVEL8	000000
LEVEL9	000000
LEVEL10	000000

CANCEL ENTER

In the case of setting "000001 DIRECT PLU"

• TYPE (Use the selective entry)

- PLU: Assigns the key as a direct PLU key.
- DEPT: Assigns the key as a direct department key.

NOTE

- When selecting a department, the screen on which a department code is to be entered (the message "DEPT. CODE") will appear.
- When selecting a PLU, the screen on which a PLU code is to be entered ("PLU CODE") will appear.

• LEVEL1 thru 10 (Use the numeric entry)

Enter a PLU code for each level. For example, if you want to use this key as PLU code1 (level 1) and PLU code101 (level 2), enter 1 for the "LEVEL1" and 101 for the "LEVEL2."

NOTE

- You cannot assign a PLU or a department to the position to which a function key has been assigned.

Functional Programming

Use the following procedure to select any option included in the functional programming group:

Procedure

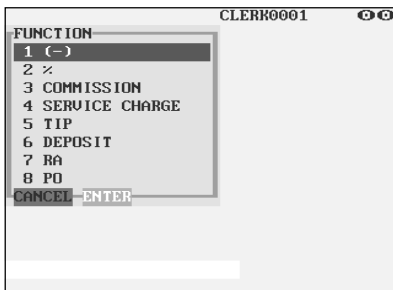
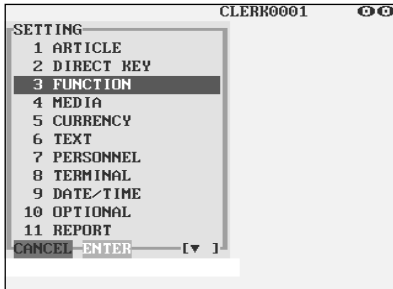

1. In the SETTING window, select “3 FUNCTION.”

- The FUNCTION window will appear.

2. Select any option from the following options list:

1 (-) :	Discount key
2 % :	Percent key
3 COMMISSION :	Commission
4 SERVICE CHARGE :	Service charge
5 TIP :	Tip
6 DEPOSIT :	Deposit
7 RA :	Received on account
8 PO :	Paid out

The following illustration shows those options included in the functional programming group.

3 FUNCTION	1 (-)	➔ See “ ■ Discount key” on page 159.
	2 %	➔ See “ ■ Percent key” on page 160.
	3 COMMISSION	➔ See “ ■ Commission” on page 160.
	4 SERVICE CHARGE	➔ See “ ■ Service charge” on page 161.
	5 TIP	➔ See “ ■ Tip” on page 161.
	6 DEPOSIT	➔ See “ ■ Deposit” on page 162.
	7 RA	➔ See “ ■ RA” on page 162.
	8 PO	➔ See “ ■ PO” on page 163.

■ Discount key ((-)1 through (-)9)

Procedure

Select a pertinent discount key from the discount keys list.

```
CLERK0001
( - )1
AMOUNT          -0.00
TEXT            =(--)=1
SIGN            -
HALO            18
ENTRY TYPE      SBTL
CANCEL ENTER
```

Program each item as follows:

- **AMOUNT (Use the numeric entry)**
Discount amount (max. 6 digits)
- **TEXT (Use the character entry)**
Description for the discount key. Up to 12 characters can be entered.
- **SIGN (Use the selective entry)**
Programming of the + or – sign assigns the premium or discount function to each discount key.
 - : Minus amount (discount)
 - +: Plus amount (premium)
- **HALO (High Amount Lockout) (Use the numeric entry)**
 - A: Significant digit for HALO (1 through 9)
 - B: Number of zeros to follow the significant digit for HALO (0 through 8)
 - AB is the same as $A \times 10^B$.
- **ENTRY TYPE (Use the selective entry)**
 - RA: Received on account (–)
 - ITEM: Item (–)
 - SBTL: Subtotal (–)

■ Percent key (%1 through %9)

Procedure

Select a pertinent percent key from the percent keys list.

CLERR0001

RATE	-0.00%
TEXT	=1
SIGN	-
%HALO	100.00%
ENTRY TYPE	SBTL

CANCEL ENTER

Program each item as follows:

- **RATE (Use the numeric entry)**
Percent rate (0.00 to 100.00)
- **TEXT (Use the character entry)**
Description for the percent key. Up to 12 characters can be entered.
- **SIGN (Use the selective entry)**
Programming of the + or – sign assigns the premium or discount function to each percent key.
–: Minus (discount)
+: Plus (premium)
- **%HALO (High Amount Lockout) (Use the numeric entry)**
HALO (High Amount Lockout) for the percent key (0.00 to 100.00)
- **ENTRY TYPE (Use the selective entry)**
RA: Received on account %
ITEM: Item %
SBTL: Subtotal %

■ Commission

Procedure

Select a pertinent commission no. from the commission list.

CLERR0001

COM.SAL1	
RATE	0.000%
TEXT	COM.SAL1

CANCEL ENTER

Program each item as follows:

- **RATE (Use the numeric entry)**
Percent rate (0.00 to 99.999)
- **TEXT (Use the character entry)**
Description for the commission. Up to 12 characters can be entered.

■ Service charge

Procedure

SERVICE CHARGE
CLERK0001
RATE 0.00%
TEXT SER . CHR
CANCEL-ENTER

Program each item as follows:

- **RATE (Use the numeric entry)**
Percent rate (0.00 to 100.00)
- **TEXT (Use the character entry)**
Description for the service charge. Up to 12 characters can be entered.

■ Tip

Procedure

Select a pertinent tip key from the tip keys list.

CASH TIP
CLERK0001
HALO 10
TEXT CASH TIP
CANCEL-ENTER

Program each item as follows:

- **HALO (High Amount Lockout) (Use the numeric entry)**
 - A: Significant digit for HALO (1 through 9)
 - B: Number of zeros to follow the significant digit for HALO (0 through 8)
 - AB is the same as $A \times 10^B$.
- **TEXT (Use the character entry)**
Description for the tip. Up to 12 characters can be entered.

■ Deposit

Procedure

Select a pertinent deposit key from the deposit keys list.

```
CLERK0001
DEPOSIT
HALO
TEXT
CANCEL ENTER
```

Program each item as follows:

- **HALO (High Amount Lockout) (Use the numeric entry)**

A: Significant digit for HALO (1 through 9)

B: Number of zeros to follow the significant digit for HALO (0 through 8)

AB is the same as $A \times 10^B$.

- **TEXT (Use the character entry)**

Description for the deposit. Up to 12 characters can be entered.

■ RA

You can program an upper limit amount and description for each received-on-account key.

Procedure

Select a pertinent received-on-account key from the RA keys list.

```
CLERK0001
***RA
HALO
TEXT
CANCEL ENTER
```

Program each item as follows:

- **HALO (High Amount Lockout) (Use the numeric entry)**

A: Significant digit for HALO (1 through 9)

B: Number of zeros to follow the significant digit for HALO (0 through 8)

AB is the same as $A \times 10^B$.

- **TEXT (Use the character entry)**

Description for the received-on-account key. Up to 12 characters can be entered.

■ PO

You can program an upper limit amount and description for each paid-out key.

Procedure

Select a pertinent paid-out key from the PO keys list.



A screenshot of a terminal window with the title 'CLERR0001'. The window displays a menu with the following options: '***PO', 'HALO', 'TEXT', and 'CANCEL ENTER'. A cursor is positioned on the 'TEXT' option. To the right of the 'TEXT' option, there is a small box containing the number '18'. The 'CANCEL ENTER' option is highlighted with a grey background.

Program each item as follows:

- **HALO (High Amount Lockout) (Use the numeric entry)**
 - A: Significant digit for HALO (1 through 9)
 - B: Number of zeros to follow the significant digit for HALO (0 through 8)
 - AB is the same as $A \times 10^B$.
- **TEXT (Use the character entry)**
 - Description for the paid-out key. Up to 12 characters can be entered.

Media Key Programming

Use the following procedure to select any option included in the media group:

Procedure

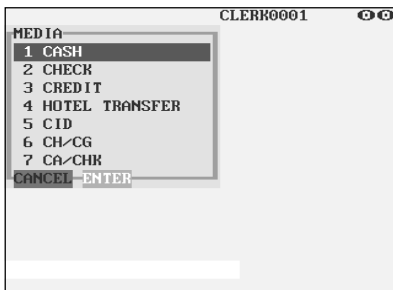
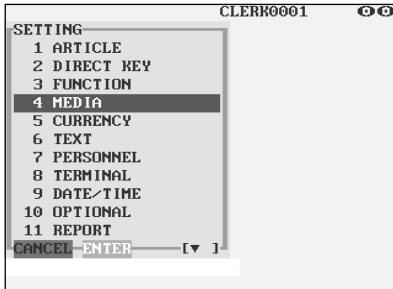

1. In the SETTING window, select "4 MEDIA."

- The MEDIA window will appear.

2. Select any option from the following options list:

- | | |
|--------------------|--------------------|
| 1 CASH : | Cash key |
| 2 CHECK : | Check key |
| 3 CREDIT : | Credit key |
| 4 HOTEL TRANSFER : | Hotel transfer key |
| 5 CID : | Cash in drawer |
| 6 CH/CG : | Check change |
| 7 CA/CHK : | Check cashing |

The following illustration shows those options included in the media key programming group.

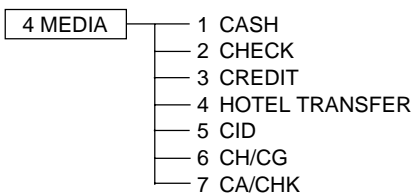

- ➔ See "■ Cash key" on page 165.
- ➔ See "■ Check key" on page 166.
- ➔ See "■ Credit key" on page 167.
- ➔ See "■ Hotel transfer key" on page 168.
- ➔ See "■ Cash in drawer" on page 169.
- ➔ See "■ Check change" on page 169.
- ➔ See "■ Check cashing" on page 170.

■ Cash key

Procedure

Select a pertinent cash key from the cash keys list.

Cash Key	Setting
CASH	
TEXT	=CASH
HALO	18
BILL PRINT	NON-COMPULSORY
FOOTER PRINT	NO
NON-ADD # ENTRY	NON-COMPULSORY
UP	NON-COMPULSORY
DRAWER OPENING	NO
AMOUNT ENTRY	NON-COMPULSORY
CANCEL-ENTER	

Program each item as follows:

- **TEXT (Use the character entry)**
Description for the cash key. Up to 12 characters can be entered.
- **HALO (High Amount Lockout) (Use the numeric entry)**
AB is the same as $A \times 10^B$.
A: Significant digit (1 through 9)
B: Number of zeros to follow the significant digit (0 through 8)
You can set AB at 18 for no limitation.
- **BILL PRINT (Use the selective entry)**
COMPULSORY: Makes bill printing compulsory.
NON-COMPULSORY: Makes bill printing non-compulsory.
- **FOOTER PRINT (Use the selective entry)**
This item decides whether or not your POS terminal should print a message at the foot of a receipt when a specified cash key is used.
YES: Enables footer printing on the receipt.
NO: Disables footer printing on the receipt.
- **NON-ADD # ENTRY (Use the selective entry)**
You can enforce the non-add code entry when a cash entry is accepted.
COMPULSORY: Compulsory non-add code entry
NON-COMPULSORY: Non-compulsory non-add code entry
- **VP (Use the selective entry)**
COMPULSORY: Compulsory validation printing
NON-COMPULSORY: Non-compulsory validation printing
- **DRAWER OPENING (Use the selective entry)**
You can program each cash key to open the drawer.
YES: Opens the drawer.
NO: Disables the drawer opening.
- **AMOUNT ENTRY (Use the selective entry)**
You may select compulsory or non-compulsory amount tender.
COMPULSORY: Compulsory amount tendered entry
NON-COMPULSORY: Non-compulsory amount tendered entry

■ Check key (CHK through CHK4)

Procedure

Select a pertinent check key from the check keys list.

CHECK	CHECK
TEXT	18
HALO	NON-COMPULSORY
EFT FUNCTION	NON-COMPULSORY
BILL PRINT	NON-COMPULSORY
FOOTER PRINT	NO
NON-ADD # ENTRY	NON-COMPULSORY
CHANGE DUE	ENABLE
UP	NON-COMPULSORY
DRAWER OPENING	NO
AMOUNT ENTRY	NON-COMPULSORY

CANCEL ENTER

Program each item as follows:

- **TEXT (Use the character entry)**
Description for the check key. Up to 12 characters can be entered.
- **HALO (High Amount Lockout) (Use the numeric entry)**
AB is the same as $A \times 10^B$.
A: Significant digit (1 through 9)
B: Number of zeros to follow the significant digit (0 through 8)
You can set AB at 18 for no limitation.
- **EFT FUNCTION (Use the selective entry)**
COMPULSORY: Makes EFT function compulsory.
NON-COMPULSORY: Makes EFT function non-compulsory.
- **BILL PRINT (Use the selective entry)**
COMPULSORY: Compulsory bill printing
NON-COMPULSORY: Non-compulsory bill printing
- **FOOTER PRINT (Use the selective entry)**
YES: Enables footer printing on the receipt.
NO: Disables footer printing on the receipt.
- **NON-ADD # ENTRY (Use the selective entry)**
COMPULSORY: Compulsory non-add code entry
NON-COMPULSORY: Non-compulsory non-add code entry
- **CHANGE DUE (Use the selective entry)**
Either change enable or disable can be selected for each check key.
DISABLE: Disables change calculation.
ENABLE: Enables change calculation.
- **VP (Use the selective entry)**
COMPULSORY: Compulsory validation printing
NON-COMPULSORY: Non-compulsory validation printing
- **DRAWER OPENING (Use the selective entry)**
YES: Opens the drawer.
NO: Disables the drawer opening.
- **AMOUNT ENTRY (Use the selective entry)**
COMPULSORY: Compulsory amount tendered entry
NON-COMPULSORY: Non-compulsory amount tendered entry

■ Credit key (CR1 through CR8)

Procedure

Select a pertinent credit key from the credit keys list.

CREDIT1	
TEXT	CREDIT1
HALO	18
EFT FUNCTION	NON-COMPULSORY
BILL PRINT	NON-COMPULSORY
FOOTER PRINT	NO
NON-ADD # ENTRY	NON-COMPULSORY
CHANGE DUE	ENABLE
UP	NON-COMPULSORY
DRAWER OPENING	NO
AMOUNT ENTRY	INHIBIT
CANCEL-ENTER	

Program each item as follows:

- **TEXT (Use the character entry)**
Description for the credit key. Up to 12 characters can be entered.
- **HALO (High Amount Lockout) (Use the numeric entry)**
AB is the same as $A \times 10^B$.
A: Significant digit (1 through 9)
B: Number of zeros to follow the significant digit (0 through 8)
You can set AB at 18 for no limitation.
- **EFT FUNCTION (Use the selective entry)**
COMPULSORY: Makes EFT function compulsory.
NON-COMPULSORY: Makes EFT function non-compulsory.
- **BILL PRINT (Use the selective entry)**
COMPULSORY: Compulsory bill printing
NON-COMPULSORY: Non-compulsory bill printing
- **FOOTER PRINT (Use the selective entry)**
This item decides whether or not your POS terminal should print a message at the foot of a receipt when a specified credit key is used.
YES: Enables footer printing on the receipt.
NO: Disables footer printing on the receipt.
- **NON-ADD # ENTRY (Use the selective entry)**
COMPULSORY: Compulsory non-add code entry
NON-COMPULSORY: Non-compulsory non-add code entry
- **CHANGE DUE (Use the selective entry)**
DISABLE: Disables change calculation.
ENABLE: Enables change calculation.
- **VP (Use the selective entry)**
COMPULSORY: Compulsory validation printing
NON-COMPULSORY: Non-compulsory validation printing
- **DRAWER OPENING (Use the selective entry)**
YES: Opens the drawer.
NO: Disables the drawer opening.
- **AMOUNT ENTRY (Use the selective entry)**
COMPULSORY: Makes amount tendered entry compulsory.
INHIBIT: Inhibits amount tendered entry.

■ Hotel transfer key

Procedure

```
CLERH0001
HOTEL TRANSFER
TEXT          HOTEL TRANS.
HALO          18
BILL PRINT    NON-COMPULSORY
FOOTER PRINT  NO
NON-ADD # ENTRY NON-COMPULSORY
CHANGE DUE    ENABLE
UP            NON-COMPULSORY
DRAWER OPENING NO
CANCEL-ENTER
```

Program each item as follows:

- **TEXT (Use the character entry)**
Description for the hotel transfer key. Up to 12 characters can be entered.
- **HALO (High Amount Lockout) (Use the numeric entry)**
AB is the same as $A \times 10^B$.
A: Significant digit for HALO (1 through 9)
B: Number of zeros to follow the significant digit for HALO (0 through 8)
You can set AB at 18 for no limitation.
- **BILL PRINT (Use the selective entry)**
COMPULSORY: Compulsory bill printing
NON-COMPULSORY: Non-compulsory bill printing
- **FOOTER PRINT (Use the selective entry)**
YES: Enables footer printing on the receipt.
NO: Disables footer printing on the receipt.
- **NON-ADD # ENTRY (Use the selective entry)**
COMPULSORY: Compulsory non-add code entry
NON-COMPULSORY: Non-compulsory non-add code entry
- **CHANGE DUE (Use the selective entry)**
DISABLE: Disables change due.
ENABLE: Enables change due.
- **VP (Use the selective entry)**
COMPULSORY: Compulsory validation printing
NON-COMPULSORY: Non-compulsory validation printing
- **DRAWER OPENING (Use the selective entry)**
YES: Opens the drawer.
NO: Disables the drawer opening.

■ Cash in drawer

You can program the description and the upper limit amounts for cash in drawer (sentinel).

Procedure

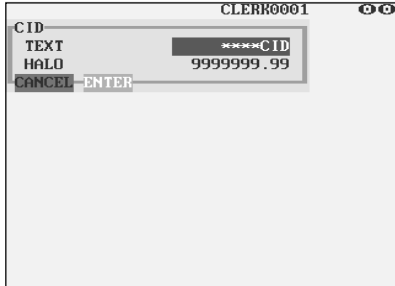

A screenshot of a terminal window titled 'CLERK0001'. The screen displays a menu with the following options: 'CID', 'TEXT', 'HALO', and 'CANCEL-ENTER'. The 'TEXT' option is highlighted with a cursor. To the right of the 'TEXT' option, there is a field containing '****CID'. Below the 'HALO' option, there is a field containing '999999.99'.

Program each item as follows:

- **TEXT (Use the character entry)**
Description for the cash in drawer.
Up to 12 characters can be entered.
- **HALO (High Amount Lockout) (Use the numeric entry)**
Limit amount: 0 to 999999.99

■ Check change

You can program the description and the upper limit amounts for check change.

Procedure

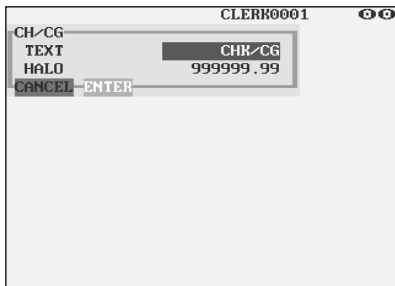

A screenshot of a terminal window titled 'CLERK0001'. The screen displays a menu with the following options: 'CH/CG', 'TEXT', 'HALO', and 'CANCEL-ENTER'. The 'TEXT' option is highlighted with a cursor. To the right of the 'TEXT' option, there is a field containing 'CHK/CG'. Below the 'HALO' option, there is a field containing '999999.99'.

Program each item as follows:

- **TEXT (Use the character entry)**
Description for check change.
Up to 12 characters can be entered.
- **HALO (High Amount Lockout) (Use the numeric entry)**
Limit amount: 0 to 999999.99

■ Check cashing

You can program the description and the upper limit amounts for check cashing.

Procedure

Select a pertinent check cashing no.
from the check cashing numbers list.

CA/CHK	TEXT	HALO
CA/CHK		999999.99

CANCEL ENTER

Program each item as follows:

- **TEXT (Use the character entry)**
Description for check cashing.
Up to 12 characters can be entered.
- **HALO (High Amount Lockout) (Use the numeric entry)**
Limit amount: 0 to 999999.99

Currency Programming

In the SETTING window, select "5 CURRENCY", and take the following procedure.

■ Currency exchange key (EXCHANGE1 through EXCHANGE9)

Procedure

Select a pertinent currency exchange key from the currency exchange keys list.

CLERK0001

FOREIGN1

RATE 0.000000

TEXT EXCH1

TAB 2

DESCRIPTOR

CANCEL-ENTER

Program each item as follows:

- **RATE (Use the numeric entry)**
Currency exchange rate (0.000000 to 999.999999)
- **TEXT (Use the character entry)**
Description for the currency exchange key. Up to 12 characters can be entered.
- **TAB (Use the numeric entry)**
Tabulation (0 to 3)
- **DESCRIPTOR (Use the character entry)**
Currency descriptor. Up to 4 characters can be entered.

■ Foreign drawer

Procedure

CLERK0001

FOREIGN DRAWER#

FOREIGN DRAWER# DRAWER1

CANCEL-ENTER

Program each item as follows:

- **FOREIGN DRAWER# (Use the selective entry)**
DRAWER2/DRAWER1/NONE

Text Programming

Use the following procedure to select any option included in the text group:

Procedure

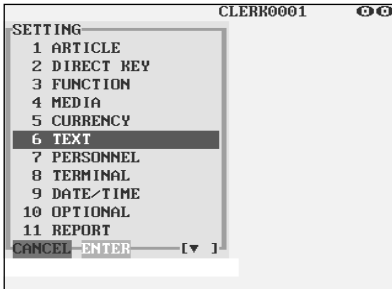

1. In the SETTING window, select "6 TEXT."

- The TEXT window will appear.

2. Select any option from the following options list:

- | | |
|------------------|-----------------------|
| 1 FUNCTION TEXT: | Function text |
| 2 DEPT. GROUP: | Department group text |
| 3 PLU GROUP: | PLU group text |
| 4 PLU HOURLY GR: | PLU hourly group text |

The following illustration shows those options included in the text programming group.



■ Function text

You can program a maximum of 12 characters for each function by using the following table:

Procedure

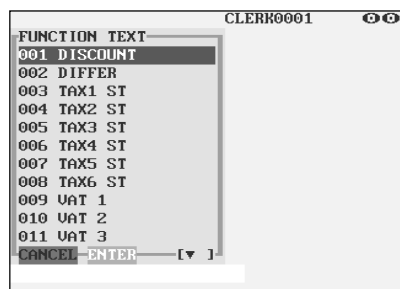

The screen continues.

No.	Function	Default text
001	Promotion discount	DISCOUNT
002	Difference	DIFFER
003	Taxable 1 subtotal	TAX1 ST
004	Taxable 2 subtotal	TAX2 ST
005	Taxable 3 subtotal	TAX3 ST
006	Taxable 4 subtotal	TAX4 ST
007	Taxable 5 subtotal	TAX5 ST
008	Taxable 6 subtotal	TAX6 ST
009	VAT/tax 1	VAT 1
010	VAT/tax 2	VAT 2
011	VAT/tax 3	VAT 3
012	VAT/tax 4	VAT 4
013	VAT/tax 5	VAT 5
014	VAT/tax 6	VAT 6
015	Net 1	NET 1
016	Net 2	NET 2
017	Coupon-like PLU	CP PLU
018*	Void issued order-receipt	VD
019	Subtotal void	SBTL VD
020	MGR void	MGR VD
021	Void	VOID
022	Refund	REFUND
023	Return	RETURN
024*	Hash void issued order-receipt	HASH VD
025	Hash refund	HASH RF
026	Hash return	HASH RT
027*	Non-turnover void	NOTURNVD

No.	Function	Default text
028	Non-turnover refund	NOTURNRF
029	Non-turnover return	NOTURNRT
030	VAT shift	VAT SFT
031	VAT/tax delete	TAX DELE
032	VP counter	VP CNT
033	Bill counter	BILL CNT
034	No sale	NO SALE
035	Guest check counter	G.C. CNT
036	PBAL (for GLU)	***PBAL
037	PBAL (for drive-through)	***PBAL2
038	NBAL (for GLU)	***NBAL
039	NBAL (for drive-through)	***NBAL2
040	Starting cash memory (+)	SCM (+)
041	Starting cash memory (-)	SCM (-)
042	Exchange 1 is	EXCH1 IS
043	Exchange 2 is	EXCH2 IS
044	Exchange 3 is	EXCH3 IS
045	Exchange 4 is	EXCH4 IS
046	Exchange 5 is	EXCH5 IS
047	Exchange 6 is	EXCH6 IS
048	Exchange 7 is	EXCH7 IS
049	Exchange 8 is	EXCH8 IS
050	Exchange 9 is	EXCH9 IS
051	Cash/check is	CA/CK IS
052	Cash/check in drawer	CA/CK ID
053	Guest	GUEST
054	Non-commission sale	NON COM.

* This void is applied to PBAL.

■ Function text (continued)

No.	Function	Default text
055	VIP sale	VIP SALE
056	Waste total	WASTE TL
057	Order total	ORDER TL
058	Paid total	PAID TL
059	Transfer out	TRAN.OUT
060	Transfer in	TRAN.IN
061	Tip paid	TIP PAID
062	Domestic currency 1	DOM.CUR1
063	Domestic currency 2	DOM.CUR2
064	Domestic currency 3	DOM.CUR3
065	Domestic currency 4	DOM.CUR4
066	Domestic currency 5	DOM.CUR5
067	Domestic currency 6	DOM.CUR6
068	Domestic currency 7	DOM.CUR7
069	Domestic currency 8	DOM.CUR8
070	Domestic currency 9	DOM.CUR9
071	Non-turnover total 1	*NT TL1
072	Non-turnover total 2	*NT TL2
073	Non-turnover total 3	*NT TL3
074	Check in drawer	*CH ID
075	(+)dept. total	*DEPT TL
076	(-)dept. total	DEPT(-)
077	Hash(+) total	*HASH TL
078	Hash(-) total	HASH(-)
079	Net 1 (Taxable 1 - VAT/tax 1)	NET 1
080	Net 2 (Taxable 2 - VAT/tax 2)	NET 2
081	Net 3 (Taxable 3 - VAT/tax 3)	NET 3
082	Net 4 (Taxable 4 - VAT/tax 4)	NET 4
083	Net 5 (Taxable 5 - VAT/tax 5)	NET 5
084	Net 6 (Taxable 6 - VAT/tax 6)	NET 6
085	Subtotal	SUBTOTAL
086	Merchandise subtotal	MDSE ST
087	Total	***TOTAL
088	Difference subtotal	DIFF ST
089	Non-turnover subtotal	NON-TURN
090	Change	CHANGE
091	English check print	CHECK PR
092	Due	DUE
093	Tip due	TIP DUE
094	Balance	BALANCE
095	Sales q'ty	ITEMS
096	PLU subtotal	PLU ST

No.	Function	Default text
097	Copy receipt title	COPY
098	Guest check copy title	G.C COPY
099	Bill totalize/transfer title	B.T.
100	Bill separation title	B.S.
101	Intermediate GLU reading title	INTERMED.
102	Bill on receipt title	BILL
103	Cumulated bill title	C.BILL
104	VIP sale title	VIP SALE
105	WASTE mode title	WASTE
106	Slip print journal message	SLIP PR.
107	Slip next page	NEXT P.
108	Average	AVE.
109	CCD	CCD
110	CCD difference	CCD DIF.
111	CCD difference total	DIF. TL
112	Order total - Paid total	O - P
113	Commission amount 1	COM.AMT1
114	Commission amount 2	COM.AMT2
115	Commission amount 3	COM.AMT3
116	Commission amount total	COM.TTL
117	Bill balance	BILL BAL
118	Free GLU	FREE GLU
119	Old balance	OLD BAL.
120	New balance	BALANCE
121	Starting cash memory total	SCM TTL
122	Turnover per table	T.TABLE
123	Turnover per guest	T.GUEST
124	Turnover per bill	T.BILL
125	Item per guest	I.GUEST
126	Item per bill	I.BILL
127	Average price per item	AVE.ITEM
128	Cost	COST
129	Cost %	COST%
130	Total cost	TTL COST
131	Job location number	LOC#
132	Job location cost	L.COST
133	Total hour	TTL HOUR
134	Overtime	OVR TIME
135	Over cost	OVR COST
136	Time-in	TIME-IN
137	Time-out	TIME-OUT
138	Break-in	BREAK-IN

■ Function text (continued)

No.	Function	Default text
139	Break-out	BREAK-OUT
140	Break total	BREAK TL
141	Labor %	LABOR%
142	Person number	PERSON#
143	Total tax	TTL TAX
144	Net without tax	NET
145	Town name 1	TOWNNAME
146	Town name 2	TOWNNAME
147	Cash transfer	TRANSFER
148	GLU code*	GLU #
149	Drive-through code*	CAR #
150	Pint sale	PINT SAL
151	Cumulated bill text (left half)	ALL FOODS &
152	Cumulated bill text (right half)	DRINKS
153	Independent payment	IND.PAY
154	Tare weight	TARE WT.
155	Receipt switch	RCP SW.
156	Subtotal of an individual clerk (drink dispenser reset)	RST SBTL
157	Total of all clerks (drink dispenser reset)	RESET TL
158	Total of an individual clerk in a drink dispenser misoperation file	MISOP TL
159	Bill void text	BILL VOID
160	WASTE on PLU report	WASTE
161	COMBO on PLU report	COMBO
162	COMBO WASTE on PLU report	COMBO WASTE
163	Check/credit payment for exchange 1	EX1CH+CR
164	Domestic currency 1 for check/credit	DOM.CHK/CR 1

■ Department group text

You can program a maximum of twelve characters for each department group (1 ~ 9).

Procedure

Select a pertinent department group number from the department groups list.

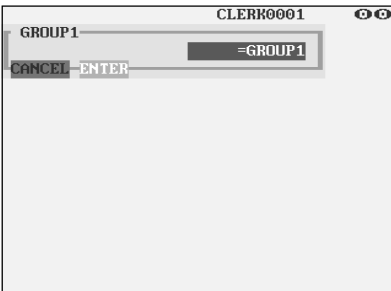

The screenshot shows a terminal window titled 'CLERR0001'. At the top left, 'GROUP1' is displayed. Below it, there is a text entry field containing '=GROUP1'. At the bottom left, there are two buttons labeled 'CANCEL' and 'ENTER'.

Program the item as follows:

- **TEXT (Use the character entry)**
Description for the department group.
Up to 12 characters can be entered.

■ PLU group text

You can program a maximum of twelve characters for each PLU group (1 ~ 99).

Procedure

Select a pertinent PLU group number from the PLU groups list.

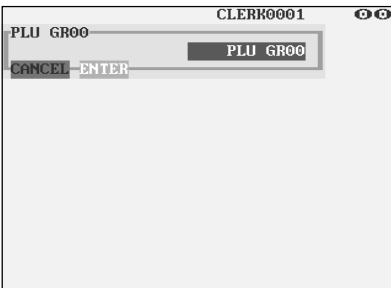

The screenshot shows a terminal window titled 'CLERR0001'. At the top left, 'PLU GR00' is displayed. Below it, there is a text entry field containing 'PLU GR00'. At the bottom left, there are two buttons labeled 'CANCEL' and 'ENTER'.

Program the item as follows:

- **TEXT (Use the character entry)**
Description for the PLU group.
Up to 12 characters can be entered.

■ PLU hourly group text

You can program a maximum of twelve characters for each PLU hourly group (1~9).

Procedure

Select a pertinent PLU hourly group no. from the hourly groups list.



The screenshot shows a terminal window titled "CLERK0001". The main display area contains the text "HOUR GR1" at the top left. Below it, there is a text entry field with "HOUR GR1" entered. At the bottom left of the entry field, the text "CANCEL ENTER" is visible. The terminal window has a standard header with the title and some control icons.

Program the item as follows:

- **TEXT (Use the character entry)**
Description for the PLU hourly group.
Up to 12 characters can be entered.

Personnel Programming

Use the following procedure to select any option included in the personnel group:

Procedure

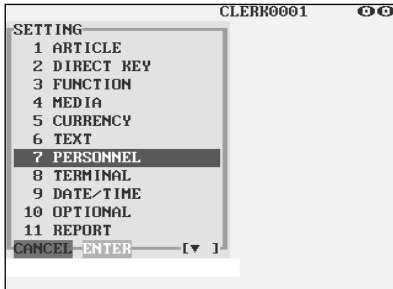

1. In the SETTING window, select “7 PERSONNEL.”

- The PERSONNEL window will appear.

2. Select any option from the following options list:

- | | |
|--------------------|--------------------|
| 1 CLERK : | Clerk |
| 2 MANAGER : | Manager |
| 3 EMPLOYEE : | Employee |
| 4 JOB LOCATE TBL : | Job location table |

The following illustration shows those options included in the personnel programming group.



■ Clerk

Procedure

```

CLERK                                CLERK0001
0001 CLERK0001
0002 CLERK0002
0003 CLERK0003
0004 CLERK0004
0005 CLERK0005
0006 CLERK0006
0007 CLERK0007
0008 CLERK0008
0009 CLERK0009
0010 CLERK0010
CANCEL ENTER
  
```



```

0001-                                CLERK0001
SECRET CODE                          0000
NAME                                  CLERK0001
KEY No.                               001
SUPERVISOR CLERK                      NO
VIP SALE                              ENABLE
GLU SYSTEM                            NON-COMPULSORY
G.C. COPY                             ENABLE
VAT SHIFT                             NOT
PRICE LEVEL                           PRICE 1
DRAWER No.                            DRAWER1
START CODE (GLU)                      00000001
CANCEL ENTER                          [v]
  
```

The screen continues.

Program each item as follows:

- **SECRET CODE (Use the numeric entry)**
Secret code (max. 4 digits: 0001 to 9999/0000)
- **NAME (Use the character entry)**
Name for the clerk. Up to 12 characters can be entered.
- **KEY No. (Use the numeric entry)**
Key number (0 through 255)
The entry of "0" disables the use of real clerk keys.
- **SUPERVISOR CLERK (Use the selective entry)**
YES: Enables supervisor clerk.
NO: Disables supervisor clerk.
- **VIP SALE (Use the selective entry)**
DISABLE: Disables VIP sale.
ENABLE: Enables VIP sale.
- **GLU SYSTEM (Use the selective entry)**
GLU (PBLU): Makes GLU (PBLU) system compulsory.
DRIVE THRU: Makes drive-through compulsory.
NON-COMPULSORY: Makes GLU (PBLU)/drive-through system non-compulsory.
- **G.C. COPY (Use the selective entry)**
DISABLE: Disables guest check copy.
ENABLE: Enables guest check copy.
- **VAT SHIFT (Use the selective entry)**
STATE: Enables VAT shift entry.
NOT: Disables VAT shift entry.
- **PRICE LEVEL (Use the selective entry)**
Selected price level
(PRICE1 through PRICE7)
- **DRAWER No. (Use the selective entry)**
DRAWER2/DRAWER1/NONE
- **START CODE (GLU) (Use the numeric entry)**
Starting GLU/PBLU code (1 to 99999999)
- **END CODE (GLU) (Use the numeric entry)**
Ending GLU/PBLU code (1 to 99999999)

■ Clerk (continued)

- **DEPT SHIFT 1 through 4 (Use the selective entry)**

YES: Enables department shift entry.

NO: Disables department shift entry.

- **PGM2 MODE (Use the selective entry)**

DISABLE: Disables operation in the PGM2 mode.

ENABLE: Enables operation in the PGM2 mode.

- **PGM1 MODE (Use the selective entry)**

DISABLE: Disables operation in the PGM1 mode.

ENABLE: Enables operation in the PGM1 mode.

- **PRICE MODE (Use the selective entry)**

DISABLE: Disables operation in the PRICE mode.

ENABLE: Enables operation in the PRICE mode.

- **X1/Z1 MODE (Use the selective entry)**

DISABLE: Disables operation in the X1/Z1 mode.

ENABLE: Enables operation in the X1/Z1 mode.

- **X2/Z2 MODE (Use the selective entry)**

DISABLE: Disables operation in the X2/Z2 mode.

ENABLE: Enables operation in the X2/Z2 mode.

- **AUTO KEY PROG. (Use the selective entry)**

DISABLE: Disables auto key programming operation.

ENABLE: Enables auto key programming operation.

- **Z1 IN OPX/Z (Use the selective entry)**

DISABLE: Disables resetting operation in OPX/Z mode.

ENABLE: Enables resetting operation in OPX/Z mode.

■ Manager

You can program a secret code for each manager.

Procedure



A screenshot of a terminal window titled 'CLERR0001'. The main display area shows 'MANAGER' at the top, followed by 'NOTHING' and a dashed line separator. At the bottom left, there are two options: 'CANCEL' and 'ENTER'.

Pertinent
manager code → ENTER



A screenshot of a terminal window titled 'CLERR0001'. The main display area shows '01' at the top left, followed by 'SECRET CODE' and a dashed line separator. To the right of 'SECRET CODE' is a field containing '0000'. At the bottom left, there are two options: 'CANCEL' and 'ENTER'.

Program the item as follows:

- **MANAGER (Use the numeric entry)**
Manager code (max. 2 digits: 01 to 99)
- **SECRET CODE (Use the numeric entry)**
Secret code (max. 4 digits: 0000 to 9999)

■ Employee

You can program various items for each employee.

Procedure

Pertinent
employee code →

Program each item as follows:

- **EMPLOYEE (Use the numeric entry)**
Employee code (max. 10 digits: 0000000001 to 9999999999)
- **SECRET CODE (Use the numeric entry)**
Secret code (max. 4 digits: 0001 to 9999)
- **NAME (Use the character entry)**
Name for the employee.
Up to 12 characters can be entered.
- ***1 CLERK CODE (Use the numeric entry)**
Clerk code (max. 4 digits: 0001 to 9999)
- **MANAGER CODE (Use the numeric entry)**
Manager code (max. 2 digits: 01 to 99)
The manager who is responsible or capable for adjustments to the employee's hours.
- **DAILY WORK TIME (Use the numeric entry)**
Standard number of hours for which the employee should work a day (max. 3 digits: 0 to 99.9)
- ***2 LOCATION#1 through #4 (Use the numeric entry)**
Job location table number (max. 2 digits: 01 to 99)

NOTE

- *1 *The clerk whom an employee code has been assigned cannot time in unless the corresponding employee times in.*
- *2 *If no job location table number is programmed for an employee time-in operation, the location no. 1 will be assigned. Therefore, make sure to program a job location table number for "LOCATION#1."*

■ Job location table

You can program three functions for each job location table number which is assigned to employees.

Procedure



Pertinent
job location
table no.

→ ENTER

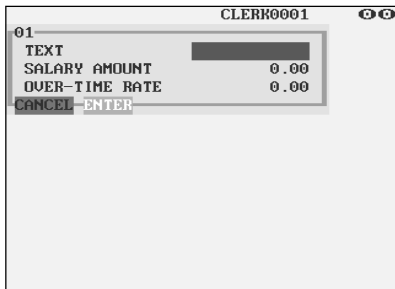

Program each item as follows:

- **JOB LOCATE TBL (Use the numeric entry)**
Job location table number (1 to 99)
- **TEXT (Use the character entry)**
Description for the job location table. Up to 12 characters can be entered.
- **SALARY AMOUNT (Use the numeric entry)**
Salary amount paid for the employee (max. 5 digits: 0 to 999.99)
- *** OVER-TIME RATE (Use the numeric entry)**
Rate for overtime work (max. 4 digits: 0.01 to 99.99)

NOTE

* *Overtime pay = SALARY AMOUNT x OVER-TIME RATE*

Terminal Programming

Use the following procedure to select any option included in the terminal group:

Procedure

```
CLERR0001
SETTING
1 ARTICLE
2 DIRECT KEY
3 FUNCTION
4 MEDIA
5 CURRENCY
6 TEXT
7 PERSONNEL
8 TERMINAL
9 DATE/TIME
10 OPTIONAL
11 REPORT
CANCEL ENTER [v ]
```



```
CLERR0001
TERMINAL
MACHINE# 123456
CONSECUTIVE# 1178
BILL NUMBER 0000
DRAWER ALARM 000
SCREEN SAVE 00
CANCEL ENTER
```

1. In the SETTING window, select “8 TERMINAL.”

- The TERMINAL window will appear.

2. Select any option from the following options list:

- **MACHINE# (Use the numeric entry)**
Machine number (max. 6 digits: 0 to 999999)
- **CONSECUTIVE# (Use the numeric entry)**
Enter a number (max. 4 digits: 0 to 9999) that is one less than the desired starting number.
- **BILL NUMBER (Use the numeric entry)**
Enter a number (max. 4 digits: 0 to 9999) that is the desired starting number.
- **DRAWER ALARM (Use the numeric entry)**
Alarm length of time with drawer opening (0 to 255 seconds)
 - Your POS terminal starts to monitor how long the drawer is kept open the moment the drawer is opened at the end of a transaction in the REG/VOID mode. It stops the time monitoring when a valid key (except the **VP**, **SLIP**, and **RCPT** keys) is touched for the next transaction. It restarts the time monitoring after that transaction is ended. You can stop the buzzer alarm by closing the drawer. No key entries can be made while the buzzer is sounding. If the number “0” is entered, this function will be unavailable.
- **SCREEN SAVE (Use the numeric entry)**
Screen save mode timer (max. 2 digits: 0 to 99 minutes)
If the number “0” is entered, the POS terminal will turn the display off after 100 min., if it remains idle.

Date/Time Setting

Use the following procedure to select the menu option "9 DATE/TIME":

■ Date/time

You can set the date and time for the POS terminal.

Procedure

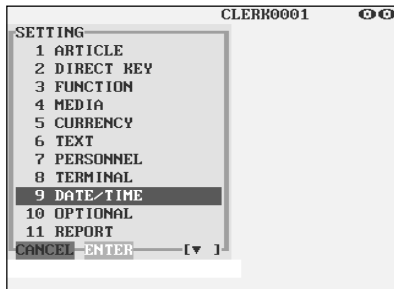

CLERK0001

SETTING

- 1 ARTICLE
- 2 DIRECT KEY
- 3 FUNCTION
- 4 MEDIA
- 5 CURRENCY
- 6 TEXT
- 7 PERSONNEL
- 8 TERMINAL
- 9 DATE/TIME**
- 10 OPTIONAL
- 11 REPORT

CANCEL ENTER []

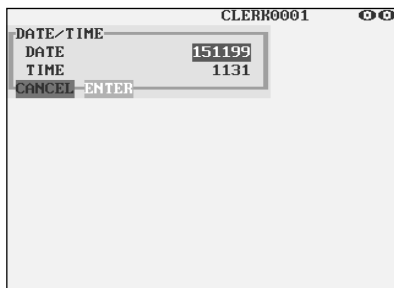

CLERK0001

DATE/TIME

DATE 151199

TIME 1131

CANCEL ENTER

Set each item as follows:

- **DATE (Use the numeric entry)**

Enter the day (2 digits), month (2 digits), and year (2 digits) in this sequence.

- **TIME (Use the numeric entry)**

Set the time (max. 4 digits) on the 24-hour system. For example, when the time is set to 2:30 AM, enter 0230; and when it is set to 2:30 PM, enter 1430. The time will be printed and displayed. Once you set the time, the internal clock unit will continue to run as long as the built-in battery pack is charged and also update the date (day, month, year) properly.

Optional Feature Selection

Use the following procedure to select any option included in the optional group:

Procedure

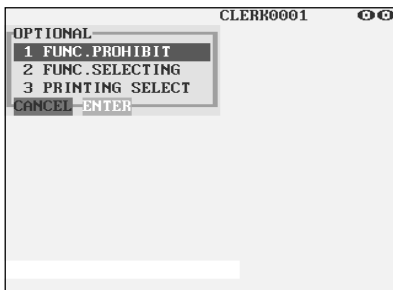
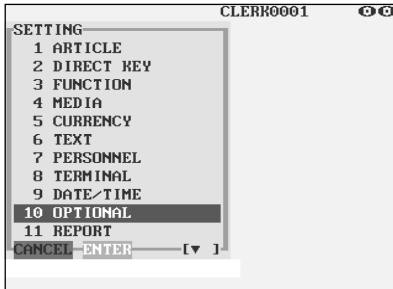

1. In the SETTING window, select “10 OPTIONAL.”

- The OPTIONAL window will appear.

2. Select any option from the following options list:

- | | |
|----------------------|----------------------|
| 1 FUNC. PROHIBIT . : | Function prohibition |
| 2 FUNC. SELECTING : | Function selection |
| 3 PRINTING SELECT : | Printing selection |

The following illustration shows those options included in the optional feature programming group.

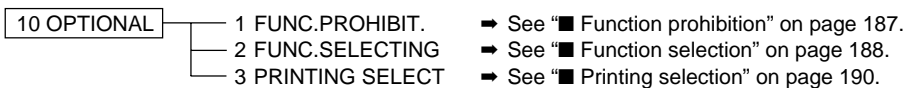

■ Function prohibition

Your POS terminal allows you to select whether to enable or disable various functions.

Procedure

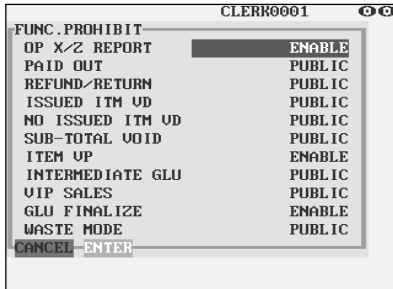

Program each item as follows:

- **OP X/Z REPORT (Use the selective entry)**
 - DISABLE: Disables clerk report printing in the OP X/Z mode.
 - ENABLE: Enables clerk report printing in the OP X/Z mode.
- **PAID OUT (Use the selective entry)**
 - LIMITED: Allowed only for managers or supervisor.
 - PUBLIC: Allowed for all clerks.
- **REFUND/RETURN (Use the selective entry)**
 - LIMITED: Allowed only for managers or supervisor.
 - PUBLIC: Allowed for all clerks.
- **ISSUED ITM VD (Use the selective entry)**
 - LIMITED: Allowed only for managers or supervisor.
 - PUBLIC: Allowed for all clerks.
- **NO ISSUED ITM VD (Use the selective entry)**
 - LIMITED: Allowed only for managers or supervisor.
 - PUBLIC: Allowed for all clerks.
- **SUB-TOTAL VOID (Use the selective entry)**
 - LIMITED: Allowed only for managers or supervisor.
 - PUBLIC: Allowed for all clerks.
- **ITEM VP (Use the selective entry)**
 - DISABLE: Disables item validation printing.
 - ENABLE: Enables item validation printing.
- **INTERMEDIATE GLU (Use the selective entry)**
 - LIMITED: Allowed only for managers or supervisor.
 - PUBLIC: Allowed for all clerks.
- **VIP SALES (Use the selective entry)**
 - LIMITED: Allowed only for managers or supervisor.
 - PUBLIC: Allowed for all clerks.
- **GLU FINALIZE (Use the selective entry)**
 - DISABLE: Disables GLU finalization after ordering.
 - ENABLE: Enables GLU finalization after ordering.
- **WASTE MODE (Use the selective entry)**
 - LIMITED: Allowed only for managers or supervisor.
 - PUBLIC: Allowed for all clerks.

■ Function selection

Your POS terminal enables you to select various functional selections.

Procedure

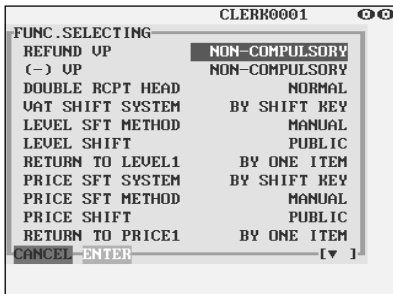

The screen continues.

Program each item as follows:

- **REFUND VP (Use the selective entry)**

COMPULSORY: Compulsory refund validation printing

NON-COMPULSORY: Non-compulsory refund validation printing

- **(-) VP (Use the selective entry)**

COMPULSORY: Compulsory minus validation printing

NON-COMPULSORY: Non-compulsory minus validation printing

- **DOUBLE RCPT HEAD (Use the selective entry)**

1 LINE: Prints a one-line header on a double receipt.

NORMAL: Prints a normal header on a double receipt.

- **VAT SHIFT SYSTEM (Use the selective entry)**

BY SHIFT KEY: Allows VAT shift to be accomplished by the shift key.

BY CLERK: Allows VAT shift to be accomplished by a clerk.

- **LEVEL SFT METHOD (Use the selective entry)**

MANUAL: Lock shift mode

AUTO: Automatic return mode

- **LEVEL SHIFT (Use the selective entry)**

LIMITED: Allowed only for managers or supervisor.

PUBLIC: Allowed for all clerks.

- **RETURN TO LEVEL1 (Use the selective entry)**

When the PLU level shift system is set to "AUTO," the PLU level can be returned to level 1 by one of the following methods:

BY ONE RECEIPT: Returns the PLU level to level 1 by one receipt.

BY ONE ITEM: Returns the PLU level to level 1 by one item.

- **PRICE SFT SYSTEM (Use the selective entry)**

BY CLERK: Allows PLU price level shift to be accomplished by a clerk.

BY SHIFT KEY: Allows PLU price level shift to be accomplished by the shift key.

- **PRICE SFT METHOD (Use the selective entry)**

MANUAL: Lock shift mode

AUTO: Automatic return mode

- **PRICE SHIFT (Use the selective entry)**

LIMITED: Allowed only for managers or supervisor.

PUBLIC: Allowed for all clerks.

■ Function selection (continued)

- **RETURN TO PRICE1 (Use the selective entry)**

When the PLU price level shift method is set to "AUTO," the price level can be returned to price 1 by one of the following methods:

BY ONE RECEIPT: Returns the price level to price 1 by one receipt.

BY ONE ITEM: Returns the price level to price 1 by one item.

- **QTY IN VIP SALES (Use the selective entry)**

UPDATE: Updates the sales quantity of VIP sale.

NOT UPDATE: Does not update the sales quantity of VIP sale.

- **NON-TURNOVER (Use the selective entry)**

INCLUDE VAT: Enables non-turnover including VAT.

EXCLUDE VAT: Disables non-turnover including VAT.

- **CREDIT IN RA/PO (Use the selective entry)**

TOTALIZER UPDATE: Updates a credit totalizer when finalizing a received-on-account or a paid-out entry by a credit key.

NOT UPDATE: Does not update a credit totalizer when finalizing a received-on-account or a paid-out entry by a credit key.

- **SHIFT KEY ACTION (Use the selective entry)**

CAPS LOCK: Locks the upper-case letter mode once the shift key is touched.

SHIFT: Shifts the upper-case letter mode to the lower-case letter mode after a letter is entered.

- **DRIVE SCREEN (Use the selective entry)**

MANUAL: Only when the function key for the drive-through screen is touched, the drive-through screen appears.

AUTO: When the drive-through registration is made, the drive-through screen becomes the default screen automatically. If the function key for the drive-through screen is touched, also the drive-through screen appears.

- **WHEN T-LOG FULL (Use the selective entry)**

Programming whether or not to lock item entry when the T-LOG file is full.

CONTINUE:

LOCK:

- **WHEN E.J. FULL (Use the selective entry)**

Programming whether or not to lock item entry when the Electronic Journal file is full.

CONTINUE:

LOCK:

- **PAYMENT FOR EX1 (Use the selective entry)**

Payment for exchange1 amount

CASH ONLY:

ALL MEDIA:

- **EX1 CALCULATION (Use the selective entry)**

Exchange1 calculation method

DIVISION:

MULTIPLICATION:

■ Printing selection

You can program various printing functions.

Procedure

Option	Action
# OF PURCHASE	NOT PRINT
TIME	PRINT
JOURNAL SELECT	FULL PRINT
JOURNAL LETTER	SMALL SIZE
VAT/TAX ON R/J	PRINT
TAXABLE ON R/J	PRINT
NET ON R/J	PRINT
VAT/TAX ON BILL	PRINT
TAXABLE ON BILL	PRINT
NET ON BILL	PRINT
TIME ON BILL	PRINT

CANCEL ENTER [▼]

The screen continues.

Program each item as follows:

- **# OF PURCHASE (Use the selective entry)**
 - PRINT: Prints the number of purchases.
 - NOT PRINT: Does not print the number of purchases.
- **TIME (Use the selective entry)**
 - NOT PRINT: Does not print the time on the receipt and journal.
 - PRINT: Prints the time on the receipt and journal.
- **JOURNAL SELECT (Use the selective entry)**
 - PARTIAL PRINT: Prints the information on all entries other than normal department entries (entries into “+” departments and their associated “+” PLUs) on the journal.
 - FULL PRINT: Prints the detailed information on the journal.
- **JOURNAL LETTER (Use the selective entry)**
 - NORMAL SIZE: Prints the normal-size letters on the journal.
 - SMALL SIZE: Prints the compressed-size letters on the journal.
- **VAT/TAX ON R/J (Use the selective entry)**
 - NOT PRINT: Does not print VAT or tax amounts on the receipt and journal.
 - PRINT: Prints VAT or tax amounts on the receipt and journal.
- **TAXABLE ON R/J (Use the selective entry)**
 - NOT PRINT: Does not print taxable amounts on the receipt and journal.
 - PRINT: Prints taxable amounts on the receipt and journal.
- **NET ON R/J (Use the selective entry)**
 - NOT PRINT: Does not print net amounts on the receipt and journal.
 - PRINT: Prints net amounts on the receipt and journal.
- **VAT/TAX ON BILL (Use the selective entry)**
 - NOT PRINT: Does not print VAT or tax amounts on the bill.
 - PRINT: Prints VAT or tax amounts on the bill.
- **TAXABLE ON BILL (Use the selective entry)**
 - NOT PRINT: Does not print taxable amounts on the bill.
 - PRINT: Prints taxable amounts on the bill.

■ Printing selection (continued)

- **NET ON BILL (Use the selective entry)**

NOT PRINT: Does not print net amounts on the bill.

PRINT: Prints net amounts on the bill.

- **TIME ON BILL (Use the selective entry)**

NOT PRINT: Does not print the time on the bill.

PRINT: Prints the time on the bill.

- **BILL ON SLIP (Use the selective entry)**

NOT PRINT: Does not print the bill on the slip.

PRINT: Prints the bill on the slip.

- **BILL ON RECEIPT (Use the selective entry)**

NOT PRINT: Does not print the bill on the receipt.

PRINT: Prints the bill on the receipt.

- **INTERMED ON SLIP (Use the selective entry)**

NOT PRINT: Does not print the details of intermediate GLU reading on the slip.

PRINT: Prints the details of intermediate GLU reading on the slip.

- **INTERMED ON RCPT (Use the selective entry)**

NOT PRINT: Does not print the details of intermediate GLU reading on the receipt.

PRINT: Prints the details of intermediate GLU reading on the receipt.

- **SEPARATOR LINE (Use the selective entry)**

SEPARATOR LINE: Prints separator lines in the report.

1 LINE: Creates one-line space instead of printing separator lines in the report.

- **LINK PLU TEXT (Use the selective entry)**

ONLY PARENT: Prints parent PLU text of linked PLUs with totalizer.

PRINT EACH PLU: Prints each PLU text of linked PLUs.

- **FREE TEXT ON KP (Use the selective entry)**

Free text print on KP

PRINT:

NOT PRINT:

- **ITEM CODE ON KP (Use the selective entry)**

Item code print on KP

PRINT:

NOT PRINT:

- **UNIT PRICE ON KP (Use the selective entry)**

Unit price print on KP

PRINT:

NOT PRINT:

- **AMOUNT ON KP (Use the selective entry)**

Amount print on KP

PRINT:

NOT PRINT:

■ Printing selection (continued)

- **GUEST# ON KP (Use the selective entry)**

Guest# print on KP on

PRINT:

NOT PRINT:

- **QTY1 PRINT ON KP (Use the selective entry)**

Qty1 print on KP

PRINT:

NOT PRINT:

- **TOTAL & CHANGE PRT (Use the selective entry)**

Exchange1 amount print for total and change

DOMESTIC ONLY:

WITH FOREIGN:

- **PAYMENT VP (Use the selective entry)**

Exchange1 amount print for payment VP

DOMESTIC ONLY:

WITH FOREIGN:

- **MAXIMUM TICKET (Use the numeric entry)**

Maximum number of ticket issuing (1 to 99)

Report Programming

Use the following procedure to select any option included in the report group:

Procedure

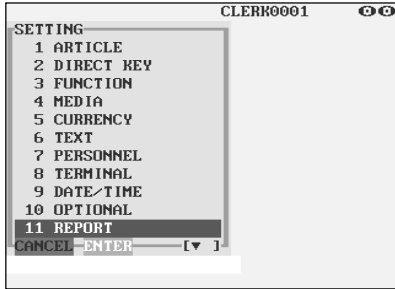

1. In the SETTING window, select "11 REPORT."
 - The REPORT window will appear.

2. Select any option from the following options list:

- | | |
|-------------------|-----------------------|
| 1 0 SKIP: | Zero skip |
| 2 GNR RPT FORMAT: | General report format |
| 3 HOURLY RPT: | Hourly report |
| 4 STACKED RPT: | Stacked report |

The following illustration shows those options included in the report programming group.

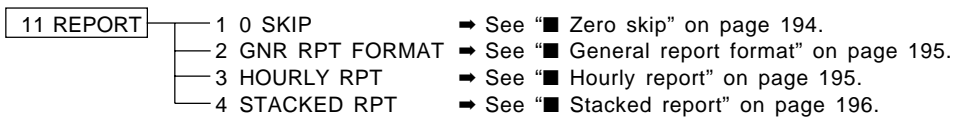

■ Zero skip

You can program whether or not to skip "0" in each report.

Procedure

The screenshot shows a terminal window titled 'CLERR0001'. It displays a menu with the following items and their corresponding skip settings:

SKIP	
CLERK	SKIP
TRANSACTION	SKIP
DEPARTMENT	SKIP
PLU	SKIP
HOURLY	SKIP
DAILY NET	SKIP

At the bottom of the menu, there are two options: 'CANCEL' and 'ENTER'.

Program each item as follows:

- **CLERK (Use the selective entry)**
 - SKIP: Skips those data that are "0" in the clerk report.
 - NOT SKIP: Does not skip those data that are "0" in the clerk report.
- **TRANSACTION (Use the selective entry)**
 - SKIP: Skips those data that are "0" in the transaction report.
 - NOT SKIP: Does not skip those data that are "0" in the transaction report.
- **DEPARTMENT (Use the selective entry)**
 - SKIP: Skips those data that are "0" in the department report.
 - NOT SKIP: Does not skip those data that are "0" in the department report.
- **PLU (Use the selective entry)**
 - SKIP: Skips those data that are "0" in the PLU report.
 - NOT SKIP: Does not skip those data that are "0" in the PLU report.
- **HOURLY (Use the selective entry)**
 - SKIP: Skips those data that are "0" in the hourly report.
 - NOT SKIP: Does not skip those data that are "0" in the hourly report.
- **DAILY NET (Use the selective entry)**
 - SKIP: Skips those data that are "0" in the daily net report.
 - NOT SKIP: Does not skip those data that are "0" in the daily net report.

■ General report format

You can program whether or not to skip the following items in the general report.

Procedure

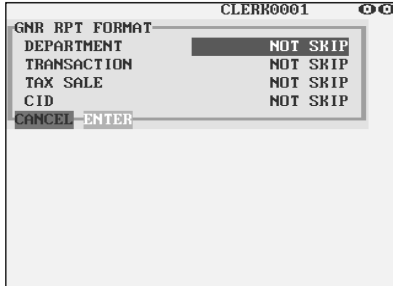

The screenshot shows a terminal window titled "CLERK0001" with the following text:

```
GNR RPT FORMAT
DEPARTMENT      NOT SKIP
TRANSACTION     NOT SKIP
TAX SALE        NOT SKIP
CID             NOT SKIP
CANCEL-ENTER
```

Program each item as follows:

- **DEPARTMENT (Use the selective entry)**
 - SKIP: Skips department data in the general report.
 - NOT SKIP: Does not skip department data in the general report.
- **TRANSACTION (Use the selective entry)**
 - SKIP: Skips transaction data in the general report.
 - NOT SKIP: Does not skip transaction data in the general report.
- **TAX SALE (Use the selective entry)**
 - SKIP: Skips tax data in the general report.
 - NOT SKIP: Does not skip tax data in the general report.
- **CID (Use the selective entry)**
 - SKIP: Skips cash-in-drawer data in the general report.
 - NOT SKIP: Does not skip cash-in-drawer data in the general report.

■ Hourly report

You can program the memory type and the starting time for the hourly report.

Procedure

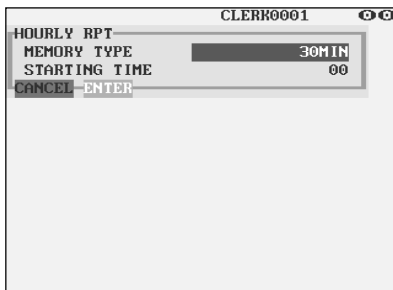

The screenshot shows a terminal window titled "CLERK0001" with the following text:

```
HOURLY RPT
MEMORY TYPE     30MIN
STARTING TIME   00
CANCEL-ENTER
```

Program each item as follows:

- **MEMORY TYPE (Use the selective entry)**
 - 15MIN: Selects the 15-minute type.
 - 30MIN: Selects the 30-minute type.
 - 60MIN: Selects the 60-minute type.
- **STARTING TIME (Use the numeric entry)**
 - Starting time entry (max. 2 digits: 0 to 23)

■ Stacked report

Your POS terminal is equipped with the stacked report printing function that enables multiple X/Z reports to be printed in sequence with a single request.

Procedure

Select a stacked report no. from the stacked reports list.



The screen continues.

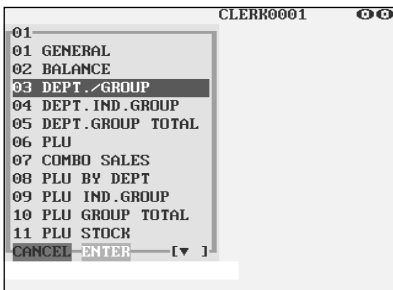

The screen continues.

When you are allowed to set the parameter of a report, the following pop-up window will appear.

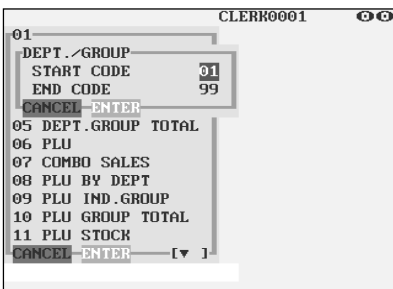

You can select a maximum of twenty reports from the stacked reports list. Some reports can be set their parameters such as "START CODE" and "END CODE."

- **01 GENERAL**
General report
- **02 BALANCE**
Balance report
- **03 DEPT./GROUP (Use the numeric entry)**
Full department report
Parameter: Starting department code/ending department code (1 through 99)
- **04 DEPT.IND.GROUP (Use the numeric entry)**
Individual group report on departments
Parameter: Department group no. (1 through 17)
- **05 DEPT.GROUP TOTAL**
Full group total report on departments
- **06 PLU (Use the numeric entry)**
PLU report by designated range
Parameter: Starting PLU code/ending PLU code (1 through 999999)
- **07 COMBO SALES (Use the numeric entry)**
Combo sales report
Parameter: Starting PLU code/ending PLU code (1 through 999999)
- **08 PLU BY DEPT (Use the numeric entry)**
PLU report by associated department
Parameter: Department code (1 through 99)
- **09 PLU IND. GROUP (Use the numeric entry)**
PLU report by individual group
Parameter: PLU group no. (00 through 99)
- **10 PLU GROUP TOTAL**
Full group total report on PLUs
- **11 PLU STOCK (Use the numeric entry)**
PLU stock report
Parameter: Starting PLU code/ending PLU code (1 through 999999)
- **12 PLU COST (Use the numeric entry)**
PLU cost report
Parameter: Starting PLU code/ending PLU code (1 through 999999)

■ Stacked report (continued)

- **13 PLU TOP 20 (Use the selective entry)**
PLU top 20 report
Parameter: AMOUNT/QUANTITY
- **14 PLU ZERO SALES (Use the selective/numeric entry)**
PLU zero sales report
Parameter: 1 ALL/2 BY DEPT.
When "2 BY DEPT." is selected, enter a department code (1 through 99).
- **15 PLU MIN. STOCK (Use the numeric entry)**
PLU minimum stock report
Parameter: Starting PLU code/ending PLU code (1 through 999999)
- **16 PLU HOURLY GROUP (Use the numeric entry)**
PLU hourly group report
Parameter: Starting time/ending time (0 through 2345)
- **17 TRANSACTION**
Transaction report
- **18 TL-ID**
Total in drawer report
- **19 COMMISSION SALES**
Commission sales report
- **20 TAX**
Tax report
- **21 CHIEF**
Chief report
- **22 ALL CLERK**
Full clerk report
- **23 IND. CLERK**
Individual clerk report
- **24 DD ERROR**
Drink dispenser error reading report
- **25 DD RESET**
Drink dispenser resetting report
- **26 EMPLOYEE (Use the numeric entry)**
Employee report
Parameter: Starting employee code/ending employee code (1 through 9999999999)
- **27 EMP. ADJUSTMENT (Use the numeric entry)**
Employee adjustment report
Parameter: Starting employee code/ending employee code (1 through 9999999999)

■ Stacked report (continued)

- **28 EMP. ACTIVE STS. (Use the numeric entry)**

Employee active status report

Parameter: Starting employee code/ending employee code (1 through 999999999)

- **29 HOURLY (Use the numeric entry)**

Hourly report

Parameter: Starting time/ending time (0 through 2345)

NOTE

To take the hourly Z report, you have to specify the full-range hourly report.

- **30 LABOR COST%**

Labor cost percent report

- **31 OVER TIME (Use the numeric entry)**

Over time report

Parameter: Starting employee code/ending employee code (max. 10 digits: 000000001 to 999999999)

- **32 DAILY NET**

Daily net report

- **33 INGREDIENT STOCK (Use the numeric entry)**

Ingredient stock report

Parameter: Starting ingredient no./ending ingredient no. (1 through 999)

- **34 GLU (Use the numeric entry)**

GLU/PBLU report

Parameter: Starting GLU code/ending GLU code (1 through 99999999)

- **35 GLU BY CLERK**

GLU/PBLU report by clerk

- **36 DRIVE THRU (Use the numeric entry)**

Drive-through report

Parameter: Starting drive-through code/ending drive-through code (1 through 99999999)

- **37 D-THRU BY CLERK**

Drive-through report by clerk

- **38 BILL**

Bill report

- **39 SERVICE TIME (Use the numeric entry)**

Drive-through service time

Parameter: Starting time/ending time (0 through 2300)

Message Programming

Use the following procedure to select any option included in the message group:

Procedure

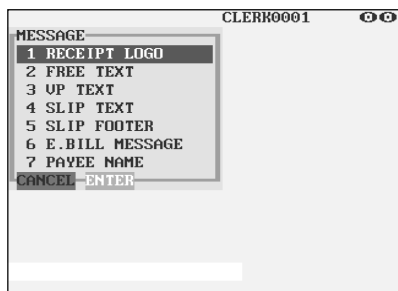
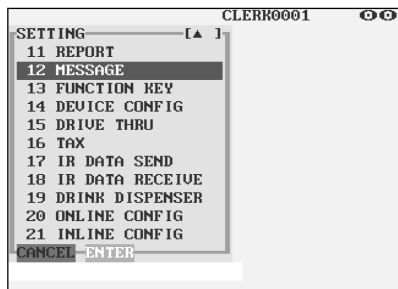

1. In the SETTING window, select "12 MESSAGE."

- The MESSAGE window will appear.

2. Select any option from the following options list:

- | | |
|-------------------|--------------------------------|
| 1 RECEIPT LOGO: | Receipt logo |
| 2 FREE TEXT: | Free text |
| 3 VP TEXT: | Validation printing text |
| 4 SLIP TEXT: | Slip text |
| 5 SLIP FOOTER: | Slip footer |
| 6 E.BILL MESSAGE: | Entertainment bill message |
| 7 PAYEE NAME: | Payee name (for English check) |

The following illustration shows those options included in the text programming group.

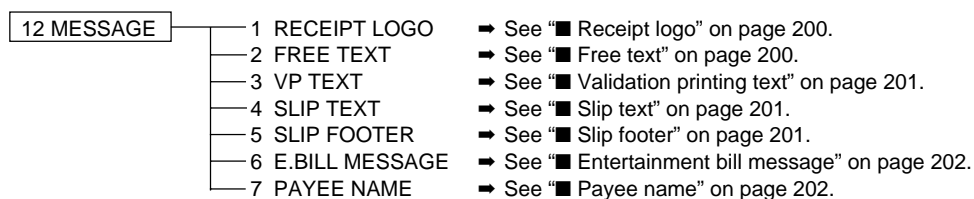

■ Receipt logo

Your POS terminal can print programmed messages for customers on every receipt.

Procedure



Program the item as follows:

- **RECEIPT LOGO (Use the character entry)**

Logo text for the receipt (max. 40 characters x 6 lines)
Entering sequential characters "=" will print the corresponding clerk name in the footer logo message. Enter four to eight characters "=".

NOTE

The programmable number of lines for a message varies according to the following message types:

- 3-line header message type
- Graphical logo only type
- Graphical logo and 3-line footer message type
- 6-line header message type
- 3-line header and 3-line footer messages type
- 3-line header message, graphical logo, and 3-line footer message type
- Graphical logo and 3-line header and 3-line footer messages type

Please contact your authorized SHARP dealer.

■ Free text

Your POS terminal can print programmed texts for departments and PLUs on every receipt.

Procedure

Select a pertinent text number from the free texts list.

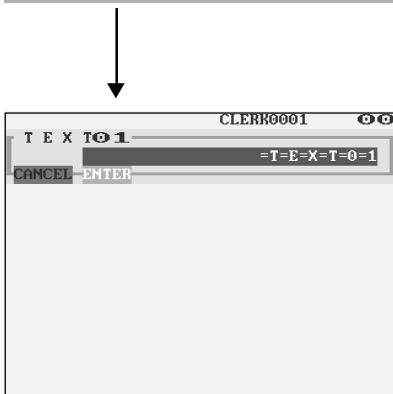

Program the item as follows:

- **FREE TEXT (Use the character entry)**

Free texts for departments and PLUs (max. 99 texts/30 characters per text)

■ Validation printing text

Your POS terminal can print programmed messages for customers on the validation slip.

Procedure

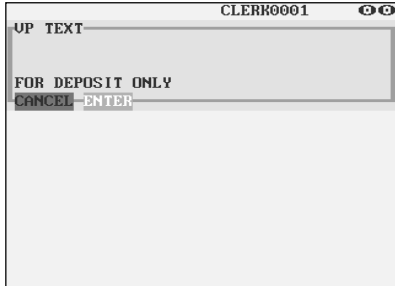

Program the item as follows:

- **VP TEXT (Use the character entry)**
Texts for the validation slip (3 lines/max. 30 characters per line)

■ Slip text

Your POS terminal can print programmed messages for customers on the slip.

Procedure

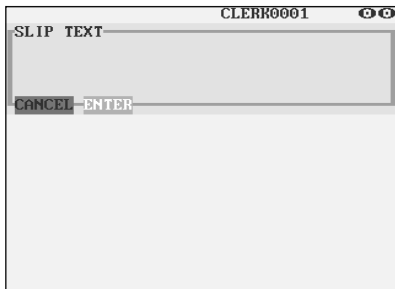

Program the item as follows:

- **SLIP TEXT (Use the character entry)**
Texts for the slip (3 lines/max. 30 characters per line)

■ Slip footer

Your POS terminal can print programmed footer messages for customers on the slip.

Procedure

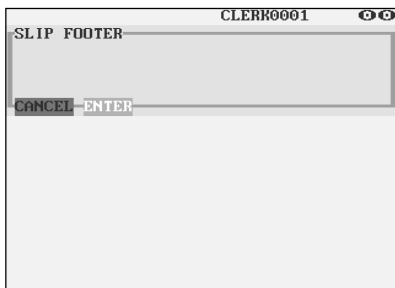

Program the item as follows:

- **SLIP FOOTER (Use the character entry)**
Texts for the footer (3 lines/max. 30 characters per line)

■ Entertainment bill message

Your POS terminal can print programmed entertainment bill messages on the receipt.

Procedure

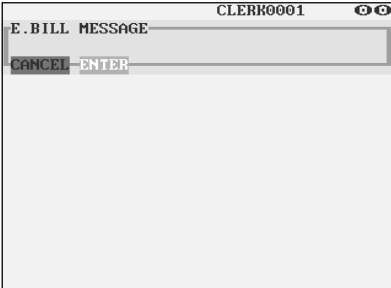

The screenshot shows a POS terminal screen with the title "E.BILL MESSAGE" and the user ID "CLERR0001" in the top right corner. Below the title is a large text entry field. At the bottom of the screen, there are two buttons labeled "CANCEL" and "ENTER".

Program the item as follows:

- **E.BILL MESSAGE (Use the character entry)**
Texts for the message (max. 30 characters)

■ Payee name

Your POS terminal can print programmed payee names for English checks.

Procedure

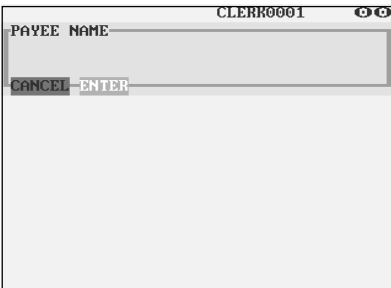

The screenshot shows a POS terminal screen with the title "PAYEE NAME" and the user ID "CLERR0001" in the top right corner. Below the title is a large text entry field. At the bottom of the screen, there are two buttons labeled "CANCEL" and "ENTER".

Program the item as follows:

- **PAYEE NAME (Use the character entry)**
Name for the payee for English check (2 lines/max. 30 characters per line)

Function Key Programming

Use the following procedure to program a text (key label) or a color for the function key:

Procedure

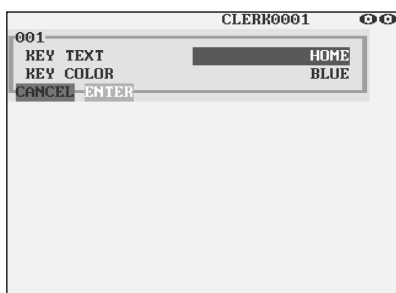
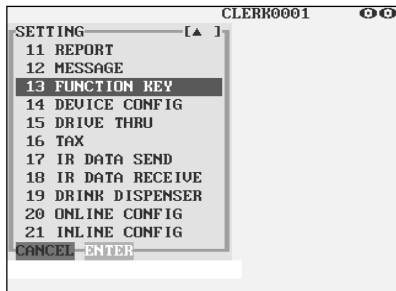

1. In the SETTING window, select "13 FUNCTION KEY."
 - The FUNCTION KEY window will appear.

2. Select any function key from the key list.

3. Program a text or a color for the corresponding function key.

- **KEY TEXT (Use the character entry)**

Enter a text for the function key.

The terminal is provided with various text-length in compliance with each key size. (max. 16 characters)

- **KEY COLOR (Use the selective entry)**

Select a key color from the colors list (16 different of colors).

BLACK/BLUE/LIGHT BLUE/MAGENTA/LIGHT MAGENTA/GREEN/LIGHT GREEN/RED/LIGHT RED/CYAN/LIGHT CYAN/GRAY/LIGHT GRAY/YELLOW/BROWN/WHITE

Device Configuration Programming

Use the following procedure to select a device configuration programming:

Procedure

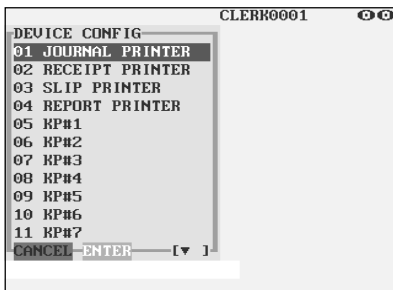

The screen continues.

1. In the SETTING window, select “14 DEVICE CONFIG.”
 - The DEVICE CONFIG window will appear.

2. Select any option from the following options list:

- | | |
|---------------------|-------------------|
| 01 JOURNAL PRINTER: | Journal printer |
| 02 RECEIPT PRINTER: | Receipt printer |
| 03 SLIP PRINTER: | Slip printer |
| 04 REPORT PRINTER: | Report printer |
| 05 KP#1: | Remote printer #1 |
| 06 KP#2: | Remote printer #2 |
| 07 KP#3: | Remote printer #3 |
| 08 KP#4: | Remote printer #4 |
| 09 KP#5: | Remote printer #5 |
| 10 KP#6: | Remote printer #6 |
| 11 KP#7: | Remote printer #7 |
| 12 KP#8: | Remote printer #8 |
| 13 KP#9: | Remote printer #9 |
| 14 SCALE: | Scale |
| 15 DRINK DISPENSER: | Drink dispenser |
| 16 ONLINE: | On-line |

The following illustration shows those options included in the device configuration programming group.

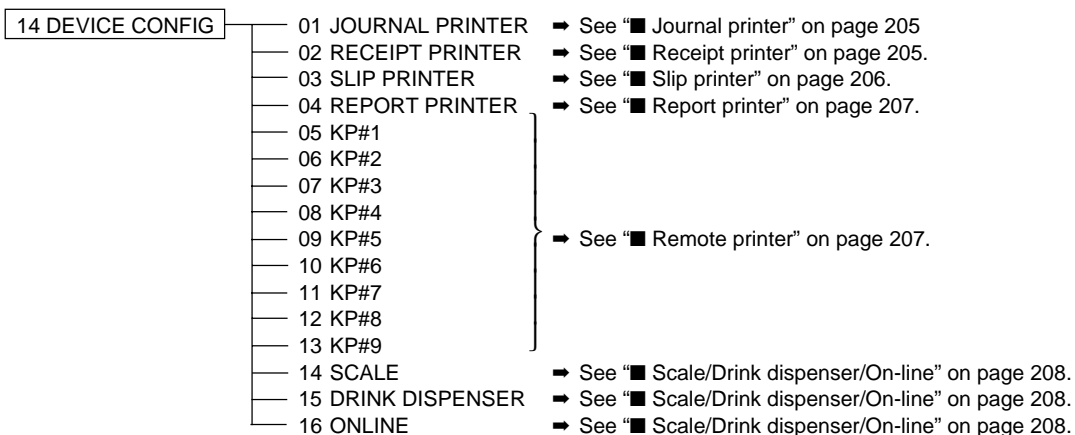

Journal printer

You can program various printing functions for journal printer.

Procedure

```
JOURNAL PRINTER
CLERK0001
TERMINAL# 000
CHANNEL# 0
PRINTER NAME SHARP ER-01PU
AUTO CUTTER NO
PAPER SHEET ONE SHEET
CANCEL ENTER
```

Program each item as follows:

- **TERMINAL# (Use the numeric entry)**
Terminal number (1 through 254 : Enter "0" for local device.)
- **CHANNEL# (Use the numeric entry)**
Channel number (1 through 7)
When you program as "0", no RS-232 channel is assigned.
- **PRINTER NAME (Use the selective entry)**
Select the printer to be used.
SHARP ER-01PU SHARP UP-T80BP
SHARP ER-03/04RP EPSON TM-300
EPSON TM-T88/85 EPSON TM-U950
EJ FILE (Electronic journal file)
- **AUTO CUTTER (Use the selective entry)**
Auto cutter function
YES: Enables auto cutter function.
NO: Disables auto cutter function.

NOTE When "ER-03RP" is connected, select "NO."
When "EJ FILE" is used, select "NO".

- **PAPER SHEET (Use the selective entry)**
Select a paper type.
TWO OR MORE: Uses two or more sheets.
ONE SHEET: Uses one sheet.

NOTE This option is available when the "TM-300" is selected.

Receipt printer

You can program various printing functions for each printer.

Procedure

```
RECEIPT PRINTER
CLERK0001
TERMINAL# 000
CHANNEL# 0
PRINTER NAME SHARP ER-01PU
AUTO CUTTER YES
PAPER SHEET ONE SHEET
HEAD LOGO PRINT PRE-PRINT
RCPT LENGTH 00
PRINT TYPE ADDITION
CANCEL ENTER
```

Program each item as follows:

- **TERMINAL# (Use the numeric entry)**
Terminal number (1 through 254 : Enter "0" for local device.)
- **CHANNEL# (Use the numeric entry)**
Channel number (1 through 7)
When you program as "0", no RS-232 channel is assigned.
- **PRINTER NAME (Use the selective entry)**
Select the printer to be used.
SHARP ER-01PU SHARP UP-T80BP
SHARP ER-03/04RP EPSON TM-300
EPSON TM-T88/85 EPSON TM-U950

■ Receipt printer (continued)

- **AUTO CUTTER (Use the selective entry)**

Auto cutter function

YES: Enables auto cutter function.

NO: Disables auto cutter function.

NOTE When "ER-03RP" is connected, select "NO."

- **PAPER SHEET (Use the selective entry)**

Select a paper type.

TWO OR MORE: Uses two or more sheets.

ONE SHEET: Uses one sheet.

NOTE This option is available when the "TM-300" is selected.

- **HEAD LOGO PRINT (Use the selective entry)**

Select a header logo print timing.

EACH ISSUE: The logo will be printed before printing transaction on each receipt.

PRE-PRINT: The logo will be printed beforehand printing transaction for a next receipt.

- **RCPT LENGTH (Use the numeric entry)**

Minimum length of the bill to be printed paper on the receipt paper

- **PRINT TYPE (Use the selective entry)**

Select the type of receipt print formats.

ADDITION SINGLE/DOUBLE

S/D + ADDITION ADDITION+SINGLE

ADD WITHOUT TL DOUBLE ADDITION

DOUBLE ADD+SNGL

■ Slip printer

Procedure

```
CLERK0001
SLIP PRINTER
TERMINAL#          000
CHANNEL#           0
PRINTER NAME      EPSON TM-295
INITIAL FEED#     00
SLIP MAX LINE     99
UP PRINT TIMES    1
CANCEL  ENTER
```

Program each item as follows:

- **TERMINAL# (Use the numeric entry)**

Terminal number (1 through 254 : Enter "0" for local device.)

- **CHANNEL# (Use the numeric entry)**

Channel number (1 through 7)

When you program as "0", no RS-232 channel is assigned.

- **PRINTER NAME (Use the selective entry)**

Select the printer to be used.

SHARP ER-FBP40

EPSON TM-295

EPSON TM-U950

EPSON TM-T85

■ Slip printer (continued)

- **INITIAL FEED# (Use the numeric entry)**
Initial line feed for a slip (0 to 64 lines)
- **SLIP MAX LINE (Use the numeric entry)**
Maximum number of lines printable on a slip (0 to 99)
- **VP PRINT TIMES (Use the numeric entry)**
Number of times of validation printing (0 to 9)

■ Report printer

Procedure

```

CLERK0001
REPORT PRINTER
TERMINAL#          000
CHANNEL#           0
PRINTER NAME      SHARP ER-01PU
AUTO CUTTER       YES
PAPER SHEET       ONE SHEET
CANCEL ENTER
  
```

Program each item as follows:

- **TERMINAL# (Use the numeric entry)**
Terminal number (1 through 254 : Enter "0" for local device.)
- **CHANNEL# (Use the numeric entry)**
Channel number (1 through 7)
When you program as "0", no RS-232 channel is assigned.
- **PRINTER NAME (Use the selective entry)**
Select the printer to be used.
SHARP ER-01PU SHARP UP-T80BP
SHARP ER-03/04RP EPSON TM-300
EPSON TM-T88/85 EPSON TM-U950
- **AUTO CUTTER (Use the selective entry)**
Auto cutter function
YES: Enables auto cutter function.
NO: Disables auto cutter function.

NOTE When "ER-03RP" is connected, select "NO."

- **PAPER SHEET (Use the selective entry)**
Select a paper type.
TWO OR MORE: Uses two or more sheets.
ONE SHEET: Uses one sheet.

NOTE This option is available when the "TM-300" is selected.

■ Remote printer (KP#1 through KP#9)

Procedure

```

CLERK0001
KP#1
TERMINAL#          000
CHANNEL#           0
PRINTER NAME      SHARP ER-03/04RP
AUTO CUTTER       NO
PAPER SHEET       ONE SHEET
PRINT TYPE        ADDITION
SECOND KP         0
NAME
CANCEL ENTER
  
```

Program each item as follows:

- **TERMINAL# (Use the numeric entry)**
Terminal number (1 through 254 : Enter "0" for local device.)
- **CHANNEL# (Use the numeric entry)**
Channel number (1 through 7)
When you program as "0", no RS-232 channel is assigned.
- **PRINTER NAME (Use the selective entry)**
Select the printer to be used.
SHARP ER-01PU SHARP UP-T80BP
SHARP ER-03/04RP EPSON TM-300
EPSON TM-T88/85 EPSON TM-U950

■ Remote printer (continued)

- **AUTO CUTTER (Use the selective entry)**

Auto cutter function

YES: Enables auto cutter function.

NO: Disables auto cutter function.

NOTE When "ER-03RP" is connected, select "NO."

- **PAPER SHEET (Use the selective entry)**

Select a paper type.

TWO OR MORE: Uses two or more sheets.

ONE SHEET: Uses one sheet.

NOTE This option is available when the "TM-300" is selected.

- **PRINT TYPE (Use the selective entry)**

Select the type of receipt print formats.

ADDITION SINGLE/DOUBLE

ADDITION+SINGLE DOUBLE ADDITION

DOUBLE ADD+SNGL

- **SECOND KP (Use the numeric entry)**

You can assign a second remote printer to which data should be output when the first remote printer encounters an error during transmission of the data.

Second remote printer number (0 to 9)

- **NAME (Use the character entry)**

Description for the remote printer (max. 12 characters)

■ Scale/Drink dispenser/On-line

Procedure

Select a pertinent device from the "DEVICE CONFIG" window.

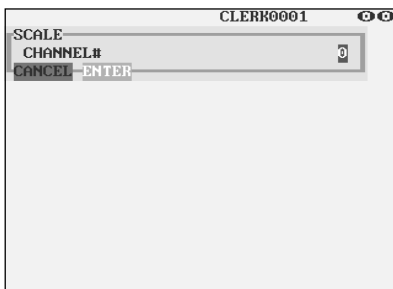

Program each item as follows:

- **CHANNEL# (Use the numeric entry)**

Channel number (1 through 7)

When you program as "0", no RS-232 channel is assigned.

Drive-through Code Programming

Use the following procedure to select the menu option “15 DRIVE THRU”:

■ Drive-through code

You can program the range of available drive-through codes.

Procedure

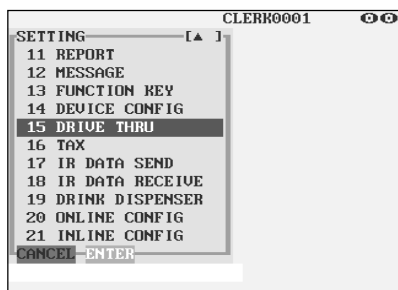

Program each item as follows:

- **START CODE (Use the numeric entry)**
Starting drive-through code (max. 8 digits: 1 to 99999999)
- **END CODE (Use the numeric entry)**
Ending drive-through code (max. 8 digits: 1 to 99999999)
- **TIME (Use the numeric entry)**
Drive-through target time:
Enter the minute (2 digits) and the second (2 digits) in this sequence.

NOTE

When the customer's waiting time is over the programmed target time, the terminal will display a warning.

Tax Programming

Use the following procedure to select any option included in the tax group:

Procedure

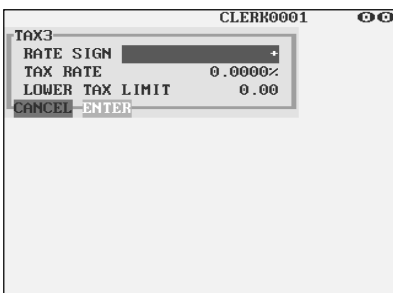
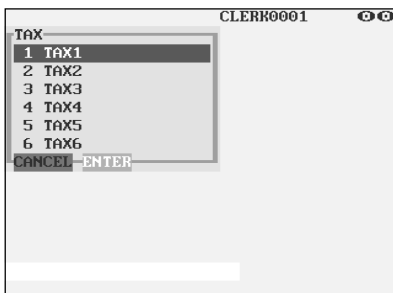
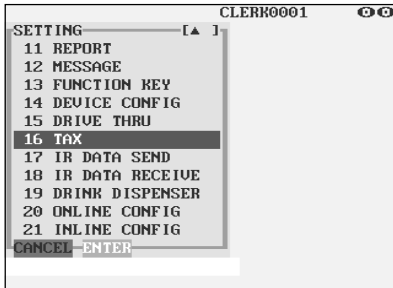

1. In the SETTING window, select "16 TAX."
 - The TAX window will appear.

2. Select any option from the following options list:

1 TAX1 :	Tax1
2 TAX2 :	Tax2
3 TAX3 :	Tax3
4 TAX4 :	Tax4
5 TAX5 :	Tax5
6 TAX6 :	Tax6

NOTE

If the **DELETE** key is touched on the tax number selection menu, the tax in the cursor position will be deleted.

3. Program each item as follows:

- **RATE SIGN (Use the selective entry)**
 - : Minus rate
 - +: Plus rate
- **TAX RATE (Use the numeric entry)**
 - Tax rate (max. 7 digits: 0.0000 to 999.9999%)
- **LOWER TAX LIMIT (Use the numeric entry)**
 - Lowest taxable amount (max. 5 digits: 0.01 to 999.99)
 - This option is not available in the VAT system.

IR Data Send Programming

Use the following procedure to select the menu option "17 IR DATA SEND":

■ IR data send

Your POS terminal can send data to another device by infrared rays.

Procedure

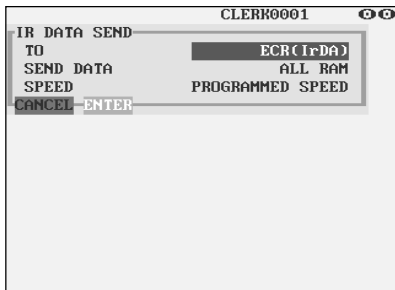
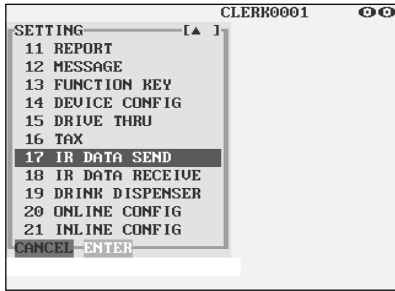

Program the item as follows:

• TO (Use the selective entry)

Select one of the following options to send data to another device:

- ECR (IrDA): Selects "IrDA" for the communication system to communicate with another POS terminal.
- ECR (ASK): Selects "ASK" for the communication system to communicate with another POS terminal.
- ER-02FD (ASK): Selects "ASK" for the communication system to communicate with the ER-02FD.

• SEND DATA (Use the selective entry)

Select one of the following options (data sources):

- ALL RAM STANDARD RAM(1)
- STANDARD RAM(2) UP-P02MB2(1)
- UP-P02MB2(2) UP-P02MB2(3)
- UP-P02MB2(4) SSP
- RESERVED 1 RESERVED 2
- RESERVED 3 RESERVED 4

• SPEED (Use the selective entry)

Select one of the following options (data transmission speeds):

- PROGRAMMED SPEED: Sends data at a programmed speed.
- 115200bps: Sends data at 115200 bps (for "IrDA" only).
- 57600bps: Sends data at 57600 bps.
- 38400bps: Sends data at 38400 bps.
- 19200bps: Sends data at 19200 bps.
- 9600bps: Sends data at 9600 bps.
- 4800bps: Sends data at 4800 bps.
- 2400bps: Sends data at 2400 bps.

IR Data Receive Programming

Use the following procedure to select the menu option "18 IR DATA RECEIVE":

■ IR data receive

Your POS terminal can receive data from another device by infrared rays.

Procedure

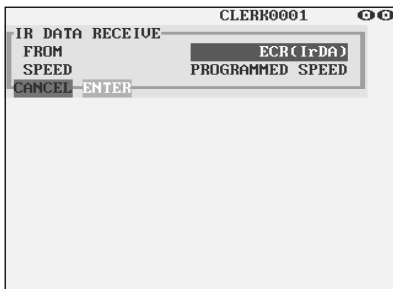
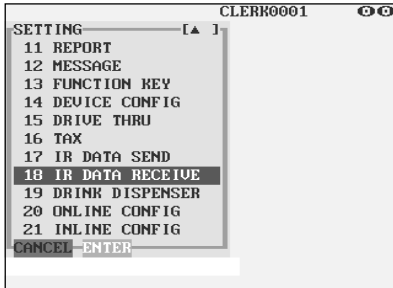

Program each item as follows:

• FROM (Use the selective entry)

Select one of the following options to receive data from another device:

ECR (IrDA): Selects "IrDA" for the communication system to communicate with another POS terminal.

ECR (ASK): Selects "ASK" for the communication system to communicate with another POS terminal.

ER-02FD (ASK): Selects "ASK" for the communication system to communicate with the ER-02FD.

• SPEED (Use the selective entry)

Select one of the following options (data transmission speeds):

PROGRAMMED SPEED: Receives data at a programmed speed.

115200bps: Receives data at 115200 bps.

57600bps: Receives data at 57600 bps.

38400bps: Receives data at 38400 bps.

19200bps: Receives data at 19200 bps.

9600bps: Receives data at 9600 bps.

4800bps: Receives data at 4800 bps.

2400bps: Receives data at 2400 bps.

Drink Dispenser Programming

Use the following procedure to select any option included in the drink dispenser programming group:

Procedure



1. In the SETTING window, select “19 DRINK DISPENSER.”

2. Select any option from the following options list:

- | | |
|-----------------|--------------------------|
| 1 DD PRESET: | Drink dispenser preset |
| 2 DD OPERATOR: | Drink dispenser operator |
| 3 DOWN LOADING: | Downloading |
| 4 LOCAL DD: | Local drink dispenser |

NOTE

“4 LOCAL DD” is available only when your POS terminal is used in an inline system.

The following illustration shows those options included in the drink dispenser programming group.



■ Drink dispenser preset

Procedure

```
CLERR0001
DD PRESET
VALUE NUMBER      000
SEPARATE CODE     000000
CONNECTION        OFF-LINE
PRINT FORMAT      PRINT
CANCEL-ENTER
```

Program each item as follows:

- **VALUE NUMBER (Use the numeric entry)**

- You can set the link of sort number of drink dispenser and PLU code.
AAA: Value in the hundred thousand's and ten thousand's and thousand's place of a PLU code (0 through 999)
- The conversion of a sort number to a PLU code is made as follows:
Sort number = xxx (max. 3 digits)
PLU code = AAxxx (max. 6 digits)

NOTE

You cannot change the setting by this option while the received data on drink dispenser sales is stored in the buffer. In this case, a lock error will occur and the message "ENTRY ERROR" will be displayed.

- **SEPARATE CODE (Use the numeric entry)**

Enter a GLU/PBLU or drive-through separate code (1 through 999999).

For example, if you program "10" for the separate code, GLU/drive-through codes "1" through "10" are used for drive-through codes, and "11" through "999999" are used for GLU codes.

- **CONNECTION (Use the selective entry)**

OFF-LINE: Makes drink dispenser off-line.

ON-LINE: Makes drink dispenser on-line.

If "OFF-LINE" is selected, data reception from the drink dispenser is disabled. If "ON-LINE" is selected, the manual entry of PLU assigned to the drink dispenser sales article results in error correction of drink dispenser misoperation.

- **PRINT FORMAT (Use the selective entry)**

NOT PRINT: Does not print a drink dispenser misoperation item when reading a drink dispenser misoperation file (in the clerk report).

PRINT: Prints a drink dispenser misoperation item when reading a drink dispenser misoperation file (in the clerk report).

■ Drink dispenser operator

Procedure

DD OPERATOR
CLERK0001
NOTHING
CANCEL ENTER

Pertinent clerk
code

→ ENTER

0001
GLU START CODE 00000
END CODE 00000
CANCEL ENTER

Program each item as follows:

- **CLERK CODE (Use the numeric entry)**
Enter a clerk code to be assigned to a drink dispenser operator.
- **GLU START CODE (Use the numeric entry)**
Starting GLU code to be assigned to a drink dispenser operator (1 through 999999)
- **GLU END CODE (Use the numeric entry)**
Ending GLU code to be assigned to a drink dispenser operator (1 through 999999)

NOTE

If the **ENTER** key is touched without setting the range after entering a clerk code, the drink dispenser sales by the entered clerk will be unavailable.

■ Downloading

This option is used to download drink dispenser clerk assignment information to drink dispenser. To transfer this information, the drink dispenser must be initialized and set to on-line mode in advance. Initialization can be performed from the drink dispenser or from your POS terminal. To initialize from POS terminal, use X1/Z1 mode job.

Procedure

DRINK DISPENSER
CLERK0001
1 DD PRESET
2 DD OPERATOR
3 DOWN LOADING
4 LOCAL DD
CANCEL ENTER

On-line Configuration Programming

Use the following procedure to select the on-line configuration programming.
Please consult your dealer for more details.

Procedure

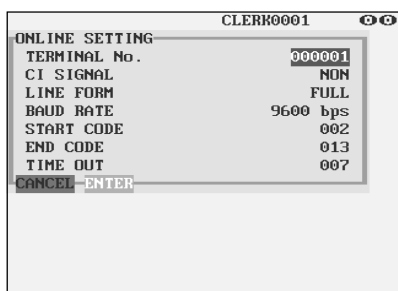
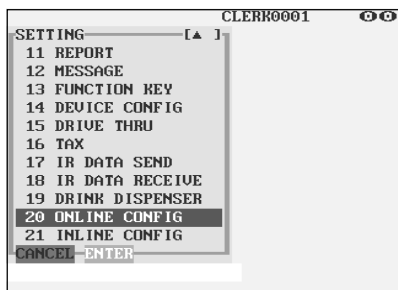

1. In the SETTING window, select "20 ONLINE CONFIG".
 - The ONLINE CONFIG window will appear.

2. Program each item as follows:

- **TERMINAL No. (Use the numeric entry)**
Terminal number (0 to 999999).
- **CI SIGNAL (Use the selective entry)**
Sensing of the CI signal
NON
SENSING
- **LINE FORM (Use the selective entry)**
Programming of the modem control
FULL: Full duplex system
HALF: Half duplex system
- **BAUD RATE (Use the selective entry)**
Transmission data rate
38400 bps 19200 bps 9600 bps
4800 bps 2400 bps 1200 bps
600 bps 300 bps
- **START CODE (Use the numeric entry)**
Start code (0 to 127)
- **END CODE (Use the numeric entry)**
End code (0 to 127)
- **TIME OUT (Use the numeric entry)**
Programming of the time-out time (1 to 255 sec.)

Price Mode Programming

The PRICE mode programming is chiefly used for daily changes of the PLU's unit price by supervisor or manager.

Procedure

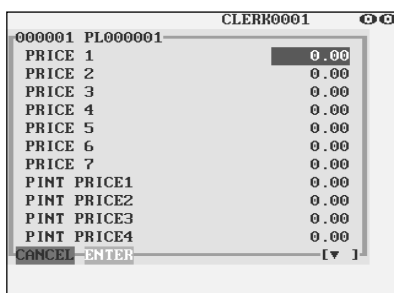
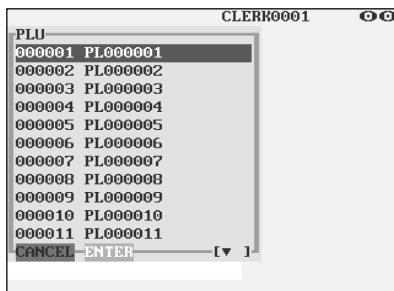
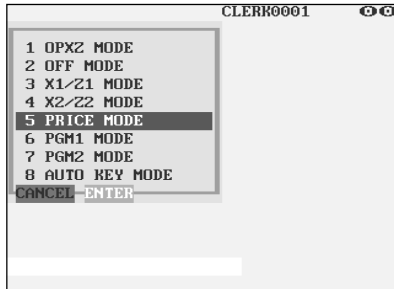

To program a unit price of the PLU as follows:

1. Select "5 PRICE MODE" from the mode selection window.
 - The PLU list will appear.

2. Select any PLU code from the list.

3. Program a unit price for corresponding price level.

- **PRICE1 through 7 (Use the numeric entry)**

Unit price of each price level (max. 6 digits)

By default, only a price for PRICE1 can be entered. If you want to enter a price for PRICE2 through 7, contact your authorized SHARP dealer.

Automatic Sequencing Key Programming

If you program frequently performed key operations for the AUTO keys, you can enter those key operations simply by touching the corresponding AUTO keys in key operations.

Procedure

Select "8 AUTO KEY MODE" from the mode selection window.

Select the keyboard from the keyboard list.

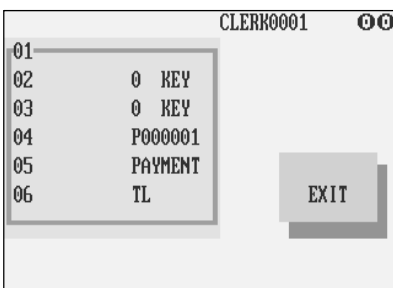
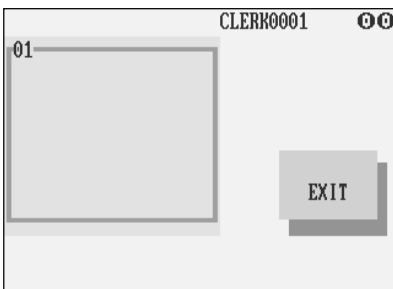
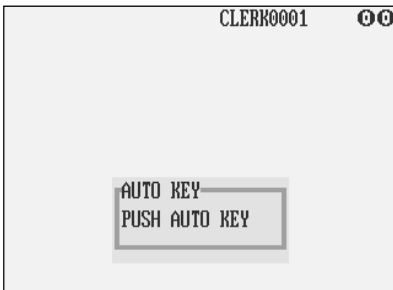

To program an automatic sequencing key as follows:

1. Touch a pertinent automatic sequencing key which you want to program.

AUTO

2. Enter the desired sequence to use the automatic sequencing key in the programmed sequence.

700 → 000001 → CASH/TL

3. Touch the automatic sequencing key again.

AUTO

4. Touch the EXIT to finalize the programming.

Reading of Stored Programs

You can read programs stored in the PGM1 or PGM2 mode.

■ Program reading sequence

To read those programs stored in the PGM1 or PGM2 mode, use the following procedure:

1. Select "1 READING" in the PGM1 or PGM2 mode menu window to display the items list.
2. Select an item listed in the table shown later.
3. If needed, enter starting and ending codes to specify the range of the selected item.
4. Select a device ("DISPLAY" or "REPORT PRINTER") to receive the output.

Item:	Description:	Available mode:
1 DEPT *	Department	PGM1 or PGM2
2 PLU *	PLU	PGM1 or PGM2
3 LINK PLU TABLE *	Link PLU table	PGM2
4 COMBO MEAL	Combo meal	PGM2
5 CONDIMENT TABLE *	Condiment table	PGM2
6 PROMOTION TABLE	Promotion table	PGM2
7 RECIPE TABLE *	Recipe table	PGM2
8 INGREDIENT *	Ingredient table	PGM1 or PGM2
9 PLU MENU KEY	PLU menu key	PGM2
10 SCALE TABLE	Scale table	PGM2
11 DEPT. SHIFT	Department shift	PGM2
12 HAPPY HOUR	Happy hour	PGM2
13 FUNCTION	Function	PGM1 or PGM2
14 MEDIA	Media key	PGM2
15 CLERK	Clerk	PGM1 or PGM2
16 MANAGER	Manager	PGM2
17 EMPLOYEE *	Employee	PGM2
18 JOB LOCATE TBL	Job location table	PGM2
19 OPTIONAL	Optional feature	PGM2
20 FUNCTION TEXT	Function text	PGM2
21 FUNCTION KEY	Function key	PGM2
22 DEPT. GROUP	Department group	PGM2
23 PLU GROUP	PLU group	PGM2
24 PLU HOURLY GR	PLU hourly group	PGM2

Item:	Description:	Available mode:
25 MESSAGE	Message	PGM2
26 TAX	Tax	PGM2
27 DRIVE THRU	Drive through code	PGM2
28 AUTO KEY	Automatic sequencing key	PGM2
29 DEVICE CONFIG	Device configuration	PGM2
30 DIRECT KEY	Direct key	PGM2
31 DRINK DISPENSER	Drink dispenser	PGM2
32 ONLINE CONFIG	On-line configuration	PGM2
33 INLINE CONFIG	In-line configuration	PGM2
34 ROM VERSION	ROM version	PGM2

NOTE

*You can read those programmed items marked with “ * ” by range.*

■ Sample printouts

• Departments (PGM1 or PGM2 mode)

Date	15/12/99	[0001]123456	Machine number
Consecutive number	#1109	15:22	Clerk name/clerk code
		CLERK0001	Time
Operating mode*	*PGM2*		
Report type	DEPT		
Dept. code	D01	5.00	Tax status
Description	DPT.01	T1 G01	Unit price
	0000003	C1	Group no.
Key text	DPT.01	KP001 L18	Commission group
		CYAN	HALO limit
	D02	2.50	Print station (Remote printer 1/2/receipt)
	DPT.02	G01	Function programming
	1000003	CO	0 0 0 0 0 3
	DPT.02	KP001 L18	Amount entry type
		CYAN	(open and preset/preset/open/inhibited)
	D03	3.00	Receipt type (double/single)
	DPT.03	G01	SIF/SICS/normal
	1000003	CO	Scale status
	DPT.03	KP001 L18	(Scale compulsory/enable/inhibited)
		CYAN	Scale table no.
	D04	0.00	Item validation print
	DPT.04	G01	(compulsory/non-compulsory)
	1000001	CO	Print on clerk report (Yes/no)
	DPT.04	KP001 L18	
		CYAN	Key color
		CYAN	
	D09	0.00	
	DPT.09	G01	
	1000201	CO	
	DPT.09	KP001 L18	
		CYAN	
	D10	-2.25	Minus department
	DPT.10	G10	
	1000003	CO	
	DPT.10	KP001 L18	
		CYAN	

* When you take this report in the PGM1 mode, the PGM2 indication is replaced by a "PGM1."

• PLUs (PGM1 or PGM2 mode)

	15/12/99	[0001]123456		
	#1110	15:25	CLERK0001	Promotion table no.
				Condiment table no.
Report type	PLU	*PGM2*		Menu type (space: normal PLU, L: link PLU table no., C: combo meal no.)
Associated dept. code				
PLU code	P000001(01)		#00/ 0	Base q'ty
Group no.	G01	P00 C00	/1.0	Pint base q'ty
	R000 000 000 000 000 000 000			Recipe table no.
Key text	P1 PL000001		1.20	Price 1
	000001		0.00	Description for price level 1
	P2		1.75	Price 2
			0.00	
	P3		0.00	Price 3
			0.00	
	P4		0.00	Price 4
			0.00	
	P5		0.00	Price 5
			0.00	
	P6		0.00	Price 6
			0.00	
	P7		0.00	Price 7
			0.00	Commission group
Tare table no.	TO 00002 CO	HG00 00 00	KP001	Print station (Remote printer 1/2/receipt)
	M 0.000 S		19.000	
			YELLOW	Tax status
	P000002(01)		L #01/ 0	
	G01	P00 C00	/1.0	
	R000 000 000 000 000 000 000			
Key text	P1 PL000002		2.80	
	000002		0.00	
	P2		2.50	
			0.00	
	P3		0.00	Function programming
			0.00	0 0 0 2 — Amount entry type
	P4		0.00	(open and preset/preset/open /inhibited)
			0.00	Scale status (compulsory/enable/inhibit)
	P5		0.00	Condiment entry to menu item
			0.00	(compulsory/non-compulsory)
	P6		0.00	Condiment type/non-condiment type
			0.00	
	P7		0.00	Price shift (compulsory/inhibited/allowed)
			0.00	
			0.00	Hourly group
	TO 00002 CO	HG00 00 00	KP001	
	M 0.000 S		132.000	
			YELLOW	Key color
	P000003(01)		#00/ 0	
	G01	P00 C00	/1.0	
	R000 000 000 000 000 000 000			
Key text	P1 PL000003		5.00	
	000003		0.00	
	P2		3.10	
			0.00	

• PLUs (continued)

P000019(01)		#00/ 0
G01	P00 C00	/1.0
R000 000 000 000 000 000 000		
P1	PL000019	0.00
	000019	0.00
P2		0.00
		0.00
P3		0.00
		0.00
P4		0.00
		0.00
P5		0.00
		0.00
P6		0.00
		0.00
P7		0.00
		0.00
T0	00002 C0 HG00 00 00	KP001
	M 0.000 S	0.000
		YELLOW
P000020(01)		#00/ 0
G01	P00 C00	/1.0
R000 000 000 000 000 000 000		
P1	PL000020	0.00
	000020	0.00
P2		0.00
		0.00
P3		0.00
		0.00
P4		0.00
		0.00
P5		0.00
		0.00
P6		0.00
		0.00
P7		0.00
		0.00
T0	00002 C0 HG00 00 00	KP001
	M 0.000 S	0.000
		YELLOW

PLU's menu type
 Blank : Normal
 L : Link PLU
 C : Combo meal

• Link PLU table (PGM2 mode)

15/12/99		[0001]123456
#1113	15:31	CLERK0001
PGM2		
LINK PLU TABLE		
#01		P000015
		P000016
		P000017
		P000018
		P000019
#02		P000010
		P000011

Report type
 Link PLU table no.
 Assigned PLU codes

• Combo meal (PGM2 mode)

15/12/99		[0001]123456
#1115	15:35	CLERK0001
PGM2		
COMBO MEAL		
#01	P000001	1.10
	P000002	1.25
	P000003	2.20
	P000004	1.20
	P000005	1.75
#02	P000006	1.00
	P000007	2.10

Report type
 Combo meal no.
 Assigned PLU codes and prices

• Promotion table (Normal selling) (PGM2 mode)

15/12/99 [0001] 123456		
#1117	15:39	CLERK0001
PGM2		
PROMOTION TABLE		
#01		
VALUE MEAL	/ 3	1.00
		P000010
		P000011
		P000012
		P000020
#02		
	/ 5	2.10
		P000007
		P000008
		P000009

Report type
 Promotion table no.
 Discount amount
 Trip level
 Text

• Condiment table (PGM2 mode)

15/12/99 [0001] 123456		
#1123	16:01	CLERK0001
PGM2		
CONDIMENT TABLE		
#01		P000015
		P000013
		P000017
		P000018
Text for #01		#04
#02		P000007
		P000008
		P000009
Text for #02		P000002
#04		P000003
Text for #04		

Report type
 Condiment table no.
 Assigned PLU codes
 Linked condiment table no.

Message text

• Promotion table (Set selling) (PGM2 mode)

15/12/99 [0001] 123456		
#1120	15:42	CLERK0001
PGM2		
PROMOTION TABLE		
#01		
VALUE MEAL		1.00
	/ 1	P000010
	/ 1	P000011
	/ 2	P000012
	/ 1	P000020
#02		
	/ 1	2.10
	/ 1	P000007
	/ 1	P000008
	/ 2	P000009

Report type
 Promotion table no.
 Discount amount
 Trip level
 Text

• Recipe table (PGM2 mode)

15/12/99 [0001] 123456		
#1128	16:07	CLERK0001
PGM2		
RECIPE TABLE		
#001		
	001 /	1.000
	003 /	3.000
	014 /	2.000
	022 /	5.000

Report type
 Ingredient no.
 Q'ty
 Recipe table no.

• Ingredient (PGM1 or PGM2 mode)

```

15/12/99 [0001]123456
#1131 16:11 CLERK0001

*PGM2*
INGREDIENT

I 001 BREAD
0.35 S 100.00
I 002 EGG
0.10 S 250.00
I 003 TOMATO
0.85 S 50.00
I 004 SOUP
1.00 S 200.00
I 014
0.00 S 0.00
I 022
0.00 S 0.00
    
```

Report type
 Ingredient no.
 Ingredient descriptor
 Stock
 Cost

• Scale table (PGM2 mode)

```

15/12/99 [0001]123456
#1137 16:16 CLERK0001

*PGM2*
SCALE TABLE

#1 0.752
#2 1.350
#3 1.235
#4 0.000
#5 0.000
#6 0.000
#7 0.000
#8 0.000
#9 0.000
    
```

Report type
 Scale table no.
 Tare weight

• Department shift (PGM2 mode)

```

15/12/99 [0001]123456
#1133 16:13 CLERK0001

*PGM2*
DEPT. SHIFT

DEPT. SHIFT1 01
DEPT. SHIFT2 02
DEPT. SHIFT3 03
DEPT. SHIFT4 04
    
```

Report type
 Department code

• PLU menu key (PGM2 mode)

```

15/12/99 [0001]123456
#1140 16:19 CLERK0001

*PGM2*
PLU MENU KEY

#01 P000001
P000002
P000003
P000004
P000005
P000006
P000007
P000008
P000009
P000010
P000011
P000012
P000013
P000014
P000015
P000016
P000017
P000018
P000019
P000020
    
```

Report type
 Menu key no.
 Menu item

• Happy hour (PGM2 mode)

```

15/12/99 [0001]123456
#1135 16:14 CLERK0001

*PGM2*
HAPPY HOUR

SFT1 START TIME 7:00
END TIME 9:00
SFT2 START TIME 12:00
END TIME 13:00
SFT3 START TIME 17:00
END TIME 18:00
SFT4 START TIME 0:00
END TIME 0:00
SFT5 START TIME 0:00
END TIME 0:00
SFT6 START TIME 0:00
END TIME 0:00
SFT7 START TIME 0:00
END TIME 0:00
    
```

Report type
 Time range

• Functions (PGM1 or PGM2 mode)

• Media (PGM2 mode)

15/12/99 [0001] 123456
#1142 16:24 CLERK0001

PGM2

FUNCTION

(-) 1	-0.00	Report type
I	L18	Sign (plus/minus)
(-) 2	-0.00	Function text
S	L18	Amount
(-) 3	-0.00	HALO
S	L18	Type
(-) 4	-0.00	I=Item
S	L18	S=Subtotal
(-) 5	-0.00	R=Received
S	L18	-on-account
(-) 6	-0.00	
S	L18	
(-) 7	-0.00	
S	L18	
(-) 8	-0.00	
S	L18	
(-) 9	-0.00	
S	L18	
%1	-10.00%	Rate
S	L100.00%	
%2	15.00%	
I	L100.00%	
%3	-0.00%	
S	L100.00%	
%4	-0.00%	
S	L100.00%	
%5	-0.00%	
S	L100.00%	
%6	-0.00%	
S	L100.00%	
%7	-0.00%	
S	L100.00%	
%8	-0.00%	
S	L100.00%	
%9	-0.00%	
S	L100.00%	
COM. SAL1	0.000%	
COM. SAL2	0.000%	
COM. SAL3	0.000%	
SER. CHRG	0.00%	
CASH TIP	L18	
NOCA TIP	L18	
DEPOSIT	L18	
DEPO. (-)	L18	
***RA	L18	
***RA2	L18	
***PO	L18	
***PO2	L18	

15/12/99 [0001] 123456
#1147 16:29 CLERK0001

PGM2

MEDIA

CASH	L18	Report type
	000010	Function text
CASH2	L18	HALO
	000010	Programming
CHECK	L18	
	00000010	
CHECK2	L18	
	00000010	
CHECK3	L18	
	00000010	
CHECK4	L18	
	00000010	
CREDIT1	L18	
	00000010	
CREDIT2	L18	
	00000010	
CREDIT3	L18	
	00000010	
CREDIT4	L18	
	00000010	
CREDIT5	L18	
	00000010	
CREDIT6	L18	
	00000010	
CREDIT7	L18	
	00000010	
CREDIT8	L18	
	00000010	
HOTEL TRANS.	L18	
	000001	
****CID	999999.99	Sentinel
CHK/CG	999999.99	HALO
CA/CHK	999999.99	
CA/CHK2	999999.99	
CA/CHK3	999999.99	
CA/CHK4	999999.99	

CURRENCY

EXCH1	US\$	0.000000	2	Rate
EXCH2		0.000000	2	
EXCH3		0.000000	2	Descriptor
EXCH4		0.000000	2	
EXCH5		0.000000	2	
EXCH6		0.000000	2	
EXCH7		0.000000	2	
EXCH8		0.000000	2	
EXCH9		0.000000	2	

DRAWER1

• Clerk (PGM1 or PGM2 mode)

```

15/12/99 [0001] 123456
#1148 16:31 CLERK0001

*PGM2*
CLERK

CLK#0001 CLERK0001
1-99999999 000000
1111 001 0000001 D1 (0000)
CLK#0002 CLERK0002
1-99999999 000000
0000 002 0000011 D1 (0000)

CLK#0009 CLERK0009
1-99999999 000000
0000 009 0000001 D1 (0000)
CLK#0010 CLERK0010
1-99999999 000000
0000 010 0000001 D1 (0000)
    
```

- Report type
- Clerk code
- Clerk name
- Linked GLU codes
- Secret code
- Programming 0 0 0 0 0 0 D 1
- Drawer no.
- Price level
- VAT shift
- G.C. copy
- GLU system
- VIP sale
- Supervisor clerk
- Resetting in OP X/Z mode
- Key no.
- Dept. shift 1 through 4 (yes/no)
- Mode selection 0 0 0 0 0 0
- Auto key programming (enable/disable)
- X2/Z2 mode (enable/disable)
- X1/Z1 (enable/disable)
- PRICE mode (enable/disable)
- PGM1 mode (enable/disable)
- PGM2 mode (enable/disable)

• Employee (PGM2 mode)

```

15/12/99 [0001] 123456
#1153 16:49 CLERK0001

*PGM2*
EMPLOYEE

EMP#0000000003 MEYER
CLK#0002 MGR#03 7.5
(1357) L01 L03 L05 L02
    
```

- Report type
- Employee code
- Employee name
- Standard number of working hours
- Linked manager code
- Job location nos.
- Linked clerk code
- Secret code

• Manager (PGM2 mode)

```

15/12/99 [0001] 123456
#1150 16:45 CLERK0001

*PGM2*
MANAGER

MGR#01 1234
MGR#02 0780
MGR#03 3300
    
```

- Report type
- Manager code
- Secret code

• Job location table (PGM2 mode)

```

15/12/99 [0001] 123456
#1156 16:51 CLERK0001

*PGM2*
JOB LOCATE TBL

#01 CASHIER
SA 600.00 OT 1.50
#02 KITCHEN
SA 750.00 OT 2.00
    
```

- Report type
- Job location table no.
- Text
- Overtime pay rate
- Salary pay amount

• Optional features (PGM2 mode)

15/12/99	[0001]123456
#1157	16:52 CLERK0001
PGM2	
OPTIONAL	Report type
OPTIONAL	
FUNC. PROHIBIT	
OP X/Z REPORT	ENABLE Setting
PAID OUT	PUBLIC Item
REFUND/RETURN	PUBLIC
ISSUED ITM VD	PUBLIC
NO ISSUED ITM VD	PUBLIC
SUB-TOTAL VOID	PUBLIC
ITEM VP	ENABLE
INTERMEDIATE GLU	PUBLIC
VIP SALES	PUBLIC
GLU FINALIZE	ENABLE
WASTE MODE	PUBLIC
FUNC. SELECTING	
REFUND VP	NON-COMPULSORY
(-) VP	NON-COMPULSORY
DOUBLE RCPT HEAD	NORMAL
VAT SHIFT SYSTEM	BY SHIFT KEY
LEVEL SFT METHOD	MANUAL
LEVEL SHIFT	PUBLIC
RETURN TO LEVEL1	BY ONE ITEM
PRICE SFT SYSTEM	BY SHIFT KEY
PRICE SFT METHOD	MANUAL
PRICE SHIFT	PUBLIC
RETURN TO PRICE1	BY ONE ITEM
QTY IN VIP SALES	NOT UPDATE

NON-TURNOVER	EXCLUDE VAT
CREDIT IN RA/PO	NOT UPDATE
SHIFT KEY ACTION	CAPS LOCK
DRIVE SCREEN	MANUAL
WHEN T-LOG FULL	LOCK
WHEN E. J. FULL	LOCK
PAYMENT FOR EX1	CASH ONLY
EX1 CALCULATION	MULTIPLICATION
PRINTING SELECT	
# OF PURCHASE	NOT PRINT
TIME	PRINT
JOURNAL SELECT	FULL PRINT
JOURNAL LETTER	SMALL SIZE
VAT/TAX ON R/J	PRINT
TAXABLE ON R/J	PRINT
NET ON R/J	PRINT
VAT/TAX ON BILL	PRINT
TAXABLE ON BILL	PRINT
NET ON BILL	PRINT
TIME ON BILL	PRINT
BILL ON SLIP	PRINT
BILL ON RECEIPT	PRINT
INTERMED ON SLIP	PRINT
INTERMED ON RCPT	PRINT
SEPARATOR LINE	1 LINE
LINK PLU TEXT	PRINT EACH PLU
FREE TEXT ON KP	NOT PRINT
ITEM CODE ON KP	NOT PRINT

• Optional features (continued)

UNIT PRICE ON KP	NOT PRINT	
AMOUNT ON KP	NOT PRINT	
GUEST# ON KP	NOT PRINT	
QTY1 PRINT ON KP	NOT PRINT	
TOTAL&CHANGE PRT	NOT PRINT	
PAYMENT VP	WITH FOREIGN	
MAXIMUM TICKET	WITH FOREIGN	15
TERMINAL		
BILL NUMBER		0005
DRAWER ALARM		0
SCREEN SAVE		0
0 SKIP		
CLERK TRANSACTION	SKIP	
DEPARTMENT	SKIP	
PLU	SKIP	
HOURLY	SKIP	
DAILY NET	SKIP	
GNR RPT FORMAT		
DEPARTMENT	NOT SKIP	
TRANSACTION	NOT SKIP	
TAX SALE	NOT SKIP	
CID	NOT SKIP	
HOURLY RPT		
MEMORY TYPE		30
STARTING TIME		00
STACKED RPT		
1		
GENERAL		
PLU TOP 20	AMOUNT	
ALL CLERK		
EMPLOYEE	000000001-999999999	
HOURLY		
2		
DEPT./GROUP	01-99	
PLU	000001-999999	

Drawer open alarm time

Hourly report

Stacked report 1

Stacked report 2

• Function text (PGM2 mode)

15/12/99 [0001]123456		
#1166	17:30	CLERK0001
PGM2		
FUNCTION TEXT		
DISCOUNT	DISCOUNT	Report type
DIFFER	DIFFER	Function text (default)
TAX1 ST	TAX1 ST	Text (preset)
TAX2 ST	TAX2 ST	
TAX3 ST	TAX3 ST	
TAX4 ST	TAX4 ST	
TAX5 ST	TAX5 ST	
TAX6 ST	TAX6 ST	
VAT 1	VAT 1	
VAT 2	VAT 2	
VAT 3	VAT 3	
VAT 4	VAT 4	
VAT 5	VAT 5	
VAT 6	VAT 6	
NET1	NET1	
NET2	NET2	
CP PLU	CP PLU	
VD	VD	
SBTL VD	SBTL VD	
MGR VD	MGR VD	
VOID	VOID	
REFUND	REFUND	
RETURN	RETURN	
HASH VD	HASH VD	
HASH RF	HASH RF	
HASH RT	HASH RT	
NOTURNVD	NOTURNVD	
NOTURNRF	NOTURNRF	
NOTURNRT	NOTURNRT	
VAT SFT	VAT SFT	
TAX DELE	TAX DELE	
VP CNT	VP CNT	
BILL CNT	BILL CNT	
NO SALE	NO SALE	
G. C. CNT	G. C. CNT	
***PBAL	***PBAL	
***PBAL2	***PBAL2	
***NBAL	***NBAL	
***NBAL2	***NBAL2	
SCM (+)	SCM (+)	
SCM (-)	SCM (-)	
EXCH1 IS	EXCH1 IS	
EXCH2 IS	EXCH2 IS	
EXCH3 IS	EXCH3 IS	
EXCH4 IS	EXCH4 IS	
EXCH5 IS	EXCH5 IS	
EXCH6 IS	EXCH6 IS	
EXCH7 IS	EXCH7 IS	
EXCH8 IS	EXCH8 IS	
EXCH9 IS	EXCH9 IS	
CA/CK IS	CA/CK IS	

CA/CK ID	CA/CK ID
GUEST	GUEST
NON COM.	NON COM.
VIP SALE	VIP SALE
WASTE TL	WASTE TL
ORDER TL	ORDER TL
PAID TL	PAID TL
TRAN. OUT	TRAN. OUT
TRAN. IN	TRAN. IN
TIP PAID	TIP PAID
DOM. CUR1	DOM. CUR1
DOM. CUR2	DOM. CUR2
DOM. CUR3	DOM. CUR3
DOM. CUR4	DOM. CUR4
DOM. CUR5	DOM. CUR5
DOM. CUR6	DOM. CUR6
DOM. CUR7	DOM. CUR7
DOM. CUR8	DOM. CUR8
DOM. CUR9	DOM. CUR9
*NT TL1	*NT TL1
*NT TL2	*NT TL2
*NT TL3	*NT TL3
*CH ID	*CH ID
*DEPT TL	*DEPT TL
DEPT (-)	DEPT (-)
*HASH TL	*HASH TL
HASH (-)	HASH (-)
NET 1	NET 1
NET 2	NET 2
NET 3	NET 3
NET 4	NET 4
NET 5	NET 5
NET 6	NET 6
SUBTOTAL	SUBTOTAL
MDSE ST	MDSE ST
***TOTAL	***TOTAL
DIFF ST	DIFF ST
NON-TURN	NON-TURN
CHANGE	CHANGE
CHECK PR	CHECK PR
DUE	DUE
TIP DUE	TIP DUE
BALANCE	BALANCE
ITEMS	ITEMS
PLU ST	PLU ST
COPY	COPY
G.C COPY	G.C COPY
B. T.	B. T.
B. S.	B. S.
INTERMED.	INTERMED.
BILL	BILL
C. BILL	C. BILL
VIP SALE	VIP SALE
WASTE	WASTE
SLIP PR.	SLIP PR.
NEXT P.	NEXT P.
AVE.	AVE.

CCD	CCD
CCD DIF.	CCD DIF.
DIF. TL	DIF. TL
O-P	O-P
COM. AMT1	COM. AMT1
COM. AMT2	COM. AMT2
COM. AMT3	COM. AMT3
COM. TTL	COM. TTL
BILL BAL	BILL BAL
FREE GLU	FREE GLU
OLD BAL.	OLD BAL.
BALANCE	BALANCE
SCM TTL	SCM TTL
T. TABLE	T. TABLE
T. GUEST	T. GUEST
T. BILL	T. BILL
I. GUEST	I. GUEST
I. BILL	I. BILL
AVE. ITEM	AVE. ITEM
COST	COST
COST%	COST%
TTL COST	TTL COST
LOC#	LOC#
L. COST	L. COST
TTL HOUR	TTL HOUR
OVR TIME	OVR TIME
OVR COST	OVR COST
TIME-IN	TIME-IN
TIME-OUT	TIME-OUT
BREAK-IN	BREAK-IN
BREAK-OUT	BREAK-OUT
BREAK TL	BREAK TL
LABOR%	LABOR%
TTL TAX	TTL TAX
NET	NET
TOWNNAME	TOWNNAME
TOWNNAME	TOWNNAME
TRANSFER	TRANSFER
GLU#	GLU#
CAR#	CAR#
PINT SAL	PINT SAL
ALL FOODS &	ALL FOODS &
DRINKS	DRINKS
IND. PAY	IND. PAY
TARE WT.	TARE WT.
RCP SW.	RCP SW.
RST SBTL	RST SBTL
RESET TL	RESET TL
MISOP TL	MISOP TL
BILL VOID	BILL VOID
WASTE	WASTE
COMBO	COMBO
COMBO WASTE	COMBO WASTE
EX1CH+CR	EX1CH+CR
DOM. CHK/CR 1	DOM. CHK/CR 1

• Department group text (PGM2 mode)

```

15/12/99 [0001]123456
#1167    17:44  CLERK0001

*PGM2*
DEPT. GROUP

GROUP1  GROUP1
GROUP2  GROUP2
GROUP3  GROUP3
GROUP4  GROUP4
GROUP5  GROUP5
GROUP6  GROUP6
GROUP7  GROUP7
GROUP8  GROUP8
GROUP9  GROUP9
    
```

Report type
Function text (default)
Text (preset)

• PLU hourly group text (PGM2 mode)

```

15/12/99 [0001]123456
#1169    17:45  CLERK0001

*PGM2*
PLU HOURLY GR

HOUR GR1 HOUR GR1
HOUR GR2 HOUR GR2
HOUR GR3 HOUR GR3
HOUR GR4 HOUR GR4
HOUR GR5 HOUR GR5
HOUR GR6 HOUR GR6
HOUR GR7 HOUR GR7
HOUR GR8 HOUR GR8
HOUR GR9 HOUR GR9
    
```

Report type
Function text (default)
Text (preset)

• PLU group text (PGM2 mode)

```

15/12/99 [0001]123456
#1168    17:45  CLERK0001

*PGM2*
PLU GROUP

PLU GRO0 PLU GRO0
PLU GR01 PLU GR01
PLU GR02 PLU GR02
PLU GR03 PLU GR03

PLU GR96 PLU GR96
PLU GR97 PLU GR97
PLU GR98 PLU GR98
PLU GR99 PLU GR99
    
```

Report type
Function text (default)
Text (preset)

• Message (PGM2 mode)

```

15/12/99 [0001]123456
#1172 17:50 CLERK0001

*PGM2*
MESSAGE

RECEIPT LOGO
SHARP
PRESENTS THE
UP-3300
SHARP
IS THE
BEST

FREE TEXT
#01
TEXT01
    
```

Report type

Receipt logo text

Free text

```

#99
TEXT99

VP TEXT

FOR DEPOSIT ONLY

SLIP TEXT

SLIP FOOTER

PAYEE NAME

E. BILL MESSAGE
    
```

VP text

Slip text

Slip footer

Payee name for English check

• Drive-through code (PGM2 mode)

```

15/12/99 [0001]123456
#1173 17:55 CLERK0001

*PGM2*
DRIVE THRU

1-99999999
0100
    
```

Report type

Starting code

Ending code

• Tax rate (PGM2 mode)

```

15/12/99 [0001]123456
#1176 17:58 CLERK0001

*PGM2*
TAX

TAX1 7.5000 %
      0.10
TAX2 3.0000 %
      0.10
TAX3 4.0000 %
      0.15
TAX4 5.0000 %
      0.21
TAX5 2.0000 %
      0.13
TAX6 -1.0000 %
      0.11
    
```

Report type

Tax no.

Rate

Lowest taxable amount

• Function key (PGM2 mode)

```

15/12/99 [0001]123456
#1177 17:58 CLERK0001

*PGM2*
FUNCTION KEY

001 HOME
002 BLUE
003 CANCEL
004 LIGHT MAGENTA
      CLEAR
      LIGHT MAGENTA
      MODE
      LIGHT CYAN
    
```

Report type

Key name

Key color

```

254 WASTE
255 RED
      NEXT CONDIMENT
256 LIGHT BLUE
      D-THRU
257 BLUE
      ENTERTAINMENT
      YELLOW
    
```

• AUTO key (PGM2 mode)

```

15/12/99 [0001]123456
#1180 18:07 CLERK0001

*PGM2*
AUTO KEY

#01
MAIN1 (HOME) P000001
MAIN1 (HOME) P000003
MAIN1 (HOME) P000007
MAIN1 (HOME) PAYMENT
PAYMENT TL
#02 -----

#24 -----
#25 -----
PGM MODE MODE
PGM MODE 1 KEY
PGM MODE ENTER
    
```

Report type: **AUTO KEY**

AUTO key no.: #01

Key operation: P000001, P000003, P000007, PAYMENT, TL

• Direct key (PGM2 mode)

```

15/12/99 [0001]123456
#1186 18:18 CLERK0001

*PGM2*
DIRECT KEY

MAIN1 (HOME)
001 -----
002 -----

065 L 1 P000021
L 2 -----
L 3 -----
L 4 -----
L 5 -----
L 6 -----
L 7 -----
L 8 -----
L 9 -----
L10 -----

021 L 1 P000005
L 2 -----
L 3 -----
L 4 -----
L 5 -----
L 6 -----
L 7 -----
L 8 -----
L 9 -----
L10 -----

022 L 1 P000010
    
```

Report type: **DIRECT KEY**

Key no.: 001, 002

PLU level: 065

PLU code: L 1 P000021

• Device configuration (PGM2 mode)

```

15/12/99 [0001]123456
#1183 18:12 CLERK0001

*PGM2*
DEVICE CONFIG

JOURNAL PRINTER T#000-C#1
SHARP ER-01PU NO
ONE SHEET
RECEIPT PRINTER T#000-C#1
SHARP ER-01PU 0/ YES
ADDITION ONE SHEET
PRE-PRINT
SLIP PRINTER T#000-C#2
EPSON TM-295 00 99 1
REPORT PRINTER T#000-C#1
SHARP ER-01PU YES
ONE SHEET
KP#1 ---

KP#9 ---
SCALE ---
DRINK DISPENSER C#6
ONLINE C#5
    
```

Report type: **DEVICE CONFIG**

Model no. of printer: T#000-C#1

Auto cutter: NO

Paper type: ONE SHEET

Minimum length for bill on the receipt: 0/ YES

Printer: PRE-PRINT

No. of times of VP: 00 99 1

Maximum line nos. of slip printing: YES

Initial slip feed line no.: ONE SHEET

• Drink dispenser (PGM2 mode)

15/12/99 [0001] 123456	
#1193	18:25 CLERK0001
DD PRESET	
DD NO. 1	000000-000999
VALUE NUMBER	00000000
SEPARATE CODE	ON-LINE
CONNECTION	PRINT
PRINT FORMAT	
DD OPERATOR	
CLK#0001	1- 50
CLK#0002	100- 200
LOCAL DD	
1	000000-000999 ON-LINE
2	000000-000999 OFF-LINE
3	000000-000999 OFF-LINE
4	000000-000999 OFF-LINE
5	000000-000999 OFF-LINE
6	000000-000999 OFF-LINE
7	000000-000999 OFF-LINE
8	000000-000999 OFF-LINE

Drink dispenser number

PLU codes linked to the sort number

Separate code

Print format of misoperation reading

List of the clerks who are able to operate drink dispenser

GLU range area

On-line

Off-line

• ROM version (PGM2)

15/12/99 [0001] 123456	
#1197	18:28 CLERK0001
PGM2	
VERSION	
IPL Version	00 UP-3300
PROGRAM Version	27801RAF00 UP-3300
	27801RAG00 UP-3300
BLOCK Version	20=00, 21=00, 22=00, 23=00
	24=00, 25=00, 26=00, 27=00
	28=00, 29=00, 2A=00, 2B=00
	2C=00, 2D=00, 2E=00, 2F=00
	30=00, 31=00, 32=00, 33=00
	34=00, 35=00, 36=00, 37=00
	38=00, 39=00, 3A=00, 3B=00
	3C=00, 3D=00, 3E=00, 3F=00
Installed SSP	

• On-line configuration (PGM2)

15/12/99 [0001] 123456	
#1194	18:27 CLERK0001
PGM2	
ONLINE PRESET	
TERMINAL No.	000001
MODEM CONTROL	00
BPS	5
START CODE	002
END CODE	013
TIME OUT	007

14

Drink Dispenser

Your POS terminal can be connected with a drink dispenser.
The summary of drink dispenser operations is shown below.

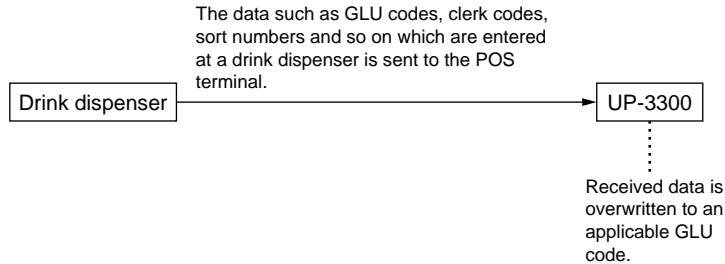

When an entry error is found, perform the following steps:

1. Check the error by the drink dispenser misoperation file reading or drink dispenser error reading.
 - Drink dispenser misoperation file reading → REG or MGR mode
 - Clerk report → OP X/Z or X1/Z1 mode

If there is misoperation data when you take an individual or full clerk X/Z report, the machine waits for selection of one of the following three commands (RETRY, ABORT and IGNORE) through the keyboard.

 - 1 RETRY: attempts to retry the report issuing job.
 - 2 ABORT: cancels the report issuing job.
 - 3 IGNORE: issues the report, disregarding that there is misoperation data. In the case of the Z report, misoperation data is also reset. - Drink dispenser error reading → X1/Z1 mode
2. Correct the error with the drink dispenser correction in the REG or MGR mode.

The error which relates to GLU codes can be corrected. However, the error which relates to PLU codes or clerk codes cannot be corrected with the drink dispenser correction.

Procedure to return from Off-line to On-line mode

Case 1:

The drink dispenser was set to Off-line only for a short term and there have been no change in GLU occupations (same guests at the same table).

The data-buffer of the drink dispenser can be emptied by using the DD reset function (Z1 mode). The POS terminal - drink dispenser line is automatically set to On-line by this function.

Case 2:

The drink dispenser was set to Off-line for a long term. Therefore, the use of the DD reset function is not applicable because GLU occupations have been changed, meanwhile. Empty the drink dispenser data-buffer at the drink dispenser directly and set the POS terminal - drink dispenser line to On-line manually.

■ Drink dispenser misoperation and misoperation file

The error caused by misoperation during drink dispenser sales registration or missetting is recorded in the drink dispenser misoperation file.

■ Causes of drink dispenser misoperation

	Causes	Processing	Error message
For PLU Department	No PLU/department code	2	NO RECORD
	Inhibited PLU code	2	INHIBIT PLU
	Preset price entry is inhibited.	2	ENTRY INHIBIT
	It's combo PLU, link PLU, condiment PLU, promotion PLU, minus PLU, or scale compulsory PLU.	2	ENTRY INHIBIT
	Amount overflow	2	TRANS. OVERFLOW
For GLU	No GLU code	1	ENTRY ERROR
	GLU code is out of the range.	1	ENTRY ERROR
	Lacking memory of GLU file	1	LACKING MEMORY
	GLU code is assigned to other clerk.	1	NO AUTHORITY
	GLU code is transferred out.	1	NO AUTHORITY
	VIP sale, VIOD mode or Training mode	1	ENTRY ERROR
For clerk	Clerk code is not defined.	2	UNDEFINE CODE
	Supervisor clerk is inhibited.	2	ENTRY ERROR
	Starting cash memory entry is compulsory.	2	ENTRY ERROR
Others	Buffer full	1	MEMORY FULL
	Transaction amount overflow	1	TRANS. OVERFLOW

NOTE

Processing 1 or 2 discriminates the processing type explained on the following pages.

■ Description of misoperation

The following two types of misoperation disposal are possible:

Type 1: Misoperation in the case when there is established clerk code which has been defined by the POS terminal based on the clerk code inputted from the drink dispenser and the PLU assigned by using the sort number of drink dispenser sales, but the GLU code is wrong. (The GLU code is out of the range for the clerk or has already been used by another clerk.)

Such a misoperation is recorded in the drink dispenser misoperation file. At this time the following data is updated:

- Totalizer for the associated department
 - Totalizer for each PLU
 - Stock counter (if controlled)
- (Data of pertinent clerk)
- Order total
 - Commission sales amount
 - Non-commission sales amount

Type 2: Fatal error in the case when the clerk code and PLU code of information (clerk code, sort number) sent from the drink dispenser cannot be identified and the totalizers for clerk or PLUs cannot be updated.

Such an error is recorded in the drink dispenser misoperation file without updating of totalizers. Accordingly, these errors are not registered in the POS terminal. They are recorded only in the drink dispenser misoperation file. These errors cannot be corrected with the correction operation.

These errors are roughly classified into the following two groups :

- Errors which make it impossible to identify the PLU code.
- Errors which make it impossible to identify the clerk code.

The former error is printed out with correction disabled mark when reading the drink dispenser misoperation or reading the drink dispenser misoperation of clerk report. If the clerk code cannot be identified, the error cannot be read by drink dispenser misoperation read operation but read/reset is possible in the X/Z mode. However, if the clerk code corresponding to the clerk code is defined in the POS terminal system after occurrence of error whose clerk code cannot be identified, it cannot be corrected with the correction operation. Accordingly, it is printed out as drink dispenser error read list, being distinguished from the ordinary misoperation read.

■ Misoperation file reading

Each clerk can display out only his/her misoperation data in the misoperation file in the REG or MGR mode.

Procedure

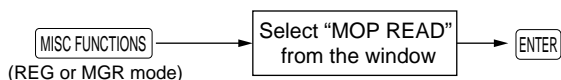

NOTE

The data of the drink dispenser misoperation file can be printed or displayed out as well in the OP X/Z and X1/Z1 modes.

■ Correction of drink dispenser articles in a drink dispenser misoperation file

When a clerk recognizes that a drink dispenser misoperation file has a record, the clerk can correct the drink dispenser operation by selecting of the drink dispenser article on the screen.

Procedure

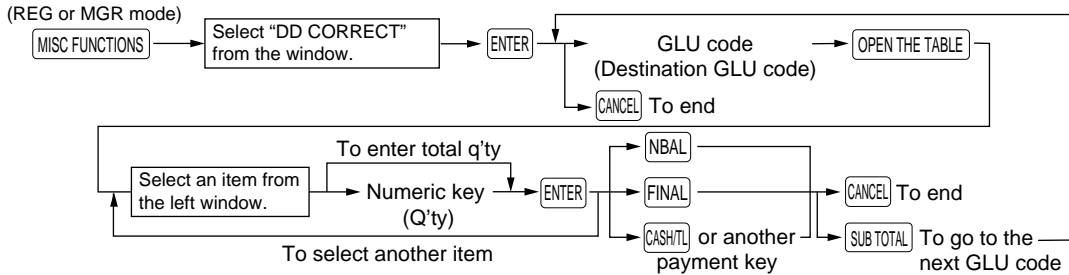

NOTE

- The contents of the first GLU code in the misoperation file are displayed in the left window.
- The pick-upped items from the left window are displayed in the right window. These items are stored in the destination GLU code when the **CASH/TL** key is touched.
- The item which is moved is selected by the cursor (**↑** and **↓**) keys.
- When the **→** key is touched, the cursor is moved to the right window. When the **←** key is touched, the cursor is moved to the left window.
- When the **SUB TOTAL** key is touched, the contents of the next GLU code in the misoperation file are displayed.
- When the **NBAL**, **FINAL**, or **CASH/TL** key or another payment key is touched, the items in the right window are stored in the destination GLU code. And the contents are printed on receipt/journal printer. Then the entry of the next destination GLU code is displayed. If the **CANCEL** key is touched at this time, the correction operation is finished.

Function

Subtotal and taxable subtotals of corresponding GLU/PBLU are updated, but in the other totalizers are not updated. (Because they are already updated when misoperation has occurred.)

■ Electronic journal

This function is intended to record the journal data in the electronic journal file (memory) instead of journal paper. For details, contact your authorized SHARP dealer.

● Recording data

The POS terminal records the printing output to the journal printer in REG, PGM1, PGM2, X1/Z1, and X2/Z2 modes into the electronic journal file.

● Reporting (X report)

The POS terminal reports the journal data (same as normal journal formats) in the electronic journal file by the report printer or the display.

Operation: Select the reading operation "E.JOURNAL" in X1/Z1 mode.

It is possible to take filter functions (consecutive no./date/clerk code).

Consecutive no.: ALL or RANGE (designate start no./end no.)

Date: ALL or RANGE (designate start date/end date)

Clerk code: ALL or INDIVIDUAL (designate clerk code)

● Resetting (Z report)

It is possible to take the resetting report of the journal data (same as normal journal formats) in the electronic journal file by the report printer.

Operation: Select the resetting operation "E.JOURNAL" in X1/Z1 mode.

The filter function (consecutive no./date/clerk code) can not be used (always "ALL").

■ Data clear

Use the following procedure to perform the data clear operation.

Procedure

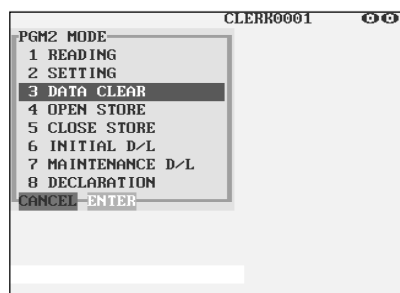

1. In the PGM2 MODE window, select "3 DATA CLEAR".
 - The DATA CLEAR window will appear.

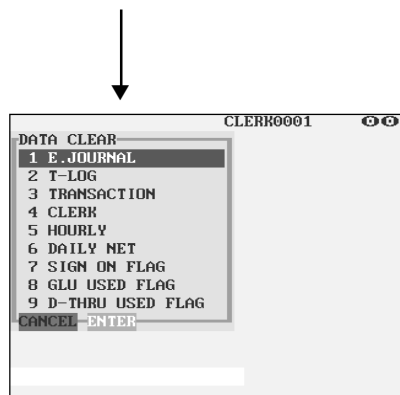

2. Select the pertinent operation.

16

EURO Migration Function

Basically your POS terminal can be automatically modified to correspond to the introduction of EURO by executing the operation "EURO STATUS" in X2/Z2 mode. However, there are several options you must set depending on your need. So, please carefully conduct necessary settings.
For details, contact your authorized SHARP dealer.

EURO status:

You can select status from following 4 types ((A), (B), (C), or (D)). And the selectable type is decided as follows for each status. Type (A) is the base status (initial status).

From type (A) — selectable —> Type (B), (C), or (D)
 From type (B) — selectable —> Type (C), (D)
 From type (C) — selectable —> Type (D)

Items	Type (B)	Type (C)	Type (D)
General Z1 report	ISSUE	ISSUE	ISSUE
General Z2 report	ISSUE	ISSUE	ISSUE
GT1/GT2/GT3 memory	—	CLEAR	CLEAR
Exchange1 amount printing for total and change	YES	YES	NO
Exchange1 amount printing for total validation print	YES	YES	NO
Exchange1 calculation method	DIVISION	MULTI	MULTI
Domestic currency symbol	—	[EURO]	[EURO]
Domestic TAB	—	2	2
Exchange1 currency descriptor	[EURO]	The current domestic currency symbol	—
Exchanger1 TAB	2	The current domestic TAB	—

The marked items "—" is remaining the current data.

Procedure

Select X2/Z2 mode → 6 EURO STATUS → [LIST] → Select B, C, or D → [ENTER]

NOTE

It is executed some of following jobs which is needed for each status.

- (1) Issue general Z1 report.
- (2) Issue general Z2 report.
- (3) Clear GT1/GT2/GT3.
- (4) Change PGM function "Total and change amount printing — With foreign/Domestic only".
- (5) Change PGM function "Exchange1 amount printing for total validation print — YES/NO" and "Total validation print amount printing — With foreign/Domestic only".
- (6) Change PGM function "Exchange1 calculation method — Division/Multiplication".
- (7) Set "Domestic currency symbol" as EURO symbol.
- (8) Set "Domestic TAB" as 2.
- (9) Set "Exchange1 currency descriptor" as the suitable data.
- (10) Set "Exchange1 TAB as the suitable

NOTE

This job cannot set below additional EURO function. Below items must be set by each PGM job after this job.

- (1) Exchange1 rate, (2) "Check, Credit operation for Exchange1 — YES/NO"

17

Operator Maintenance

Replacing the Backup Battery Pack

The memory backup battery pack has an expected life of approximately three years under normal conditions (temperature extremes can shorten the life of the battery). Replace the memory backup battery pack every three years.

The battery pack is not available on the market, so please contact your dealer and ask him or her for replacement when you need a new one. Be sure to use a battery pack specified by SHARP.

Use of other battery packs could damage your POS terminal.

Caution : When you replace the battery pack, keep the POS terminal turned on. If you replace the battery pack with the power switch off, all the data in memory will be lost.

1. Remove the screw in front of the battery compartment cover located at the bottom of the terminal and slide the cover in the direction of the arrow to detach it.

Battery compartment cover

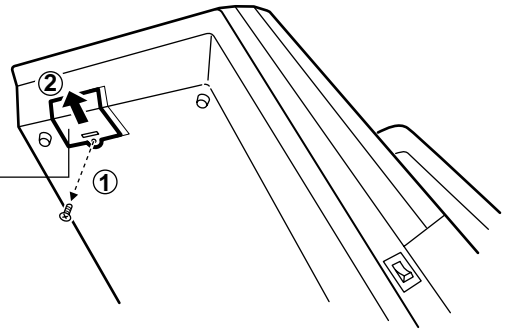

2. Take out the battery pack.

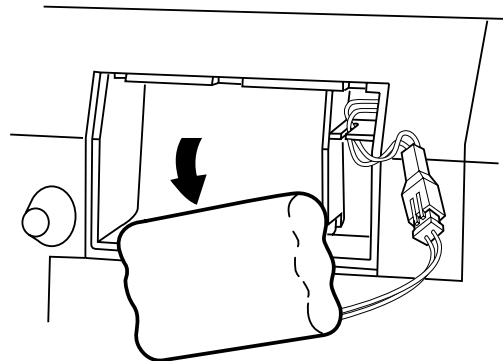

3. Disconnect the connector.

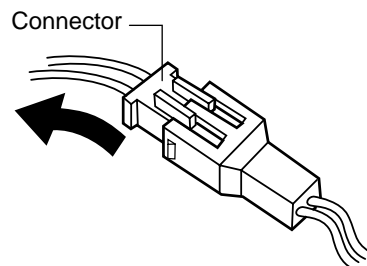

4. Connect the connector of a new battery pack.

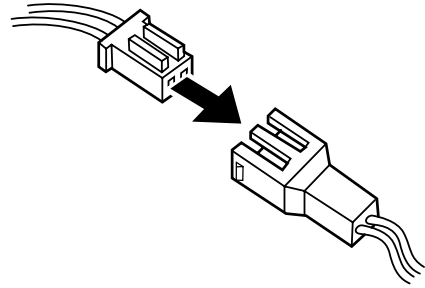

5. Install the pack, placing the wires in the slit as shown in the figure at right.

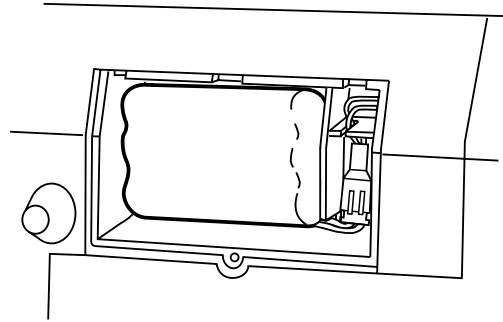

6. Replace the battery compartment cover, and tighten the screw removed earlier in step 1.

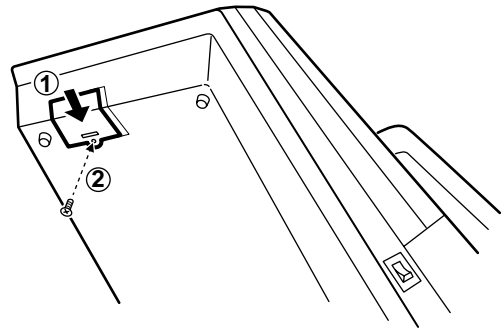

In Case of Power Failure

When power is lost, the POS terminal retains its memory contents and all information on sales entries.

- When power failure is encountered in POS terminal idle state or during an entry, the POS terminal returns to the normal state of operation after power recovery.

Before Calling for Service

The malfunctions shown in the left-hand column below, labeled "Fault," do not necessarily indicate functional faults of the machine. It is therefore advisable to refer to the "Checking" shown in the right-hand column before calling for service.

Fault	Checking
<ul style="list-style-type: none">• The display does not illuminate.	<ul style="list-style-type: none">• Is power supplied to the electric outlet?• Is the power cord plug out or loosely connected to the electrical outlet?• Is the power switch in the "ON" position?• Are the brightness control and the contrast control adjusted correctly?• Is the terminal in screen-save mode?
<ul style="list-style-type: none">• The display is illuminated, but the whole machine refuses entries.	<ul style="list-style-type: none">• See the printer manual.
<ul style="list-style-type: none">• No receipt is issued.	<ul style="list-style-type: none">• See the printer manual.
<ul style="list-style-type: none">• No journal paper is taken up.	
<ul style="list-style-type: none">• Printing is unusual.	

List of Options

For your UP-3300 POS terminal, the following options are available:

For details, contact your authorized SHARP dealer. Do not try to install any options yourself.

1. RAM memory board model UP-P02MB2
2. External printer model ER-01PU
3. Remote printer model ER-03RP or ER-04RP
4. Slip printer model ER-FBP40
5. Remote drawer model ER-03DW or ER-04DW or ER-05DW
6. Remote coin case model ER-48CC3, ER-48CC2 or ER-58CC
7. Remote coin case cover model ER-02CV1-5, 01CV1-5 or ER-03CV
8. Magnetic card reader model UP-E12MR2
9. Built-in printer model UP-T80BP
10. Remote display model UP-P16DP (Pole type)
11. EFT terminal I/F model ER-02EF
12. Two-port RS-232 interface model ER-A7RS

19

Specifications

Model:	UP-3300	
External dimensions:	295(W) x 414.5(D) x 320(H) mm	
Weight:	6.5 kg	
Power source:	Official (nominal) voltage and frequency	
Power consumption:	Stand-by:	42W
	Operating:	59W (max.)
Working temperatures:	0 to 40 °C	
Electronics:	LSI (CPU) etc.	
Built-in battery:	Rechargeable battery pack, memory holding time of about 1 month (with fully charged built-in battery pack, at room temperature)	
Display:	Operator display:	Color LCD module and Touch panel 640(W) x 480(H) (dots)
Accessories:	Instruction manual	1 copy
	Instruction manual for inline system	1 copy
	Clerk keys (for 6 clerks)	12 (2 keys for each clerk)
	Ferrite cores	2

* Specifications and appearance subject to change without notice for improvement.

SHARP[®]
SHARP CORPORATION

Free Manuals Download Website

<http://myh66.com>

<http://usermanuals.us>

<http://www.somanuals.com>

<http://www.4manuals.cc>

<http://www.manual-lib.com>

<http://www.404manual.com>

<http://www.luxmanual.com>

<http://aubethermostatmanual.com>

Golf course search by state

<http://golfingnear.com>

Email search by domain

<http://emailbydomain.com>

Auto manuals search

<http://auto.somanuals.com>

TV manuals search

<http://tv.somanuals.com>