

SHARP



1-BIT DIGITAL HOME THEATER WITH DVD PLAYER

MODEL

SD-AS10

OPERATION MANUAL

Thank you for purchasing this SHARP product. To obtain the best performance from this product, please read this manual carefully. It will guide you in operating your SHARP product.

SD-AS10 1-Bit Digital Home Theater with DVD Player consisting of SD-AS10 (main unit and amplifier unit), CP-AS10F (front speakers), CP-AS10C (center speaker), CP-AS10R (surround speakers) and CP-AS10W (subwoofer).



MP3



SPECIAL NOTES



CAUTION
RISK OF ELECTRIC SHOCK
DO NOT OPEN



CAUTION: TO REDUCE THE RISK OF ELECTRIC SHOCK, DO NOT REMOVE COVER (OR BACK). NO USER-SERVICEABLE PARTS INSIDE. REFER SERVICING TO QUALIFIED SERVICE PERSONNEL.

Explanation of Graphical Symbols:



The lightning flash with arrowhead symbol, within an equilateral triangle, is intended to alert the user to the presence of uninsulated "dangerous voltage" within the product's enclosure that may be of sufficient magnitude to constitute a risk of electric shock to persons.



The exclamation point within an equilateral triangle is intended to alert the user to the presence of important operating and maintenance (servicing) instructions in the literature accompanying the appliance.

0010

WARNING: TO REDUCE THE RISK OF FIRE OR ELECTRIC SHOCK, DO NOT EXPOSE THIS APPLIANCE TO RAIN OR MOISTURE.

0010

Note to CATV system installer:

This reminder is provided to call the CATV system installer's attention to Article 820-40 of the National Electrical Code that provides guidelines for proper grounding and, in particular, specifies that the cable ground shall be connected to the grounding system of the building, as close to the point of cable entry as practical.

NOTE

This equipment has been tested and found to comply with the limits for a Class B digital device, pursuant to Part 15 of the FCC Rules. These limits are designed to provide reasonable protection against harmful interference in a residential installation. This equipment generates, uses, and can radiate radio frequency energy and, if not installed and used in accordance with the instructions, may cause harmful interference to radio communications. However, there is no guarantee that interference will not occur in a particular installation. If this equipment does cause harmful interference to radio or television reception, which can be determined by turning the equipment off and on, the user is encouraged to try to correct the interference by one or more of the following measures:

- Reorient or relocate the receiving antenna.
- Increase the separation between the equipment and receiver.
- Connect the equipment into an outlet on a circuit different from that to which the receiver is connected.
- Consult the dealer or an experienced radio/TV technician for help.

WARNING

FCC Regulations state that any unauthorized changes or modifications to this equipment not expressly approved by the manufacturer could void the user's authority to operate this equipment.

CAUTION:

THIS PRODUCT IS A CLASS 1 LASER PRODUCT. USE OF CONTROLS OR ADJUSTMENTS OR PERFORMANCE OF PROCEDURES OTHER THAN THOSE SPECIFIED HEREIN MAY RESULT IN HAZARDOUS RADIATION EXPOSURE. AS THE LASER BEAM USED IN THIS PRODUCT IS HARMFUL TO THE EYES, DO NOT ATTEMPT TO DISASSEMBLE THE CABINET. REFER SERVICING TO QUALIFIED PERSONNEL ONLY.

0207

FOR YOUR RECORDS

For your assistance in reporting this unit in case of loss or theft, please record below the model number and serial number which are located on the bottom of the amplifier unit. Please retain this information.

Model number

Serial number

Date of purchase

Place of purchase

0407

IMPORTANT SAFETY INSTRUCTIONS

SD-AS10

- 1 Read Instructions** - All the safety and operating instructions should be read before the product is operated.
- 2 Retain Instructions** - The safety and operating instructions should be retained for future reference.
- 3 Heed Warnings** - All warnings on the product and in the operating instructions should be adhered to.
- 4 Follow Instructions** - All operating and use instructions should be followed.
- 5 Cleaning** - Unplug this product from the wall outlet before cleaning. Do not use liquid cleaners or aerosol cleaners. Use a damp cloth for cleaning.
- 6 Attachments** - Do not use attachments not recommended by the product manufacturer as they may cause hazards.
- 7 Water and Moisture** - Do not use this product near water - for example, near a bath tub, wash bowl, kitchen sink, or laundry tub; in a wet basement; or near a swimming pool; and the like.
- 8 Accessories** - Do not place this product on an unstable cart, stand, tripod, bracket, or table. The product may fall, causing serious injury to a child or adult, and serious damage to the product. Use only with a cart, stand, tripod, bracket, or table recommended by the manufacturer, or sold with the product. Any mounting of the product should follow the manufacturer's instructions, and should use a mounting accessory recommended by the manufacturer.
- 9** A product and cart combination should be moved with care. Quick stops, excessive force, and uneven surfaces may cause the product and cart combination to overturn.



- 10 Ventilation** - Slots and openings in the cabinet are provided for ventilation and to ensure reliable operation of the product and to protect it from overheating, and these openings must not be blocked or covered. The openings should never be blocked by placing the product on a bed, sofa, rug, or other similar surface. This product should not be placed in a built-in installation such as a bookcase or rack unless proper ventilation is provided or the manufacturer's instructions have been adhered to.
- 11 Power Sources** - This product should be operated only from the type of power source indicated on the marking label. If you are not sure of the type of power supply to your home, consult your product dealer or local power company. For products intended to operate from battery power, or other sources, refer to the operating instructions.
- 12 Grounding or Polarization** - This product may be equipped with a polarized alternating-current line plug (a plug having one blade wider than the other). This plug will fit into the power outlet only one way. This is a safety feature. If you are unable to insert the plug fully into the outlet, try reversing the plug. If the plug should still fail to fit, contact your electrician to replace your obsolete outlet. Do not defeat the safety purpose of the polarized plug.
Alternate Warnings - This product is equipped with a three-wire grounding-type plug, a plug having a third (grounding) pin. This plug will only fit into a grounding-type power outlet. This is a safety feature. If you are unable to insert the plug into the outlet, contact your electrician to replace your obsolete outlet. Do not defeat the safety purpose of the grounding-type plug.
- 13 Power-Cord Protection** - Power-supply cords should be routed so that they are not likely to be walked on or pinched by items placed upon or against them, paying particular attention to cords at plugs, convenience receptacles, and the point where they exit from the product.
- 14 Protective Attachment Plug** - The product is equipped with an attachment plug having overload protection. This is a safety feature. See Instruction Manual for replacement or resetting of protective device. If replacement of the plug is required, be sure the service technician has used a replacement plug specified by the manufacturer that has the same overload protection as the original plug.

0109

IMPORTANT SAFETY INSTRUCTIONS (continued)

- 15 Outdoor Antenna Grounding** - If an outside antenna or cable system is connected to the product, be sure the antenna or cable system is grounded so as to provide some protection against voltage surges and built-up static charges. Article 810 of the National Electrical Code, ANSI/NFPA 70, provides information with regard to proper grounding of the mast and supporting structure, grounding of the lead-in wire to an antenna discharge unit, size of grounding conductors, location of antenna-discharge unit, connection to grounding electrodes, and requirements for the grounding electrode.

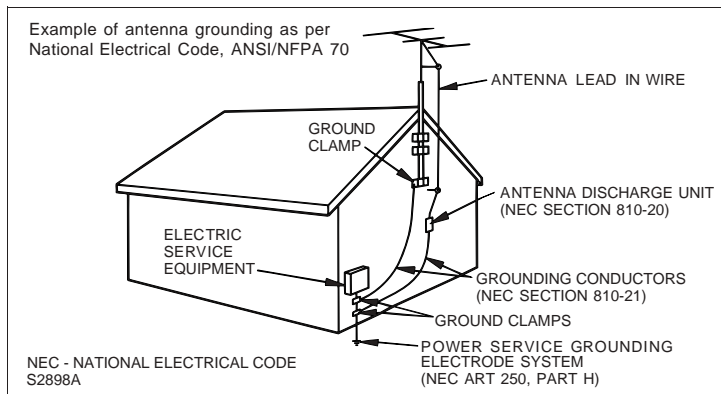

- 16 Lightning** - For added protection for this product during a lightning storm, or when it is left unattended and unused for long periods of time, unplug it from the wall outlet and disconnect the antenna or cable system. This will prevent damage to the product due to lightning and power-line surges.
- 17 Power Lines** - An outside antenna system should not be located in the vicinity of overhead power lines or other electric light or power circuits, or where it can fall into such power lines or circuits. When installing an outside antenna system, extreme care should be taken to keep from touching such power lines or circuits as contact with them might be fatal.
- 18 Overloading** - Do not overload wall outlets, extension cords, or integral convenience receptacles as this can result in a risk of fire or electric shock.

- 19 Object and Liquid Entry** - Never push objects of any kind into this product through openings as they may touch dangerous voltage points or short-out parts that could result in a fire or electric shock. Never spill liquid of any kind on the product.

- 20 Servicing** - Do not attempt to service this product yourself as opening or removing covers may expose you to dangerous voltage or other hazards. Refer all servicing to qualified service personnel.

- 21 Damage Requiring Service** - Unplug this product from the wall outlet and refer servicing to qualified service personnel under the following conditions:

- a) When the power-supply cord or plug is damaged,
- b) If liquid has been spilled, or objects have fallen into the product,
- c) If the product has been exposed to rain or water,
- d) If the product does not operate normally by following the operating instructions. Adjust only those controls that are covered by the operating instructions as an improper adjustment of other controls may result in damage and will often require extensive work by a qualified technician to restore the product to its normal operation,
- e) If the product has been dropped or damaged in any way, and
- f) When the product exhibits a distinct change in performance - this indicates a need for service.

- 22 Replacement Parts** - When replacement parts are required, be sure the service technician has used replacement parts specified by the manufacturer or have the same characteristics as the original part. Unauthorized substitutions may result in fire, electric shock, or other hazards.

- 23 Safety Check** - Upon completion of any service or repairs to this product, ask the service technician to perform safety checks to determine that the product is in proper operating condition.

- 24 Wall or Ceiling Mounting** - The product should be mounted to a wall or ceiling only as recommended by the manufacturer.

- 25 Heat** - The product should be situated away from heat sources such as radiators, heat registers, stoves, or other products (including amplifiers) that produce heat.

"DTS" and "DTS Digital Surround" are registered trademarks of Digital Theater Systems, Inc.

Manufactured under license from Dolby Laboratories. "Dolby", "Pro Logic" and the double-D symbol are trademarks of Dolby Laboratories.

NOTE

Licensed under one or more of U.S. Pat. 4,972,484, 5,214,678, 5,323,396, 5,530,655, 5,539,829, 5,544,247, 5,606,618, 5,610,985, 5,740,317, 5,777,992, 5,878,080 or 5,960,037.

0407

ENERGY STAR® Program Information

Products that have earned the ENERGY STAR® are designed to protect the environment through superior energy efficiency.







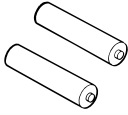
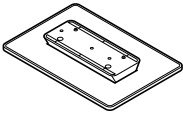

ENERGY STAR® is a U.S. registered mark.

0312

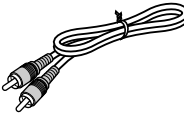
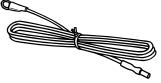
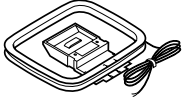
The letters in brackets contained in the model number indicate the color of the product only. Operation and specifications are unaffected.

Accessories

Please confirm that the following accessories are included.

 Remote control × 1 (RRMCGA020AWSA)	 "AA" size battery (UM/SUM-3, R6, HP-7 or similar) × 2 (UBATU0001AWZZ)	
 Main unit stand × 1 (92LSTD5880ASY1)	 System connection cable × 1 (QCNWGA012AWPZ)	 Video cable × 1 (QCNWGA013AWPZ)
 FM antenna × 1 (92LFANT1535A)	 AM loop antenna × 1 (QANTL0014AWZZ)	 Button name label × 1 (TLABHA006AWSA)
 Non-slip sheet for main unit × 4 (PCUSGA027AWZZ)	 White (for left front speaker) approx. 5 m (16 feet) Green (for center speaker) approx. 5 m (16 feet) Red (for right front speaker) approx. 5 m (16 feet)	
 Non-slip sheet for speakers × 20 (PCUSG0129AWSA)	 Purple (for subwoofer) approx. 5 m (16 feet) Blue (for left surround speaker) approx. 15 m (49 feet) Gray (for right surround speaker) approx. 15 m (49 feet) Speaker wire × 6 (QCNWHA006AWZZ)	

Note:





Only the above accessories are included.

Contents

	Page		Page
■ General Information		■ CD, CD-R and CD-RW Operation	
Precautions	7	Playing a CD	
Description of discs	8, 9	To start playback from the desired point (direct play)	33
Controls and indicators	10 - 13	<u>To play by specifying time (time search)</u>	<u>33</u>
		To play in the desired order (programmed play)	34
		To play in random order (random play)	34
■ Preparation for Use		MP3/WMA and JPEG disc operation	
<u>System installation</u>	<u>14</u>	Playback on the MP3/WMA and JPEG menu screen	35
Main unit preparation	15	To play in the desired order (programmed play)	36
System connections	16, 17	<u>Zoom function</u>	<u>37</u>
Antenna connection	17	Rotating a picture	37
Speaker connection	18		
TV connection	19		
AC power connection	20		
Remote control	20		
General control	21		
Setting the clock	21		
		■ Radio Operation	
		Listening to the radio	38, 39
		■ Advanced Features	
		Enjoying surround sound (sound mode)	40 - 42
		Changing the default settings of the amplifier	43 - 45
		Changing the initial setting of DVD	46 - 49
		Setting the timer	50, 51
		Operations after setting the timer	52
		Sleep timer	53
		Operating the connected TV	54, 55
		Connecting other equipment	56 - 58
		■ References	
		<u>Language code list</u>	<u>58</u>
		Error indicators and warnings	59
		Troubleshooting chart	60, 61
		Maintenance	62
		Optional accessories	62
		Specifications	62, 63
		CONSUMER LIMITED WARRANTY	Back cover
■ DVD Operation			
<u>Inserting and removing discs</u>			
Inserting a disc	22, 23		
<u>To remove the disc</u>	<u>23</u>		
To exchange other discs while playing a disc	23		
Playing a disc			
Playback	24, 25		
To resume playback after stopping (resume play)	25		
<u>Changing the progressive scan select mode</u>	<u>25</u>		
Basic operation			
Fast forward/Fast reverse (search)	26		
To locate the beginning of a chapter (track) (skip)	27		
To start playback from the desired point (direct play)	27		
<u>To play by specifying time (time search)</u>	<u>27</u>		
Useful operation			
To change the subtitle language	28		
To change the audio language (audio output)	28		
To select a title from the top menu of the disc	29		
To select a subtitle or audio language from the disc menu	29		
Still picture/Frame advance	29		
Slow-motion play	29		
To change the angle	30		
To zoom images (zoom)	30		
To play repeatedly (repeat play)	31		
To play the contents between the specified points repeatedly (A-B repeat) ..	31		
To change the display on TV screen	32		
<u>To change the display on the main unit</u>	<u>32</u>		

Icons used in this operation manual

Some functions may not be available depending on discs. The following icons indicate the discs that can be used in the section.

	... DVD-Video discs and DVD-R/DVD-RW for NTSC system.
	... Audio CDs.
	... CD-R/CD-RW with MP3 recording.
	... CD-R/CD-RW with WMA recording.
	... CD-R/CD-RW with JPEG recording.

Precautions

■ General

- Please ensure that the equipment is positioned in a well-ventilated area and that there is at least 4" (10 cm) of free space along the sides and back. There must also be a minimum of 6" (15 cm) of free space on the top of the unit.

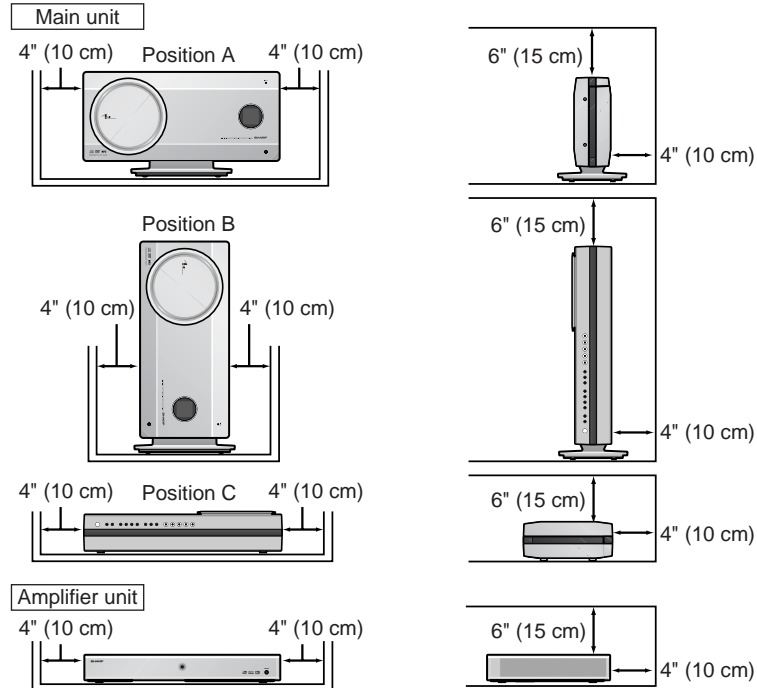

- Use the unit on a firm, level surface free from vibration.
- Keep the unit away from direct sunlight, strong magnetic fields, excessive dust, humidity and electronic/electrical equipment (home computers, facsimiles, etc.) which generate electrical noise.

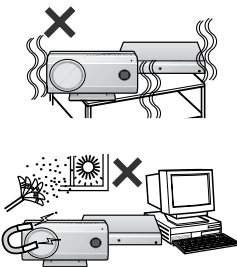

- Do not place anything on top of the unit.
- Do not expose the unit to moisture, to temperatures higher than 140°F (60°C) or to extremely low temperatures.
- If the unit does not work properly, unplug and plug it in again. Then turn on the unit.
- In case of an electrical storm, unplug the unit for safety.
- Hold the AC power plug by the head when removing it from the AC outlet, as pulling the cord can damage internal wires.
- Do not remove the outer cover, as this may result in electric shock. Refer internal service to your local SHARP service facility.
- This unit should only be used within the range of 41°F - 95°F (5°C - 35°C).

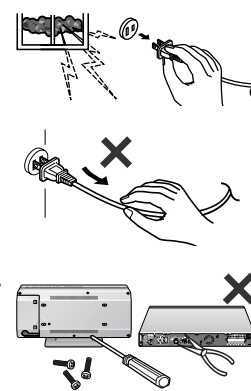

Warning:

The voltage used must be the same as that specified by this unit. Using this product with a higher voltage other than that specified is dangerous and may result in a fire or other types of accident, causing damage. SHARP will not be held responsible for any damage resulting from the use of this unit with a voltage other than that specified.

Cooling fan

This amplifier unit is fitted with a cooling fan at the rear for improved cooling. Do not cover the opening in this section with any obstacles.

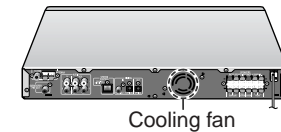

Caution:

- The amplifier unit will get warm while being used. Do not touch the warm areas of the amplifier unit for prolonged periods to avoid damage to you.
- This amplifier unit contains an automatic protection circuit, which protects the amplifier unit from being damaged. All speaker outputs are muted when this circuit is activated. Should the unit stop operating, first check the speaker terminals for shorted wires, then press the POWER button to turn on the main unit.



■ Volume control

The sound level at a given volume setting depends on speaker efficiency, location and various other factors. It is advisable to avoid exposure to high volume levels, which occurs while turning the unit on with the volume control setting up high, or while continually listening at high volumes.



Description of discs

Types of playable discs

The unit can play back discs bearing any of the following marks:

DVD		
DVD-Video Disc for NTSC system	DVD-R for NTSC system	DVD-RW for NTSC system
	 Recorded in the video mode (*)	 Recorded in the video mode (*) Discs recorded in VR mode (Video Recording format) cannot be played back.

Some DVD discs may not function as described in the manual. See the disc jacket for restrictions.

CD		
Audio CD	Audio CD-R	Audio CD-RW
	 Or CD-R recorded in MP3/WMA/JPEG format (*)	 Or CD-RW recorded in MP3/WMA/JPEG format (*)

(*) Some discs may not play properly due to the status of the equipment used for recording, characteristics of the discs, scratches, dirt, or dirty optical pickup lens.

DVD-Video

A popular type of DVD disc of the same size as a CD, mainly containing video images.

Region number

DVD discs are programmed with region numbers indicating countries in which they can be played. This system can play discs with region number "1" or "ALL".



Title and chapter

DVD-Video discs are divided into "titles" and "chapters". If the disc has more than one movie on it, each movie is a separate "title". "Chapters" are subdivisions of titles.

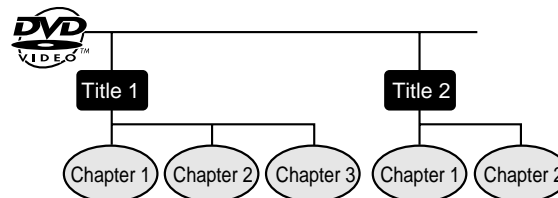

DVD-R/DVD-RW playback

- You can play DVD-R and DVD-RW discs recorded in the video mode.
- Before playing DVD-R/DVD-RW discs with this unit, finalize them with the equipment used for recording.

CD

Track

The audio CD is composed of "tracks". Tracks are equivalent to songs on a CD.

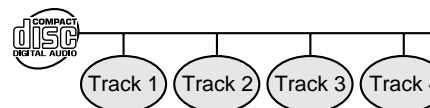

■ MP3/WMA/JPEG format on CD-R/CD-RW

An MP3 file is an audio data compressed in the MPEG 1 audio layer 3 format. MP3 files have the extension ".mp3". (Files with the extension ".mp3" may not play, or noise may occur during playback if not recorded in the MP3 format.)

WMA is an audio file format developed by Microsoft with the ".wma" extension. This type of audio file is recorded through Microsoft Windows operating system.

A JPEG file is still image data compressed in the JPEG (Joint Photographic Experts Group) format. JPEG files have the extension ".jpg".

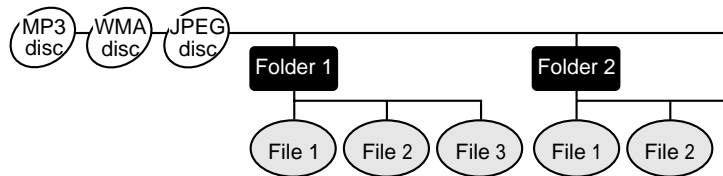

Folder and file

MP3/WMA/JPEG discs consist of "folders" and "files".



■ Icons used on DVD discs

Check the icons on the DVD jacket before playing your discs.

Display	Description
<p>Format recorded on the DVD</p> <p>4:3 16:9 LB 16:9 PS</p>	To adapt the video format to the connected TVs ("wide-screen TV" or "4:3 size TV").
<p>Type of subtitles recorded</p> <p>Example:  1: English 2: Japanese</p>	Recorded subtitle languages. You can select a subtitle language.
<p>Number of camera angles</p> <p></p>	Number of angles recorded on the DVD. You can view scenes from different angles.
<p>Number of audio tracks and audio recording systems</p> <p>Example:  1: Original <English> (Dolby Digital 5.1 Surround) 2: Japanese (Dolby Digital 2 ch)</p>	The number of audio tracks and audio recording systems are indicated. <ul style="list-style-type: none"> You can change the audio language. Audio and recording system vary depending on the DVD. Check them in the DVD's manual.

■ Discs that cannot be played

- DVDs without the region number "1" or "ALL"
 - DVDs with PAL system
 - DVDs with SECAM system
 - DVDs with MPEG sound
 - DVD-ROM
 - DVD-RAM
 - DVD-Audio
 - SACD
 - CDG
 - Video CD
 - Photo CD
 - CD-ROM
 - Discs recorded in special formats, etc.
- The discs above cannot be played at all, or no sound is heard although images appear on the screen or vice versa.
 - Faulty playback may damage the speakers and can have an adverse effect on your hearing when played at high volume settings.
 - This DVD player adopts the NTSC system. Discs that were made in foreign countries may not be played back. Check the recording system before purchasing discs.**
 - You cannot play illegally produced discs.

Copyright Information:

- Unauthorized copying, broadcast, public display, transmission, public performance and rental (regardless of whether or not such activities are for profit) of disc contents are prohibited by law.
- This system is equipped with copy protection technology that causes substantial degradation of images when the contents of a disc are copied to a video tape.

Copy Protection:

This unit supports Macrovision copy protection.

On DVD discs that include a copy protection code, if the contents of the DVD disc are copied using a VCR, the copy protection code prevents the videotape copy from playing normally.

Apparatus Claims of U.S. Patent Nos. 4,631,603, 4,577,216, 4,819,098 and 4,907,093 licensed for limited viewing uses only.

This product incorporates copyright protection technology that is protected by method claims of certain U.S. patents and other intellectual property rights owned by Macrovision Corporation and other rights owners. Use of this copyright protection technology must be authorized by Macrovision Corporation, and is intended for home and other limited viewing uses only unless otherwise authorized by Macrovision Corporation. Reverse engineering or disassembly is prohibited.

0407

Controls and indicators

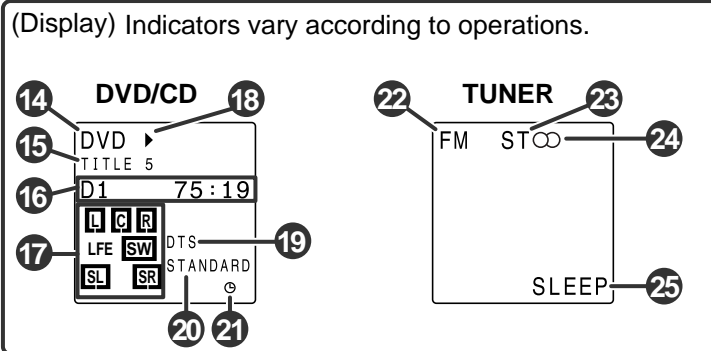
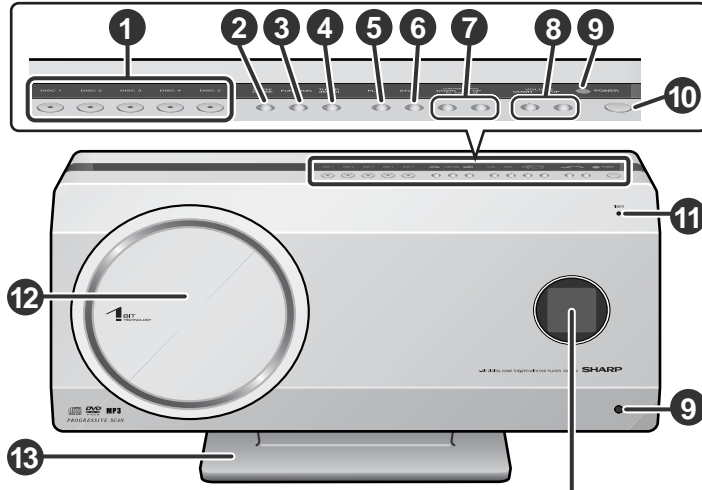

(Right side)

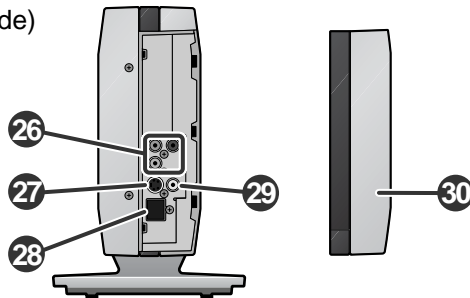

■ Main unit

	Reference page
1. Disc Number Select Buttons	22, 24, 34, 61
2. Disc Compartment Open/Close Button	<u>22</u>
3. Function Button	56
4. Tuner (Band) Button	38
5. Play Button	24
6. Stop Button	<u>22, 25, 57, 61</u>
7. Chapter (Track) Skip Up and Down, Search or Tuning Up and Down buttons 26, 27, 38	
8. Volume Up and Down Buttons	21
9. Remote Sensor	20
10. Power Button	20, 61
11. Timer Set Indicator	51
12. Disc Compartment	<u>22</u>
13. Main Unit Stand	15
<hr/>	
14. Function Indicator	<u>32</u>
15. Track, Title, Chapter, Total Information Indicator	<u>32</u>
16. Time and Present Disc Indicator	<u>32</u>
17. Speaker Indicators	42
18. Operation Indicator	<u>32</u>
19. Audio Signal Indicator	42
20. Surround Indicator	<u>32</u>
21. Timer Indicator	<u>52</u>
<hr/>	
22. Tuner (Band) Indicator	<u>38</u>
23. FM Stereo Mode Indicator	38
24. FM Stereo Receiving Indicator	38
25. Sleep Indicator	53
<hr/>	
26. Component Video Output Jacks	19
27. S-video Output Jack	19
28. System Connection Jack (to amplifier unit)	<u>17</u>
29. Video Output Jack	19
30. Side Cover	<u>19</u>

Notes:

- Make sure to attach the main unit stand (see page 15).
- How to open side cover (see page 17).

■ Amplifier unit

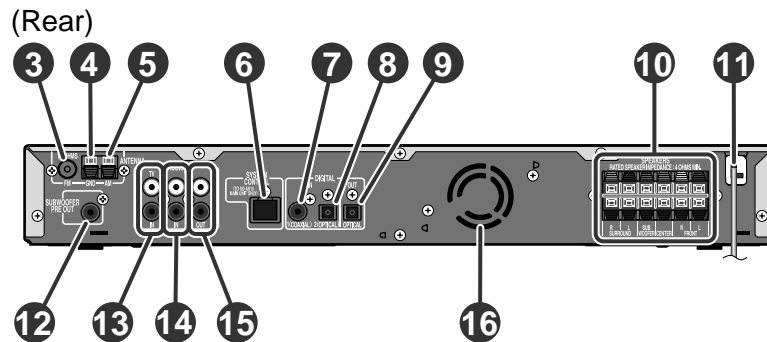
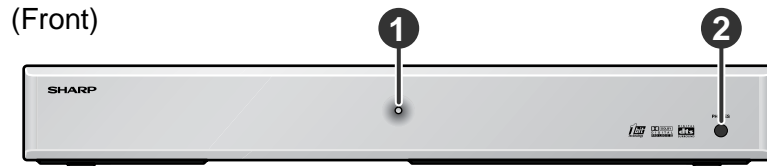

	Reference page
1. Power Indicator	20
2. Headphone Jack	58
3. FM 75 Ohm Antenna Jack	17
4. AM Antenna Ground Terminal	17
5. AM Antenna Terminal	17
6. System Connection Jack (to main unit)	17
7. Coaxial Digital Audio Input Jack	57
8. Optical Digital Audio Input Jack	56
9. Optical Digital Audio Output Jack	57
10. Speaker Terminals	18
11. AC Power Cord	20
12. Subwoofer Pre Output Jack	58
<i>(Connect a commercially available subwoofer with a built-in amplifier.)</i>	
13. TV Audio Input Jacks	56
14. VCR Audio Input Jacks	56
15. VCR Audio Output Jacks	56
16. Cooling Fan	7

■ Front/Surround speakers

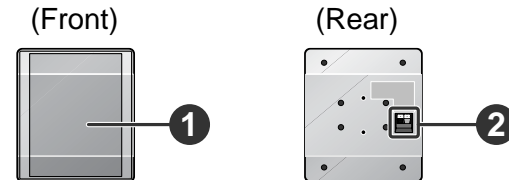

Reference page

1. Speaker	
2. Speaker Terminals	18

■ Center speaker

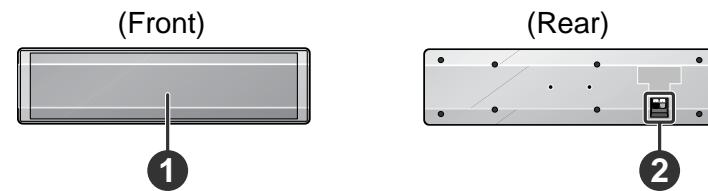

Reference page

1. Speaker	
2. Speaker Terminals	18

■ Subwoofer

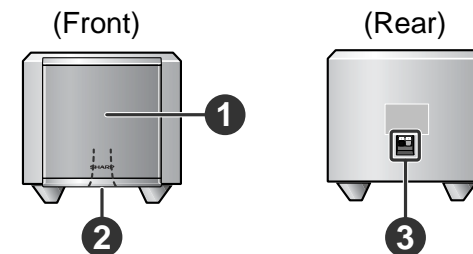

Reference page

1. Woofer	
2. Bass Reflex Duct	
3. Speaker Terminals	18

Controls and indicators (continued)

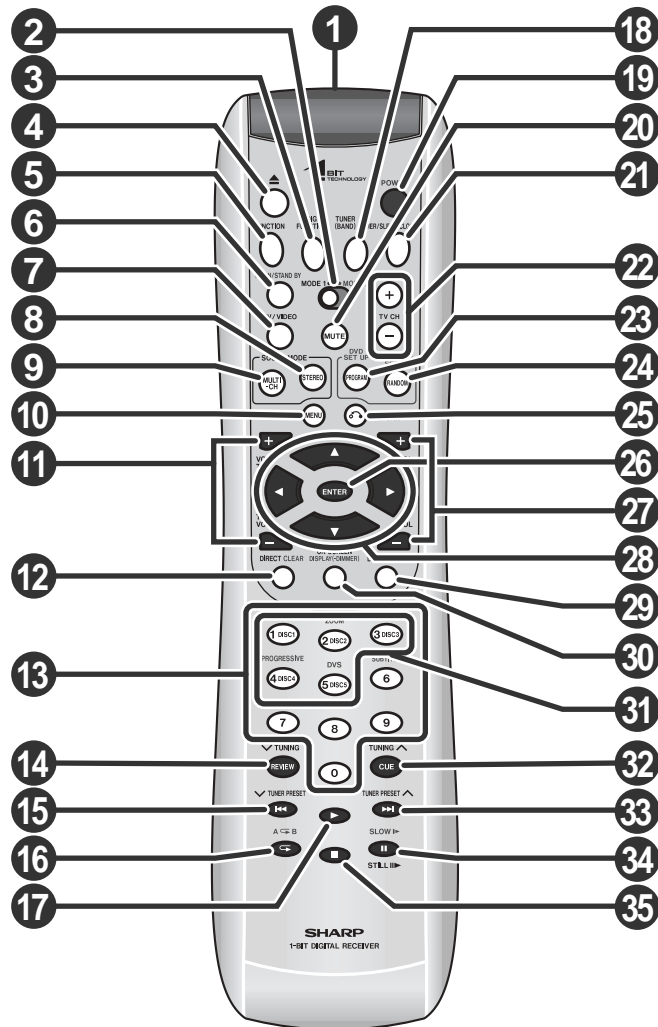

■ Remote control

Set the MODE 1/MODE 2 switch to MODE 1 and press the following buttons.

	Reference page
1. Remote Control Transmitter	.20
2. MODE 1/MODE 2 Switch	.13
3. Function Select Button (DIG1/DIG2)	.56
4. Disc Compartment Open/Close Button	.22
5. Function Select Button (VCR/TV)	.56
6. TV On/Stand-by Button	.54
7. TV/Video Select Button	.54
8. Stereo (2 channel) Select Button	.41
9. Multi Channel Select Button	.40
10. Menu Button	.29
11. TV Volume Up and Down Buttons	.54
12. Direct Select Button	.27
13. Direct Number Buttons	.27
14. Review/Tuning Down Button	.26, 38
15. Chapter (track) Skip Down/Tuner Preset Down Button	.27, 39
16. Repeat Play Button	.31
17. Play Button	.24
18. Tuner (Band) Button	.38
19. Power Button	.20
20. Mute Button	.21
21. Timer/Sleep/Clock Button	.21, 51, 53
22. TV Channel Up and Down Buttons	.54
23. Program Button	.34
24. Random Play Button	.34
25. Return Button	.44
26. Enter Button	.21
27. Volume Up and Down Buttons	.21
28. Cursor Buttons	.21
29. Disc Select Button	.22
30. On Screen Button	.32
31. Disc Number Select Buttons	.22
32. Cue/Tuning Up Button	.26, 38
33. Chapter (Track) Skip Up/Tuner Preset Up Button	.27, 39
34. DVD Still Frame Advance/Disc Pause Button	.25, 29
35. Stop Button	.22, 25, 57

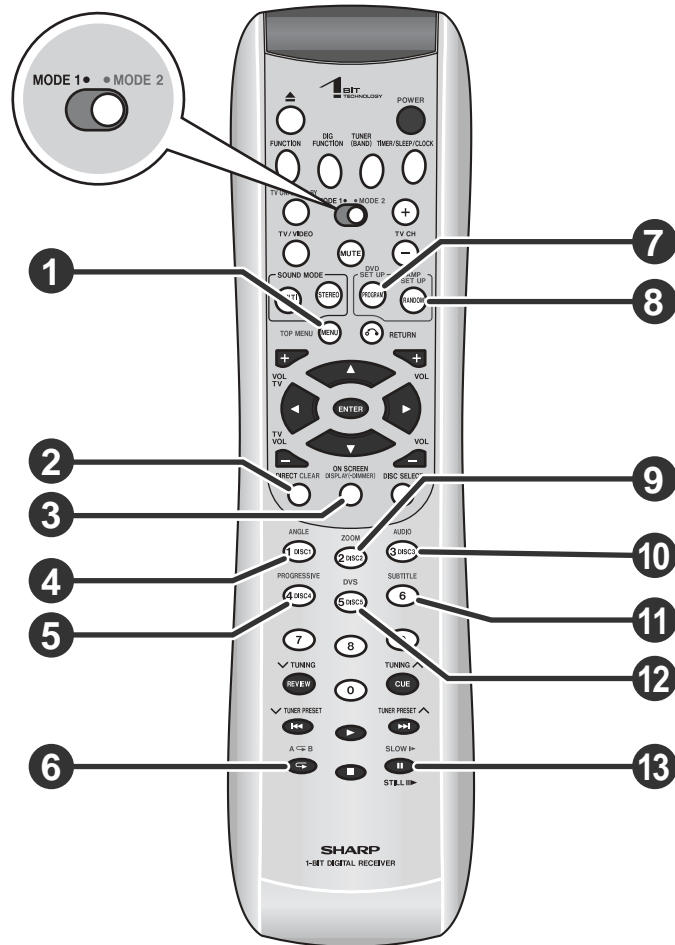

■ Remote control

Set the MODE 1/MODE 2 switch to MODE 2 and press the following buttons (indicated in blue). Available operations change.

	Reference page
1. DVD Top Menu Button	29
2. Clear Button	39
3. <u>Display (Dimmer) Button</u>	<u>21, 32</u>
4. DVD Angle Button	30
5. <u>Progressive Scan Mode Select Button</u>	<u>25</u>
6. A - B Repeat Button	31
7. DVD Setup Button	46
8. Amplifier Setup Button	44
9. DVD Zoom Button	30
10. <u>DVD Audio Language Select Button</u>	<u>28</u>
11. <u>DVD Subtitle Button</u>	<u>28</u>
12. Dolby Virtual Speaker button	41
13. DVD Slow Button	29

Note:

In "MODE 2", you can use buttons other than the above for the same operations as in "MODE 1".

System installation

Installation image (with optional accessories):

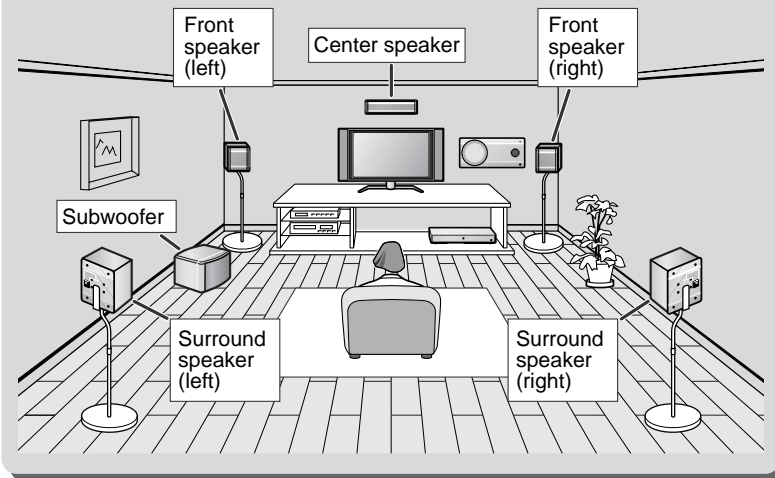

■ Magnetically shielded speakers

The front, surround and center speakers may be placed beside or near the TV as they are magnetically shielded. However, discoloration may occur depending on the TV type.

If color variation occurs...

Turn off the TV (with the power switch).
After 15 - 30 minutes, turn the TV on again.

If the color variation is still present...

Move the speakers further away from the TV.
Refer to the manual of the TV for details.

Note:

The subwoofer is not magnetically shielded.

■ Placing the speaker system

The best surround effect will be achieved by placing each speaker at the same distance from the listening position.
It is recommended to arrange the speakers as shown below.

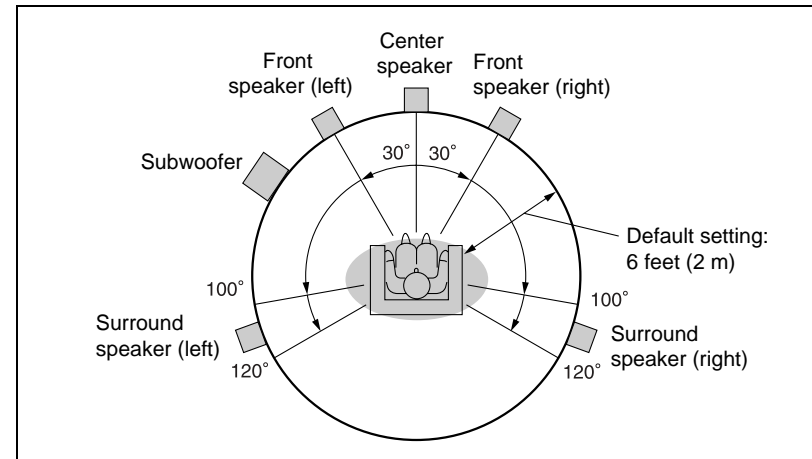

Notes:

- The default distance is set to 6 feet (2 m). If speakers cannot be placed at equal distances, refer to "Speaker delay setting" (see page 44).
- Place the TV halfway between the front speakers.
- It is recommended that the center speaker be placed near the television.
- Place the surround speakers at a position just above the height of your ears.
- You can place the subwoofer anywhere you like. As it vibrates while reproducing bass, place it on a stable, sturdy surface.

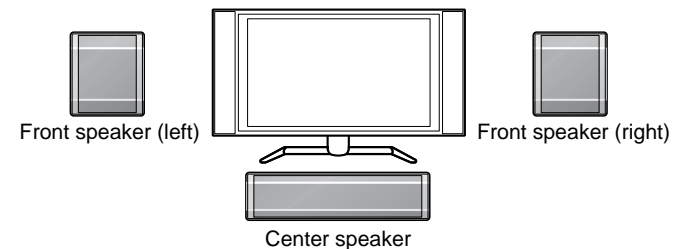

Main unit preparation

Select from three installation methods according to the location.

For position A or B, make sure to use the included main unit stand. Otherwise the unit may fall.

The display direction changes according to the installation direction.

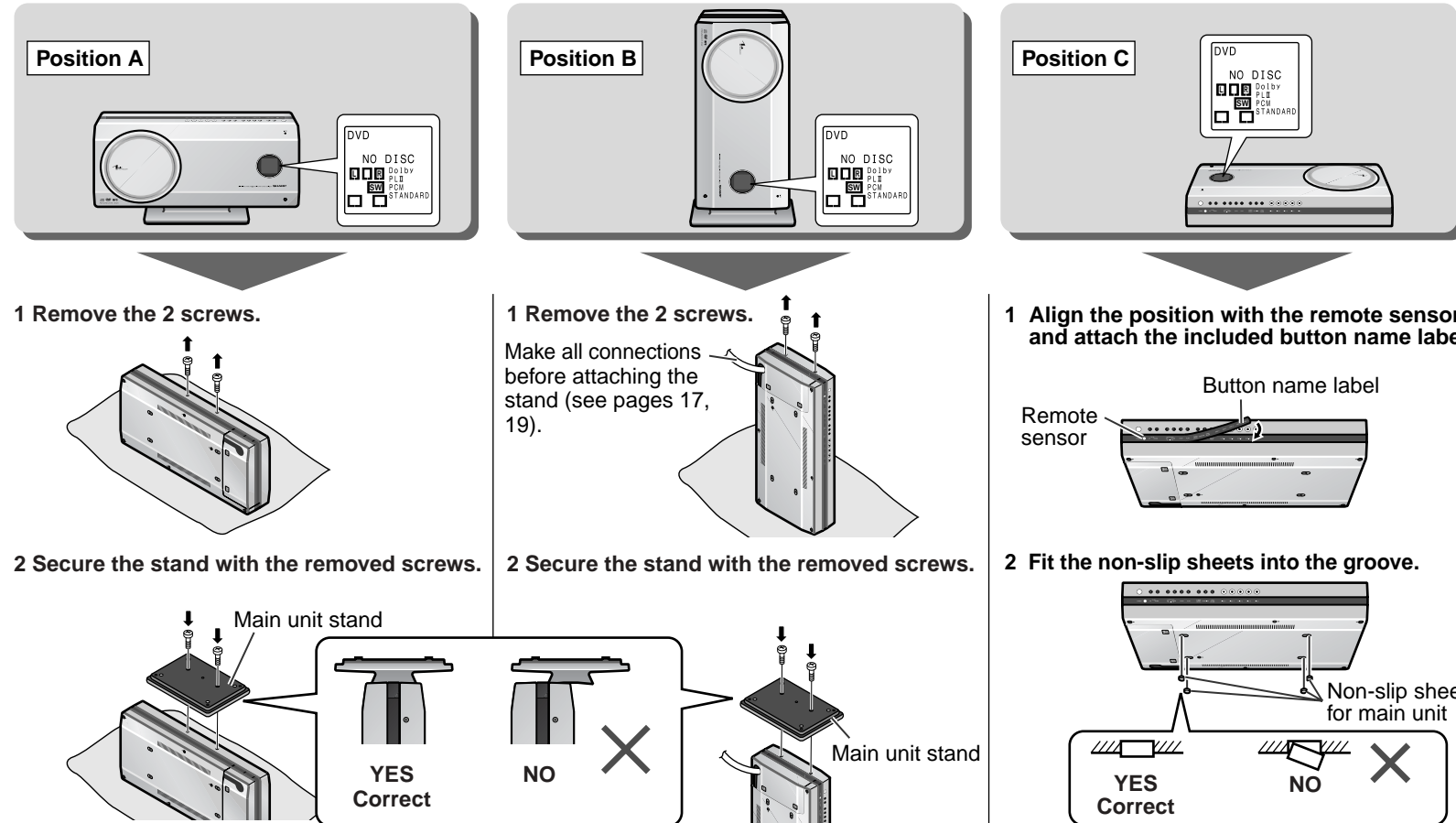

System connections

Make sure to unplug the AC power cord before making any connections.

TV connection (see page 19)

Connect a TV and main unit with the included video cable. If your TV is equipped with an S-video input jack or component video input jacks, purchase an appropriate cable to enjoy higher quality images.



TV

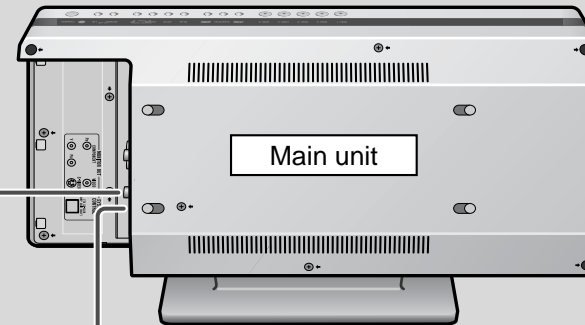

Main unit

Connecting the system connection cable (see page 17)

Antenna connection (see page 17)



FM antenna

AM loop antenna

Amplifier unit

Attaching the side cover (see page 19)

You can position cables differently by changing installation.

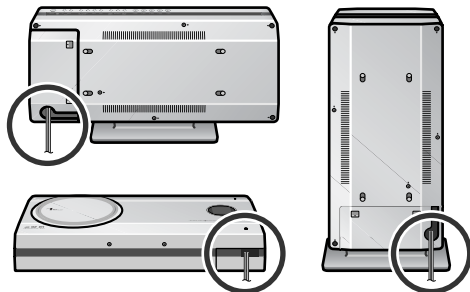

AC power connection (see page 20)

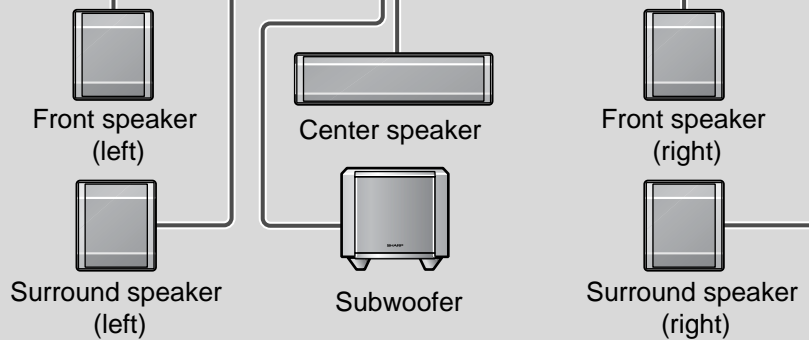

Front speaker (left)

Center speaker

Front speaker (right)

Surround speaker (left)

Subwoofer

Surround speaker (right)

Speaker connection (see page 18)

■ Connecting the system connection cable

Connect the main unit and amplifier unit as follows.

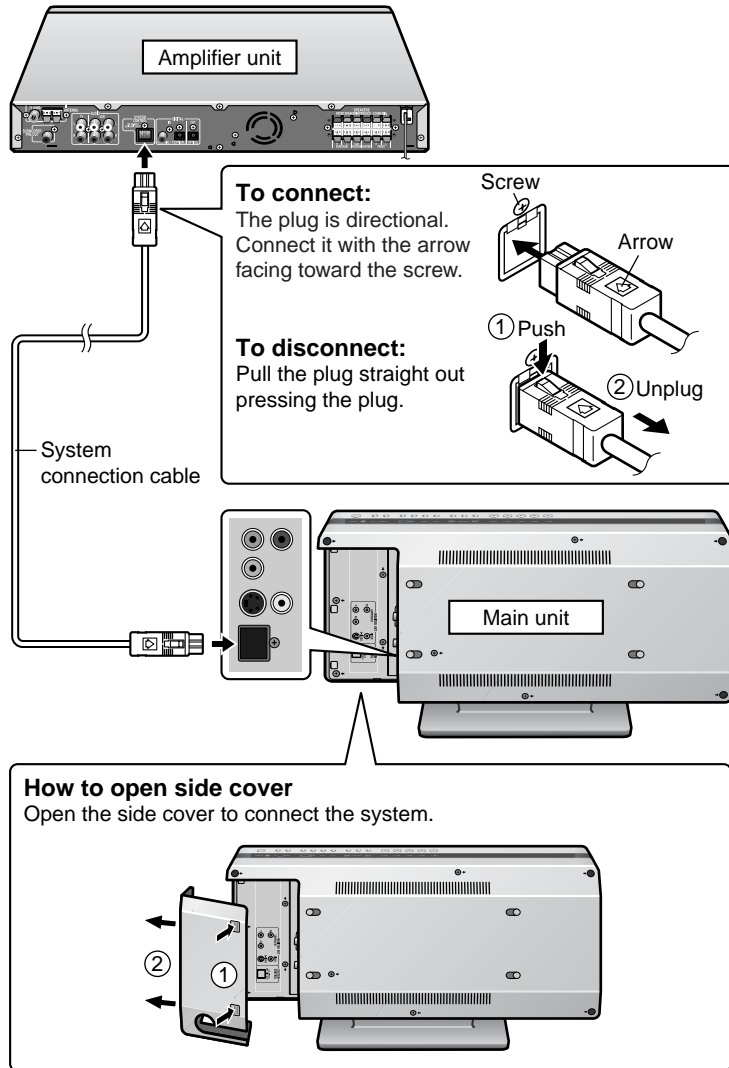

Antenna connection

Supplied FM antenna:

Connect the FM antenna wire to the FM 75 OHMS jack and position the FM antenna wire in the direction where the strongest signal can be received.

Supplied AM loop antenna:

Connect the AM loop antenna wire to the AM and GND terminals. Position the AM loop antenna for optimum reception. Place the AM loop antenna on a shelf, etc., or attach it to a stand or a wall with screws (not supplied).

Note:

Placing the antenna on the unit or near the AC power cord may cause noise pickup. Place the antenna away from the unit for better reception.

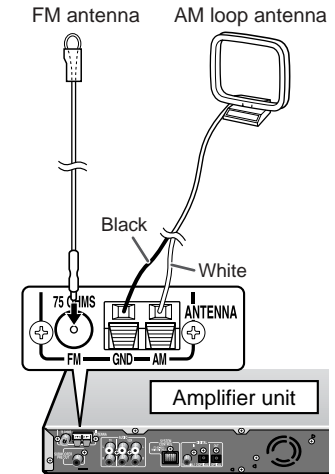

Installing the AM loop antenna:

< Assembling >

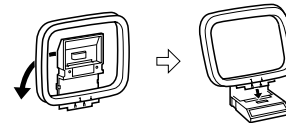

< Attaching to the wall >

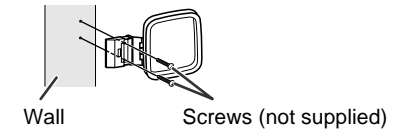

Outdoor FM or AM antenna:

Use an outdoor FM or AM antenna if you require better reception. Consult your dealer.

When using an outdoor AM antenna, be sure to keep the wire of the AM loop antenna connected.

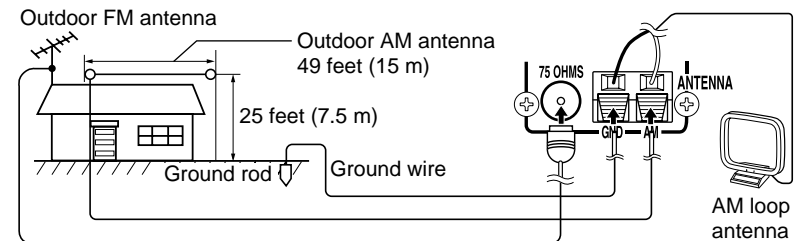

Speaker connection

Make sure to leave the AC power cord disconnected when connecting the speakers.

To prevent accidental short circuits between ⊕ and ⊖ terminals, connect the speaker wires to the speakers first and then to the unit.

Connect the speaker and the unit by matching the colors.

1 Connect the wires to the speakers.

Example :To connect the right surround speaker.

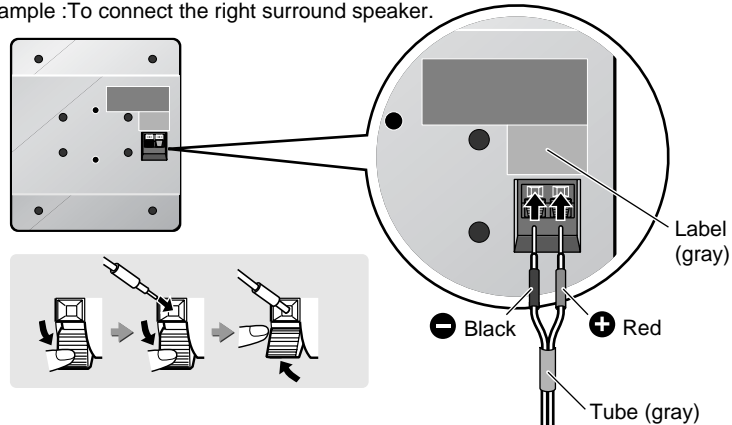

2 Connect the other end to the amplifier unit.

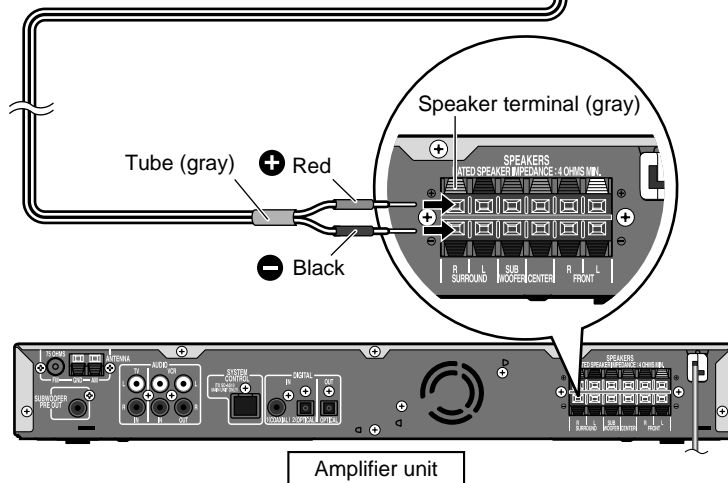

Amplifier unit

Caution:

- **The supplied speakers are designed exclusively for SD-AS10. Do not connect these speakers to other equipment. Also, do not connect other speakers to SD-AS10. It may cause malfunction.**
- Do not mistake the ⊕ and ⊖, and right and left terminals of the speaker wires. (The right speaker is placed on the right when you face the unit.)
- Do not let the bare speaker wires touch each other.
- Do not stand or sit on the speakers. You may be injured.
- **Do not short-circuit the speaker wire. If it happens with the power on, the protection circuit is activated and the unit is set to the power stand-by mode. In this case, check that the speaker wire is connected correctly before turning on the power again.**
- The speakers grilles are not removable.
- Do not allow any objects to fall into or to be placed in the bass reflex ducts.

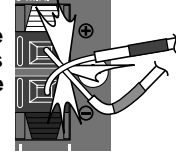

Incorrect

Non-slip sheet for speakers:

Attach the sheets to the bottom of the speaker to prevent it from sliding.

Front/Surround speakers

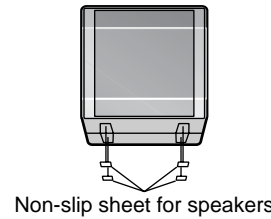

Center speaker

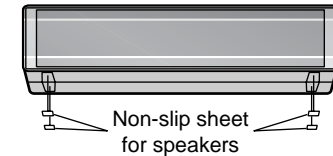

Non-slip sheet for speakers

TV connection

Three types of jacks (VIDEO OUT, S-VIDEO OUT and COMPONENT VIDEO OUT) are available for connection of a TV and this unit. Connect according to your TV.

Connect the optional S-video cable or component video cable for higher quality DVD images. For the component video cable, the progressive video mode is available and you can enjoy images with less flicker (default setting: PROGRESSIVE OFF). See page 25 for details.

Connecting to a TV with a video input jack

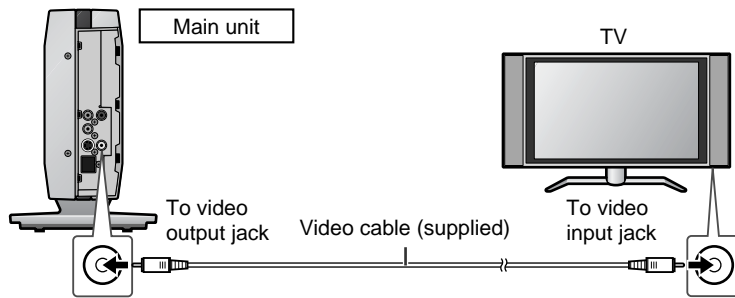

Connecting to a TV with an S-video input jack

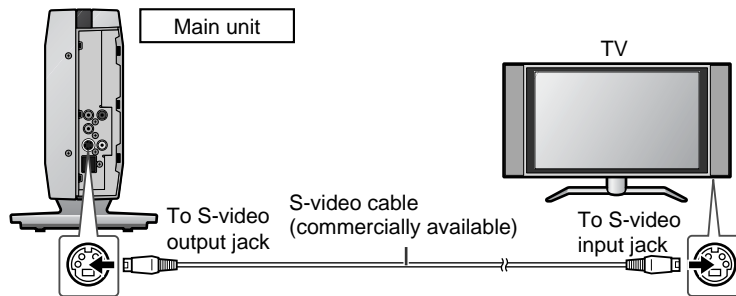

Connecting to a TV with component video input jacks

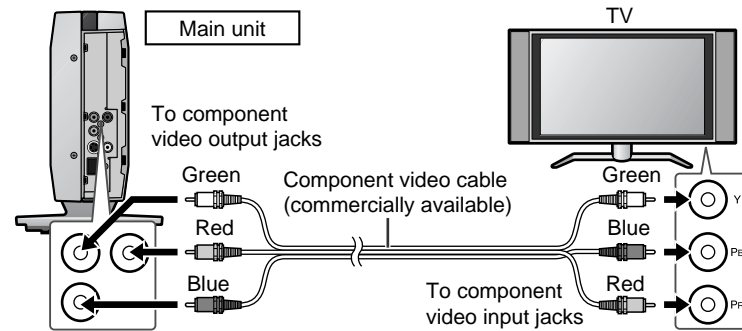

Notes:

- Change the TV input in accordance with the connected jack.
- Do not connect other equipment between the TV and this unit. If they are connected via a VCR, pictures may be distorted.
- If your TV has different indications for the component video inputs (Y, CB and CR or Y, B-Y and P-Y), connect jacks with its matching color.
- Do not connect to a component video input jack designed for the high-vision system, which is not DVD-compatible (the images may be distorted or not appear).
- Using the audio cable, you can listen to the TV sound with this unit (see page 56).

■ Attaching the side cover

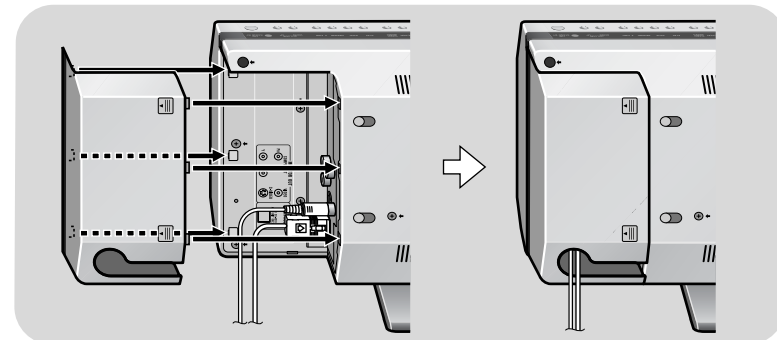

- 1 After making all the connections, attach the side cover to the main unit. Fit the claws into the holes.
- 2 Route all the cables through the hole of the cover.

AC power connection

■ Connecting the AC power cord

After checking all the connections have been made correctly, plug in the amplifier unit.

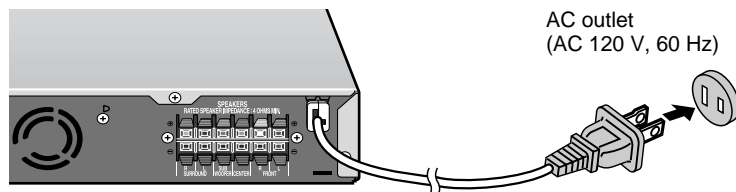

Note:

Unplug the AC power cord from the AC outlet if the unit will not be in use for a prolonged period of time.

■ To turn the power on

Press the **POWER** button.

The power indicator on the amplifier unit lights up.

If the power does not turn on, check if the power cord and system connection cable are plugged in properly.

To set the unit to stand-by mode:

Press the **POWER** button again.

Note:

After the unit enters the power stand-by mode, wait a few seconds to turn on again.

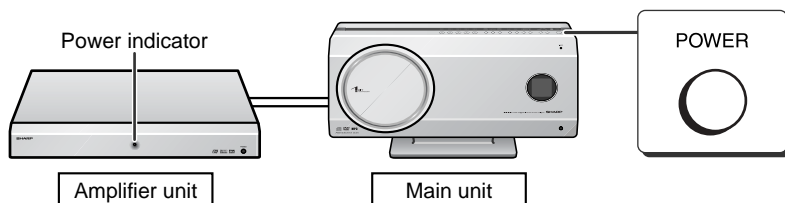

■ Auto power off function

The unit enters the stand-by mode after 20 minutes of inactivity in DVD operation.

Remote control

■ Battery installation

- 1 Open the battery cover.
- 2 Insert the supplied batteries according to the direction indicated in the battery compartment.
When inserting or removing the batteries, push them toward the \ominus battery terminals.
- 3 Close the cover.

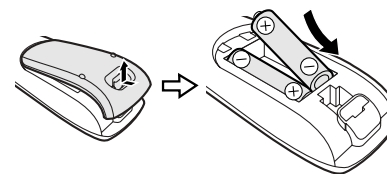

Precautions for battery use:

- Replace all old batteries with new ones at the same time.
- Do not mix old and new batteries.
- Remove the batteries if the unit will not be used for long periods of time. This will prevent potential damage due to battery leakage.

Caution:

- Do not use rechargeable batteries (nickel-cadmium battery, etc.).
- Installing the batteries incorrectly may cause the unit to malfunction.

Notes concerning use:

- Replace the batteries if the operating distance is reduced or if the operation becomes erratic. Purchase 2 "AA" size batteries (UM/SUM-3, R6, HP-7 or similar).
- Periodically clean the transmitter on the remote control and the sensor on the unit with a soft cloth.
- Exposing the sensor on the unit to strong light may interfere with operation. Change the lighting or the direction of the unit.
- Keep the remote control away from moisture, heat, shock, and vibrations.

■ Test of the remote control

Point the remote control directly at the remote sensor on the unit.

The remote control can be used within the range shown on the right.

Press the **POWER** button. Does the power turn on? Now, you can enjoy your system.

- Use 2 remote sensors on the main unit according to the installation method.

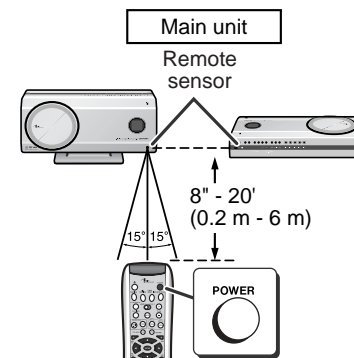

General control

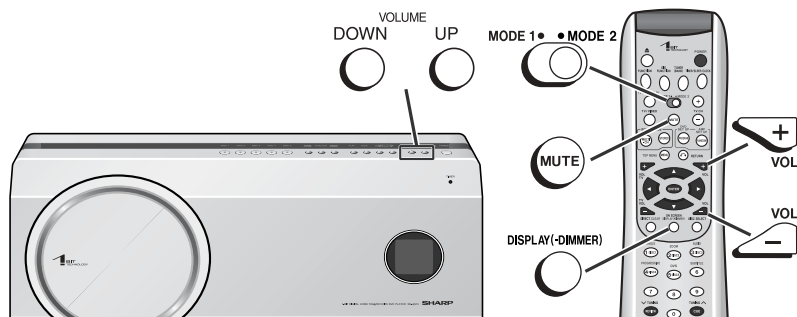

Volume control

Main unit operation:

Press the VOLUME UP button to increase the volume and the VOLUME DOWN button for decreasing.

Remote control operation:

Press the VOL + button to increase the volume and the VOL - button for decreasing.

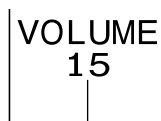

0 → 1 → 2 ... 38 → 39 → 40

Muting

The volume is muted temporarily when pressing the MUTE button.

- Press again to restore the volume.
- The mute status is canceled when you adjust the volume.



To change the display brightness (2 levels)

Set the MODE 1/MODE 2 switch to MODE 2 and hold down the DISPLAY (-DIMMER) button for 3 seconds or more.

Each time you press, brightness changes.

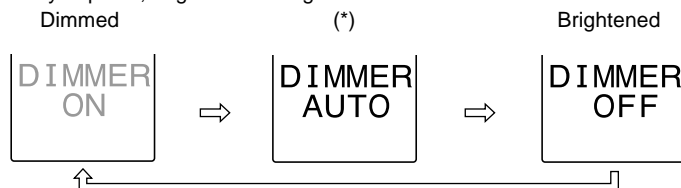

(*) After approx. 5 seconds of DVD playback, the display dims and the original brightness returns when you stop playback. The brightness remains unchanged during playback of other media.

Setting the clock

By setting the unit to the correct time, you can use it not only as a clock but also for timer playback.

1 Turn on the unit, and press the TIMER/SLEEP/CLOCK button.

2 Within 10 seconds, press the ▲ or ▼ button to select the date and time indicator and then press the ENTER button.

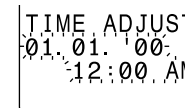

3 Press the ◀ or ▶ button to adjust the year and then press the ENTER button.

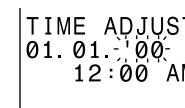

Set "Month", "Date", "Hour" and "Minute" in the same way.

- The 12-hour display will appear.
(AM 12:00 - PM 11:59)
- The time disappears after approx. 2 seconds.

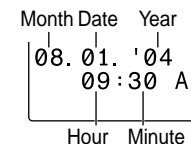

To confirm the time display:

Set the MODE 1/MODE 2 switch to MODE 2 and hold down the DISPLAY (-DIMMER) button for 3 seconds or more.

The time display will appear for about 5 seconds.

[When the power is on]

Press the TIMER/SLEEP/CLOCK button.

Within 10 seconds, press the ▲ or ▼ button to select the time.

The time display will appear for about 10 seconds.

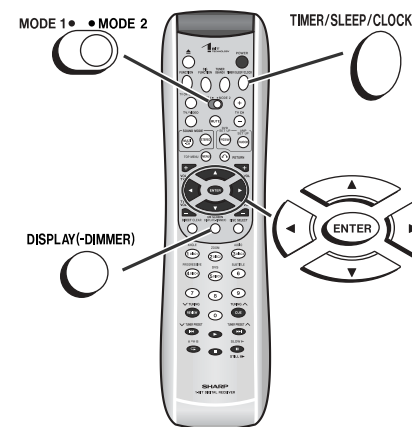

Note:

Unplugging the unit or power failure will clear the clock setting. Readjust the clock.

Inserting and removing discs

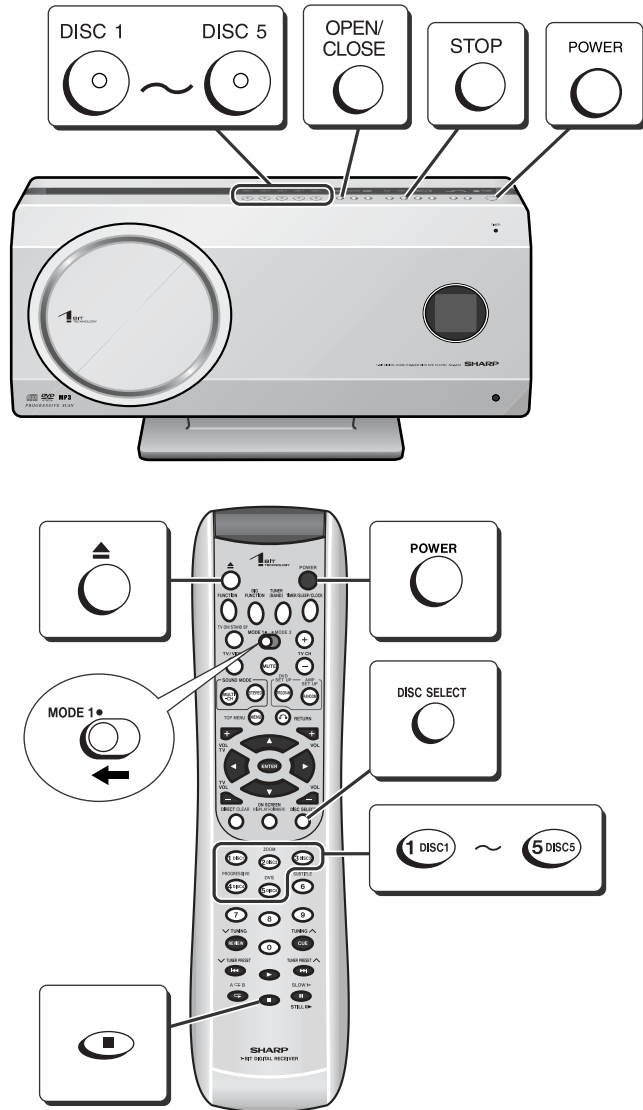

■ Inserting a disc DVD CD MP3 WMA JPEG

1 Press the POWER button to turn the power on.

2 Press the STOP button to set the input to "DVD".

The same operation can be performed by pressing the ■ button on the remote control.

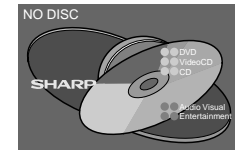

3 Select the DISC 1 slot.

Main unit:

Press the DISC 1 button.

Remote control:

Press the DISC SELECT button, set the MODE 1/MODE 2 switch to MODE 1 and press the DISC 1 button.

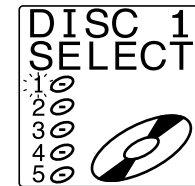

4 Press the OPEN/CLOSE button.

- The same operation can be performed by pressing the ▲ button on the remote control.

- Rotating slowly, the disc compartment opens.

- A disc number flashes for the selected slot.

Note:

The disc compartment closes approximately after 2 minutes of inactivity. Press the OPEN/CLOSE button again.



Example:
DISC 1
slot

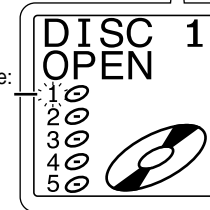

5 Insert a disc into the disc insertion slot and push it.

The disc compartment closes automatically.

Disc insertion angle differs depending on the installation direction.

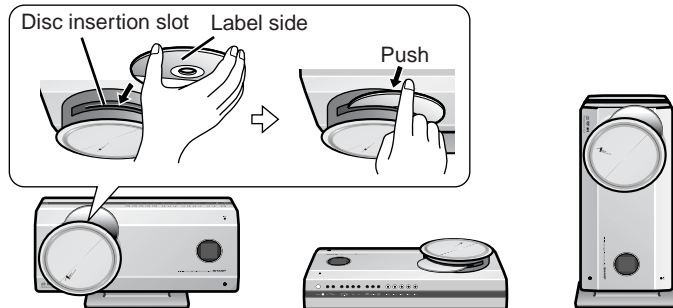

1. Insert a disc into the slot with the label toward you.
2. Push in the disc slightly (it enters automatically).
3. The disc compartment closes and one of the DISC 1 - DISC 5 buttons lights up for the disc.

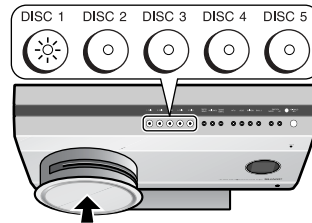

6 Repeat steps 3 - 5 to insert a disc into the DISC 2 - 5 slot.

Caution:

- Do not touch the disc compartment while it is moving, and be careful not to pinch your fingers.
- If the power fails while the compartment is open, wait until the power is restored.
- If the disc compartment is stopped with force, the unit will not function. If this occurs, press the POWER button to enter the power stand-by mode and then turn the unit on again.
- Do not insert two discs in one disc insertion slot.
- A disc with scratches or fingerprints may not play properly. Refer to "Care of discs (page 62)" and clean the disc.
- Do not play the discs of special shapes (heart or octagon shaped) as they can be ejected while rotating and cause injury.
- If you turn off the power with the disc compartment open, the compartment closes.

To remove the disc

Example: Removing a disc from DISC 1

- 1 Press the DISC 1 button.
The same operation can be performed by pressing the DISC SELECT button, and then press the DISC 1 button on the remote control.
- 2 Press the OPEN/CLOSE button.
The same operation can be performed by pressing the ▲ button on the remote control.
- 3 Remove the disc.

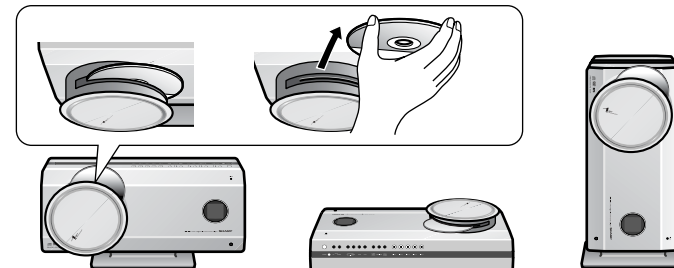

- 4 Press the OPEN/CLOSE button to close the disc compartment.
The same operation can be performed by pressing the ▲ button on the remote control.
To remove more discs, repeat step 1 - 4.

Notes:

- DVD discs cannot be removed in the resume play mode. Press the STOP button and then remove the disc.
- Do not touch the playback side.
- 3" (8 cm) discs are not supported.



To exchange other discs while playing a disc

- 1 Press a disc number select button (except for the disc in operation).
The same operation can be performed by pressing the DISC SELECT button and then the disc number select button on the remote control.
- 2 Press the OPEN/CLOSE button.
The same operation can be performed by pressing the ▲ button on the remote control.
- 3 Replace a disc.

Playing a disc

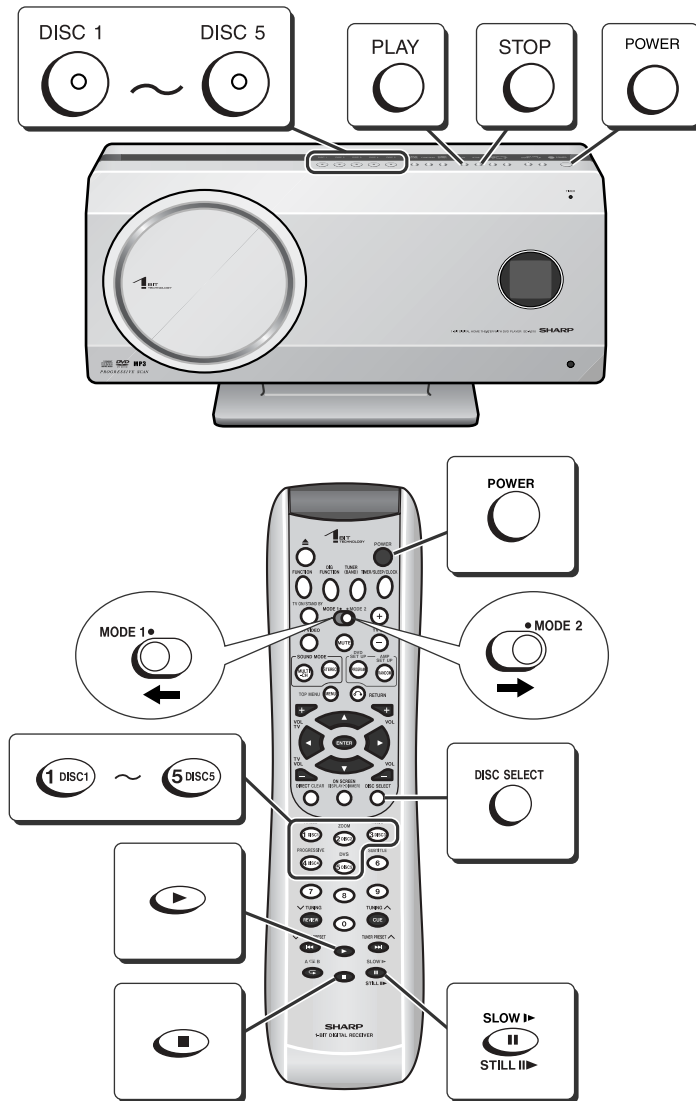

■ Playback DVD CD MP3 WMA JPEG

- For a wide-screen TV, set the video output to "Wide" (see page 48).
- Turn on the TV, and switch the input to the "VIDEO 1", "VIDEO 2", etc. accordingly.

1 Press the POWER button to turn the power on.

2 Press the ■ button to set the input to "DVD".

You can also use the STOP button on the main unit.

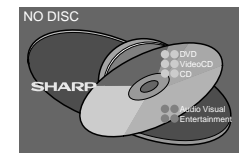

3 Insert a disc (see pages 22, 23).

4 Press the DISC SELECT button, set the MODE 1/MODE 2 switch to MODE 1 and press the DISC 1 - DISC 5 button.

Alternatively, press one of the DISC 1 - DISC 5 buttons on the main unit.

DISC 2
SELECT

5 Press the ► button.

- When the top menu (for DVD) is open, select an item with the cursor buttons and press the ► button again.
- You can also use the PLAY button on the main unit.



- The main unit stops after playing a disc and does not switch to discs automatically.
- When "ALL DISC REP" is selected for audio CD playback, the next disc plays after a disc ends.
- When the unit is left unoperated for more than 5 minutes after pressing the ■ (STOP) button, a screen saver appears.
Press any button on the main unit or remote control. The startup screen returns.
- To play other discs during playback, select a disc number and press the ► (PLAY) button.

To interrupt playback

Press the **II** button on the remote control.

To resume playback from the same point, press the **▶** (PLAY) button.

To stop playback

DVD:

Press the **■** (STOP) button twice.

Audio CD/MP3/WMA/JPEG:

Press the **■** (STOP) button.

Notes:

- Some DVD discs may not function as described in the manual. See the disc jacket for restrictions.
- During an operation, "E" may appear indicating that the operation is disabled by the disc.
- Some DVD-R/DVD-RW/CD-R/CD-RW may not play properly due to the status of the disc or equipment used for recording. Change the recording speed or disc. For more details, see the manual for the equipment.
- When you turn on the power or switch the input to "DVD", initialization starts and operation is not possible for a few seconds.
- Sound may skip at high volume depending on the disc. In this case, turn down the volume.
- On dual layer DVD discs, playback may pause when the layer switches.

■ To resume playback after stopping (resume play) DVD

You can resume playback from the point where it was stopped.

- 1 While a disc is playing, press the **■** (STOP) button.**

The system stores the point.



- 2 To restart play, press the **▶** (PLAY) button.**

Play resumes from the point.

To cancel resume play:

Press the **■** (STOP) button twice.

Notes:

- The resume playback feature is disabled on some discs.
- Depending on the disc, playback may resume from slightly before the stopped position.

■ Changing the progressive scan select mode DVD

- 1 Press the POWER button to turn the power on.**

- 2 Set the MODE 1/MODE 2 switch to MODE 2 and press the PROGRESSIVE button on the remote control.**

Each time this button is pressed, the mode changes in the following order:

Select this for a non-progressive scan TV
(use a video cable, S-video cable, or component video cable).

PROGRESSIVE
OFF



Select this for a progressive scan TV
(use a component video cable).

PROGRESSIVE
ON

**Caution:**

When "PROGRESSIVE ON" is selected for a non-progressive scan TV, nothing appears on the screen.

What is progressive scanning?

The conventional TV system displays 30 frames of still images per second to perform a series of movements (interlaced scanning). Whereas, progressive scanning displays one frame every 1/60th of a second (60 frames per second) to ensure less flickers and high-density images.

Basic operation

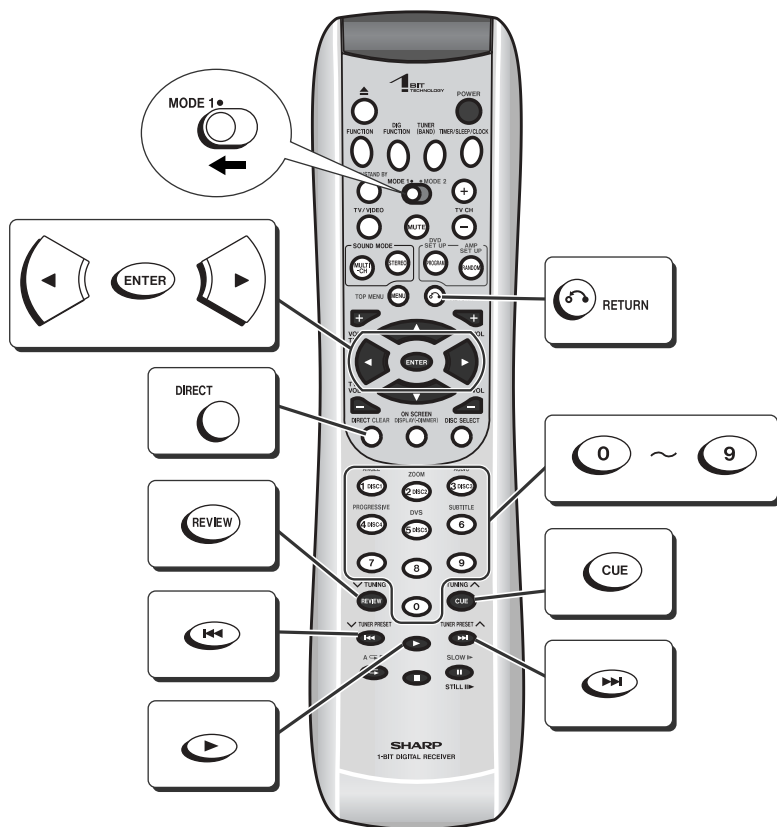

■ Fast forward/Fast reverse (search) DVD CD

MP3 WMA

You can search the desired point as you play the disc.

1 While a disc is playing, press the CUE or REVIEW button.

On DVD, the speed changes as follows:

CUE: fast forward	FF 2 X
REVIEW: fast reverse	FR 2 X

PLAY (Normal play) → 2 X → 4 X → 6 X → 8 X

On Audio CD/MP3/WMA, the speed changes as follows:

PLAY (Normal play) → 1 X → 2 X → 3 X → 4 X

● The disc is forwarded by the CUE button and reversed by the REVIEW button.

● The same operation can be performed by holding down the CHAPTER (TRACK) DOWN or UP button on the main unit for 2 seconds or more.

2 Press the ► button to return to normal playback.

Notes:

- On some discs, the search function is disabled.
- On a DVD, search does not operate between titles.
- On audio CD, MP3 and WMA, the search does not operate across tracks.
- When "ALL DISC REP" is selected for audio CD playback, the next disc plays after a disc ends.
- While searching on a DVD, the sound is not heard and the subtitles do not appear.
- Audio CD, MP3 or WMA disc sounds will break up during search. This is not a malfunction.
- When search is performed during the DVD playback, pictures may not be forwarded or reversed in the search speed specified in this manual, depending on the disc or the scene being played.

■ To locate the beginning of a chapter (track) (skip) DVD CD MP3 WMA JPEG

You can move to other chapter (track) with simple operations.

While a disc is playing, press the ◀◀ or ▶▶ button.

- Press the ▶▶ button to skip to the next chapter (track).
- Press the ◀◀ button to skip to the beginning of the current chapter (track). Press the ◀◀ button again to skip to the beginning of the previous chapter (track).
- The same operation can be performed by pressing the CHAPTER (TRACK) DOWN or UP button on the main unit.

NEXT

Notes:

- The main unit stops after playing a disc and does not switch to discs automatically.
- Some discs do not display the chapter (track) and the skip feature is disabled.
- On a DVD, the skip function may not be available across titles.

■ To start playback from the desired point (direct play) DVD

1 During playback, set the MODE 1/MODE 2 switch to MODE 1 and press the DIRECT button.

2 Within 10 seconds, select a title or chapter by pressing the ◀ or ▶ button and enter the title or chapter number using the direct number buttons.

TITLE 01/02 CHAPTER 001/002

3 Within 10 seconds, press the ENTER button.

To correct the number, enter again.

Notes:

- Direct play feature is disabled on some discs.
- Some DVD discs may not display the chapter number.

■ To play by specifying time (time search)

DVD

1 During playback, set the MODE 1/MODE 2 switch to MODE 1 and press the DIRECT button twice.

TITLE 02/12 TIME : : :

If " : : " is not highlighted, press the ◀ or ▶ button repeatedly.

2 Within 10 seconds, specify the time with the direct number buttons, and then press the ENTER button.

TITLE 02/12 TIME 01:23:40

- To specify 1 hour 23 minutes and 40 seconds, enter "012340".
- If you enter the wrong number, start over from step 1.
- Specify the elapsed time of the title.

Notes:

- Time search is not possible across titles.
- Some discs cannot play from the specified point.
- Time search feature is disabled on some discs.
- Some discs contain time portions you cannot specify.

Useful operation

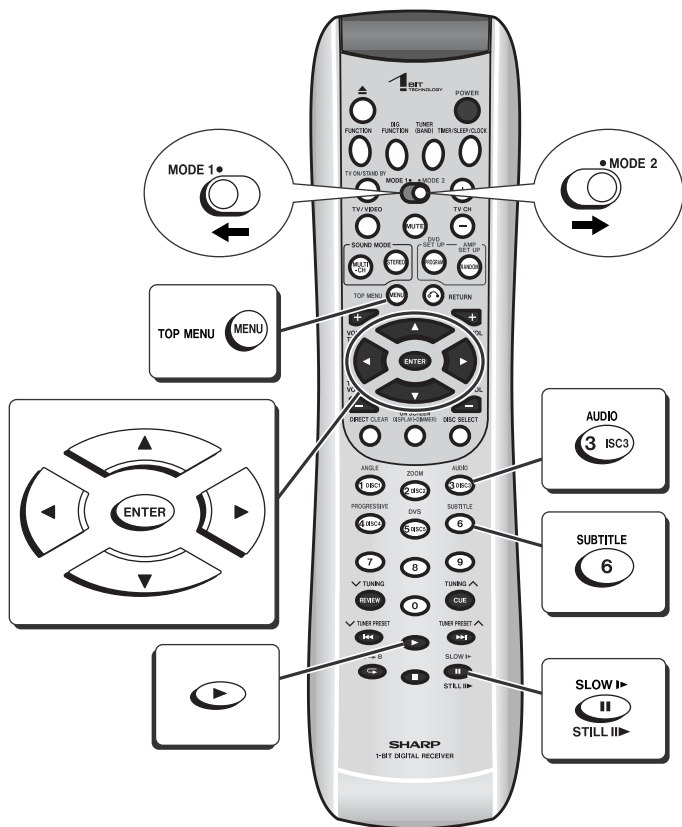

■ To change the subtitle language DVD

You can change the subtitle language or hide subtitles during playback.

1 During playback, set the MODE 1/MODE 2 switch to **MODE 2** and press the **SUBTITLE** button.

2 Press the **SUBTITLE** button repeatedly to select the subtitle language.

SUBTITLE 01/03: ENGLISH

- You can select one of the subtitle languages that are recorded on a DVD.

ENGLISH → FRENCH → ... → SPANISH

- To hide subtitles on the screen, press the **SUBTITLE** button repeatedly to select "OFF".

Notes:

- The subtitle language on some DVDs may not be changed.
- If no subtitles are recorded on the disc, "SUBTITLE OFF" is displayed.
- It may take a little time to switch the subtitle language to the selected one.
- When you set the unit to the stand-by mode or replace the disc, settings return to the default.

■ To change the audio language (audio output) DVD

During playback, you can change the audio language (audio output).

1 During playback, set the MODE 1/MODE 2 switch to **MODE 2** and press the **AUDIO** button.

2 Press the **AUDIO** button repeatedly to select the audio language (audio output).

AUDIO 2/8: AC-3 5.1CH ENGLISH

Each time you press, audio language (audio output) changes.

Example:

1 DD 5.1ch 1: Original <English> (Dolby Digital 5.1 Surround)

2 dts 2: Original <English> (DTS 5.1 Surround)

3 DD 2ch 3: Japanese (Dolby Digital 2 ch)

Notes:

- The audio language on some DVDs may not be changed.
- For available audio languages (audio outputs), see the disc jacket.
- When you set the unit to the stand-by mode or replace the disc, settings return to the default.

■ To select a title from the top menu of the disc DVD

On a DVD with multiple titles, you can select a title from the top menu.

1 During playback, set the MODE 1/ MODE 2 switch to MODE 2 and press the TOP MENU button.	Example				
	<table border="1" style="margin: auto; border-collapse: collapse;"> <tr> <td style="padding: 2px 5px;">1 Drama</td> <td style="padding: 2px 5px;">2 Action</td> </tr> <tr> <td style="padding: 2px 5px;">3 SF</td> <td style="padding: 2px 5px;">4 Comedy</td> </tr> </table>	1 Drama	2 Action	3 SF	4 Comedy
1 Drama	2 Action				
3 SF	4 Comedy				
2 Use the ▲, ▼, ◀, or ▶ button to select the title, and then press the ENTER button.					
<ul style="list-style-type: none"> ● The selected title is played. ● You can also use the direct number buttons for some discs. 					

Note:

The procedure shown here provides only general steps. The actual procedure for using the disc menu depends on the disc you are using. See the disc jacket for details.

■ To select a subtitle or audio language from the disc menu DVD

You can select the desired subtitle/audio language and sound system (5.1-ch Dolby Digital or DTS sound) on your DVD if it has a disc menu.

1 During playback, set the MODE 1/ MODE 2 switch to MODE 1 and press the MENU button.	Example			
	<table border="1" style="margin: auto; border-collapse: collapse;"> <tr> <td style="padding: 2px 5px;">Menu</td> </tr> <tr> <td style="padding: 2px 5px;">1.Highlights</td> </tr> <tr> <td style="padding: 2px 5px;">2.Start Movie</td> </tr> </table>	Menu	1.Highlights	2.Start Movie
Menu				
1.Highlights				
2.Start Movie				
2 Press the ▲, ▼, ◀ or ▶ button to select a subtitle/audio language and press the ENTER button.				
You can also use the direct number buttons for some discs.				

Note:

The procedure shown here provides only general steps. The actual procedure for using the disc menu depends on the disc you are using. See the disc jacket for details.

■ Still picture/Frame advance DVD

You can freeze the image and advance frame by frame.

1 During playback, set the MODE 1/ MODE 2 switch to MODE 1 and press the STILL button.	<table border="1" style="margin: auto; border-collapse: collapse;"> <tr> <td style="padding: 2px 5px;">STILL</td> </tr> </table>	STILL
STILL		
Each press of the STILL button advances the frame.		
2 Press the ▶ button to return to normal playback.		

Note:

Still picture and frame advance features are disabled on some discs.

■ Slow-motion play DVD

You can slow down the playback speed.

1 During playback, set the MODE 1/ MODE 2 switch to MODE 2 and press the SLOW button.	<table border="1" style="margin: auto; border-collapse: collapse;"> <tr> <td style="padding: 2px 5px;">SF 1/2 X</td> </tr> </table>	SF 1/2 X													
SF 1/2 X															
2 Press the SLOW button repeatedly to select a playback speed.															
<table style="margin: auto;"> <tr> <td style="padding: 5px;">PLAY (Normal play)</td> <td style="padding: 0 10px;">→</td> <td style="padding: 5px;">SF 1/2 X</td> <td style="padding: 0 10px;">→</td> <td style="padding: 5px;">SF 1/4 X</td> <td style="padding: 0 10px;">→</td> <td style="padding: 5px;">SF 1/8 X</td> </tr> <tr> <td style="padding: 5px;">↑</td> <td colspan="5"></td> <td style="padding: 5px;"> </td> </tr> </table>		PLAY (Normal play)	→	SF 1/2 X	→	SF 1/4 X	→	SF 1/8 X	↑						
PLAY (Normal play)	→	SF 1/2 X	→	SF 1/4 X	→	SF 1/8 X									
↑															
3 Press the ▶ button to return to normal playback.															

Note:

On some discs, the slow-motion playback functions are disabled.

Useful operation (continued)

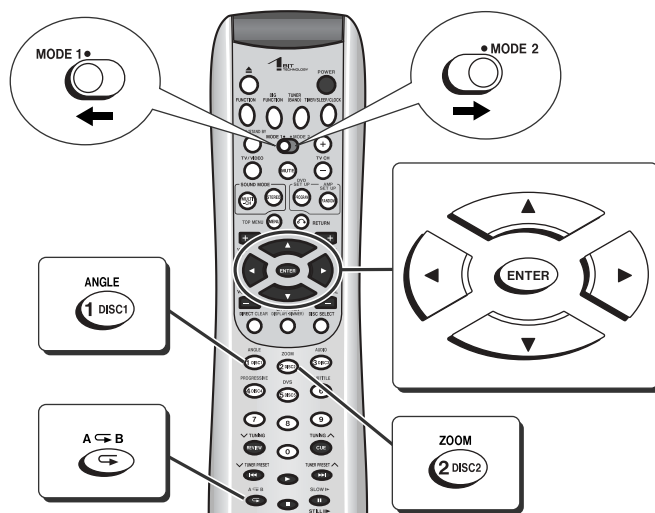

■ To change the angle DVD

You can change the angle of view when playing a DVD disc that contains scenes recorded from multiple angles.

- 1 When "ANGLE" appears on the TV during playback, set the MODE 1/MODE 2 switch to MODE 2 and press the ANGLE button.



- 2 Use the ANGLE button to select an angle number.

Each time you press, the angle changes.



Notes:

- Some DVDs prohibit changing the angle.
- The angle number is not displayed if there is no other angle recorded. "0" is displayed instead.
- Refer to the manual of the disc as the operation may vary depending on the disc.

■ To zoom images (zoom) DVD

You can magnify images during playback.

- 1 In the pause mode or during playback, set the MODE 1/MODE 2 switch to MODE 2 and press the ZOOM button.

ZOOM X1.5

Pressing the button cycles through the zoom settings as follows:

ZOOM X1.5 → ZOOM X2 → ZOOM X3 → ZOOM OFF

- 2 To shift the view and display the desired part of a zoomed image, press the ▲, ▼, ◀ or ▶ button repeatedly.

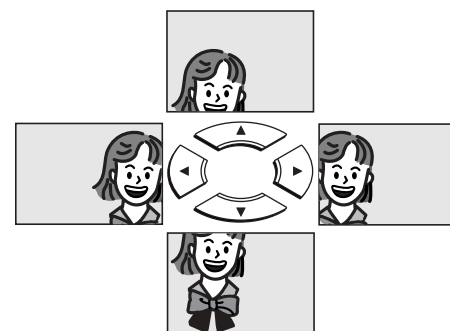

To return to normal view:

Press the ZOOM button repeatedly to select "ZOOM OFF".
When you cancel the zoom function, you cannot shift the view.

Notes:

- An image may become distorted when zoomed.
- Subtitles cannot be zoomed.

■ To play repeatedly (repeat play) DVD CD MP3

WMA

You can play a chapter (track) or a title repeatedly by specifying it during playback.

During playback, set the MODE 1/MODE 2 switch to MODE 1 and press the \leftarrow button.

TV screen

CHAPTER REPEAT ON

Unit display

DVD ▶ C ↻

Each time the button is pressed, the repeat play mode changes in the following order.

The repeat play mode changes as follows on DVD:

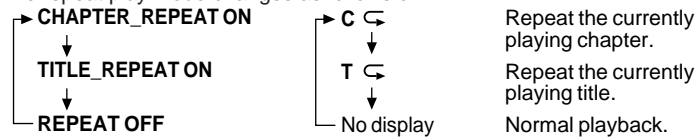

The repeat play mode changes as follows on CD:

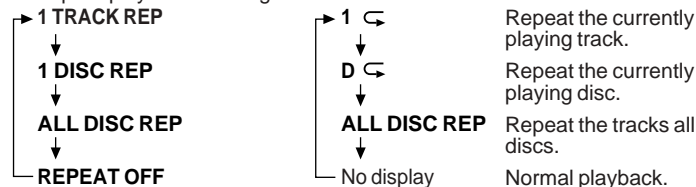

The repeat play mode changes as follows on MP3/WMA:

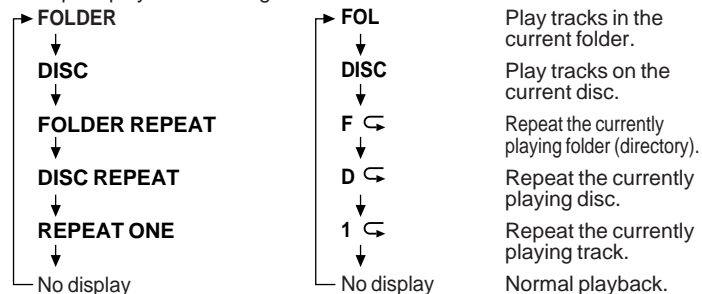

Caution:

After performing repeat play, be sure to press the \blacksquare button. Otherwise, the disc will play continuously.

Notes:

- On some discs, the repeat play function is disabled.
- To repeat CD programmed play, perform repeat play during programmed playback.
- When you press the \blacksquare button, the current repeat play is canceled.
- Random is prohibited during repeat play.

■ To play the contents between the specified points repeatedly (A-B repeat) DVD CD

You can play the desired portion repeatedly by specifying it during playback.

1 During playback, set the MODE 1/MODE 2 switch to MODE 2 and press the A \leftarrow B button.

TV screen

A TO B SET A

Unit display

A ↻

The start point (A) is created.

2 Press the A \leftarrow B button again to enter the end point (B).

A-B repeat plays from the start point (A) to the end point (B).

3 Press the A \leftarrow B button to return to normal playback.

Notes:

- A-B repeat play is disabled on some discs.
- Some scenes on DVD may not allow A-B repeat play.
- A-B repeat play for DVD is possible only within a title.
- A-B repeat play for CD is possible only within a track.
- During programmed play, A-B repeat play is not available.
- When you press the \blacksquare button, the current A-B repeat play is canceled.
- When playback stops after creating the start point (A), A-B repeat setting is canceled.

Useful operation (continued)

■ To change the display on TV screen DVD

CD MP3 WMA

You can display or hide the operation indicators on the TV screen.

During playback, set the MODE 1/MODE 2 switch to MODE 1 and press the ON SCREEN button. (The display is changed at each press.)

DVD:

Current title number Current chapter number

TITLE 02/05 CHAPTER 001 / 008
00:30:21

Total number of chapters
Total number of titles
Elapsed playback time for the current title

TITLE REMAIN
00:45:00

Remaining playback time for the current title

CHAPTER ELAPSE TIME
00:01:23

Elapsed playback time for the current chapter

CHAPTER REMAIN TIME
00:03:03

Remaining playback time for the current chapter

OFF

MP3/WMA:

TRACK ELAPSE TIME 00:05:21

Elapsed playback time for the current track

TRACK REMAIN TIME 00:02:35

Remaining playback time for the current track

OFF

Audio CD:

TRACK ELAPSED
00:01:16

Elapsed playback time for the current track

TRACK REMAIN
00:03:21

Remaining playback time for the current track

TOTAL ELAPSED
00:12:40

Total elapsed playback time for the disc

TOTAL REMAIN
00:48:54

Total remaining playback time for the disc

OFF

■ To change the display on the main unit DVD

CD MP3 WMA JPEG

During playback, set the MODE 1/MODE 2 switch to MODE 2 and press the DISPLAY (-DIMMER) button.

Each time you press, the display changes.

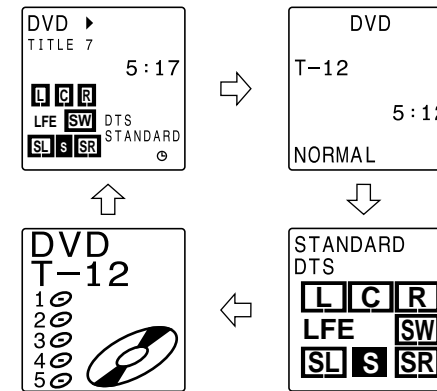

Notes:

- The playing time of the disc specified on the jacket, etc. may not include silence between tracks, and may differ from that displayed on the unit.
- Elapsed time on the display does not indicate the actual time.

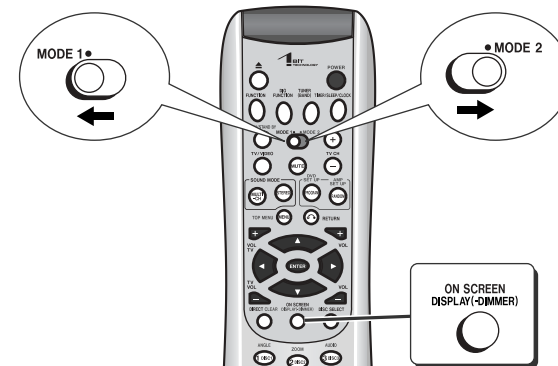

Playing a CD

The procedure of the following playback functions are the same as the DVD operation.

	Page
<u>Inserting and removing discs</u>	22
<u>Playback</u>	24
<u>Fast forward/Fast reverse (search)</u>	26
<u>To locate the beginning of a chapter (track) (skip)</u>	27
<u>To play repeatedly (repeat play)</u>	31
<u>To play the contents between the specified points repeatedly (A-B repeat)</u> ..	31
<u>To change the display on TV screen</u>	32
<u>To change the display on the main unit</u>	32

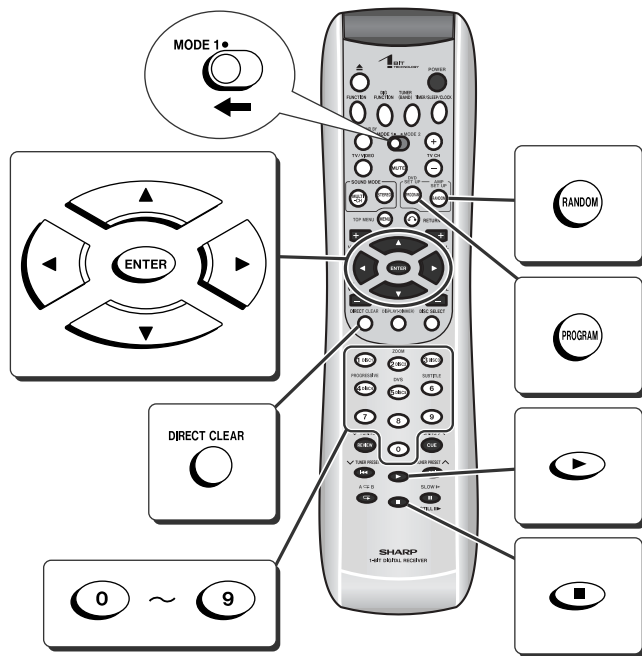

■ To start playback from the desired point (direct play) CD MP3 WMA JPEG

In the stop or playback mode, set the MODE 1/MODE 2 switch to MODE 1 and press the direct number buttons to select the track number.

SELECT: 14

Notes:

- Direct play feature is disabled on some discs.
- Some discs cannot play from the specified point.

■ To play by specifying time (time search)

CD

1 During playback, set the MODE 1/MODE 2 switch to MODE 1 and press the DIRECT button.

GO TO ____:____

2 Specify the time with the direct number buttons.

- Enter minutes and seconds.
- To specify 4 minutes and 23 seconds, enter "0423".
- Specify the elapsed time of the track.

Note:

Time search feature is disabled on some discs.

Playing a CD (continued)

■ To play in the desired order (programmed play) **CD**

You can play tracks in the desired order. 21 tracks can be programmed.

1 Press the DISC SELECT button, and then press the DISC 1 - DISC 5 button.

2 In the stop mode, set the MODE 1/ MODE 2 switch to MODE 1 and press the PROGRAM button.

The programming screen is displayed.

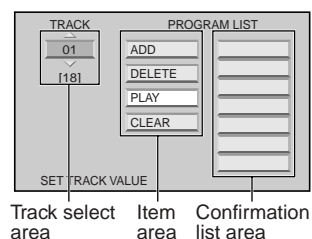

3 Press the ▲ or ▼ button to select the desired track.

4 Press the ► button to move to the item area.

5 Press the ▲ or ▼ button to select "ADD" in item area, and press the ENTER button.

- The number is saved in the confirmation list area.
- Press the ◀ button, and repeat steps 3 - 5 to program other tracks.

6 Press the ▲ or ▼ button to select "PLAY" in item area, and press the ENTER button.

- The unit stops after playing the tracks in the programmed order.
- The programmed contents will be stored until the disc is removed.

To change the programmed contents:

- 1 In the stop mode, set the MODE 1/MODE 2 switch to MODE 1 and press the PROGRAM button.
- 2 Press the ► button to move to the item area.
- 3 Press the ▲ or ▼ button to select the desired item.

"ADD"* Adds a track to the program.

"INSERT" Inserts a track between programmed tracks. The track is inserted above (before) the selected track.

"DELETE" Deletes the selected track.

"PLAY" Starts the programmed play.

"CLEAR" Deletes the program.

* "ADD" changes to "INSERT" when selecting tracks in the confirmation list area.

- 4 Press the ENTER button.

To repeat the programmed play:

During programmed play, press the REPEAT button twice.
Programmed tracks play repeatedly.

Notes:

- Programming cannot be performed while paused or in the playback mode.
- Programmed play is prohibited on some discs.

■ To play in random order (random play) **CD**

MP3

The tracks on the disc can be played in random order automatically.

1 In the stop mode, set the MODE 1/ MODE 2 switch to MODE 1 and press the RANDOM button.

RANDOM

2 Press the ► button.

All tracks play in random order.

To cancel random play, press the RANDOM button.

When you press the ■ button, the current random play is canceled.

Notes:

- The main unit stops after playing a disc and does not switch to discs automatically.
- Random play is not allowed during programmed playback.
- In random play, the unit will select and play tracks automatically. (You cannot select the order of the tracks.)
- In random play, repeat play is prohibited.

MP3/WMA and JPEG disc operation

The procedure of the following playback functions are the same as the DVD or CD operations.

Inserting and removing discs	Page 22
Playback	24
Fast forward/Fast reverse (search)	26
To locate the beginning of a chapter (track) (skip)	27
To play repeatedly (repeat play)	31
To change the display on TV screen	32
To change the display on the main unit	32
To start playback from the desired point (direct play)	33
To play in random order (random play)	34

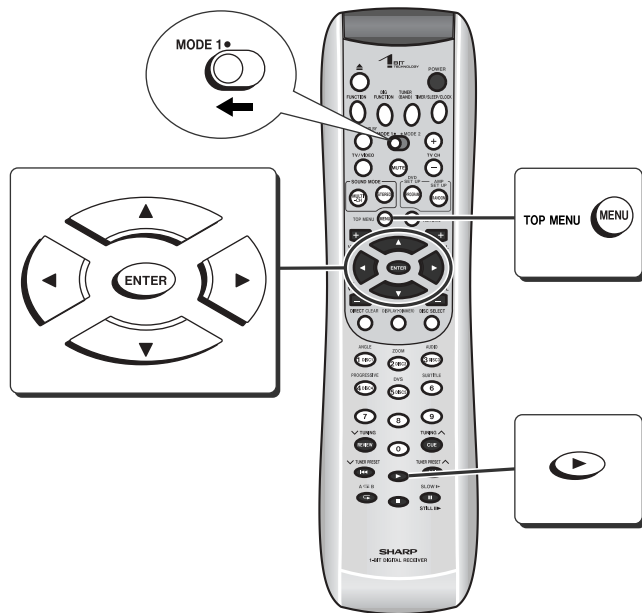

■ Playback on the MP3/WMA and JPEG menu screen

MP3 WMA JPEG

You can play CD-R/RW recorded in the MP3/WMA or JPEG formats.

1 Load a disc containing MP3/WMA or JPEG files.

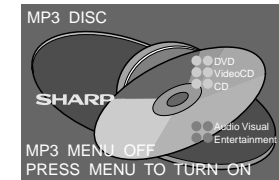

2 Press the MENU button.

The menu screen appears.

- Ⓛ ... Indicates folders.
- MP3 ... Indicates MP3 file.
- Ⓛ ... Indicates WMA file.
- Ⓛ ... Indicates JPEG file.

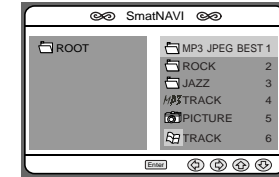

3 Press the ▲, ▼, ◀ or ▶ button to select a folder or file and press the ENTER or ► button.

- Playback starts when you select a file.
- When the format is JPEG, the next file is automatically displayed after a while.
- Using the direct number buttons, you can open files or folders directly. Enter the number on the right of the display.

Notes:

- Up to 11 characters can be displayed for a folder name and a track name. Underlines, asterisks, and spaces may not be displayed.
- Due to the structure of disc information, it takes longer to read an MP3/WMA or JPEG disc than a normal CD.

MP3/WMA and JPEG disc operation (continued)

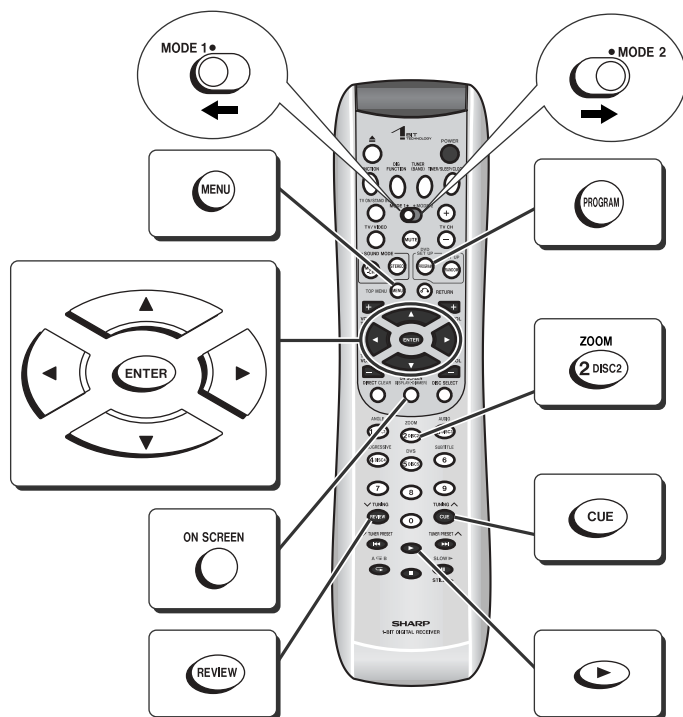

To set the menu screen to off:

Press the MENU button.

When the menu screen is off, tracks are played in the following order.
Playback is performed in the order of 1 to 11 in the following example.

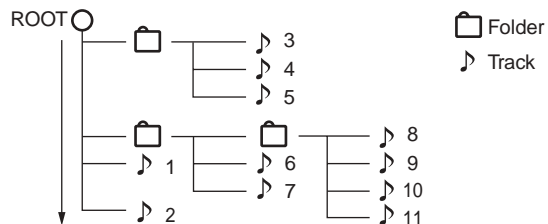

Tracks on some discs cannot be played in order.

To play in the desired order (programmed play) **MP3 WMA JPEG**

1 Load a disc containing MP3/WMA or JPEG files.

2 Press the MENU button.

3 Press the ▲, ▼, ◀ or ▶ button to select a track.

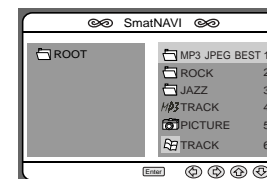

4 Set the MODE 1/MODE 2 switch to MODE 1 and press the ON SCREEN button.

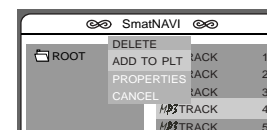

5 Press the ▲ or ▼ button to select "ADD TO PLT" and press the ENTER button.

Repeat steps 3 - 5 to program other tracks.

6 Press the PROGRAM button to view the program list.

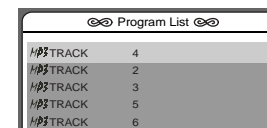

7 Press the ▶ button.

To change the programmed contents:

- 1 Press the MENU button.
- 2 Press the ON SCREEN button.
- 3 Press the ▲ or ▼ button to select the desired item.

"DELETE" Deletes the selected track.

"ADD TO PLT" Add selected tracks to Program List.

"PROPERTIES" Select this item to view an selected song properties. Can select this item either during stop mode or program list.

"CANCEL" Cancel on screen.

- 4 Press the ENTER button.

■ Zoom function JPEG

1 During playback, set the MODE 1/MODE 2 switch to MODE 2 and press the ZOOM button.

2 Press the REVIEW or CUE button.

Each press of the REVIEW or CUE button cycles through the zoom setting as follows.

ZOOM 025 PCT ↔ ZOOM 050 PCT ↔ ZOOM 100 PCT ↔ ZOOM 150 PCT ↔ ZOOM 200 PCT

3 To shift the view and display the desired part of a zoomed image, press the ▲, ▼, ◀ or ▶ button repeatedly.

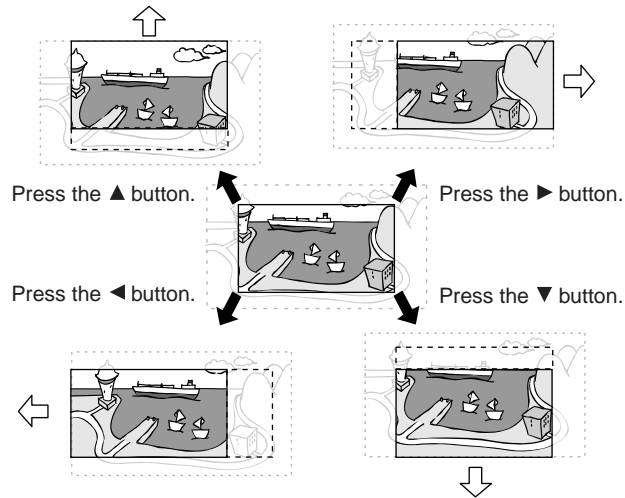

To return to normal view:

Set the MODE 1/MODE 2 switch to MODE 2 and press the ZOOM button again, "ZOOM 100 PCT" appears on the screen.

■ Rotating a picture JPEG

You can rotate images.

During playback, press the ▲, ▼, ◀ or ▶ button.

The image rotates as shown below.

▶ button : 90° rotation in a clockwise direction.

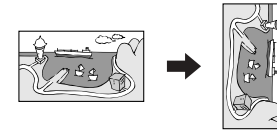

◀ button : 90° rotation in a counterclockwise direction.

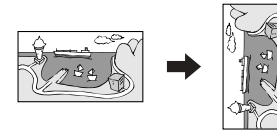

▲ button : Vertical mirror image.



▼ button : Horizontal mirror image.

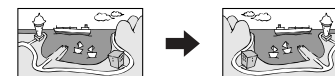

Listening to the radio

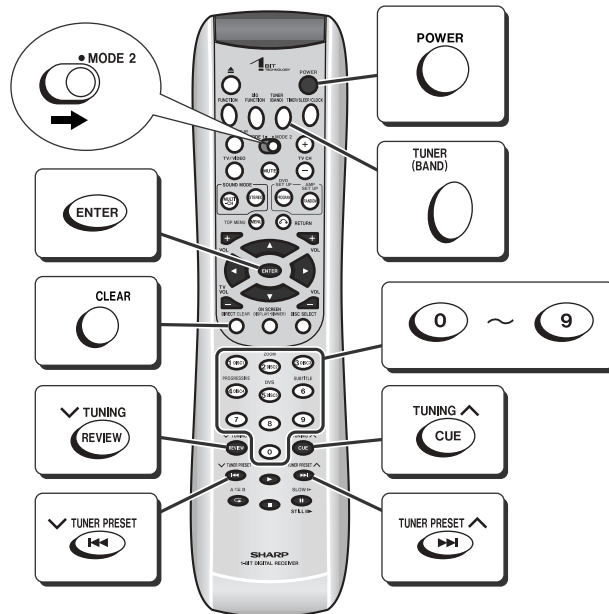
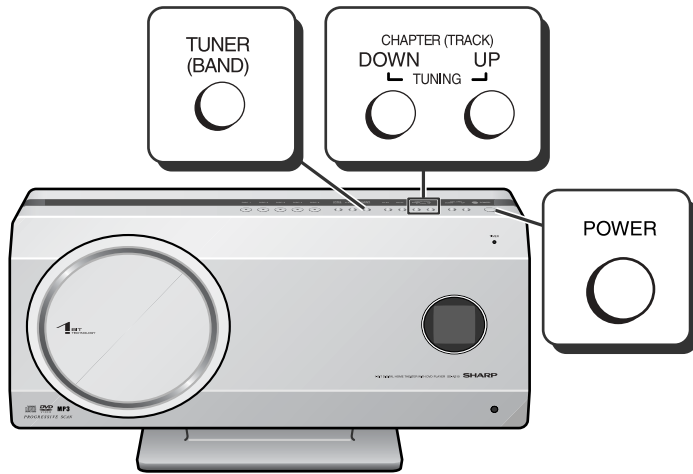

1 Turn on the power and press the **TUNER (BAND)** button to set the input to "FM (AM)".

2 Press the **TUNER (BAND)** button repeatedly to select the desired frequency band.

FM stereo	FM mono	AM
FM ST	FM	AM
87.5 MHz	87.5 MHz	530KHz

3 Press the **TUNING (∨ or ∧)** button to tune in to the desired station.

Manual tuning:

Press the TUNING button as many times as required to tune in to the desired station.

Auto tuning:

When the TUNING button is pressed for 0.5 seconds or more, scanning will start automatically and the tuner will stop at the first receivable broadcast station.

- When radio interference occurs, auto scan tuning may stop automatically. Should this happen, tune in manually.
- Auto scan tuning will skip weak signal stations.
- To stop the auto tuning, press the TUNING button again.

You can also use the TUNER (BAND), TUNING DOWN or TUNING UP button on the main unit.

To receive an FM stereo transmission:

Press the TUNER (BAND) button to display the "ST" indicator.

- "∞" will appear when an FM broadcast is in stereo.

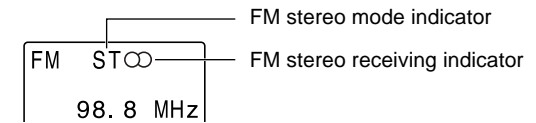

- If the FM reception is weak, press the TUNER (BAND) button to turn off the "ST" indicator. The reception changes to mono, and the sound becomes clearer.

After use:

Press the POWER button to enter the power stand-by mode.

■ Listening to the memorized station

You can store 40 AM and FM stations in total (preset tuning).

1 Tune in the desired station and press the ENTER button.

- For FM stations, stereo and mono modes are memorized.
- Store the stations in memory, in order, starting with preset channel 1.

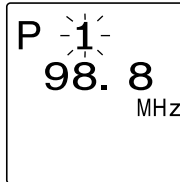

2 Within 5 seconds, press the TUNER PRESET (∨ or ∧) button to select the preset channel number.

Preset channel number

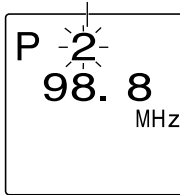

3 Within 5 seconds, press the ENTER button to store that station in memory.

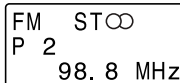

When a new station is stored in memory, the station previously memorized will be erased.

Note:

The backup function protects the memorized stations for a few days should there be a power failure or the AC power cord disconnection.

To recall a memorized station:

Press the TUNER PRESET (∨ or ∧) button to select the desired station.

Preset channel number

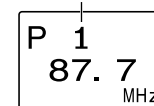

To select a preset station with the direct number buttons:

- 1 Set the MODE 1/MODE 2 switch to MODE 1.
- 2 Press the corresponding number ("0" - "9").
- 3 Press the ENTER button.

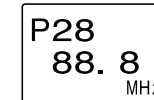
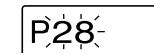

For example, to choose 28

- 1 Press the 2 button.
- 2 Press the 8 button.
- 3 Press the ENTER button.

- Press buttons within 5 seconds.
- To correct, enter the number again.

To erase all the contents of the preset memory:

- 1 Set the MODE 1/MODE 2 switch to MODE 2.
- 2 Hold the CLEAR button down for 4 seconds or more.
- 3 Within 10 seconds, press the ENTER button.



Enjoying surround sound (sound mode)

You can enjoy spacious sound recorded in Dolby Digital or DTS.
Also, Dolby Pro Logic II allows you to enjoy spacious 2 channel stereo sound.

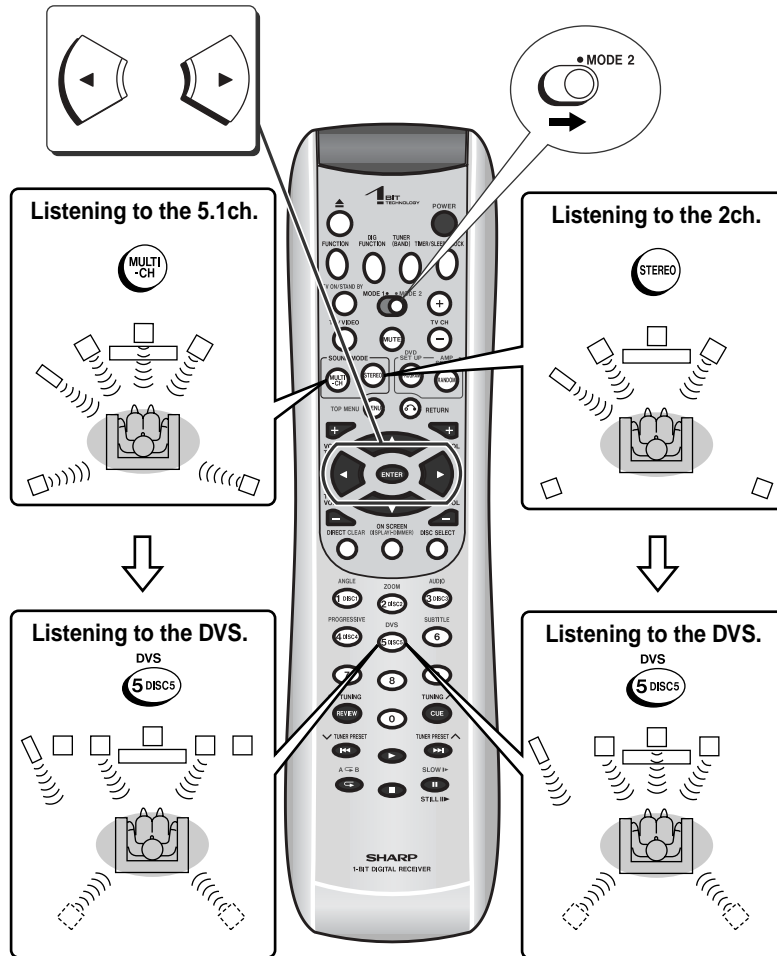

Notes:

- If sound is unpleasant to listen to, change the multi channel mode or stereo mode.
- Settings for the multi channel mode and stereo mode are retained by input (DVD/CD, TUNER, DIGITAL 1, DIGITAL 2, TV and VCR).

■ Listening to sounds in the multi channel mode (5.1 ch, etc.)

While the disc is playing, press the MULTI-CH button.

When you press once, the last used setting appears. To change it, press the button repeatedly within 3 seconds.

STANDARD:

You can enjoy the original sound as it is.

MOVIE:

The bass level is increased for powerful sound effect.

MUSIC:

You can enjoy lively sound by producing the articulate sound.

NIGHT:

Soft but powerful sound is achieved even at low volumes.

* STADIUM:

You feel like one of the audience in a stadium.

* HALL:

A concert hall atmosphere is created.

* Settings are available for 2 channel discs and 2 channel compatible equipment.

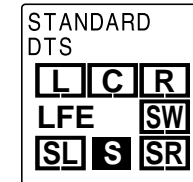

Notes:

- When monaural signals are received in the multi channel mode, only the center speaker and subwoofer produce sound.
- When you play Dolby Digital or DTS sound with "STADIUM" or "HALL" set, surround is automatically set to "STANDARD".
- When listening to Dolby Digital or DTS sound, you cannot select "STADIUM" and "HALL".

■ Listening to 2 channel stereo sounds

While the disc is playing, press the STEREO button.

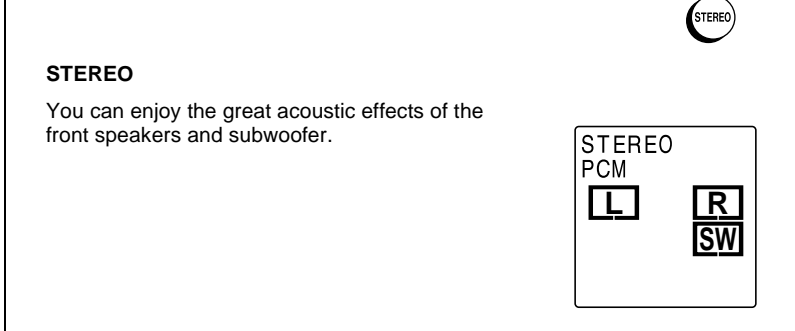

Notes:

- When the surround mode is set to "STEREO", the same monaural sound is reproduced in the both of the right and left channels.
- Some discs are recorded at 96 kHz of sampling frequency. When this type of disc is played on a compatible player and signals are digitally (DIGITAL 1/2) sent to this unit, the sound mode is changed to "STEREO" automatically. The sound mode cannot be changed during playback.

■ Listening to sounds in the Dolby virtual speaker mode (DVS) (3.1ch, etc.)

If the surround speakers cannot be placed behind you, place them in front and set the DVS mode. You can enjoy the same surround effects as the multi channel mode (5.1 channel, etc.).

- 1 While the disc is playing, press the MULTI-CH or STEREO button.**
- 2 Set the MODE 1/MODE 2 switch to MODE 2 and press the DVS button.**
- 3 Within 3 seconds, press the ◀ or ▶ button.**

The diagram illustrates the DVS mode selection process. It shows a "MULTI-CH" button and a "STEREO" button. Below them is a "MODE 2" switch and a "DVS" button. An arrow points to the "DVS" button. To the right, a "5 DISCS" button is shown. Below the "DVS" button, a vertical stack of three boxes represents the speaker layout options: "DVS OFF", "5. 1REF", and "3. 1WIDE". Arrows indicate the selection path: from "DVS OFF" to "5. 1REF", and from "5. 1REF" to "3. 1WIDE".

Listening to the 5.1ch

DVS OFF:
Normal multi channel mode.

5.1REF:
Surround effects are created as if the front speakers and surround speaker were placed in front and another surround speaker was set behind.

Listening to the 2ch

DVS OFF:
Normal 2 channel stereo sound.

3.1REF:
Front speakers create surround effects as if all the other speakers were also placed.

3.1WIDE
You can enjoy surround effects as if the sound field was more spacious than that of 3.1REF.

Enjoying surround sound (sound mode) (continued)

Dolby Digital



Disc with this trademark

Unit display

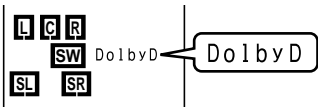

One of the digital audio systems for theatrical use. You can enjoy the stereophonic effect in the home theater system. When you set the audio output to Dolby Digital for a disc recorded in Dolby Digital, the "DolbyD" indicator lights up (see page 28).

DTS (Digital Theater Systems)



Disc with this trademark

Unit display

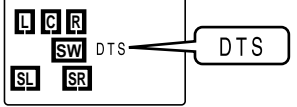

One of the digital audio systems for theatrical use. As the sound quality is emphasized, you can enjoy the realistic sound effect in the home theater system. When you set the audio output to DTS for a disc recorded in DTS, the "DTS" indicator lights up (see page 28).

Unit display



Linear PCM
A signal recording format without compression
Used in DVD and CD featuring a musical or concert.

Dolby Pro Logic II
Stereo-recorded discs and video tapes
Dolby Pro Logic II decodes 2 channel stereo sound from discs, videotapes, etc. to reproduce 5.1 channel surround sound. You can enjoy a three-dimensional sound field.

When Dolby Pro Logic II is activated, the "Dolby PLII" indicator lights up.

■ Audio signal/Speaker indicators

Audio signal indicators light up for the corresponding audio source, and speaker indicators are illuminated according to signals sent to the speakers.

- (1) Left Front Speaker Indicator
- (2) Left Indicator
- (3) Center Indicator
- (4) Center Speaker Indicator
- (5) Right Indicator
- (6) Right Front Speaker Indicator
- (7) Low Frequency Effect Indicator
- (8) Subwoofer Indicator
- (9) Left Surround Speaker Indicator
- (10) Left Surround Indicator
- (11) Surround Monaural Signal Indicator
(Lights up when the surround speakers receive monaural signals.)
- (12) Right Surround Indicator
- (13) Right Surround Speaker Indicator

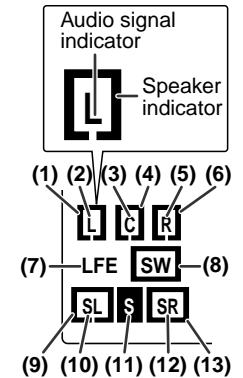

Example:

When 2.1 channel audio signals (L, R, LFE) are received, the audio signal indicators "L", "R" and "LFE" light up. The illustration on the right indicates that 2 channel stereo sound (L and R) is reproduced.

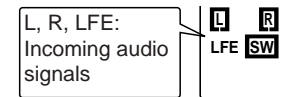

When Dolby Pro Logic II is activated

2 channel stereo sound is converted to 5.1 channel surround sound, and all the speaker indicators "□" light up.

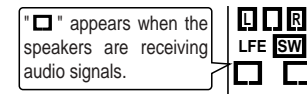

Notes:

- You can switch the audio output when the disc contains sounds of multiple audio formats (Dolby Digital, DTS, etc.). See page 28.
- Sound may not be produced from the subwoofer depending on the disc.
- You cannot change the multi channel mode or stereo mode while listening to the radio.

Changing the default settings of the amplifier

SD-AS10

Installation image (with optional accessories):

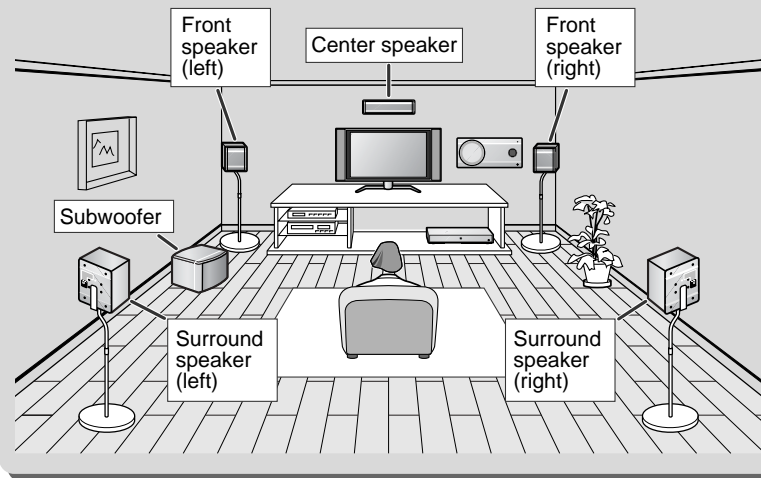

Change settings according to the connected speakers.

Speaker delay setting (See page 44.)

Speaker level setting (See page 45.)

Test tone (See page 45.)

Example:

If the right surround speaker is 10 feet (3.3 m) away from the listening position, change settings as shown below (adjust the SR).

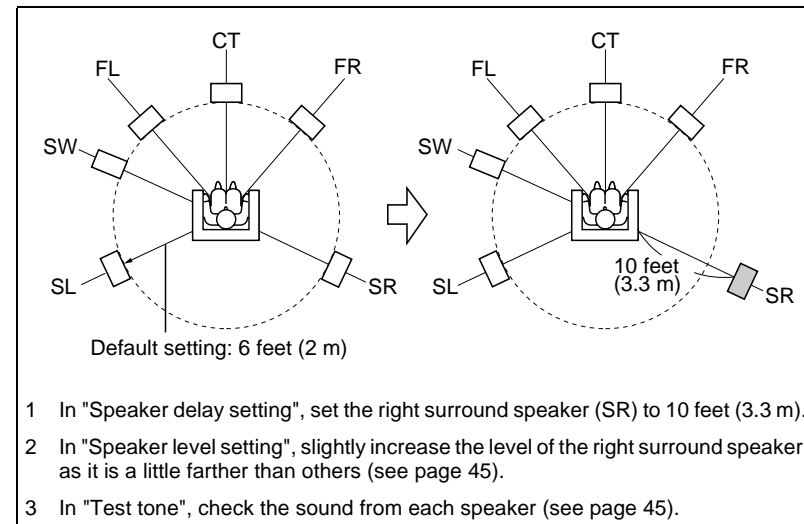

Note:

The subwoofer setting applies to a subwoofer connected to SUBWOOFER PREOUT.

Changing the default settings of the amplifier (continued)

Switch the function to "DVD" to change the default settings of the amplifier.

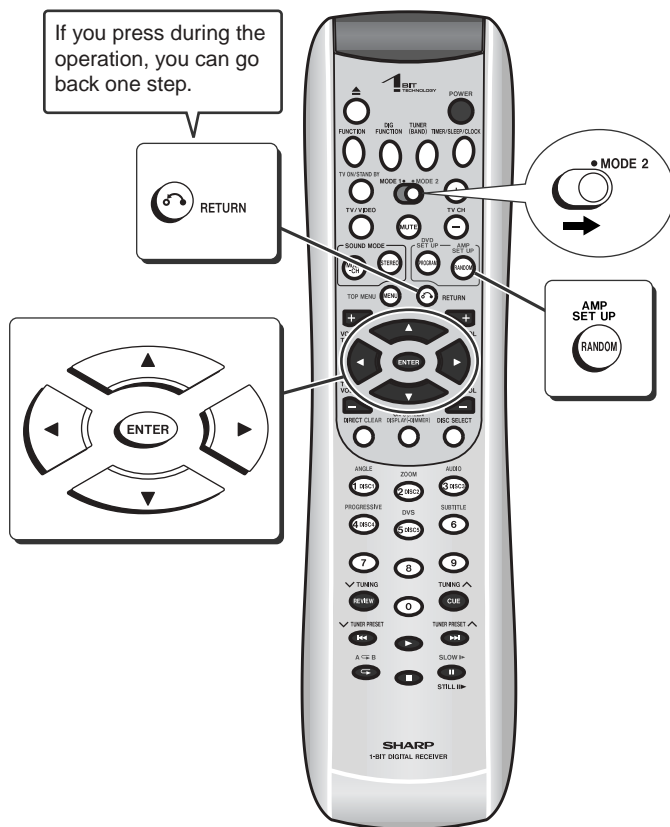

■ Speaker delay setting

When some of the speakers are at a different distance from the listening point, you can select the speaker delay to make it seem as though the speaker distances are the same.

1 Set the MODE 1/MODE 2 switch to MODE 2 and press the AMP SET UP button.

2 Within 10 seconds, press the ◀ or ▶ button to select "SP DELAY", and press the ENTER button.

SP DELAY

3 Within 30 seconds, press the ◀ or ▶ button to select the desired speaker.

The indicator of the selected speaker flashes.

SP DELAY
SR 06FT

L	C	R
SL	SW	SR

4 Within 30 seconds, press the ▲ or ▼ button to select the distance.

- You can change the distance in 1 foot (0.3 m) steps.
- To set the distance of other speakers, repeat the operation from step 3.

SP DELAY
SR 10FT

L	C	R
SL	SW	SR

5 Press ENTER button to confirm the setting.

6 Press the RETURN button twice.

The setting is complete.

Speaker type	Delay range	Default setting
FL Front speaker (Left)	1 to 29 ft	6 ft (2 m)
CT Center speaker	1 to 29 ft	6 ft (2 m)
FR Front speaker (Right)	1 to 29 ft	6 ft (2 m)
SR Surround speaker (Right)	1 to 29 ft	6 ft (2 m)
SL Surround speaker (Left)	1 to 29 ft	6 ft (2 m)
SW Subwoofer	1 to 29 ft	6 ft (2 m)

■ Speaker level setting

If sounds from the speakers are uneven, you can equalize them by adjusting the speaker levels.

- 1** Set the MODE 1/MODE 2 switch to MODE 2 and press the AMP SET UP button.
- 2** Within 10 seconds, press the ◀ or ▶ button to select "SP LEVEL", and press the ENTER button.

SP LEVEL
- 3** Within 10 seconds, press the ◀ or ▶ button to select the desired speaker.

SP LEVEL
 SR 0dB

LCR

SLSR

The indicator of the selected speaker flashes.
- 4** Within 10 seconds, press the ▲ or ▼ button to adjust the level.

SP LEVEL
 SR + 3dB

LCR

SLSR

 - You can adjust the level at 1 dB intervals.
 - To adjust the levels of other speakers, repeat the operation from step 3.
- 5** Press the RETURN ↶ button twice.

The setting is complete.

Speaker type		Level range	Default setting
FL	Front speaker (Left)	- 6 dB to + 6 dB	0 dB
CT	Center speaker	- 6 dB to + 6 dB	0 dB
FR	Front speaker (Right)	- 6 dB to + 6 dB	0 dB
SR	Surround speaker (Right)	- 6 dB to + 6 dB	0 dB
SL	Surround speaker (Left)	- 6 dB to + 6 dB	0 dB
SW	Subwoofer	- 10 dB to + 10 dB	+ 3 dB

Note:

If subwoofer sound is distorted, lower the subwoofer level.

■ Test tone

You can check each speaker sound by a test tone. Readjust the volume set in "Speaker level setting".

- 1** Set the MODE 1/MODE 2 switch to MODE 2 and press the AMP SET UP button.
- 2** Within 10 seconds, press the ◀ or ▶ button to select "TONE", and press the ENTER button.

TONE

The test tone will be heard from each speaker, in order, at about 2-second intervals.

```

      graph LR
        FL --> CT
        CT --> FR
        SW --> SL
        SL --> SR
      
```

To adjust speaker levels
 While the test tone is heard:
 Adjust the level with the ▲ or ▼ button.
 Press the ◀ or ▶ to select a speaker.
- 3** Press the RETURN ↶ button twice.

The setting is complete.

Changing the initial setting of DVD

A new setting will be retained even if the unit is set to the stand-by mode. If you want to restore or change the setting, reset it.

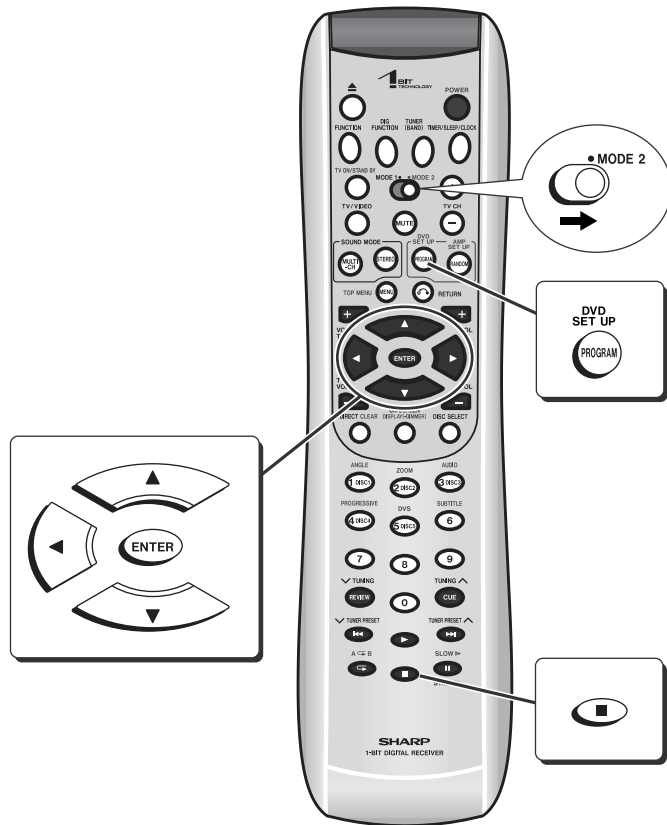

1 Press the button, set the MODE 1/MODE 2 switch to MODE 2 and press the DVD SET UP button.

2 Press the or button to select the main menu and press the ENTER button.

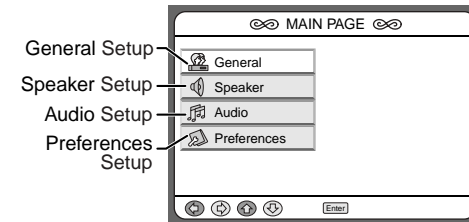

3 Press the or button to select the submenu and press the ENTER button.

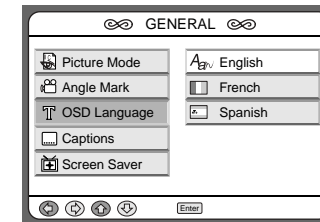



- To return to the previous display, press the button.
- For details on submenu items, see pages 47, 48.

4 Press the or button to change the setting and press the ENTER button.

- To return to the previous display, press the button.
- To change other settings, begin from step 2.

5 Press the DVD SET UP button.

The new setting is memorized.

Setting	Selectable parameters (* indicates initial settings.)	Description	
General 	Picture Mode	Auto	<u>Images are automatically optimized according to the video source.</u>
		Film	<u>Suitable for progressive video output. Select for DVD movies, etc.</u>
		Video	<u>Suitable for interlaced video output. Select for DVD karaoke, etc.</u>
		Smart	<u>Optimize special effects for progressive video output.</u>
		Super Smart*	<u>Special effects are enhanced more than "Smart".</u>
	Angle Mark	ON*	<u>You can switch camera angles if recorded on the disc.</u>
		OFF	<u>The angle mark does not appear.</u>
OSD Language	English* French Spanish	<u>You can select the desired OSD (On Screen Display) language for the setup menu or playback control screen.</u>	
Screen Saver	ON*	<u>Press the ■ button. After 5 minutes or more of inactivity, a screen saver appears.</u> <u>To turn off the screen saver on the screen, press any button on the main unit or remote control.</u>	
	OFF	<u>Cancel the screen saver setting.</u>	
Audio 	Audio Out	BIT STREAM*	<u>Choose this when connecting the unit to a Dolby Digital/DTS (5.1 ch) surround amplifier. When playing a DVD recorded in Dolby Digital or DTS, bitstream output allows you to enjoy the 5.1 ch surround sound.</u>
		PCM	<u>Choose this for PCM output. When playing a DVD recorded in Dolby Digital, the output converts to 2-channel PCM. When a DVD recorded in DTS is played back, signals are sent in bitstream.</u>
	LPCM Output	48K LPCM 48k 96K LPCM 96k*	<u>If 48K LPCM 48k is selected, PCM sound signals recorded at 96 kHz are converted to 48 kHz.</u>

Changing the initial setting of DVD (continued)

Setting	Selectable parameters (* indicates initial settings.)	Description
	TV Display	Normal/PS When playing a wide image (16:9) disc, the left and right sides of the image are cut (pan scan) to display a natural-looking 4:3 size image. A 4:3 disc is played in 4:3.
		Normal/LB* When playing a wide image (16:9) disc, black bands are inserted at the top and bottom and you can enjoy full wide images (16:9) on a 4:3 size TV. A 4:3 disc is played in 4:3.
		Wide A wide image (16:9) is displayed when playing a wide image (16:9) disc. <ul style="list-style-type: none"> ● When playing a 4:3 image disc, the image size depends on the setting of the connected TV. ● If you play back a wide image (16:9) disc with the unit connected to a 4:3 TV, images appear stretched vertically.
	Audio	English* French Spanish Chinese Japanese Others A language for audio can be set. <u>You can specify a language for dialogues and narration.</u>
	Subtitle	English* French Spanish Chinese Japanese Others OFF A language for subtitle can be set. The subtitle is displayed in a specified language.
	Disc Menu	English* French Spanish Chinese Japanese Others A language for disc menus can be set. Menu screens are displayed in a specified language.
	Country Code	Hong Kong Japan Taiwan GBR USA* Set a country code according to parent control level of the disc.
	Parental	1 Only DVD software intended for children can be played back.
		2, 6PGR to 7 NC-17 Only DVD software intended for general use and children can be played back.
		8 ADULT DVD software of any grade (adult/general/children) can be played back.
NO_PARENTAL* <u>Parental control is canceled.</u>		
Defaults	Defaults This resets all settings, except for Parental and Password, to the factory defaults.	
Password	- - - - <u>Change the password (for details, see page 49).</u>	

■ Parental setting

- 1** Select "Preferences" on the setup menu screen (see steps 1 - 2 on page 46).
- 2** After selecting "Parental" in step 3 on page 46, select the parental level and press the ENTER button.
- 3** Enter a 4-digit password using the direct number buttons and press the ENTER button.
If this is the first time, enter "0000".

Note:

While playing a disc with parental control, the display may appear requesting a password in order to watch some restricted scenes. In such a case, enter the password to temporarily change the control level.

■ Password setting

From the setup menu, select "Preferences" and then "Password" A screen appears.

- 1** Enter the old password using the direct number buttons.
- 2** Enter the new password using the direct number buttons.
- 3** Enter the new password again for confirmation.

Note:

When you forget your password, cancel the current password by pressing "3308" using the direct number buttons (0 - 9).

■ Selecting a language for "Others"

Check the code of the language (See the language code list on page 65).
Example: When you select 1229 (Hungarian)

- 1** Select "Preferences" on the setup menu screen (see steps 1 - 2 on page 46).
- 2** After selecting "Audio", "Subtitle" or "Disc Menu" in step 3 on page 46, select "Others" and press the ENTER button.
- 3** Set the MODE 1/MODE 2 switch to MODE 1.
- 4** Enter "1229" with the direct number buttons and press the ENTER button.

Setting the timer

The unit starts playback or turns on the radio at a specified time. This unit has 2 types of timer functions: "once timer" and "daily timer".

Once timer:

Once timer playback works for one time only at a preset time.

Use when...

You want to listen to a radio program on the day.

(After operation, the timer setting is canceled.)

Daily timer:

Daily timer playback works at the same preset time every day.

Use when...

You want to use the timer as a wake-up call, or listen to the radio at the same time every day.

You can use the once timer and daily timer together.

For example, use the timer as a wake-up call (daily timer), and listen to the radio later on the day.

1 Set the daily timer (pages 50 - 51).

2 Set the once timer (pages 50 - 51).

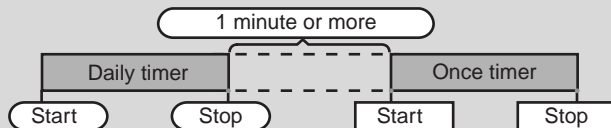

Notes:

If both timers are set for the same time, the once timer setting will start.

When using both timers, allow at least 1 minute between operations. Otherwise the timer used later will not work.

Before setting timer:

1 Set the clock (see page 21).

If the clock is not set to the correct time, the timers do not work properly.

2 Prepare a source to play back.

- Insert a disc to play.
- To use the radio for timer playback, store a station (see page 39).

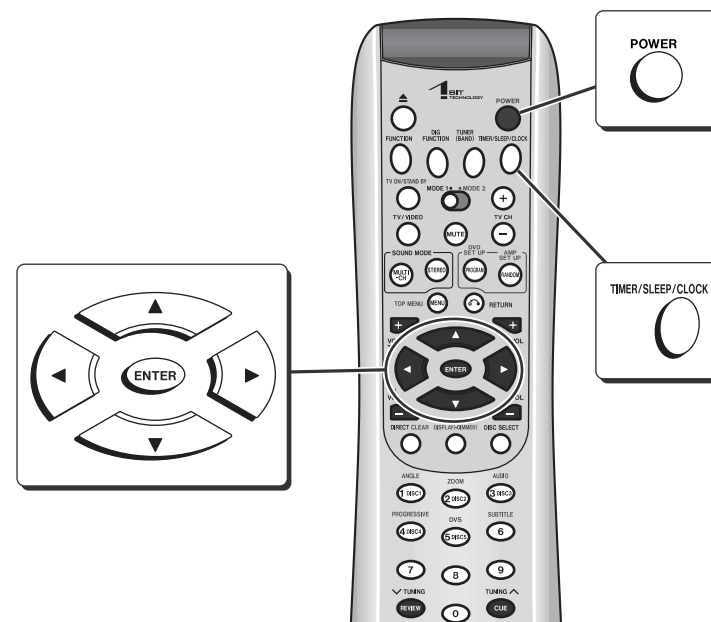

Notes:

- When you use the timer to play a DVD with a menu screen, playback stops at the menu screen.
- If the unit is unplugged or a power failure occurs after timer setting, the clock stops and the timer setting will be canceled. Set the clock and timer again.
- You cannot use the timer to operate other equipment.
- Timer playback does not start if the unit is turned on at the start time.

1 Turn on the unit, and press the **TIMER/SLEEP/CLOCK** button.

2 Within 10 seconds, press the **▲** or **▼** button to select "**ONCE TIMER**" or "**DAILY TIMER**", and press the **ENTER** button.

Once timer

Daily timer

```

ONCE TIMER
DAILY ----
ONCE ----
SLEEP ----
  
```

```

DAILY TIMER
DAILY ----
ONCE ----
SLEEP ----
  
```

3 Within 10 seconds, press the **▲** or **▼** button to select "**ONCE SET**" or "**DAILY SET**", and press the **ENTER** button.

Once timer

Daily timer

```

ONCE SET
DAILY ----
ONCE ----
SLEEP ----
  
```

```

DAILY SET
DAILY ----
ONCE ----
SLEEP ----
  
```

4 Press the **◀** or **▶** button to adjust the hour and then press the **ENTER** button.

```

ON 7:00AM
DAILY ----
ONCE ----
SLEEP ----
  
```

5 Press the **◀** or **▶** button to adjust the minutes and then press the **ENTER** button.

```

ON 7:30AM
DAILY ----
ONCE ----
SLEEP ----
  
```

6 Set the time to finish as in steps 4 and 5 above.

```

OFF 8:30AM
DAILY ----
ONCE ----
SLEEP ----
  
```

7 Switch the input with the **◀** or **▶** button, and then press the **ENTER** button.

- Available playback sources: DVD/CD, TUNER, DIGITAL 1, DIGITAL 2, TV and VCR.
- If you select DIGITAL 1, DIGITAL 2, TV or VCR, connect the unit to the corresponding equipment and set the timer.
- When you select "TUNER", select a station by pressing the **◀** or **▶** button, and then press the **ENTER** button.
- If a station has not been programmed, "NO P.SET" will be displayed and timer setting will be canceled.

Preset channel number

```

P.1 87.7M
  
```

8 Adjust the volume with the **◀** or **▶** button and press the **ENTER** button.

Do not set the volume too high.

```

VOLUME 15
DAILY ----
ONCE ----
SLEEP ----
  
```

9 The following appear and the setting for each item is displayed.

Once timer

Daily timer

```

ONCE TIMER
DAILY ----
ONCE PLAY
SLEEP ----
  
```

```

DAILY TIMER
DAILY PLAY
ONCE ----
SLEEP ----
  
```

10 Press the **POWER** button to enter the power stand-by mode.

- The unit enters the timer stand-by mode.
(The timer set indicator lights up. See page 52.)
- The timer setting is retained.

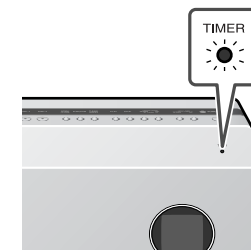

Operations after setting the timer

1 After setting the timer

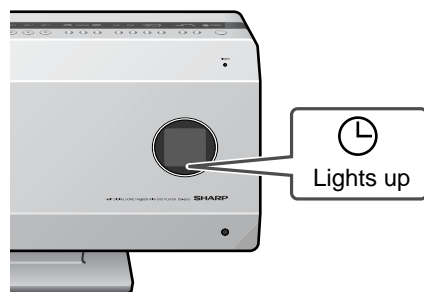

- The unit is in the timer stand-by mode.
- If the timer set indicator does not light up, turn on the power and set the timer again.

2 At the start time

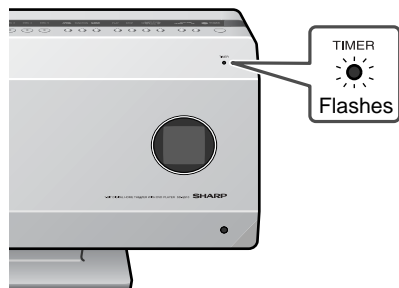

The volume will increase gradually until it reaches the preset volume.

3 When the finish time is reached

The unit is set to the power stand-by mode automatically.

■ Checking the timer setting

- 1 Press the TIMER/SLEEP/CLOCK button.
- 2 Within 10 seconds, press the ▲ or ▼ button to select "ONCE TIMER" or "DAILY TIMER", and press the ENTER button.
- 3 Within 10 seconds, press the ▲ or ▼ button to select "ONCE CALL" or "DAILY CALL", and press the ENTER button.
The unit returns to the timer stand-by mode after displaying the settings in order.

■ Canceling the timer setting

- 1 Press the TIMER/SLEEP/CLOCK button.
- 2 Within 10 seconds, press the ▲ or ▼ button to select "ONCE TIMER" or "DAILY TIMER", and press the ENTER button.
- 3 Within 10 seconds, press the ▲ or ▼ button to select "ONCE OFF" or "DAILY OFF", and press the ENTER button.
Timer will be canceled (the setting will be retained).

■ Changing the timer setting

Perform steps 1 - 10 on page 51 to set the timer again.

■ To use the same timer setting

Once timer:

- 1 Turn on the unit, and press the TIMER/SLEEP/CLOCK button.
- 2 Within 10 seconds, press the ▲ or ▼ button to select "ONCE TIMER", and press the ENTER button.
- 3 Within 10 seconds, press the ▲ or ▼ button to select "ONCE ON", and press the ENTER button.
- 4 Press the POWER button to enter the power stand-by mode.

Daily timer:

The timer will operate at the same time every day. It will continue until the daily timer setting is canceled. Cancel the daily timer when it is not in use.
When you use the same setting for the daily timer, select "DAILY TIMER" instead of "ONCE TIMER", and select "DAILY ON" instead of "ONCE ON".

Sleep timer

The unit turns off at a specified time when listening to a disc or the radio.

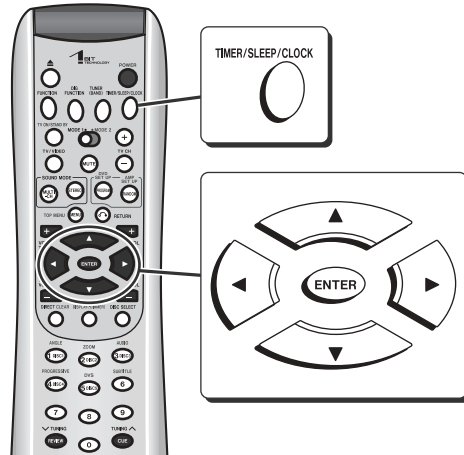

1 During playback, press the **TIMER/SLEEP/CLOCK** button.

2 Within 10 seconds, press the **▲** or **▼** button to select "SLEEP", and press the **ENTER** button.

```
SLEEP
DAILY ----
ONCE ----
SLEEP 60m
```

3 Press the **◀** or **▶** button to select the time.

The default is 60 minutes. Time changes by 5 minutes (5 - 120) and decreases by 1 minute (5 - 1).

```
SLEEP
DAILY ----
ONCE ----
SLEEP 30m
```

4 Press the **ENTER** button.

- The unit will enter the power stand-by mode automatically after the preset time has elapsed.
- The volume will be turned down 1 minute before the sleep operation finishes, and then you cannot change the volume.

```
SLEEP
```

To confirm the remaining sleep time:

- 1 Press the **TIMER/SLEEP/CLOCK** button.
- 2 Within 10 seconds, press the **▲** or **▼** button to select "SLEEP". When the remaining time appears, you can change the time.

To cancel the sleep operation:

Press the **POWER** button while "SLEEP" is indicated.

To cancel the sleep operation without setting the unit to the stand-by mode, proceed as follows.

- 1 Press the **TIMER/SLEEP/CLOCK** button.
- 2 Within 10 seconds, press the **▲** or **▼** button to select "SLEEP OFF".
- 3 Within 10 seconds, press the **ENTER** button. ("SLEEP" goes out.)

```
SLEEP OFF
DAILY ----
ONCE ----
SLEEP 24m
```

■ To use timer and sleep operation together

For example, you can fall asleep to the radio, and wake up to CD.

- 1 Set the sleep time (steps 1 - 4).
 - 2 Set the timer playback (steps 1 - 8, page 51).
- Make sure timer playback does not start while sleep timer is active.

The unit enters into the power stand-by mode after the time set for sleep timer, and turns on at the start time of timer playback.

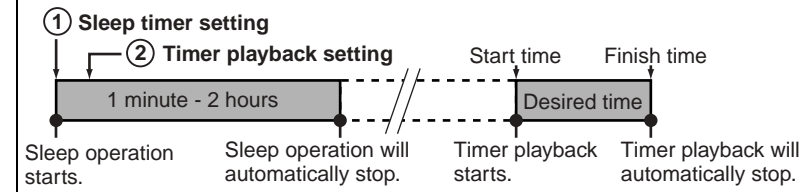

Operating the connected TV

You can operate Sharp TVs with the remote control. Change the remote control setting if operating other manufacturers' TV, or if you cannot operate a Sharp TV.

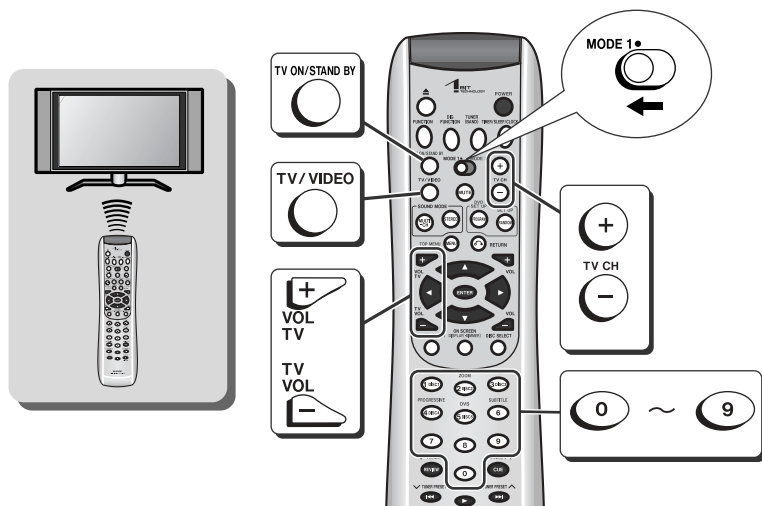



■ Watching TV

1 Press the TV ON/STAND BY button to turn on the TV.

2 Press the TV CH (- or +) button to set the channel.

Other buttons available for operating TVs

Operation	Button
Volume control	 
Switching the input	

■ Changing the TV registration

1 While holding down the TV ON/STAND BY button, set the MODE 1/ MODE 2 switch to MODE 1 and enter the manufacturer setting number (4 digits).

2 Release the TV ON/STAND BY button.

The setting is registered and the TV can be operated with the remote control of this unit.

Notes:

- You cannot operate some Sharp TVs with the remote control.
- As for manufacturers with 2 or more setting numbers, select one with which you can operate the TV.
- Once you set a number, the number previously memorized will be canceled.
- After replacing the batteries in the remote control, the registered number may automatically be set to 1044 (SHARP). If it occurs, register the desired number again.
- Registration cannot be executed depending on TVs. Even if numbers can be set, some buttons may not work.

TV manufacturer	Setting number	TV manufacturer	Setting number
SHARP	1011, 1025, 1044(*)	BELL & HOWELL	1005, 1021
AIWA	1052	BROCKWOOD	1007
ADMIRAL	1037	BROKSONIC	1032, 1037
AIKO	1019	CANDLE	1009, 1015
AKAI	1009	CARNIVALE	1009
ALARON	1031	CARVER	1014, 1026
AMBASSADOR	1029	CELEBRITY	1001
AMPRO	1045	CINERAL	1019, 1036
AMSTRAD	1034	CITIZEN	1009, 1011, 1015, 1016, 1019
ANAM	1004, 1024, 1035		
ANAM NATIONAL	1024, 1035	CME	1039
AOC	1007, 1009	CONCERTO	1015
AUDIOVOX	1019, 1036, 1041	CRAIG	1024
BAUR	1039	CROSLEY	1014
BELCOR	1007	CROWN	1011

(*): The default manufacturer number is 1044 (SHARP).

TV manufacturer	Setting number	TV manufacturer	Setting number
CURTIS MATHES	1005, 1009, 1011, 1012, 1013, 1014, 1015, 1016, 1020, 1021, 1036, 1038, 1044, 1048, 1050	INTEQ	1006
		INTERFUNK	1039
		JBL	1014
		JCB	1001
		JVC	1018, 1023
		KENWOOD	1007, 1009
DAEWOO	1007, 1011, 1017, 1019, 1021, 1036, 1041, 1042	KONIG	1039
		KTV	1009, 1011
		LG	1015
DAYTRON	1007	LOEWE	1039
DENON	1020	LOGIK	1005
DUMONT	1006, 1007	LUXMAN	1015
DWIN	1044, 1046	LXI	1012, 1014, 1021, 1022, 1030
ELECTRONBAND	1001	MAGNAVOX	1009, 1014, 1031
EMERSON	1007, 1010, 1011, 1021, 1029, 1030, 1031, 1032, 1037, 1041, 1042	MAJESTIC	1005
		MARANTZ	1009, 1014
		MEGATRON	1020, 1030
		MEMOREX	1005, 1015, 1021, 1030, 1037
ENVISION	1009	METZ	1007, 1009, 1030
ETRON	1043	MGA	1007, 1009, 1028
FISHER	1021	MIDLAND	1006, 1011, 1012, 1013
FORTRESS	1044	MINOKA	1034
FUJITSU	1031	MINUTZ	1008
FUNAI	1027, 1031	MITSUBISHI	1007, 1030, 1039
GE	1008, 1012, 1013, 1030, 1036, 1048, 1050	MTC	1007, 1009, 1015, 1016, 1039
		NAD	1022, 1030
GIBRALTER	1006, 1007, 1009	NEC	1007, 1009, 1015, 1026
GOLDSTAR	1002, 1007, 1009, 1011, 1015, 1030	NIKKO	1009, 1019, 1030
GRADIENTE	1015, 1026	NTC	1019
GRANADA	1033	OPTIMUS	1021
GRUNPY	1031	OPTONICA	1025, 1044
HALLMARK	1030	ORION	1031, 1032, 1037
HARLEY DAVIDSON	1031	OSAKA	1034
HARMAN/KARDON	1014		
HCM	1034		
HITACHI	1010, 1015, 1020		
INFINITY	1014		

TV manufacturer	Setting number	TV manufacturer	Setting number		
OTTO	1039	SCOTT	1007, 1030, 1031, 1032		
PANASONIC	1013, 1024				
PENNEY	1003, 1007, 1008, 1009, 1011, 1012, 1013, 1015, 1016, 1022, 1030, 1050	SEARS	1012, 1014, 1015, 1021, 1022, 1027, 1030, 1031		
		SEMP	1022		
		SHOGUN	1007		
		SIGNATURE	1005		
		SONY	1001		
PHILCO	1007, 1009, 1014, 1020, 1037	SOUNDESIGN	1030, 1031		
PHILIPS	1014	SQUAREVIEW	1027		
PILOT	1007, 1009, 1011	SSS	1007		
PIONEER	1010, 1028	SUPREME	1001		
PORTLAND	1007, 1011, 1019	SYLVANIA	1009, 1014		
PRISM	1013	SYMPHONIC	1027		
PROSOCAN	1012	TANDY	1044		
PROTON	1030, 1038	TECHNICS	1013		
PULSAR	1006, 1007	TECHNOL ACE	1031		
QUASAR	1013, 1025	TECHWOOD	1013, 1015		
QUELLE	1039	TEKNIKA	1005, 1007, 1011, 1014, 1015, 1016, 1019, 1031		
RADIO SHACK	1007, 1009, 1011, 1012, 1015, 1028, 1030			TELEFUNKEN	1015
				THORN	1039
				TMK	1015, 1029, 1030
RCA	1007, 1010, 1012, 1013, 1044, 1047, 1048, 1049, 1050, 1051	TOSHIBA	1016, 1021, 1022		
		TOTEVISION	1011		
		VECTOR RESEARCH	1009		
		VICTOR	1023		
REALISTIC	1007, 1009, 1011, 1015, 1021, 1025, 1030	VIDIKRON	1014		
RUNCO	1006, 1009, 1040	VIDTECH	1007, 1030		
SAMPO	1009, 1011	WARDS	1005, 1007, 1008, 1009, 1014, 1015, 1025, 1030, 1031		
SAMSUNG	1007, 1009, 1015, 1016, 1030				
SAMSUX	1011	WHITE WESTINGHOUSE	1037, 1041, 1042		
SANSEI	1036	YAMAHA	1007, 1009		
SANSUI	1037	ZENITH	1005, 1006, 1019, 1037		
SANYO	1021, 1033				
SCIMITSU	1007				
SCOTCH	1030				

Connecting other equipment

Turn off the other equipment before making this connection.

- An optical digital cable, audio digital cable and audio cable are not included. Purchase a commercially available cable.
- If using an audio cable, purchase one without resistance. If you use an audio cable with resistance, sound volume will decrease.
- Plug in each cable fully to prevent noise interference.

Audio connection to TV

You can listen to TV sound from the speakers by connecting the amplifier unit using an optical digital cable or audio cable (not supplied).

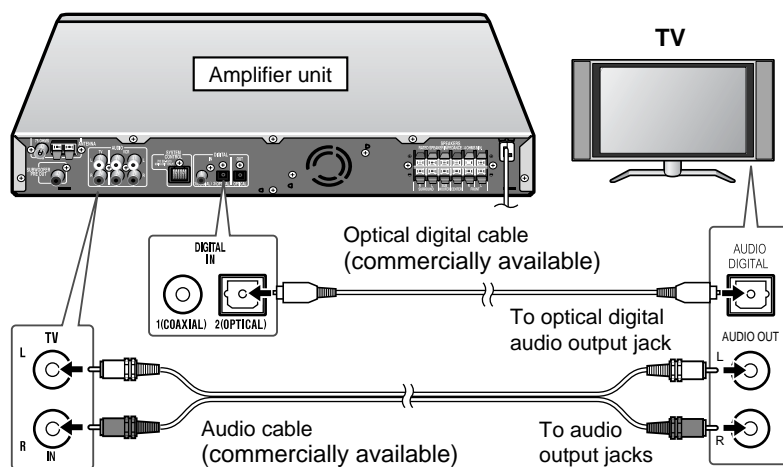

To listen to TV sound:

Turn the power on and press the FUNCTION button on the main unit.

Each press of this button changes the input in the order of "DIGITAL 1" → "DIGITAL 2" → "TV" → "VCR".

DIGITAL 2: The audio input is switched to "OPTICAL".

TV: The audio input is switched to "ANALOG 1".

You can also use the DIG FUNCTION (DIGITAL 1/DIGITAL 2) or FUNCTION (TV/VCR) button on the remote control.

Audio connection to VCR

You can listen to VCR sound from the speakers by connecting the amplifier unit using an audio cable (not supplied).

To record sound from the main unit, connect the VCR audio output jacks (amplifier) with audio input jacks (VCR).

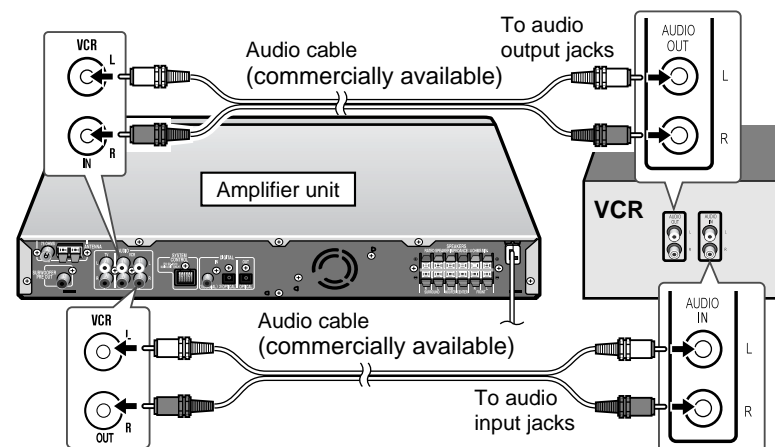

To listen to VCR sound:

Turn the power on and press the FUNCTION button on the main unit.

Each press of this button changes the input in the order of "DIGITAL 1" → "DIGITAL 2" → "TV" → "VCR".

VCR: The audio input is switched to "ANALOG 2".

You can also use the FUNCTION (TV/VCR) button on the remote control.

Notes:

- The audio VCR output jacks send signals coming from a DVD/CD, the tuner, audio TV input jacks and digital audio input jack. Signals from the audio VCR input jacks are not sent.
- When sending signals coming from the digital audio input jack via the audio VCR output jacks on the unit, set the stereo mode to STEREO (see page 41). In the multi channel mode, signals may not be sent properly. When sending signals from the digital audio input jack to the audio VCR output jacks, the audio output level decreases. (Leave headphones unplugged while recording to avoid further level decrease.)

■ Audio connection to digital tuner, etc.

You can listen to digital tuner sound from the speakers by connecting the amplifier unit using an audio digital cable (not supplied).

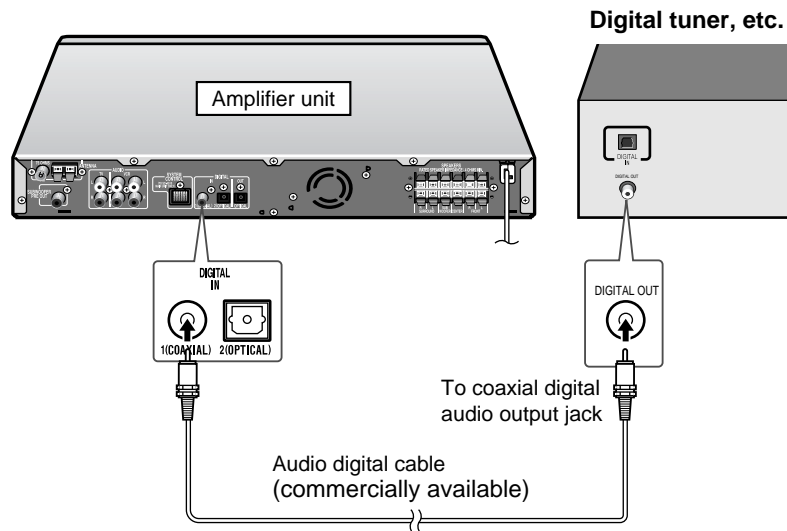

To listen to digital tuner, etc. sound:

Turn the power on and press the FUNCTION button on the main unit. Each press of this button changes the input in the order of "DIGITAL 1"→"DIGITAL 2"→"TV"→"VCR".

DIGITAL 1: The audio input is switched to "COAXIAL".

You can also use the DIG FUNCTION (DIGITAL 1/DIGITAL 2) button on the remote control.

■ Digital connection to a digital audio recorder, etc.

You can record sound on a digital audio recorder by connecting to the digital audio output jack using an optical digital cable.

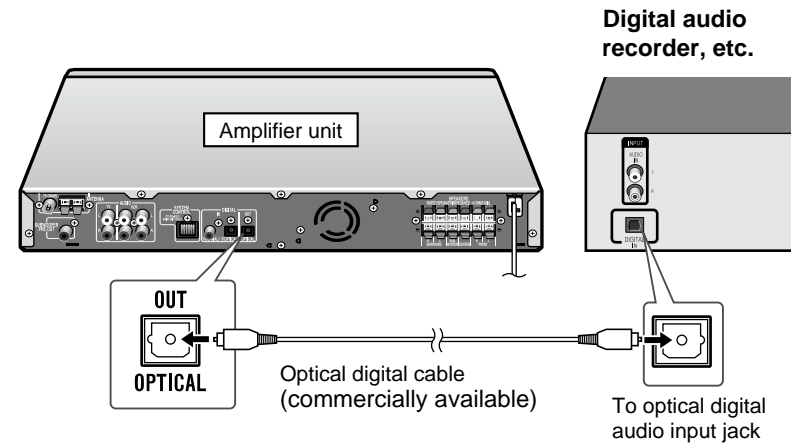

When connecting a digital audio recorder to the digital audio output jack, set "Audio Out" to "PCM" (see page 47).

BITSTREAM	For 5.1 channel Dolby Digital/DTS surround processors, etc.
PCM	For 2 channel digital input amplifiers, etc.

Notes:

- Some discs are copy protected and digital recording is not possible (including DTS signals).
- The digital audio output jack sends signals coming from a DVD/CD, the digital audio input jack. Signals from the tuner, audio TV input jacks and audio VCR input jacks are not sent.
- When you play DVD discs with Linear PCM sound recorded at a 96 kHz sampling rate, sound may be sampled at 96 kHz (or 48 kHz depending on the disc).
- Plug in each cable fully to prevent noise interference.
- When using the optical digital jack, remove the cap first. After using the jack, replace the cap.

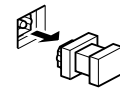

■ Using other subwoofer

You can connect a subwoofer with an amplifier to the subwoofer pre output jack.

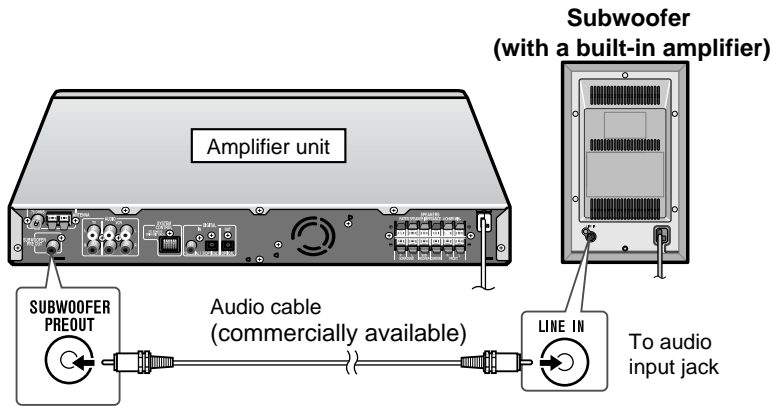

Notes:

- No sound is heard from the speaker in which an amplifier is not built in.
- When two subwoofers are connected, both subwoofers reproduce sound. Changes in the speaker setting apply to both subwoofers (see pages 44, 45).

■ Headphones

- Before plugging in or unplugging the headphones, reduce the volume.
- Be sure your headphones have a 1/8" (3.5 mm) diameter plug and are between 16 ohm and 50 ohm impedance. The recommended impedance is 32 ohms.
- While headphones are connected, sound is not produced from the speakers.
- You cannot use the surround feature with headphones.

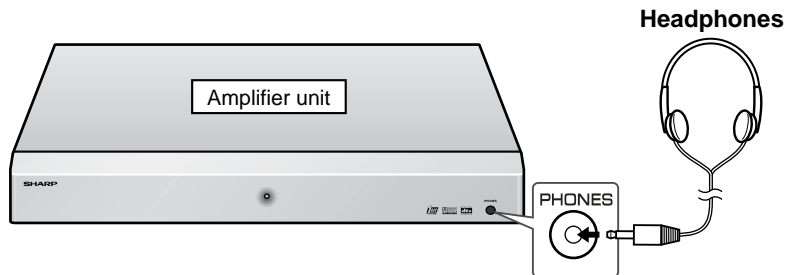

Language code list



Code	Language name	Code	Language name	Code	Language name
1027	Afar	1239	Interlingue	1483	Romanian
1028	Abkhazian	1245	Inupiak	1489	Russian
1032	Afrikaans	1248	Indonesian	1491	Kinyarwanda
1039	Amharic	1253	Icelandic	1495	Sanskrit
1044	Arabic	1254	Italian	1498	Sindhi
1045	Assamese	1257	Hebrew	1501	Sango
1051	Aymara	1261	Japanese	1502	Serbo-Croatian
1052	Azerbaijani	1269	Yiddish	1503	Singhalese
1053	Bashkir	1283	Javanese	1505	Slovak
1057	Byelorussian	1287	Georgian	1506	Slovenian
1059	Bulgarian	1297	Kazakh	1507	Samoaan
1060	Bihari	1298	Greenlandic	1508	Shona
1069	Bislama	1299	Cambodian	1509	Somali
1066	Bengali; Bangla	1300	Kannada	1511	Albanian
1067	Tibetan	1301	Korean	1512	Serbian
1070	Breton	1305	Kashmiri	1513	Siswati
1079	Catalan	1307	Kurdish	1514	Sesotho
1093	Corsican	1311	Kirghiz	1515	Sundanese
1097	Czech	1313	Latin	1516	Swedish
1103	Welsh	1326	Lingala	1517	Swahili
1105	Danish	1327	Laotian	1521	Tamil
1109	German	1332	Lithuanian	1525	Telugu
1130	Bhutanese	1334	Latvian, Lettish	1527	Tajik
1142	Greek	1345	Malagasy	1528	Thai
1144	English	1347	Maori	1529	Tigrinya
1145	Esperanto	1349	Macedonian	1531	Turkmen
1149	Spanish	1350	Malayalam	1532	Tagalog
1150	Estonian	1352	Mongolian	1534	Setswana
1151	Basque	1353	Moldavian	1535	Tonga
1157	Persian	1356	Marathi	1538	Turkish
1165	Finnish	1357	Malay	1539	Tsonga
1166	Fiji	1358	Maltese	1540	Tatar
1171	Faroese	1363	Burmese	1543	Twi
1174	French	1365	Nauru	1557	Ukrainian
1181	Frisian	1369	Nepali	1564	Urdu
1183	Irish	1376	Dutch	1572	Uzbek
1186	Scots Gaelic	1379	Norwegian	1581	Vietnamese
1194	Galician	1393	Occitan	1587	Volapuk
1196	Guarani	1403	(Afan) Oromo	1613	Wolof
1203	Gujarati	1408	Oriya	1632	Xhosa
1209	Hausa	1417	Panjabi	1665	Yoruba
1217	Hindi	1428	Polish	1684	Chinese
1226	Croatian	1435	Pashto, Pushto	1697	Zulu
1229	Hungarian	1438	Portuguese		
1233	Armenian	1463	Quechua		
1235	Interlingua	1481	Rhaeto-Romance		
		1482	Kirundi		

Error indicators and warnings

When you load an unplayable disc or fail to perform operations properly, the following messages are displayed on the unit and the TV screen.

Display	Meaning
CHECK CARRY	<ul style="list-style-type: none"> ● Disc is not carried. Try the operation again.
CHECK D**	<ul style="list-style-type: none"> ● <u>Changer drum cam is not moved.</u> Try the operation again.
CHECK LOCK	<ul style="list-style-type: none"> ● Disc tray is not locked. Try the operation again.
CHECK M**	<ul style="list-style-type: none"> ● <u>Changer mode cam is not moved.</u> Try the operation again.
CHECK SHUT	<ul style="list-style-type: none"> ● <u>Changer shutter is not closed.</u> Try the operation again. (*)
DSP NG	<ul style="list-style-type: none"> ● Place the unit away from noise source or plug the AC power cord to another AC outlet. (*)
Er.** (** indicates numbers/symbols.)	<ul style="list-style-type: none"> ● The unit considers the DVD mechanism is defective. ● The amplifier is defective. Set this unit to the stand-by mode and turn the power on again. (*)
ERROR CARRY	<ul style="list-style-type: none"> ● Disc is not carried. (*)
ERROR D**	<ul style="list-style-type: none"> ● Changer initial error. (*)
ERROR LOCK	<ul style="list-style-type: none"> ● Disc tray is not locked. (*)
ERROR M**	<ul style="list-style-type: none"> ● Changer initial error. (*)
FAN LOCK	<ul style="list-style-type: none"> ● The cooling fan on the back of the amplifier unit does not run due to foreign objects caught in it. Set this unit to the stand-by mode and remove the foreign objects around the fan.
NO DISC	<ul style="list-style-type: none"> ● The disc is not loaded. ● The disc is loaded with the label side toward you.
No Signal	<ul style="list-style-type: none"> ● The digital audio input jack is not connected properly. ● Unspecified signal is received and cannot be recognized.

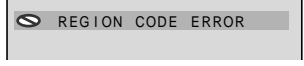
(*): Set the main unit to the stand-by mode and turn the power on again, or unplug and plug it back in. Should the same message appear, contact your local dealer where you purchased the unit.

TV screen	Meaning
	The disc cannot be played with this unit or the disc is loaded in an incorrect way.
	The region number of the DVD is not "1" or "ALL".
	A disc has not been loaded.
	<ul style="list-style-type: none"> ● You are trying to perform an incorrect operation. ● The operation is prohibited. ● The disc does not support the operation described in this operation manual.

Troubleshooting chart

Many potential problems can be resolved by the owner without calling a service technician.

If something is wrong with this product, check the following before calling your authorized SHARP dealer or service center.

■ General

Symptom	Possible cause	Reference page
The power is not turned on.	<ul style="list-style-type: none"> ● Is the unit unplugged? ● <u>Is the system cable connected?</u> 	P. 20 P. 17
No sound is heard.	<ul style="list-style-type: none"> ● Is the volume level set to "0"? ● Are the headphones connected? ● Are the speaker wires disconnected? 	P. 21 P. 58 P. 18
The sounds from speakers are not well balanced.	<ul style="list-style-type: none"> ● <u>Are the speaker wires connected to the wrong channels?</u> 	P. 18
Noise is heard during playback.	<ul style="list-style-type: none"> ● Move the unit away from any computers or mobile phones. 	—
When a button is pressed, the unit does not respond.	<ul style="list-style-type: none"> ● Set this unit to the power stand-by mode and then turn it back on. If the unit still malfunctions, reset it. 	P. 61
Interference or noise occurs on the TV image.	<ul style="list-style-type: none"> ● Is the unit placed near TV with internal antenna? Use an outdoor antenna. 	P. 17
Timer playback does not start.	<ul style="list-style-type: none"> ● Did you remove the plug from the AC outlet, or did a power failure occur? Reset the clock and timer. 	P. 21, 51
The display on the unit is dark.	<ul style="list-style-type: none"> ● Is the display in the dimmer mode? 	P. 21
No images are displayed.	<ul style="list-style-type: none"> ● Is TV turned on? ● Is the input of TV switched? 	P. 54 P. 54

■ DVD/CD player

Symptom	Possible cause	Reference page
Playback sounds are skipped.	<ul style="list-style-type: none"> ● Is the disc very dirty? ● Does the disc satisfy the standards? ● Is the unit located near excessive vibrations? ● Has condensation formed inside the unit? 	— — — P. 61
The control buttons do not function. Music or video playback is interrupted.	<ul style="list-style-type: none"> ● Is the disc very dirty? ● Does the disc satisfy the standards? ● Is the unit located near excessive vibrations? ● Has condensation formed inside the unit? 	— — — P. 61
Pictures and sound are skipped.	<ul style="list-style-type: none"> ● Is the disc very dirty? ● Is the unit located near excessive vibrations? ● Has condensation formed inside the unit? 	— — P. 61
The system does not operate even if the power is on.	<ul style="list-style-type: none"> ● <u>Is a disc other than a DVD (region number 1 or ALL), audio CD, MP3, WMA or JPEG loaded?</u> 	P. 9
Image cannot be played back. (Sound is not heard.)	<ul style="list-style-type: none"> ● Are the video and audio cables connected improperly? ● <u>Is a disc other than a DVD (region number 1 or ALL), audio CD, MP3, WMA or JPEG loaded?</u> ● Is the disc very dirty? ● <u>Is the disc loaded with the label side toward you.</u> ● Clean the optical pickup if it is dirty. ● Is the TV input set to "VIDEO 1/VIDEO 2" etc.? ● Is the unit turned on? 	P. 19, 56 P. 9 — — P. 62 P. 54 P. 20

■ Tuner

Symptom	Possible cause	Reference page
The radio makes unusual noises continuously.	<ul style="list-style-type: none"> ● Is the unit placed near the TV or computer? ● Is the FM antenna or AM loop antenna placed properly? Move the antenna away from the AC power cord or the unit if located near. 	— —
The preset channel cannot be recalled.	<ul style="list-style-type: none"> ● Did you remove the plug from the AC outlet, or did a power failure occur? Preset the channel again. 	P. 39

■ Remote control

Symptom	Possible cause	Reference page
The remote control does not operate properly.	● Is the battery polarity respected?	P. 20
	● Are the batteries dead?	—
	● Is the distance or angle incorrect?	P. 20
	● Are there any obstructions in front of the unit?	—
	● Is the remote control sensor exposed to strong light (inverter fluorescent light, direct sunlight, etc.)?	P. 20
The unit cannot be turned on with the remote control.	● Is the remote control for another equipment used simultaneously?	—
	● Is the AC power cord of the unit plugged in?	P. 20
<u>The unit performs unintended operations.</u>	● Are the batteries inserted?	P. 20
	● <u>Is the MODE 1/MODE 2 switch set correctly?</u>	P. 12, 13

■ Condensation

Sudden temperature changes, storage or operation in an extremely humid environment may cause condensation inside the cabinet (laser pickup, etc.) or on the transmitter on the remote control.

Condensation can cause the unit to malfunction. If this happens, leave the power on with no disc in the unit until normal playback is possible (about 1 hour). Wipe off any condensation on the transmitter with a soft cloth before operating the unit.

■ If trouble occurs

When this product is subjected to strong external interference (mechanical shock, excessive static electricity, abnormal supply voltage due to lightning, etc.) or if it is operated incorrectly, it may malfunction.

If such a problem occurs, do the following:

- 1 Set the unit to the stand-by mode and turn the power on again.
- 2 If the unit is not restored in the previous operation, unplug and plug in the unit, and then turn the power on.

Note:

If neither operation above restores the unit, clear all the memory by resetting it.

Clearing all the memory (reset)

- 1 Press the POWER button to enter the power stand-by mode.
- 2 While holding down the DISC 5 button and the STOP button, press the POWER button for 2 seconds or more.
- 3 When "ALL CLEAR" appears, press the POWER button to enter the stand-by mode.
- 4 Press the POWER button again to turn on the unit.

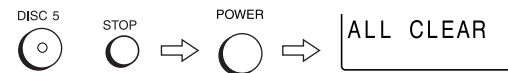

Caution:

- When you reset, all data is deleted and the settings return to the default. (DVD initial settings are retained.)
- If problem occurred, the power turns off and the timer set indicator will blinking.

Maintenance

■ Cleaning the cabinet

Periodically wipe the cabinet with a soft cloth and a diluted soap solution, then with a dry cloth.

- Do not use chemicals for cleaning (gasoline, paint thinner, etc.). It may damage the cabinet finish.
- Do not apply oil to the inside of the unit. It may cause malfunctions.

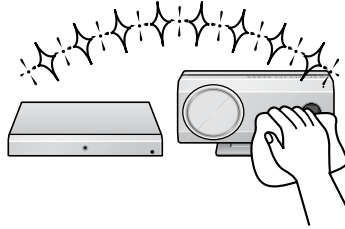

■ Cleaning the laser pickup lens

In order to ensure proper operation of the DVD player, preventative maintenance (cleaning of the laser pickup lens) should be performed periodically. Lens cleaners are commercially available. Contact your local DVD software dealer for options.

Notes:

- Close the disc compartment when it is not used.
- Be careful not to damage the optical pickup or to touch it by hand.

■ Care of discs

Discs are fairly resistant to damage, however mistracking can occur due to an accumulation of dirt on the disc surface. Follow the guidelines below for maximum enjoyment from your disc collection and player.

- Do not write on either side of the disc, particularly the non-label side from which signals are read. Do not mark this surface.
- Keep your discs away from direct sunlight, heat, and excessive moisture.
- Always hold the discs by the edges. Fingerprints, dirt, or water on the discs can cause noise or mistracking. If a disc is dirty or does not play properly, clean it with a soft, dry cloth, wiping straight out from the center, along the radius.

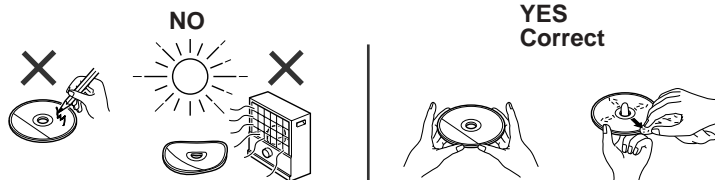

Optional accessories

Use only the specified optional accessories to operate this product properly. For speaker installation, read instructions supplied with stands or brackets.

MAIN UNIT WALL BRACKET	FLOOR SPEAKER STAND	SPEAKER WALL BRACKET
Model: AD-AS10WA	Model: AD-AT12ST	Model: AD-AT10SA

The appearance of optional accessories may differ from the illustrations above.

Specifications

As part of our policy of continuous improvement, SHARP reserves the right to make design and specification changes for product improvement without prior notice. The performance specification figures indicated are nominal values of production units. There may be some deviations from these values in individual units.

■ Main unit (DVD player unit)

Dimensions	including the stand Width: 16-15/16" (430 mm) Height: *-*** (228 mm) Depth: *-*** (150 mm)	
	excluding the stand Width: 16-15/16" (430 mm) Depth: *-*** (86 mm) Height: *-*** (195 mm)	
Weight	6.6 lbs. (3.0 kg)	
Video output terminals	Video output: RCA type × 1 S-video output: S-terminal × 1 Component video output: RCA type × 3 (Y/PB/PR)	
Other terminals	System control × 1	
Signal system	NTSC color	
Supported disc types	<u>DVD-Video (Region number 1, ALL), DVD-R/RW (video mode), audio CD, CD-R, CD-RW</u>	
Video signal	Horizontal resolution: 500 lines S/N ratio: 70 dB	

■ Amplifier unit

Power source	AC 120 V, 60 Hz
Power consumption	100 W
Dimensions	Width: 16-15/16" (430 mm) Height: 2-3/8" (60 mm) Depth: **-*/**" (321 mm)
Weight	8.6 lbs. (3.9 kg)
Speaker Terminals	<u>Front speakers, Center speaker, Surround speakers and Passive Subwoofer: more than 4 ohms</u>
Audio output terminals	Headphones: 16 - 50 ohms (recommended: 32 ohms) Optical digital output: Square type × 1 <u>VCR output: RCA type × 1 pair (L/R)</u> Subwoofer Pre Out: 10 kohms
Audio input terminals	Audio input (TV, VCR): RCA type × 2 pairs (L/R) Coaxial digital input: RCA type × 1 <u>Optical digital input: Square type × 1</u>
Other terminals	System control × 1
Amplification system	5.6448 MHz (128 fs) 1-bit switching (Remarks: fs = 44.1 kHz)
Power output (FTC)	70 watts minimum RMS per channel into 4 ohms from 120 Hz to 20 kHz, 2 % total harmonic distortion
Rated power output	<u>Front: 100 W + 100 W, Center: 100 W</u> Surround: 100 W + 100 W (4 ohms at 1 kHz) <u>Passive Subwoofer: 100 W</u>
A/D noise shaping	7th-order $\Delta \Sigma$ (delta - sigma) modulation
Frequency characteristics	Linear PCM DVD: 4 Hz to 22 kHz (sampling rate: 48 kHz) 4 Hz to 44 kHz (sampling rate: 96 kHz) CD: 4 Hz to 20 kHz
S/N ratio	CD: 96 dB (1 kHz)
Dynamic range	Linear PCM DVD: 95 dB CD: 94 dB
Total harmonic distortion ratio	0.006 % maximum
Frequency range	FM: 87.5 - 108 MHz AM: 530 - 1,720 kHz

■ Front speaker

Type	Full range speaker system (magnetic shield) 3-1/8" (8 cm) speaker × 2
Impedance	4 ohms
Dimensions	Width: 6-5/8" (168 mm) Height: 7-11/16" (195 mm) Depth: 3-1/8" (80 mm)
Weight	3.3 lbs. (1.5 kg)/each

■ Surround speaker

Type	Full range speaker system (magnetic shield) 3-1/8" (8 cm) speaker × 2
Impedance	4 ohms
Dimensions	Width: 6-5/8" (168 mm) Height: 7-11/16" (195 mm) Depth: 3-1/8" (80 mm)
Weight	3.3 lbs. (1.5 kg)/each

■ Center speaker

Type	Full range speaker system (magnetic shield) 3-1/8" (8 cm) speaker × 2
Impedance	4 ohms
Dimensions	Width: 16-15/16" (430 mm) Height: 3-15/16" (100 mm) Depth: 3-1/8" (80 mm)
Weight	3.7 lbs. (1.7 kg)/each

■ Subwoofer

Type	6-1/4" (16 cm) Woofer
Impedance	4 ohms
Dimensions	Width: 11-13/16" (300 mm) Height: 11-10/16" (295 mm) Depth: 14-3/16" (360 mm)
Weight	6.4 lbs. (14.0 kg)

CONSUMER LIMITED WARRANTY

SHARP ELECTRONICS CORPORATION warrants to the first consumer purchaser that this Sharp brand product (the "Product"), when shipped in its original container, will be free from defective workmanship and materials, and agrees that it will, at its option, either repair the defect or replace the defective Product or part thereof with a new or remanufactured equivalent at no charge to the purchaser for parts or labor for the period(s) set forth below.

This warranty does not apply to any appearance items of the Product nor to the additional excluded item(s) set forth below nor to any Product the exterior of which has been damaged or defaced, which has been subjected to improper voltage or other misuse, abnormal service or handling, or which has been altered or modified in design or construction.

In order to enforce the rights under this limited warranty, the purchaser should follow the steps set forth below and provide proof of purchase to the servicer.

The limited warranty described herein is in addition to whatever implied warranties may be granted to purchasers by law. ALL IMPLIED WARRANTIES INCLUDING THE WARRANTIES OF MERCHANTABILITY AND FITNESS FOR USE ARE LIMITED TO THE PERIOD(S) FROM THE DATE OF PURCHASE SET FORTH BELOW. Some states do not allow limitations on how long an implied warranty lasts, so the above limitation may not apply to you.

Neither the sales personnel of the seller nor any other person is authorized to make any warranties other than those described herein, or to extend the duration of any warranties beyond the time period described herein on behalf of Sharp.

The warranties described herein shall be the sole and exclusive warranties granted by Sharp and shall be the sole and exclusive remedy available to the purchaser. Correction of defects, in the manner and for the period of time described herein, shall constitute complete fulfillment of all liabilities and responsibilities of Sharp to the purchaser with respect to the Product, and shall constitute full satisfaction of all claims, whether based on contract, negligence, strict liability or otherwise. In no event shall Sharp be liable, or in any way responsible, for any damages or defects in the Product which were caused by repairs or attempted repairs performed by anyone other than an authorized servicer. Nor shall Sharp be liable or in any way responsible for any incidental or consequential economic or property damage. Some states do not allow the exclusion of incidental or consequential damages, so the above exclusion may not apply to you. THIS WARRANTY GIVES YOU SPECIFIC LEGAL RIGHTS. YOU MAY ALSO HAVE OTHER RIGHTS WHICH VARY FROM STATE TO STATE.

Model Specific Section

Your Product Model Number & Description:

SD-AS10 1-Bit Digital Home Theater with DVD Player

(Be sure to have this information available when you need service for your Product.)

Warranty Period for this Product:

One (1) year parts and labor from the date of purchase.

Additional Item(s) Excluded from Warranty Coverage (if any):

Non-functional accessories, supplies, and consumable items.

Where to Obtain Service:

At a Sharp Authorized Servicer located in the United States.

To find a location of the nearest Sharp Authorized Servicer, call Sharp toll free at 1-800-BE-SHARP.

What to do to Obtain Service:

Ship prepaid or carry in your Product to a Sharp Authorized Servicer.

Be sure to have Proof of Purchase available. If you ship the Product, be sure it is insured and packaged securely.

TO OBTAIN SUPPLY, ACCESSORY OR PRODUCT INFORMATION, CALL 1-800-BE-SHARP.

0403

SHARP

SHARP ELECTRONICS CORPORATION

Sharp Plaza, Mahwah, New Jersey 07430-2135

SHARP CORPORATION

9910

PRINTED IN MALAYSIA

TINSEA070AWZZ

04H R AO ①

Free Manuals Download Website

<http://myh66.com>

<http://usermanuals.us>

<http://www.somanuals.com>

<http://www.4manuals.cc>

<http://www.manual-lib.com>

<http://www.404manual.com>

<http://www.luxmanual.com>

<http://aubethermostatmanual.com>

Golf course search by state

<http://golfingnear.com>

Email search by domain

<http://emailbydomain.com>

Auto manuals search

<http://auto.somanuals.com>

TV manuals search

<http://tv.somanuals.com>