

RadioShack®



49-1000
Plug 'n Power
Wireless Security System



security console

AC adapter



motion detector



door/window sensor
and magnet



keychain remote

Thank you for purchasing your Wireless Security System from RadioShack.

security console
mounting hardware
magnets (2)
door/window sensors (2)

keychain remote (1)
AC adapter
motion detector (1)

Please read this user's guide before installing,
setting up and using your new product

www.radioshack.com

Introduction	3
Installing Your Security System	4
Locating Security System Components	4
Attaching Your Cords	4
Installing the Backup Batteries	5
Locating Your Security Console	5
A Look at Your Security Console	5
Setting Up Your Security System	6
Reviewing Your Menu Options	6
Initializing/Registering Your Keychain Remote	8
Initializing Your Door/Window Sensors	8
Registering Your Door/Window Sensors	8
De-Registering Your Door/Window Sensors	9
Mounting Your Door/Window Sensors	10
Initializing Your Motion Detector	11
Registering Your Motion Detector	11
De-Registering Motion Detector	11
Mounting Your Motion Detector	12
Connecting Hard-Wired Inputs	13
Setting the Clock	13
Storing Phone Numbers	13
Recording Your Outgoing Message	14
Changing Your PIN	15
Clearing Your Security Console's Memory	15
Setting Security Console Options	15
Setting the Delays	16
Setting the Timers	16
Reviewing/Canceling/Replacing Timers	17
Using Your Security System	18
Arming and Disarming	18
Problem Zones	18
When There's An Alarm	19
Tampering	20
Controlling Lights and Appliances	20
Setting up Optional Lamp Modules	21
Operating from an Outside Telephone	22
Battery Notes	23
Frequently Asked Questions	25
FCC Wants You To Know	30
Accessories	31



Choose a central location for your Security Console that is near a modular telephone jack and an AC outlet. You can place it on a shelf or table, or mount it on a wall.

Plan the location of the Door/Window Sensors and Motion Detectors so the RF path, which runs in a straight line from the sensor to your Security Console, is not obstructed by large metal objects, such as a refrigerator or freezer. Be sure it passes through as few walls as possible. Door/Window Sensors may be hidden behind drapes for a more discreet installation.

Connect your Security Console with the included telephone cord that has been terminated at each end with an RJ11 connector. If possible, connect your Security Console to its own telephone line to ensure your phone line is never busy when your Security Console attempts to dial out. If this is not practical, your Security Console may also share a line with an existing telephone using a duplex adapter (available at your local RadioShack store).

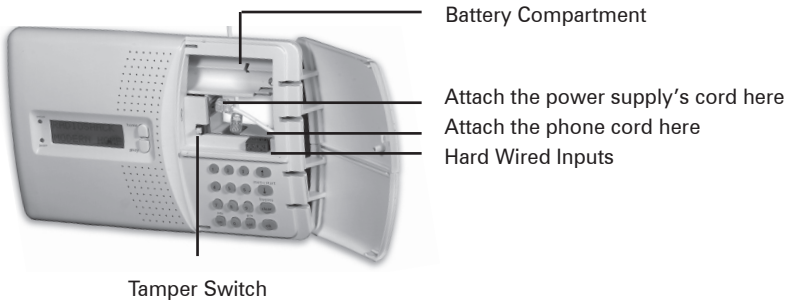

Open the door on your Security Console and attach the AC adapter to the connector labeled power supply. Plug the other end of the AC adapter into any convenient (unswitched) AC outlet.



You must use the included AC adapter. It contains circuitry required to control Plug 'n Power modules, so you cannot replace it with a regular 8V DC power supply.

Open the battery compartment at the top right side of your Security Console and install four AA alkaline batteries (not supplied). You do not need to disconnect power when installing or replacing batteries. "TAMPER" appears in the display when you open the lid. After installing your batteries, close the lid and enter your PIN to remove "TAMPER" from your display.

Your Security Console can be placed on a table top or shelf. Or, you can mount it on a wall, using the two slotted holes on the back of your Security Console.

After you've connected power to your Security Console, the display shows the time of day on the bottom left line, and "HOME CONTROL" in the top line.

All features (except Home Control) require access to the Menu mode. To do this, press either of the Menu \uparrow/\downarrow buttons. The display then shows "ENTER PIN" (Personal Identification Number) in the top line.

Enter the default PIN (0000). This clears the top line and shows * for each number entered. See page 15 for instructions on how you can change your PIN. After you enter the PIN, the display shows the first menu level.

To select a menu option, repeatedly press Menu \uparrow/\downarrow to scroll through menu items 1 through 9. Or, you can press number button 1 through 9 on the control panel to go directly to that menu item. Once you arrive at the menu item you desire, press **ok** to select it.

- | | |
|-----------------|---|
| 1. INSTALL | Allows installation/removal of sensors, and/or remotes. |
| 2. SET CLOCK | Enter time followed by am or pm. |
| 3. PHONE NUMS | Store up to six (16 digit) phone numbers. |
| 4. MESSAGE | RECORD (This is your own alarm message)
REPLAY (Replays your message). |
| 5. NEW PIN | Enter new 4 digit PIN. |
| 6. MEMORY CLEAR | Clear all Sensors, Remotes, Timers, or Master Clear. |
| 7. OPTIONS | Set Chime On/Off, Siren On/Off, Set Housecode or Light Code. |
| 8. DELAYS | Set Exit, Entry, Dial, and Answer Delays. |
| 9. SET TIMER | Enter unit code, then On and Off time, then Daily, Once or Random. |

To leave the first menu level, press **clear**. If you are entering numbers (for the time, etc.), the **clear** button will clear all numbers entered. Otherwise, **clear** gives the option of leaving the menu completely and going back to the "HOME CONTROL" mode, or staying in the "INSTALL" mode.

After pressing **ok** at the first menu level, you can select the sub-menus under that menu item. Or, you can go directly to the sub-menu item by pressing the corresponding number button.

Phone Numbers Sub-menu

You can enter up to six phone numbers (up to 16 digits), which your system will dial in the event your system cannot reach anyone on a specific phone number. Select PHONE 1 - PHONE 6 to enter a phone number. **off/pm** enters a pause if you need to enter a number before the complete phone number. For example, press **9** + **off/pm** + telephone number.

Delays Sub-menu

All times are entered in seconds, up to 99.

ENTRY DELAY

EXIT DELAY

DIAL DELAY

ANSWER DELAY

Options Sub-menu

- | | |
|-----------|---|
| CHIME | 1. CHIME ON
2. CHIME OFF (No chimes when doors/windows are opened) |
| SIREN | 1. SIREN ON
2. SIREN OFF (Silent Alarm) |
| HOUSECODE | Chosen by Menu ↑/↓ buttons |
| LIGHTCODE | Chosen by Menu ↑/↓ buttons |

Memory Clear Sub-menu

CLEAR ALL SENSORS

CLEAR ALL REMOTES

CLEAR ALL TIMERS

MASTER

RESET

Press and hold the **arm** button on your Keychain Remote for three to four seconds, and then release it. This initializes the remote and picks a random code that is used when it is registered with your Security Console.

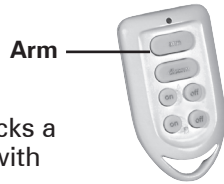

Press either of the Menu \uparrow/\downarrow buttons. The display shows "ENTER PIN" in the top line. When you enter your PIN, * displays for each number entered.

Press **ok** when you see "INSTALL" on the display.

Press any button on your Keychain remote. The Console acknowledges that it has been registered by beeping and displaying "RMOT 1 SET, RMOT 2 SET," etc. as you install more remotes.

Repeat this for each Keychain Remote you want to register.

Repeatedly press **clear** to back out of the menu. To confirm your selection, press **1** for YES or **2** for NO. Pressing 1 takes you back to the HOME CONTROL screen. Pressing 2 takes you up one menu level.

To open the battery compartment, remove the screw and install two AAA alkaline batteries, matching the polarity (+ and -) marked inside.

Set the **DELAY** switch inside your Sensor to **MAX** (left) for doors, or **MIN** (right) for windows.

Press and hold the button inside your sensor for three to four seconds, and then release it. This initializes the sensor and picks a random code that is used when it is registered with your Security Console.

Replace the battery compartment cover and place the magnet next to the sensor, aligning the arrows.



Press either of the Menu \uparrow/\downarrow buttons. The display shows "ENTER PIN" in the top line. When you enter your PIN, * displays for each number entered.

Press **ok** when you see "INSTALL" on the display.

Move the magnet away from your Door/Window Sensor. Your Security Console acknowledges that it has been registered with a chime and displays "ZONE 1 SET."

Repeat this for other Door/Window Sensors you want to register. The display increments to ZONE 2 SET, etc., as you install more Door/Window Sensors. If you connected a second magnetic switch to the contacts on the sensor, move its magnet away to install the second magnetic switch as a separate zone.

If desired, you can specify the zone for which you want the Door/Window Sensor to be registered. Simply press the number of the zone you want on your Security Console's keypad after Step 2 above.

Repeatedly press **clear** to back out of the menu. After a short delay, the display shows "HOME CONTROL" and the time of day.



When you replace the batteries, place the magnet next to the sensor, and then move it away. If your system does not chime, you must register the sensor again.

Repeat Steps 1 and 2 above for Registering Door/Window Sensors.

Press the number of the zone you desire, and then press **clear**. The display asks you to confirm the deletion by pressing 1 for YES or 2 for NO. Pressing 1 displays the zone number you removed. Pressing 2 takes you back to the "INSTALL ZONE" screen.

Repeatedly press **clear** to back out of the menu. To confirm your selection, press **1** for YES or **2** for NO. Pressing 1 takes you back to the "HOME CONTROL" screen. Pressing 2 takes you up one menu level.

Attach the Door/Window Sensor to the wall using the mounting screws provided.

Place the Door/Window Sensor as high as possible at the top of the door/window, aligning the arrows on the magnet and Door/Window sensor.

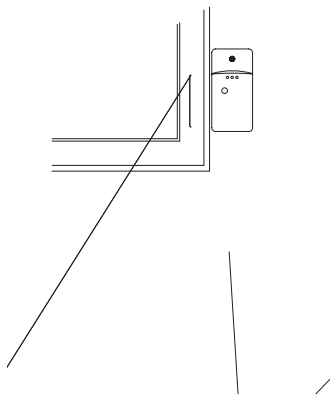

Make sure the arrows on the magnet and the Door/Window Sensor are facing each other and that they separate cleanly when the door or window is opened. To protect two doors or windows close to each other, use the Door/Window Sensor with an additional set of magnetic switch contacts as shown in the diagram above. Slide the **DELAY** switch (inside the Sensor) to **MIN** to always trigger the alarm instantly (for windows). Slide the switch to **MAX** to trigger the alarm after a preset entry delay when the system is armed in the "AWAY" mode (for doors).

The numbers 1 –32 in the display refer to up to 32 "zones." These represent up to 30 Door/Window Sensors and/or Motion Detectors you can install, plus the two hard-wired zones. The numbers show open zones, problem zones and bypassed zones by being displayed as steady on (door or window open), slow flash (there's a problem with that zone) or fast flash (that zone has been bypassed). Attempting to arm with an open or problem zone makes the Security Console beep continuously. It also displays what the cause is one zone at a time. Bypassing that zone (by pressing **clear**) moves on to the next problem zone, if there is one.

Remove the cover on the front of the Motion Detector and install two AA alkaline batteries in the compartment, matching the polarity (+ and -) marked inside. Replace the cover.



Press and hold the **TEST** button on the back of your Motion Detector for three to four seconds, and then release it. This initializes your Motion Detector and picks a random code that is used when it is registered with your Security Console. Place the unit face down, so it won't detect any motion during the registering process.



Press either of the Menu \uparrow/\downarrow buttons. The display shows "ENTER PIN" in the top line. When you enter your PIN, * displays for each number entered.

Press **ok** when you see "INSTALL" on the display.

Press the **TEST** button on the back of your Motion Detector (or turn the unit over so that it sees motion). Your Security Console will acknowledge it has been registered by displaying "ZONE (number) SET."

Repeat these steps for other Motion Detectors you want to register. Your display shows incremental Zone numbers as you install each Motion Detector, such as Zone 4 SET, Zone 5 SET, and so on.

If desired, you can specify the zone for which you want your Motion Detector to be installed. Simply press the number of the zone you want on your Security Console's keypad before you press the **TEST** button on the back of your Motion Detector.

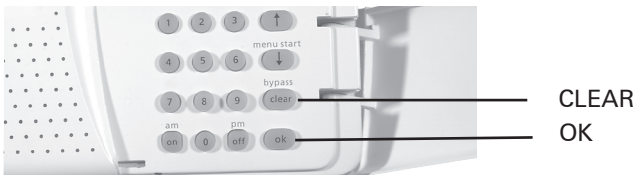

Repeatedly press **clear** to back out of the menu. To confirm your selection, press **1** for YES, or **2** for NO. Pressing 1 takes you back to the "HOME CONTROL" screen. Pressing 2 takes you up one menu level.



When you replace your batteries, press arm to arm your system. Walk past the Motion Detector. If the system does not trip, you must register the Motion Detector again.

1/2 Switch

Press **Menu** \uparrow/\downarrow and enter your PIN.
Press **ok** when you see "INSTALL" on the display.

Press the number of the zone you desire, and then press **clear**. The display asks you to confirm the deletion by pressing 1 for YES or 2 for NO. Pressing 1 displays the zone number you removed. Pressing 2 takes you back to the "INSTALL ZONE" screen.

Repeatedly press **clear** to back out of the menu. To confirm your selection, press **1** for YES or **2** for NO. Pressing 1 takes you back to the "HOME CONTROL" screen. Pressing 2 takes you up one menu level.



Mount your Motion Detector on a wall at a height of five to six feet, using the mounting bracket and screws provided.

Press **ok** when you see "INSTALL" on the display.

Position your Motion Detector so it points slightly downward.

Slide the switch (on the back) to position 1 for instant triggering.

Or, set the switch to position 2 to trigger the system after two movements have been detected.

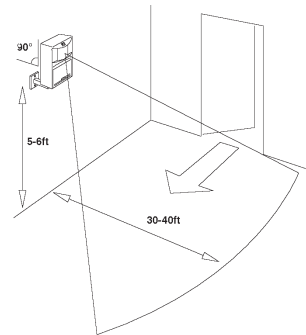

Slide the switch on your Motion Detector to position 1.

Press and hold the **TEST** button for about a second (until the LED flashes twice), and then release it.

Wait 20 seconds for the Motion Detector to settle.

Walk in front of the Motion Detector. The indicator LED lights each time it detects movement. Check your coverage area and reposition the sensor as required.

Press **TEST** to return to normal operating mode.

Press **ok**. You also can press **3** to go directly to the "PHONE NUMS" menu.

Press **Menu** **↑/↓** to select the desired sub-menu: (PHONE 1, PHONE 2, and so on).

Press **ok** at the desired number. The display shows "SET PH1, SET PH2," etc.

Enter the phone number, up to 16 digits. Use **off/pm** to enter a pause, and then press **ok**. This takes you to the next phone number to be stored.

Repeatedly press **clear** to back out of the menu. Confirm your selection by pressing **1** for YES or **2** for NO. Pressing **1** takes you back to the "HOME CONTROL" screen. Pressing **2** keeps you in the "INSTALL" mode.

Press **Menu** **↑/↓** and enter your PIN.

When you see "INSTALL" on your Security Console, press **Menu** **↑/↓** until you reach the "MESSAGE" menu.

Press **ok**. You also can press **4** to go directly to the "MESSAGE" menu.

To record your own alarm message, press **1** to select RECORD, and then press **ok**.



Press **Menu** ↑/↓ and enter your old PIN.

When you see "INSTALL" on your Security Console, press **Menu** ↑/↓ until you reach the "NEW PIN" menu.

Press **ok**. You also can press **5** to go directly to the "NEW PIN" menu.

Enter your new PIN and press **ok**.

Note: Choose a PIN you are not likely to forget. If you forget your PIN, you will not be able use the system. Contact your local RadioShack store to find out how to reset your system.

Repeatedly press **clear** to back out of the menu. Confirm your selection by pressing **1** for YES or **2** for NO. Pressing **1** takes you back to the "HOME CONTROL" screen. Pressing **2** keeps you in the "INSTALL" mode.

Press **Menu** ↑/↓ and enter your PIN.

When you see "INSTALL" on your Security Console, press **Menu** ↑/↓ until you reach the "MEMORY CLEAR" menu.

Press **ok**. You also can press **6** to go directly to the "MEMORY CLEAR" menu.

Press **Menu** ↑/↓ to select the desired sub-menu: (CLEAR ALL SENSORS, CLEAR ALL REMOTES, and so on).

Press **ok** after you select the desired sub-menu.

Repeatedly press **clear** to back out of the menu. Confirm your selection by pressing **1** for YES or **2** for NO. Pressing **1** takes you back to the "HOME CONTROL" screen. Pressing **2** keeps you in the "INSTALL" mode.

Press **Menu** ↑/↓ and enter your PIN.

When you see "INSTALL" on your Security Console, press **Menu** ↑/↓ until you reach the "OPTIONS" menu.

Press **ok**. You also can press **7** to go directly to the "OPTIONS" menu.

Use Menu \uparrow/\downarrow to choose from the following sub-menu items:

CHIME	1. CHIME ON 2. CHIME OFF (No chimes when doors/windows are opened)
SIREN	1. SIREN ON 2. SIREN OFF (Silent Alarm)
HOUSECODE	Press the Menu \uparrow/\downarrow buttons to change.
LIGHTCODE	Press the Menu \uparrow/\downarrow buttons to change.

Press **Menu** \uparrow/\downarrow and enter your PIN.

When you see "INSTALL" on your Security Console, press **Menu** \uparrow/\downarrow until you reach the "DELAYS" menu.

Press **ok**. You also can press **8** to go directly to the "DELAYS" menu.

Use Menu \uparrow/\downarrow to choose from the following sub-menu items:

ENTRY DELAY	(Default 30 seconds)
EXIT DELAY	(Default 60 seconds)
DIAL DELAY	(Default 5 seconds)
ANSWER DELAY	(Default 30 seconds)

Select the desired sub-menu item and then press **ok**. Then, enter the desired delay time for up to 99 second and press **ok**.

Press **Menu** \uparrow/\downarrow and enter your PIN.

When you see "INSTALL" on your Security Console, press **Menu** \uparrow/\downarrow until you reach the "SET TIMER" menu.

Press **ok**. You also can press **9** to go directly to the "NEW TIMER" menu.

"NEW TIMER" displays. If no timers have been entered, Menu \uparrow/\downarrow will not function. If other timers are in memory, Menu \uparrow/\downarrow will cycle around them, and will always include "NEW TIMER" in the loop if empty space is available in memory.

To enter a new timer, you must be in the "NEW TIMER" menu. Press **ok**. "UNIT NUMBER" displays. Enter a valid unit number (1-16) and press **ok**.

For example: If you enter 12, the top line of your Security Console displays "TIMER 12 ON." The bottom line displays a colon (:).

Enter your desired "On" time and press **am** or **pm**. Or, you can press **ok** if you don't want to set an On time. Press **clear** if you enter a wrong time.

Press **ok**. **TIMER 12 OFF** displays in the top line of your security console and the bottom line displays a (:).

Enter the "Off" time, as in step 2, and press **ok**. Or, you can just press **ok** if you don't want to set an Off time. Press **clear** if you enter a wrong time. The display shows "1. DAILY" on the bottom line. The top line will be empty.

Using Menu **↑/↓**, you can cycle around "1. DAILY, 2. ONCE ONLY, and 3. RANDOM." Select one and press **ok**. The display again shows "NEW TIMER." Use Menu **↑/↓** to review the stored timers, which will appear in this format (12ON 12:34am and OFF 12:45pm).

You can set a total of 12 "timer pairs" (i.e. ON-OFF times). If you choose to set an "On" time with no corresponding "Off" time for that unit code (or vice versa) it still counts as a "timer pair." "RANDOM" varies the time during the programmed hour.

Repeat steps 1-3 under setting your timers on page 16.

You can review your stored timers by pressing Menu **↑/↓**. While a timer is on the display, pressing **clear** deletes it. To confirm your selection, press **1** (for YES) to delete the timer. Pressing **1** takes you to NEW TIMER, which allows you to enter a new timer. Pressing **2** takes you to NEW TIMER without deleting the one that was on the screen. Repeatedly press **clear** to back out of the menu options.

To replace a timer, while a timer is on the display, press **ok** to go to the Replace Timer screen.

Selecting **1** (for YES), takes you to the UNIT NUMBER screen, which allows you to enter a new timer. Selecting **2** (for NO) takes you to the NEW TIMER screen, so you can enter a new timer without replacing the existing one. Press **clear** the back out of the Menu options. You also can clear all timers as described on page 15.

Press **arm home** on your Security Console to arm all Door/Window Sensors instantly. Motion Detectors will not trip the system when it is armed in the "ARM HOME" mode.

Press **arm away** to arm all Door/Window Sensors and Motion Detectors. This arms the system after a set delay. If you arm the system in the "AWAY" mode, you also will have an entry delay when you enter your home before the alarm trips, to give you time to disarm it.

Pressing **arm** on your Keychain Remote always arms in the "AWAY" mode, but arms instantly (You will not have an entry delay).

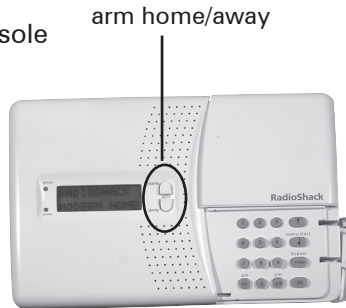

Pressing **disarm** on the Keychain Remote disarms the system instantly. The zone that was violated is shown in the display. To remove this, press **arm** and **disarm** again.

To disarm from your Security Console, enter your four-digit PIN. The display shows * for each digit entered.

If the unit was armed, (in either "ARMED HOME" or "ARMED AWAY" modes), your system will disarm when your PIN is entered. Then, it will return to the time display, showing "DISARMED" and then reverts to "HOME CONTROL."

If a door or window is open and you try to arm the system, a zone number displays. This indicates the door or window that's open.

If a Door/Window Sensor or Motion Detector has not reported in within the last four hours, and you try to arm the system, PROBLEM and the zone number displays.

If a Door/Window Sensor has been tampered with (e.g. the cover is open, and you try to arm the system), TAMPER and the zone number displays.

For all the above situations, pressing **bypass/clear** bypasses the problem zone, and lets you arm the system. After pressing **bypass**, the next problem zone is displayed, (if there is more than one).

You can't arm the system until you fix the problem zone, or bypass the zone. If you try to arm the system before resolving the problem zone(s), a repetitive "trouble alarm" sounds to alert you to respond.

If your Security Console has been tampered with, i.e. the door to the upper right of the display is open, the problem must be fixed (close the door) before you can arm the system. **Note: If the system is armed and this door is tampered with, the alarm trips.**

If you bypass a zone and then arm the system, that zone stays bypassed until you disarm the system.

The alarm will trip if the system is armed, and you open a protected door or window, or walk past a Motion Detector (if armed in the "Away" mode).

When the alarm is tripped, a loud siren sounds. Lights (set to the two security codes) flash on and off (if you set up Plug 'n Power modules).

Your Security Console dials the first phone number you set up. It plays the recorded message you stored. And, the system repeats your recorded message three times, in case it takes awhile for the person the system called to pick up.

When the person who was called answers the call and presses a button on their phone, this activates a microphone in your Security Console. They will be able to listen in to your home, and determine if there is suspicious activity going on. They can then take action, such as calling the police for you.

IMPORTANT: Do not program your Security Console to call the Police directly.

The person who answers the phone must wait for a gap between the messages before they can press a button on their phone to listen in. The message repeats three times, but might have already played once or twice before the person answers the phone.



If no one answers the call (or presses a button) before the third message is played, your Security Console dials the next number stored. If you stored six numbers, it may take a long time to dial all of them. The siren stops sounding after four minutes. The unit still dials all the numbers stored unless someone answers.

If your system is armed and someone tampers with (opens the cover on a Door/Window Sensor, the Motion Detector or the Security Console), the alarm is tripped and a loud siren sounds. If the system is **not** armed and someone tampers with a Sensor or the Security Console, the word "TAMPER" appears in the display, but the system does not trip. You must correct this by pressing **arm** and then **disarm** before you can arm the system.

If you install one or more Lamp Modules (sold separately), you can control lights around your home from your Security Console. When it is in its normal state, your Security Console displays "HOME CONTROL" in the display. You can simply press the number button on the keypad that corresponds to the number set on the module. Then, press **On** or **Off** on Security Console's control panel to control the light connected to the module.

You can also control lights set to your Security LIGHTCODEs from the A and B buttons on the Keychain Remote. The A buttons on the Keychain Remote control lights connected to Plug 'n Power Modules that are set to the Security LIGHTCODE you set in the Console. The B buttons control modules set to the next sequential number. For example, if you set your Security LIGHTCODE to 1, the A and B buttons on the Keychain Remote will control Plug 'n Power modules that are set to Unit Codes 1 and 2. If your Security LIGHTCODE is 10, the A and B buttons will control Modules 10 and 11. If your Security LIGHTCODE to 16, the A and B buttons will control 16 and 1, etc. See page 16 to change your Security LIGHTCODE.

Any lights set to your two Security LIGHTCODEs flash on and off when the alarm trips. They stay on after an alarm until you turn them off, either from your Security Console, or from your Keychain Remote.

These lights also blink on for a second when the alarm is armed in the HOME Mode, or turn on for the exit delay time when the alarm is armed in the AWAY Mode.



Using a small screwdriver, set your module's red House Code dial to the same letter as your Security Console. Set the Black Unit Code dial to any unused number.



Plug your lamp's AC cord into the module.



Plug your module into the same wall outlet as your Security Console.



Use the bottom outlet plug for your module and the top plug for your Security Console.

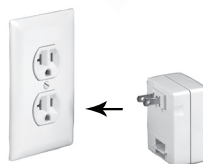

To test your module, make sure the lamp's switch is on and plug the module into the same wall outlet as your Console.

Press the Console's **On** and **Off** buttons that correspond to the Unit Code setting on your lamp module.

If your module turns on and off, move the Console and your module to their permanent location.

If your module does not work, try plugging your Console into another location, or visit your local RadioShack store for assistance.

Your lamp module only can be used to control an incandescent lamp rated up to 300W. It is not suitable for other types of lamps, such as fluorescent or energy saving lamps, low voltage lamps, or lamps that include a dimmer control.

Do not connect an appliance to a lamp module. It may damage the lamp module and/or appliance, and could cause a fire hazard. Use an appliance module instead.

Your Security Console has remote telephone access, with voice responses to acknowledge receipt of remote commands.

When you call home, your Security Console answers and says "Please enter PIN."

1. Enter your PIN using the touch tone buttons on the remote telephone.
2. If the PIN is entered correctly, your system says "PIN accepted." If wrong, it says "Error."
3. Press **0**, and then ***** (on the remote telephone's touch-tone keypad) to arm your Security Console.
4. Press **0**, and then **#** to disarm the Console.

Pressing **9, 9**, and then ***** displays the current system status: I.E. Armed Home, Armed away, Disarmed, Panic alarm, or Alarm in zone (1 – 32).

If the alarm tripped because zone 3 was violated, when you call in and press **9, 9, ***, you will hear "Alarm in zone 3."

If you install one or more Plug 'n Power modules (sold separately), see previous page, you can control lights and appliances around your home from any touch tone telephone in the world.

When you call home, your Security Console answers and says "Please enter PIN." If the PIN is entered correctly it says "PIN accepted". If wrong, it says "Error."

If you press **4**, and then ***** on a touch-tone phone, it says "4 On" and turns on any Plug 'n Power module(s) set to Unit Code 4 (and the same Housecode as the Security Console).

If you press **1**, and then **6**, then **#** on the touch-tone phone, it says "16 Off" and turns off any Plug 'n Power module(s) set to Unit Code 16 (and the same Housecode as the Security Console).

If you have an answering machine, and it picks up the call (or if someone picks up the phone), the security system will not answer the call. You can still enter your PIN to access the security system features above. Wait until your answering machine completes its outgoing message, and then enter your security system PIN.

Door/Window Sensors, Motion Detectors and Keychain Remotes are designed to operate for approximately one year after the appropriate batteries are installed. Since operating conditions vary from installation to installation, we recommend replacing batteries every six months.

The batteries in your Security Console are used as a backup when there has been a power failure. The batteries provide approximately 12 hours of backup time, provided the alarm has not been triggered.

While on battery backup, your Security Console will continue to operate, and will sound the siren and dial out if the alarm is tripped. Since there is no AC power, the house lights will not flash.

If both the AC supply and the batteries fail, your Security Console will not operate. It will not lose its telephone numbers, recorded message, or installed sensors and remotes. But, you must reset the clock for the correct time of day.

Batteries can be replaced at any time, even while the unit is powered up. Use four AA alkaline batteries.

You can install new batteries in your Keychain Remote at any time. You do not have to re-register your remote, unless the batteries have already failed. New batteries must be installed within 30 seconds of removing the old batteries from your Keychain Remote. This ensures the security code is retained.

Gently pry the two halves of the Keychain Remote's case apart and install two CR2016 lithium batteries in the compartment (+ facing up). Press the two halves of the cabinet back together. Once the batteries have been replaced, confirm the remote is still registered with your Security Console by arming the system. If it does not arm, the code has been lost and you will need to register your Keychain Remote again. Follow the procedure on page 8.

If a zone has not reported in to the Console during the last four hours, the display will show **PROBLEM** and the appropriate zone number when you try to arm the system. This is most likely caused by dead batteries in the Motion Detector or Door/Window Sensor for that zone. As with the remotes, as long as the batteries have not completely failed they may be replaced with fresh batteries without the need to re-register the Motion Detector or Door/Window Sensor. After removing the old batteries, the new batteries must be fitted within 30 seconds to ensure that the code is retained.

Once the batteries have been replaced, the Door/Window Sensor should be tested as follows:

- Make sure the system is **NOT** armed.
- Open the door or window with the sensor attached. The Console chimes to acknowledge and the zone # is displayed on the LCD.
- If you don't hear a chime, re-register the Door/Window Sensor.

To test your Motion Detector:

- Make sure the system is armed.
- Press the **TEST** button on the back of the Motion Detector. Or, walk past it. If the alarm trips, press **disarm** on your Keychain Remote.
- If the alarm doesn't trip, re-register your Motion Detector, as described on page 11.

If you suspect that a neighbor's system is causing false alarms, or if you need to reinstall remotes, Door/Window Sensors, and Motion Detectors for any other reason, you can clear all sensors and remotes from your Security Console's memory. Follow the steps on page 15.

Why can't I arm my system?	Your batteries may be low. Check that the indicator on your Keychain Remote turns on when you press arm . Replace the batteries and re-register your Remote with your Security Console if necessary.
Why does "PROBLEM" and a Zone number display when I try to arm my system?	One of your sensors/motion detectors has not reported during the last four hours. Check that the batteries in the sensor/motion detector are good. Or, a protected door or window is open. If you need to arm the system and want to ignore a sensor/motion detector that is not functioning: Press clear on your Security Console while the problem is being displayed. Then, press arm on your Keychain Remote. The problem zone is not protected, but all other zones are armed.
Why does the alarm sound when I enter the house before I have time to disarm it?	You need to arm your system in the "AWAY" mode.
Why don't I hear a beep from the Security Console when I register a Remote?	You may have improperly registered your remote. Re-initialize and re-register your Keychain Remote.

What should I do if I lose my remote control?	Re-register your complete system to prevent someone else from using the lost remote control.
Why do I hear a repetitive trouble alarm when I try to arm the system, and it does not arm?	<p>Check your Security Console's display. If a door or a window is open, the zone # and the problem displays.</p> <p>Press disarm. Check each Door/Window Sensor is working properly and that no doors or windows are open. Then, arm the system.</p> <p>Or:</p> <p>While the trouble alarm is sounding, press clear on your Security Console to bypass the problem zone ("BYPASSED" displays.) Then, arm the system again.</p> <p>Or, if the display shows "TAMPER," check the cover on your Door/Window Sensor for that zone.</p> <p>Or, check that the upper right lid on your Security Console is closed.</p>
Why does my Motion Detector cause false alarms?	<ul style="list-style-type: none"> • All brands of motion detectors sense motion by detecting a change in temperature. Therefore, do not place the detector near any sources of heat such as over a heating vent or an air conditioner. • Do not place in a direct source of bright light, such as sunlight.

<p>Why won't my lights turn on or off using the on or off buttons on my Keychain Remote?</p>	<p>Be sure you set the correct SECURITY LIGHT CODE in your Security Console, see Setting Security Console Options on page 15.</p> <p>Be sure the light you are trying to control has its on/off switch in the on position. And, check to see that the bulb is good.</p> <p>Plug your Module into another outlet near your Security Console.</p> <p>Be sure the indicator on your Keychain Remote lights when you press a button.</p> <p>Replace the batteries and re-register your remote if necessary.</p> <p>Check the dials on your Modules.</p>
<p>Why don't I hear a beep from my Security Console when I register a Door/Window Sensor or Motion Detector.</p>	<p>The system may already be registered. Disarm your Security Console, and check to see if it chimes when you press test on the Door/Window Sensor, or the alarm trips when you press test on a Motion Detector (when the system is armed).</p> <p>If it does, the sensor is already registered and no further action is necessary.</p> <p>If not, re-register the Sensor/Motion detector (see Registering Door/Window Sensors and Registering Motion Detectors on pages 9 and 11).</p>

<p>Why do my appliances turn off during an alarm?</p>	<p>Your appliance modules might be set to the same code as your Security Console. The system flashes lights by repetitively transmitting the SECURITY light "on" and "off" codes. Any Appliance Modules set to the same codes will turn on and off.</p>
<p>Why does my system Arm or Disarm by itself?</p>	<p>A neighbor may have a compatible system. Re-register the complete system so it chooses different RF codes.</p>
<p>Why does the light on my Keychain Remote stay on during initialization?</p>	<p>You may need to re-register your remote.</p> <ul style="list-style-type: none"> • Remove the batteries, wait a few seconds, and then replace the batteries. • Press and hold the arm button on the Keychain Remote for a second and then release it. This initializes the remote and picks a random code that is used when it is registered with the Console. • Re-register your remote.
<p>Why didn't my alarm trip when I opened the door/window?</p>	<p>You may need to re-register your door/window sensor.</p> <ul style="list-style-type: none"> • Check that the system is armed. • Check to see if the alarm trips when you move the magnet away. • If the alarm does not trip, check that the indicator on the sensor comes on when you move the magnet away. <p>If the indicator does not come on, replace the batteries and re-register the sensor if necessary.</p>

Why is the battery indicator on my Security Console on?	Your batteries may be low. Replace your Security Console's batteries. Two AA alkaline batteries provides approximately 20 hours of backup time. Replace batteries at least once a year.
Why does the alarm cause still display after I disarm it?	To remove, use a remote to Arm and Disarm, or disarm by pressing a menu key and entering the PIN on your Security Console.

Intercom systems that send voice signals over existing electrical wiring may interfere with the ability to control modules from your security system while the intercom is in use. If the intercom system has its own separate wiring, it will not cause a problem.

This equipment generates and uses radio frequency energy, and if not installed and used properly, that is, in strict accordance with the manufacturers instructions, may cause interference to radio and television reception. It has been type tested and found to comply with the limits for remote control security devices in accordance with the specifications in Sub-Parts B and C of Part 15 of FCC Rules, which are designed to provide reasonable protection against such interference in a residential installation. However, there is no guarantee that interference will not occur in a particular installation. If this equipment does cause interference to radio or television reception, which can be determined by unplugging the equipment, try to correct the interference by one or more of the following measures.

- Reorient the antenna of the radio/TV experiencing the interference.
- Relocate the Console with respect to the radio/TV.
- Move the Console away from the radio/ TV.
- Plug the Console into an outlet on a different electrical circuit from the radio/TV experiencing the interference.

Changes or modifications not expressly approved by RadioShack may cause interference and void the user's authority to operate the equipment.

This device complies with Part 15 of the *FCC Rules*. Operation is subject to the condition that this device does not cause harmful interference.

This equipment complies with Part 68 of the FCC rules and the requirements adopted by the ACTA. On the bottom of this equipment is a label that contains, among other information, a product identifier US: B4SAL11B-SC12A. If requested, this number must be provided to the telephone company.

Note: The security functions of this system have not been tested by Underwriters Laboratories.

Product:	Home Automation Security Kit
Model:	49-1000
Responsible Party:	RadioShack Corporation 100 Throckmorton St. Fort Worth, TX 76102
Phone:	817-415-3200



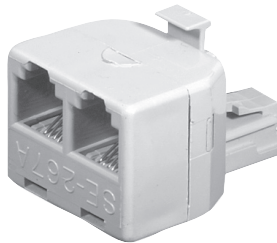

This product is warranted by RadioShack against manufacturing defects in material and workmanship under normal use for ninety (90) days from the date of purchase from RadioShack company-owned stores and authorized RadioShack franchisees and dealers. For complete warranty details and exclusions, check with your local RadioShack store.

RadioShack Customer Relations
200 Taylor Street, 6th Floor, Fort Worth, TX 76102

04/04



Free Manuals Download Website

<http://myh66.com>

<http://usermanuals.us>

<http://www.somanuals.com>

<http://www.4manuals.cc>

<http://www.manual-lib.com>

<http://www.404manual.com>

<http://www.luxmanual.com>

<http://aubethermostatmanual.com>

Golf course search by state

<http://golfingnear.com>

Email search by domain

<http://emailbydomain.com>

Auto manuals search

<http://auto.somanuals.com>

TV manuals search

<http://tv.somanuals.com>