

PHASER® 860
COLOR PRINTER

USER GUIDE



Tektronix

COLOR PRINTERS BY

XEROX

www.xerox.com/officeprinting



Phaser® 860 Color Printer User Guide

071-0726-00
June 2001

Copyright © 2001 Xerox Corporation. Unpublished rights reserved under the copyright laws of the United States. Contents of this publication may not be reproduced in any form without permission of Xerox Corporation.

Phaser®, PhaserShare®, ColorStix® II, the TekColor® icon, Made For Each Other®, DocuPrint®, WorkSet®, Ethernet®, the stylized X, and XEROX® are registered trademarks of Xerox Corporation. PhaserLink™, PhaserPort™, PhaserPrint™, PhaserSym™, PhaserTools™, infoSMART™, and the TekColor™ name are trademarks of Xerox Corporation. TekColor CareSM and RealSUPPORTSM are service marks of Xerox Corporation.

Adobe®, Acrobat®, Acrobat® Reader, Illustrator®, PageMaker®, Photoshop®, and PostScript®, ATM®, Adobe Garamond®, Birch®, Carta®, Mythos®, Quake®, and Tekton® are registered trademarks and Adobe Jenson™, Adobe Brilliant Screens™ technology, and IntelliSelect™ are trademarks of Adobe Systems Incorporated or its subsidiaries which may be registered in certain jurisdictions.

Apple®, LaserWriter®, LocalTalk®, Macintosh®, Mac® OS, AppleTalk®, TrueType2®, Apple Chancery®, Chicago®, Geneva®, Monaco®, and New York® are registered trademarks, and QuickDraw™ is a trademark of Apple Computer Incorporated.

Marigold™ and Oxford™ are trademarks of AlphaOmega Typography.

Avery™ is a trademark of Avery Dennison Corporation.

FTP® Software is a registered trademark of FTP Software, Incorporated.

PCL® and HP-GL® are registered trademarks of Hewlett-Packard Corporation.

Hoefer Text was designed by the Hoefer Type Foundry.

ITC Avant Guard Gothic®, ITC Bookman®, ITC Lubalin Graph®, ITC Mona Lisa®, ITC Symbol®, ITC Zapf Chancery®, and ITC Zapf Dingbats® are registered trademarks of International Typeface Corporation.

Bernhard Modern™, Clarendon™, Coronet™, Helvetica™, New Century Schoolbook™, Optima™, Palatino™, Stempel Garamond™, Times™, and Univers™ are trademarks of Linotype-Hell AG and/or its subsidiaries.

MS-DOS® and Windows® are registered trademarks of Microsoft Corporation.

Wingdings™ in TrueType® format is a product of Microsoft Corporation. WingDings is a trademark of Microsoft Corporation and TrueType is a registered trademark of Apple Computer, Inc.

Albertus™, Arial™, Gill Sans™, Joanna™, and Times New Roman™ are trademarks of Monotype Corporation.

Antique Olive® is a registered trademark of M. Olive.

Eurostile™ is a trademark of Nebiolo.

Novell® and NetWare® are registered trademarks of Novell, Incorporated.

Sun®, Sun Microsystems®, and Sun Microsystems Computer Corporation® are registered trademarks of Sun Microsystems, Incorporated.

SPARC® is a registered trademark of SPARC International, Incorporated.

SPARCstation™ is a trademark of SPARC International, Incorporated, licensed exclusively to Sun Microsystems, Incorporated.

UNIX® is a registered trademark in the US and other countries, licensed exclusively through X/Open Company Limited.

Other marks are trademarks or registered trademarks of the companies with which they are associated.

PANTONE® Colors generated by the Phaser 860 Color Printer are four- and/or three-color process simulations and may not match PANTONE-identified solid color standards. Use current PANTONE Color Reference Manuals for accurate colors. PANTONE Color simulations are only obtainable on this product when driven by qualified Pantone-licensed software packages. Contact Pantone, Inc. for a current list of qualified licensees. All trademarks noted herein are either the property of Xerox Corporation, Pantone, Inc., or their respective companies. © Pantone, Inc., 1988.

Contents

Printer Warranty	vii
User safety summary	x
Printer Parts and Supplies	1
Customer-Replaceable Consumables (CRCs)	1
Customer-Replaceable Units (CRUs)	2
Accessories	3
Paper and specialty media	5
Front Panel	8
Features	10
Print quality modes	11
TekColor™ color corrections	12
Paper and Print Media	13
Paper tips	13
Supported media	13
Print area of supported paper sizes	15
Loading Trays	17
Loading the Standard Paper/Transparency Tray	17
Loading the Optional High-Capacity Paper Tray	19
Loading the Optional High-Capacity Transparency/Label Tray	22
Loading the Optional Legal Paper Tray	23
Manual-Feed Printing	26
Printing on Special Media	29
Printing on Phaser High-Resolution Photo Paper	29
Printing on labels and business cards	30
Printing on transparencies	32
Printing on envelopes	34
Printing on letterhead paper	38
Printing Two-Sided Jobs	39

Troubleshooting Print Quality	42
Band of color(s) missing	42
Smudges or smears appear on the print	45
Images are too light or too dark	46
Paper Jams	47
Jam prevention tips	47
Clearing jams	47
Paper jam – Open exit cover to clear	48
Paper jam - Open front cover to clear	52
Paper jam - Remove upper tray or paper tray to clear	53
Paper jam - Remove middle tray to clear	53
Paper jam - Remove lower tray to clear	54
Paper jam, incorrect size - Open exit cover to clear	54
Paper jam - Retry manual feed	55
Maintenance and Cleaning	56
Adding ink	56
Emptying the waste tray	58
Replacing the Maintenance Kit	61
Cleaning the Rapid Release Guide	62
Cleaning the maintenance drawer wiper blade	65
Cleaning the exit rollers	66
Cleaning the paper-feed rollers	66
Moving and Shipping the Printer.	68
Moving the printer within the office	68
Shipping the printer	69
Getting Help	71
Xerox web sites	72
Customer support centers	74
Specifications.	75
Material Safety Data Sheet for ColorStix® II Ink.	75
Material Safety Data Sheet for Silicone Intermediate Transfer Layer Fluid	77
Material Safety Data Sheet for CleanTex® Alcopad	80
Index	85

Printer Warranty

Xerox warrants that the Phaser 860 Printer will be free from defects in materials and workmanship for a period of one (1) year from the date of shipment. If the product proves defective during the warranty period, Xerox, at its option, will:

- (1) repair the product by means of telephone support or on-site service at no charge for parts or labor,
- (2) replace the product with a comparable product, or
- (3) refund the amount paid for the product, less a reasonable allowance for usage, upon its return.

Under this product warranty, the Customer must notify Xerox or its authorized service representative of the defect before the expiration of the warranty period. To obtain service under this warranty, the Customer must first contact Xerox Telephone Support personnel or that of its authorized service representative. Telephone Support personnel will work to resolve issues professionally and quickly, however the Customer must reasonably assist Xerox or its authorized representative.

If telephone support is unsuccessful, Xerox or its authorized service representative will provide warranty repair at the Customer's site without charge as provided below.

- Service is available within the customary on-site service area in the United States and Canada for products purchased in the United States and Canada.
- Inside the European Economic Area, service is available within the customary on-site service area for products purchased in the EEA.
- Outside the US, Canada, & EEA, service is available within the customary on-site service area in the country of purchase.
- Xerox reserves the right to charge for on-site service in exceptional cases.

A description of the customary on-site service area may be obtained from the local Xerox Customer Support Center or authorized Xerox distributor. On-site service is at Xerox or its authorized service representative's sole discretion and is considered an option of last resort.

If the Customer's product contains features that enable Xerox or its authorized service representative to diagnose and repair problems with the product remotely, Xerox may request that the Customer allow such remote access to the product.

In the maintenance of the product, Xerox may use new or equivalent to new parts or assemblies for equal or improved quality. All defective parts and assemblies become the property of Xerox. Xerox, at its option, may request the return of these parts.

Consumables Warranty

Xerox warrants that ColorStix® II Ink will be free from defects in materials and workmanship for a period of one (1) year from date of installation. All other Customer Replaceable Consumables (CRCs) will be covered for a period of ninety (90) days (six (6) months where longer periods are required by law) from the date of installation, but not more than one (1) year from date of shipment. Under this warranty, the Customer must notify Xerox or its authorized service representative of the defect before the expiration of the warranty period. XEROX MAY REQUIRE THAT THE DEFECTIVE CRC BE RETURNED TO A DESIGNATED XEROX DEPOT OR THE XEROX REPRESENTATIVE FROM WHICH THE CRC WAS ORIGINALLY PURCHASED. Claims will be handled according to the current Xerox procedure.

These warranties shall not apply to any defect, failure or damage caused by improper use or improper or inadequate maintenance and care. Xerox shall not be obligated under these warranties:

- a. to repair damage resulting from attempts by personnel other than Xerox representatives to install, repair or service the product unless directed by a Xerox representative;
- b. to repair damage, malfunction, or degradation of performance resulting from improper use or connection to incompatible equipment or memory;
- c. to repair damage, malfunction, or degradation of performance caused by the use of non-Tektronix/Xerox printer supplies or consumables or the use of Tektronix/Xerox supplies not specified for use with this printer;
- d. to repair a product or CRC that has been modified or integrated with other products when the effect of such modification or integration increases the time or difficulty of servicing the product or CRC;
- e. to perform user maintenance or cleaning or to repair damage, malfunction, or degradation of performance resulting from failure to perform user maintenance and cleaning as prescribed in published product materials;
- f. to repair damage, malfunction, or degradation of performance resulting from use of the product in an environment not meeting the operating specifications set forth in the user manual;
- g. to repair this product after the limit of its duty cycle has been reached; all service thereafter shall be billed on a time and material basis;
- h. to replace CRCs that have been refilled, are used up, abused, misused, or tampered with in any way.

THE ABOVE WARRANTIES ARE GIVEN BY XEROX WITH RESPECT TO THIS PRODUCT AND ITS CUSTOMER REPLACEABLE CONSUMABLES IN LIEU OF ANY OTHER WARRANTIES, EXPRESS OR IMPLIED. XEROX AND ITS VENDORS DISCLAIM ANY IMPLIED WARRANTIES OF MERCHANTABILITY OR FITNESS FOR A PARTICULAR PURPOSE OR ANY SIMILAR STANDARD IMPOSED BY APPLICABLE LEGISLATION. XEROX'S RESPONSIBILITY TO REPAIR, REPLACE, OR OFFER A REFUND FOR DEFECTIVE PRODUCTS AND CUSTOMER REPLACEABLE CONSUMABLES IS THE SOLE AND EXCLUSIVE REMEDY PROVIDED TO THE CUSTOMER FOR BREACH OF THESE WARRANTIES. XEROX AND ITS VENDORS WILL NOT BE LIABLE FOR ANY INDIRECT, SPECIAL, INCIDENTAL OR CONSEQUENTIAL DAMAGES (INCLUDING LOSS OF PROFITS) IRRESPECTIVE OF WHETHER XEROX OR THE VENDOR HAS ADVANCE NOTICE OF THE POSSIBILITY OF SUCH DAMAGES.

Some states, provinces, and countries do not allow the exclusion or limitation of incidental or consequential damages or exclusions or limitations on the duration of implied warranties or conditions, so the above limitations or exclusions may not apply to you. This warranty gives you specific legal rights, and you may also have other rights that vary by state, province, or country.

For the software warranty please see the end user license agreement included with the software.

In certain geographies this product is warranted by Fuji Xerox. This statement of warranty does not apply in Japan – please refer to the warranty statement provided in the Japanese user manual for products purchased in Japan.

If you are an Australian consumer, you should be aware that the Trade Practices Act 1974 and equivalent State and Territory legislation (collectively "the Acts") contain special provisions designed to protect Australian consumers. Nothing in any Fuji Xerox warranty material excludes or limits the application of any provision of any of the Acts, where to do so would contravene the Acts or cause any part of this warranty to be void. In this warranty material, an implied condition or warranty, the exclusion of which from a contract with a "Consumer" (as defined in the Acts) would contravene any provision of the Acts or cause any part or all of this warranty to be void, is called a "Non-excludable Condition". To the full extent permitted by law, Fuji Xerox's sole and total liability to the customer for a breach of any Non-excludable Condition (including for any consequential loss suffered by the customer) is limited, except as otherwise stated herein, to (at Fuji Xerox's option) replacing or repairing the goods, or resupplying, or paying the cost of the resupply of, the services, in respect of which the breach occurred. Subject to the above, all conditions and warranties which would or might otherwise be implied in a Consumer contract, whether by operation of statute, inference from circumstances, industry practice or otherwise, are excluded.

User safety summary

Your printer and the recommended consumable supplies have been designed and tested to meet strict safety requirements. Attention to the following notes will ensure the continued safe operation of your printer.

Electrical Safety

- Use the power cord supplied with your printer.
- Do not use a ground adapter plug to connect the printer to a power source receptacle that lacks a ground connection terminal.
- Plug the power cord directly into a properly-grounded electrical outlet. Do not use an extension cord. If you do not know whether an outlet is grounded, ask an electrician to check the outlet.

Warning

Avoid the potential of severe electrical shock by ensuring the printer is properly grounded.

- Do not place the printer where people may step on the power cord.
- Do not place objects on the power cord.
- Do not obstruct the ventilation openings. These openings are provided to prevent overheating of the printer.

Warning

Do not push objects into slots or openings on the printer. Making contact with a voltage point or shorting out a part could result in fire or electrical shock.

- If you notice unusual noises or odors, switch off the printer power immediately. Disconnect the power cord from the electrical outlet. Call an authorized service representative to correct the problem.
- The power cord is attached to the printer as a plug-in device at the back of the printer. In the event it is necessary to remove all electrical power from the printer, disconnect the power cord from the power receptacle.

Note

Leaving the printer on all the time is recommended for optimum performance, and does not pose a safety hazard.

- If any of the following conditions occur, switch off the printer power immediately, disconnect the power cord, and call an authorized service representative.
 - The power cord is damaged or frayed.
 - Liquid has spilled into the printer.

- The printer is exposed to water.
- Any part of the printer is damaged.

Maintenance Safety

- Do not attempt any maintenance procedure that is not specifically described in the documentation supplied with your printer.
- Do not use aerosol cleaners. The use of supplies that are not approved may cause poor performance and could create a dangerous condition.
- Do not remove the covers or guards that are fastened with screws unless you are installing optional equipment and are specifically instructed to do so. Power should be OFF when performing these installations. Except for user-installable options, there are no parts that you can maintain or service behind these covers.

Operational Safety

Your printer and supplies were designed and tested to meet strict safety requirements. These include safety agency examination, approval, and compliance with established environmental standards.

Your attention to the following safety guidelines will help to ensure the continued safe operation of your printer.

- Use the material and supplies specifically designed for your printer. The use of unsuitable materials may result in poor performance and possibly a hazardous situation.
- Follow all warnings and instructions marked on, or supplied with, the printer, options, and supplies.
- Place the printer in a dust-free area where the temperature range is 50 degrees F to 90 degrees F (10 degrees C to 32 degrees C) and the relative humidity is 10 percent to 85 percent.

Place the printer in an area where there is adequate space for ventilation, operation, and servicing. The recommended minimal spacing is:

- 45.72 cm (18 in.) above the printer
- 10.16 cm (4 in.) behind the printer
- 10.16 cm (4 in.) on each side of the printer
- unrestricted access in front of the printer, for access to the trays

Do not block or cover the slots or openings on the printer. Without adequate ventilation, the printer may overheat.

- Place the printer on a level surface (no more than a 3 degree tilt).
- For optimum performance, use the printer at elevations below 2,400 meters (7,874 ft.).
- Do not place the printer near a heat source.
- Do not place the printer in direct sunlight.
- Do not place the printer in line with the cold air flow from an air conditioning system.

- Place the printer on a level, solid surface with adequate strength for the weight of the machine. The base printer weight without any packaging materials is 36 kg (79 pounds).
- The printer is heavy, and must be lifted by two people. The illustration below shows the proper technique for lifting the printer.

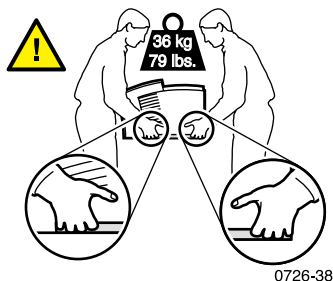

- Exercise care in moving or relocating the printer. It is front heavy and could tip forward. Follow the recommended procedure when moving the printer from one location to another. Refer to the *Phaser 860 Setup Instructions* and page 68 of this *User Guide*.
- Do not place any liquids on the printer.

Warning

Be careful when working in areas inside the printer identified with a warning symbol. These areas may be very hot and could cause personal injury.

- Wait 10-15 seconds between switching the printer off and on.
- Keep hands, hair, neckties, etc., away from the exit-feed rollers.
- Do not remove a paper tray while printing, even if the paper tray is not being used for the current print job. All trays must be in place for media to be fed through the printer's paper path.

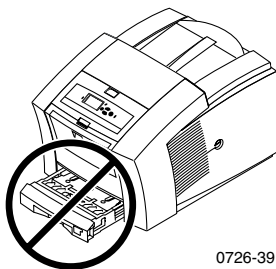

- Do not open the covers while printing.



0726-40

- Do not switch off the printer power while printing.

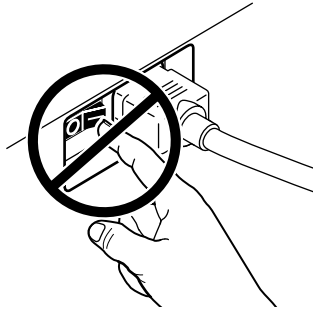

0726-41

- Do not move the printer while printing. Refer to page 68 for instructions for moving the printer.

Symbols as marked on product:

DANGER high voltage:



4525-101

Protective ground (earth) terminal:



4525-102

Hot surface on or in the printer. Use caution to avoid personal injury:



4525-103



4525-104



4525-105

Use caution. Refer to the manual(s) for information:



4525-106

Warning

If the product loses the ground connection, usage of knobs and controls (and other conductive parts) can cause an electrical shock. Electrical products may be hazardous if misused.

Warning

For your protection, do not defeat any door switches.

Printer Parts and Supplies

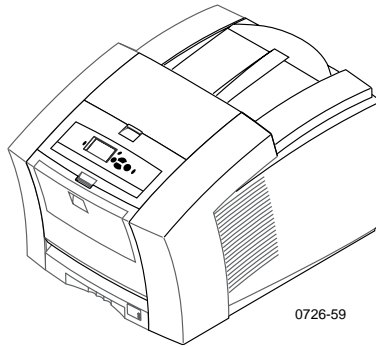

Note

Inside the printer, all handles and points of user interaction are **green**. Disposable parts in the Maintenance Kit are **orange**.

To order supplies and accessories, contact your local dealer or visit the Xerox web site:

www.xerox.com/officeprinting/supplies/

Customer-Replaceable Consumables (CRCs)

Maintenance Kits

Item	Part Number
Extended Maintenance Kit	016-1932-00
<ul style="list-style-type: none"> ■ Replacement maintenance roller and counter ■ Life up to 40,000 pages or 15 months, whichever comes first 	
Standard Maintenance Kit	016-1933-00
<ul style="list-style-type: none"> ■ Replacement maintenance roller and counter ■ Life up to 10,000 pages or 15 months, whichever comes first 	

Phaser 860 ColorStix® II Ink

Item	Part Number
3 Free Black ColorStix II ink	016-1902-01
5 Black ColorStix II ink	016-2019-00
5 Cyan ColorStix II ink	016-2020-00
5 Magenta ColorStix II ink	016-2021-00
5 Yellow ColorStix II ink	016-2022-00
5 Cyan ColorStix II ink plus 2 Free Black Colorstix II ink	016-1903-01
5 Magenta ColorStix II ink plus 2 Free Black ColorStix II ink	016-1904-01
5 Yellow ColorStix II ink plus 2 Free Black ColorStix II ink	016-1905-01
2 Cyan ColorStix II ink plus 1 Free Black ColorStix ink II	016-1906-01
2 Magenta ColorStix II ink plus 1 Free Black ColorStix II ink	016-1907-01
2 Yellow ColorStix II ink plus 1 Free Black ColorStix II ink	016-1908-01

Customer-Replaceable Units (CRUs)

Replacement and Cleaning Items

Item	Part Number
Waste Tray for Maintenance Drawer	436-0415-00
Maintenance Drawer (includes Standard Maintenance Kit)	436-0414-00
Rapid Release Guide	650-4214-00
Output Tray Extension	381-0497-00
<ul style="list-style-type: none"> ■ Use when print from the Legal Paper Tray 	
Cleaning Kit	016-1845-00
<ul style="list-style-type: none"> ■ Package of 5 alcohol wipes 	

Accessories

Trays

Item	Size	Part Number
Standard Paper/Transparency Tray	A/Letter (U. S.)	436-0409-00
■ Holds 200 sheets of paper	A4 (Metric Letter)	436-0410-00
■ Holds 50 sheets of labels		
■ Holds 50 transparencies		
Legal Paper Tray	Legal (U. S.)	436-0413-00
■ Holds 200 sheets of legal paper		
High-Capacity Transparency/ Label Tray	A/Letter (U. S.)	436-0411-00
■ Holds 175 transparencies	A4 (Metric Letter)	436-0412-00
■ Holds 100 sheets of labels		

High-Capacity Paper Tray Assembly

Item	Part Number
■ Holds 500 sheets of Letter-size or A4-size paper	860LTA
■ Increased paper-printing capacity	
■ Increased printing versatility and convenience	
■ Up to two High-Capacity Paper Tray Assemblies can be used	

Printer Station

Item	Part Number
■ Ergonomic surface height	ZCARTA
■ Provides storage for supplies	
■ Movable for easy access to rear cables	

Internal Hard Drive

Item	Part Number
<ul style="list-style-type: none"> ■ 5-Gbyte capacity 	860HD
<ul style="list-style-type: none"> ■ Collation, downloaded fonts, forms and overlays functionality (requires the DP Feature Set also) ■ ProofPrint, Saved Print, and Secure Print functionality (requires the DP Feature Set also) 	

Upgrades

Item	Part Number
<ul style="list-style-type: none"> ■ Adds 10/100T Ethernet support to Phaser 860B (non-network) configuration ■ This upgrade is needed (along with 860FP) to upgrade a Phaser 860B configuration to the DP Feature Set. 	860FN
<ul style="list-style-type: none"> ■ Upgrades a Phaser 860N to a Phaser 860DP ■ High Resolution/Photo print-quality mode, 1200 x 600 dpi ■ Automatic two-sided printing capability ■ Additional 64 Mbytes of memory (128 Mbytes total) ■ ProofPrint, Saved Print, and Secure Print functionality (requires the internal hard drive also) ■ Quick Collate functionality (requires the internal hard drive also) ■ Page Pipelining 	860FP

Phaser® Memory

Features	Size	Part Numbers
■ Guaranteed performance	64 Mbytes	ZMC64
■ Faster image processing	128 Mbytes	ZMC128
■ Up to 192 Mbytes maximum		

The printer has two memory slots. When adding memory, you can use 64-Mbyte and 128-Mbyte DIMMs in combination.

Parallel Cables

Item	Part Number
Parallel cable	012-1468-00
<ul style="list-style-type: none"> ■ 3 meters long ■ Use to connect your computer to the printer's high-density parallel port 	
Parallel adapter	013-0299-00
<ul style="list-style-type: none"> ■ Use to connect a low-density parallel cable to the printer's high-density parallel port 	

Paper and specialty media

Xerox Phaser paper, transparencies, labels, and business cards have been developed and tested specifically for use in your Phaser 860 color printer. They will provide optimal print quality, reliability, and durability.

Xerox Phaser Professional Printing Paper

Item	Size	Description	Part Number
Phaser Premium Color Printing Paper 90 g/m ² (24 lb. bond paper)	A/Letter (U. S.) 8.5 x 11 in.	500 sheets	016-1368-00
Phaser Premium Color Printing Paper 90 g/m ² (24 lb. bond paper)	A4 (Metric Letter) 210 x 297 mm	500 sheets	016-1369-00
Phaser 860 Glossy Coated Paper 148 g/m ² (100 lb. text)	A/Letter (U. S.) 8.5 x 11 in.	100 sheets	016-1936-00
Phaser 860 Glossy Coated Paper 148 g/m ² (100 lb. book)	A4 (Metric Letter) 210 x 297 mm	100 sheets	016-1937-00
Phaser Premium Cover Paper 160 g/m ² (60 lb. cover)	A/Letter (U. S.) 8.5 x 11 in.	100 sheets	016-1823-00

Xerox Phaser Professional Printing Paper (cont'd.)

Item	Size	Description	Part Number
Phaser Premium Cover Paper 160 g/m ² (60 lb. cover)	A4 (Metric Letter) 210 x 297 mm	100 sheets	016-1824-00
Phaser High Resolution Photo Paper 170 g/m ²	A/Letter (U. S.) 8.5 x 11 in.	25 sheets	016-1808-00
Phaser High Resolution Photo Paper 170 g/m ²	A4 (Metric) 210 x 297 mm	25 sheets	016-1809-00

Phaser 860 Transparency Film

Item	Size	Description	Part Number
Premium	A/Letter (U. S.) 8.5 x 11 in.	50 sheets	016-1876-00
Premium	A4 (Metric Letter) 210 x 297 mm	50 sheets	016-1877-00
Standard	A/Letter (U. S.) 8.5 x 11 in.	50 sheets	016-1874-00
Standard	A4 (Metric Letter) 210 x 297 mm	50 sheets	016-1875-00

Color Printing Labels

Size	Description	Part Number
A/Letter (U. S.) 8.5 x 11 in.	100 sheets; 30 labels per sheet (each label: 1 x 2-5/8 in.)	016-1812-00
A/Letter (U. S.) 8.5 x 11 in.	100 sheets; 6 labels per sheet (each label: 3-1/3 x 4 in.)	016-1813-00
A4 (Metric Letter) 210 x 297 mm	100 sheets; 14 labels per sheet (each label: 38.1 x 99.1 mm)	016-1814-00
A4 (Metric Letter) 210 x 297 mm	100 sheets; 8 labels per sheet (each label: 67.1 x 99.1 mm)	016-1815-00

Premium Die-cut Business Cards

Size	Description	Part Number
A/Letter (U. S.) 8.5 x 11 in.	25 sheets; 10 pre-cut cards per sheet heavyweight: 190 g/m ² (70 lb.)	016-1898-00
A4 (Metric Letter) 210 x 297 mm	25 sheets; 10 pre-cut cards per sheet heavyweight: 190 g/m ² (70 lb.)	016-1899-00

Front Panel

The front panel:

- Displays the printer's operating status (Ready to Print, Printing).
- Alerts you to load paper, replace consumables, and clear jams.
- Enables you to print reports and information pages.
- Enables you to access tools and information pages to help troubleshoot problems.
- Enables you to change printer and network settings; (driver settings override settings set on the printer's front panel).
- Enables you to print Secure Print, Proof Print, and Saved Print jobs that you have stored on the printer's hard disk; (refer to the printer driver help for more information).

Parts of the front panel

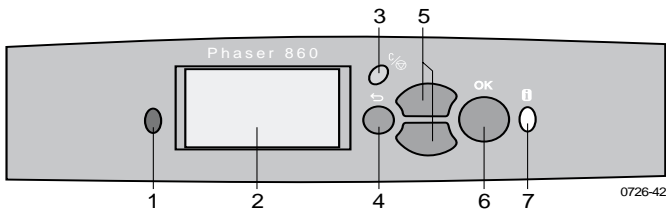

1. Status indicator light — green when operating correctly; red when there is a problem
2. Display screen
3. **Cancel Print** key — cancels the current print job
4. **Back** key — returns the display to the previous menu
5. **Scroll Up** and **Scroll Down** keys — scrolls through the front panel menus
6. **OK** key — selects the highlighted menu setting
7. **Information** key — (press at any time) displays additional information on the message or menu on the display screen

Printing a Menu Map

The **Menu Map** shows you where features, such as the information pages, are located in the front panel's menu structure.

1. With **Menus** highlighted, press the **OK** key.
2. Scroll to **Print Menu Map** by pressing the **Scroll Up** or **Scroll Down** key.
3. Press the **OK** key.

Printing information pages

A large amount of useful information is stored in your printer as printable pages. Access these pages from the **Printable Pages Menu**:

1. With **Menus** highlighted, press the **OK** key.
2. Scroll to **Printable Pages Menu** by pressing the **Scroll Up** or **Scroll Down** key.
3. Press the **OK** key.
4. Scroll to the desired information page (such as **Print Quality Tips**).
5. Press the **OK** key.

Front panel error conditions

When the front panel prompts you that there is a paper jam, it describes the location of the jam. Refer to page 47 for information on clearing jams.

When the front panel prompts you that a supply is low or needs to be replaced, make sure that you have replacements on hand. Refer to page 1 for ordering information.

Features

Your Phaser 860 Color Printer comes with many useful features to help you create the best possible printed documents. You can access the printer features in the printer driver, which you use when you send a print job to the printer. To ensure that you have access to all of the printer features, make sure you have installed the printer driver that comes on your Phaser 860 Printer CD-ROM. Updated printer drivers are also available on the Xerox web site:

www.xerox.com/officeprinting

Note

You can also set some of the features on the printer's front panel. The settings in the printer driver override the front panel settings.

The following features are described in this manual:

- Print quality mode — see page 11
- TekColor correction — see page 12
- 2-sided printing — see page 39
- Legal paper printing — see page 23

For information on the following features, refer to the printer driver help or the *Advanced Features and Troubleshooting Guide*, which is available on your Printer CD-ROM:

- Secure prints, proof prints, and saved prints
- Separation pages
- Multiple pages on a single sheet of paper
- Booklet printing
- Negative images
- Mirror images
- Scaling
- Watermarks

Print quality modes

You can choose between different print quality modes to obtain the best combination of speed and print quality for your job.

Print quality mode	Maximum speed *
Fast Color	16 ppm Paper
<ul style="list-style-type: none">■ Fastest color print mode■ Ink-saving mode since prints lighter than Standard mode■ Useful for text and business graphics■ Ideal for previewing work■ Produces fast, high-quality transparencies	7 ppm Transparency
Standard	10 ppm Paper
<ul style="list-style-type: none">■ General-purpose mode for color printing■ Produces vibrant, saturated prints with smooth color transitions■ Suitable for most office uses and images■ Best quality mode for printing transparencies	3.5 ppm Transparency
Enhanced	6 ppm Paper *
<ul style="list-style-type: none">■ Balance of high quality and fast speed■ Increases color saturation compared to Standard mode■ Smoothest and brightest large-area fills■ Useful for printing paper copies of overhead presentations	
High Resolution/Photo	3.5 ppm Paper *
<ul style="list-style-type: none">■ Highest-quality color prints■ Richest color and near-photographic detail■ Makes very fine lines, sharp edges, and small text sharper■ 1200 x 600 dpi■ Printer must have the DP Features Set (or must be a DX model)	

* Approximate number of pages per minute based on prints with margins of .5 in. or greater; does not include image processing time.

* Transparencies are printed in Standard mode.

TekColor™ color corrections

You can select a color correction to match particular press specifications or match your computer screen's colors. Otherwise, select **Automatic** to let the printer automatically pick the best color correction for elements in your document.

Color correction	Description
Automatic	<ul style="list-style-type: none">■ Automatically optimizes the color correction for each element (text, graphics, and photographs) on the page
sRGB Display	<ul style="list-style-type: none">■ Closely approximates the colors on a standard display screen
Vivid Color	<ul style="list-style-type: none">■ Produces the brightest possible colors and makes blues appear less purple
None	<ul style="list-style-type: none">■ Doesn't use a color correction so the colors you specified in the application for your job are not altered■ Use when you have specified colors from the PANTONE® Color Chart
SWOP Press	<ul style="list-style-type: none">■ Matches U.S. press standards using the Specification for Web Offset Publications
Euroscale Press	<ul style="list-style-type: none">■ Emulates the Euroscale 4-color process press mode
Commercial Press	<ul style="list-style-type: none">■ Emulates a 4-color process commercial press mode
SNAP Press	<ul style="list-style-type: none">■ Matches the standards for printing on uncoated and newsprint papers using the Specifications for Non-Heat Advertising Printing
DIC	<ul style="list-style-type: none">■ Matches Dai Nippon printing inks on coated paper
Toyo	<ul style="list-style-type: none">■ Matches commercial Toyo printing inks on coated paper
FujiProof	<ul style="list-style-type: none">■ Matches the Fuji Color Art System for commercial North American proofs
Black and White	<ul style="list-style-type: none">■ Produces a black-and-white version of a document■ Colors converted to grayscale■ Use to print page masters for photocopying in black-and-white

Paper and Print Media

Paper tips

- Only use the supported paper types, sizes, and weights.
- Do not use perforated paper.
- Store the paper on a flat surface, in a relatively low-humidity environment.
- Avoid storing paper in such a way as to cause wrinkling, bending, curling, etc.
- Do not unwrap paper until you are ready to use it, and rewrap any paper you are not using.
- Do not expose paper to direct sunlight.
- Do not expose paper to high humidity, since moisture can affect feed reliability.
- Handle transparencies by the edges and with both hands to avoid fingerprints and creases, which can result in poor print quality.
- Always use the manual-feed slot for envelopes.

Supported media

Refer to the following table for the supported paper and media types, sizes, and weights and the correct trays to load that media. You can also print the **Paper Tips Page** from the printer's front panel, which lists the supported paper types and sizes.

Supported paper and print media

Media Type/Size/Weight	Standard Paper/Transparency Tray *	High-Capacity Paper Tray **	High-Capacity Transparency /Label Tray *	Legal Paper Tray *	Manual -Feed Slot
Bond or equivalent Letter or A4 60-120 g/m ² (16-32 lbs.)	● (1)	●			●
Bond or equivalent Letter or A4 120-150 g/m ² (32-40 lbs.) ‡	● (1)				●
Bond or equivalent Executive or A5 60-150 g/m ² (16-40 lbs.)					●
Bond or equivalent Legal 75-105 g/m ² (20-28 lbs)				●	●
Heavy paper/cover stock 150-160 g/m ² (40-60 lbs.)	● (1)				●
Heavy paper/cover stock 176 - 216 g/m ² (65-80 lbs.) ‡					●
Coated or glossy paper Letter or A4	● (1)				●
High-Resolution Photo paper; Letter or A4 ‡	● (1)				●
Short-grained paper Letter or A4 105-150 g/m ² (28-40 lbs.)	● (1)				●
Transparencies ‡	● (2)		● (2)		●
Labels ‡	● (1)		● (3)		●
Business Cards ‡					●
Envelopes *** ‡					●

(1) Tray switch set to **Paper**(2) Tray switch set to **Transparency**(3) Tray switch set to **Label**

‡ Print single sided only

* If your printer has more than one tray, this is the Upper Tray

** Middle or Lower Tray

*** See page 16 for acceptable envelope sizes and types

Print area of supported paper sizes

The image area of a print is slightly smaller than the paper size. You may need to adjust the page margins in your application software to match the print area. When sending a job to the printer, select the paper size in the printer driver.

Print area of supported paper sizes

Paper*	Sheet size	Print area	Top/ bottom margins	Left/ right margins
1. Letter	215.9 x 279.4 mm (8.5 x 11 in.)	205.9 x 269.4 mm (8.1 x 10.6 in.)	5 mm (.2 in.)	5 mm (.2 in.)
2. Executive	184 x 267 mm (7.25 x 10.5 in.)	174 x 253 mm (6.85 x 9.95 in.)	7 mm (.275 in.)	5 mm (.2 in.)
3. Legal	215.9 x 355.6 mm (8.5 x 14 in.)	205.9 x 304.8 mm (8.1 x 12 in.)	25.4 mm (1.0 in.)	5 mm (.2 in.)
4. A4	210 x 297 mm 8.27 x 11.7 in.)	200 x 287 mm (7.87 x 11.3 in.)	5 mm (.2 in.)	5 mm (.2 in.)
5. A5	148 x 210 mm (5.83 x 8.27 in.)	138 x 196 mm (5.43 x 7.72 in.)	7 mm (.275 in.)	5 mm (.2 in.)

* Transparencies are available in Letter-size and A4-sizes only.

To determine which tray to use for these paper sizes, refer to page 14.

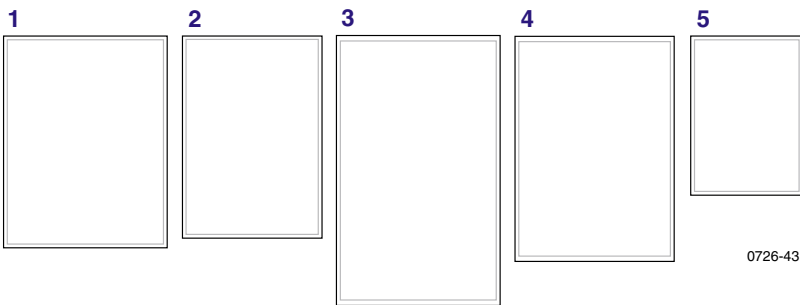

To print on envelopes, use the manual-feed slot; see page 34.

Print area of supported envelope sizes

Envelopes	Envelope size	Print area	Top/ bottom margins (A/B)	Left/ right margins (C/D)
#10 (U. S.)	4.13 x 9.5 in.	3.73 x 8.95 in.	.2 in.	.275 in.
#6.75 (U. S.)	3.65 x 6.5 in.	3.25 x 5.95 in.	.2 in.	.275 in.
Monarch (U. S.)	3.875 x 7.5 in.	3.475 x 6.95 in.	.2 in.	.275 in.
C5	162 x 229 mm	152 x 197 mm	5 mm	7 mm 25 mm
DL	110 x 220 mm	100 x 206 mm	5 mm	7 mm
Choukei 3 Gou	120 x 235 mm	110 x 221 mm	5 mm	7 mm
Choukei 4 Gou	90 x 205 mm	80 x 191 mm	5 mm	7 mm

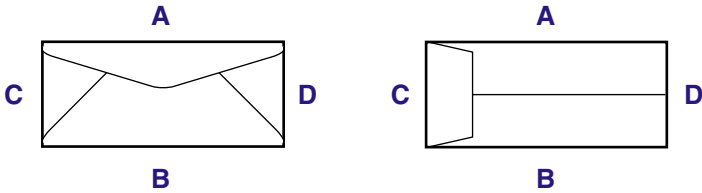

0726-88

Loading Trays

For a list of the recommended paper, transparencies, and labels that can be used in each type of tray, refer to page 14.

Loading the Standard Paper/Transparency Tray

You can also refer to the labels inside the tray for loading instructions.

1. Pull out the tray.
2. Load the print media.
 - One-sided job — Load paper with the side to be printed **face up**. Load letterhead paper **face up** with the letterhead toward the **front** of the tray. Load transparencies with the side to be printed **face up** and the notch in the **back-right** corner of the tray.
 - Two-sided job — Load paper with the side to be printed first **face down**. Place letterhead paper **face down** with the letterhead toward the **back** of the tray. For more information on two-sided printing, refer to page 39.

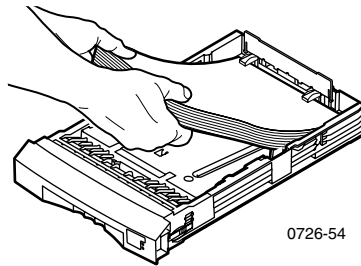

Note

Make sure that you place the paper or transparencies under the tabs in the back of the tray.

3. Observe the fill lines on the left side of the tray. Don't load paper above the **Paper** fill line. Don't load transparencies or labels above the **Transparency/Label** fill line.

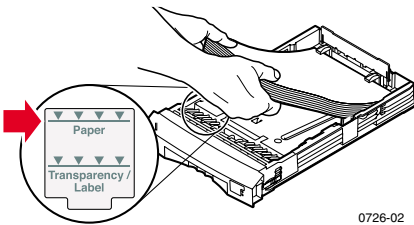

0726-02

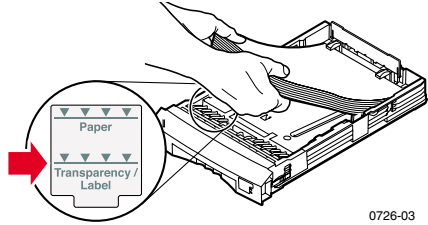

0726-03

4. If you loaded paper, make sure that the tray switch on the front-right side of the tray is set to **Paper** (forward position). If you loaded transparencies, make sure that the tray switch is set to **Transparency** (back position).

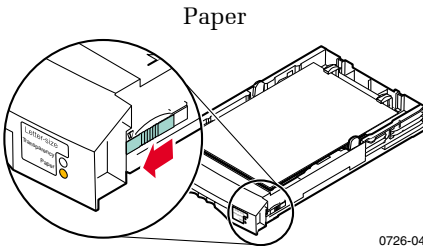

0726-04

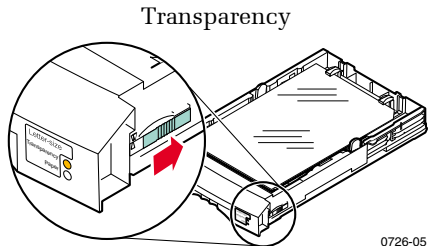

0726-05

5. Slide the tray back into the printer.

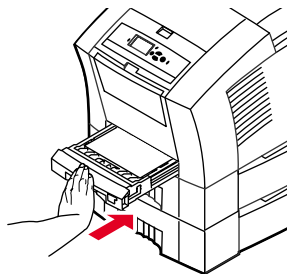

0726-06

Note

Do not place paper that was printed on one side back into the printer to print on the second side. Pre-printed pages may stick together.

Loading the Optional High-Capacity Paper Tray

The optional high-capacity paper tray assembly is located under the base printer. You can have one or two high-capacity paper tray assemblies. The trays are then called the Middle Tray and Lower Tray in the printer driver software.

Note

Do NOT load transparencies in a high-capacity tray.

You can refer to the labels inside the tray for paper-loading instructions.

1. Pull out and completely remove the tray.

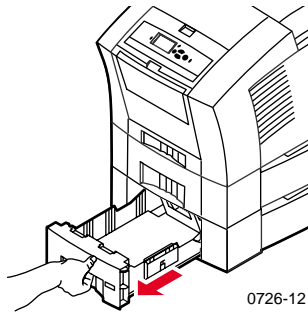

2. If there is any paper remaining in the tray, remove it.

Note

Do not re-use the remaining paper in a high-capacity paper tray. If that paper is not damaged, it may be used in the standard paper tray (upper tray).

3. Open a new ream of paper. Remove any bent or torn sheets of paper from the ream.

- Slide the ream of paper into the tray so that the paper rests up against the angled paper stop at the rear of the tray. The stack of paper should assume the same angle as the paper stop.

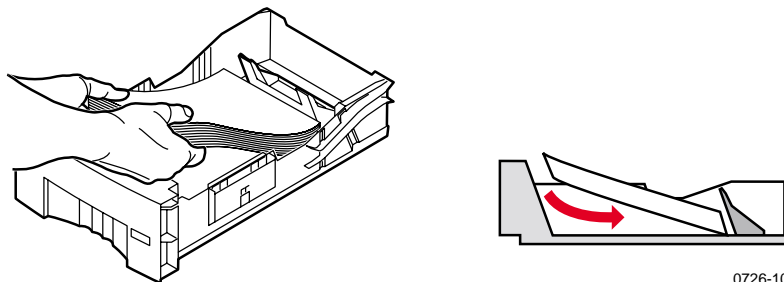

0726-10

Note

Don't load paper above the fill line on the left side of the tray.

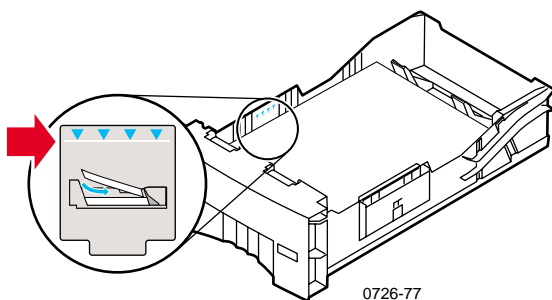

0726-77

Note

If you are loading letterhead and printing on one side of the paper, place the paper **face up** with the letterhead toward the **front** of the tray. For two-sided jobs, place the letterhead paper **face down** with the letterhead toward the **back** of the tray.

- Remove any sheets that are damaged.

6. Tilt the back left corner of the tray downward slightly and shake the tray front-to-back several times until the paper is uniformly aligned along the left side of the tray and rear paper stop.

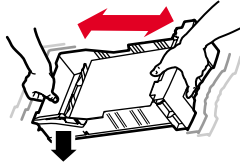

0726-11

7. Re-insert the tray in the printer.

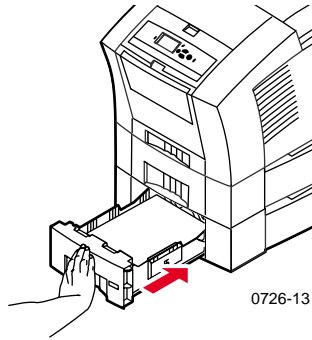

0726-13

Loading the Optional High-Capacity Transparency/Label Tray

The optional high-capacity transparency/label tray replaces the standard paper/transparency tray in the printer. It holds up to 100 sheets of labels or 175 transparencies (instead of 50 for the standard tray).

You can refer to the labels inside the tray for loading instructions.

1. Pull out the tray.
2. Load transparencies with the side to be printed **face up** and the notch in the **back-right** corner of the tray. Load labels with the side to be printed **face up**.

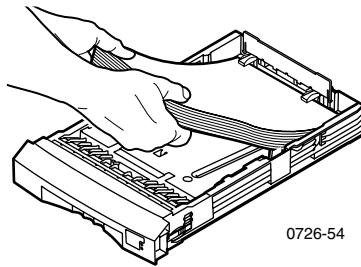

0726-54

Note

Make sure that you place the labels or transparencies under the tabs in the back of the tray.

3. Observe the fill lines on the left side of the tray. Don't load transparencies above the **Transparency** fill line. Don't load labels above the **Label** fill line.

4. If you loaded transparencies, make sure that the tray switch on the front-right side of the tray is set to **Transparency** (back position). If you loaded labels, make sure that the tray switch is set to **Label** (forward position).

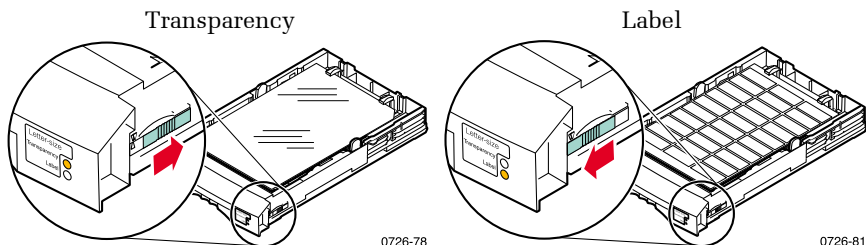

5. Slide the tray back into the printer.

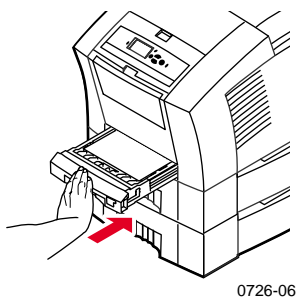

Note

Do not use two-sided printing for transparencies or labels.

Loading the Optional Legal Paper Tray

The optional legal paper tray replaces the standard paper/transparency tray in the printer.

You can refer to the labels inside the tray for paper-loading instructions.

1. Pull out the tray.

2. Load the print media.
 - One-sided job — Load paper with the side to be printed **face up**. Load letterhead paper **face up** with the letterhead toward the **front** of the tray.
 - Two-sided job — Load paper with the side to be printed first **face down**. Place letterhead paper **face down** with the letterhead toward the **back** of the tray. For more information on two-sided printing, refer to page 39.

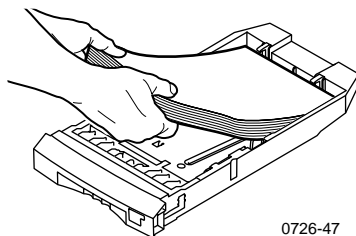

3. Observe the fill line on the left side of the tray. Don't load paper above the fill line.

Note

Make sure that you place the paper under the tabs in the back of the tray.

4. Slide the tray back into the printer.

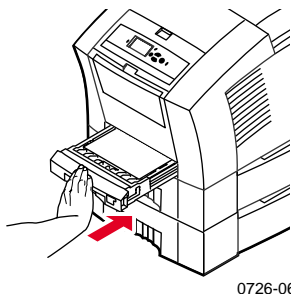

5. To print on this paper, be sure to select **Legal** for the **Paper Size** in the printer driver.

Note

If necessary, install the Output Tray Extension into the holes on the back of the printer. This extension keeps your legal-size paper from falling off the printer after it is printed.

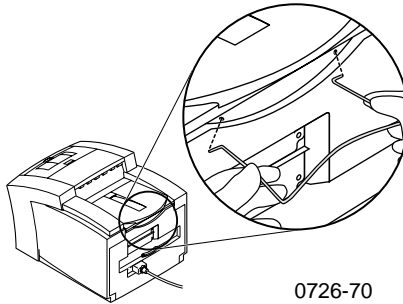

Manual-Feed Printing

For a list of the recommended papers, transparencies, labels, and business cards that can be used in the manual-feed slot, refer to page 14.

You can print one-sided or two-sided jobs from the manual-feed slot. For more information on two-sided printing, refer to page 39. Refer to page 38 for instructions on loading letterhead in the manual-feed slot. Transparencies and envelopes can only be printed on one side; refer to page 32 and page 34 for more information.

1. In the printer driver, select **Manual Feed-Paper** or **Manual Feed-Transparency** as the **Paper Source**.

Note

You also use the printer driver to select whether to print on one side or two sides.

2. Send the job to the printer.
3. If necessary, open the manual-feed slot.

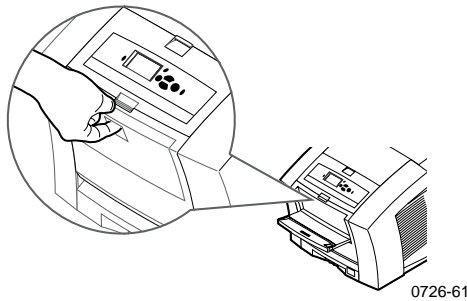

4. If necessary, adjust the guide on the right side of the slot for Letter-size (and Legal-size) or A4-size paper.

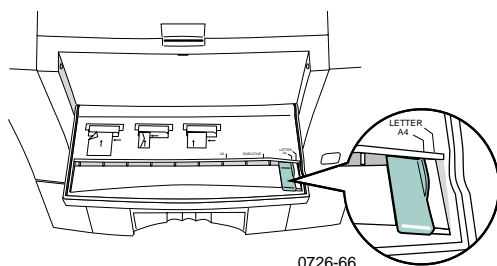

5. When the front panel displays the **Waiting for Manual Feed** prompt, insert one sheet or envelope into the manual feed slot until the printer pulls it in.

Align the paper, transparency, or envelope along the left side of the slot. For transparencies, make sure the **notch** is along the **right side** and enters **last**.

- One-sided job — The top of the sheet enters **first** and the side to be printed is **face down**, as shown in the following illustrations.
- Two-sided job — The top of the sheet enters **last** and the side to be printed first is **face up**.

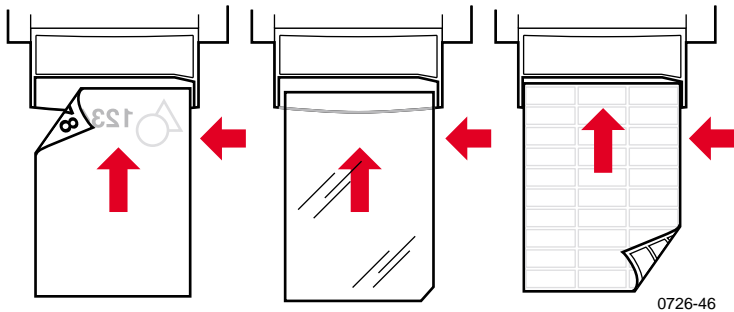

0726-46

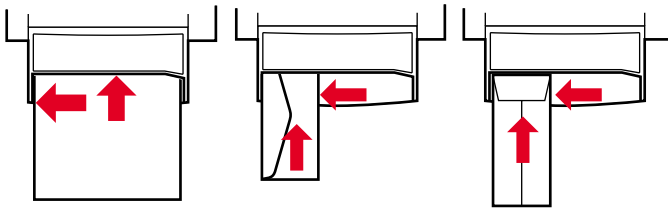

0726-55

6. Check the first print to make sure the image placement is correct.
7. Wait for the front panel to display the prompt again before inserting the next sheet.

Printing on Special Media

In addition to bond paper, the printer can print on the following special media:

- Phaser High-Resolution Photo Paper
- Phaser Labels and Phaser Business Cards — see page 30
- Phaser 860 Transparencies — see page 32
- Envelopes — see page 34
- Letterhead paper — see page 38

Printing on Phaser High-Resolution Photo Paper

The Phaser High-Resolution Photo Paper can be printed on **one side only**, since it has a Xerox logo on the reverse side. Refer to page 5 for more information.

1. You can either:
 - Place up to 50 sheets of the photo paper **face up** in the standard paper/transparency tray. Make sure that the tray switch is set to **Paper** (forward position).
 - Choose to manually feed the paper. Don't place the photo paper in the manual-feed slot until you are prompted by the printer's front panel to do so.
2. In the printer driver:
 - Select the tray containing the high-resolution photo paper (**Upper Tray**) or **Manual Feed-Paper**.
 - Select one-sided printing.
 - Select **High-Resolution/Photo** for the **Print Quality** mode.
3. Send the job to the printer.
4. If you selected **Manual Feed-Paper**, wait until the printer's front panel prompts you, then insert the first sheet **face down** in the manual-feed slot. Wait until you are prompted again before adding the next sheet.

Printing on labels and business cards

Guidelines

- Use only Phaser 860 Printer Color Printing Labels or Xerox Phaser Premium Business Cards; refer to page 6 for more information.
- If any of the labels or business cards on a sheet are missing, do not use that sheet; it may damage printer components.
- Keep labels and business cards in a cool, dry place. Never store labels and business cards in a high-humidity environment; labels and business cards stored under such conditions will jam in the printer.
- Store unused labels and business cards flat in their containers.
- Rotate stock frequently. Long periods of storage can cause the labels and business cards to curl and jam the printer.
- Print only on one side of the sheet of labels or business cards.

Method for printing on labels or business cards

1. If your application has a setting for labels, use it as a template. Otherwise, refer to the instructions included with the labels or business cards for margin settings.
2. To print on labels, you can either:
 - Place sheets of labels **face up** in the standard paper/transparency tray (up to 50 sheets) or high capacity transparency/label tray (up to 100 sheets). Make sure the tray switch is set to **Paper** or **Label** (forward position).

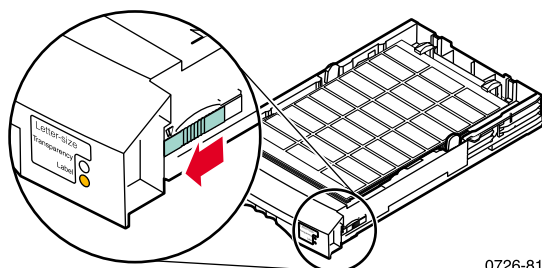

0726-81

- Choose to manually feed the labels. Don't place the labels in the manual-feed slot until you are prompted by the printer's front panel to do so.

To print on business cards, use the manual-feed slot. Don't place the sheet of business cards in the manual-feed slot until you are prompted by the printer's front panel to do so.

3. In the printer driver:
 - Select the tray containing the labels (**Upper Tray**) or select **Manual Feed-Paper**.
 - Select one-sided printing.
4. Send the job to the printer.
5. If you selected **Manual Feed-Paper**, wait until the printer's front panel prompts you, then insert the first sheet of labels or business cards **face down** in the manual-feed slot. Wait until you are prompted again before adding the next sheet.

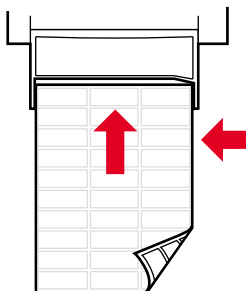

0726-71

Printing on transparencies

Note

Use only Phaser 860 Premium or Standard Transparencies. Refer to page 6 for more information. Handle transparencies by the edges and with both hands to avoid fingerprints and creases, which can cause poor print quality.

To print on transparencies:

1. You can either:
 - Place transparencies in the standard paper/transparency tray (up to 50 sheets) or high capacity transparency/label tray (up to 175 sheets) so that the **notch** of the transparencies is in the **back-right corner** of the tray. Make sure the tray switch is set to **Transparency** (back position).

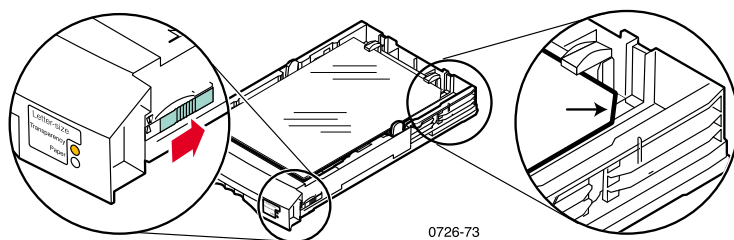

- Choose to manually feed the transparencies. Don't place a transparency in the manual-feed slot until you are prompted by the printer's front panel to do so.
2. In the printer driver:
 - Select the tray containing the transparencies (**Upper Tray**) or **Manual Feed-Transparency**.
 - Select one-sided printing.
 3. Send the job to the printer.

4. If you selected **Manual Feed-Transparency**, wait until the printer's front panel prompts you, then insert the first sheet into the manual-feed slot so that the **notch** of the transparency is on the **right side** and enters the manual-feed slot **last**. Wait until you are prompted again before adding the next transparency.

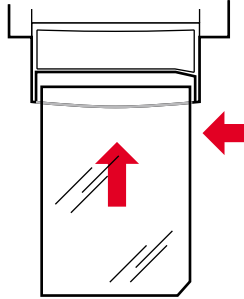

0726-62

Printing on envelopes

Guidelines

- Use only the recommended envelope sizes (see page 16)
- No windows or metal clasps
- No exposed gummed surfaces
- For best results, use light-weight, laser-quality envelopes
- Single-sided printing only
- Keep unused envelopes in their original packaging to avoid dust and humidity, which can affect print quality and cause wrinkling
- When prompted, load a single envelope in the manual-feed slot, aligning it along the left side

General method for printing on envelopes

1. In your application, create a document matching the measurements of the envelope; refer to page 16 for the print area and margins of supported envelopes.

Note

Many applications include a tool for creating an envelope. If you are using Microsoft WORD, refer to page 35 when using Windows or page 36 when using a Macintosh. When using other Macintosh applications, refer to page 37. For other applications, refer to your application's documentation.

2. From your application or printer driver, make these selections:
 - Set the orientation to **Landscape**.
 - Select your envelope size.
 - Select **Manual Feed-Paper** as the **Paper Source**.
 - If your application has a tool for creating envelopes, select the feed method that matches the illustration in Step 4.
3. Send the job to the printer

4. When the printer's front panel prompts you, insert the envelope in the manual-feed slot:
 - Short side enters **first**.
 - **Flap is face up and closed.**

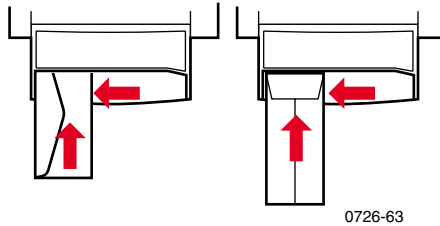

0726-63

Printing envelopes from Microsoft WORD for Windows

1. From the **Tools** menu, select **Envelopes and Labels**.
2. In the **Envelopes and Labels** dialog box, click the **Envelopes** tab and type the delivery and return addresses.
3. Click the **Feed** icon.
4. On the **Printing Options** tab, select all of the following:
 - **Face Down**
 - **Clockwise Rotation**
 - For **Feed From**, select **Manual Feed Paper**.
 - **Envelope feed on left** icon:

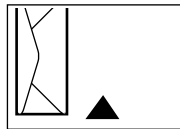

0726-82

5. Click the **Envelope Options** tab, select your envelope size in the **Envelope size** drop-down list, and click the **OK** button.
6. In the **Envelopes and Labels** dialog box, click the **Print** button.
7. When the printer's front panel prompts you, insert the envelope in the manual-feed slot.

Printing envelopes from Microsoft WORD on a Macintosh

1. From the **Tools** menu, select **Envelopes and Labels**.
2. In the **Envelopes and Labels** dialog box, click the **Envelopes** tab and type the delivery and return addresses.
3. Click the **Feed** icon.
4. On the **Printing Options** tab, select all of the following:
 - **Face Down**
 - **Clockwise Rotation**
 - **Use Envelope Feeder**
 - **Envelope feed on left** icon:

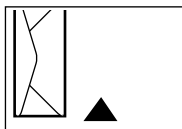

0726-82

5. Click the **Envelope Options** tab, select your envelope size in the **Envelope size** drop-down list, and click the **OK** button.
6. In the **Envelopes and Labels** dialog box, click the **Print** button.
7. In the **Page Setup** dialog box, select all of the following **Page Attributes**:
 - **Paper**: select your envelope size.
 - **Orientation**: select **Landscape**.
8. From the drop-down menu, select **PostScript Options**, and make the following selections:
 - **Flip Horizontal**
 - **Flip Vertical**
9. Click the **OK** button.
10. In the **Print** dialog box, in **General** options, select **Manual Feed Paper** for **Paper Source** and click the **Print** button.
11. When the printer's front panel prompts you, insert the envelope in the manual-feed slot.

Printing envelopes from other applications on a Macintosh

Follow the instructions in the application documentation. If the envelope address prints upside-down, change the **Page Setup** settings in your printer driver before printing on another envelope:

1. From the **File** menu, select **Page Setup**.
2. Select the following **Page Attributes**:
 - **Paper**: select your envelope size.
 - **Orientation**: select **Landscape**.
3. From the drop-down menu, select **PostScript Options**, and make the following selections:
 - **Flip Horizontal**
 - **Flip Vertical**
4. Click the **OK** button.
5. From the **File** menu, select **Print**.
6. For **Paper Source**, select **Manual Feed Paper**.
7. Click **Print** button.
8. When the printer's front panel prompts you, insert the envelope in the manual-feed slot.

Printing on letterhead paper

Letterhead paper can be printed on one side or two sides. Refer to page 14 for the weights and sizes of paper you can use.

1. You can either:
 - Place the letterhead paper in the standard paper/transparency tray (with the tray switch set to **Paper**) or a high capacity paper tray.

One-sided job — place the letterhead paper **face up** with the letterhead towards the **front** of the tray.

Two-sided job — place the letterhead paper **face down** with the letterhead towards the **back** of the tray.

- Choose to manually feed the paper. Don't place the paper in the manual-feed slot until you are prompted by the printer's front panel to do so.
2. In the printer driver:
 - Select the tray containing the letterhead paper or **Manual Feed-Paper**.
 - Select either one-sided printing or two-sided printing.
 3. Send the job to the printer.
 4. If you selected **Manual Feed-Paper**, wait until the printer's front panel prompts you before inserting the paper.

One-sided job — Place the letterhead paper **face down** with the letterhead entering the manual-feed slot **first**.

Two-sided job — Place the letterhead paper **face up** with the letterhead entering the manual-feed slot **last**.

Wait until you are prompted again before adding the next sheet of paper.

Printing Two-Sided Jobs

You can have the printer automatically print two-sided (duplex) jobs using Letter-size, A4-size, or Legal-size paper in the paper trays or the manual-feed slot. Refer to page 14 for the weights and types of paper you can use.

Do not print two-sided jobs on transparencies, labels, business cards, envelopes, heavy paper, card stock, index stock, or high-resolution photo paper.

Caution

Do not place paper that was printed on one side back into the printer to print on the second side. Pre-printed pages may stick together and not feed properly.

When you print any job, you can use the printer driver to select the orientation of the images on the page: **Portrait** or **Landscape**. When you print two-sided jobs, you also select the binding preference, which determines how the pages turn; refer to the table on page 41 for the wording used in the printer drivers.

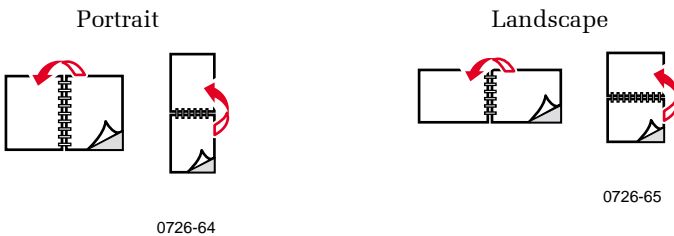

Printing two-sided jobs

1. You can either:
 - Place the paper in the standard paper/transparency tray (with the tray switch set to **Paper**), legal tray, or a high capacity paper tray, depending on its size. If you are printing on letterhead, refer to page 38.
 - Choose to manually feed the paper. Don't place the paper in the manual-feed slot until you are prompted by the printer's front panel to do so.
2. In the printer driver:
 - Select the tray containing the paper or **Manual Feed-Paper**.
 - Select two-sided printing. Refer to the table on page 41 for the wording used in the printer drivers.
3. Send the job to the printer.
4. If you selected **Manual Feed-Paper**, wait until the printer's front panel prompts you, then insert the first sheet of paper in the manual-feed slot. Wait until you are prompted again before adding the next sheet.

Note

When the printer prints a two-sided job, the paper partially exits then is fed back in to print on the second side. To avoid paper jams, do not touch the paper before it completely exits the printer.

Setting the printer driver for two-sided printing

Macintosh LaserWriter 8.6 OR LaserWriter 8.7	<ol style="list-style-type: none">1. From the File menu, select Print, and then select Layout.2. Select Print on Both Sides.3. Select a binding preference.
Windows 95 OR Windows 98	<ol style="list-style-type: none">1. From the File menu, select Print.2. Click the Properties button.3. On the Setup tab, select Print on 2 sides.4. Check or uncheck Bind on Top Edge.
Windows 2000	<ol style="list-style-type: none">1. From the File menu, select Print.2. Click the Properties button.3. On the Layout tab, select either Flip on Long Edge or Flip on Short Edge.
Windows NT	<ol style="list-style-type: none">1. From the File menu, select Print.2. Click the Properties button.3. On the Page Setup tab, select either Long Edge or Short Edge.

Troubleshooting Print Quality

Band of color(s) missing

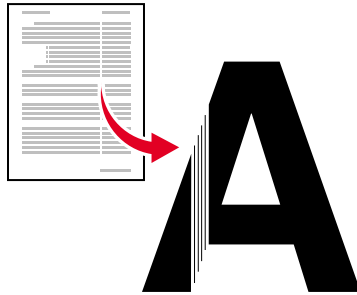

0726-87

Determine whether the problem occurs for some colors or all colors by printing the **Diagnostic Pages** from the printer's front panel:

1. With **Menus** highlighted, press the **OK** key.
2. Scroll to **Printable Pages Menu** by pressing the **Scroll Up** or **Scroll Down** key.
3. Press the **OK** key.
4. Scroll to **Print Diagnostic Pages**.
5. Press the **OK** key.

Note

You can also print the **Diagnostic Pages** from the **Troubleshooting** tab in the driver.

Band of colors prints correctly

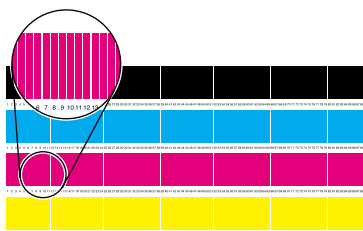

Band of one color (magenta) missing

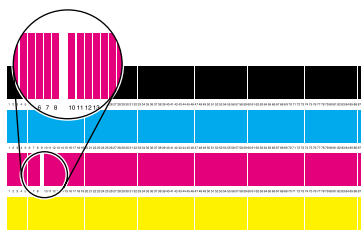

0726-83

One or more color bars are missing

1. On the front panel, select **Eliminate Light Stripes** to clean the printhead and print a test print:
 - a. With **Menus** highlighted, press the **OK** key.
 - b. Scroll to **Support Menu** by pressing the **Scroll Up** or **Scroll Down** key.
 - c. Press the **OK** key.
 - d. Scroll to **Improve Print Quality?**.
 - e. Press the **OK** key.
 - f. Scroll to **Eliminate Light Stripes**.
 - g. Press the **OK** key.

Note

You can also select **Eliminate Light Stripes** from the **Troubleshooting** tab in the driver.

2. If there is still a color band missing, repeat Step 1. Repeat up to three times in a row, if necessary.
3. If the problem persists:
 - a. Turn off the printer for at least 4 hours.
 - b. When you turn on the printer, print the **Diagnostic Pages** and, if necessary, select **Eliminate Light Stripes**.

All four color bars are missing in the test print

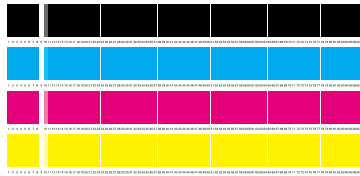

0726-86

1. If needed, clean the Rapid Release Guide; see page 62 for instructions.
2. If needed, clean the wiper blade on the maintenance drawer; see page 65 for instructions.
3. Inspect the printer's paper-exit area for debris. If needed, clean the exit rollers; see page 66 for instructions.
4. If needed, clean the printhead and print a test print.
 - a. Select **Eliminate Light Stripes** on the front panel (as described on page 43) or on the **Troubleshooting** tab in the driver.
 - b. Examine the test print.
 - c. If there is still a color band missing, repeat Steps a and b. Repeat up to three times in a row, if necessary.
5. If the problem persists:
 - a. Turn off the printer for at least 4 hours.
 - b. When you turn on the printer, print the **Diagnostic Pages** and, if necessary, select **Eliminate Light Stripes**.

Smudges or smears appear on the print



0726-85

- On the front panel, select **Remove Print Smears**. Repeat as needed.
 - a. With **Menus** highlighted, press the **OK** key.
 - b. Scroll to **Support Menu** by pressing the **Scroll Up** or **Scroll Down** key.
 - c. Press the **OK** key.
 - d. Scroll to **Improve Print Quality?**.
 - e. Press the **OK** key.
 - f. Scroll to **Remove Print Smears**.
 - g. Press the **OK** key.
- Be sure to use paper supported by the printer. For a list of recommended paper types, see page 14 or print the **Paper Tips Page** from the front panel's **Printable Pages Menu**.
- If needed, clean the wiper blade on the maintenance drawer; see page 65 for instructions.
- If ink or debris is visible on the exit rollers, clean the rollers; see page 66 for instructions.
- If ink or debris is visible on the paper-feed rollers, clean the rollers; see page 66 for instructions.

Images are too light or too dark

- Pull out the tray and check the position of the switch on the front-right side of the tray. Push it forward for paper (or labels) and backward for transparencies. After setting the switch correctly, slide the tray back in.

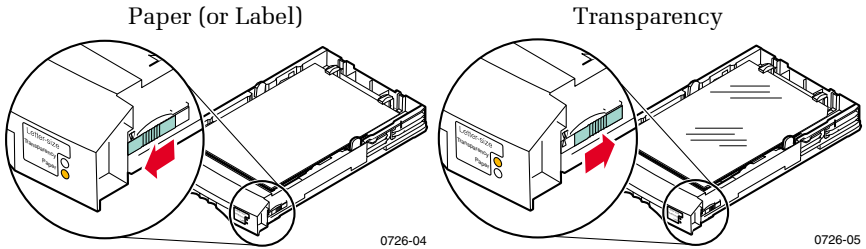

- Select another print quality mode in the printer driver, then print the job again; refer to page 11.
- Select another color correction in the printer driver, then print the job again; refer to page 12.

Paper Jams

Jam prevention tips

- Use **only** the recommended papers, transparencies, labels, and business cards. For more information, refer to page 14.
- Use clean, undamaged paper.
- Load paper from a newly opened package.
- Don't add paper above the tray's fill line.
- If paper is still jamming, flip the paper over in the paper tray.
- Clean the printer's rollers if they are visibly dirty.

For more information, print the **Help Guide** from the printer's front panel (as described on page 9) or visit the Xerox Customer Support website at

www.xerox.com/officeprinting/support

Clearing jams

When there is a paper jam, the printer's front panel displays a message about the jam location and information on how to clear the jam.

Paper jam – Open exit cover to clear

Caution

Do not use tools to remove jammed paper from the exit area. Using tools in this area could damage the printer's imaging surface.

Solution 1

If the paper has partially exited the printer at the exit slot:

1. Using both hands, remove the jammed paper. If it cannot be removed easily, refer to Solution 2.

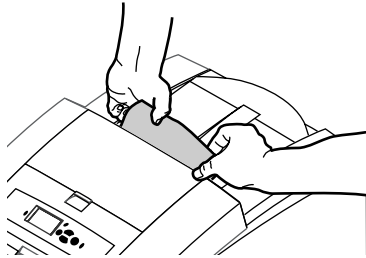

0726-16

2. Remove the entire sheet of paper; any pieces left in the printer may cause more jams.

Solution 2

If the paper has partially exited the printer but cannot be removed easily:

1. Open the exit cover.

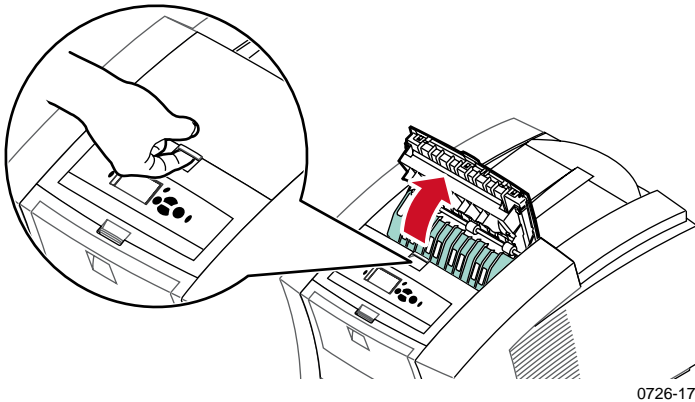

2. Using both hands, remove the jammed paper. If the paper is still caught inside the printer, skip to Solution 3 (Step 2).

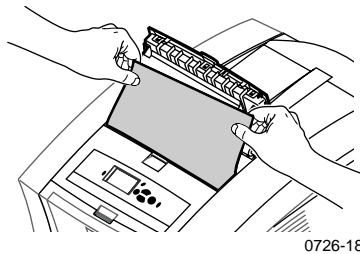

3. Remove the entire sheet of paper; any pieces left in the printer may cause more jams.
4. Close the exit cover.

Solution 3

If the paper is caught under the Rapid Release Guide:

1. Open the exit cover.
2. Lift the green paper guide.

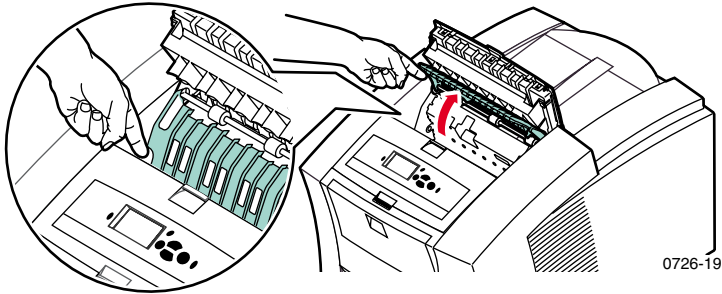

Caution

Handle the Rapid Release Guide carefully to avoid bending or damaging the clear plastic edge.

3. Lift up on the green tabs and remove the Rapid Release Guide. **Do not use any sharp objects in this area of the printer.**

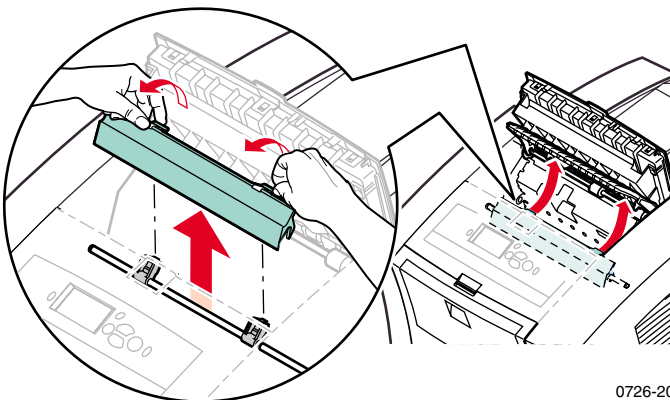

- Remove the jammed paper.

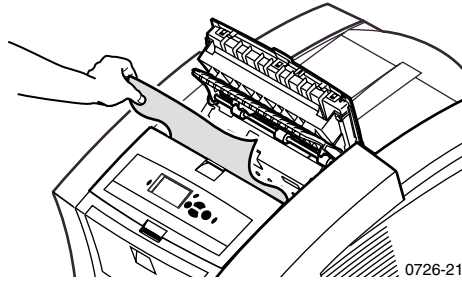

- Make sure the thin, white dust shield is lying on top of the metal shaft. Then, reinstall the Rapid Release Guide, pressing down on the green tabs to snap the guide into place.

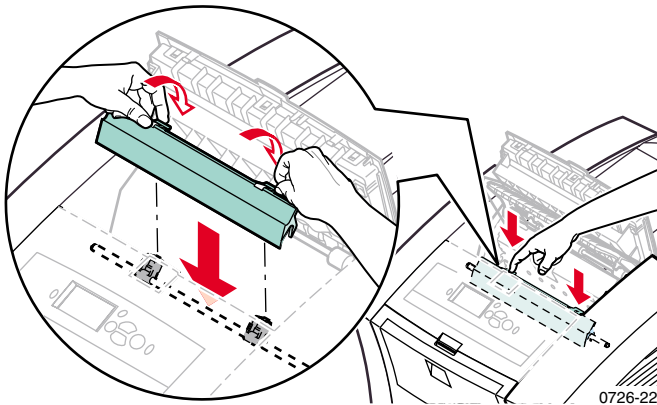

Note

Verify that the Rapid Release Guide is fully installed by gently tugging on it. If it isn't snapped into place, it may cause jams and print quality problems.

- Close the exit cover.

Paper jam - Open front cover to clear

1. Open the front cover.

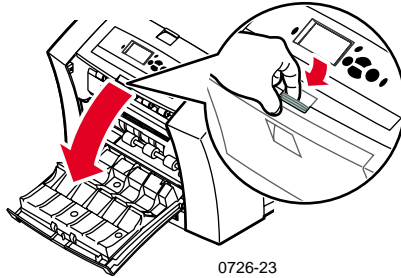

2. Using both hands, remove the jammed paper.
3. If there is any resistance to removing the jammed paper, turn the green thumbwheel to help feed the paper.

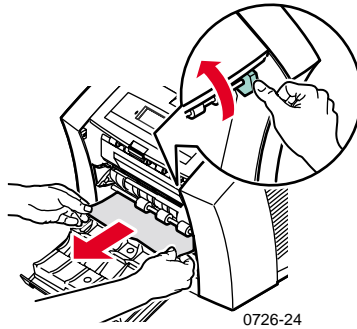

4. Remove the entire sheet of paper; any pieces of paper left in the printer may cause more jams.
5. Close the front cover.

Paper jam - Remove upper tray or paper tray to clear

1. Completely remove the upper tray or paper tray.
2. Using both hands, carefully remove the jammed paper.

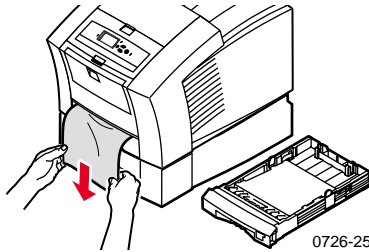

3. Re-insert the upper tray or paper tray.

Paper jam - Remove middle tray to clear

1. Completely remove the middle tray.
2. Using both hands, carefully remove the jammed paper.

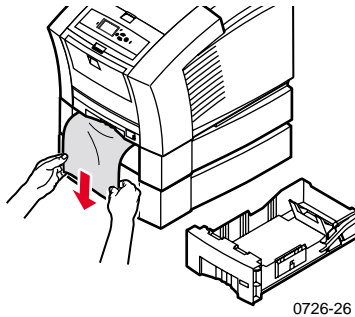

3. Re-insert the middle tray.

Paper jam - Remove lower tray to clear

1. Completely remove the lower tray.
2. Using both hands, carefully remove the jammed paper.

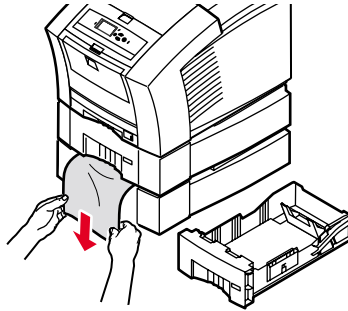

0726-27

3. Re-insert the lower tray.

Paper jam, incorrect size - Open exit cover to clear

The printer may be trying to print on the wrong size paper. Before clearing the jam, verify that the paper loaded in the source tray is the correct size and is within specifications. Refer to page 14 for information on supported paper sizes and types.

Caution

Do not use tools to remove jammed paper from the exit area. Using tools in this area could damage the printer's imaging surface.

Follow the steps that start on page 48 to remove the jam from the exit area.

Paper jam - Retry manual feed

1. Using both hands, remove the jammed paper, transparency, label, or business card sheet.

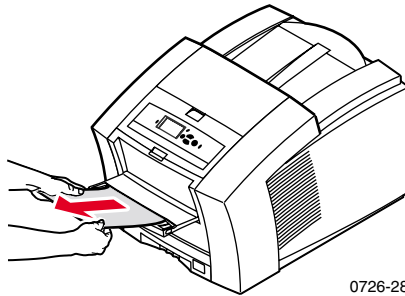

2. Verify that the paper (or other media) is the correct size and is within specifications; refer to page 14.
3. Verify that the manual-feed slot is fully extended by gently pushing it downward.
4. When prompted by the display message, reinsert only one sheet of paper or one envelope. Use both hands to guide the sheet until you feel the printer grab the sheet. Make sure that you insert the sheet or envelope properly, so it is along the left edge of the slot and it enters the printer straight and evenly. Be especially careful to properly line up envelopes and small-size papers.

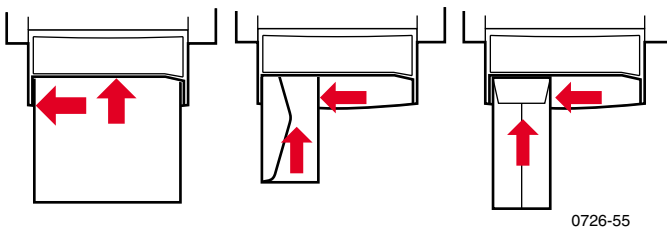

Maintenance and Cleaning

Adding ink

Refer to page 2 for information on Phaser 860 ColorStix II ink.

Caution

Use only **Phaser 860 ColorStix® II ink**; the use of other ink or ink designed for other Phaser® color printers may affect print quality and reliability. Xerox warranties and service contracts do not cover damage, malfunction, or degradation of performance caused by the use of non-Xerox supplies or consumables, or the use of Xerox supplies not specified for use with this printer.

Ink tips

- Keep ink in its packaging until you are ready to use it.
- To avoid ink jams, never insert broken ink sticks into the ink-loading bins.

Loading ink

You can load ink any time the printer is idle, or when the front panel displays the **Ink low** or **Ink out** message.

1. Open the top cover.

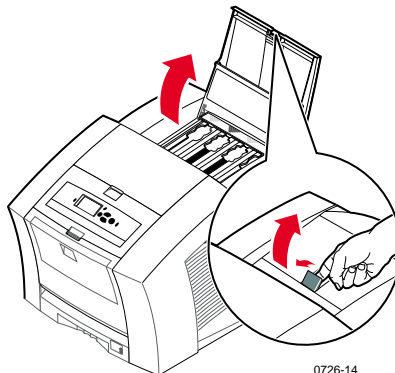

0726-14

2. Determine which ink-loading bin needs ink. A label above each bin indicates the color and color number of that bin.
3. Remove the ink stick from its packaging.

Note

Because the magenta, cyan, and black ink sticks are all dark, refer to its color number; this number corresponds to the bin for that the color. Yellow ink sticks may have a mottled appearance that doesn't affect print quality.

4. Place the ink stick into the opening of the appropriate ink-loading bin. **Do not force the ink stick into the ink-loading bin.**

Note

Each ink stick is uniquely shaped to fit into the correct ink-loading bin. Insert the ink stick's narrow end first.

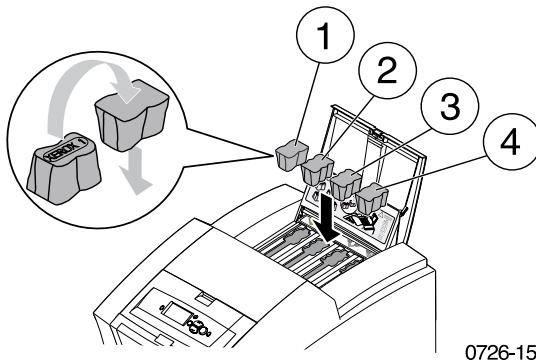

0726-15

5. Close the top cover.

The front panel may read **Warming Up** until the printer is ready for printing.

Emptying the waste tray

Empty the waste tray when the front panel displays a message stating that the waste tray is full.

Note

To minimize waste ink and optimize performance, leave the printer on all the time.

Caution

The printer's interior may be hot. Do not touch the hot surfaces!

1. Open the front cover.

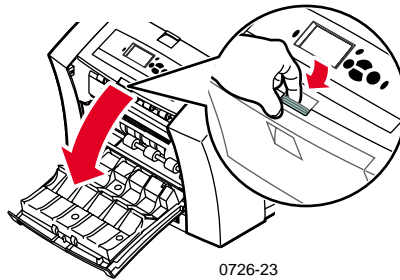

2. Pull out the maintenance drawer (labeled A), if it is not locked.

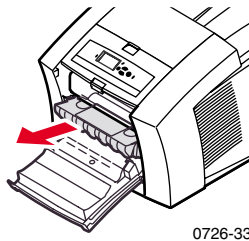

Note

The maintenance drawer is locked during the warm-up cycle whenever the printer is turned on and while the ink cools after the **Eliminate Light Stripes** troubleshooting routine. If the maintenance drawer is locked, close all covers and wait 15 minutes before repeating steps 1 and 2.

3. Lift the waste tray (labeled B) from the maintenance drawer. **The waste tray may be hot; handle it carefully!**

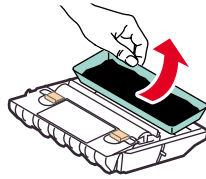

0726-49

4. Empty the waste tray by gently twisting the tray or tapping it on the sides of a waste container. Ink is non-toxic and can be discarded as normal office waste.



0726-56

5. Re-insert the waste tray in the maintenance drawer. Make sure the tray is seated flat in the drawer.

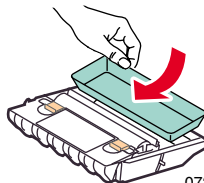

0726-34

6. Re-insert the maintenance drawer in the printer.
7. Close the front cover.

Note

Do not attempt to reuse the waste ink in the printer; it may damage the printer. This damage is not covered under the printer warranty.

Replacing the Maintenance Kit

The Maintenance Kit is a consumable that consists of the maintenance roller (labeled C1) that maintains the surface of the imaging drum and counter (labeled C2). The kit is located in the maintenance drawer (labeled A), which is accessed from the printer's front cover.

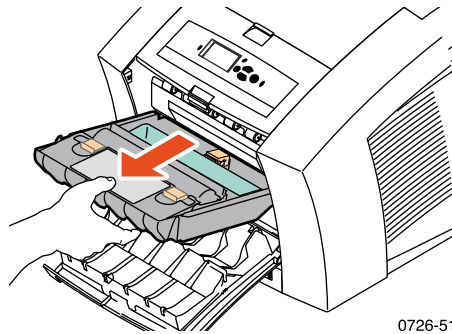

0726-51

Order a new Maintenance Kit when the front panel displays a message telling you that the Maintenance Kit is low. Replace it when the front panel displays a message telling you to replace the Maintenance Kit. Depending on your print volume and average ink coverage, order either the Standard Maintenance Kit or the Extended Maintenance Kit; refer to page 2 for more information.

Caution

The printer's interior may be hot. Do not touch the hot surfaces!

For replacement instructions, refer to the detailed, illustrated instructions included with the new Maintenance Kit.

Cleaning the Rapid Release Guide

1. Open the exit cover.

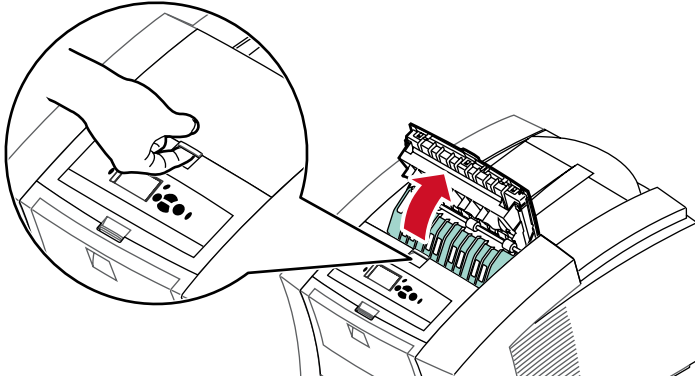

2. Tilt up the green paper guide.

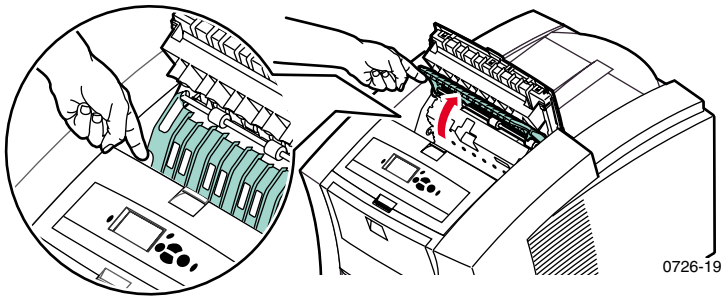

Caution

Handle the Rapid Release Guide carefully to avoid bending or damaging the clear plastic edge.

3. Remove the Rapid Release Guide by lifting up on the green tabs. **Do not use any sharp objects in this area of the printer.**

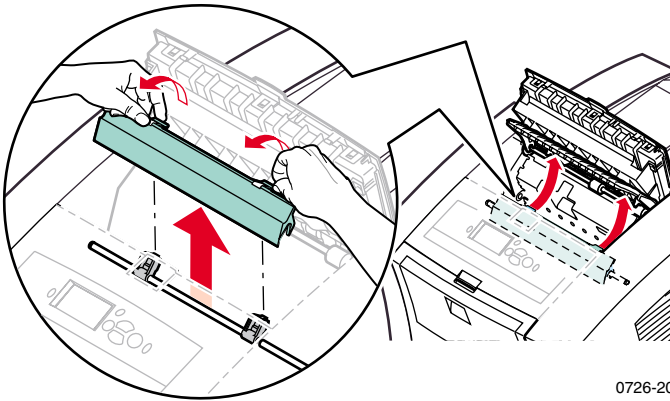

4. Gently clean the plastic Rapid Release Guide by wiping it with a pre-soaked alcohol cloth (using 90% isopropyl alcohol).

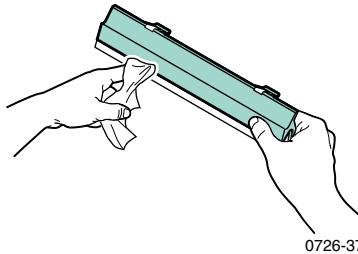

5. Make sure the thin, white dust shield is lying on top of the metal shaft. Then, reinstall the Rapid Release Guide, pressing down on the green tabs to snap the guide into place.

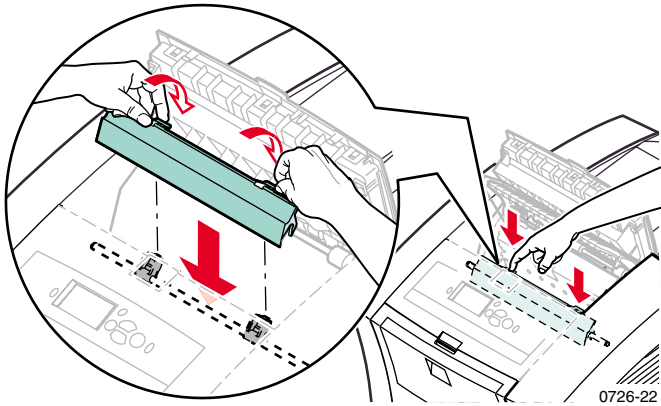

Note

Verify that the Rapid Release Guide is fully installed by gently tugging on it. If it isn't snapped into place, it may cause jams and print quality problems.

6. Close the exit cover.

Cleaning the maintenance drawer wiper blade

1. Open the front cover.

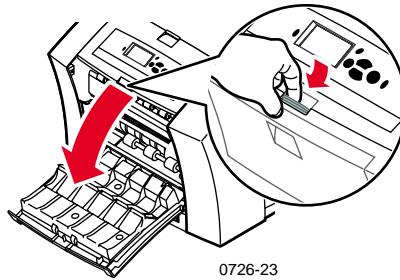

2. Remove the maintenance drawer (labeled A).

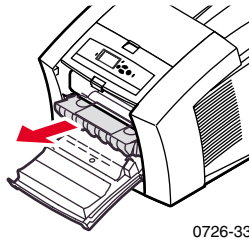

3. Use a lint-free cloth to clean the top and upper edges of the flexible plastic wiper blade located on the top of the maintenance drawer between the roller and waste tray.

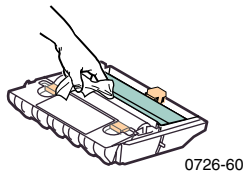

4. Replace the maintenance drawer and close the front cover.

Cleaning the exit rollers

1. Open the exit cover.
2. Clean the exit rollers using a pre-soaked alcohol cloth (using 90% isopropyl alcohol). To turn the rollers, turn the green thumbwheel.

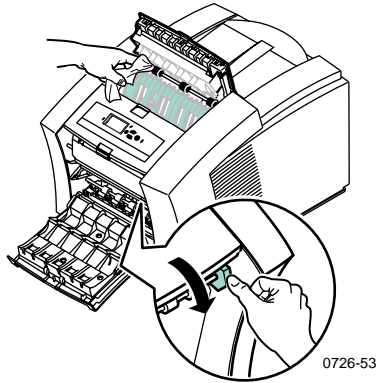

3. Close the exit cover.

Cleaning the paper-feed rollers

1. Open the front cover.

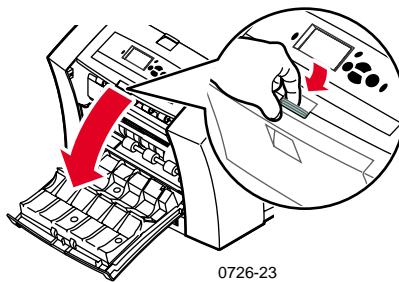

2. Remove the maintenance drawer (labeled A).

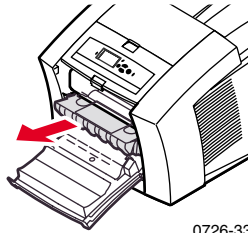

3. To clean the rollers in rows 1, 2, and 3, use a pre-soaked alcohol cloth (using 90% isopropyl alcohol). To turn the rollers in rows 1 and 3, turn the green thumbwheel.

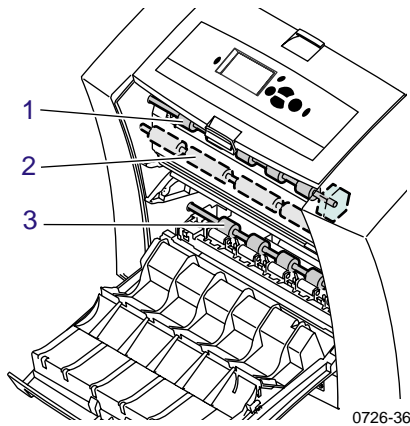

4. Clean any ink from the polished metal guide (located between rollers 1 and 2) using a pre-soaked alcohol cloth (using 90% isopropyl alcohol).
5. Replace the maintenance drawer and close the front cover.

Moving and Shipping the Printer

Moving the printer within the office

1. Close all of the printer's doors and covers.
2. Turn off the printer using the power switch located on the rear panel.

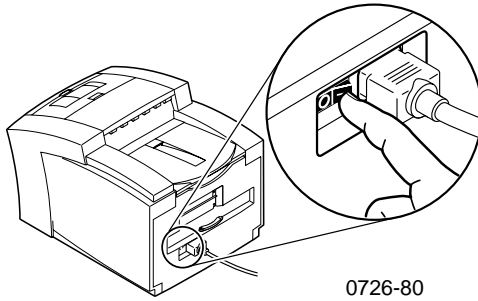

0726-80

3. Immediately use the front panel to scroll down to **Shut Down for Moving Printer** and press the **OK** key before the front panel goes blank; (you only have 4 seconds).
4. Wait for the printer to complete its cool-down period, during which the ink solidifies, making the printer safe to move. This takes at least 20 minutes with the fan running.

Note

If you did not select **Shut Down for Moving Printer**, wait at least 30 minutes before moving the printer to ensure the printer is safe to move.

5. After the ink has cooled, unplug the printer.
6. Remove the upper paper tray to provide a place for your hands when lifting the printer.

Note

Always move the printer separately from its High-Capacity Paper Tray Assembly.

7. Have two people move the printer to the new location.

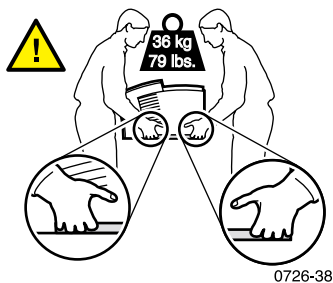

Shipping the printer

To prepare the printer for shipment, complete steps 1 through 5 starting on page 68, then:

1. Open the front cover.

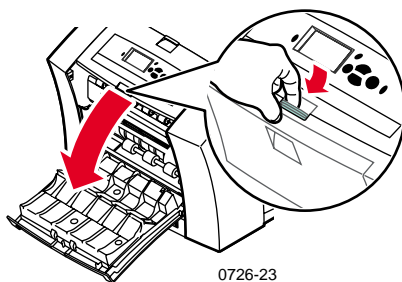

2. Remove the Maintenance Drawer (labeled A) and place it in a plastic bag for storage.

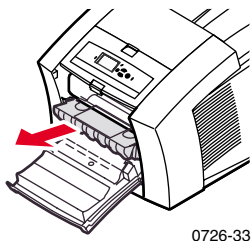

Caution

Always remove the Maintenance Drawer before shipping the printer. Shipping the printer with the Maintenance Drawer installed will damage the printer.

3. Close the front cover.
4. Place the printer in its original shipping carton and use the original packing material to pack it. If you don't have the original carton or packing material, order replacement packaging from Xerox (part number 065-0594-00).
5. To avoid shipping damage, refer to the instructions on the printer's CD-ROM or the following Xerox web site:
www.xerox.com/officeprinting/support

Getting Help

Refer to the following resources for information about your printer.

Printer CD-ROM

The printer's auto-running CD-ROM guides you to the various resources available for installing and learning more about your Phaser color printer.

- Read Me release notes
- Printer drivers
- Driver installers (for Mac and Windows)
- *Phaser 860 Color Printer User Guide* (this manual)
- *Advanced Features and Troubleshooting Manual*
- *Setup Guide* poster
- How-to videos
- Networking information
- Cleaning instructions
- Consumables instructions
- Repacking instructions
- Adobe Acrobat Reader (for reading the PDF files)
- Adobe Type Manager (ATM)

Advanced Network Management Tools CD-ROM

This CD-ROM contains network management tools, including CentreWare DP, Unix tools, and the Font Downloader application.

Printer's front panel and internal pages

You can press the **Information** key at any time to get additional information about the message displayed on the front panel.

Use the **Printable Pages** menu to print internal pages that give information about the printer configuration, supplies information, paper tips, etc. Refer to page 9 for instructions.

Windows driver and driver help system

If you are using Windows 95, Windows 98, Windows 2000, or Windows NT, install the driver from the Printer CD-ROM and access the printer driver to:

- Link to relevant web sites from the **Troubleshooting** tab.
- View information about the printer features on the driver tabs by clicking the **Help** button on the tab.
- View troubleshooting information by clicking a **Help** button, then selecting the **Troubleshooting Guide**.

To access the Phaser 860 printer driver:

1. Click **Start**, select **Settings**, then click **Printers**.
2. In the **Printers** folder, right-click the icon for your Phaser 860 printer.
3. From the popup menu, select **Properties**.

Xerox web sites

www.xerox.com/officeprinting/

- Product and supplies information
- Downloading printer drivers
- Finding your local reseller
- Online documentation

www.xerox.com/officeprinting/infoSMART/

The infoSMART™ knowledge base is the same troubleshooting knowledge base used by Xerox Customer Support staff to provide the latest technical information on:

- Application issues
- Networking issues
- Printer errors
- Print-quality issues
- Troubleshooting

www.colorconnection.xerox.com/

This site helps you get the most from your color printer:

- Interactive tutorials, color printing templates, and helpful tips for using your printer and favorite software applications.
- Easy access to online technical support.
- Customized features to meet your individual needs.

CentreWare IS

www.xerox.com/officeprinting/products/860/sprt.html

then click the CentreWare link

- View manuals describing how to control printer settings and view your printer's status using any web browser
- Link to information about CentreWare IS
- Requires network connection via TCP/IP

Other online services

Subscribe to email update notices: www.colorconnection.xerox.com/

Technical Support: www.xerox.com/officeprinting/support

To find a local reseller

See www.xerox.com/officeprinting/contacts for the most updated information.

U. S.
1-800-835-6100

Canada
1-877-662-9338

**Outside U.S. and
Canada**
Contact your local
Xerox office for a list of
local resellers

Customer support centers

See www.xerox.com/officeprinting/support for the most updated contact information.

U. S. and Canada 1-800-835-6100	Denmark 7010 7288	Norway 8150 0308
Argentina 54-114-378-5444	Ecuador +593 (2) 503 444	Peru (511) 265 7328
Australia 1-800-811-177	Finland 0800 11 8388	Puerto Rico 1-800-835-6100
Austria 017956 7083	France 0825 393 490	Singapore 1-800-356-5565
Belgium-Dutch 070 222 047	Germany 01 805 004392	ASEAN +65 251 3006
Belgium-French 070 222 045	Ireland 1890 925 050	Spain 902 160 236
Bolivia +(5913)472662	Italy 199 112 088	Sweden 0771 1788 08
Brazil 0800-21-8400	Japan +81 03 3448 3040	Switzerland 0845 845 107
Caribbean (305)716-3925 (Miami)	Korea 82(2) 528 4661	Taiwan 2 2757 1567
Central America (305)716-3925 (Miami)	Luxembourg 34 2080 8035	Thailand 2 645 3600
Chile 800-200-600	Mexico 50 (3) 615 4748	UK 0870 241 3459
Colombia 571-636-3011	Netherlands 0900 202 1154	Venezuela +58(2)265-2625
	New Zealand 0 800 449 177	

Specifications

Material Safety Data Sheet for ColorStix® II Ink

SECTION 1- PRODUCT IDENTIFICATION

Trade Names	Xerox Part No.
ColorStix® II Ink, Black	016-1902-00, 016-1902-50
ColorStix® II Ink, Cyan	016-1903-00, 016-1906-00
ColorStix® II Ink, Magenta	016-1904-00, 016-1907-00
ColorStix® II Ink, Yellow	016-1905-00, 016-1908-00
Four color "rainbow" pack	016-1909-00
Supplies Start-up Kit	860 SS 00, 860 SS 01

Product Use: XEROX Phaser® 860 color printers

SECTION 2 - INFORMATION ON INGREDIENTS

Xerox Phaser® 860 ColorStix® II are a proprietary blend of polyethylene and fatty amide waxes, resins, and dyes. The specific identity of ingredients is withheld as a trade secret.

ColorStix® II solid inks are considered articles under Hazard Communication regulations. This Material Safety Data Sheet is provided as a customer service.

SECTION 3 - HAZARDS IDENTIFICATION

ROUTES OF EXPOSURE: Skin

POTENTIAL HEALTH EFFECTS

Immediate Effects: None are known, when used as intended in Phaser® 860 Color Printers. See Section 11 for toxicology test information.

Chronic Effects: None are known

SIGNS AND SYMPTOMS OF EXPOSURE: None are known.

MEDICAL CONDITIONS AGGRAVATED BY EXPOSURE: None are known.

SECTION 4 - FIRST AID MEASURES

EYES: Contact unlikely. If particles get into eyes, flush thoroughly with water.

INGESTION: Not applicable

INHALATION: Not applicable

SKIN: Wash skin thoroughly with soap and water

SECTION 5 - FIRE FIGHTING MEASURES

FLASH POINT: > 221 degrees C (>429 degrees F), Pensky-Martens closed tester

FIRE & EXPLOSION HAZARDS: These inks will burn. During a fire, irritating and toxic gases may be generated by thermal decomposition or combustion.

EXTINGUISHING MEDIA: All extinguishing agents classified as B and C are effective, including dry powder(s), carbon dioxide, and halon.

FIRE FIGHTING INSTRUCTIONS: Avoid inhalation of smoke. As in any fire, wear self-contained breathing apparatus, pressure demand, MSHA/NIOSH approved, and full protective gear.

SECTION 6 - ACCIDENTAL RELEASE MEASURES

SPILL OR LEAK: Not applicable

SECTION 7 - HANDLING AND STORAGE

HANDLING: No special precautions, when used as intended.

STORAGE: Avoid high temperatures. Keep ink below 60 degrees C (140 degrees F)

SECTION 8 - EXPOSURE CONTROL - PERSONAL PROTECTION

EXPOSURE GUIDELINES: None established.

ENGINEERING CONTROLS/PERSONAL PROTECTION: No special personal protection indicated, when used as intended.

SECTION 9 - PHYSICAL AND CHEMICAL PROPERTIES

APPEARANCE/ODOR: Waxy solid. Black, blue, red, or yellow in color/Faint odor

SOLUBILITY IN WATER: Insoluble

MELTING POINT: Approximately 100 degrees C (212 degrees F)

SPECIFIC GRAVITY (Water = 1): Approximately 1, @ 25 degrees C (77 degrees F)

SECTION 10 - STABILITY AND REACTIVITY

STABILITY: Stable.

CONDITIONS TO AVOID: Temperatures above 200 degrees C (392 degrees F)

INCOMPATIBILITY WITH OTHER MATERIALS: None

HAZARDOUS POLYMERIZATION: Will not occur

HAZARDOUS DECOMPOSITION PRODUCTS: Material may decompose into toxic byproducts when heated to temperatures above 200 degrees C (392 degrees F).

SECTION 11 - TOXICOLOGICAL INFORMATION

TOXICITY: Oral LD₅₀ >5 g/kg (rats); practically non-toxic

SKIN IRRITATION: Primary Dermal Irritation Index = 0.0; not skin irritants.

CARCINOGENICITY: Components not listed by IARC, NTP, or OSHA.

SECTION 12 - ECOLOGICAL INFORMATION

No known impact

SECTION 13 - DISPOSAL CONSIDERATIONS

This product is not a hazardous waste as specified in 40CFR261. TCLP below hazardous waste levels set by EPA. State and local waste disposal requirements, however, may be more restrictive. Manage and dispose of waste in accordance with all federal, state, and local regulations.

SECTION 14 - TRANSPORT INFORMATION

DOT: Not regulated.

SECTION 15 - REGULATORY INFORMATION

TSCA: This material has been manufactured in compliance with the EPA Toxic Substances Control Act (TSCA).

RCRA (Resource Conservation and Recovery Act): Not a hazardous waste as specified in 40CFR261. TCLP below hazardous waste levels set by EPA.

SECTION 16 - OTHER INFORMATION

Original preparation date: 10/5/00

Xerox Corporation
Office Printing Business
Environmental, Health & Safety
P.O. Box 1000
Mail Stop 60-512
Wilsonville, Oregon 97070
Safety Information: 800-828-6571
Health Information: 716-422-2177

Material Safety Data Sheet for Silicone Intermediate Transfer Layer Fluid

SECTION 1- PRODUCT IDENTIFICATION

Trade Name: Xerox Silicone Intermediate Transfer Layer Fluid, impregnated into printer's maintenance roller.

Xerox part number 016-1933-00 (replacement standard maintenance kit)

Xerox part number 016-1932-00 (replacement extended maintenance kit)

Product Use: Xerox Phaser[®] 860 color printers

SECTION 2 - INFORMATION ON INGREDIENTS

Xerox Silicone Intermediate Transfer Layer Fluid is a proprietary blend of silicone oils. Specific identities of components, and their percentage composition, are withheld as a trade secret.

SECTION 3 - HAZARDS IDENTIFICATION

ROUTES OF EXPOSURE: Skin, eyes

POTENTIAL HEALTH EFFECTS: Health effects from this product are expected to be negligible, when product is used as intended in Xerox Phaser® 860 Color Printers.

Immediate Effects:

Inhalation: Not an expected route of entry

Skin: May cause mild irritation.

Eyes: May cause mild irritation.

Ingestion: Not an expected route of exposure.

Chronic Effects: None known or expected.

SIGNS AND SYMPTOMS OF EXPOSURE

Mild skin or eye irritation.

MEDICAL CONDITIONS AGGRAVATED BY EXPOSURE

None known

SECTION 4 - FIRST AID MEASURES

INHALATION: Not a route of exposure for this product.

EYES: Flush thoroughly with water. Seek medical attention if symptoms occur.

SKIN: Wash thoroughly with soap and water. Seek medical attention if symptoms of irritation occur.

INGESTION: Not a route of exposure for this product.

SECTION 5 - FIRE FIGHTING MEASURES

FLASH POINT: Flash point of fluid is 226 degrees C, Pensky-Martens closed-cup tester.

EXTINGUISHING MEDIA: All extinguishing agents classified as B and C are effective, including dry powder(s), CO₂, and halon.

FIRE FIGHTING INSTRUCTIONS: As for any fire, wear self-contained breathing apparatus, pressure demand, MSHA/NIOSH approved, and protective gear.

FIRE AND EXPLOSION HAZARDS. During a fire, irritating and toxic substances may be generated by thermal decomposition or combustion. No unusual fire hazards expected.

SECTION 6 - ACCIDENTAL RELEASE MEASURES

SPILL OR LEAK: Fluid is impregnated into maintenance roller. Small amounts (ie., drops) may result from normal handling. Absorb and place in an appropriate disposal container. Clean spills thoroughly because residue can be slippery.

SECTION 7 - HANDLING AND STORAGE

HANDLING: Wash hands with soap and water after contact. Clean spills per SECTION 6.

STORAGE: No special requirements.

SECTION 8 - EXPOSURE CONTROL - PERSONAL PROTECTION

No special protection indicated when used as intended.

SECTION 9 - PHYSICAL AND CHEMICAL PROPERTIES

APPEARANCE: Clear liquid impregnated into maintenance roller.

ODOR: Mild

SOLUBILITY IN WATER: No data

SPECIFIC GRAVITY: Specific gravity of fluid is 0.97 (water=1)

SECTION 10 - STABILITY AND REACTIVITY

STABILITY: Stable.

INCOMPATIBILITY WITH OTHER MATERIALS: Strong oxidizing agents

HAZARDOUS DECOMPOSITION PRODUCTS: At elevated temperatures, formaldehyde may be generated.

HAZARDOUS POLYMERIZATION: Will not occur.

SECTION 11 - TOXICOLOGICAL INFORMATION

No toxicology data on mixture

SECTION 12 - ECOLOGICAL INFORMATION

Not available.

SECTION 13 - DISPOSAL CONSIDERATIONS

Fluid is not listed as RCRA hazardous waste. Dispose of in accordance with federal, state, and local regulations.

SECTION 14 - TRANSPORT INFORMATION

DOT: Not regulated.

SECTION 15 - REGULATORY INFORMATION

The following information pertains to the ingredients of Xerox Silicone Intermediate Transfer Layer Fluid:

TSCA (Toxic Substances Control Act): Listed in the TSCA inventory as verified by our suppliers.

RCRA (Resource Conservation and Recovery Act): Not listed as RCRA hazardous wastes.

The ingredients of this fluid are not listed as carcinogenic by OSHA, IARC or NTP.

SECTION 16 - OTHER INFORMATION

Original preparation date:10/3/00

Xerox Corporation
Office Printing Business
Environmental, Health & Safety
P.O. Box 1000
Mail Stop 60-512
Wilsonville, Oregon 97070
Safety Information: 800-828-6571
Health Information: 716-422-2177

Material Safety Data Sheet for CleanTex® Alcopad

SECTION 1 – PRODUCT IDENTIFICATION

Trade name: Xerox Part Number:
Alcopad 016-1845-00

Product identification numbers: 806B, 806C, 806H, 806T, 806Z, 806
Chemical name and synonyms: Isopropyl Alcohol
Chemical formula: $\text{CH}_2\text{CH}(\text{OH})\text{CH}_3$
Emergency telephone numbers: CHEMTREC (Transportation): 1-800-424-9300
Product Use: Xerox Phaser® 860 Color Printer

SECTION 2 – INFORMATION ON INGREDIENTS

Component	CAS#	%	OSHA PEL (ppm)	ACGIL TLV (ppm)
Isopropyl alcohol	67-63-0	91.0	400	400
Deionized water	7732-18-5	9.0	NA	NA

SECTION 3 – HAZARDS IDENTIFICATION

Product is distributed as a single-use, presaturated pad, in which all the liquid is absorbed by the applicator. Isopropyl alcohol is a flammable liquid. Eye contact will cause local irritation and burning sensations with possible injury if not removed promptly. Repeated or prolonged contact with skin may produce irritation and cause dermatitis. Exposure above TLV may cause irritation of respiratory tract and eyes along with headaches, dizziness and CNS effects. May be harmful if swallowed.

Carcinogenicity (OSHA/NTP/IARC/ACGIH): Not Listed.
Medical Conditions Aggravated by Exposure: Not Listed.

SECTION 4 – FIRST AID MEASURES

EYE CONTACT: Flush with water for 15 minutes, including under eyelids.
Get Medical help.

SKIN CONTACT: Flush with water.

INHALATION: Remove to fresh air. Keep at rest. Restore and/or support breathing as needed. Get prompt Medical attention.

INGESTION: In the unlikely event of ingestion of a wiper, first aid measures should focus on removal of the object and preventing choking. Once removed, keep affected person at rest. Call physician immediately.

SECTION 5 – FIRE-FIGHTING MEASURES

FLASH POINT (TCC): 56 degrees F

FLAMMABLE LIMITS (% BY VOLUME): LEL: NA UEL: NA

AUTOIGNITION TEMPERATURE degrees F (degrees C): NA

EXTINGUISHING MEDIA: Isopropyl-alcohol fires may be extinguished using carbon dioxide, dry chemical or alcohol foam. Water may be used to cool containers exposed to the fire.

UNUSUAL FIRE OR EXPLOSION HAZARDS: Isopropyl alcohol may release vapors which may ignite at or above flash point.

NFPA RATING: HEALTH (1)

FLAMMABILITY (3)

REACTIVITY (0)

Formulation is classified as an OSHA Class IB Flammable Liquid

NA = Not Available

SECTION 6 – ACCIDENTAL RELEASE MEASURES

Since the isopropyl-alcohol solution is completely absorbed by the applicator and the amount of isopropyl alcohol per applicator is small, the chance of a significant spill occurring is small. In the event however, that a significant amount of liquid is released, ventilate the area, especially low areas where vapors may collect, and remove all sources of ignition. Cleanup personnel need protection against liquid contact and vapor inhalation.

SECTION 7 – HANDLING AND STORAGE

Store in a clean, cool, ventilated area away from sources of ignition and oxidizing agents. Handle and store in a manner suitable for an OSHA class IB Flammable Liquid. Electrical services must meet applicable codes. Use non-sparking tools.

SECTION 8 – EXPOSURE CONTROL – PERSONAL PROTECTION

Provide ventilation to maintain TLV. Use non-sparking tools. Avoid inhalation of vapors, contact with eyes and repeated or prolonged contact with skin. Do not take internally.

SECTION 9 – PHYSICAL AND CHEMICAL PROPERTIES

BOILING POINT (80 degrees C) (180 degrees F)

% VOLATILE BY VOLUME @ 25 degrees C: 100

VAPOR PRESSURE (mmHg @ 25 degrees C): 33

EVAPORATION RATE (BUTYL ACETATE-1) >1

VAPOR DENSITY (AIR = 1): <1

FORM: liquid

% SOLUBLE IN WATER @ 25 degrees C: 100

ODOR: alcohol

SPECIFIC GRAVITY (G/CC @ 25 degrees C): 0.79

APPEARANCE OF LIQUID: clear

SECTION 10 – STABILITY AND REACTIVITY

STABILITY: Stable

HAZARDOUS POLYMERIZATION: Will not occur.

INCOMPATIBILITIES / CONDITIONS TO AVOID: Caustics, amines, alkanolamines, aldehydes, ammonia, strong oxidizing agents and chlorinated compounds.

HAZARDOUS DECOMPOSITION PRODUCTS: Carbon monoxide

SECTION 11 – TOXICOLOGICAL INFORMATION

Not Available

SECTION 12 – ECOLOGICAL INFORMATION

Not Available.

SECTION 13 – DISPOSAL CONSIDERATIONS

Follow Federal, State and Local Regulations.

SECTION 14 – TRANSPORT INFORMATION

DOT CLASSIFICATION: Not Regulated.

Proper Shipping Name:

Hazard Class:

UN Number:

Packing Group:

Hazard Labeling:

IATA / ICAO CLASSIFICATION: Not Regulated.

Proper Shipping Name:

Hazard Class:

UN Number:

Packing Group:

Hazard Labeling:

IMDG CLASSIFICATION: Not Regulated.

Proper Shipping Name:

Hazard Class

IMDG Page #

Packing Group:

Flash Point (degrees C):

Marine Pollutant:

SECTION 15 – REGULATORY INFORMATION

SARA TITLE III REPORTING:

Toxic Chemical (Section 313): Not Listed.

Extremely Hazardous Substance: Not Listed.

Section 302, 304, 311, 312)

Hazard Class:

Chronic Health: Yes

Acute Health: Yes

Fire Hazard: Yes
Pressure Hazard: No
Reactivity Hazard: No

TSCA INVENTORY STATUS: All components listed are on the TSCA inventory.

SECTION 16 – OTHER INFORMATION

The information provided herein is compiled from internal reports and data from professional publications. It is furnished without warranty of any kind, expressed or implied. It is intended solely to assist in evaluating suitability and proper use of the material and in implementing safety precautions and procedures. Employees should use this information as a supplement to other information gathered by them and must make independent determination of suitability and completeness of information from all sources to assure proper use of these materials. All information used must be determined by the user to be in accordance with applicable federal, state and local laws and regulations.

Prepared by:

CleanTex Products
33 Murray Hill Drive
Nanuet, NY 10954
June 1997

Index

Numerics

2-sided jobs 39

A

accessories

 ordering information 1

adding ink 56

alcohol wipes

 material safety data sheet 80

Automatic color correction 12

B

Back key 8

binding preference 39

Black and White color correction 12

business cards 14

 part numbers 7

 printing on 30

 storing 30

C

Cancel Print key 8

cart for printer

 part number 3

carton for shipping 70

caution symbol xiv

CD-ROM for printer 71

CentreWare IS 73

cleaning 56

 exit rollers 66

 paper-feed rollers 66

 Rapid Release Guide 62

 wiper blade in maintenance drawer 65

cleaning kit

 part number 2

CleanTex Alcopad

 material safety data sheet 80

- clearing jam
 - in manual-feed slot 55
 - incorrect size 54
 - open exit cover to clear 48
 - open front cover to clear 52
 - remove middle tray to clear 53
 - remove upper tray to clear 53
 - remove lower tray to clear 54
- clearing jams 47
- color connection 73
- color corrections 12
- colors missing 42
- colors of ink sticks 57
- ColorStix II ink
 - loading 56
 - material safety data sheet 75
 - part numbers 2
- Commercial Press color correction 12
- consumables
 - adding ink 56
 - Maintenance Kit 61
 - warranty viii
- counter in maintenance kit 61
- cover paper
 - part numbers 6

D

- danger symbol xiv
- dark prints 46
- diagnostic pages 42
- DIC color correction 12
- DP Feature Set
 - part number 4
- drivers
 - location 71
 - uses 72
- duplex printing 39

E

- electrical safety x
- elevation xi
- eliminate light stripes 43
- Enhanced print quality mode 11

- envelopes
 - creating in application 34
 - guidelines 34
 - print area 16
 - printing from Macintosh applications 37
 - printing from Microsoft Word for Windows 35
 - printing from Microsoft Word on a Macintosh 36
 - printing on 34
 - sizes 16
 - storing 34
 - using the manual-feed slot 26
- error conditions 9
- Euroscale Press color correction 12
- exit cover
 - clearing jam 48
- exit rollers
 - cleaning 66

F

- Fast Color print quality mode 11
- Feature Set, DP
 - part number 4
- features of the printer 10
- fill lines
 - high-capacity paper tray 20
 - high-capacity transparency/label tray 22
 - legal paper tray 24
 - standard paper/transparency tray 18
- front cover
 - clearing jam 52
- front panel 8
 - information key 71
 - keys 8
- FujiProof color correction 12

G

- glossy paper
 - part numbers 5

H

- hard drive
 - part number 4
- Help button in printer driver 72
- help information 71
- High Resolution/Photo print quality mode 11

- high-capacity paper tray
 - loading 19
 - part number 3
- high-capacity transparency/label tray
 - loading 22
 - part numbers 3
- high-resolution photo paper
 - part numbers 6
 - printing on 29
- hot surfaces symbols xiv

I

- images too light or too dark 46
- incorrect size of paper causing jam 54
- information key 8, 71
- information pages 9, 71
- infoSMART 72
- ink
 - loading 56
- ink saving print quality mode 11
- internal hard drive
 - part number 4

J

- jams 47

K

- keys
 - front panel 8

L

- labels 14
 - in high-capacity transparency/label tray 22
 - in standard paper/transparency tray 17
 - part numbers 6
 - printing on 30
 - storing 30
 - using the manual-feed slot 26
- legal paper tray
 - loading 23
 - part number 3
- letterhead
 - printing on 38
- lifting the printer xii, 69
- light prints 46

- loading
 - high-capacity paper tray 19
 - high-capacity transparency/label tray 22
 - legal paper tray 23
 - standard paper/transparency tray 17
- low supplies 9
- lower tray
 - clearing jam 54

M

- maintenance 56
- Maintenance Drawer
 - part number 2
- maintenance drawer wiper blade
 - cleaning 65
- Maintenance Kit
 - life 1
 - part numbers 1
 - replacing 61
- maintenance safety xi
- manual-feed slot 26
 - jam 55
- manuals 71
- margins
 - envelopes 16
 - paper 15
- material safety data sheet
 - CleanTex Alcopad 80
 - ColorStix II ink 75
 - silicone intermediate transfer layer fluid 77
- media 13
- media jams 47
- media types 14
- memory
 - part numbers 4
- menu map 9
- middle tray
 - clearing jam 53
- modes
 - print quality 11
- moving the printer 68

N

- network card
 - part number 5
- None color correction 12
- notch in transparencies 32

O

- OK key 8
- orientation 39
- output tray extension 25
 - part number 2

P

- paper 13
 - in high-capacity paper tray 19
 - in standard paper/transparency tray 17
 - margins 15
 - part numbers 5
 - print area 15
 - sizes 14, 15
 - storing 13
 - using the manual-feed slot 26
- paper guide 62
- paper jams 47
- paper trays
 - loading 17
 - part numbers 3
- paper types 14
- paper weights 14
- paper-feed rollers
 - cleaning 66
- photo paper
 - printing on 29
- photographic print quality mode 11
- power x
- power switch 68
- preventing jams 47
- print area 15
 - envelopes 16
- print quality 42
- print quality modes 11
- print speed 11

- printer
 - DP feature set 4
 - front panel 8
 - print speed 11
 - quality modes 11
- printer CD-ROM contents 71
- printer drivers
 - location 71
 - uses 72
- printer station
 - part number 3
- printer warranty vii
- printing
 - two-sided jobs 39
- protective ground symbol xiv

Q

- quality modes 11
- quality of prints 42

R

- Rapid Release Guide
 - cleaning 62
 - part number 2
- remove ink smears 45
- repacking the printer 70
- resellers 73
- roller in maintenance kit 61
- rollers
 - cleaning exit rollers 66
 - cleaning paper-feed rollers 66

S

- safety x
- safety symbols xiv
- scroll keys 8
- shipping the printer 69
- silicone intermediate transfer layer fluid
 - material safety data sheet 77
- sizes of paper 14
- smudges on prints 45
- SNAP Press color correction 12
- space around printer xi
- special media 29
- speed of printing 11
- sRGB Display color correction 12

- standard paper/transparency tray
 - loading 17
 - part numbers 3
- Standard print quality mode 11
- storing
 - envelopes 34
 - labels and business cards 30
 - paper 13
- supplies
 - ordering information 1
- SWOP Press color correction 12
- symbols on printer xiv

T

- TekColor color corrections 12
- temperature range xi
- Toyo color correction 12
- transparencies
 - in high-capacity transparency/label tray 22
 - in standard paper/transparency tray 17
 - part numbers 6
 - print quality modes 11
 - printing on 32
 - sizes 15
 - using the manual-feed slot 26
- transparency trays
 - part numbers 3
- tray switch 18, 23
- trays
 - loading 17
 - part numbers 3
- two-sided jobs 39

U

- upper tray
 - clearing jam 53
- user safety x

V

- videos 71
- Vivid Color color correction 12

W

- warranty
 - consumables viii
 - printer vii

waste tray
 emptying 58
 part number 2
web sites 72
weight of printer xii
weights of paper 14
wiper blade
 cleaning 65

X

Xerox web sites 72

Tektronix

COLOR PRINTERS BY

XEROX

Free Manuals Download Website

<http://myh66.com>

<http://usermanuals.us>

<http://www.somanuals.com>

<http://www.4manuals.cc>

<http://www.manual-lib.com>

<http://www.404manual.com>

<http://www.luxmanual.com>

<http://aubethermostatmanual.com>

Golf course search by state

<http://golfingnear.com>

Email search by domain

<http://emailbydomain.com>

Auto manuals search

<http://auto.somanuals.com>

TV manuals search

<http://tv.somanuals.com>