

# *MAY200*

*User Guide*

701P36011

October 2000

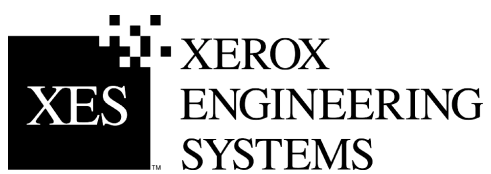

**NOTICE** While every care has been taken in the preparation of this guide, no liability will be accepted by Xerox Corporation arising out of any inaccuracies or omissions.

© 2000 XEROX CORPORATION. All rights reserved.

Printed in the United States of America

XEROX®, XES, AccXES, The Document Company, and the identifying product names and numbers herein are trademarks of XEROX CORPORATION.

All terms mentioned in this document that are known to be trademarks or service marks have been appropriately capitalized; Bic Briteliner.

Prepared by:  
Xerox Corporation  
Global Knowledge & Language Services  
800 Phillips Road  
Webster, New York 14580-9791

---

## Introduction

---

The **introduction** provides an overview of the MAX 200 and its optional accessories and features. You will also find information on how to use this guide, and the location of information you will need to operate, maintain, and service the MAX 200.

---

## Welcome to the MAX 200

---

Congratulations on acquiring your new MAX 200. Xerox Engineering Systems looks forward to supporting you and helping you increase your organizational productivity.

The MAX 200 is a high speed, highlight color production solution for centralized operations. It is a large-format digital copier for high-volume production producing 9.2 E-size, 17 D-size, 22 C-size, 29 B-size, and 37 A-size prints per minute, with concurrent scanning and printing operations.

- |   |  |
|---|--|
| <b>Speed and productivity</b>   | Makes copies or scans at 8 IPS (200 mm/sec).   |
| <b>Large media supply</b>   | Six media supply sources – 4 x 500 feet or 600 feet rolls, 1000 cut sheet tray for 8.5 x11 inch to 12 x 18 inch sizes, and the manual feed tray.   |
| <b>Image quality</b>  | Has an excellent 400-dpi-image quality for fine lines, solid areas, and halftones with pictures, and a true photo mode for superb results. The MAX 200 also has 256 levels of grayscale scanning. This gives the ability to reproduce from difficult legacy documents, like bluelines, sepias, or dark and low contrast originals. |
| <b>Highlight color</b>  | The MAX 200 provides single pass black plus red, with no loss of speed. The highlight feature enables editing, identifying changes, clear date stamps, labels, watermarks, and other applications.   |
| <b>Scan-to-file memory</b>  | The MAX 200 is equipped with 160 MB of scan-to-file memory. Additional memory can be purchased.  |
| <b>Standard copy memory</b>   | The MAX 200 is equipped with 208 MB of standard copy memory.   |
|  | To order optional features or accessories call the Xerox Engineering Systems sales office at 1-877-XES-8212, extension 751.  |

## Optional accessories

---

Some machine configurations may have optional accessories. Any one or more accessories may or may not be installed on your system.

The MAX 200 has the following optional accessories available:

- Folder
- Flat stacker
- Document carrier

## Optional features

---

Some machine configurations may have optional features. Any one or more features may or may not be installed on your system.

The MAX 200 has the following optional features available:

- Editing kit
- Stamper kit, with floppy disk drive
- Multifunction plot kit
- Multifunction scan kit
- Additional scan-to-file memory kit



To order optional accessories call Xerox Engineering Systems sales office at 1-877-8212, extension 751.



For more information, visit the Xerox Engineering Systems web site at <http://www.xes.com>.

## About this guide

---





This user guide contains information you need to operate and maintain the MAX 200 safely and efficiently. Please read this guide carefully. Always refer to this user guide if a problem occurs during the use of the MAX 200.

### Conventions

---

Special conventions are used, in this user guide, to help you get the most from the guide.

Typefaces and symbols in the guide identify terms and conditions. The table below provides you with a description of the typefaces and symbols used in this user guide.

Typeface	Symbol	Description
<b>Bold</b>	None	Identifies an action to perform, like press a button or select an area on the touch screen. It also identifies terms, a feature, an option or message.  Example 1: Select <b>print</b> . Example 2: The <b>ready to copy</b> message is displayed. Example 3: The <b>normal R/E screen</b> is displayed.
<i>Italic</i>	None	Identifies a chapter or section title in this guide. For more information refer to the chapter or the section title.
<i>Italic</i>		<i>Note:</i> The symbol on the left and the word <b>note</b> at the beginning of a sentence indicates additional information, explanations, and helpful suggestions.
<b>Bold and Normal</b>		<b>Caution:</b> The symbol on the left and the word <b>Caution</b> at the beginning of a sentence alerts the user that certain operations or procedures may cause damage to the machine.
<b>Bold</b>		<b>WARNING:</b> The symbol on the left and the word <b>warning</b> at the beginning of a sentence alerts the user to an operation that could cause injury to them.
Normal		This symbol identifies a web site address.
Normal		This symbol identifies a phone number.

## About this guide (continued)

---

### Organization

---

The MAX 200 user guide contains fifteen chapters. Each chapter may contain several sections. This section provides you with a brief overview of each chapter.

For detailed information, refer to the appropriate chapter and section.

#### **Introduction**      **Customer support**

This section of the introduction provides you with the phone numbers for service and supplies.

#### **Compliance information**

This section of the introduction provides all necessary compliance information associated with the MAX 200.

#### **It's illegal**

This section of the introduction provides you valuable information on what is illegal in your location.

#### **Safety notes**

This section of the introduction provides you with all safety information, warnings, and instructions marked on the product. Failure to follow the recommendations in this section may result in personal injury or rescinding of the machine operation agreement.

**Getting to know the MAX 200**      This chapter introduces the location and function of the major machine components.

**MAX 200 power**      This chapter provides step-by-step instructions on how to power-on and power off the machine. It also includes ground fault protector and machine power mode information.

**Media**      This chapter provides the following media information: specifications, storage, handling, and usability. Step-by-step instructions on how to load the trays is also provided.

**How to make copies**      This chapter provides step-by-step instructions on how to make copies in auto mode, manual mode, or from the manual feed tray.

## About this guide (continued)

---

### Organization (continued)

---

<b>Basic touch screen features</b>	This chapter provides step-by-step instructions on how to use the basic touch screen features.
<b>Image quality touch screen features</b>	This chapter provides step-by-step instructions on how to use the image quality touch screen features.
<b>Additional touch screen features</b>	This chapter provides step-by-step instructions on how to use the additional touch screen features.  It also provides detailed information and procedures for the editing feature.
<b>Finishing touch screen features</b>	This chapter provides step-by-step instructions on how to use the finishing touch screen features.  It also provides detailed information and procedures for the optional stamper feature.
<b>How to customize the MAX 200</b>	This chapter provides information about the custom presets feature and how to enter custom presets. It also identifies, and provides step-by-step instructions on how to change the system, copy, and storage disk/manager custom presets features.
<b>Care</b>	This chapter provides you with information on how to care for the MAX 200 and order supplies.
<b>Problem solving</b>	This chapter provides problem solving information. When a machine problem occurs, go to this section first to assist you with troubleshooting the problem. This chapter also provides the phone number to call for service.
<b>Scanner interface (optional)</b>	This chapter provides general information about the scanner interface.
<b>Plotter interface (optional)</b>	This chapter provides general information about the plotter interface.
<b>Technical data</b>	This chapter provides the MAX 200 technical data.

# Customer support

---

## Service

---

Should you be unable to resolve a problem, place a call to your Xerox Engineering Systems service representative.

Your service representative will assist you in keeping your MAX 200 operating and if required, arrange for a customer service engineer to inspect your MAX 200 and restore its performance.

When you call service you will need the machine serial number. You can access the serial number from the meter check screen. For detailed information on how to obtain the serial number, refer to page 24.

Fill in each item below. When you call for service, they will request this information.

**Customer account name:** \_\_\_\_\_

**Customer account number:** \_\_\_\_\_

**Machine type:** \_\_\_\_\_

**Machine serial number:** \_\_\_\_\_

**Purchase date:** \_\_\_\_\_



United States XES 1-877-3627 or 1-877-XES-DNCS.  
Customer First Center



Canada 1-800-939-3769.



For more information, visit the Xerox Engineering Systems web site at <http://www.xes.com>.

## Supplies

---



To order supplies for the MAX 200 call 1-800-538-6468. A supplies representative will assist you with evaluating your supply needs. You can reach the 24-hour fax order line at 1-800-204-5403.



For more information, visit the Xerox Engineering Systems web site at <http://www.xes.com>.



# Compliance information

---

## FCC Compliance in the USA

---



**WARNING:** This equipment has been tested and found to comply with the limits for a Class A computing device pursuant to Subpart B of Part 15 FCC Rules.

This equipment generates, uses, and can radiate radio frequency energy and, if it is not installed and used in accordance with the instruction guide, may cause interference to radio communications. These limits are designed to provide reasonable protection against such interference when operated in a commercial environment. Operation of this equipment in a residential area is likely to cause interference, in which case the user, at his own expense, will be required to take whatever measures may be required to correct the interference.

## EME Compliance in Canada

---

This digital apparatus does not exceed the Class A limits for radio noise emissions from digital apparatus set out in the radio interference regulations of the Canadian Department of Communications.

## Conformité EEM

---

Cet appareil numérique est conforme aux limites d'émission de bruits radioélectriques pour les appareils de classe A stipulées dans le Règlement sur le brouillage radioélectrique du Ministère des Communications du Canada.

## In the USA

---

It is against U.S. law to reproduce copyrighted material without the permission of the copyright owner unless the copying falls within the "Fair Use" library reproduction rights of the copyright law.



Further information on these U.S. provisions may be obtained from the Copyright Office, Library of Congress, Washington, D.C. 20550, or telephone the Copyright Office at (202) 707-9100 and ask for circular 21. Copying other items may be prohibited. If you have any questions seek legal advice.

## In Canada

---

Parliament, by statute, has forbidden the copying of the following subjects under certain circumstances. Penalties of fines or imprisonment may be imposed on those guilty of making such copies.

1. Current bank notes or current money.
2. Obligations or securities of a government or bank.
3. Exchequer bill paper or revenue paper.
4. The public seal of Canada or of a province, or the seal of a public body or authority in Canada, or of a court of law.
5. Proclamations, orders, regulations or appointments, or notices thereof (with intent to falsely cause same to purport to have been printed by the Queen's Printer for Canada, or the equivalent printer for a province).
6. Marks, brands, seals, wrappers, or designs used by or on behalf of the Government of Canada or of a province, the government of a state other than Canada, or a department, board, commission or agency established by the Government of Canada, or a province or a government of a state other than Canada.
7. Impressed or adhesive stamps used for the purpose of revenue by the Government of Canada or a province or the government of a state other than Canada.
8. Documents, registers, or records kept by public officials charged with the duty of making or issuing certified copies thereof, where the copy falsely purports to be a certified copy thereof.
9. Copyright material or trademarks of any manner or kind without the consent of the copyright or trademark owner.
10. The above list is provided for your convenience and assistance, but is not all-inclusive, and no liability is assumed for its completeness or accuracy. In case of doubt, consult your solicitor.

## Safety notes

---

Your system has been designed and tested to meet strict safety requirements. These include safety agency examination and approval plus compliance with established environmental standards.



**WARNING: Failure to follow the recommendations in this section may result in personal injury or rescinding of the machine operation agreement.**

### Maintenance safety

---

1. Follow all warnings and instructions marked on or supplied with the product.
2. Unplug the units from the wall outlet before cleaning the exterior. Always use materials specifically designated for the MAX 200. Use of other materials may result in poor performance and could create a hazardous situation.
3. Do not use aerosol cleaners. Follow the instructions in this operator guide for the correct cleaning methods.
4. Never use supplies or cleaning materials for purposes other than what they were intended. Keep all supplies and materials out of the reach of children.
5. Do not use the units near water, wet locations, or outdoors.
6. The components of this product are equipped with a three-wire, grounding-type plug (i.e., a plug having a grounding pin). This plug will only fit into a grounding-type power outlet. This is a safety feature. To avoid the risk of electric shock, contact your electrician to replace the receptacle if you are unable to insert the plug into the outlet.
7. Never use a ground adapter plug to connect the system to a power source that lacks a ground connection terminal.
8. This system should be operated from the type of power source indicated on the marking label. If you are not sure of the type of power available, consult your local power company.
9. The power supply cord is the disconnect device for this equipment. Make sure that the installation is near the socket outlet and is easily accessible.
10. Do not allow anything to rest on the power cord. Do not locate the units where someone will step on the cord.
11. The units should not be placed in a built-in installation unless correct ventilation is provided.

## Safety notes (continued)

---

### Maintenance safety (continued)

---

12. Never push objects of any kind into the slots of the units as they may touch dangerous voltage points or short out parts that could result in a risk of fire or electric shock.
13. Never spill liquid of any kind on the units.
14. Never remove any covers or guards that require a tool for removal. There are no operator serviceable areas within these covers.
15. Never attempt any maintenance function that is not specified in this operator guide.
16. Never defeat interlock switches. Machines are designed to prevent operator access to unsafe areas. Covers, guards, and interlock switches are provided to ensure that the system will not operate with the covers opened.
17. If the power plug is used as a disconnect device, instructions shall comply with UL 1950 Sec. 1.7.2. The power switch does not break power to the low voltage power supply.
18. Unplug the reprographic system from the wall outlet and call for service under the following conditions:
  - When the power cord is damaged or frayed.
  - If the gas piston springs in the upper cover of the printer lose their strength.
  - If liquid has been spilled into the product.
  - If the units have been exposed to rain or water.
  - If the units are producing unusual noises or odors.
  - If the units or the cabinets have been damaged.
19. If you need additional safety information concerning the MAX 200 or XES supply materials, call:



United States                      1-800-828-6571.  
Xerox Hotline



In other countries                      Please call your local Xerox Engineering Systems service representative for help.

### Ozone safety

---

This product produces ozone during normal operation. The ozone produced is heavier than the air and quantity is dependent on the copy volume. Providing the proper environmental parameter, as specified in Xerox Engineering System installation procedures, will ensure that concentration levels meet safe limits.



If additional information concerning ozone is needed, request the Xerox publication Ozone, 600P83222. Please call your Xerox Engineering Systems representative.

---

# Table of contents

---

<b>Introduction .....</b>	<b>i</b>
Welcome to the MAX 200 .....	i
Optional accessories.....	ii
Optional features.....	ii
About this guide .....	iii
Conventions .....	iii
Organization .....	iv
Customer support .....	vi
Service .....	vi
Supplies.....	vi
Compliance information .....	vii
FCC Compliance in the USA.....	vii
EME Compliance in Canada .....	vii
Conformité EEM .....	vii
It's illegal .....	viii
In the USA .....	viii
In Canada .....	viii
Safety notes .....	ix
Maintenance safety .....	ix
Ozone safety .....	x
<b>Getting to know the MAX 200 .....</b>	<b>15</b>
Scanner.....	15
Front .....	15
Rear.....	16
Printer.....	17
Manual feed tray.....	18
Touch screen .....	19
Components .....	19
How do I know if a feature or option is available?.....	20
Scanner control panel .....	21
Upper components .....	21
Lower components .....	22
Information button .....	23
Stored jobs button .....	23
Meter check button.....	24
Custom presets button .....	24
Review button.....	25
Stop document button .....	25
Clear button.....	26
Clear all button .....	26
Check/repair button .....	26
Stop copy button .....	27
Interrupt button .....	27
Power save button.....	28
Scanner document feed panel.....	28
Auto mode panel.....	29
Printer control panel.....	30
Messages .....	30
Printer diagram.....	32
Top indicator lamps .....	33
Buttons .....	33
Manual feed panel .....	34
RFC panel.....	36
Cut sheet panel.....	37
Media type and series panel.....	38
Media series panel (tray 5) .....	38
<b>MAX 200 power.....</b>	<b>39</b>
Switching the power-on.....	39

Switching the power off .....	40
Ground fault protectors .....	41
Printer ground fault .....	41
Scanner ground fault .....	41
Warm-up .....	42
Auto power-off mode .....	42
Power save .....	42
<b>Media.....</b>	<b>43</b>
How to handle unusable documents.....	43
Torn or ripped document.....	43
Document with staples .....	43
Document with curl.....	43
Bent document .....	43
Transparent document .....	43
How to store cut sheet media .....	44
How to store roll media .....	44
Media type and weight charts .....	45
Media size charts .....	46
Maximum scan length .....	47
Maximum print length.....	47
How do I know when tray 5 or a drawer is empty? .....	48
From the auto mode panel .....	48
From the R/E, media, cut touch screen.....	48
From the RFC panel.....	48
From the cut sheet panel .....	48
How to load roll media .....	49
How to load cut sheet media .....	51
How to cut roll media .....	52
Auto cut .....	52
Manual cut.....	53
Heater .....	54
Humidifier (optional).....	55
<b>How to make copies.....</b>	<b>56</b>
Before making copies .....	56
In auto mode .....	57
In manual mode .....	60
With the manual feed tray .....	64
<b>Basic touch screen features.....</b>	<b>68</b>
Media cut mode .....	69
R/E; media; cut .....	70
Normal R/E .....	71
R/E by L&W .....	73
Normal R/E calculator .....	75
Paper length adjustment .....	79
Image density.....	87
Document image type .....	88
Print color.....	90
One color (black or red) .....	90
Two color (black and red).....	91
<b>Image quality touch screen features.....</b>	<b>92</b>
Sharpness.....	93
Scan color sensitivity .....	94
<b>Additional touch screen features.....</b>	<b>95</b>
Image location.....	96
Editing .....	97
Overall editing .....	98
Marker editing.....	107
Coordinates editing .....	119
<b>Finishing touch screen features .....</b>	<b>129</b>
E-sorter .....	130
Off (uncollated).....	131
Collated .....	132

Program.....	135
Stamper .....	137
Stamp pattern.....	139
Numbering.....	141
Stamp location.....	147
Date stamp .....	153
Stamp color .....	158
Folder.....	159
Paper exit (for machines with no folder) .....	161
<b>Stored jobs .....</b>	<b>162</b>
How to store, recall or delete a job .....	162
Store jobs log .....	164
Job feature log .....	165
<b>How to customize the MAX 200.....</b>	<b>167</b>
Identifying the system features .....	168
Identifying the copy features.....	170
Identifying the storage/disk manager features.....	173
How to enter custom presets .....	174
How to change the system features .....	176
Time & date.....	176
Auto power off .....	177
Auto power save.....	178
Auto clear/backlight off.....	179
Document width.....	181
Attention tone .....	182
Plotter setup .....	183
Loading stamp data.....	190
Additional setting.....	192
How to change the copy features .....	194
Reduce/enlarge presets .....	194
Media type and width for auto mode.....	196
Stamp location and orientation.....	198
Date stamp format.....	201
Folder setup .....	203
Auto/manual mode .....	212
Media cut mode and document orientation.....	214
Lead/trail edge default for synchronized .....	216
Variable length default.....	218
Background suppression level default .....	220
Image density.....	223
Document image type .....	224
Scan to print color default .....	225
Color recognition range.....	226
Marker area recognition .....	229
Additional setting.....	231
How to change the storage/disk manager features .....	233
Stamp creation/deletion .....	233
Disk manager (format/duplication) .....	245
E-sorter (program) settings .....	249
<b>Care.....</b>	<b>256</b>
Cleaning the scanner platen glass.....	256
Ordering supplies.....	256
<b>Problem solving .....</b>	<b>257</b>
Problem solving chart .....	257
Clearing a scanner jam.....	259
Clearing a printer jam.....	260
Indicator lamps 1 - 4.....	261
Indicator lamp 5.....	262
Indicator lamps 6 or 7.....	263
Indicator lamp 8.....	264
Indicator lamp 9.....	266
Indicator lamp 10.....	268
Indicator lamp 11 or 12.....	270

Replacing the toner cartridge.....	271
Relatch the fuser.....	273
Calling for service .....	274
<b>Scanner interface (optional).....</b>	<b>275</b>
Overview .....	275
<b>Plotter interface (optional).....</b>	<b>276</b>
Overview .....	276
How to enter copy mode from plot mode .....	277
<b>Technical data .....</b>	<b>278</b>
Printer specifications.....	278
Physical characteristics.....	278
Floor space requirements .....	278
Scanner specifications.....	279
Physical characteristics.....	279
Floor space requirements .....	279
System requirements.....	279
Electrical.....	280
Environmental data .....	280
Media specifications.....	281
System capability.....	281
Material safety data sheet (MSDS) information.....	282



---

# Getting to know the MAX 200

---

## Scanner

---

### Front

---

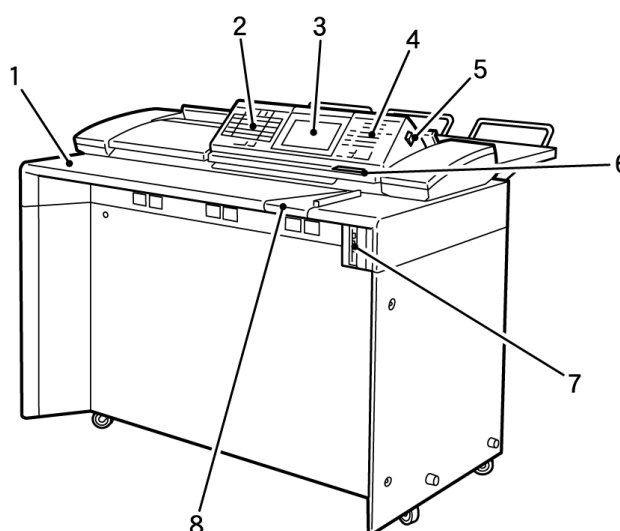

No.	Name	Function
1	<b>Document shelf</b>	Place documents face down on the document shelf and feed into the scanner.
2	<b>Auto mode panel</b>	The auto mode panel is used to select the media size, document feed direction, and mode of operation. When in auto mode the panel also displays the document size, media type, and media supply information. For detailed information about the panel, refer to page 29.
3	<b>Touch screen</b>	Displays available features and options, messages, and job information. For detailed information about the touch screens, refer to page 19.
4	<b>Scanner control panel</b>	Contains the numeric keypad, control buttons and the document counter. For detailed information about the panel, refer to page 21.
5	<b>Power switch</b>	Switches the scanner power-on or off. If your system is equipped with the printer and the scanner switch is positioned to off, power to the printer is also removed.
6	<b>Document feed direction panel</b>	Displays the document feed direction.
7	<b>Floppy diskette drive</b>	The floppy disk drive is used to store stamp data.
8	<b>Document guide</b>	The document guide registers the document during the scan process.

## Scanner (continued)

### Rear

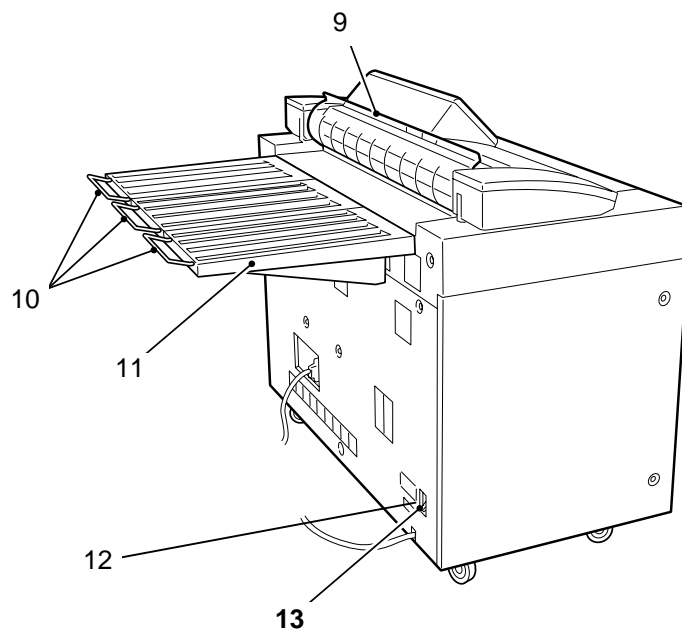

No.	Name	Function
9	<b>Document exit guide</b>	The document exit guide is positioned manually. If the guide is positioned up, documents are fed to the document output tray. If the guide is positioned down, documents are fed to the front of the scanner.
10	<b>Document support guides</b>	If documents are longer than 36 inches, pull out the document support guides. The guide keeps long documents from falling off the document output tray.
11	<b>Document output tray</b>	The document output tray receives documents when the document exit guide is in the up position.
12	<b>Scanner circuit breaker</b>	The circuit breaker switches the main power to the scanner on or off.
13	<b>Ground fault protector</b>	If the scanner detects an electrical problem, the ground fault protector switches the scanner power off.

# Printer

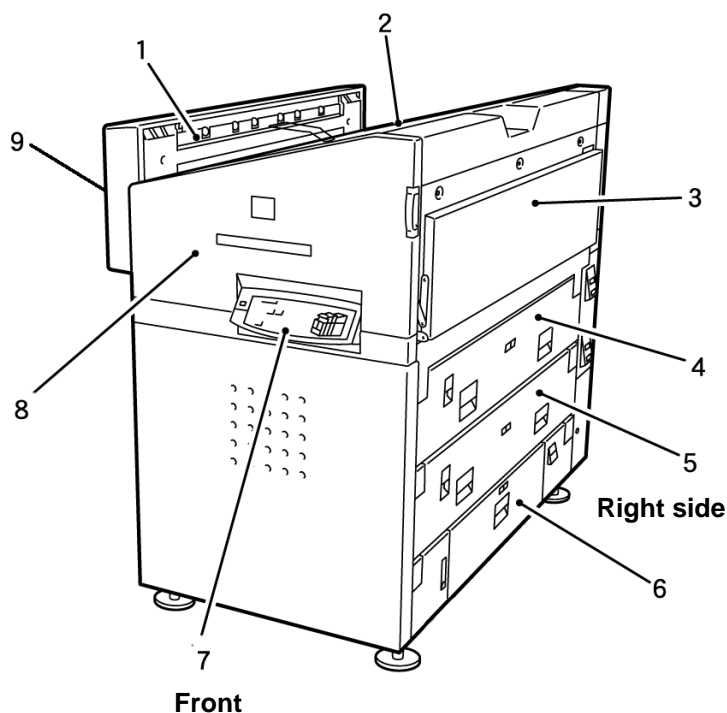

No.	Name	Function
1	<b>Copy output tray exit area</b>	Copies that exit this area are feed to the copy output tray.
2	<b>Copy output tray</b>	Copies are placed onto the copy output tray when there is no folder or stacker. Maximum media tray capacity is 100 sheets (20 –24 lb.).
3	<b>Manual feed tray</b>	Supplies standard or nonstandard media sizes. All media is feed manually.
4	<b>RFC drawer 1</b>	The roll feed cutter (RFC drawer 1) supplies up to 2 rolls of media. The media type and series panel is included in the drawer, for detailed information about the panel, refer to page 38.
5	<b>RFC drawer 2</b>	The roll feed cutter (RFC drawer 2) supplies up to 2 rolls of media. The media type and series panel is included in the drawer, for detailed information about the panel, refer to page 38.
6	<b>Cut sheet tray</b>	Supplies 1000 sheets of cut sheet media, 8.5 x 11 inch to 12 x 18 inch. The cut sheet tray is also referred to as tray 5. The media series panel is included in the tray, for detail information about the panel, refer to page 38.
7	<b>Printer control panel</b>	Displays the printer status and includes the offline button, and the red and black increase toner buttons. For detailed information about the panel, refer to page 30.
8	<b>Front door</b>	Open to access media jams or to replace the toner cartridge.
9	<b>Copy output folder/stacker exit area</b>	Copies that exit this area and are fed into the folder or stacker.

## Printer (continued)

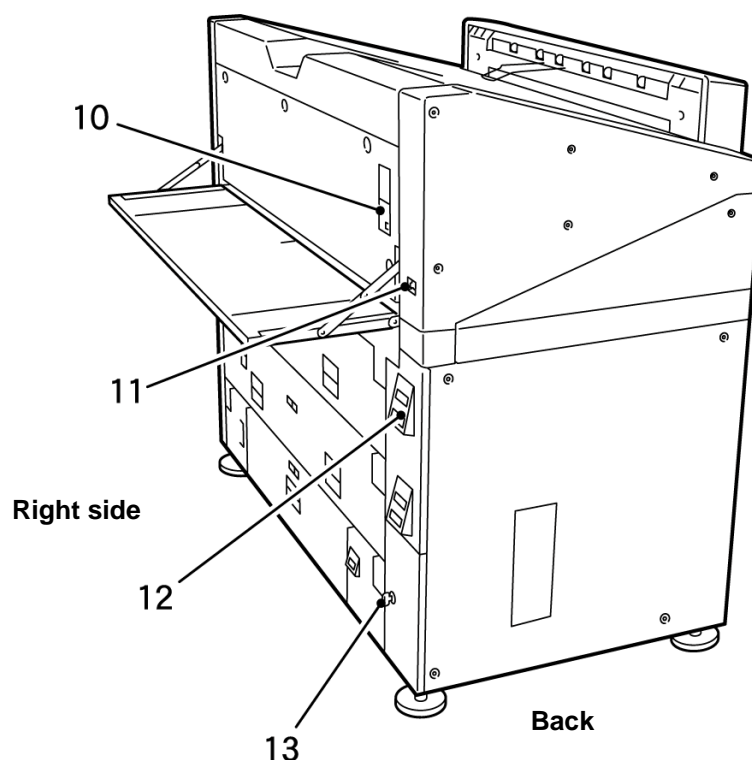

No.	Name	Function
10	Manual feed panel	Displays the manual feed tray status and contains the manual feed control buttons. For detailed information about the panel, refer to page 34.
11	Power switch	Switches the printer power-on or off.
12	RFC panel	Displays media roll information. The trim button controls the auto cut function. For detailed information about the panel, refer to page 36.
13	Lower door	Open to access the printer circuit breaker, heater switch and the humidifier switch (optional).

### Manual feed tray

Using the manual feed tray is useful when the correct size or type of media is not loaded in the printer, or when you need to make a copy on special size media (A – E).

For detailed information on how to make copies, with the manual feed tray, refer to page 70.

# Touch screen

---

The touch screens contain messages, copy quantity information, tabs, buttons, icons and text. There are two types of screens, the copy feature screens and the custom presets screens.

The copy feature screens are grouped into four feature group tabs; basic, image quality, additional, and finishing. Whenever a selection is made from any of the tabs, the selection overrides the custom presets values until the **clear all** button is pressed.

The custom presets screens are grouped into three feature group tabs; system, copy, and storage/disk manager. When you enter custom presets you can customize the MAX 200 defaults, to meet your workflow requirements.

## Components

---



*Note: The screen below is an example of a copy feature screen. The text above the selection buttons, displays the current copy feature selections.*

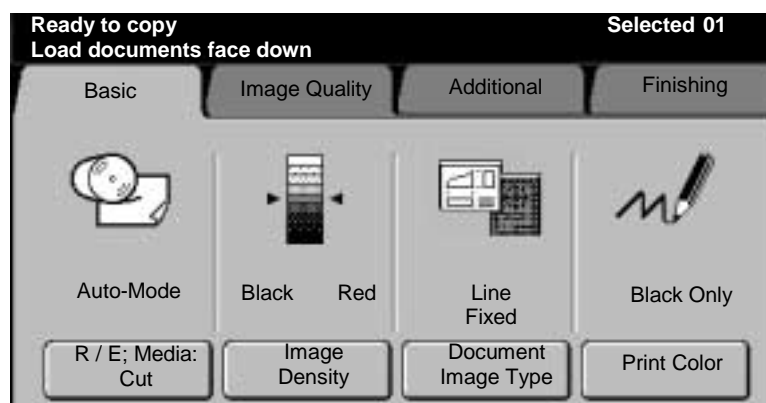

**Message bar** Displays the machine conditions, operator instructions, and copy quantity. In this example the message bar displays the following information:



**Tabs** There are four feature group tabs (basic, image quality, additional, finishing). When a tab is selected, the feature group menu is displayed. Each feature group has a specific set of selections.

**Icons and text** Each feature group screen is divided into columns, each column may contain an icon with text. Each column provides the operator a quick overview of the current job selections.

**Selection buttons** To select touch screen features or options, touch the desired button.

## Touch screen (continued)

---

### How do I know if a feature or option is available?

---

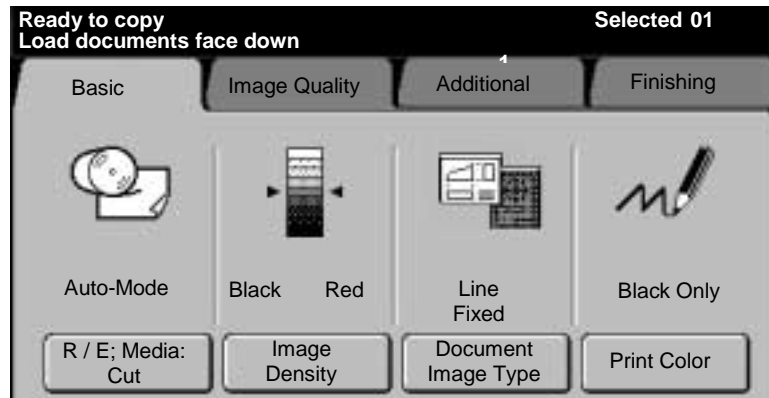

An available feature or option is shown raised and is not grayed out. In this example the basic feature group tab is available, along with the four selection buttons.

Any tab or button that is not raised and appears to be grayed out is not available. In this example the following tabs are not available: image quality, additional, and finishing.



*Note: Any feature group tab or selection button that is not available, may have a conflict with a current selection. Sometimes a specific option must be selected first, or your machine is not equipped with the optional accessory.*

# Scanner control panel

## Upper components

The **scanner control panel** is divided into two sections; the upper and lower sections. The upper section is located under the scanner control panel cover. To access the upper section, press the **press to open** latch and release.

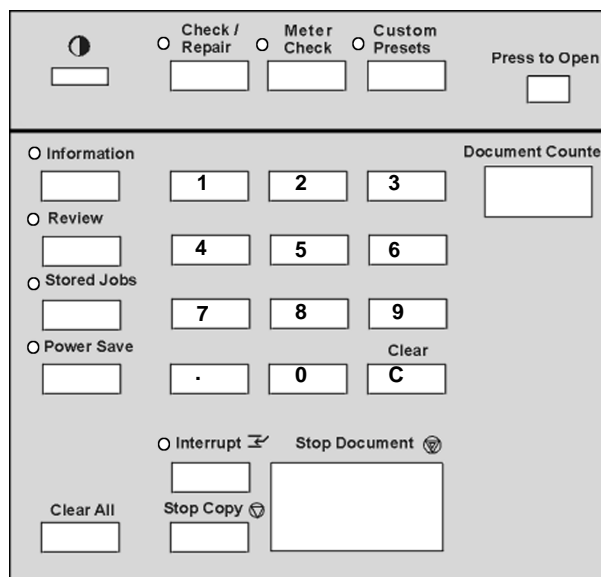

Name	Function
<b>Brightness control dial</b>	The <b>brightness control dial</b> adjusts the brightness of the touch screen.
<b>Check/repair button</b>	The <b>check/repair button</b> is for the service representative.
<b>Meter check button</b>	The <b>meter check button</b> provides access to the billing meter. The meter reads the printer usage. For detailed information on how to use the meter check button, refer to page 24.
<b>Custom presets button</b>	The <b>custom presets button</b> provides access to the system, copy, and storage/disk manager defaults. You can change the defaults to meet your specific needs. For detailed information about the custom presets button, refer to page 24.
<b>Press to open latch</b>	Press and release the <b>press to open</b> latch, to open the top cover of the scanner control panel.

## Scanner control panel (continued)

### Lower components

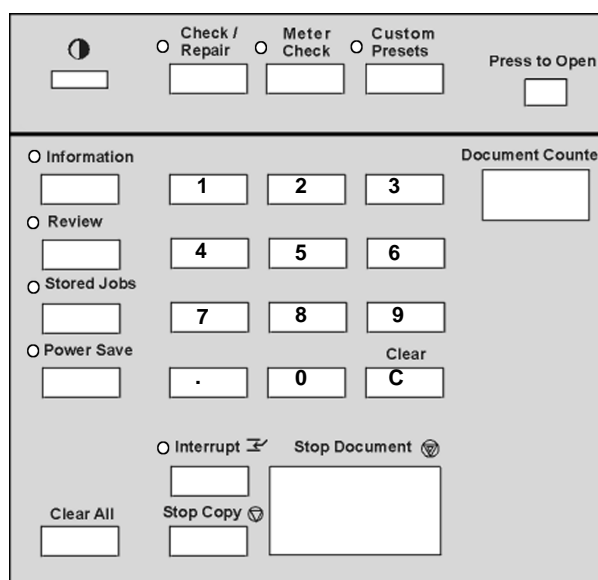

Name	Function
<b>Information button</b>	Press the <b>information button</b> , to provided online information about the machine feature and options. For detailed information, refer to page 23.
<b>Review button</b>	Press the <b>review button</b> , to display the current job feature settings, and move quickly between screens. For detailed information, refer to page 25.
<b>Stored jobs button</b>	Press the <b>stored jobs button</b> to store, recall or delete a stored job. For detailed information, refer to page 162.
<b>Power save button</b>	Press the <b>power save button</b> , to enter or exit the power saver mode. For detailed information, refer to page 28.
<b>Document counter</b>	The <b>document counter</b> displays the total number of scanned documents. To reset, press the button beside the counter.
<b>Clear button</b>	Press the <b>clear (C) button</b> , to clear numeric data. For detailed information, refer to page 26.
<b>Clear all button</b>	Press the <b>clear all button</b> , to clear current copy feature selections and numeric data. The machine automatically returns to the custom presets default settings. For detailed information, refer to page 26.
<b>Interrupt button</b>	Press the <b>interrupt button</b> to suspend the current job, so a different job can be run. For detailed information, refer to page 27.
<b>Stop copy button</b>	Press the <b>stop copy button</b> to stop the print cycle. For detailed information, refer to page 27.
<b>Stop document button</b>	Press the <b>stop document button</b> to stop the scan operation. For detailed information, refer to page 25.
<b>Numeric keypad</b>	Press the <b>keypad buttons</b> to enter quantity and other information.



## Scanner control panel (continued)

---

### Information button

---

#### Introduction

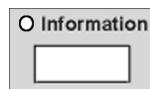

The **information button** is a quick way to access online information. For additional information, refer to the user guide.

#### Procedure

1. Press the **information button**.  
The information indicator lamp is lit and the **information main-menu screen** is displayed.
2. Select the desired topic.  
Information about the topic is displayed or a sub topic menu is displayed.  
Select **close** to return to the previous screen.
3. To exit, press the **information button**.  
The **basic feature group screen** is displayed and the information indicator lamp is not lit.

### Stored jobs button

---

#### Introduction

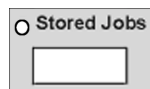

This **stored jobs button** allows you to store (create), recall, or delete stored jobs. For detailed information refer to page 162.

## Scanner control panel (continued)

---

### Meter check button

---



*Note: The meter check screen displays two fields, billing and service. The service field is for the service representative.*

#### Introduction

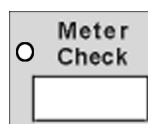

The **meter check button** provides access to the billing meter. The meter displays the printer media usage.

The machine serial number is also displayed on the meter check screen. It is located at the lower right corner of the screen.

#### Procedure

1. Press the **press to open** latch, at the upper right corner of the scanner control panel cover.  
The scanner control panel cover is open.
2. Press the **meter check button**.  
The meter check indicator lamp is lit and the meter check screen is displayed.  
The billing field displays the media usage.
3. To exit, press the **meter check button**.  
The **basic feature group screen** is displayed.

### Custom presets button

---



*Note: For detailed information on how to enter the custom presets feature, refer to page 174.*

#### Introduction

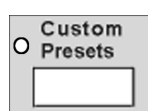

The **custom presets button** provides access to various default settings. There are three feature groups; system, copy and storage/disk manager.

#### Procedure

1. Press the **press to open latch**, at the upper right corner of the scanner control panel cover.  
The scanner control panel cover is open.
2. Ensure the machine is in copy mode. If needed, refer to page 277.
3. Press the **custom presets button**.  
The custom presets indicator lamp is lit and the system features tab is displayed.
4. Select the desired feature tab.
5. To exit, press the **custom presets button**.

## Scanner control panel (continued)

---

### Review button

---

#### Introduction



The **review button** provides quick access to review the current job features and quickly move between screens to make changes. Before printing your job, you may want to review all the selected features.

#### Procedure

1. Press the **review button**.
  - The review indicator lamp is lit and the **review screen** is displayed. The first column of text, next to the feature button, is the name of the copy feature.
  - The second column of text, displays the selected feature option.
2. To make changes, select the desired copy feature button. The **copy feature screen** is displayed.
3. Enter your changes.
4. Perform one of the following:
  - a. If you do not have any more changes, select **done** on the copy feature screen. Continue to the next step.
  - b. If you need to make more feature changes press the **review button** again. The **review screen** is displayed and any feature button that is highlighted indicates a change has been made.

When all your changes are complete select **done** on the on the copy feature screen or select **close** on the **review screen** to save your changes. Continue to the next step.
5. Select the copy quantity.
6. Insert your document into the scanner.

### Stop document button

---

#### Introduction

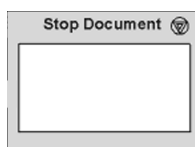

Press the **stop document button** to stop the scan process. If a document begins to tear or skew, always press the **stop document button** immediately. Stopping the document may save your document and eliminate possible document jams.



*Note: If a document jam does occurs, refer to page 259.*

## Scanner control panel (continued)

---

### Clear button

---

#### Introduction

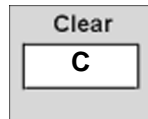

When the **clear (C) button** is pressed, the machine clears the numeric data entered from the keypad.

### Clear all button

---

#### Introduction

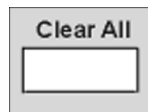

When the **clear all button** is pressed, the machine resets the copy features to the custom presets defaults. This occurs automatically after some preset amount of time.

If a jam occurs, press the **clear all button** to cancel the job while clearing the jam.

### Check/repair button

---

#### Introduction

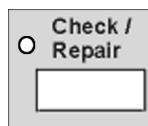

The **check/repair button** is used by the service representative.

## Scanner control panel (continued)

---

### Stop copy button

---

#### Introduction



When the **stop copy button** is pressed, the printer stops printing. If the button is pressed during the copy cycle, the printer stops after completing the current copy cycle. You are given the option to continue the copy process or delete the image.

#### Procedure

1. Press the **stop copy** button.  
The **stop copy screen** is displayed.
2. Select **yes** to resume the same copy job (at the point where it was stopped) or select **no** to cancel the current job.

### Interrupt button

---

#### Introduction

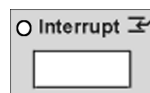

Press the **interrupt button** when you need to run a job other than the current job that is printing and would like to return to the original print job without setting up the original job again.

#### Procedure

1. Press the **interrupt** button.  
When the current copy cycle is complete the **ready to copy** message is displayed. The interrupt indicator lamp stops flashing when the printer is ready to be programmed for the interrupt job.
2. Select the desired features and run the different job.
3. To return to the original job, press the **interrupt button**.

## Scanner control panel (continued)

---

### Power save button

---



*Note: For detailed information on how to setup power save, in custom presets, refer to page 178.*

#### Introduction

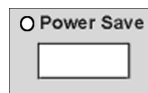

The power save function reduces machine power consumption when the machine is not used for a selected period of time.

When the machine enters the power save mode, current to the fuser is reduced, and the electrical control signals (except auto mode panel and scanner control panel) are switched off.

The power save feature in custom presets, can be set from 1 to 30 minutes, or the feature can be disabled entirely by entering No minutes. The factory default is set to No minutes.

The interval timer clock is reset whenever the **power save button** is pressed and the machine is currently in the power save mode.

If the machine is in power save mode and you would like to begin making copies, press the **power save button**. Once the machine completes the warm-up cycle and the **ready to copy** message is displayed, you may begin copying again.

#### Procedure

1. Press the **power save button**.  
The power save indicator lamp is lit.  
The machine enters the power save mode.
2. To exit the power save mode, press the **power save button**.

## Scanner document feed panel

---





The **scanner document feed panel**, located below the scanner control panel, displays the document feed direction.

When the **ready** message is displayed, you can begin scanning your documents.

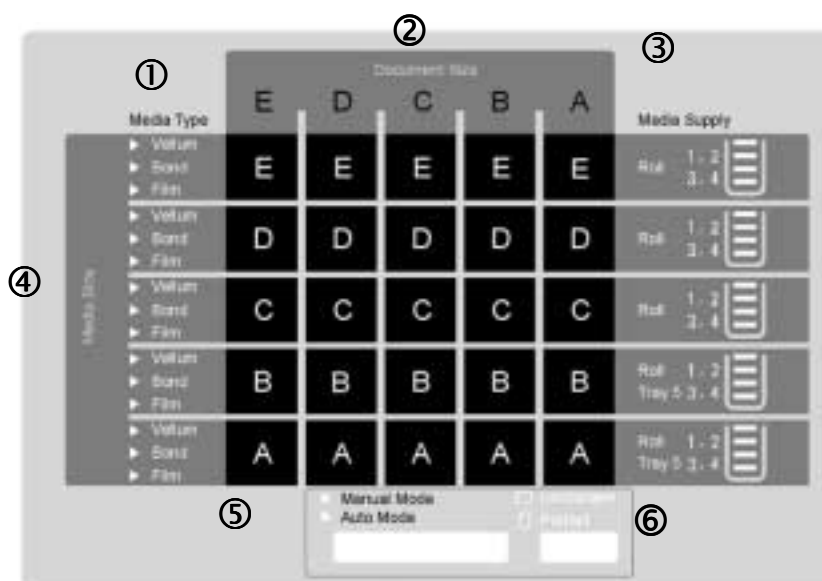
## Auto mode panel



Number	Name	Function
①	<b>Media type</b>	The media type column displays the preset media type for the output media. For detailed information on how setup the media type column, refer to page 196.
②	<b>Document size</b>	Each document size column refers to a document size, which can be feed into the scanner. In auto mode, the panel displays the document size that is feed into the scanner.
③	<b>Media supply</b>	The media supply column displays the auto mode media supply information, such as the roll number, tray or drawer number, and the amount of media in each drawer or tray.  <i>Note: To display the correct media supply information, ensure the media type and series panel and the media series panel (tray 5), are set correctly. If needed, refer to page 38.</i>
④	<b>Media size matrix</b>	The media size matrix displays the output media size.
⑤	<b>Mode select button</b>	There are two modes of operations, auto or manual. If needed, press the <b>mode select button</b> until the desired indicator lamp is lit. The factory default is set to auto. For detailed information to set the mode of operation, refer to page 212.
⑥	<b>Document feed direction button</b>	There are two feed directions, landscape or portrait. If needed, press the <b>document feed direction button</b> until the desired feed direction lamp is lit.  <i>Note: The document feed direction button is disabled when the machine is in manual mode.</i>

# Printer control panel

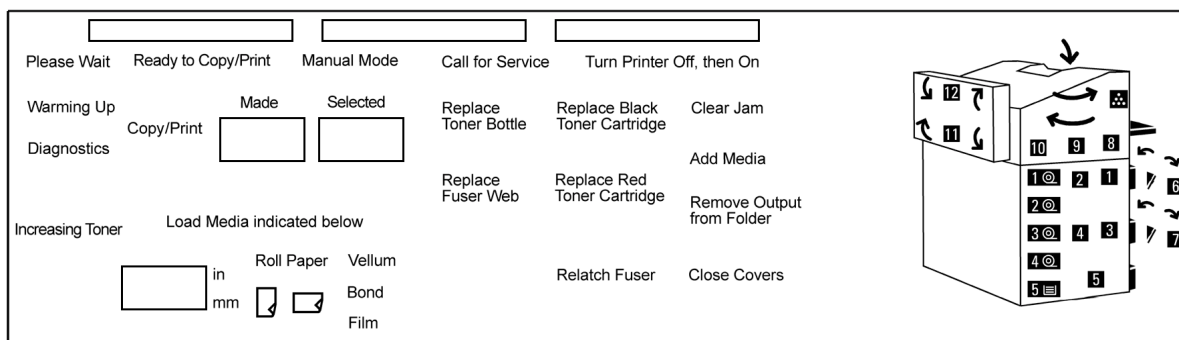

## Messages

Messages	On condition
<b>Please wait</b>	<ul style="list-style-type: none"> <li>The machine condition before the <b>ready to copy/print</b> is displayed.</li> <li>When machine operation has stopped due to a problem.</li> </ul>
<b>Ready to copy/print</b>	When the machine is in the ready condition.
<b>Copy/print</b>	When the machine is running copies.
<b>Warm-up</b>	During the machine warm-up cycle.
<b>Manual mode</b>	When the machine starts copying from the manual feed tray.
<b>Close covers</b>	Indicates one of the printer doors is open.
<b>Call for service</b>	When the machine detects an unrecoverable error that cannot be recovered by a power-on reset.
<b>Turn printer off, then on</b>	When the machine detects on unrecoverable error.
<b>Replace toner bottle</b>	When the machine detects the toner bottle is filled up to its maximum capacity. To replace the toner bottle call for service.
<b>Replace black toner cartridge</b>	When the machine detects the black toner cartridge is out of toner.
<b>Replace red toner cartridge</b>	When the machine detects the red toner cartridge is out of toner.
<b>Add media</b>	Indicates the machine has run out of media. Check the appropriate drawer or tray.



## Printer control panel (continued)

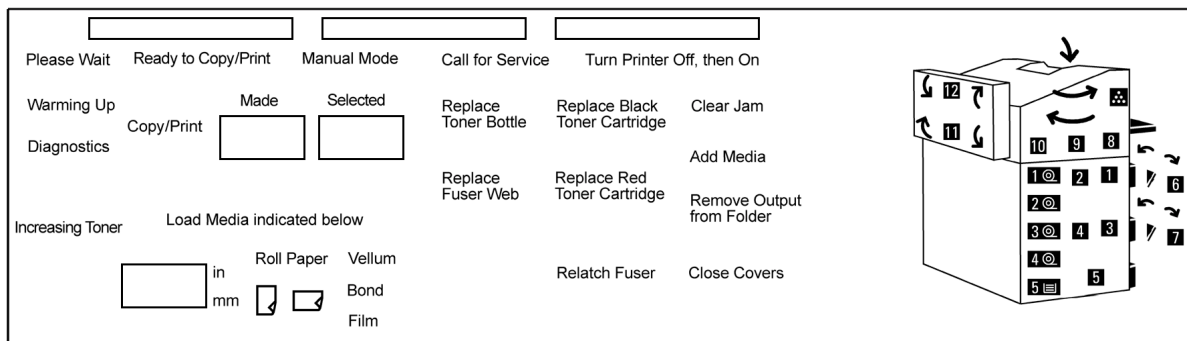

## Messages (continued)

Message	On condition
<b>Remove output from folder</b>	When the machine detects the folder is full.
<b>Relatch fuser</b>	When the fuser is not correctly positioned.
<b>Replace fuser web</b>	When the fuser web needs to be replaced. To replace the web, call for service.
<b>Load media indicated below</b>	<p><b>Load media indicated below</b> is displayed, when the machine detects the selected media supply is empty.</p> <p>The following media information is also displayed:</p> <ul style="list-style-type: none"> <li>Media series window displays the media series</li> <li>Roll or paper</li> <li>The type of media; vellum, bond or film</li> </ul>
<b>Made</b>	The made window displays the number of copies made. Increments by one.
<b>Selected</b>	The selected window displays the copy quantity selected.
<b>Increasing Toner</b>	When the machine starts to increase toner.
<b>Diagnostics</b>	When the machine is in diagnostic mode.
<b>Clear Jam</b>	When the machine detects a media jam. Check the printer diagram for the location of the jam.

## Printer control panel (continued)

### Printer diagram

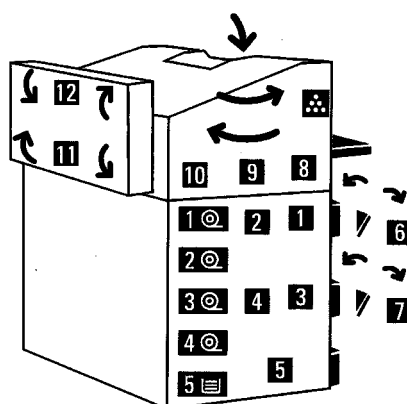

Indicator lamp	Function
1 - 5	When a jam has occurred in the tray area, the respective indicator lamp is lit red.
6	When a jam has occurred between RFC drawer 1 and the xerographic area, the indicator lamp is lit red.
7	When a jam has occurred between RFC drawer 2 and the xerographic area, the indicator lamp is lit red.
8	When a jam has occurred between the manual feed tray and the xerographic area, the indicator lamp is lit red.
9	When a jam has occurred before the xerographic area, the indicator lamp is lit red.
10	When a jam has occurred in the fuser area, the indicator lamp is lit red.
11	When a jam has occurred at the printer media exit area for the folder or stacker, the indicator lamp is lit red.
12	When a jam has occurred at the printer media exit area, for the copy output tray, the indicator lamp is lit red.
1 ⊙	The roll 1 indicator lamp is lit, when the RFC drawer recognizes the specified media series.
2 ⊙	The roll 2 indicator lamp is lit, when the RFC drawer recognizes the specified media series.
3 ⊙	The roll 3 indicator lamp is lit, when the RFC drawer recognizes the specified media series.
4 ⊙	The roll 4 indicator lamp is lit, when the RFC drawer recognizes the specified media series.
5 ≡	The tray 5 indicator lamp is lit, when tray 5 recognizes the specified media series.
⊙ ⊙ ⊙	When the black or red toner needs to be replaced, the toner indicator lamp is lit. Approximately 2000 copies can be made after the indicator lamp is lit.

## Printer control panel (continued)

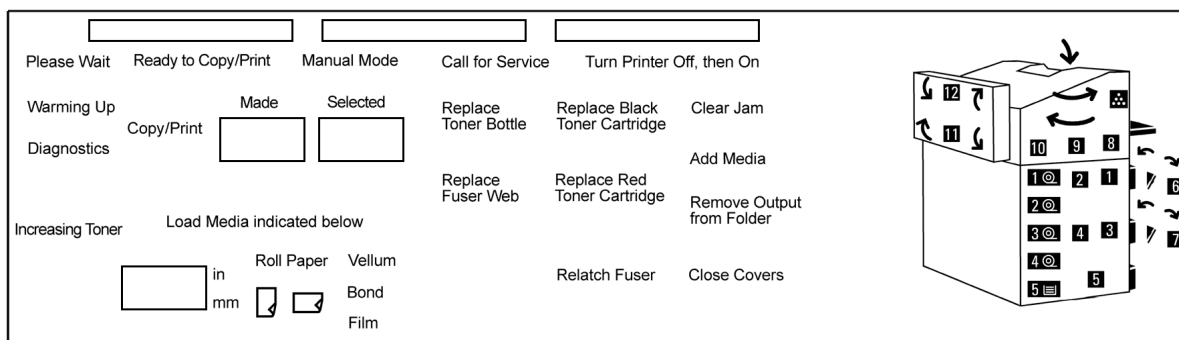

### Top indicator lamps

There are three indicator lamps located at the top of the printer control panel. The table below describes the condition of each indicator lamp.



	Green	Amber	Red
<b>Color</b>	<b>On condition</b>		
<b>Green</b>	When the printer is running.		
<b>Amber</b>	When the machine is temporarily unable to copy because it is in the warm-up cycle, or is offline.		
<b>Red</b>	When the machine detects an a problem.		



*Note: The three indicator lamps flash at power-up.*

### Buttons

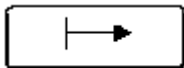
There are three buttons on the left side of the printer control panel (not shown). The table below provides the name and function of each button.

Button	Function
<b>Offline</b>	Press to switch printer to offline or online.
	 <i>Note: When the printer is offline, the offline indicator lamp is lit.</i>
<b>Increase black toner</b>	Press the black button to increase black toner onto the copies.
<b>Increase red toner</b>	Press the red button to increase red toner onto the copies.

# Manual feed panel

This section provides an overview of the manual feed panel components.

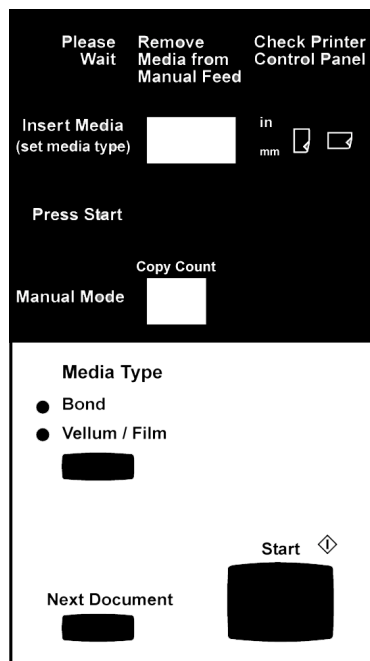

Message	On condition
Please wait	When the machine is at a stop or the machine has detected an error.
Remove media from manual feed	When the machine detects a media jam in the insertion area of the manual feed tray.
Check printer control panel	The operator should check the printer control panel.
Insert media (set media type)	When there is no media inserted at the start of the manual feed copying.
Press start	When the machine detects media inserted in the manual feed tray.
Manual mode	When making copies from the manual feed tray.

**Copy count** When machine is making copies.





Button	Function
Media type	Press the <b>media type button</b> until the desired media type is lit. Selection is displayed in the (set media type) window.

Start	After media is inserted and the media type is selected, press the <b>start button</b> to begin the copy process.
-------	--

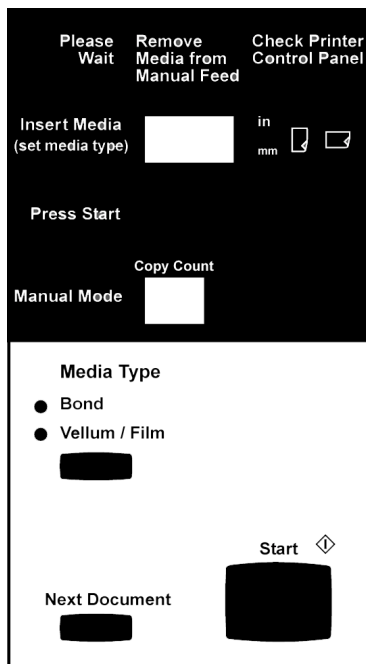
Next document	After making all copies of the current document, press the <b>next document button</b> , to copy the next scanned document.
---------------	---

## Manual feed panel (continued)



Icon	Function
	The portrait icon is lit when media needs to be loaded in the portrait direction.
	The landscape icon is lit when media needs to be loaded in the landscape direction.
Window	Function
	The window displays the number of copies made. Increments by one.
	The window displays the media width you need to manually feed into the manual feed tray.

# RFC panel

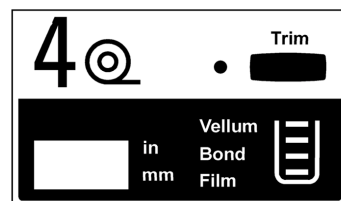
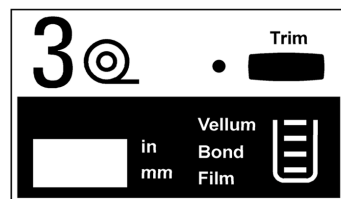
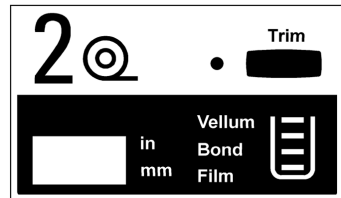
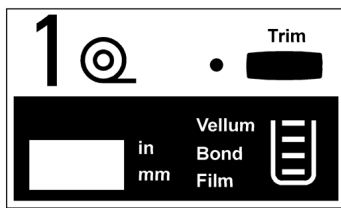

There are four RFC panels, one for each roll. Each panel displays, the amount of media on each roll, the media roll number, the media type and the media series information.

The RFC panels are located on right side of the printer. For detailed information about the RFC media specifications, refer to the appropriate chart in *Media*, starting on page 43.

For instructions on how to load roll media into the drawer, refer to page 49.

Icon	Function
------	----------

- |     |  |
|-----|--|
| 1 @ | Indicates the roll number in the RFC drawer. |
| 2 @ |  |
| 3 @ |  |
| 4 @ |  |

	The media supply indicator lamp displays the amount of media on the roll. When the roll is empty, there are no horizontal lines lit.
--	--

Message	Function
---------	----------

	Displays the media type. Media type is set from the media type and series panel, on page 38.
--	--

Window	Function
--------	----------

	Displays the media width for the selected series. Media series is set from the media type and series panel, on page 38.
--	---

Button	Function
--------	----------

	Press the <b>trim button</b> to perform the auto cut function on roll media. For detailed information on how to use the trim button, refer to page 52.
--	--

*Note: To enable the trim function, the printer must be offline.*

## Cut sheet panel

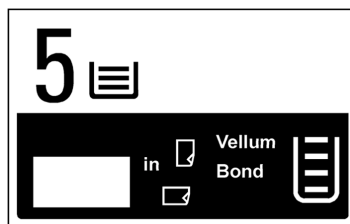

The cut sheet tray, also known as tray 5, supplies bond media and has a tray capacity of 1000 sheets (20 –24 lb.). Media can be loaded, short edge or long edge feed.

For detailed information about the media specifications, refer to the appropriate chart in *Media*, starting on page 43.

For instructions on how to load media into the tray 5, refer to page 51.

Icon	Function
------	----------



The 5 icon indicates the cut sheet tray, tray 5.



The portrait indicator lamp is lit when the feed direction from the cut sheet tray is portrait.



The landscape indicator lamp is lit when the feed direction from the cut sheet tray is landscape.



The media supply indicator lamp displays the amount of media in tray 5. When the tray is empty, there are no horizontal lines lit.

Message	Function
---------	----------

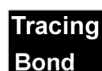

Displays the bond media type only.

Window	Function
--------	----------



Displays the media width for the selected series. The media series is set from the media series panel (tray 5), on page 38.

## Media type and series panel

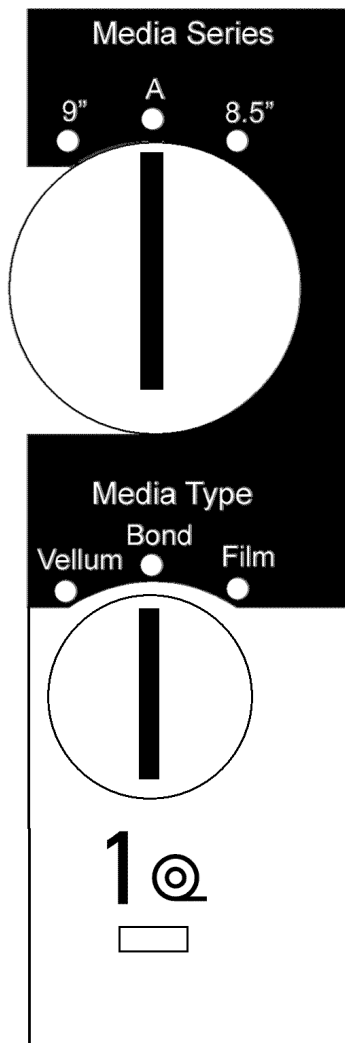



There are four media type and series panels, one for each roll. They are located next to each roll in the RFC drawer. This section provides an overview of the media type and series panel components.

For detailed information about the RFC media specifications, refer to the appropriate chart in *Media*, starting on page 43.

Name	Function
Media series	Set the dial to the correct media series. When the drawer is closed, the RFC panel window displays the media series.

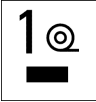
Media type	Set the dial to the correct media type. When the drawer is closed, the RFC panel displays the media type.
------------	--

Window	Function
	When the drawer detects media the indicator lights.  <i>Note: The media type and series panel in this example is for roll 1.</i>

## Media series panel (tray 5)

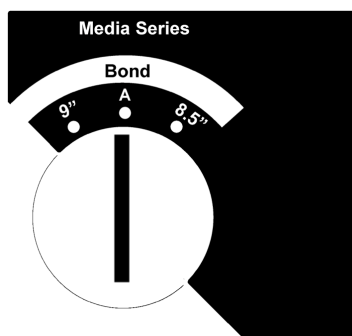

The media series panel is located in the cut sheet tray, tray 5.

For detailed information about the cut sheet tray media specifications, refer to the appropriate chart in *Media*, starting on page 43.



*Note: Only bond media can be loaded into tray 5.*

Name	Function
Media series	Set the dial to the correct media series. When the tray is closed, the cut sheet panel window displays the media width for the selected series.



---

## MAX 200 power

---

The **Max 200 power** chapter provides machine power information. The following topics are discussed:

- Switching the power-on
- Switching the power off
- Ground fault protectors
- Warm-up
- Auto power-off
- Power save

---

### Switching the power-on

---



**Caution:** Never switch off the printer or scanner when the printer is in operation.



*Note:* This procedure is for the printer and scanner only. If your system contains the folder or stacker, refer to their user guide for power-on instructions.

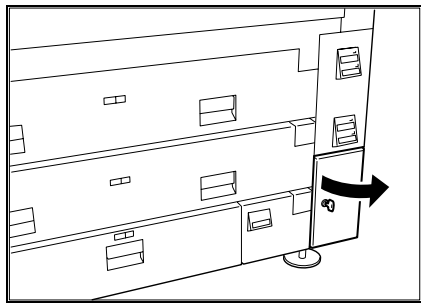

1. Turn the key and open the printer circuit breaker door.

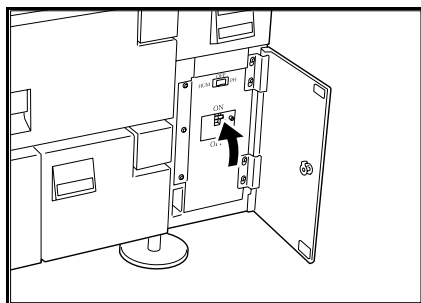

2. Switch the printer circuit breaker to the on position (up).

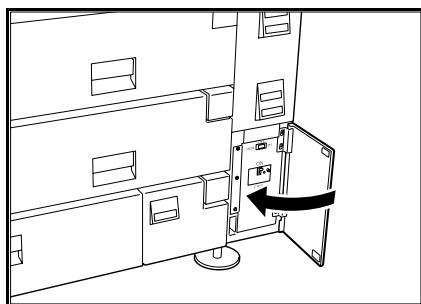

3. Close the printer circuit breaker door and turn the key to lock the door.

## Switching the power-on (continued)

---

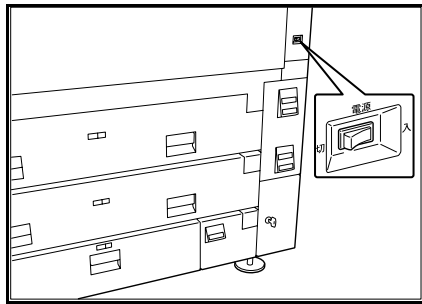

4. Switch the printer power-on.  
The switch is located above the door.

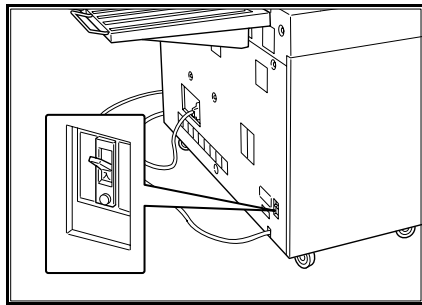

5. Position the scanner circuit breaker switch to the on position (up).  
The scanner circuit breaker is located at the lower rear right corner.

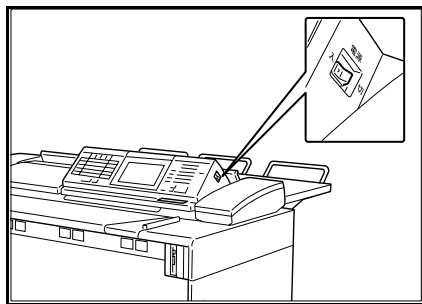

6. Switch the scanner power-on.

## Switching the power off

---



**WARNING:** The machine power switch does not break power to the low voltage power supply, to remove power from the machine disconnect the power cord.



*Note:* This procedure is for the printer and scanner only. If your system contains the folder or stacker, refer to their user guide for power-off instructions.

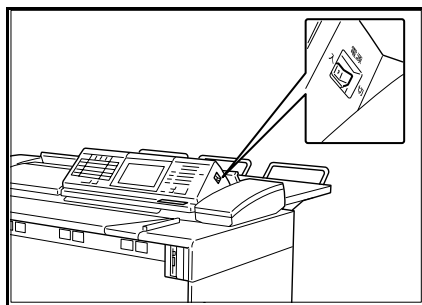

1. Switch the scanner power off.  
The printer power is automatically switched to the off position.

## Ground fault protectors

---

In the event that the MAX 200 experiences an unexpected power loss, check the printer and scanner ground fault protectors.

### Printer ground fault

---

In case of a printer power loss, perform the procedure below:

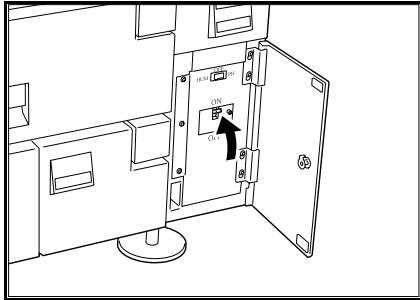

1. Open the printer circuit breaker door.
2. Position the ground fault up.

If the test indicator remains lit, call your Xerox Engineering Systems service representative.

### Scanner ground fault

---

In case of a scanner power loss perform the procedure below:

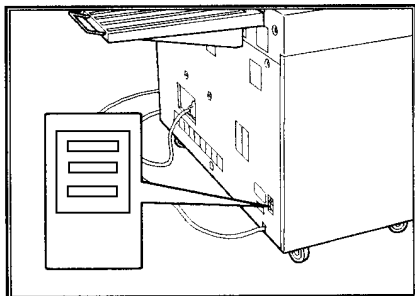

If the color red is not displayed in the top ground fault window, press the **bottom red reset button**.

If the ground fault window still does not have red displayed, call your Xerox Engineering Systems service representative.



*Note: Ensure the scanner circuit breaker is in the up position.*

## Warm-up

---

When the MAX 200 is switched on, the machine enters a warm-up cycle and the **please wait** message is displayed on the touch screen and the printer control panel. The warm-up cycle is approximately 5 minutes at 72°C, 55% humidity.

During the warm-up cycle the scanner does not respond to button selections. When the **ready to copy** message is displayed on the touch screen and **ready to copy/print** is displayed on the printer, you can begin to scan documents or select any touch screen feature or option.

## Auto power-off mode

---

When the machine is not used for a selected period of time, the auto power-off feature switches the machine power to off. To exit the auto power-off mode, you must power-on the machine. For detailed information on how to power-on the MAX 200, refer to page 39.

Once the machine completes the warm-up cycle, and the **ready to copy** message is displayed, you may begin copying again.

The auto power-off timer can be set from 1 to 5 hours, or the feature can be disabled entirely by entering No minutes. The factory default is set to No minutes.

For detailed information on how to change the auto power-off mode default, refer to page 177.

## Power save

---

The power save function reduces machine power consumption when the machine is not used for a selected period of time. The current to the fuser is reduced, and the electrical control signals (except the control panels) are switched off.

To exit the power save mode press the **power save button**, located on the scanner control panel.

Once the machine completes the warm-up cycle, and the **ready to copy** message is displayed, you may begin copying again.

The power save timer can be set from 1 to 30 minutes, or the feature can be disabled entirely by entering No minutes. The factory default is set to No minutes.

For detailed information on how to change the power save default, refer to page 178.

---

## Media

---

### How to handle unusable documents

---

#### Torn or ripped document

---

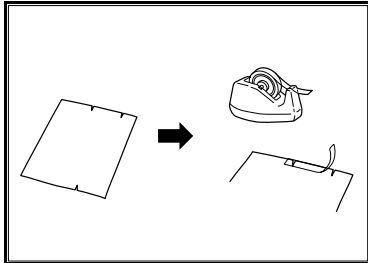

1. Mend the torn portion by affixing tape on the reverse side.
2. If the lead edge is frayed, mend it with tape.

#### Document with staples

---

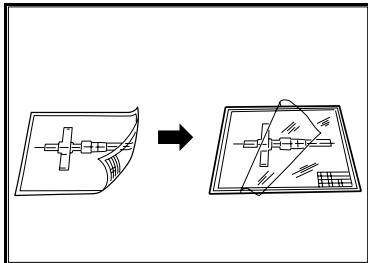

1. Remove the staples.
2. Mend the torn portion by affixing tape on the reverse side.
3. If the lead edge is frayed, mend it with tape.

#### Document with curl

---

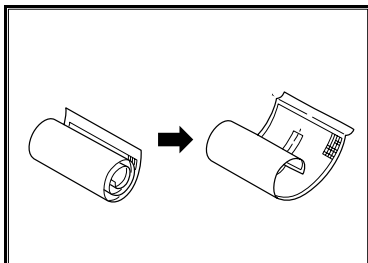

1. Roll the document in reverse to straighten the curl.
2. If the curl cannot be straightened, fold the original document once along the line about 20-30 mm from the lead edge, then flatten the original document before copying it.
3. If media has excessive curl, do not use.

#### Bent document

---

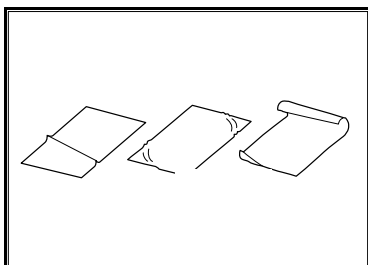

Do not use creased, wrinkled, or excessively curled document.

#### Transparent document

---

Copy the transparent document, with it loaded in the document carrier.

## How to store cut sheet media

---

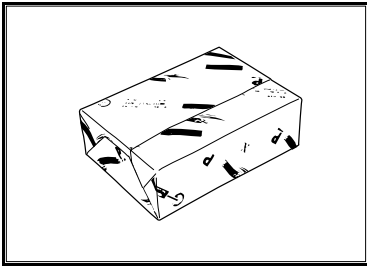

- Store the cut sheet media flat, not on edge.
- Store open media in original wrap and seal.
- Do not expose to moisture or sunlight.

## How to store roll media

---

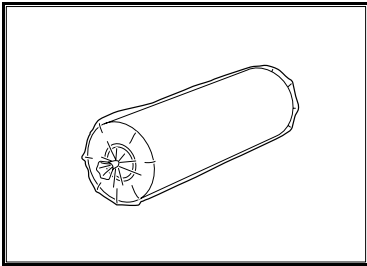

- Store roll media on end.
- Store open media in original wrap and seal.
- Do not expose to moisture or sunlight.

## Media type and weight charts

The media specification charts in this section, provide media type and weight information.

### RFC drawer and manual feed tray

Media type	Media types and weights
<b>Bond</b>	20 lb. Xerox 4024 Engineering smooth 20 lb. Xerox 4024 DP 20 lb. Xerox image series smooth recycled engineering bond
<b>Vellum</b>	20 lb. Xerox improved zero-solvent vellum 17 lb. Xerox zero solvent vellum 20 lb. Improved erasable vellum
<b>Film</b>	4mil Zero solvent accu-image film 3mil Aqueous film

#### RFC media size parameters

Minimum width: 11 inch  
 Maximum width: 36 inch  
 3 in. core diameter with 500 ft. or 650 ft. bond or vellum  
 3 in. core diameter with 150 ft. film

#### Manual feed tray media size parameters

Minimum width: 8.5 inch  
 Maximum width: 36 inch  
 Minimum length: 8.5 inch  
 Maximum length: 19 feet 8 inches

### Cut sheet tray (tray 5)

Media type	Media weights
<b>Bond</b>	20 –24 lb.

#### Cut sheet tray media size parameters

11 x 17 inch, 12 x 18 inch (short/long edge feed)  
 8.5 x 11 inch, 9 x 12 inch (short/long edge feed)

## Media size charts

The media size specification charts in this section provide media size roll, cut sheet, and manual feed tray information.

### RFC drawer

A: Supports auto and manual mode

M: Supports only manual mode

	Standard														
Selection of switch	9 inch series					8.5 inch series					ISO A series				
Size	36 in.	30 in.	24 in.	18 in.	12 in.	34 in.	30 in.	22 in.	17 in.	11 in.	841 mm	594 mm	420 mm	297 mm	210 mm
Supports	A	M	A	A	A	A	M	A	A	A	A	A	A	A	A

### Tray 5

A: Supports auto and manual mode

M: Supports manual mode only

	Standard					
Selection of switch	9 inch series		8.5 inch series		ISO A series	
Size	12 x 18 inch	9 x 12 inch	11 x 17 inch	8.5 x 11 inch	297 x 420 mm	210 x 297 mm
Supports	A	A	A	A	A	A

Tray capacity is 1000 sheets (20 –24 lb.).

Supports pre-punches sheet media (2, 3, and 4 hole)



## Media size charts (continued)

### Manual feed tray

M: Supports manual mode only

	Width												
Size	36 inch	34 inch	30 inch	24 inch	22 inch	18 inch	17 inch	12 inch	11 inch	841 mm	594 mm	420 mm	297 mm
Supports	M	M	M	M	M	M	M	M	M	M	M	M	M

### Maximum scan length

MAX 200 maximum scan length is 49.3 feet (15 m), Xerox Engineer Systems guarantees copy quality up to 32.8 feet (10 m).

### Maximum print length

The MAX 200 print length can be set up to 62.4 feet (19 m). Xerox Engineer Systems guarantees print quality up to 19.7 feet (6 m). If needed, your service representative can set the maximum printer length to; 19.7 feet (6 m), 32.8 feet (10 m), 49.3 feet (15 m), or 62.4 feet (19 m).

\*The maximum print length for E-sorter function is 13.5 feet (4.1 m).

## How do I know when tray 5 or a drawer is empty?

---



The symbol on the left is called the media supply indicator. It is displayed on various MAX 200 components to help you determine the tray or drawer condition. This section identifies the MAX 200 components that display the media supply indicator.

### From the auto mode panel

---

When the MAX 200 is in auto mode, the media supply indicators are displayed on the auto mode panel.

The media supply indicator lamps are located on the far right column, of the auto mode panel. The bars within the indicator lamp reflect the amount in the tray or drawers. When there are no bars displayed, the specified tray or drawer is empty.

### From the R/E, media, cut touch screen

---

When the MAX 200 is in manual mode, the media supply levels are displayed on the R/E; media; cut touch screen.

The media supply icons are located next to the R/E; media; cut option buttons. The bars within each icon reflect the amount of media on each roll or in tray 5. When there are no bars displayed, the specified roll or tray is empty.

### From the RFC panel

---

The media supply indicator lamp is located on the lower right side of the RFC panel. The bars in the indicator lamp reflect the amount of media left. When the media supply indicator displays no bars there is no media on the roll.

### From the cut sheet panel

---

The media supply indicator lamp is located on the right side of the cut sheet panel. The bars within in the indicator lamp reflect the amount of media in the tray. When the media supply indicator displays no bars the tray is empty.

# How to load roll media

## Introduction

When roll media runs out, the printer control panel displays the messages, **add media** and **load media indicated below**.

Perform the following procedure when you need to load roll media into the machine.

## Procedure

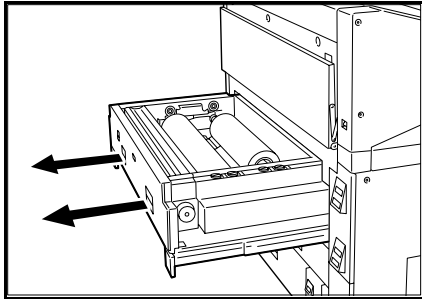

1. Pull out the RFC drawer.

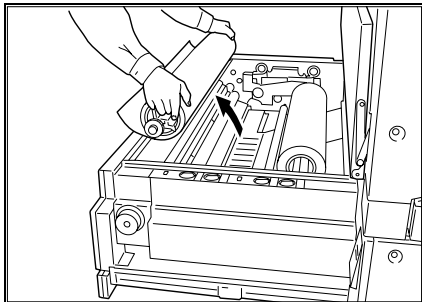

2. Remove the mandrel and empty roll from the RFC drawer.

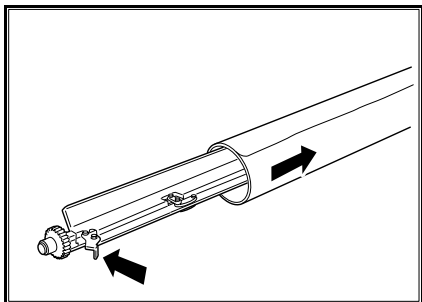

3. Push down on the mandrel release lever, and pull the used media core off of the shaft.

## How to load roll media (continued)

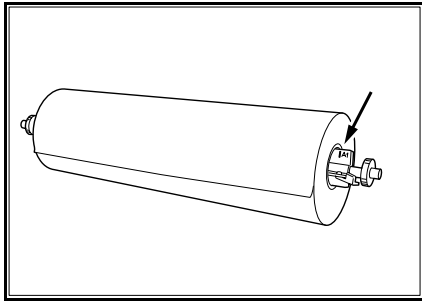

4. Push down on the mandrel release lever, and insert the mandrel into the new media roll.
5. Align the edge of the media to the size indicators on the mandrel.
6. Place the mandrel back into the drawer.

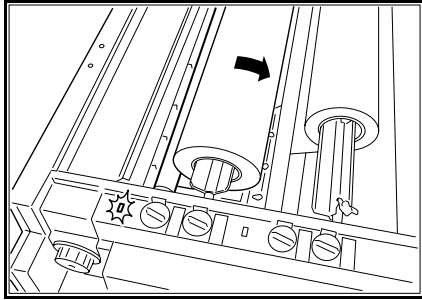

7. Rotate the media lead edge clockwise and position the media lead edge, under the roll.
8. Continue to rotate clockwise until you here a beep.
  - If you hear an intermittent beep, take up the media slightly and rotate the media clockwise again.

The media indicator lamp is lit.

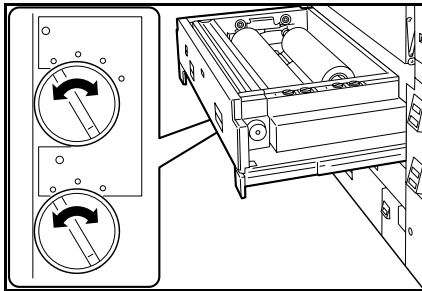

9. Use the dial on the media type and series panel, and set to the correct media series and type.

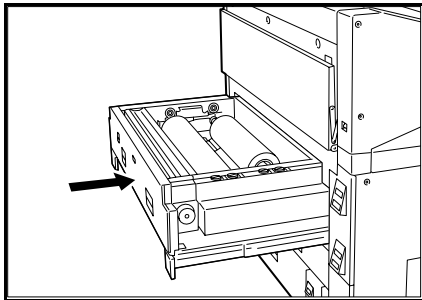

10. Push in the RFC drawer gently back into the machine.



*Note: Ensure the correct media series and type is displayed on the RFC panel. If not, ensure the media series and type panel is set correctly.*

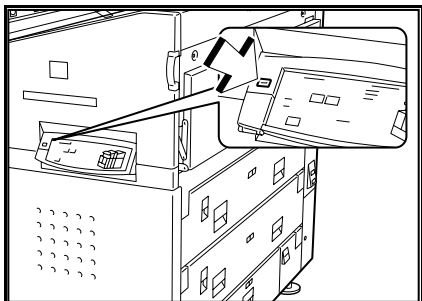

11. Press the **offline button**, on the printer control panel.

The printer is offline.
12. Press the **trim button**, on the RFC panel.

The trim indicator lamp is lit and the trimmed media is sent to the printer copy output tray.
13. Press the **offline button**.

The printer is online.
14. Remove the trimmed media from the copy output tray.

# How to load cut sheet media

## Introduction

The cut sheet tray capacity is 1000 sheets (20 –24 lb.). The cut sheet tray holds 8.5 x 11 inch to 12 x 18 inch bond media (short edge or long edge feed).

Perform the following procedure when you need to load cut sheet media into tray 5.

## Procedure

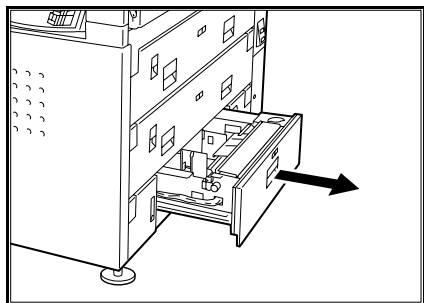

1. Pull out the cut sheet tray.

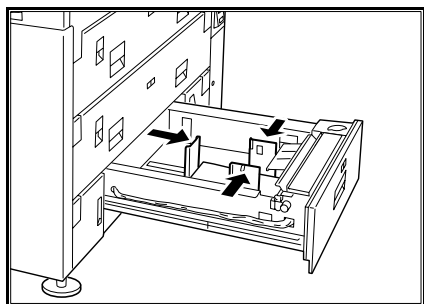

2. Load the media short edge or long edge feed. Refer to the media size label in the tray.

3. Adjust the guides to the media size.

Do not force the guides against the edges of the cut sheet stack.

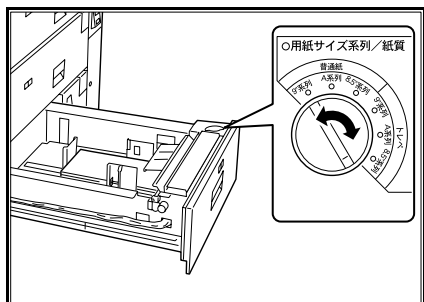

4. Use the dial on the media series panel (tray 5), and set to the correct media series.

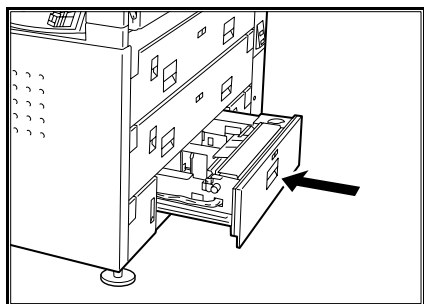

5. Push the tray in until it stops.



*Note: Ensure the correct media series is displayed on the cut sheet panel. If not, ensure the media series panel (tray 5) is set correctly.*

# How to cut roll media

## Introduction

The MAX 200 provides two roll cut methods, auto and manual.

**Auto cut,** page 52. When the **trim button** is pressed, the machine automatically cuts the roll media.

When a new roll is loaded into the drawer, use this cut method to ensure a smooth cut.

**Manual cut,** page 53. The operator uses the cutter knob to cut the media. Use this method, when a media jam occurs and the media jam length is very long. When the cutter knob is used, media is cut at a slight angle.

## Auto cut

### Procedure

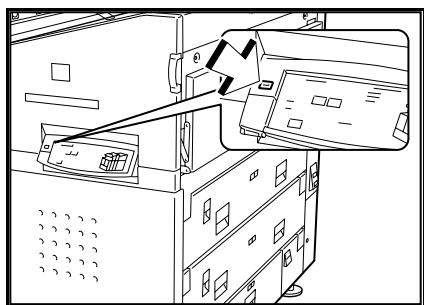

1. Press the **offline button**, on the printer control panel.  
The printer is offline.

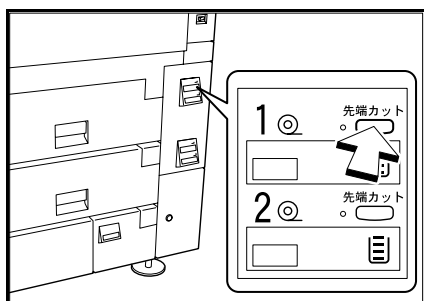

2. Press the **trim button**, on the RFC panel.  
When the machine cuts the media, the trim indicator lamp is lit.  
The trimmed media is sent to the printer copy output tray and the trim indicator lamp is off.

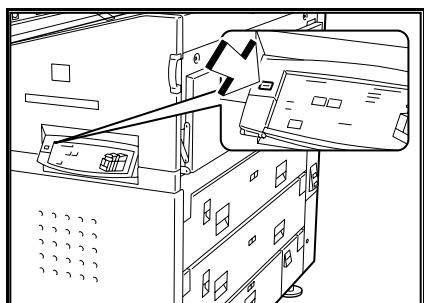

4. Remove the cut media, from the copy output tray.
5. Press the **offline button**.  
The printer is online.

## How to cut roll media (continued)

---

### Manual cut

---

#### Procedure

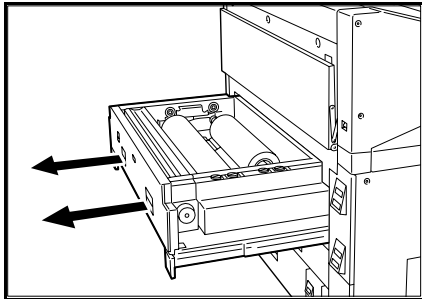

1. Open the desired RFC drawer.

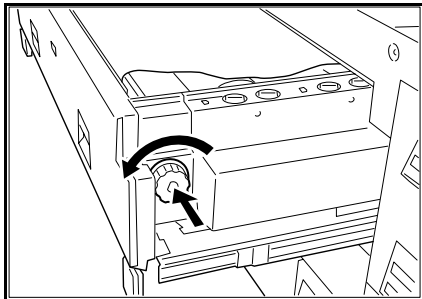

2. Press and release the **cutter knob**.
3. Rotate the **cutter knob** counterclockwise, to cut the media.
4. Remove the cut media from the drawer.

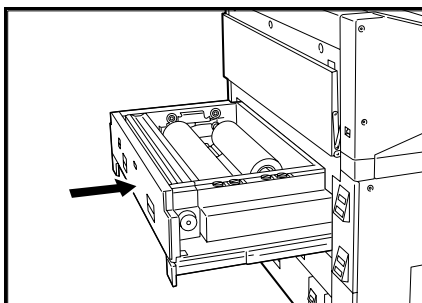

5. Push the RFC drawer gently back into the machine.

# Heater

## Introduction

The heater reduces the moisture contained in the media. If the room humidity is high, switch the media heater to on.



*Note: When the printer is switched off, the heater remains on. In order to switch the heater off, the printer breaker switch must be off.*

## Procedure

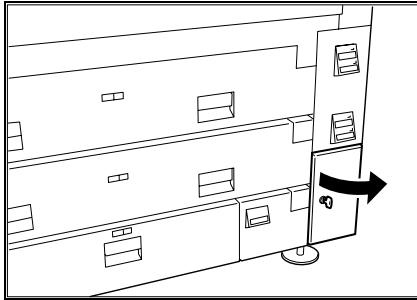

1. Turn the key and open the printer circuit breaker door.
2. Position the media heater switch to on.

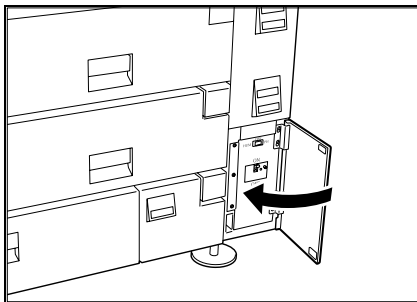

3. Close the printer circuit breaker door and turn the key to lock the breaker door.



# Humidifier (optional)

## Introduction

The humidifier is an optional accessory and adds moisture to the media. Depending on the amount of humidity in the room, the humidifier is automatically switched on.



*Note: When the printer is switched off, the humidifier remains on. In order to switch the humidifier off, the printer breaker switch must be off.*



*Note: The humidifier and the heater can not be activated at the same time.*

## Procedure

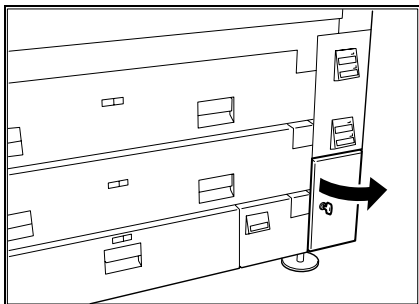

1. Turn the key and open the printer circuit breaker door.
2. Position the right switch to humidifier.
3. Position the left switch to on.



*Note: You can only switch the heater or the humidifier on, both can not be set to On at the same time.*

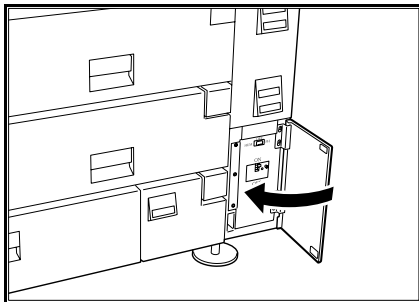

4. Close the printer circuit breaker door and turn the key to lock the breaker door.

---

## How to make copies

---

### Before making copies

---

Before using the MAX 200 you need to determine what standard series the MAX 200 will recognize: 8.5 inch series or 9 inch series. The **Custom Presets** feature, *Document Width*, sets up the default series the machine recognizes.

If your machine is set up to recognize the 8.5 inch series, all output lengths are based on the standard paper sizes shown below:

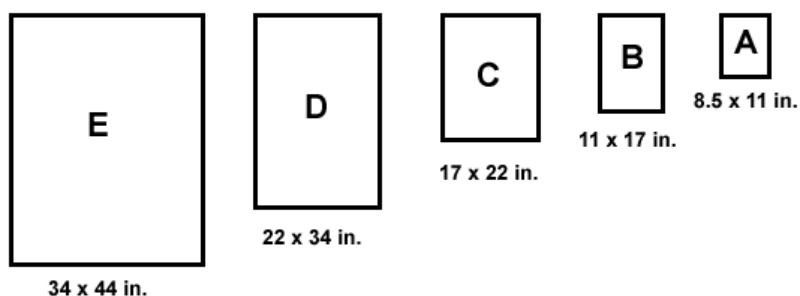

If your machine is set up to recognize the 9 inch series, all output lengths are based on the standard paper sizes shown below:

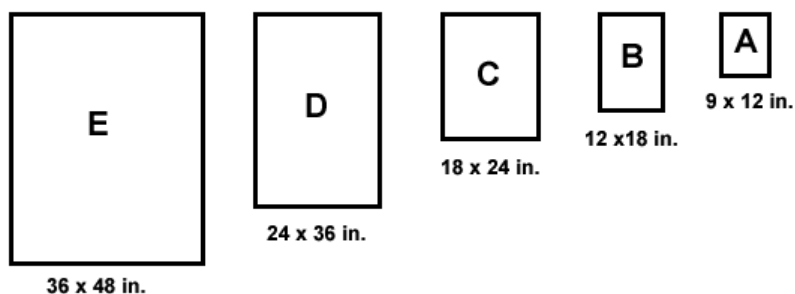

## In auto mode

---



*Note: When the selected feed direction is landscape, the E size row and column on the auto mode panel is not available. The maximum document width for scan is 36 inches, an E size landscape document width is 44 inches.*



*Note: To go directly to the auto mode procedure, go to page 58.*

### Introduction

When MAX 200 is in auto mode, all output lengths are based on the standard paper size set in Custom Presets, 8.5 inch or 9 inch.

The following features are available for auto mode:

- **Auto R/E** – Copies are printed automatically reduced or enlarged per your selection
- **Auto 100%** - Copy at 100%
- **Cut roll media** – Standard or synchronize
- **Add/remove margins** – you can add up to 999 mm or remove up to 90 mm margins in 1 mm increments to either the lead or trail edge of your copy (enabled with synchronize)

E	D	C	B	A
E	E	E	E	E
D	D	D	D	D
C	C	C	C	C
B	B	B	B	B
A	A	A	A	A

### Auto R/E

---

For example, you want all of your documents to be printed on C-size media (shaded buttons), but your input documents are a combination of different size drawings (E, D, C, B and A).

First select C-size media under each document size. The machine then automatically reduces the E and D-sizes to C-size, the C-size document is copied at 100%, and the B and A-size documents are enlarged to C-size.

## In auto mode (continued)

E	D	C	B	A
E	E	E	E	E
D	D	D	D	D
C	C	C	C	C
B	B	B	B	B
A	A	A	A	A

### Auto 100%

In the next example you have multiple size documents and you want each copy to be printed at 100%. For this example, you would select the media size shown to the left (shaded buttons). The machine automatically prints the copies at 100%.

### Cut roll media

- Standard cuts roll media to the length of standard paper sizes.
- Synchronize cuts roll media to the length of the original up to 19.8 feet (6 m) long for a 11 inch (279 mm) wide original.

To activate synchronized cut mode, you need to enable the auto mode-synchronized media cut default to enable in Custom Presets. For detailed refer to page 192.

#### Procedure

- ▶ Manual Mode
- ▶ Auto Mode

1. Ensure the auto mode indicator lamp is lit. If not, press the **mode select button**, until the auto mode indicator lamp is lit.
2. Determine the document size to be scanned (A to E).
3. Select the desired output media size (A – E), for each document to be scanned, on the auto mode panel.

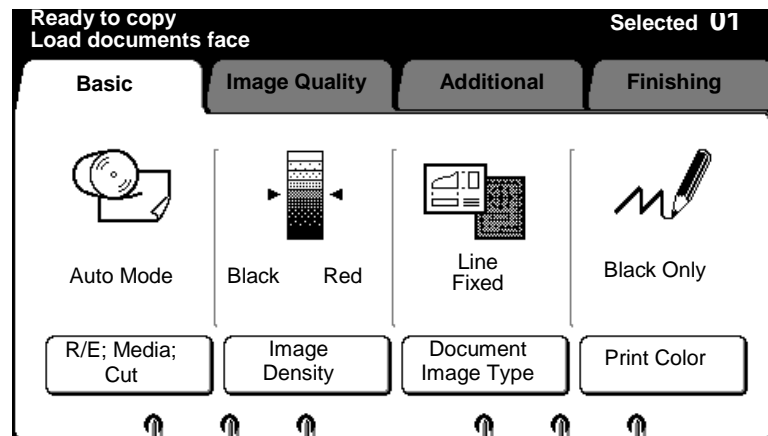

4. Select the desired basic copying features. If needed, refer to page 68.

## In auto mode (continued)

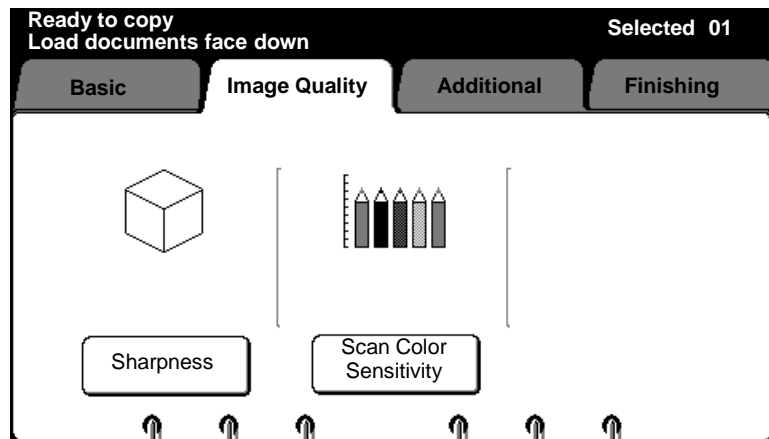

6. Select the desired image quality features. If needed, refer to page 92.

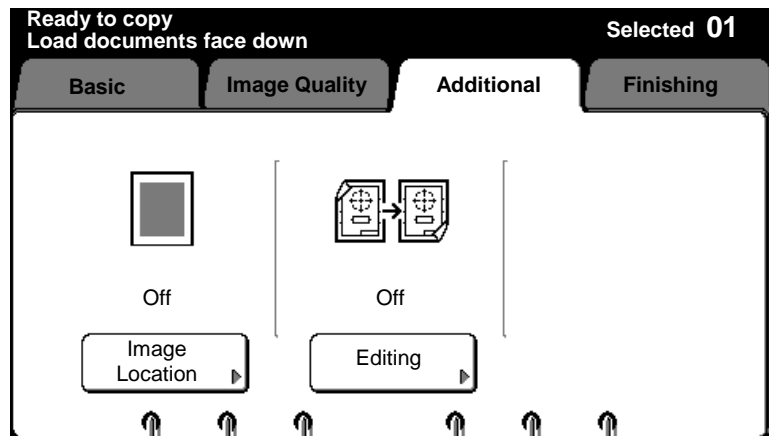

7. Select the desired additional features. If needed, refer to page 95.

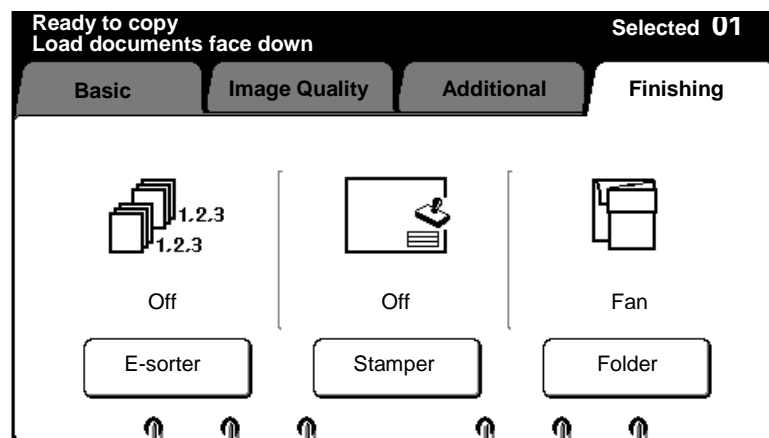

8. Select the desired finishing features. If needed, refer to page 129.
9. Enter the copy quantity.
10. Ensure the document exit guide is positioned correctly. If needed, refer to page 16.
11. When the **ready to copy** message is displayed, insert the document face down along the guide.

# In manual mode

---

## Introduction

When MAX 200 is in manual mode, all output lengths are based on the same auto mode standard sizes and the nonstandard size 30 x 42 inch.

The following features are available for manual mode:

- **Manual 100%** - Copy at 100%
- **Manual R/E** – Reduce or enlarge your copies from 25% to 400%, 0.1% increments are available
- **Cut roll media** – Standard, synchronized, long copy or variable length
- **Add/remove margins** – you can add up to 999 mm or remove up to 90 mm margins in 1 mm increments to either the lead or trail edge of your copy (enabled with synchronize and long copy)
- **Manual feed mode** – Enable the manual feed tray

Documents can be scanned, short edge or long edge feed. If the scanned document size does not match the selected magnification and output media size, an error message is displayed.

## In manual mode (continued)

### Procedure

- ▶ Manual Mode
- ▶ Auto Mode

1. Ensure the MAX 200 is in manual mode. If needed press the mode select button until the manual mode lamp is lit.
2. Select the **basic** feature group tab.

The **basic feature group** screen displayed.

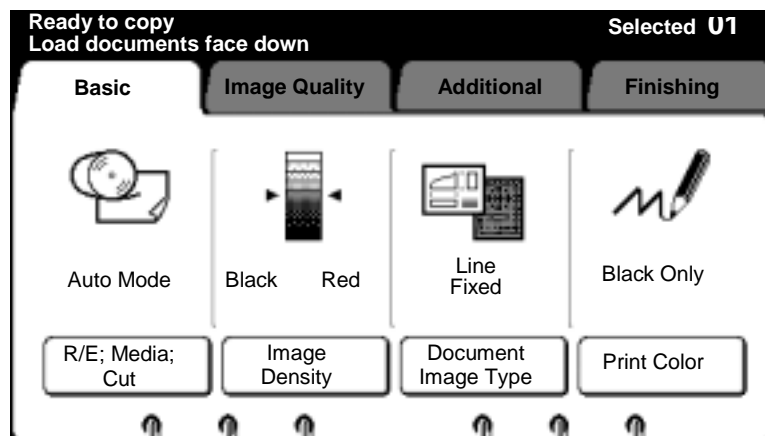

3. Select **R/E; media; cut**.

The **R/E; media; cut** screen is displayed.

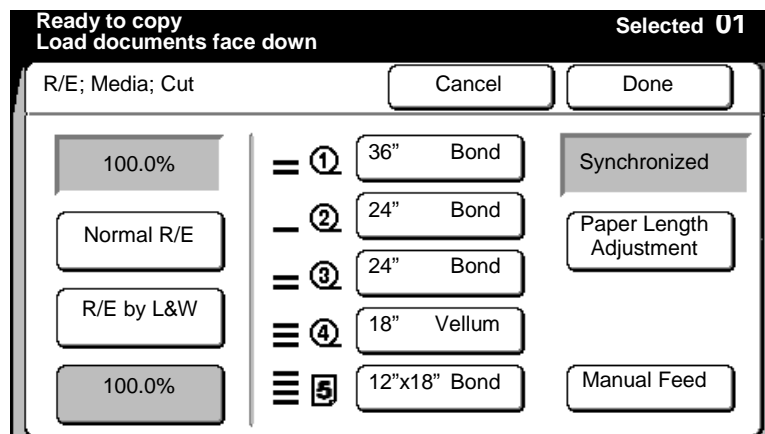

3. If needed, select the desired R/E.

**Normal R/E** One of six preset percentages may be selected, or any percentage within the available range may be entered.

**R/E by L&W** Two different percentages may be selected, one for the length and one width.

**100.0%** Same as document.

4. Select the desired media source (**roll 1 – roll 4, or tray 5**).

When roll media is selected, the paper length adjustment feature is enabled. If needed, select this button to select the desired cut mode. For detailed information, refer to page 79.

5. Select **done**.

The **basic feature group** screen is displayed.

## In manual mode (continued)

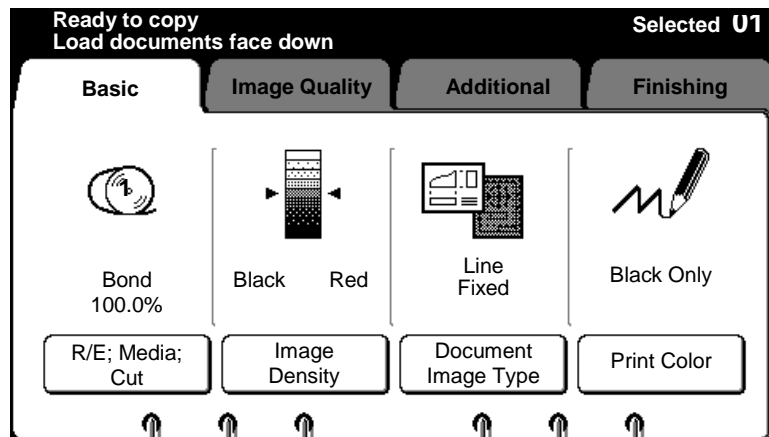

6. Select other desired basic copying features. If needed, refer to page 68.
7. Select the desired image quality features. If needed, refer to page 92.

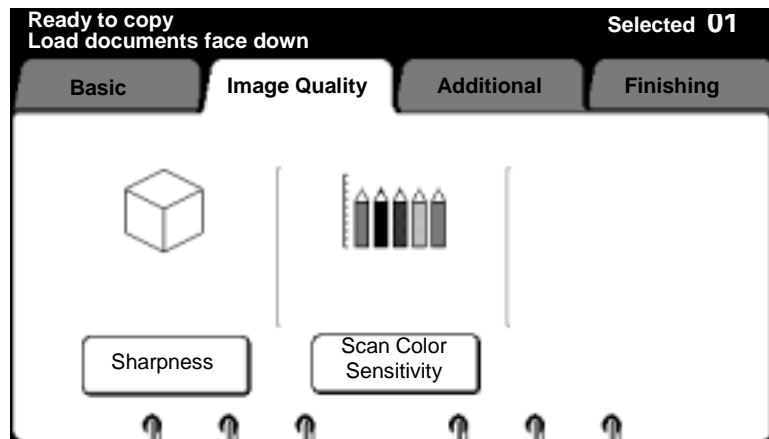

8. Select the desired additional features. If needed, refer to page 95.

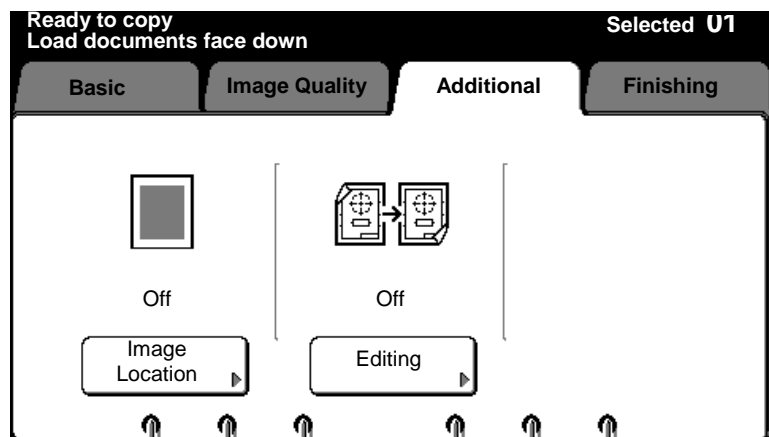



## In manual mode (continued)

---

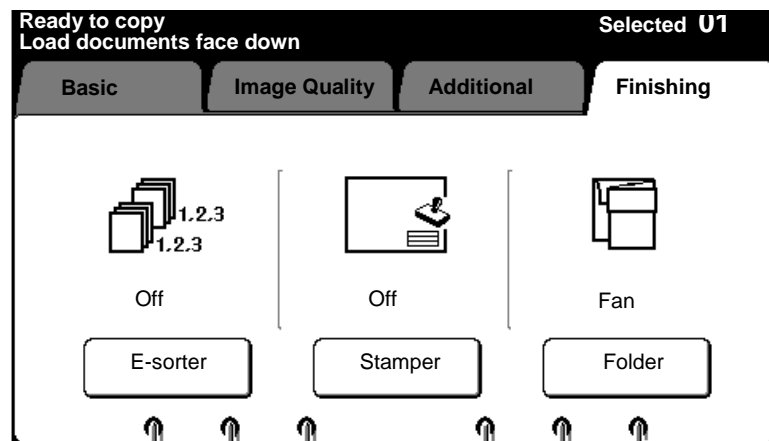

9. Select the desired finishing features. If needed, refer to page 129.
10. Enter the copy quantity.
10. Ensure the document exit guide is positioned correctly. If needed, refer to page 16.
11. When the **ready to copy** message is displayed, insert the document face down along the guide.

## With the manual feed tray

### Introduction

Using the manual feed tray is useful when the correct size or type of media is not loaded in the printer, or when you want to make a copy on special size media (A – E).

Refer to the helpful hints before using the manual feed tray procedure on page 64.

### Helpful hints

- The manual feed mode is available with the combination of the stamper and E-sorter.
- The stamper feature can be used with manual feed.
- Not available when the E-sorter is being used.
- Copies made with the manual feed tray, can not be folded.

### Procedure

1. Ensure MAX 200 is in manual mode. If needed, press the mode select button until the manual mode lamp is lit.
2. Select the **basic** feature group tab.
3. Select **R/E; media cut**.

The **R/E; media; cut screen** is displayed.

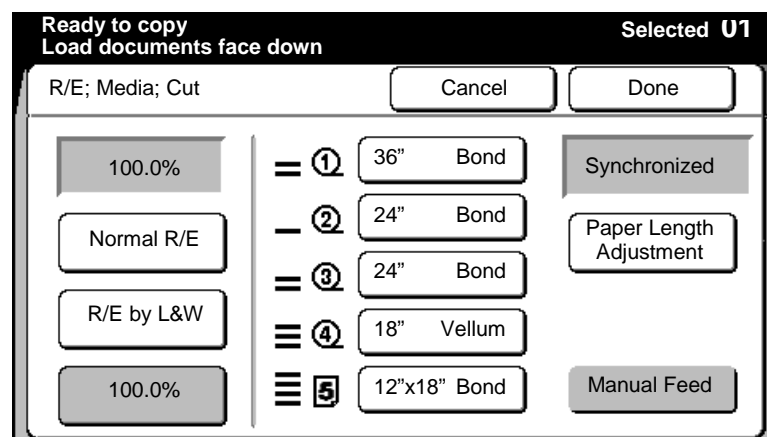

4. Select **manual feed**.

The **manual feed screen** is displayed.

## With the manual feed tray (continued)

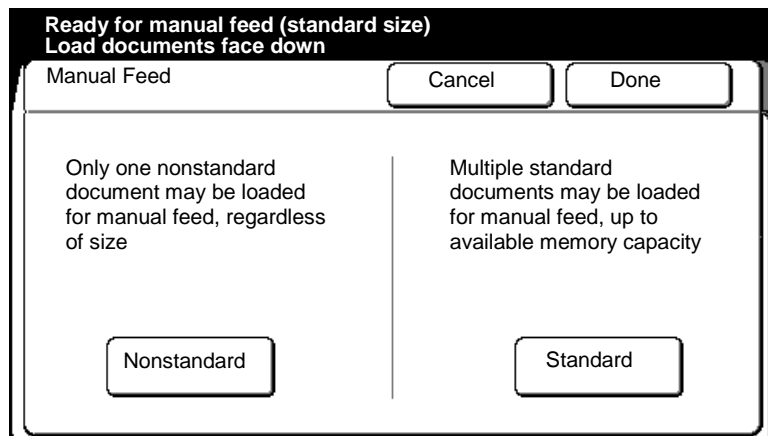

5. Select **nonstandard** or **standard**.

**Standard** The number of standard sized documents that can be scanned at one time depends on the memory capacity and document size.

**Nonstandard** Only one nonstandard document can be scanned at a time.

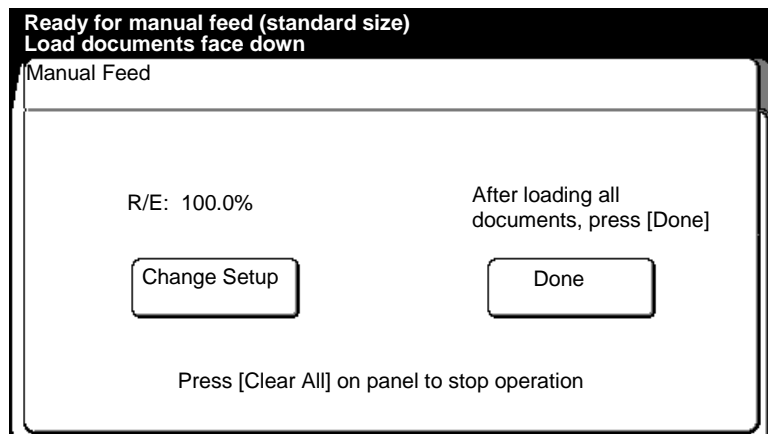

6. Insert each document in your document set into the scanner and follow steps 5a or 5b, after each document is scanned.
  - a. If your scanned document requires any copy feature changes, select the **change setup button** and go to step 14.
  - b. When all your documents have been scanned and there are no required copy feature changes, select the **done button**. Continue to the next step.
6. Open the manual feed tray.

## With the manual feed tray (continued)

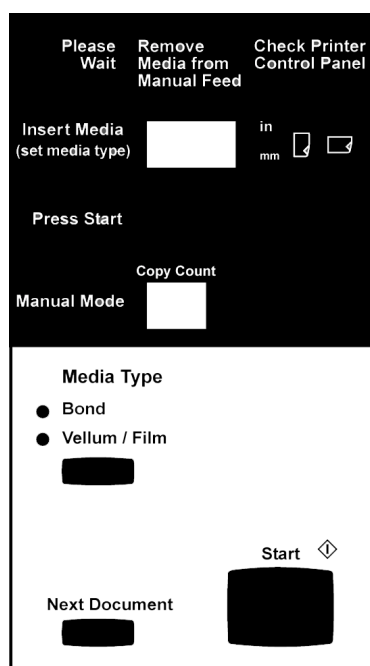

7. Press the **media type button**, until the desired media type is displayed.
  - The media series is displayed in the insert media window.
8. Insert the media into the manual feed tray in the direction that is displayed on the manual feed panel (landscape or portrait).
  - Ensure to align the media between the guidelines, on the manual feed tray. The machine will grip the media and feed it in slightly.
  - The **press start** message is displayed when the media is loaded correctly.
9. Press the **start button**, on the manual feed panel, to start copying.
  - To make additional copies of the same scanned document, press the **start button** again.
  - The number of copies made is displayed in the copy count window.
10. If needed, press the **next document button**, to make copies of your next scanned document. Else continue to the next step.
 

To make multiple copies of the same document repeat step 9.
11. Repeat step 10 until all scanned documents have been copied.
12. To exit the manual feed mode, press the **stop copy button** on the scanner control panel. Stop here.

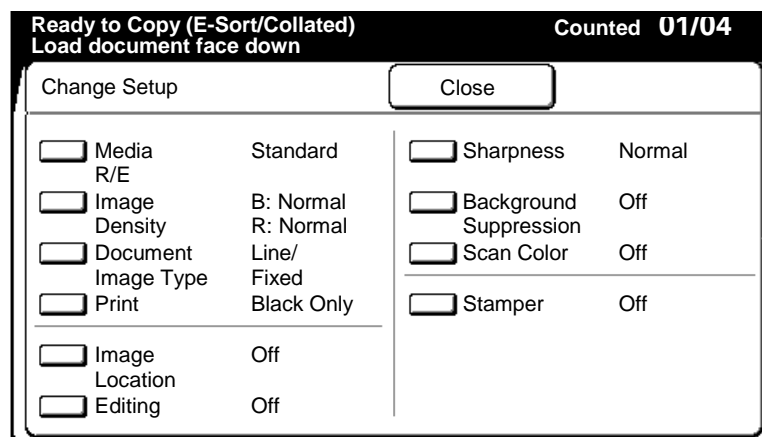

The **change setup screen** is displayed.

13. Select the desired feature you want to change.
  - The first column of text, next to the feature button, is the name of the copy feature.
  - The second column of text, displays the selected feature option.
14. When the copy feature screen is displayed, make your changes. Select **done** to return to the change setup screen.

The **change setup screen** is displayed.

## With the manual feed tray (continued)

Ready to Copy (E-Sort/Collated)		Counted 01/04	
Load document face down			
Change Setup		Close	
<input type="checkbox"/> Media R/E	Standard	<input type="checkbox"/> Sharpness	Normal
<input type="checkbox"/> Image Density	B: Normal R: Normal	<input type="checkbox"/> Background Suppression	Off
<input type="checkbox"/> Document Image Type	Line/ Fixed	<input type="checkbox"/> Scan Color	Off
<input type="checkbox"/> Print	Black Only	<input type="checkbox"/> Stamper	Off
<input type="checkbox"/> Image Location	Off		
<input type="checkbox"/> Editing	Off		

15. If additional changes are required for the scanned document, repeat steps 13 and 14.

When all feature changes are complete for the scanned document, select the **close button** and go to step 5.

## Basic touch screen features

The **basic features** provide access to the most common copy features used.

### Procedure

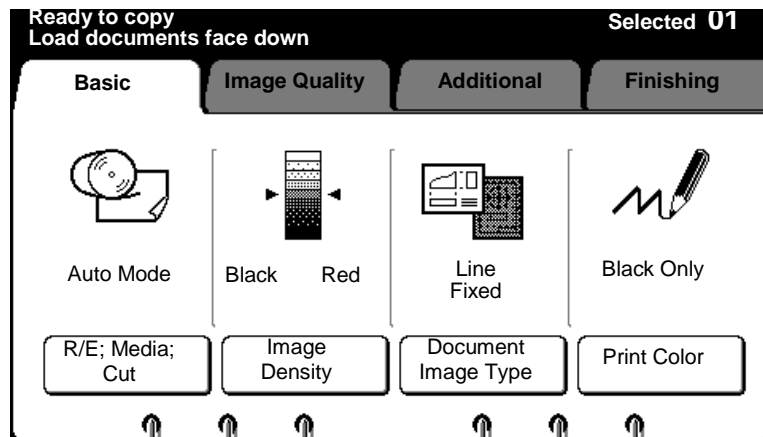

Procedure to access the basic feature group screen:

1. Select the **basic** feature group tab.  
The **basic feature group screen** is displayed.
2. Go to the desired selection.
  - **Media cut mode**, (when in auto mode and synchronized cut mode is enabled), go to page 69.
  - **R/E; media; cut**, page 69.
  - **Image density**, page 87.
  - **Document image type**, page 88.
  - **Print color**, page 90.

# Media cut mode

## Introduction

When in auto mode you can choose synchronize cut by enabling the auto mode –synchronized media cut default, in **Custom Presets** (page 192). Synchronize cuts roll media to the length of the original up to 19.8 feet (6 m) long.

1. Select **media cut mode**.

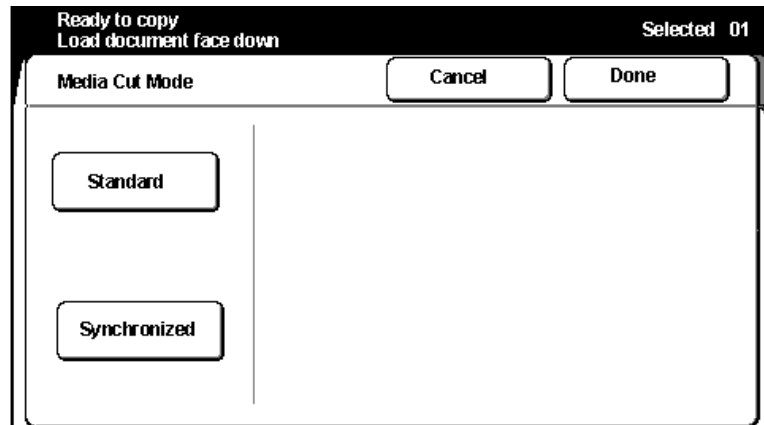

2. Select **Synchronized**.

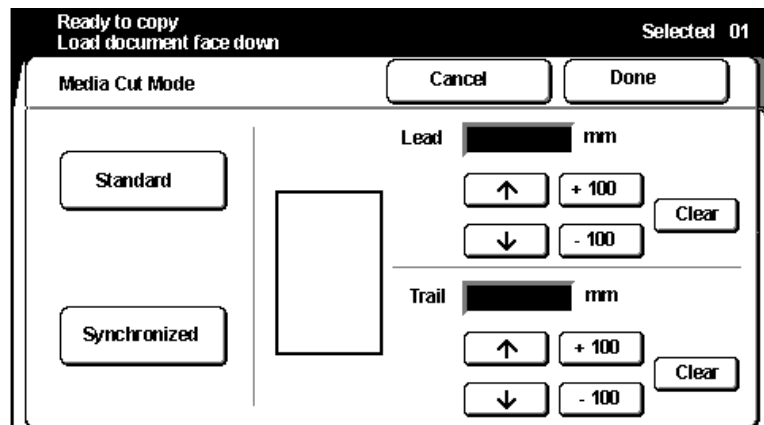

3. If needed, you can add up to 999 mm or remove up to 90 mm to the trail or lead edge margin. Use the **arrow** buttons or **±100** buttons to enter the desired measurement. Select **clear** to clear wrong data.
4. Select **done**.

# R/E; media; cut

## Introduction

When the R/E; media cut mode screen is displayed the following manual mode features are available to you:

- **Manual 100%** - copy at 100%
- **Manual R/E** – reduce or enlarge your copies using normal R/E, R/E by L&W, or R/E calculate. These features allow you to reduce or enlarge copies from 25 to 400%.
- **Cut roll media** – use one of the cut modes; standard, synchronized, long copy or variable length
- **Manual feed tray** – enables the manual feed tray mode, refer to 64.

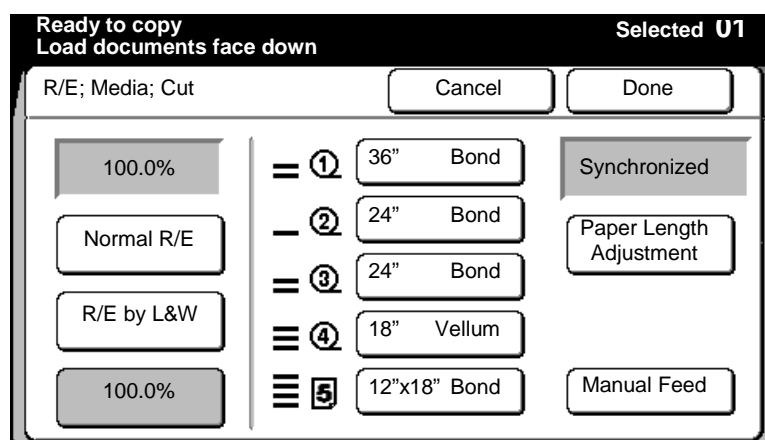

Option	Function
<b>Normal R/E</b>	One of six preset percentages may be selected, or any percentage within the available range may be entered. Refer to page 71.
<b>R/E by L&amp;W</b>	Two percentages may be selected, one for the length and one for the width. Refer to page 73.
<b>R/E calculator</b>	The percentage is automatically calculated based on the document and copy size. There are two calculators available, one for normal R/E and one for R/E by L&W (for manual mode). <ul style="list-style-type: none"> <li>• To refer to the normal R/E calculator, refer to page 75.</li> <li>• To refer to the R/E by L&amp;W calculator, refer to page 77.</li> </ul>
<b>Paper length adjustment</b>	The paper length adjustment feature has four cut options; standard, synchronized, long copy and variable length. Refer to page 79.
<b>Manual feed</b>	Select the <b>manual feed button</b> when you need to use the manual feed tray. For detailed information on how make copies from the manual feed tray, refer to page 70.



## R/E; media; cut (continued)

### Normal R/E

#### Introduction

One of six preset percentages may be selected, or any percentage within the available range may be entered. The **normal R/E feature** reduces or enlarges copies, in  $\pm 0.1\%$  increments from 25 to 400%.

For detailed information on how to change the default presets, refer to page 194.

#### Procedure

1. Select the **basic** feature group tab. If needed, refer to page 68.
2. Select the **R/E; media; cut button**, on the basic screen.

The **R/E; media; cut screen** is displayed.

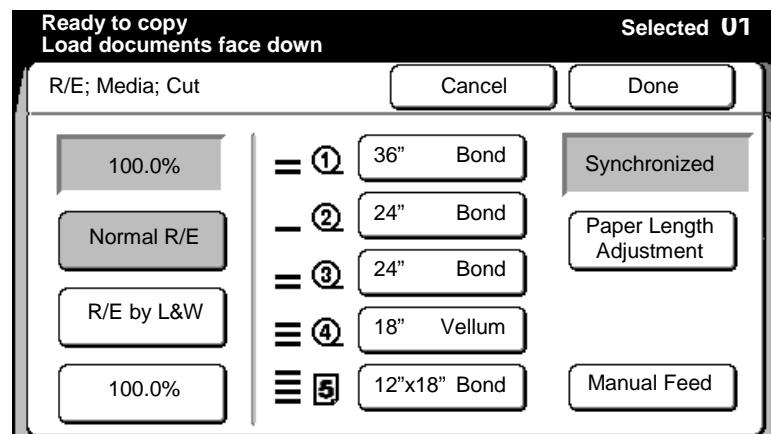

3. Select **normal R/E**.

The **normal R/E screen** is displayed.

### Normal R/E (continued)

---

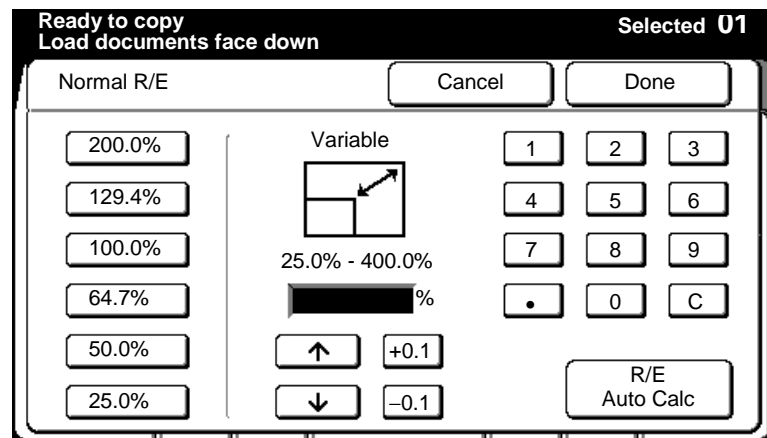

4. Select the desired preset percentage.
  - If the percentage you desire is not a shown, enter the desired percentage using the numeric keypad (on the screen) or select the **up** or **down arrow buttons**.
  - To clear wrong data select the **C button** on the touch screen.
  - Select  $\pm 0.1$ , to increase or decrease the percentage in  $\pm 0.1\%$  increments.

To cancel the changes and exit from this screen, select **cancel**.

5. Insert the document to make copies, or select **done** as required to select more features.

## R/E; media; cut (continued)

### R/E by L&W

#### Introduction

The **R/E by L&W feature** reduces or enlarges copies, from the desired length and width percentages you enter. You can reduce or enlarge the length and width of your copies, in  $\pm 0.1\%$  increments, from 25 to 400%.

#### Procedure

1. Select the **basic** feature group tab. If needed, refer to page 68.
2. Select the **R/E; media; cut button**, on the basic screen.

The **R/E; media; cut screen** is displayed.

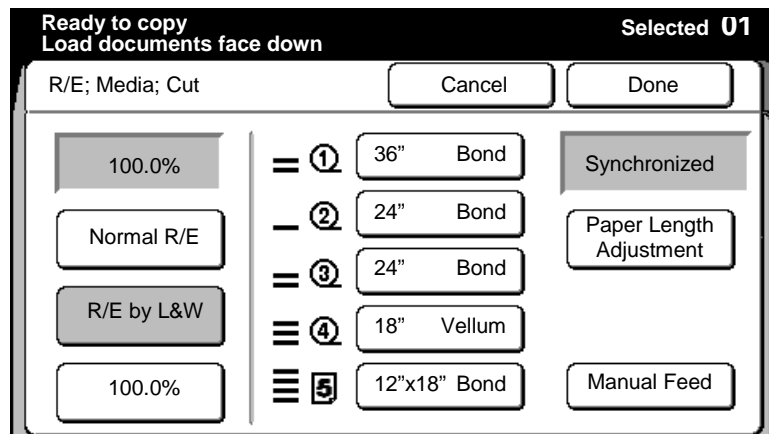

3. Select **R/E by L&W**.

The **R/E by L&W screen** is displayed.

### R/E by L&W (continued)

---

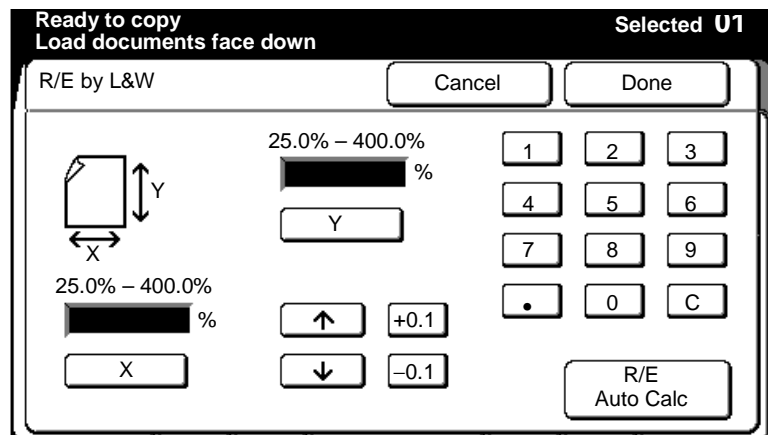

Use the touch screen keypad to enter data and select the **C** button to clear wrong data.

4. Select **X** and enter the desired width percent.
5. Select **Y** and enter the desired length percent.

To cancel the changes and exit from this screen, select **cancel**.

6. Insert the document to make copies, or select **done** as required to select more features.

## R/E; media; cut (continued)

### Normal R/E calculator

#### Introduction

The **normal R/E calculator feature** calculates the copy percentage automatically based on the document length and the required copy size length.

#### Procedure

1. Select the **basic** feature group tab. If needed, refer to page 68.
2. Select the **R/E; media; cut button**, on the basic screen.

The **R/E; media; cut screen** is displayed.

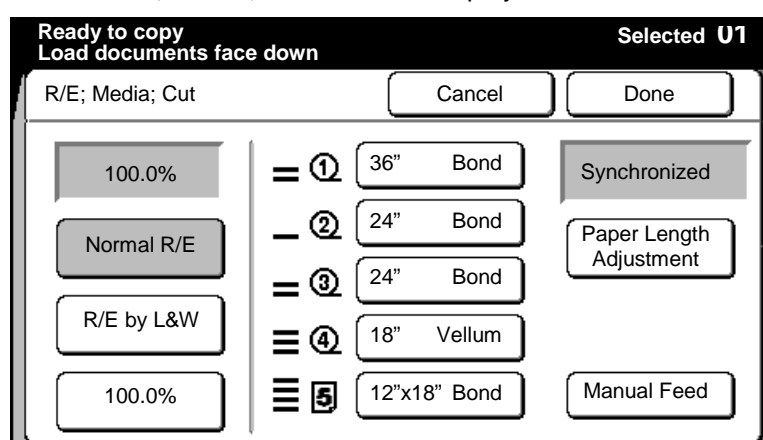

3. Select **normal R/E**.

The **normal R/E screen** is displayed.

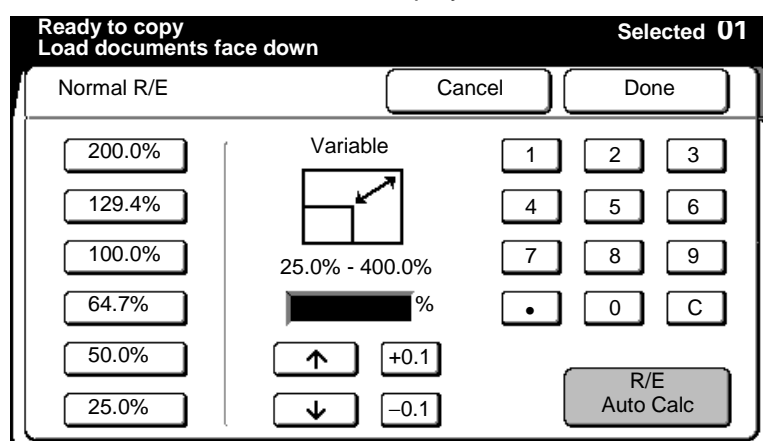

4. Select **R/E auto calc**.

The **R/E auto calculate screen** is displayed.

### Normal R/E calculator (continued)

---

The screenshot shows a touch screen interface for an R/E calculator. At the top, it says "Enter document length from the numeric pad" and "Press [Scroll]". The screen is titled "R/E Auto Calc" and has "Selected U1" in the top right corner. There are two buttons at the top: "Cancel" and "Done". The main area has three input fields: "Reduce/Enlarge" with a value of "100 %", "Document Length" with a value of "mm", and "Required Copy Length" with a value of "mm". To the right of these fields is a numeric keypad with buttons for digits 1-9, 0, and a "C" button. Below the keypad is a "Scroll" button.

Use the touch screen keypad to enter data and select the **C button** to clear wrong data.

5. Enter the document length.
6. Select **scroll** and move to the required copy length field.
7. Enter the required copy length.
8. Select **scroll**.

The reduce/enlarge field displays the new percentage.

To cancel the changes and exit from this screen, select **cancel**.

9. Insert the document to make copies, or select **done** as required to select additional features.

## R/E; media; cut (continued)

### R/E by L&W calculator

#### Introduction

The **R/E by L&W calculator feature** calculates the copy percentage automatically based on the document length and width and the required copy size length and width.

#### Procedure

1. Select the **basic** feature group tab. If needed, refer to page 68.
2. Select the **R/E; media; cut button**, on the basic screen.

The **R/E; media; cut screen** is displayed.

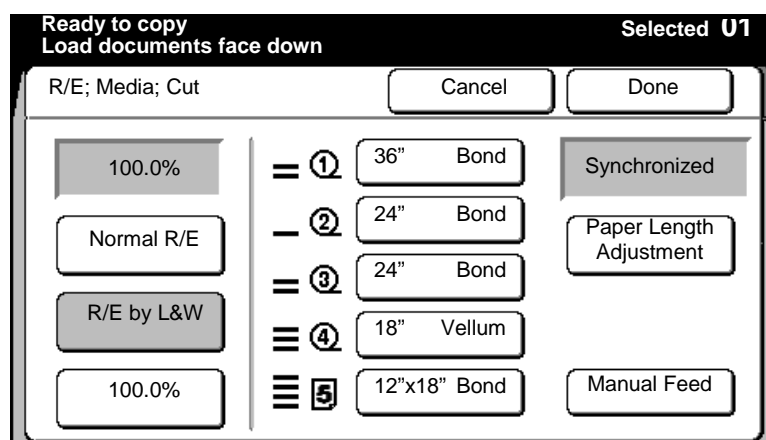

3. Select **R/E by L&W**.

The **R/E by L&W screen** is displayed.

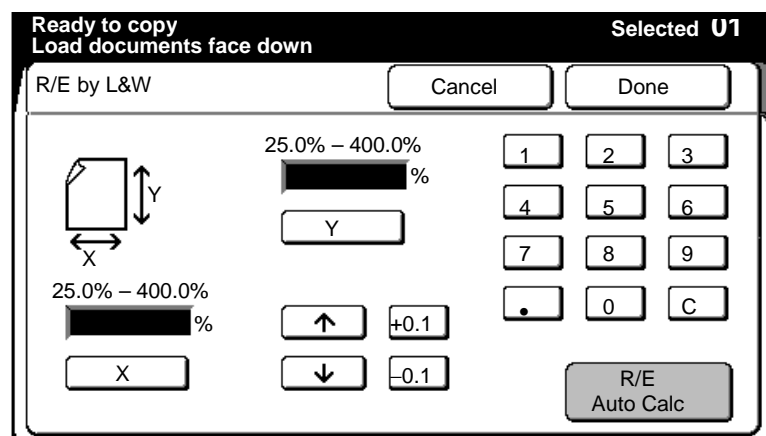

4. Select **R/E auto calc**.

The **R/E auto calculate (L& W) screen** is displayed.

### R/E by L&W calculator (continued)

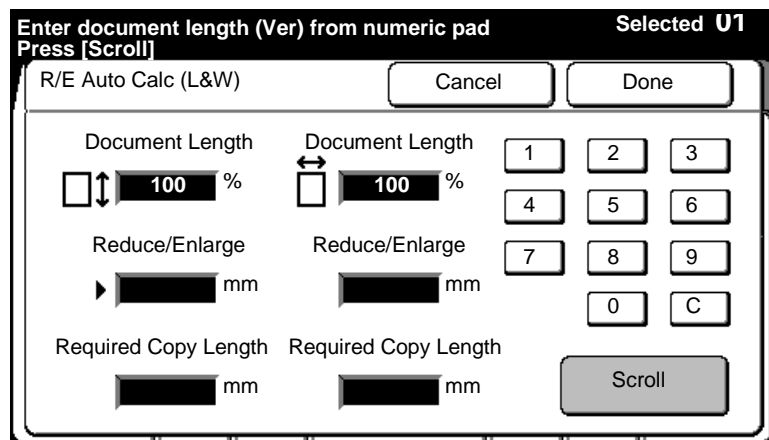



Select **scroll**, to move to the desired fields.

Use the touch screen keypad to enter data and select the **C** button to clear wrong data.

5. Enter the desired reduce/enlarge measurement.  

6. Enter the required copy length.  

7. Enter the desired reduce/enlarge measurement.  

8. Enter the required copy length (width).  

9. Select **scroll**.

- The calculated percentages are displayed in the document length fields.

To cancel the changes and exit from this screen, select **cancel**.

10. Insert the document to make copies, or select the **done** as required to select additional features.



### Paper length adjustment

---



*Note: The paper length adjustment button is only available if roll media is selected on the R/E; media; cut screen.*

#### Introduction

**Paper length adjustment feature** provides four cut options for manual mode; standard, synchronized, long copy and variable length.

Option	Function
<b>Standard</b>	Cuts roll media to standard and special size lengths. For detailed information about the standard sizes, refer to page 56. MAX 200 nonstandard size is 30 x 42 inch.
<b>Synchronized</b>	Cuts roll media to the length of the original up to 19.8 feet (6 m). Refer to page 81.  For detailed information on how to set the custom presets default for the lead and trail edge margins for synchronized, refer to page 216.
<b>Long copy</b>	Cuts roll media for to the length of original, when the original is greater than 19.8 feet (6m), refer to page 83.  For detailed information on how to set the custom presets default for the lead and trail edge margins for long copy, refer to page 216.
<b>Variable length</b>	Operator specifies the media cut length. Refer to page 85.  For detailed information on how to set the custom presets default for each roll, refer to page 218.

## R/E; media; cut (continued)

### Paper length adjustment (continued)

#### Standard

##### Procedure

1. Select the **basic** feature group tab. If needed, refer to page 68.
2. Select the **R/E; media; cut button**, on the basic screen.

The **R/E; media; cut screen** is displayed.

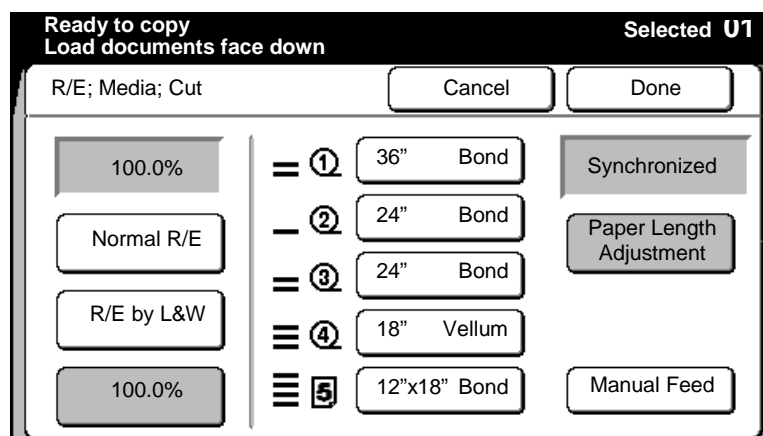

3. Select **paper length adjustment**.

The **paper length adjustment screen** is displayed.

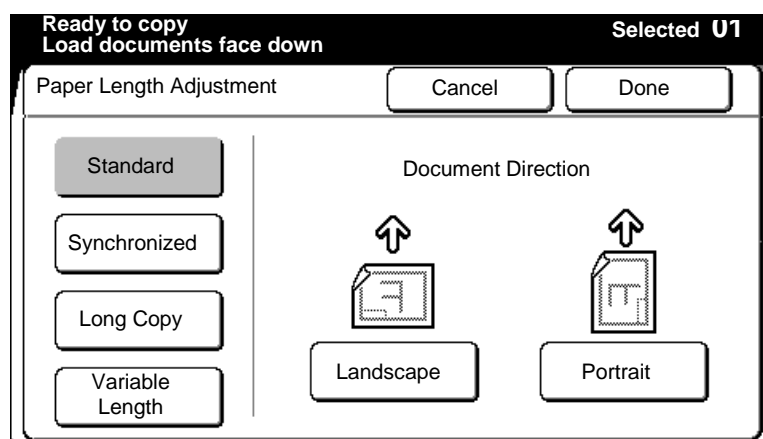

4. Select **standard**.

## R/E; media; cut (continued)

---

### Paper length adjustment (continued)

---

#### Standard (continued)

---

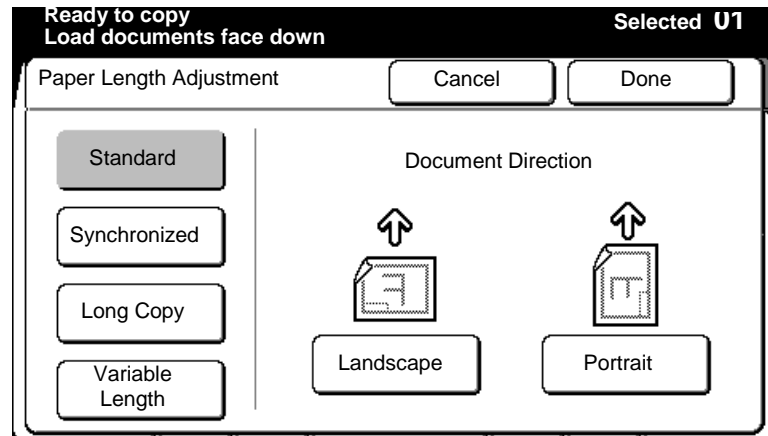

5. Select the desired document direction, **landscape** or **portrait**.
  - For example: When A0 width roll media is selected, choose: Portrait to make A0-size copies. Landscape to make A1-size copies.

To cancel the changes and exit from this screen, select **cancel**.

6. Insert the document to make copies, or select **done** as required to select additional features.

#### Synchronized

---



*Note: The **synchronized** option can be selected with magnification. The width of document does not have to be the same as the media width.*

#### Procedure

1. Select the **basic** feature group tab. If needed, refer to page 68.
2. Select the **R/E; media; cut button**, on the basic screen.

The **R/E; media; cut screen** is displayed.

## Paper length adjustment (continued)

### Synchronized (continued)

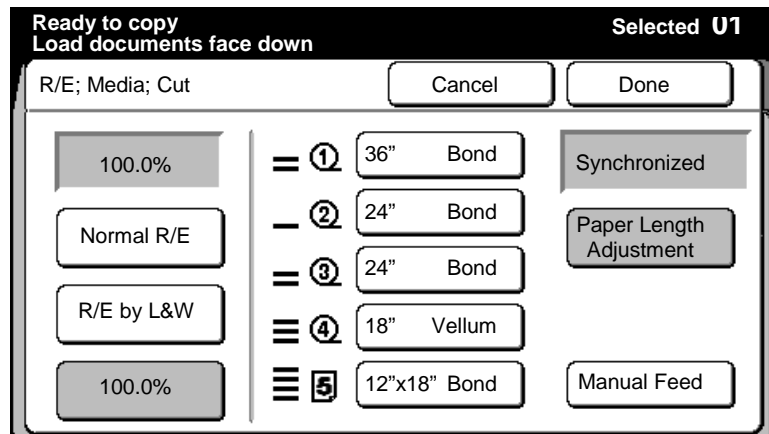

3. Select **paper length adjustment**.

The **paper length adjustment screen** is displayed.

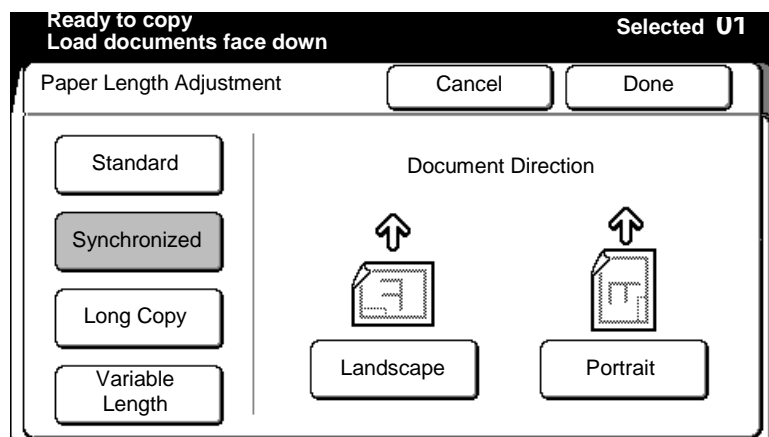

4. Select **synchronized**.

The second **paper length adjustment screen** is displayed.

## R/E; media; cut (continued)

### Paper length adjustment (continued)

#### Synchronized (continued)

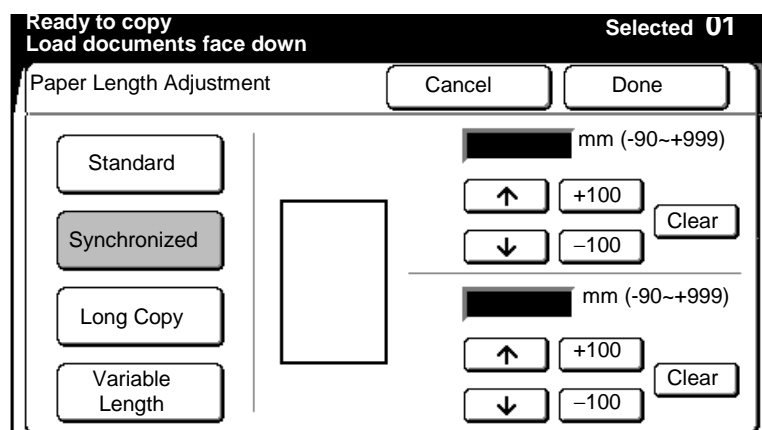

- Adjust the margins as desired, using the **arrow** or the **± 100 buttons**. To clear wrong data, select **clear**.
  - You can add up to 999 mm to the lead or trail edge margin or remove up to 90 mm from the lead or trail edge margin.To cancel the changes and exit from this screen, select **cancel**.
- Insert the document to make copies, or select **done** as required to select additional features.

#### Long copy

##### Procedure

- Select the **basic** feature group tab. If needed, refer to page 68.
- Select the **R/E; media; cut button**, on the basic screen.

The **R/E; media; cut screen** is displayed.

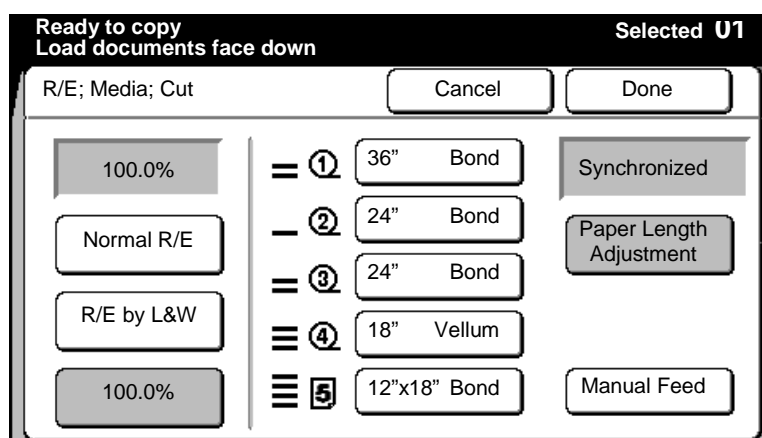

- Select **paper length adjustment**.

The **paper length adjustment screen** is displayed.

### Paper length adjustment (continued)

#### Long copy (continued)

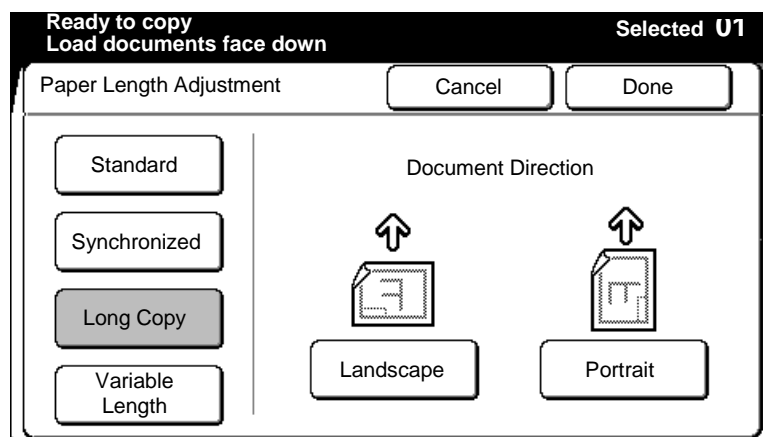

4. Select **long copy**.

The **second paper length adjustment screen** is displayed.

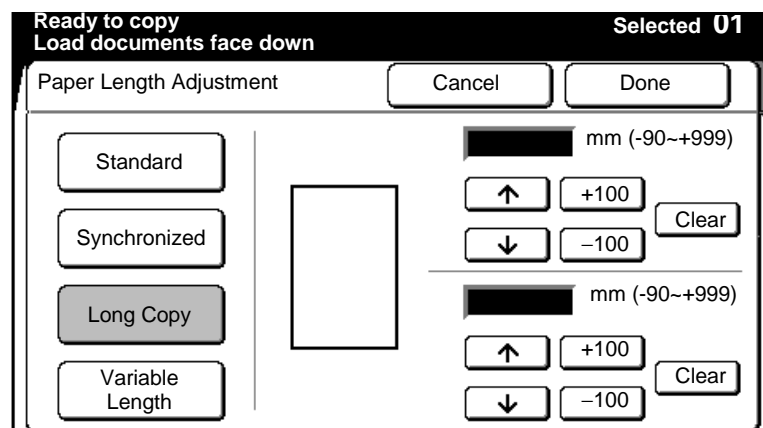

5. Adjust the margins as desired, using the **arrow** or the **± 100 buttons**. To clear wrong data, select **clear**.

- You can add up to 999 mm to the lead or trail edge margin or remove up to 90 mm from the lead or trail edge margin.

To cancel the changes and exit from this screen, select **cancel**.

6. Insert the document to make copies, or select **done** as required to select additional features.

## R/E; media; cut (continued)

### Paper length adjustment (continued)

#### Variable length

##### Procedure

1. Select the **basic** feature group tab. If needed, refer to page 68.
2. Select the **R/E; media; cut button**, on the basic screen.

The **R/E; media; cut screen** is displayed.

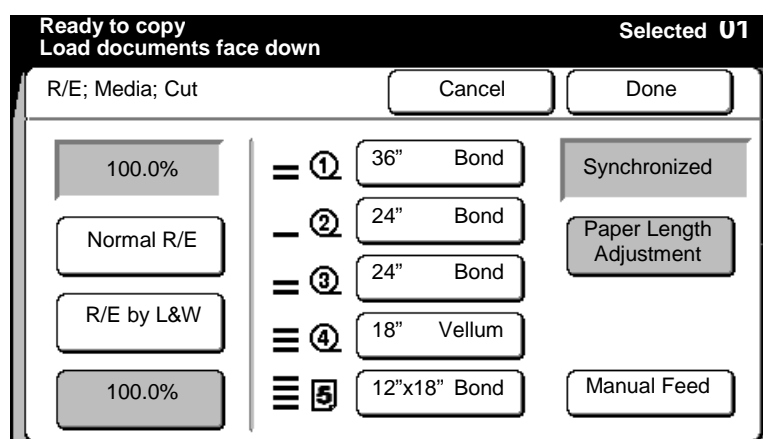

3. Select **paper length adjustment**.

The **paper length adjustment screen** is displayed.

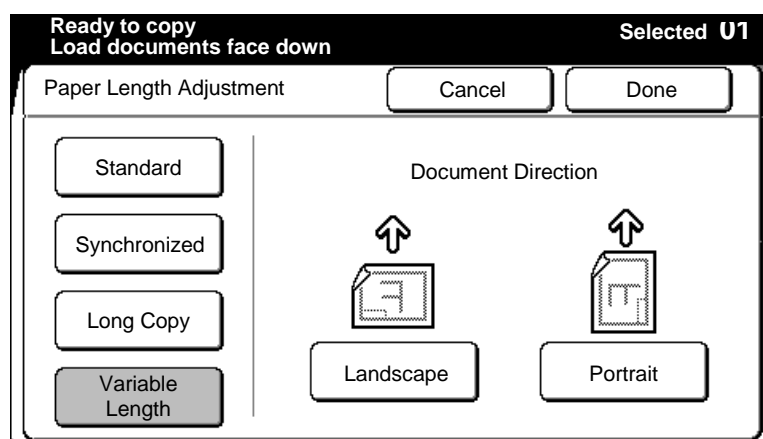

4. Select **variable length**.

The second **paper length adjustment screen** is displayed.

### Paper length adjustment (continued)

---

#### Variable length (continued)

---

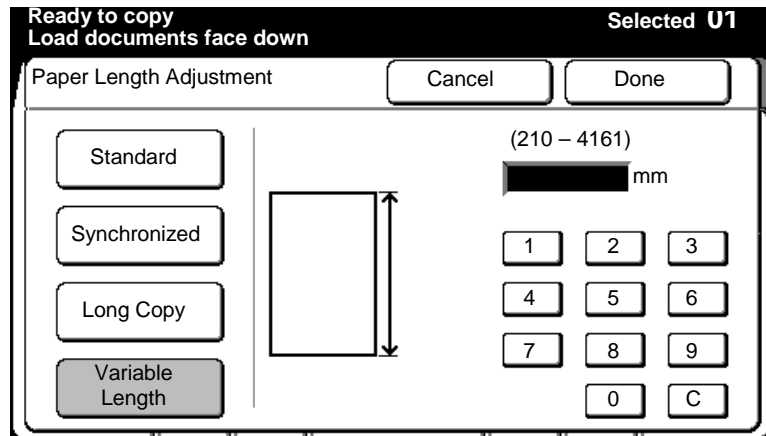

5. Set the length of the copy (210 – 4161 mm), using the touch screen keypad and select the **C button** to clear wrong data.  
To cancel the changes and exit from this screen, select **cancel**.
6. Insert the document to make copies, or select **done** as required to select additional features.



# Image density

## Introduction

The **image density feature** allows you to make adjustments to the colors red and black on your copies. Each color can be adjusted separately. Typically if the original is very light, you will want to change the density too darker.

## Procedure

1. Select the **basic** feature group tab. If needed, refer to page 68.
2. Select the **image density button**, on the basic screen.

The **image density screen** is displayed.

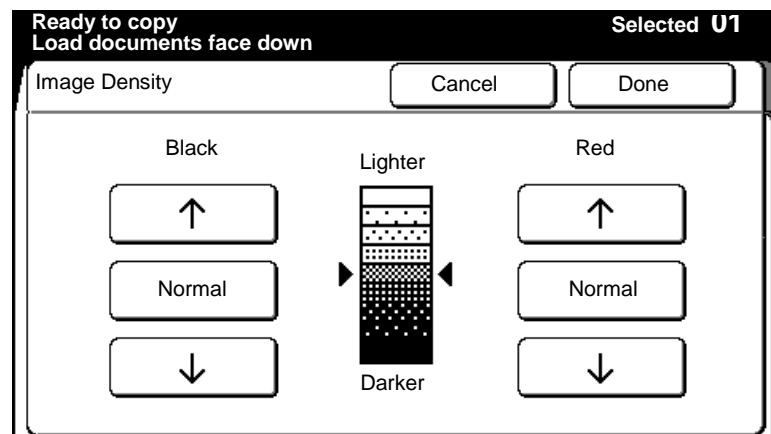

3. Adjust the black and red density levels to meet your specific needs.

To increase density, select the **down arrow**. To decrease density, select the **up arrow**. To return to normal, select the **normal button**.

To cancel the changes and exit from this screen, select **cancel**.

4. Insert the document to make copies, or select **done** as required to select additional features.

# Document image type

## Introduction

The **document image type** screen contains two features, document image type and background suppression.

To ensure excellent copy quality, it is good practice to select the best document image type that matches your document.

You can also suppress any unwanted background on your document with the background suppression feature.

Feature	Function
<b>Document image type</b>	There are six document type options, line, picture, line/picture, photo, low contrast and dark. The machines image quality components are automatically calibrated to ensure proper copy quality
<b>Background suppression</b>	The background suppression feature allows you to suppress unwanted background on documents. There are two background suppression options; fixed and variable.

## Procedure

1. Select the **basic** feature group tab. If needed, refer to page 68.
2. Select the **document image type button**, on the basic screen.

The **document image type screen** is displayed.

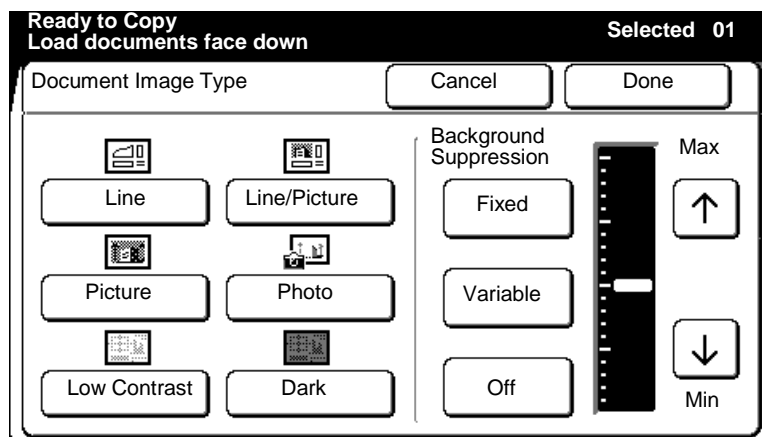

## Document image type (continued)

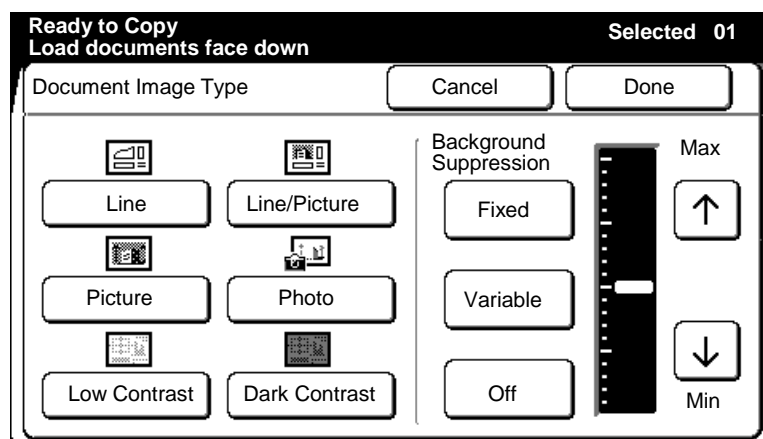

3. Select the document image type that best matches your document.

<b>Line</b>	Select when the original contains lines and text images.
<b>Picture</b>	Select when the original contains dot matrix images (like newspaper, posters, or copy of photographs).
<b>Line/picture</b>	Select when the original contains text/lines and dot matrix images or halftone images.
<b>Photo</b>	Select when the original contains pure glossy image.
<b>Low contrast</b>	Select when the original contains pencil writing.
<b>Dark contrast</b>	Select when the original contains a dark background (negatives, blueprints, sepias, diazo).

4. Select the desired background suppression. If needed, select the **arrow buttons** to further adjust the background suppression level.

<b>Fixed</b>	Select fixed when the background is uniform. Examples include diazo paper, newspaper, and colored paper.
<b>Variable</b>	Select variable when the background is not uniform. For example the document background has light and dark areas.
<b>Off</b>	Background suppress feature is off.

To cancel the changes and exit from this screen, select **cancel**.

5. Insert the document to make copies, or select **done** as required to select additional features.

# Print color

## Introduction

The **print color feature** allows you to select a specific color for print. There are three options available.

Option	Function
<b>Red only</b>	Prints all in red. Refer to the one color procedure, on page 90.
<b>Black only</b>	Prints all in black. Refer to the one color procedure, on page 90.
<b>Red/black</b>	Prints in red and black. Operator specifies the colors the machine recognizes to be printed in red. Refer to the two color procedure, on page 91.

## One color (black or red)

## Procedure

1. Select the **basic** feature group tab. If needed, refer to page 68.
2. Select the **print color button**, on the basic screen.

The **print color screen** is displayed.

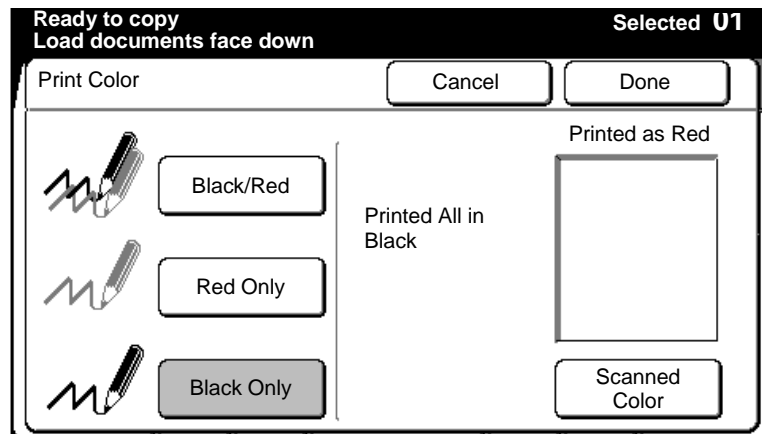

3. Select **black only** or **red only**.  
To cancel the changes and exit from this screen, select **cancel**.
4. Insert the document to make copies, or select **done** as required to select additional features.

## Print color (continued)

### Two color (black and red)



*Note: This option is automatically enabled, if you set any of the copy features to recognize a specific color on your document to be printed red.*

#### Procedure

1. Select the **basic** feature group tab. If needed, refer to page 68.
2. Select the **print color button**, on the basic screen.

The **print color screen** is displayed.

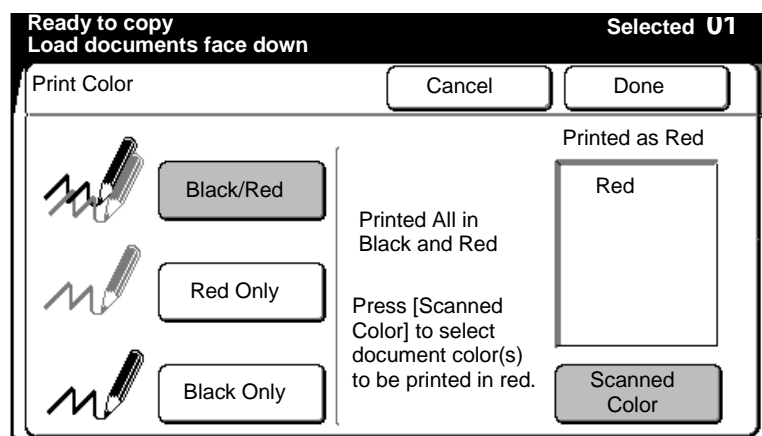

3. Select **black/red**.
4. Select **scanner color** (specifies the color on the document to be printed in red).

The **scanned color screen** is displayed.

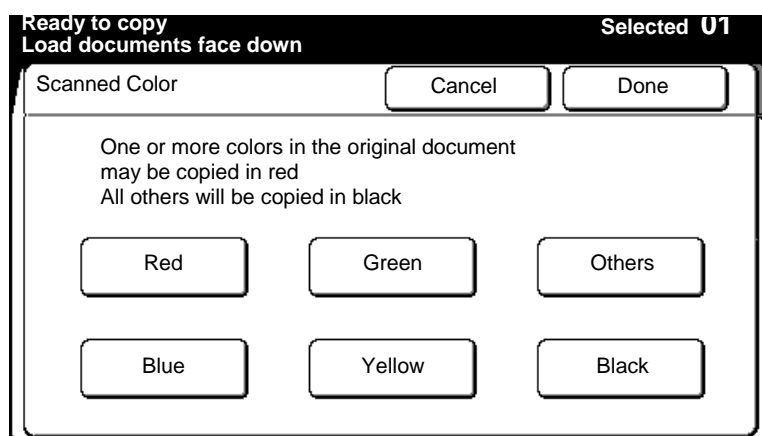

5. Select the desired colors, to be copied in red. To cancel a color selection, press the same color button again.
  - Multiply colors can be selected.
  - Others specify colors other than red, blue, green, yellow, and black.

To cancel the changes and exit from this screen, select **cancel**.

6. Insert the document to make copies, or select **done** as required to select additional features.

---

## Image quality touch screen features

---

The **image quality touch features** allow you to adjust the copy quality.

### Procedure

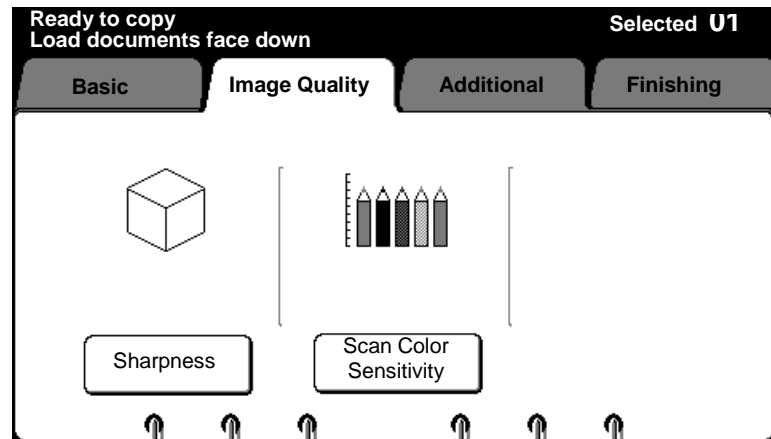

Procedure to access the image quality feature group screen:

1. Select the **image quality** feature group tab.  
The **image quality feature group screen** is displayed.
2. Go to the desired selection.
  - **Sharpness**, page 93.
  - **Scan color sensitivity**, page 94.

# Sharpness

## Introduction

The **sharpness feature** adjusts the image edge sharpness of the copy. There are three options; maximum, normal and minimum.

Option	Function
<b>Maximum</b>	Select to achieve maximum sharpness.
<b>Normal</b>	Select to achieve normal sharpness.
<b>Minimum</b>	Select to achieve minimum sharpness.

## Procedure

1. Select the **image quality** feature group tab. If needed, refer to page 92.
2. Select the **sharpness button**, on the image quality screen.

The **sharpness screen** is displayed.

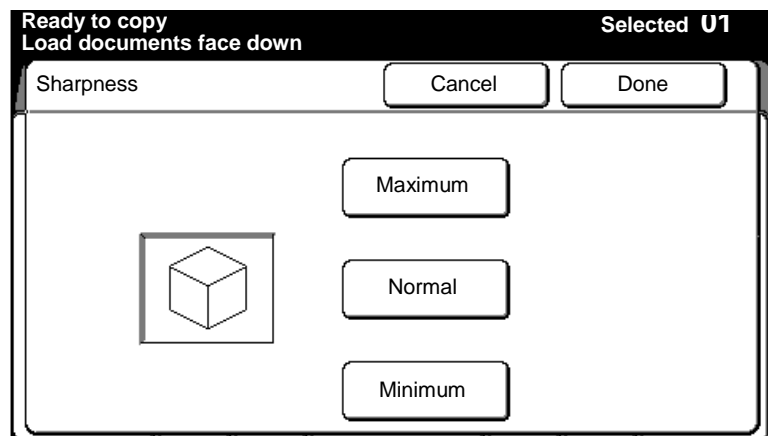

3. Select the desired sharpness; **maximum**, **normal** or **minimum**.  
To cancel the changes and exit from this screen, select **cancel**.
4. Insert the document to make copies, or select **done** as required to select additional features.

# Scan color sensitivity

## Introduction

The **scan color sensitivity feature** increases or decreases the density for each selected color, on the copy.

For example, the map you want to copy has areas in blue that you want to appear darker on the copy. Select **dark blue** on the scanner color sensitivity screen. The blue areas on your copies are printed darker.

## Procedure

1. Select the **image quality** feature group tab. If needed, refer to page 92.

2. Select the **scanner sensitivity button**, on the basic screen.

The **scanner sensitivity screen** is displayed.

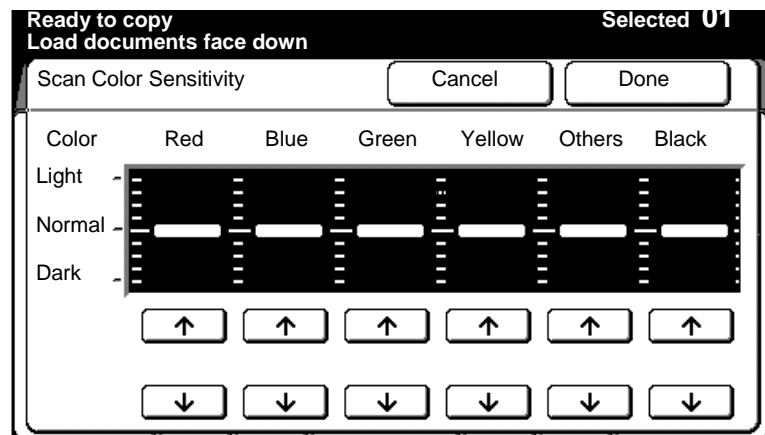

3. Select an **arrow button** to adjust desired color.

- Others specify colors other than red, blue, green, yellow, and black.

To cancel the changes and exit from this screen, select **cancel**.

4. Insert the document to make copies, or select **done** as required to select additional features.



## Additional touch screen features

The **additional features** allow you to change the image location or edit your document.

### Procedure

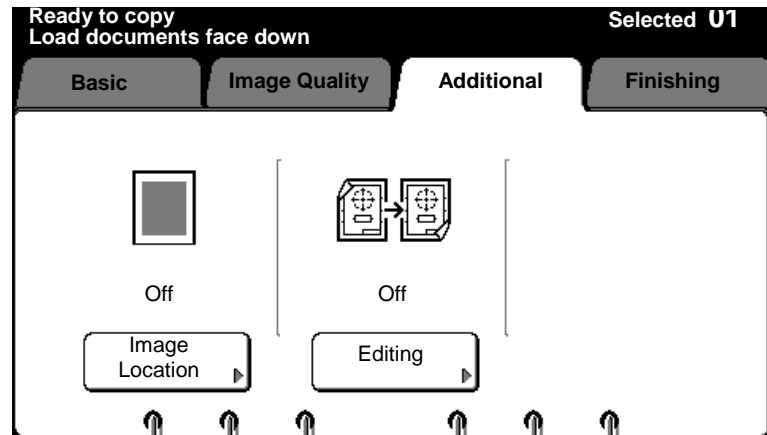

*Note: The text above each selection button provides the status of each feature.*

Procedure to access the additional feature group screen:

1. Select the **additional** feature group tab.  
The **additional feature group screen** is displayed.
2. Go to the desired selection.
  - **Image location**, page 96.
  - **Editing**, page 97.

# Image location

## Introduction

The **image location feature** shifts the image up, down or to the right in 1-mm increments up to 30 mm.

The image cannot be shifted to the left (the left arrow button is always disabled). If you copy requires a left margin, shift the image to the right.



*Note: If needed, you can shift your original to the left by moving the document guides, on the scanner.*

## Procedure

1. Select the **additional** feature group tab. If needed, refer to page 95.
2. Select the **image location button**, on the basic screen.

The **image location screen** is displayed.

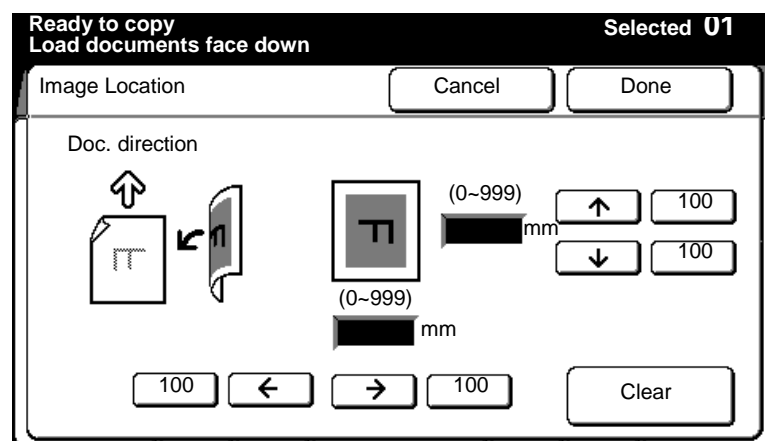

3. Select the **top** or **bottom arrow buttons** to shift the image up or down. If needed, select the **100 buttons** to shift the image in 100 increments.
4. Select the **right arrow button** to shift the image to the right. If needed, select the **100 button** to shift the image in 100 increments.

Select **clear** to set the values to 0.

To cancel the changes and exit from this screen, select **cancel**.

5. Insert the document to make copies, or select **done** as required to select additional features.

# Editing

## Introduction

The MAX 200 provides two edit configurations; basic and full. When the optional editing kit is installed, your machine is equipped with the full configuration.

- If your machine is not equipped with the editing kit, the MAX 200 allows access to the **basic edit features only**. All basic edit features are identified with the word basic next to the feature.
- If your machine is equipped with the optional edit kit, the MAX 200 allows access to all edit features.

The screen below, is the editing screen. It is displayed when you select the **editing button**, on the **additional feature group tab**.

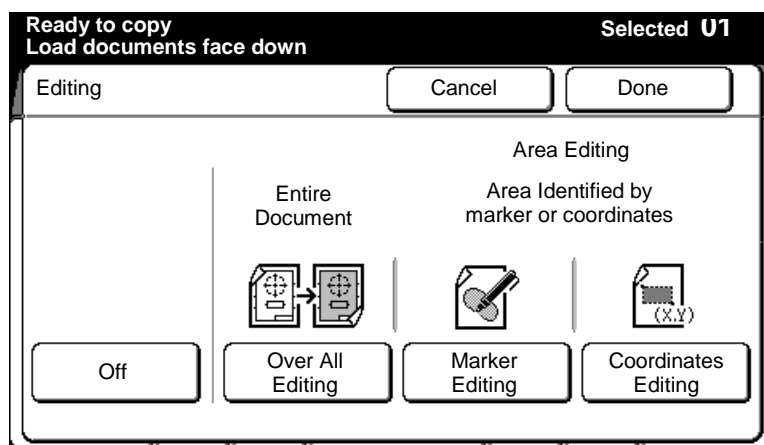

Feature	Function
<b>Overall editing</b>	Allows you to edit the entire document. Refer to page 98.
<b>Marker editing</b>	Allows you to specify the edit area, with a marker. You can define multiple edit areas on your document. Refer to page 107.
<b>Coordinate editing</b>	Allows you to specify a single edit area with, X and Y coordinates on your document. Refer to page 119.

# Editing (continued)

## Overall editing

### Introduction

The **overall edit feature** allows you to edit the entire document. There are four overall edit options; fill, contrast reversal, mirror image, and color drop.

Option	Function
<b>Fill</b>	Lets you cover an entire document, or edit areas with a pattern. There are seven fill patterns and three levels of fill available. The fill is in black or red.
<b>Contrast reversal (basic)</b>	Prints black (or red) images on a document to be printed white and white areas to be printed in black (or red). It is useful when converting old blueprints or negatives.
<b>Mirror image</b>	Prints as the reflection of the original document.
<b>Color drop (basic)</b>	Allows you to delete select colors from the copy.

### Procedure

1. Select the **additional** feature group tab. If needed, refer to page 95.
2. Select the **editing button**, on the basic screen.  
The **editing screen** is displayed.

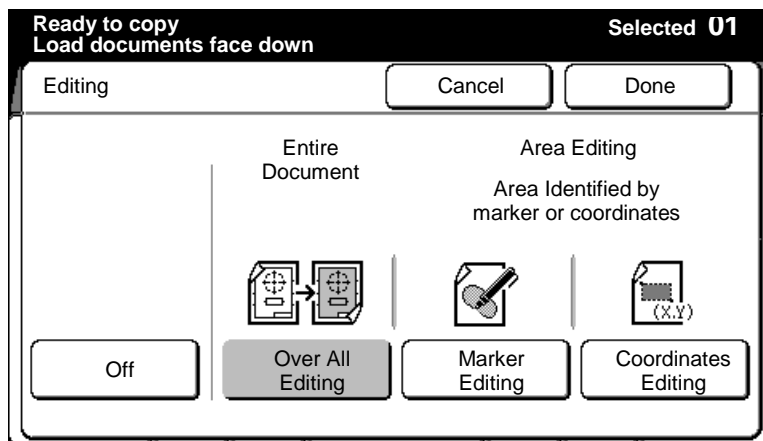

3. Select **overall editing**.  
The **overall screen** is displayed.

## Editing (continued)

---

### Overall editing (continued)

---

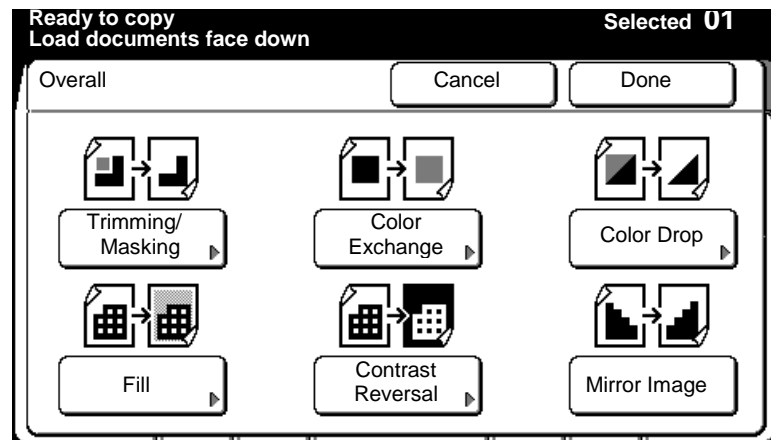

4. Go to the desired selection.
  - **Fill**, page 100.
  - **Color drop**, page 105.
  - **Contrast reversal**, page 104.
  - **Mirror image**, page 105.

## Editing (continued)

### Overall editing (continued)

#### Fill

##### Procedure

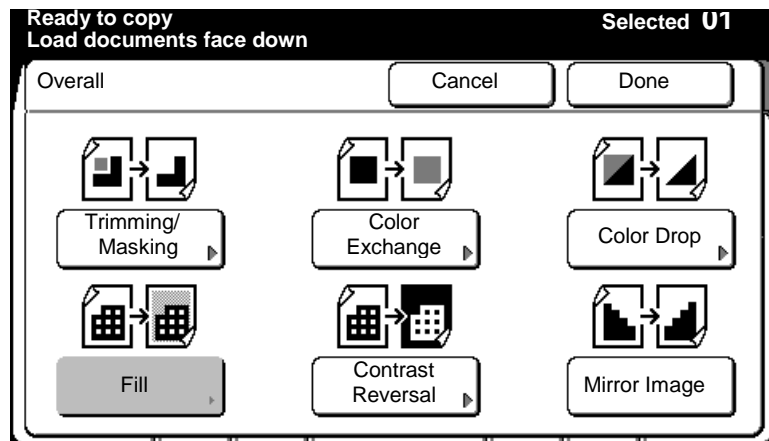

1. Select **fill**.

The **fill screen** is displayed.

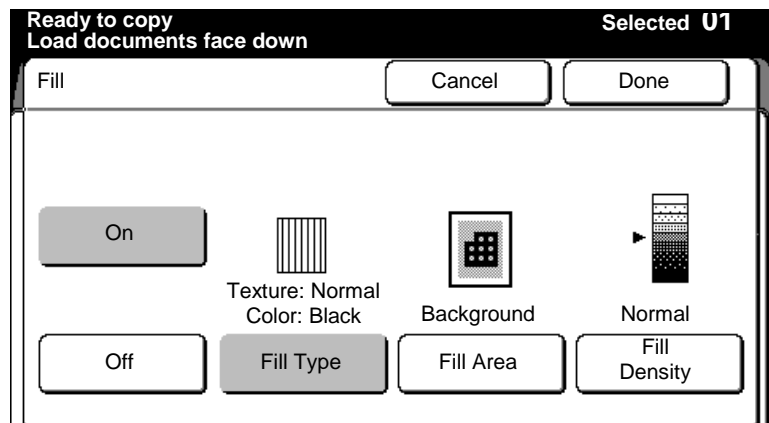

2. Select **on**.
3. Select **fill type**.

The **fill type screen** is displayed.

## Editing (continued)

### Overall editing (continued)

#### Fill (continued)

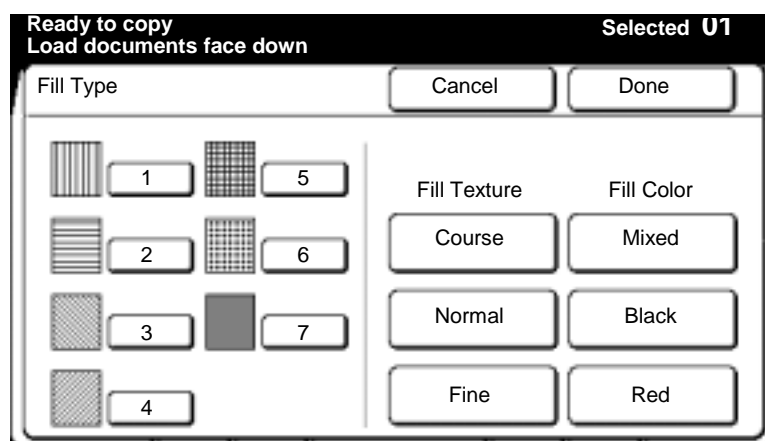

4. Select the desired fill type; **1-7**.
5. Select the desired fill texture; **course, normal** or **fine**.
6. Select the desired fill color; **mixed, black**, or **red**.



*Note: Mixed is only available with fill type 7.*

To cancel the changes and exit from this screen, select **cancel**.

7. Select **done** to save the selection.

The **fill screen** is displayed.

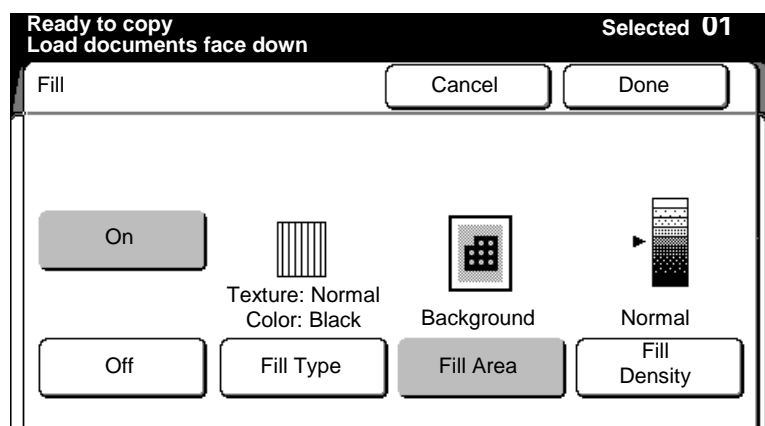

8. Select **fill area**.

The **fill area screen** is displayed.

### Overall editing (continued)

---

#### Fill (continued)

---

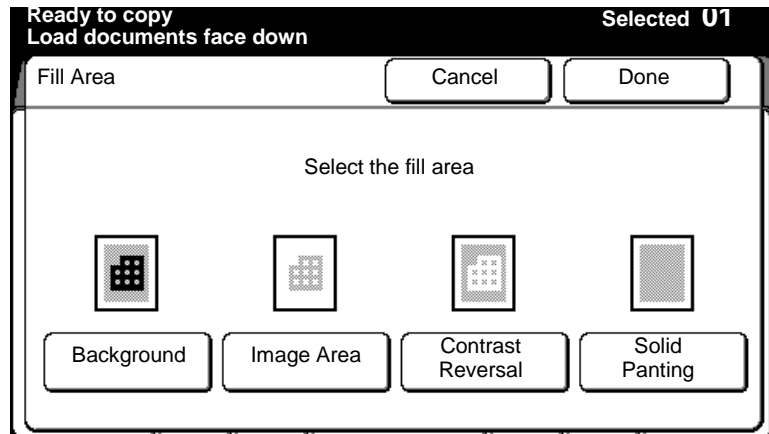

9. Select the desired fill area.

**Background** Replaces the background with the selected fill.

**Image area** Replaces the image with the selected fill.

**Contrast reversal** Prints the image areas in white and background areas are printed in the selected fill.

**Solid painting** The entire copy is printed in the selected fill.

To cancel the changes and exit from this screen, select **cancel**.

10. Select **done** to save the selection.

The **fill screen** is displayed.



## Editing (continued)

---

### Overall editing (continued)

---

#### Fill (continued)

---

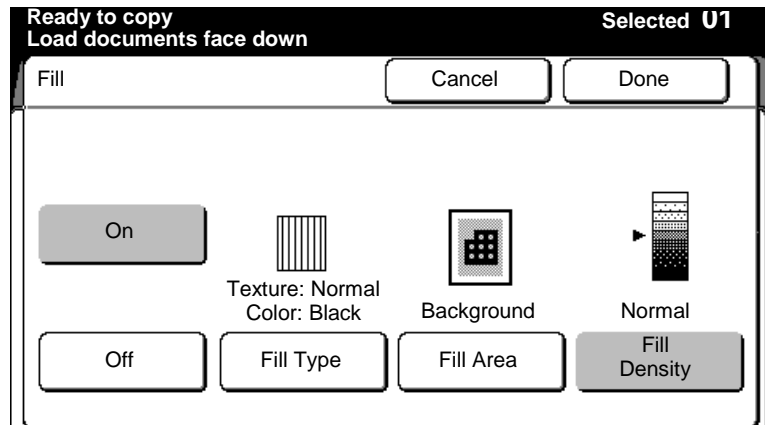

11. Select **fill density**.

The **fill density screen** is displayed.

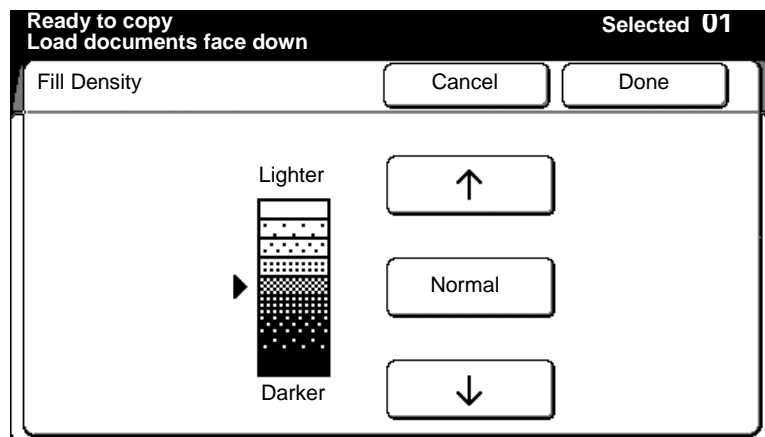

12. Adjust the density, using the **arrow buttons**. Select **normal** to return to the normal setting.

To cancel the changes and exit from this screen, select **cancel**.

13. Insert the document to make copies, or select **done** as required to select additional features.

## Editing (continued)

### Overall editing (continued)

#### Contrast reversal (basic)

##### Procedure

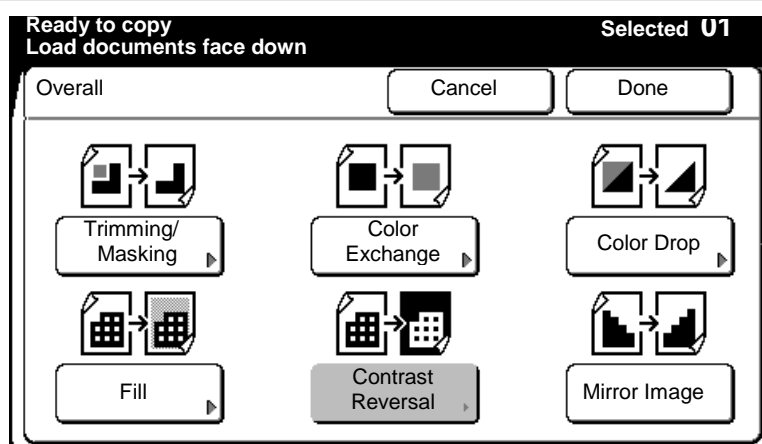

1. Select **contrast reversal**.

The **contrast reversal screen** is displayed.

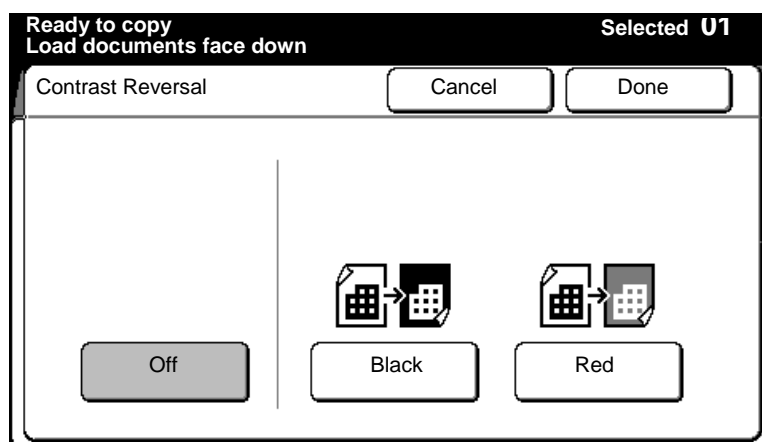

2. Select the desired color; **black** or **red**.

- If black is selected, the image is white and the background is black. If red is selected, the image is white and the background is red.



*Note: When red is selected, the machine automatically changes the print color to red/black.*

To cancel the changes and exit from this screen, select **cancel**.

3. Insert the document to make copies, or select **done** as required to select additional features.

## Editing (continued)

---

### Overall editing (continued)

---

#### Mirror image

---

##### Procedure

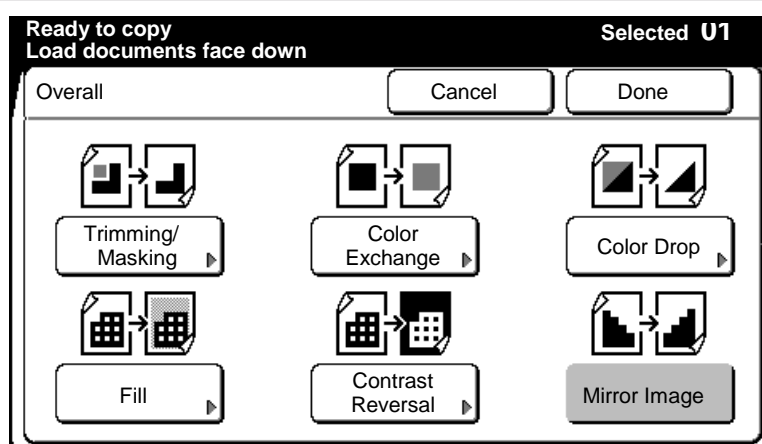

1. Select **mirror image**.  
To cancel the changes and exit from this screen, select **cancel**.
2. Insert the document to make copies, or select **done** as required to select additional features.

#### Color drop (basic)

---

##### Procedure

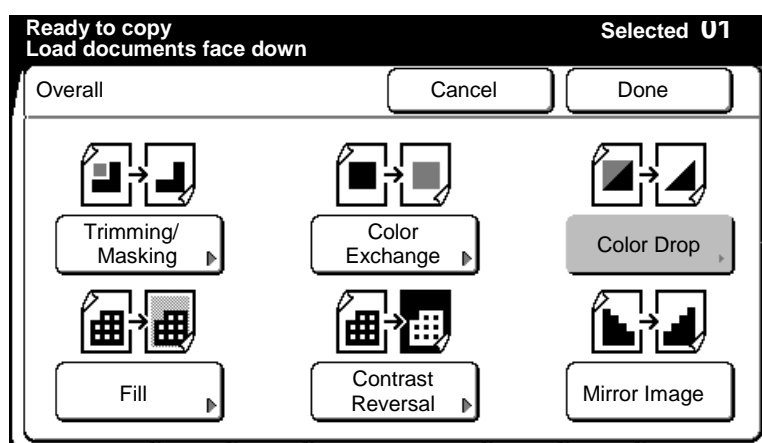

1. Select **color drop**.
2. The **color drop screen** is displayed.

## Editing (continued)

---

### Overall editing (continued)

---

#### Color drop (basic) (continued)

---

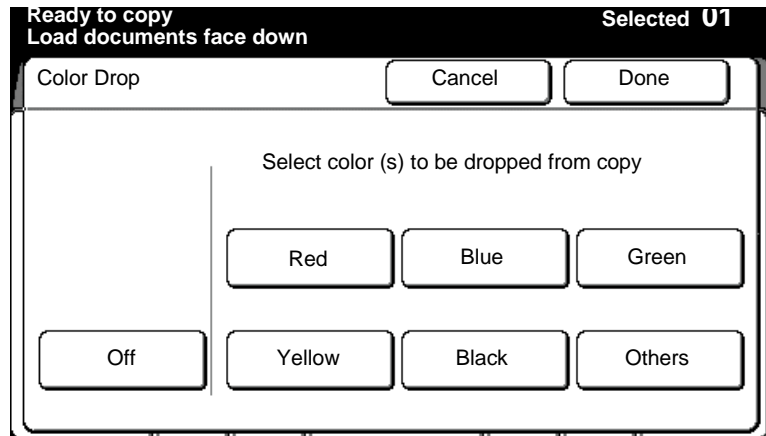

3. Select the color you want to delete; **blue**, **green**, **yellow**, **black**, or **others**.
  - Multiple colors can be selected. When others is selected, all colors except red, blue, green, yellow, and black are deleted.To cancel the changes and exit from this screen, select **cancel**.
4. Insert the document to make copies, or select **done** as required to select additional features.

## Editing (continued)

### Marker editing

#### Introduction

The **marker editing feature** applies the MAX 200 edit options to the inside or outside area that is defined on your document, with a color marker. You can define multiple edit areas with this method.

In order for the machine to recognize an area on your document, specify the area by marking your document with 4 dots (in rectangular form) or with closed area.

Once you have defined an area, you must apply the edit options to the inside or outside area of the marker. There are six marker edit options; trimming/masking, fill, contrast reversal, mirror image, color drop, and color exchange.

The method used to mark your document (4 dots or closed area) and the selection of inside or outside edit, determines the options that are available to you. Use the chart below as a quick reference to determine, if an option is available.



**Caution:** Choose your marker color carefully, especially when changing colors or brands. Xerox Engineering Systems recommends Bic Briteliner pink (BC11-PK), yellow (BC11-YL), or blue (BC11-BE) or equivalent.

	4 Dots		Closed area	
	Inside	Outside	Inside	Outside
<b>Trimming/masking</b>	Trim or mask the inside edit area.	Not available	Trim or mask the inside edit area.	Not available
<b>Fill</b>	Adds shading to the edit area. There are seven fill patterns and three levels of fill available. The fill can be in black or red.		Adds shading to the edit area. There are seven fill patterns and three levels of fill available. The fill can be in black or red.	
<b>Contrast reversal</b>	Reverse the image. In black and white, the image is white and the background is black. In red and white the image is white and the background is red.		Reverse the image. In black and white, the image is white and the background is black. In red and white the image is white and the background is red.	
<b>Mirror image</b>	Produces a copy that is a mirror image of the original.	Not available	Not available	Not available
<b>Color drop</b>	Not available	Not available	Select colors that will not be copied.	
<b>Color exchange</b>	Not available	Not available	Selected document colors are printed in red.	

## Editing (continued)

### Marker editing (continued)

#### Procedure

1. Select the **additional** feature group tab. If needed, refer to page 95.
2. Select the **editing button**, on the basic screen.  
The **editing screen** is displayed.

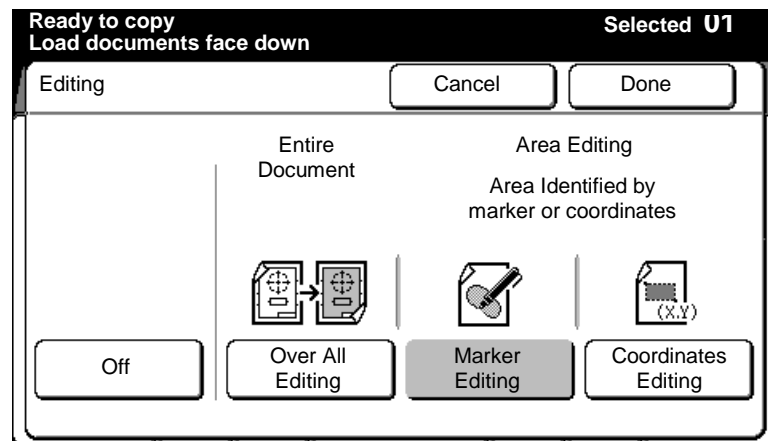

3. Select **marker editing**.  
The **marker editing screen** is displayed.

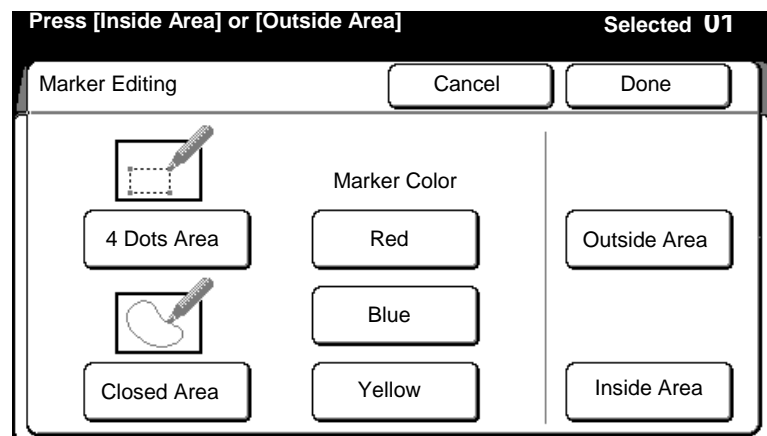

4. Select **4 dots area** or **closed area**.
5. Select the desired maker color; **red**, **blue** or **yellow**.

## Editing (continued)

---

### Marker editing (continued)

---

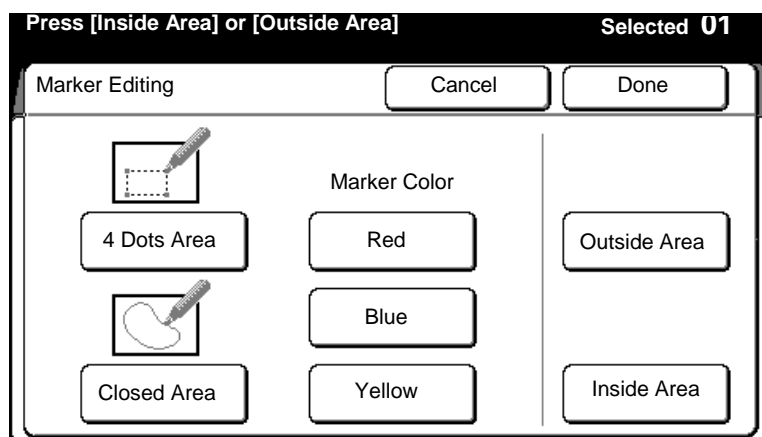

6. Select **outside area** or **inside area**.

**Inside area** Only the area within the specified area is edited.

**Outside area** Only the area outside the marked area is edited.

The **editing screen** is displayed.

7. Go to the desired option:
- **Trimming/masking**, page 110.
  - **Fill**, page 111.
  - **Contrast reversal**, page 114.
  - **Mirror image**, page 116.
  - **Color drop**, page 116.
  - **Color exchange**, page 118.

## Editing (continued)

### Marker editing (continued)

#### Trimming/masking

##### Procedure

The **closed area (inside)** screen is displayed.

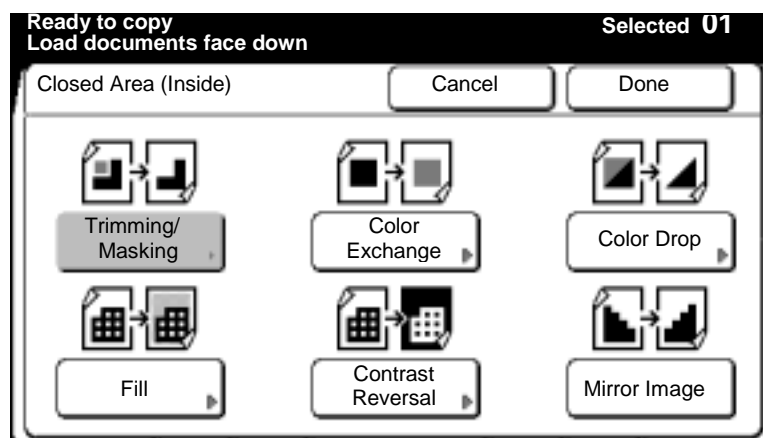

1. Select **trimming/masking**.

The **trimming/mask** screen is displayed.

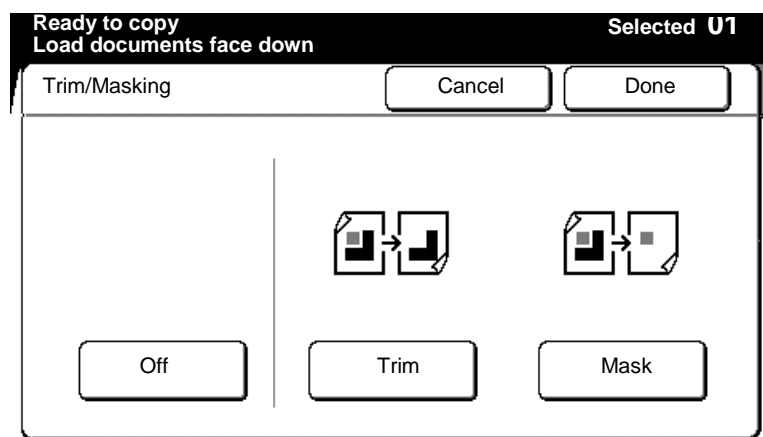

2. Select **trim** or **mask**.

**Trim** The edit area is saved and everything else deleted.

**Mask** The edit area is deleted and everything else saved.

3. Mark your document to specify the edit area.



*Note: If **closed area** is selected, the marked area on your document must be completely closed. The scanner can not recognize an open loop.*

To cancel the changes and exit from this screen, select **cancel**.

4. Insert the marked document to make copies, or select **done** as required to select additional features.



## Editing (continued)

### Marker editing (continued)

#### Fill

##### Procedure

The **closed area** or **4 dots area** (outside or inside) screen is displayed.

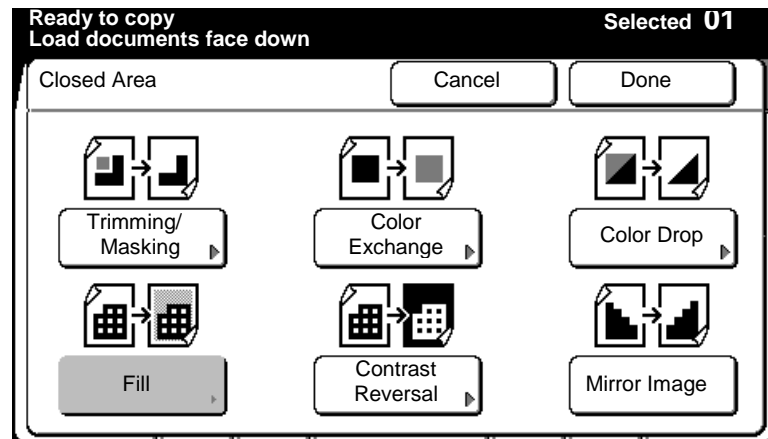

1. Select **fill**.

The **fill screen** is displayed.

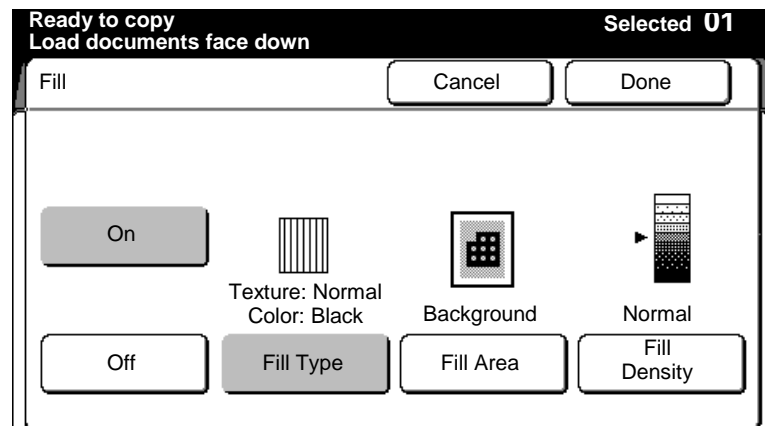

2. Select **on**.
3. Select **fill type**.

The **fill type screen** is displayed.

### Marker editing (continued)

#### Fill (continued)

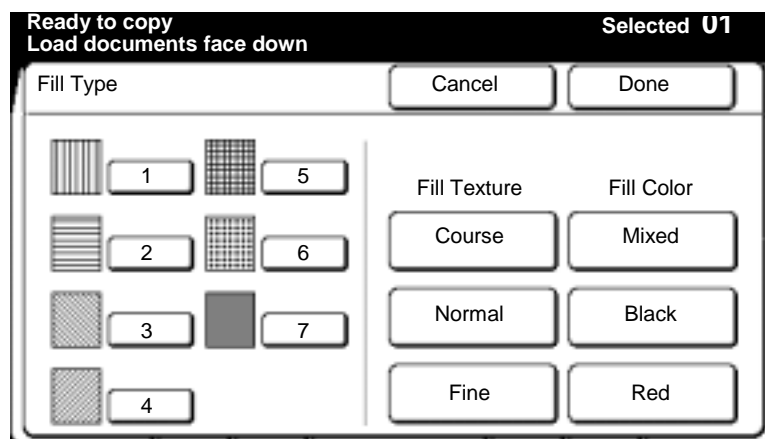

4. Select the desired fill type; **1-7**.
5. Select the desired fill texture; **course, normal** or **fine**.
6. Select the desired fill color; **mixed, black** or **red**.



*Note: Mixed is only available with fill type 7.*

To cancel the changes and exit from this screen, select **cancel**.

7. Select **done** to save the selection.

The **fill screen** is displayed.

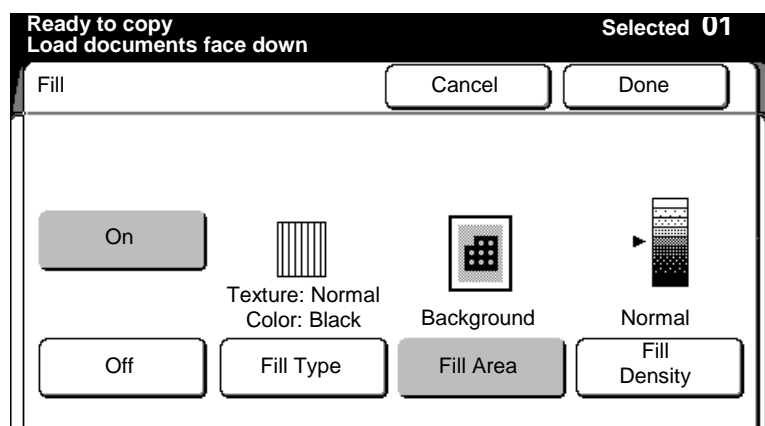

8. Select **fill area**.

The **fill area screen** is displayed.

## Editing (continued)

### Marker editing (continued)

#### Fill (continued)

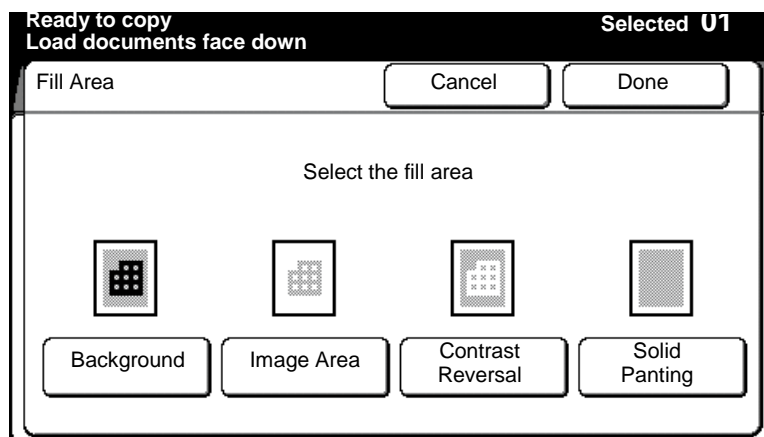

9. Select the desired fill area.

**Background** Replaces the background with the selected fill.

**Image area** Replaces the image with the selected fill .

**Contrast reversal** Prints the image areas in white and background areas are printed in the selected fill.

**Solid painting** The entire copy will be the selected fill.

To cancel the changes and exit from this screen, select **cancel**.

10. Select **done** to save the selection.

The **fill screen** is displayed.

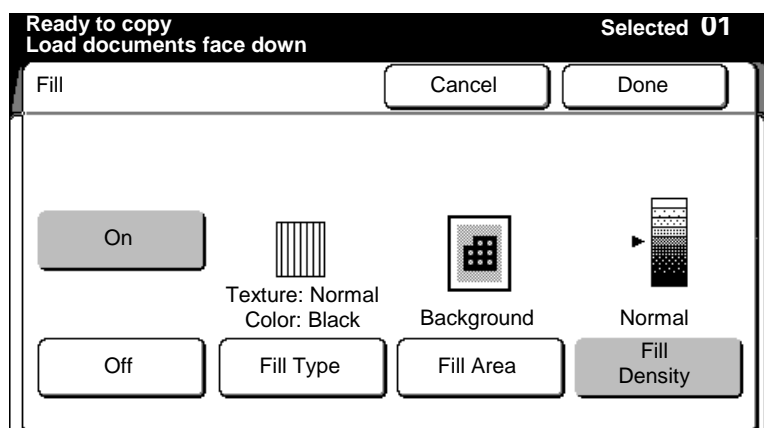

11. Select **fill density**.

The **fill density screen** is displayed.

## Editing (continued)

### Marker editing (continued)

#### Fill (continued)

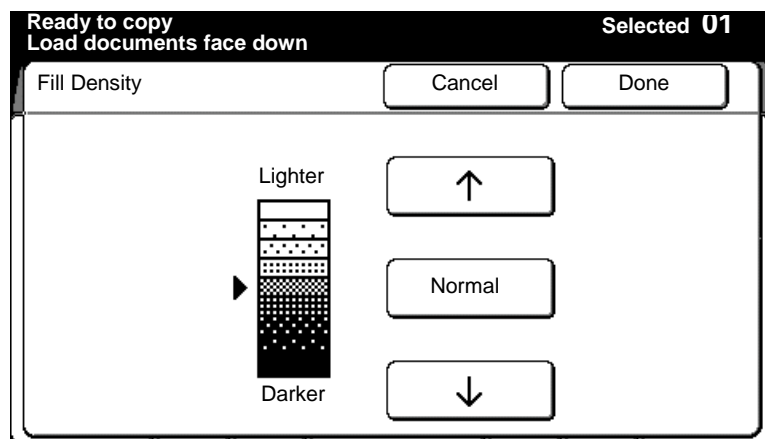

12. Adjust the density, using the **arrow buttons**. Select **normal** to return to the normal setting.

To cancel the changes and exit from this screen, select **cancel**.

13. Insert the original to make copies, or select **done** as required to select additional features.

#### Contrast reversal

##### Procedure

The **closed area or 4 dots area (outside or inside) screen** is displayed.

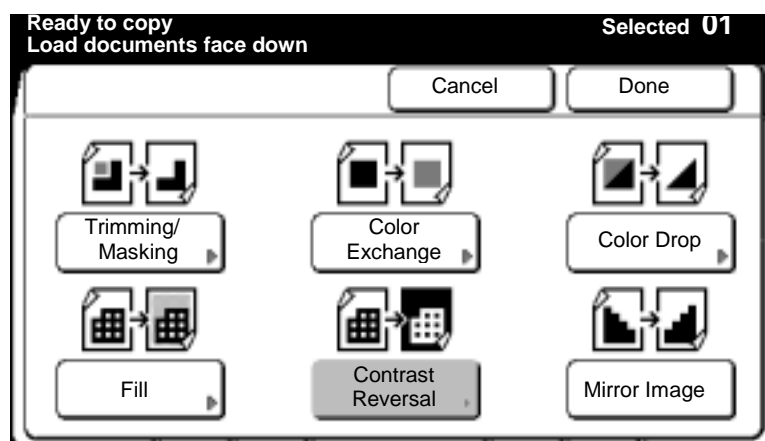

1. Select **contrast reversal**.

The **contrast reversal screen** is displayed.

## Editing (continued)

---

### Marker editing (continued)

---

#### Contrast reversal (continued)

---

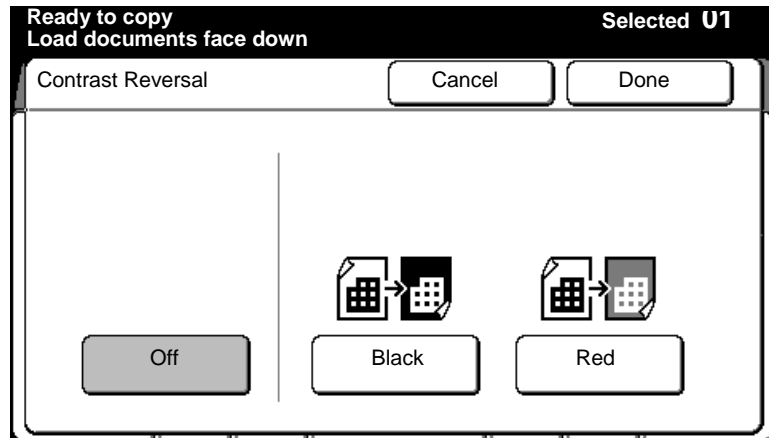

2. Select the desired color.
  - If black is selected, the image is white and the background is black. If red is selected, the image is white and the background is red.



*Note: When red is selected, the machine automatically changes the print color to red/black.*

To cancel the changes and exit from this screen, select **cancel**.

3. Insert the document to make copies, or select **done** as required to select additional features.

## Editing (continued)

### Marker editing (continued)

#### Mirror image

##### Procedure

The **4 dots Area (Inside)** screen is displayed.

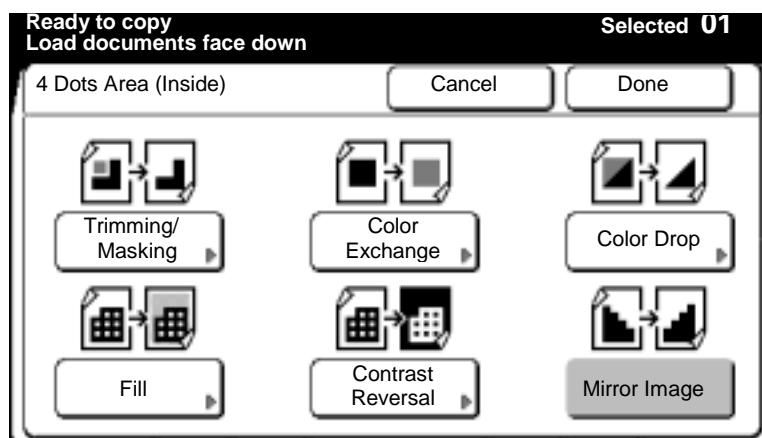

1. Select **mirror image**.  
To cancel the changes and exit from this screen, select **cancel**.
2. Insert the document to make copies, or select **done** as required to select additional features.

#### Color drop

##### Procedure

The **closed area (inside or outside)** screen is displayed.

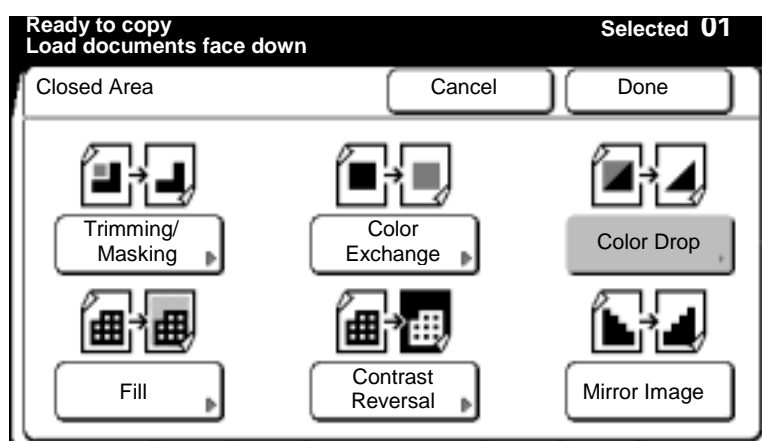

1. Select **color drop**.  
The **color drop screen** is displayed.

## Editing (continued)

---

### Marker editing (continued)

---

#### Color drop (continued)

---

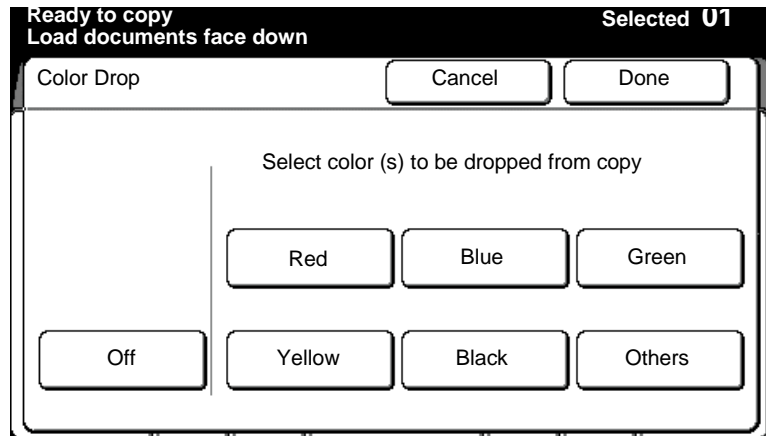

2. Select the color you want to delete from the copy; **red, blue, green, yellow, black** or **others**.
  - Multiple colors can be selected. When others is selected all colors except red, blue, green, yellow, and black are deleted.To cancel the changes and exit from this screen, select **cancel**.

3. Mark your document to specify the edit area.



*Note: If **closed area** is selected, the marked area on your document must be completely closed. The scanner can not recognize an open loop.*

4. Insert the document to make copies, or select **done** as required to select additional features.

## Editing (continued)

### Marker editing (continued)

#### Color exchange

##### Procedure

The **closed area (inside or outside) screen** is displayed.

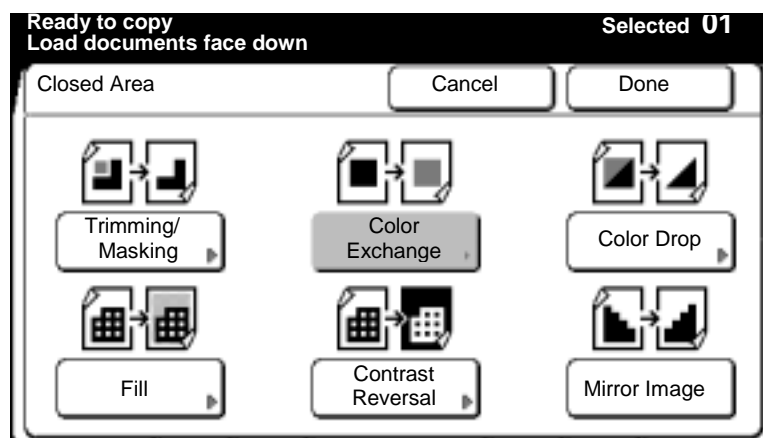

1. Select **color exchange**.

The **color exchange screen** is displayed.

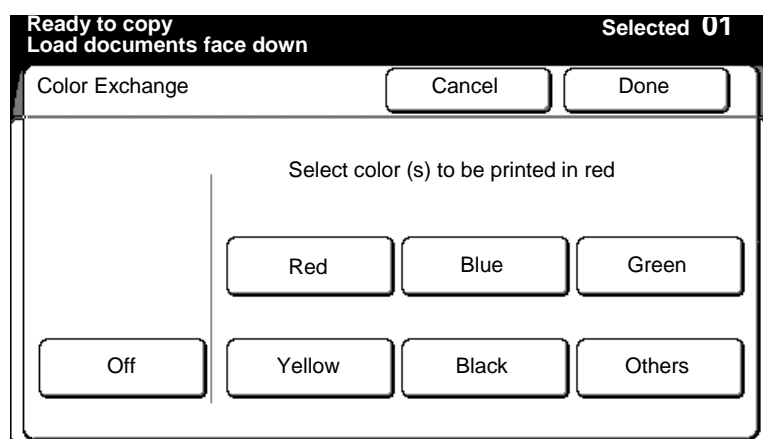

2. Select the colors you want to print in red; **red, blue, green, yellow, black** or **others**.
  - Multiple colors can be selected. When others is selected all colors except red, blue, green, yellow, and black are printed in red.

To cancel the changes and exit from this screen, select **cancel**.

3. Mark your document to specify the edit area.



*Note: If **closed area** is selected, the marked area on your document must be completely closed. The scanner can not recognize an open loop.*

4. Insert the document to make copies, or select **done** as required to select additional features.



## Editing (continued)

---

### Coordinates editing

---

#### Introduction

The **coordinate editing feature** applies the MAX 200 edit options to a single area on your document. The edit area is defined by X and Y coordinates and the coordinates must be in rectangular form.

Once you have defined the area with coordinates, you must apply the edit options to the inside or outside area of the coordinates.

There are four coordinate edit options; trimming/masking, fill, contrast reversal, and mirror image. Depending on your selection of inside or outside, determines the options that are available to you.

	Inside	Outside
<b>Trimming/masking</b>	Allows you to trim or mask the inside edit area.	Not available
<b>Fill</b>	Allows you to add shading to the edit area. There are seven fill patterns and three levels of fill available. The fill can be in black or red.	
<b>Contrast reversal</b>	Allows you to reverse the image. In black and white, the image is white and the background is black. In red and white the image is white and the background is red.	
<b>Mirror image</b>	This option produces a copy that is a mirror image of the original.	Not available

## Editing (continued)

### Coordinates editing (continued)

#### Procedure

1. Select the **additional** feature group tab. If needed, refer to page 95.
2. Select the **editing button**, on the basic screen.

The **editing screen** is displayed.

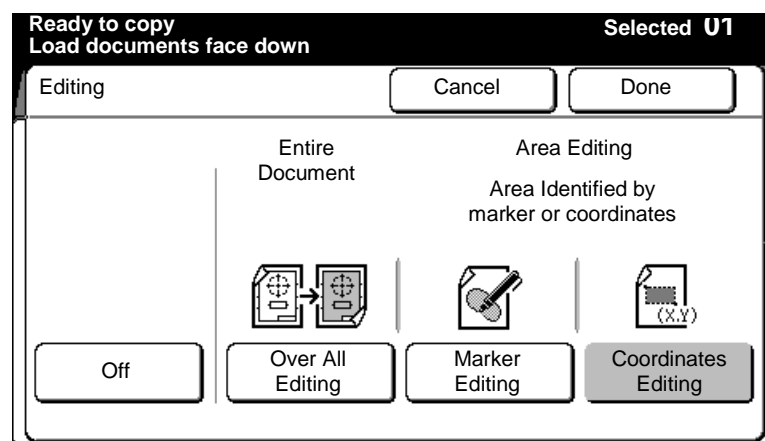

3. Select **coordinates editing**.

The **coordinates editing screen** is displayed.

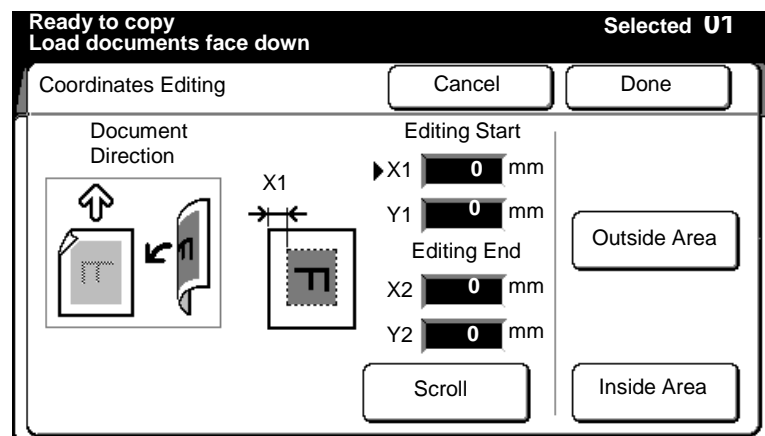

4. Use the numeric keypad to enter the X and Y coordinates and select **scroll**, to move to the desired field.

The icon on the screen shows you how to measure each coordinate.

5. Select **outside** or **inside area**.

**Inside** When selected the printer edits the area outside the marked coordinates.

**Outside** When selected the printer edits the area inside the marked coordinates.

## Editing (continued)

---

### Coordinates editing (continued)

---

The **inside or outside area** screen is displayed.

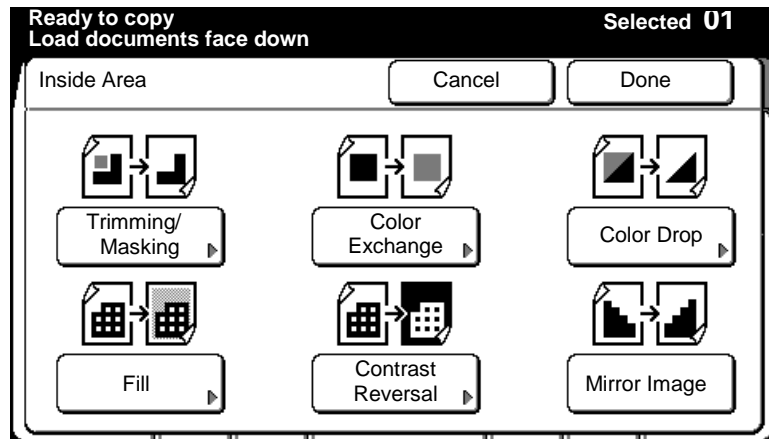

6. Go to the desired option.
  - **Trimming/masking**, page 122.
  - **Fill**, page 123.
  - **Contrast reversal**, page 127.
  - **Mirror image**, page 128.

## Editing (continued)

### Coordinates editing (continued)

#### Trimming/masking

##### Procedure

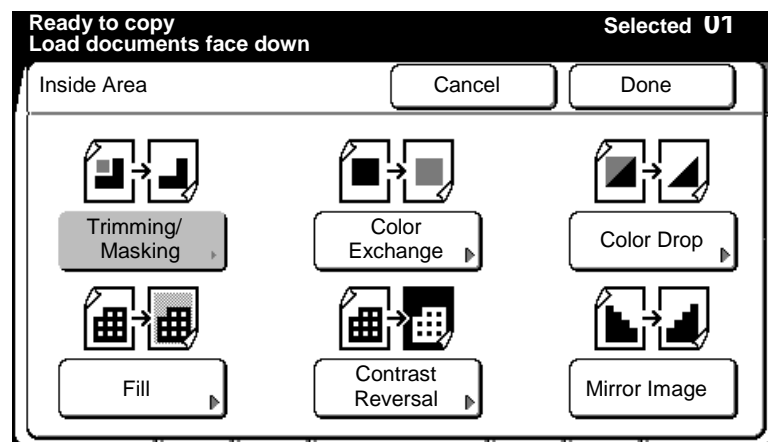

1. Select **trimming/masking**.

The **trimming/mask** screen is displayed.

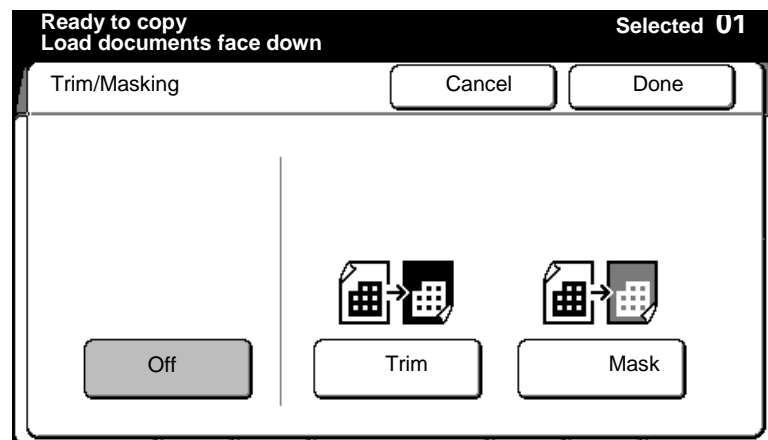

2. Select **trim** or **mask**.

**Trim** The edit area is saved and everything else deleted.

**Mask** The edit area is deleted and everything else saved.

To cancel the changes and exit from this screen, select **cancel**.

3. Insert the document to make copies, or select **done** as required to select additional features.

## Editing (continued)

### Coordinates editing (continued)

#### Fill

##### Procedure

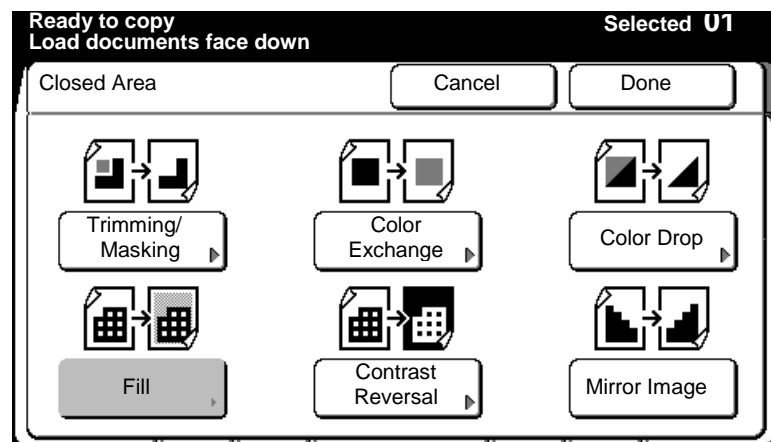

1. Select **fill**.

The **fill screen** is displayed.

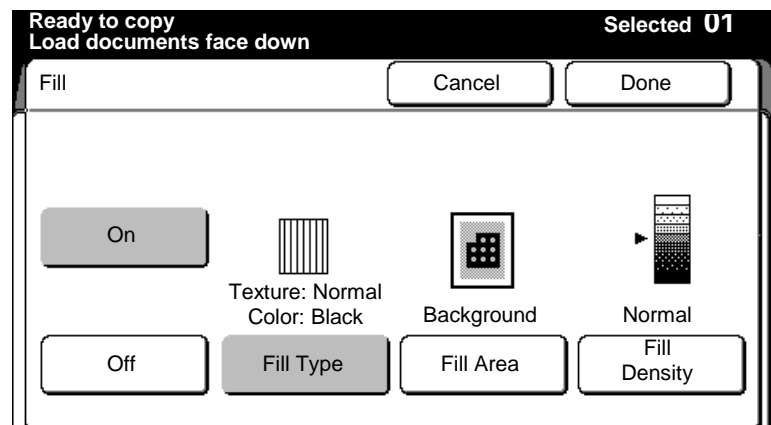

2. Select **on**.
3. Select **fill type**.

The **fill type screen** is displayed.

### Coordinates editing (continued)

#### Fill (continued)

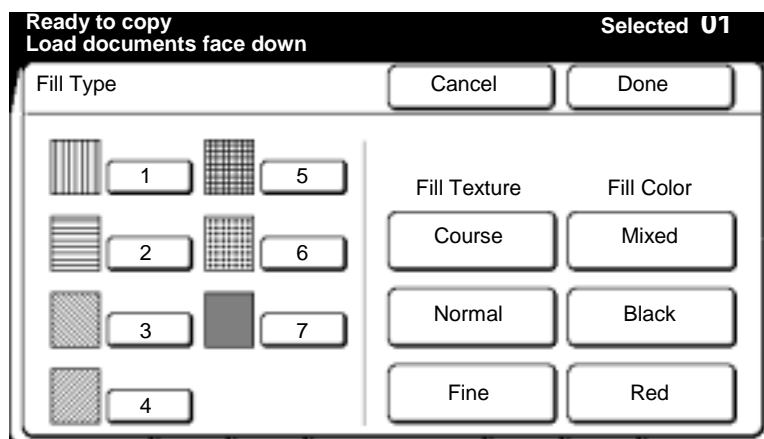

4. Select the desired fill type; **1 – 7**.
5. Select the desired fill texture; **course, normal**, or **fine**.
6. Select the desired fill color; **mixed, black** or **red**.



*Note: Mixed is only available with fill type 7.*

To cancel the changes and exit from this screen, select **cancel**.

7. Select **done** to save the selection.

The **fill screen** is displayed.

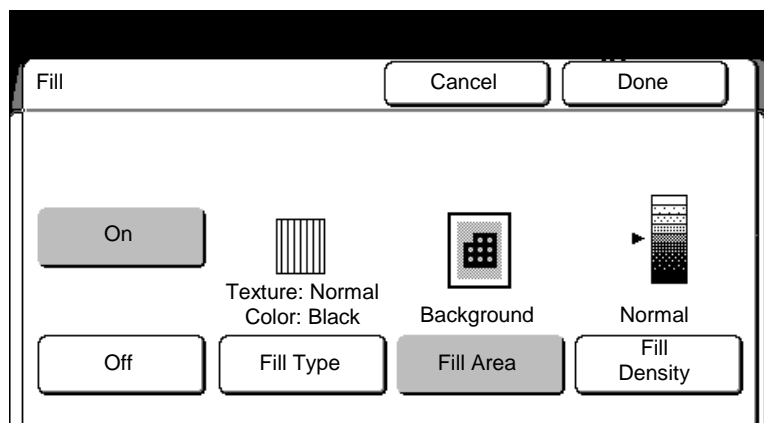

8. Select **fill area**.

The **fill area screen** is displayed.

## Editing (continued)

### Coordinates editing (continued)

#### Fill (continued)

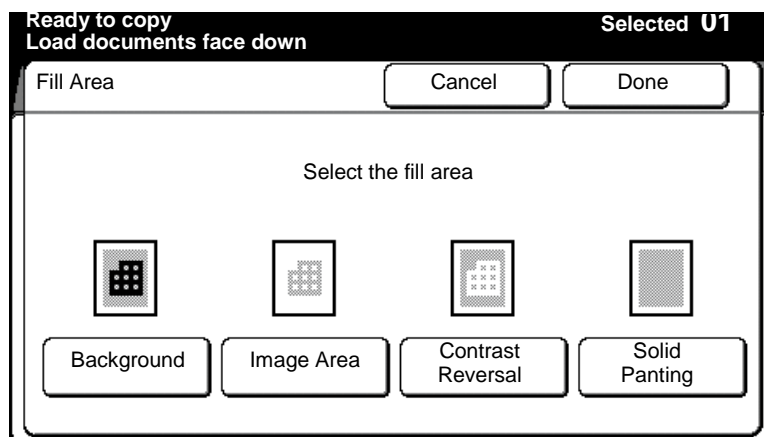

9. Select the desired fill area.

**Background** Replaces the background with the selected fill.

**Image area** Replaces the image with the selected fill.

**Contrast reversal** Prints the image areas in white and background areas are printed in the selected fill.

**Solid painting** The entire copy is the selected fill.

To cancel the changes and exit from this screen, select **cancel**.

10. Select **done** to save the selection.

The **fill screen** is displayed.

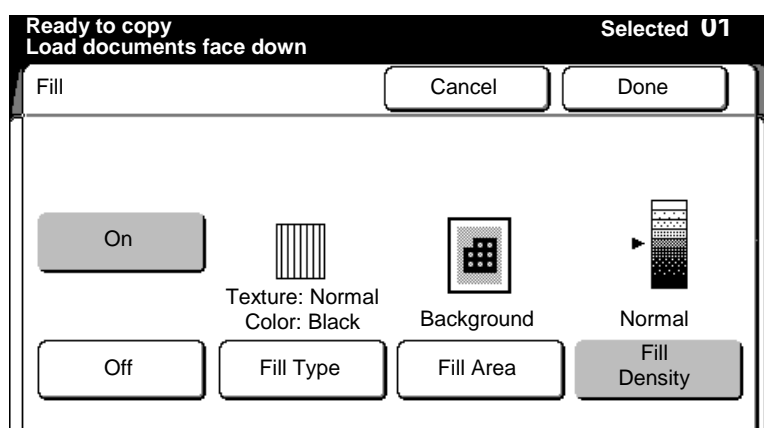

11. Select **fill density**.

The **fill density screen** is displayed.

## Editing (continued)

---

### Coordinates editing (continued)

---

#### Fill (continued)

---

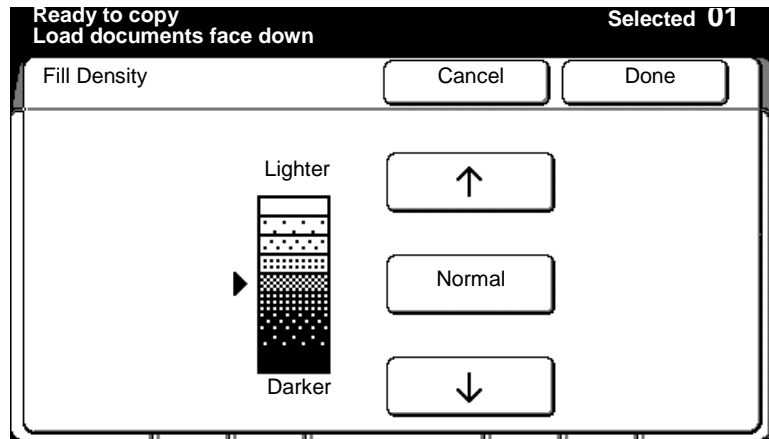

12. Adjust the density, using the **arrow buttons**.  
Select **normal** to return to the normal setting.  
To cancel the changes and exit from this screen, select **cancel**.
13. Insert the document to make copies, or select **done** as required to select additional features.



## Editing (continued)

### Coordinates editing (continued)

#### Contrast reversal

##### Procedure

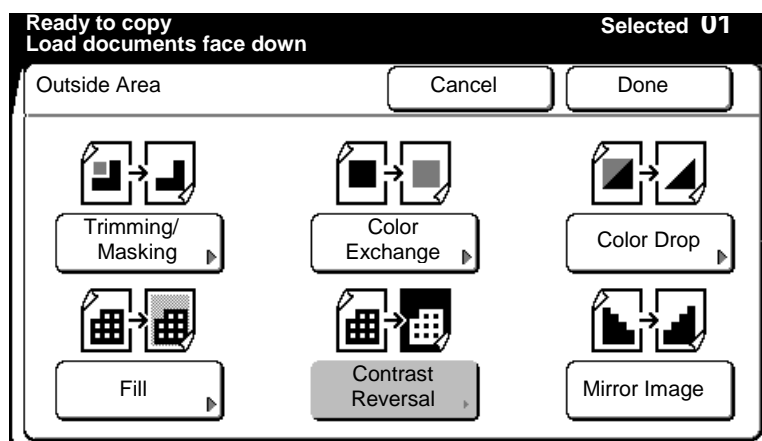

1. Select **contrast reversal**.

The **contrast reversal screen** is displayed.

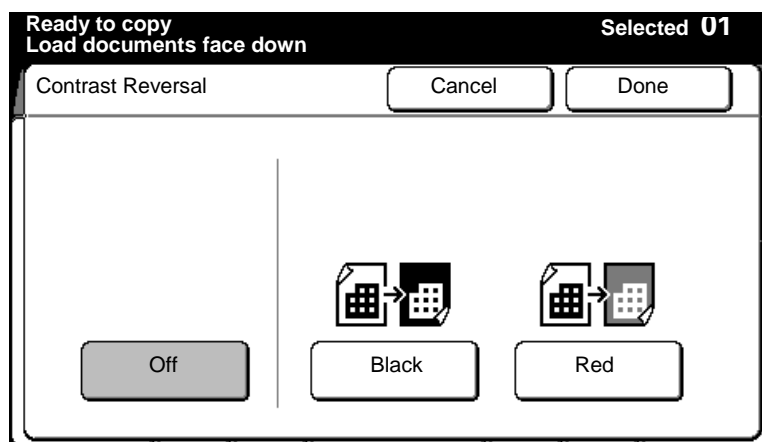

2. Select the desired color.



*Note: When red is selected, the machine automatically changes the print color to red/black.*

- If black is selected, the image is white and the background is black. If red is selected, the image is white and the background is red.

To cancel the changes and exit from this screen, select **cancel**.

3. Insert the document to make copies, or select **done** as required to select additional features.

## Editing (continued)

---

### Coordinates editing (continued)

---

#### Mirror image

---

##### Procedure

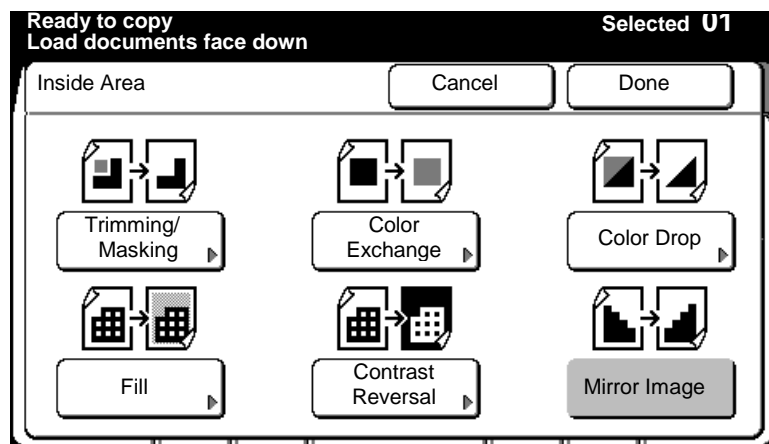

1. Select **mirror image**.  
To cancel the changes and exit from this screen, select **cancel**.
2. Insert the document to make copies, or select **done** as required to select additional features.

## Finishing touch screen features

The **finishing features** provide you access to the MAX 200 finishing features for the stamper, E-sorter, folder and the printer paper exit areas (systems with no folder).



*Note: If your machine is not equipped with the optional stamper, the stamper feature is not available.*



*Note: If your machine is not equipped with the optional folder, the folder feature is not available. The finishing touch screen displays the paper exit selection button, instead of the folder button. Refer to page 161.*

### Introduction

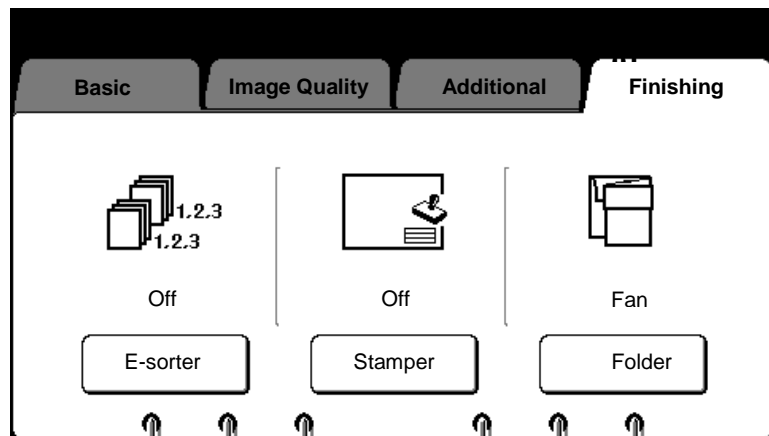

*Note: Depending on what your machine is equipped with, the screen above may have different icons and text. The text above the selection buttons provides the status of each feature.*

### Procedure

Procedure to access the finishing feature group screen:

1. Select the **finishing** feature group tab.

The **finishing feature group screen** is displayed.

2. Go to the desired selection.
  - **E-sorter**, page 130.
  - **Stamper**, page 137.
  - **Folder**, page 159.
  - **Paper exit**, page 161.

# E-sorter

## Introduction

The electronic sorter, also known as the E-sorter, reads a set of scanned documents, stores the data into memory, and delivers the desired quantity of sets to the printer.

**Collated** copies print in sets, with a 1-2-3, 1-2-3, 1-2-3 order. When the **collated feature is off**, copies print in sets with a 1-1-1, 2-2-2, 3-3-3 order. You can select up to 99 copy sets.

The E-sorter also provides the **program feature**. The program feature is a convenient tool that helps you automate the copy function for jobs that have complex distribution lists.

The MAX 200 allows a maximum of 300 programs. Each program can store copy quantity requirements for up to 40 customers.

Once your E-sorter program is setup in custom presets, you can select the E-sorter **program button** to automate your copy jobs. For detailed information on how to setup an E-sorter program, refer to page 249.

The screen below is the E-sorter screen. It is displayed when you select the **E-sorter button**, on the **finishing feature group tab**.

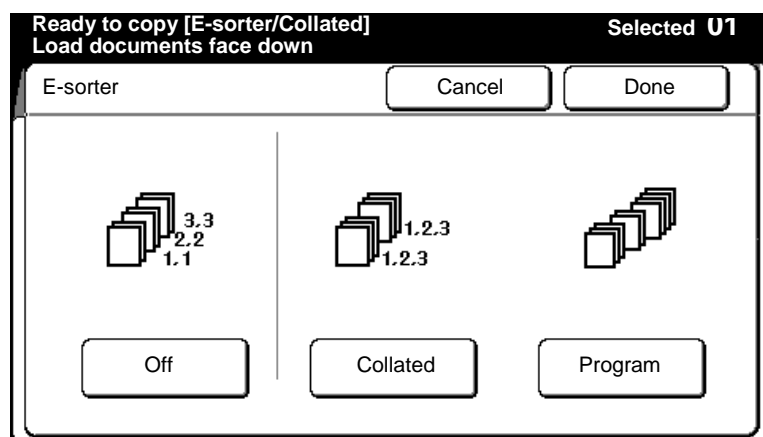

Feature	Function
<b>Off (not collated)</b>	Copies are delivered as sets. Sets are delivered in a 1-1-1, 2-2-2, 3-3-3 order. Refer to page 131.
<b>Collated</b>	Copies are delivered as sets. Banner sheets can be inserted between each set. Sets are delivered in a 1-2-3, 1-2-3, 1-2-3 order. Refer to page 132.
<b>Program</b>	Copy sets are delivered per a preset program. Refer to page 135.  To setup an E-sorter program (in custom presets), refer to page 249.

## E-sorter (continued)

### Off (uncollated)

#### Procedure

1. Select the **finishing** feature group tab. If needed, refer to page 129.
2. Select the **E-sorter button**, on the finishing screen.

The **E-sorter screen** is displayed.

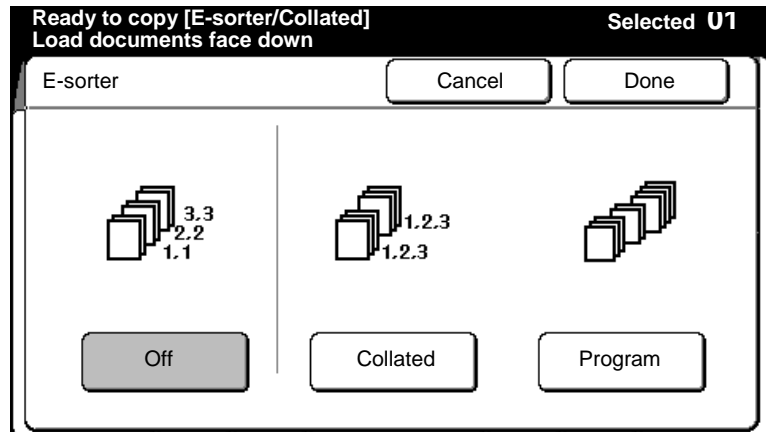

3. Select **off**.
4. Select **done**.
5. Insert the documents to make copies (copies of your documents are output in a set order of 1-1-1, 2-2-2, 3-3-3).

## E-sorter (continued)

### Collated

#### Procedure

1. Select the **finishing** feature group tab. If needed, refer to page 129.
2. Select the **E-sorter button**, on the finishing screen.

The **E-sorter screen** is displayed.

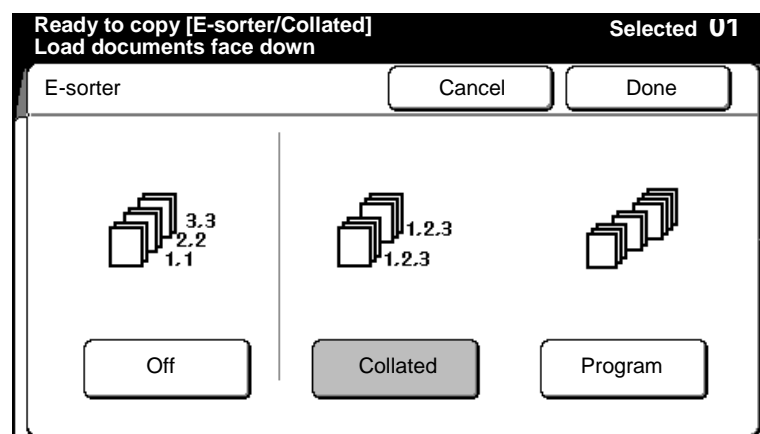

3. Select **collated**.

The **E-sorter (collated) screen** is displayed.

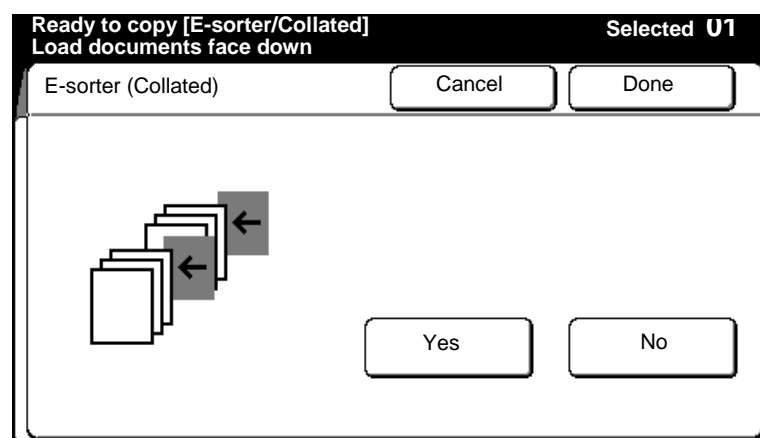

4. Select **yes** or **no** for banner sheet inserts.
  - Banner sheets are fed from tray 5.
5. Select the number of desired sets, using the numeric keypad.
  - Once the first document is fed, the number of sets cannot be changed.
6. Insert the first document from the document set, into the scanner.

The **E-sorter (collated) screen** is displayed, when the document is inserted into the scanner.

## E-sorter (continued)

### Collated (continued)

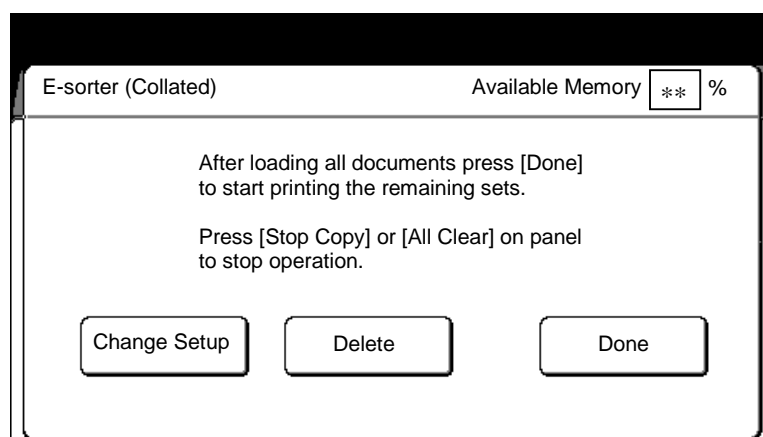

7. Check the copy. If the copy features are Ok, continue to step 9. If not, continue to the next step.
  - If you need to delete the last document scanned, select **delete**.
  - If you need to change any of the copy features of the scanned document, select **change setup**. Else continue to step 9.

The **change setup screen** is displayed.

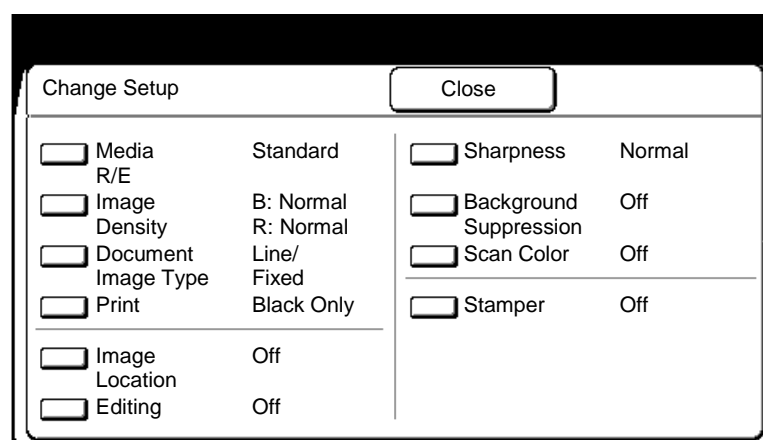

8. Select the desired feature button. Select the new settings. Select **done** to return to the change setup screen. When all changes are complete, select **close** on the change setup screen.
9. Insert the next document to be scanned. If needed select additional features as required. Repeat step 7 for each document.

The **E-sorter (collated) screen** is displayed.

## E-sorter (continued)

---

### Collated (continued)

---

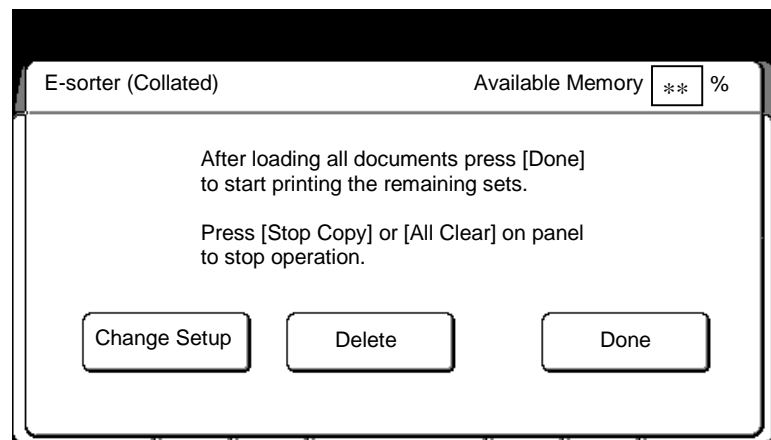

10. When all the documents are scanned, select **done**.

Press **stop copy button** or **clear all button** to stop the operation.

The remaining sets are delivered.



## E-sorter (continued)

### Program



*Note: A maximum of 300 programs can be created before or during the build of the E-sorter set. To pre-build an E-sorter program, refer to page 249.*

#### Procedure

1. Select the **finishing** feature group tab. If needed, refer to page 129.
2. Select the **E-sorter button**, on the finishing screen.

The **E-sorter screen** is displayed.

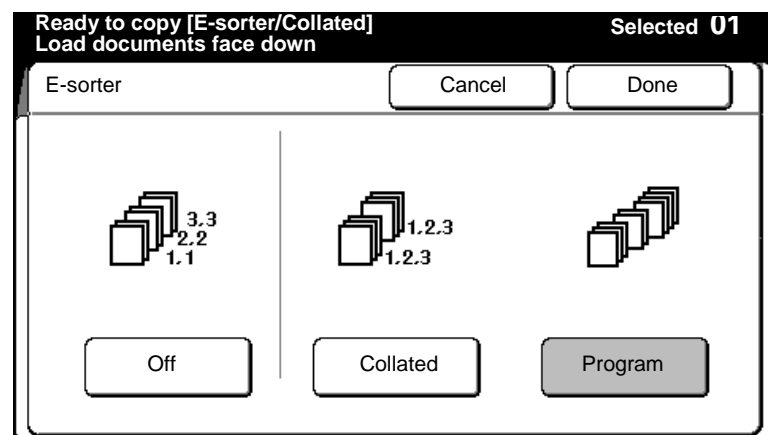

3. Select **program**.

The **E-sorter (program) screen** is displayed.

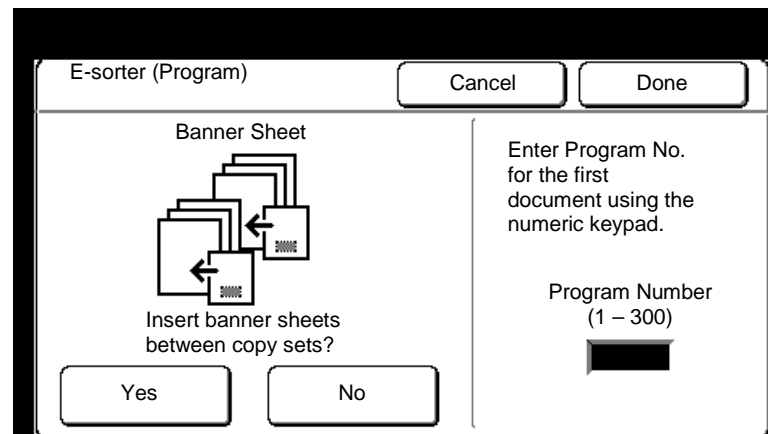

4. Select **yes** or **no** for banner sheet inserts.
  - Banner sheets are fed from tray 5.
5. Enter the E-sorter program number, using the numeric keypad.
6. Insert the first document from the document set, to make the first copy. Select **done** as required to select additional features.

The **E-sorter program number screen** is displayed.

## E-sorter (continued)

### Program (continued)

Enter Program Number of next document  
Load document face down

E-sorter (Program) Available Memory \*\* %

Number of Customers: 5 Program Number (1 - 300)  
Storage pattern: Off  
Reduce/Enlarge: Auto

After loading all documents, press [Done] to start printing the remaining sets.  
Press [Stop Copy] or [All Clear] on panel to stop operation.

Change Setup Delete Done

7. Check the copy.
  - If the copy is not acceptable select **delete**. The document image just scanned is deleted. The **deletion screen** is displayed. Select **confirm** to delete.
8. Change the program number if required.

The **new program number screen** is displayed.
9. To change the setup of the next document, select **change setup**, else continue to step 11.

The **change setup screen** is displayed.

Ready to Copy (E-Sort/Collated) Counted 01/04  
Load document face down

Change Setup Close

<input type="checkbox"/> Media R/E	Standard	<input type="checkbox"/> Sharpness	Normal
<input type="checkbox"/> Image Density	B: Normal R: Normal	<input type="checkbox"/> Background Suppression	Off
<input type="checkbox"/> Document Image Type	Line/ Fixed	<input type="checkbox"/> Scan Color	Off
<input type="checkbox"/> Print	Black Only	<input type="checkbox"/> Stamper	Off
<input type="checkbox"/> Image Location	Off		
<input type="checkbox"/> Editing	Off		

10. Select the desired feature button. Select the new settings.
11. Insert the next document to be copied, or select additional features as required.
  - Repeat steps 7 to 11 until all documents in the document set are scanned.
12. Select **done** on the **E-sorter (program) screen** to begin making copies of the remaining documents.

# Stamper



*Note: If your machine is not equipped with the optional stamper, the stamper features is not available.*

## Introduction

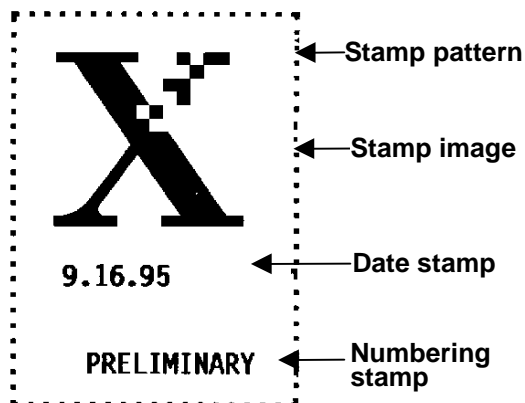

This **stamper feature** allows you to select a stamp pattern to print, modify a stamp pattern, print the stamp patterns, or delete stamp patterns.

If you modify a stamp pattern, you are able to define the stamp location and orientation or include the date stamp and the numbering stamp. All stamp patterns are first created in custom presets before they can be modified, for detailed information on how to create the stamp, refer to page 234.

You may position a stamp anywhere on your copies, but patterns may not be larger than 70 mm squared = 4900 mm<sup>2</sup>. The stamp image can be printed red or black.

All created stamp patterns must be stored onto the floppy disk drive. The disk may contain up to 40 stamps; you can store additional stamps on other diskettes and load them as needed. Once stored onto the floppy you can load the stamp patterns into machine memory.



*Note: The format used by the floppy drive is unique to MAX 200; it can not read or write PC, Macintosh, or UNIX computer files. To format your floppy diskette, refer to page 245.*

## Stamper (continued)

The screen below is the stamper screen. It is displayed when you select the **stamper button**, on the **finishing feature group tab**.

The stamper screen contains five stamper features; stamp pattern, numbering, stamp location, date stamp, and stamp color.

In order to enable the stamper features select the **on button** first. The chart in this section, identifies each feature and provides a description of each feature.

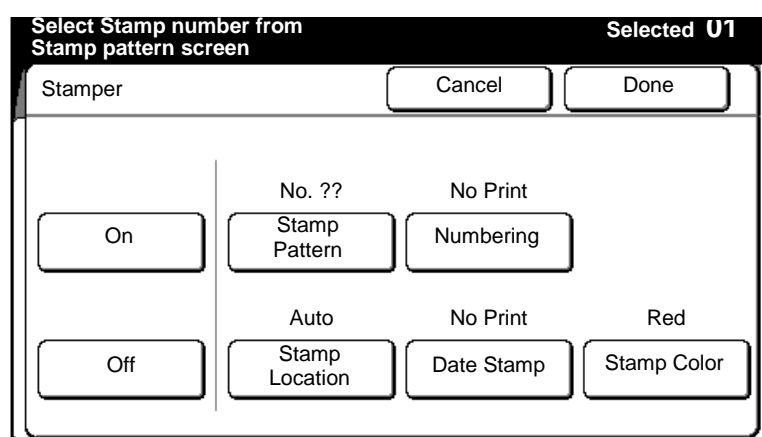

Feature	Function
<b>On</b>	Enable the stamper features.
<b>Off</b>	Disables the stamper features.
<b>Stamp pattern</b>	This feature allows you to select a stamp pattern, print all stamp patterns, manually load stamp patterns to memory, or delete all stamp patterns in memory. Refer to page 139.
<b>Numbering</b>	This feature creates the numbering stamp. You can have a maximum of 12 characters in the numbering stamp. Refer to page 141.
<b>Stamp location</b>	This feature sets up the stamp location and orientation to the preset values in custom presets. Refer to page 147.
<b>Date stamp</b>	This feature creates the date stamp. There are two options available current and variable. Refer to page 153.
<b>Stamp color</b>	This feature prints the stamp pattern in red or black. Refer to page 158.

# Stamper (continued)

## Stamp pattern

### Introduction

The **stamp pattern feature** allows you:

- To select a loaded stamp pattern.
- To load all the stamp patterns from the floppy disk drive to machine memory. Ensure your floppy is formatted. For detailed information on how to format your floppy, refer to page 245.
- To print all the stored stamp patterns.
- To delete all the stamp patterns, from machine memory.

### Procedure

1. Select the **finishing** feature group tab. If needed, refer to page 129.
2. Select the **stamper button**, on the finishing screen.

The **stamper screen** is displayed.

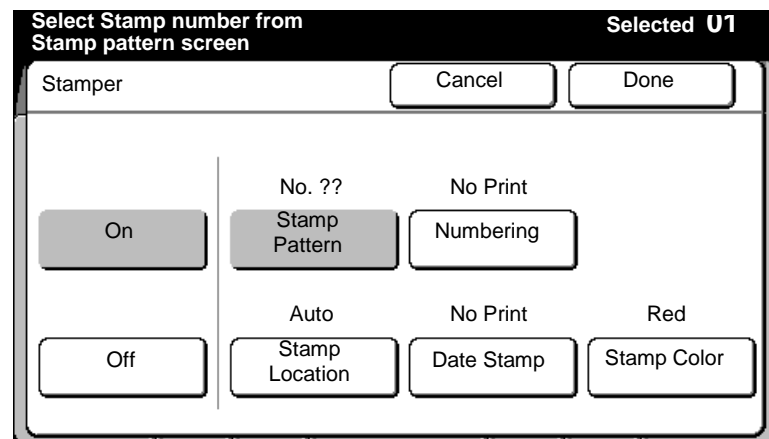

3. Select **on**.
4. Select **stamp pattern**.

The **stamp pattern screen** is displayed.

## Stamper (continued)

### Stamp pattern (continued)

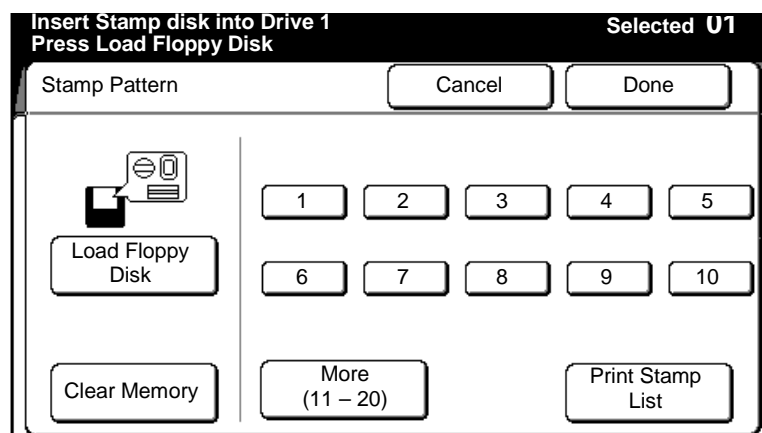

*Note: The format used by the floppy drive is unique to MAX 200; it can not read or write PC, Macintosh, or UNIX files. You must format your floppy disk from the MAX 200. If needed, refer to page 245.*

5. Select the desired selection button:

**Select a stamp pattern number, 1 - 40.**

Select the desired loaded stamp pattern number. Insert the document into the scanner.

**Print stamp list**

Select **print stamp list**. All stored stamps are printed.

**Load floppy disk.**

Select **load floppy disk**. All stamp data is loaded to memory.

**Clear memory**

Select **clear memory**. All stamp data is removed from memory.

To cancel selection, select **cancel**.

6. Select **done**.

The **stamper screen** is displayed.

7. To exit the stamper screen, select **done** or select another desired feature (refer to the selected feature in this section for the procedure).

To cancel the changes and exit from this screen, select **cancel**.

8. Insert the document to make copies, or select **done** as required to select additional features.

## Stamper (continued)

### Numbering



*Note: Ensure your loaded stamp pattern has enough room to include the numbering stamp. All stamp patterns can not exceed 70 mm squared = 4900 mm<sup>2</sup>.*



*Note: If you do not want an image stamped on your drawing, but you do want to use the numbering feature, create a blank stamp.*

#### Introduction

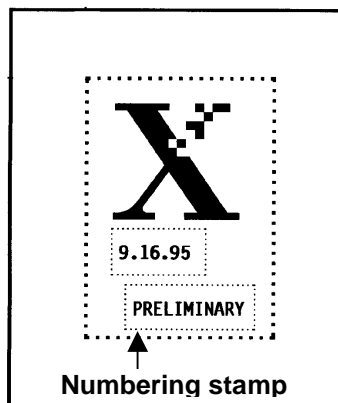

The **numbering stamp feature** allows you to create the numbering stamp and insert it into an existing stamp pattern.

The numbering stamp may contain a maximum of 12 alphanumeric characters. The font used for all characters is 14 point gothic, and can not be changed.

There are two numbering options available; fixed and sequential.

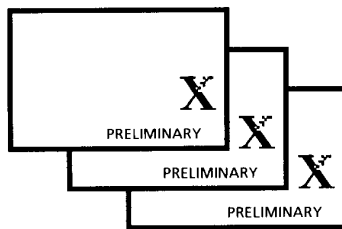

#### Option

#### Function

##### Fixed

The maximum number of characters is twelve. The same characters are printed on all copies. Refer to page 142.

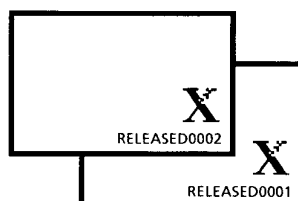

##### Sequential

The maximum number of characters is twelve. The first 8 characters are printed on all copies, the next 4 characters are the number of the copy, within the set. Refer to page 144.

The sequential feature is only enabled when the collated E-sorter option is selected.

## Stamper (continued)

### Numbering (continued)

#### Fixed



Note: To cancel changes and exit from any screen, select **cancel** on the touch screen.

#### Procedure

1. Select the **finishing** feature group tab. If needed, refer to page 129.
2. Select the **stamper button**, on the finishing screen.  
The **stamper screen** is displayed.

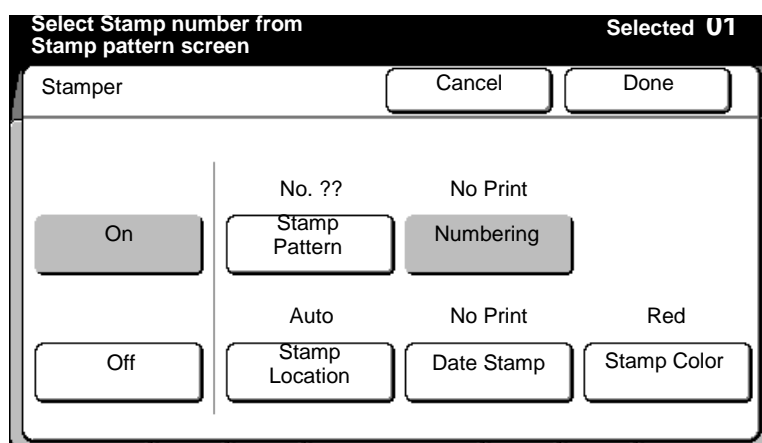

3. Select **on**.
4. Select **numbering**.

The **numbering screen** is displayed.

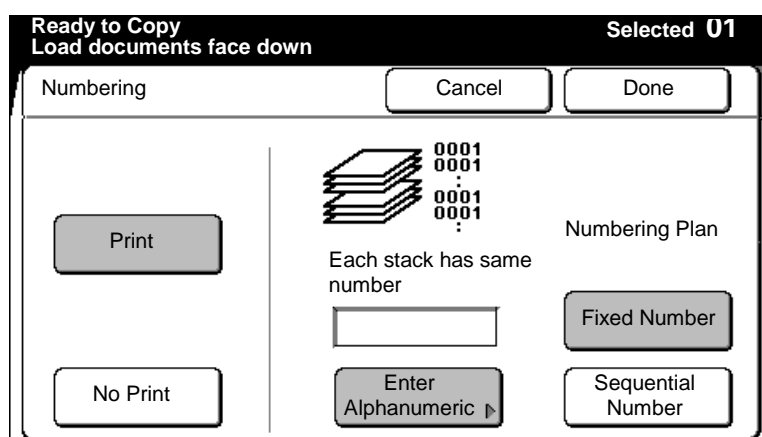

5. Select **print**.
6. Select **fixed number**.
7. Select **enter alphanumeric**.

The **alphanumeric screen** is displayed.



## Stamper (continued)

### Numbering (continued)

#### Fixed (continued)

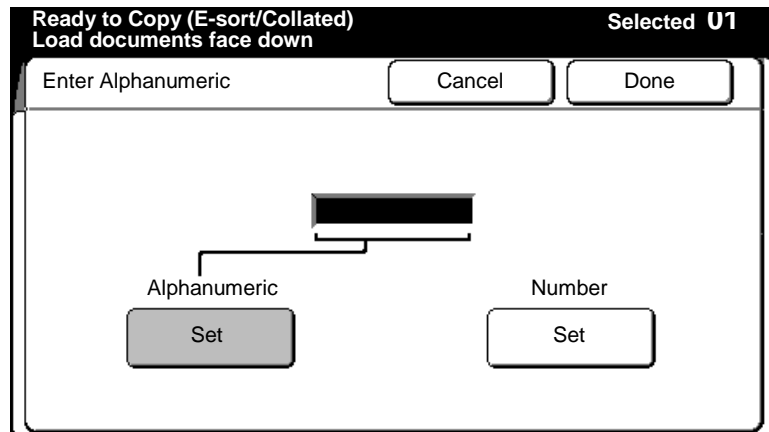

8. Select the alphanumeric **set button**.

The **alphanumeric keypad screen** is displayed.

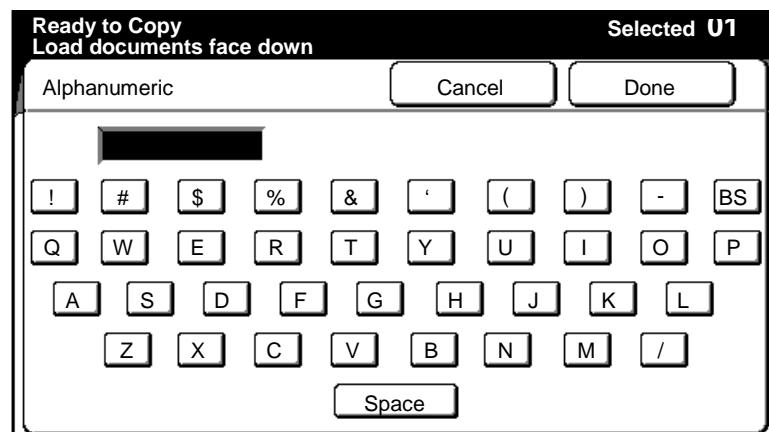

9. Use the keyboard screen to enter the characters and spaces.

- A maximum of 12 characters can be entered.
- Select the **BS button** to backspace and to erase unwanted characters.

To cancel the changes and exit from this screen, select **cancel**.

10. Insert the document to make copies, or select **done** as required to select additional features.

## Stamper (continued)

### Numbering (continued)

#### Sequential



Note: The sequential option is available only when the E-sorter collated option is selected.



Note: To cancel changes and exit from any screen, select **cancel** on the touch screen.

#### Procedure

1. Select the **finishing** feature group tab. If needed, refer to page 129.
2. Select the **stamper button**, on the finishing screen.

The **stamper screen** is displayed.

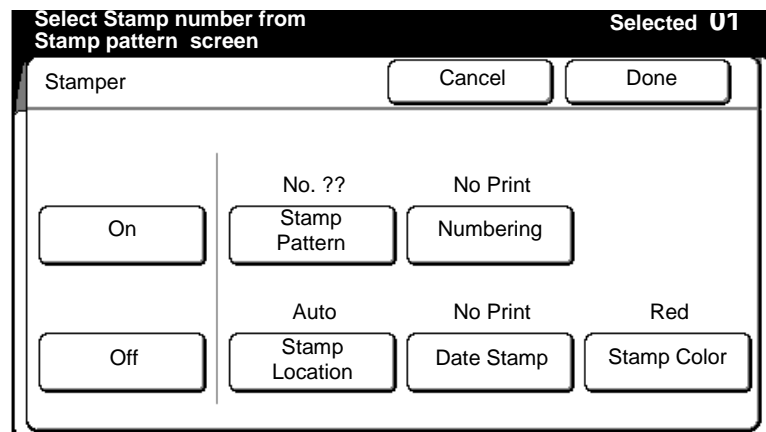

3. Select **on**.
4. Select **numbering**.

The **numbering screen** is displayed.

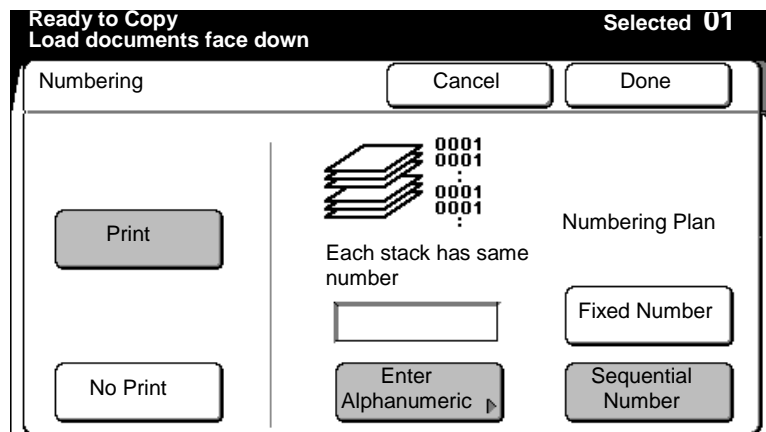

5. Select **print**.
6. Select **sequential number**.
7. Select **enter alphanumeric**.

The **alphanumeric screen** is displayed.

## Stamper (continued)

### Numbering (continued)

#### Sequential (continued)

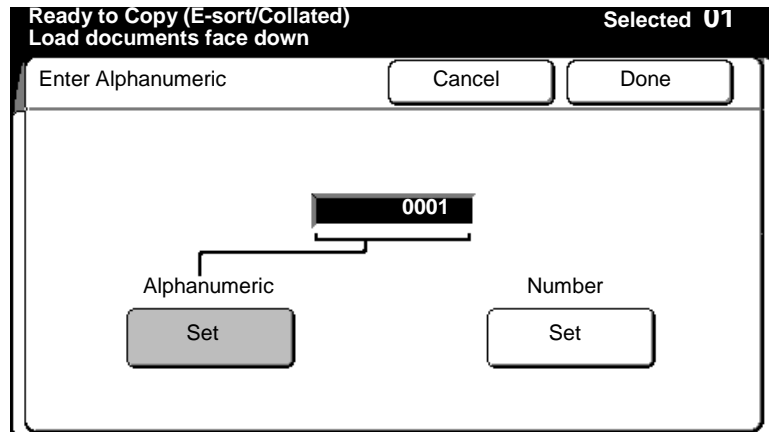

8. Select the alphanumeric **set** button.

The **alphanumeric keypad screen** is displayed.

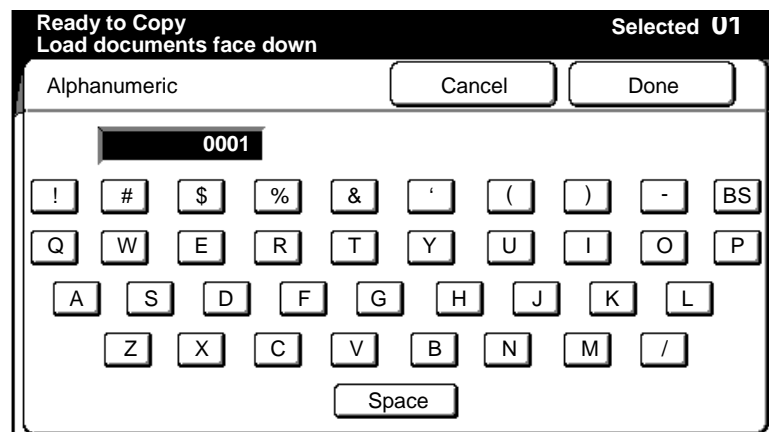

9. Enter the desired characters using the keyboard screen. Up to 8 letters or numbers can be entered.



*Note: The characters entered are printed to the left of the sequential number.*

10. Select **done**.

The **alphanumeric keypad screen** is displayed.

## Stamper (continued)

---

### Numbering (continued)

---

#### Sequential (continued)

---

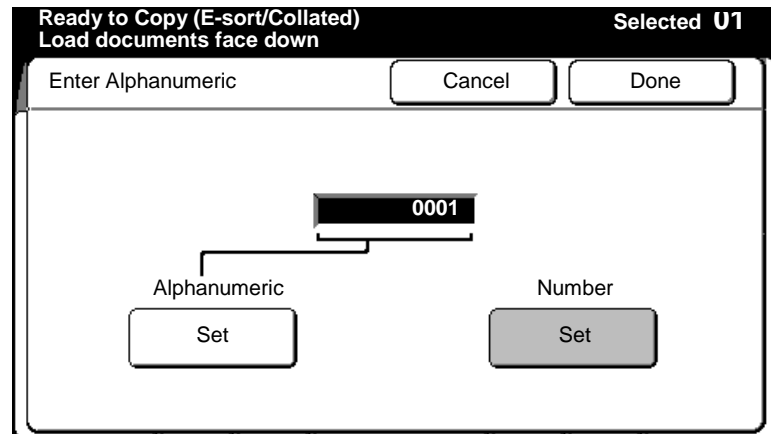

11. Select the number **set button**, enter the beginning number for the last 4 digits.
  - If no change is made, the sequential number begins with 0001.
12. Insert documents to make copies, or select **done** as required to select additional features.

## Stamper (continued)

---

### Stamp location

---

#### Introduction

The **stamp location feature** provides you with two methods to define the stamp location and orientation, on your copies.

The auto method, automatically uses the preset values in custom presets, on page 198.

The manual method allows you to set up the location and orientation of the stamp pattern, on your copies.

Option	Function
<b>Manual</b>	The operator selects the start position of the stamp pattern with X and Y coordinates and selects the stamp orientation. Refer to page 147.
<b>Auto</b>	The preset values in custom presets are used to define the stamp location and orientation of the stamp pattern. Refer to page 151.  For detailed information on how to setup the auto settings in custom presets, refer to page 198.

## Stamper (continued)

### Stamp location (continued)

#### Manual



Note: To cancel changes and exit from any screen, select **cancel** on the touch screen.

#### Procedure

1. Select the **finishing** feature group tab. If needed, refer to page 129.
2. Select the **stamper button**, on the finishing screen.

The **stamper screen** is displayed.

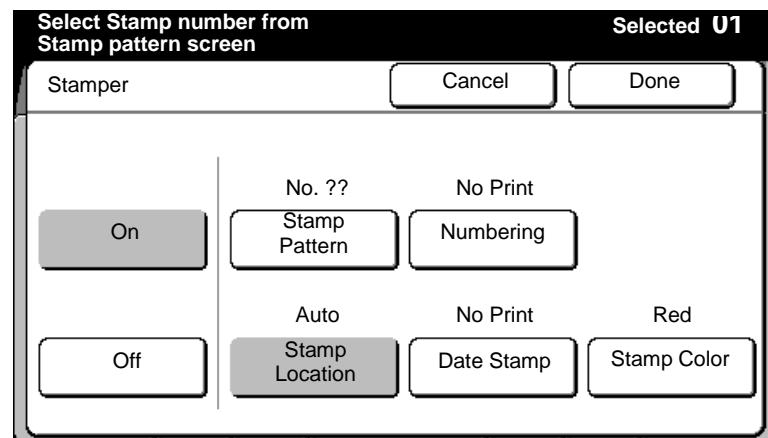

3. Select **on**.
4. Select **stamp location**.

The **stamp location screen** is displayed.

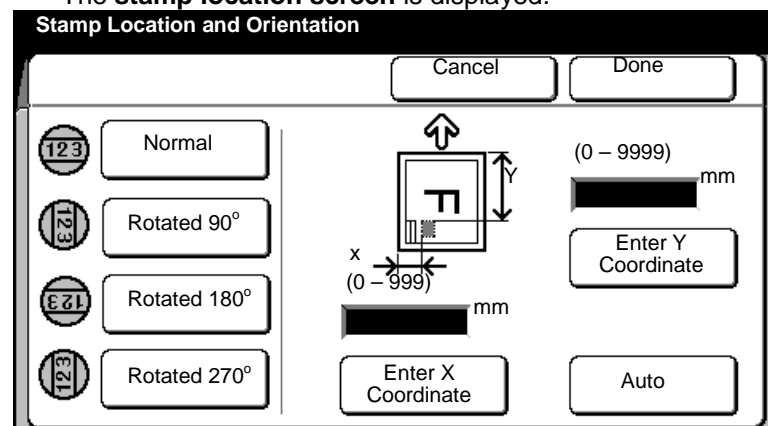

5. Select the desired stamp orientation, **normal**, **90°**, **180°**, or **270°**.

When the stamp image is scanned (normally portrait), the scanned position becomes the default for normal. When 90°, 180°, or 270° is selected, the stamp is rotated 90°, 180°, or 270° from the default.

## Stamper (continued)

### Stamp location (continued)

#### Manual (continued)

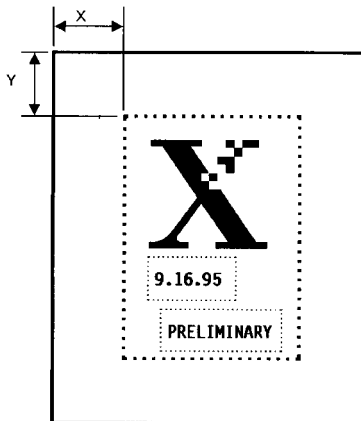
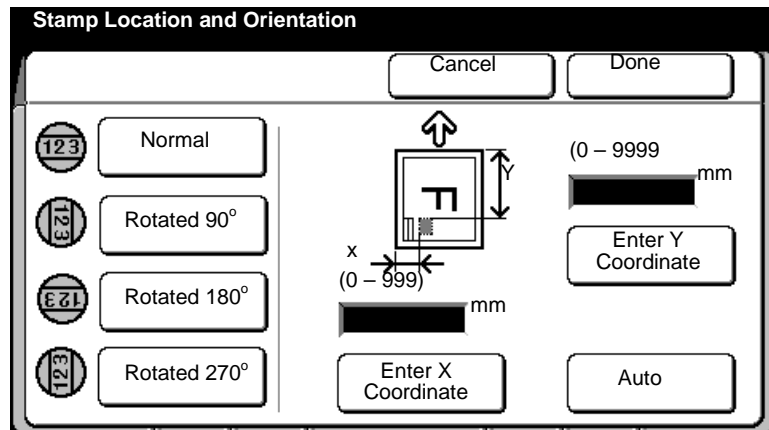

6. Select **enter X coordinate**.
7. Measure the X coordinate.
  - Measure from the left edge of the paper to the left side of the desired stamp pattern location.
8. Use the numeric keypad to enter the dimension. The range is 0 – 999 mm.

## Stamper (continued)

### Stamp location (continued)

#### Manual (continued)

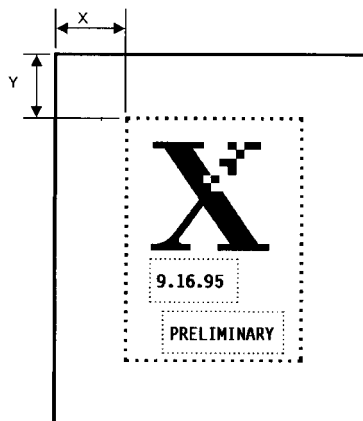
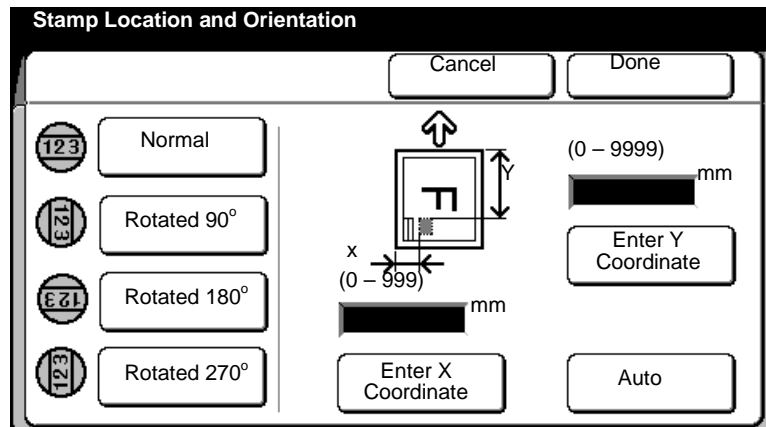

9. Select **enter Y coordinate**.
10. Measure the Y coordinate.
  - Measure from the lead edge of the paper to the top of the desired stamp pattern location.
11. Use the numeric keypad to enter the dimension. The range is 0 - 999 mm.
12. Insert the document to make copies or select **done** as required to select additional features.



## Stamper (continued)

---

### Stamp location (continued)

---

#### Auto

---

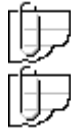

*Note: To change the setup settings for the auto option, refer to page 198.*

*Note: To cancel changes and exit from any screen, select **cancel** on the touch screen.*

#### Procedure

1. Select the **finishing** feature group tab. If needed, refer to page 129.
2. Select the **stamper button** on the finishing screen.

The **stamper screen** is displayed.

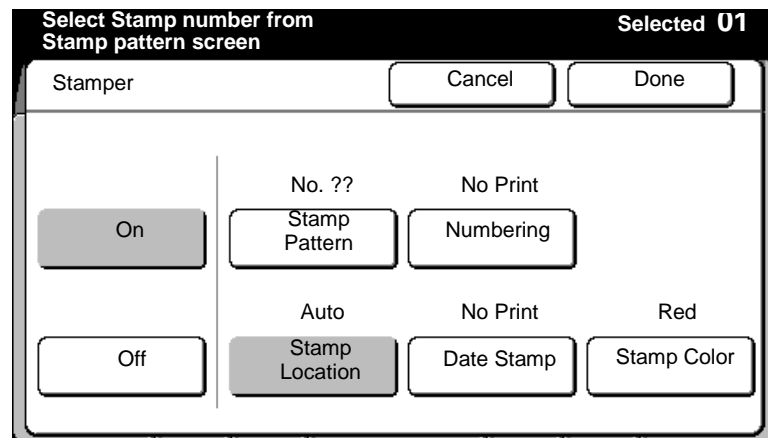

3. Select **on**.
4. Select **stamp location**.

The **stamp location screen** is displayed.

## Stamper (continued)

---

### Stamp location (continued)

---

#### Auto (continued)

---

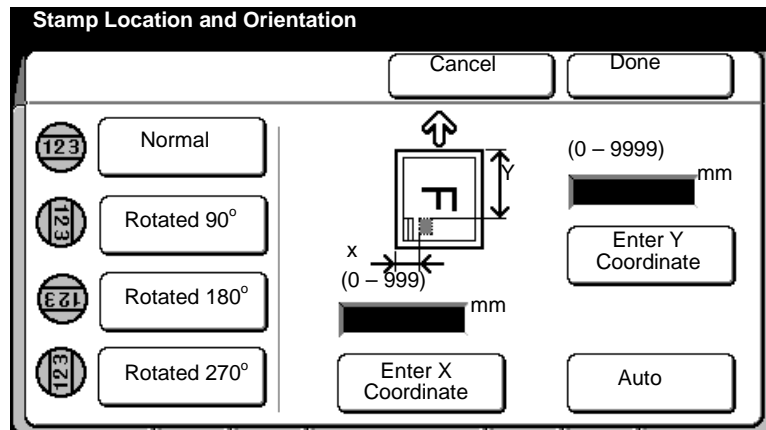

5. Select **auto**.
  - Auto is displayed in the X and Y fields and the auto orientation set in custom presets is highlighted.
  - The stamp location and orientation are the same preset values in custom presets (page 198).
6. Insert the document to make copies or select **done** as required to select additional features.

## Stamper (continued)

### Date stamp



*Note: Ensure the loaded stamp pattern has enough room to include the date stamp. Stamp patterns can not exceed 70 mm squared = 4900 mm<sup>2</sup>.*

#### Introduction

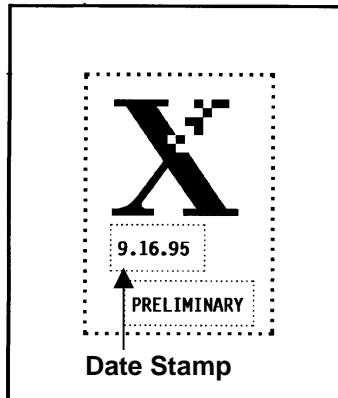

The **date stamp feature** allows you to create the date stamp and format it, if needed.

The date stamp is one element of the stamp pattern. In order to include the date stamp to a stamp pattern, the stamp pattern must be stored on to a floppy disk or in machine memory.

The date stamp font is 14 point gothic and can not be changed. There are two options available; current and variable.

Option	Function
<b>Current</b>	The current option uses the current machine date for the date stamp. The operator can select a different format. Refer to page 154.
<b>Variable</b>	The variable option allows the operator to select the date and format for the date stamp. Refer to page 156.

## Stamper (continued)

---

### Date stamp (continued)

---

#### Current

---



*Note: The date used is the current machine date. The machine date & time is setup in custom presets, on page 176.setup*



*Note: To cancel changes and exit from any screen, select **cancel** on the touch screen.*

#### Procedure

1. Select the **finishing** feature group tab. If needed, refer to page 129.
2. Select the **stamper button**, on the finishing screen.

The **stamper screen** is displayed.

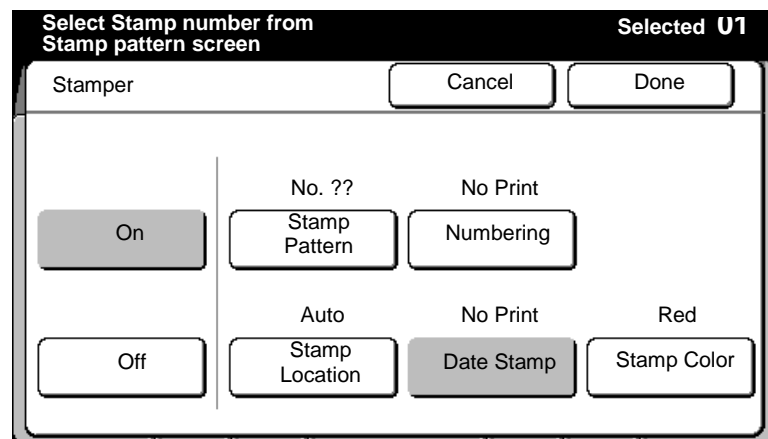

3. Select **on**.
4. Select **date stamp**.

The **date stamp screen** is displayed.

## Stamper (continued)

---

### Date stamp (continued)

---

#### Current (continued)

---

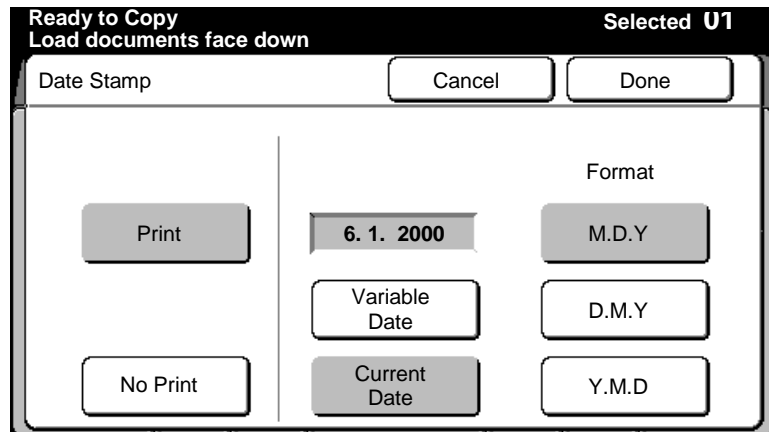

5. Select **print**.
6. Select **current date** (the current machine date is used).
7. Select the desired format.
  - M.D.Y.**      Month/day/year
  - D.M.Y.**      Day/month/year
  - Y.M.D.**      Year/month/day
8. Insert the document to make copies, or select **done** as required to select additional features.

## Stamper (continued)

### Date stamp (continued)

#### Variable



Note: To cancel changes and exit from any screen, select **cancel** on the touch screen.

#### Procedure

1. Select the **finishing** feature group tab. If needed, refer to page 129.
2. Select the **stamper button**, on the finishing screen.

The **stamper screen** is displayed.

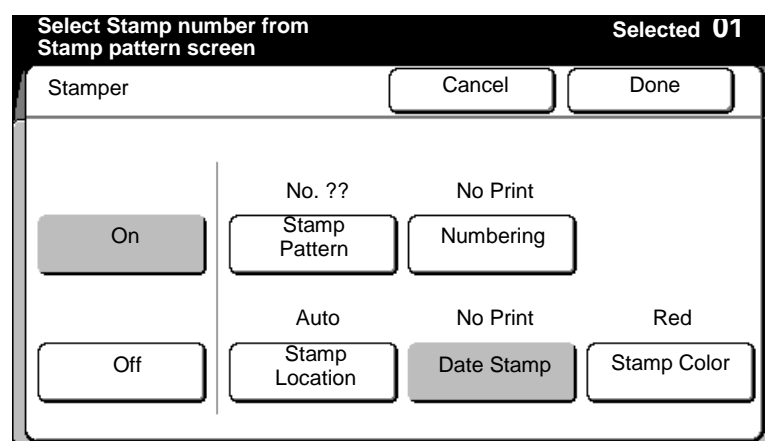

3. Select **on**.
4. Select **date stamp**.

The **date stamp screen** is displayed.

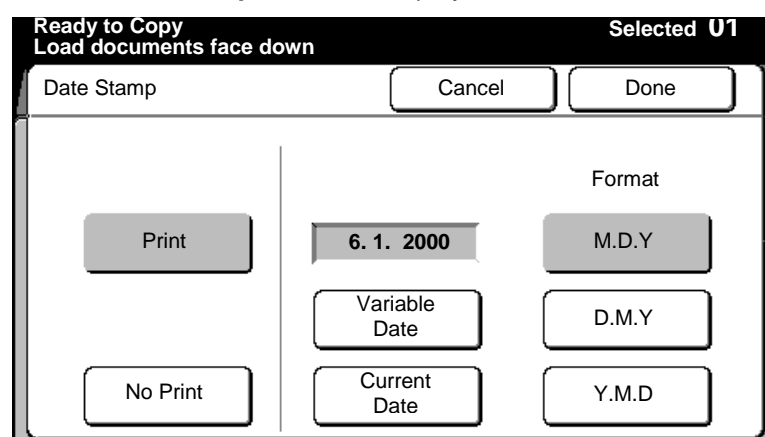

5. Select **print**.
6. Select the desired format.

**M.D.Y.**      Month/day/year

**D.M.Y.**      Day/month/year

**Y.M.D.**      Year/month/day

## Stamper (continued)

### Date stamp (continued)

#### Variable (continued)

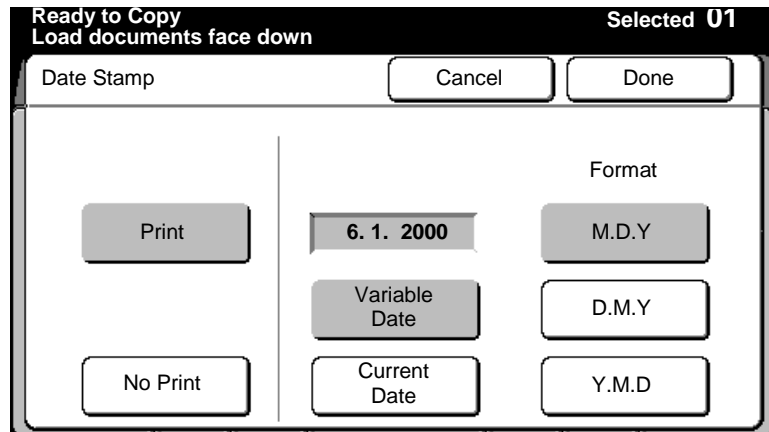

7. Select **variable**.

The **variable date** screen is displayed.

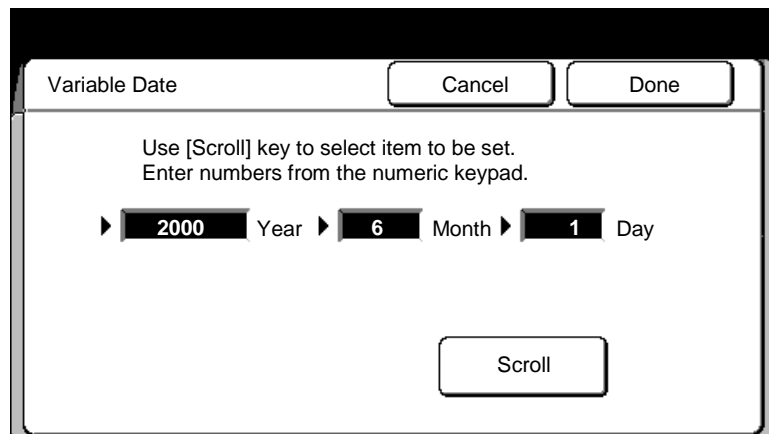

8. Use the numeric keypad to enter the desired numbers.  
Select **scroll** to move to each field  
Press the **clear button**, on the scanner control panel to clear wrong data.
9. Insert the document to make copies, or select **done** as required to select additional features.

## Stamper (continued)

### Stamp color

#### Introduction

The **stamp color feature** sets up the color of the stamp to print red or black.

#### Procedure

1. Select the **finishing** feature group tab. If needed, refer to page 129.
2. Select the **stamper button**, on the finishing screen.

The **stamper screen** is displayed.

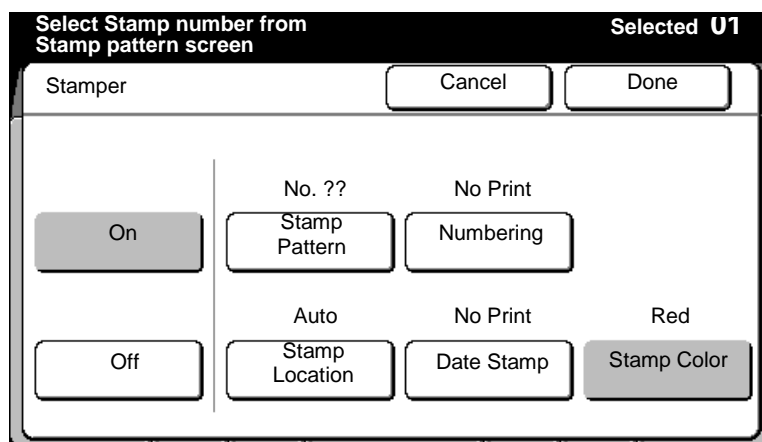

3. Select **on**.
4. Select **stamp color**.

The **stamp color screen** is displayed.

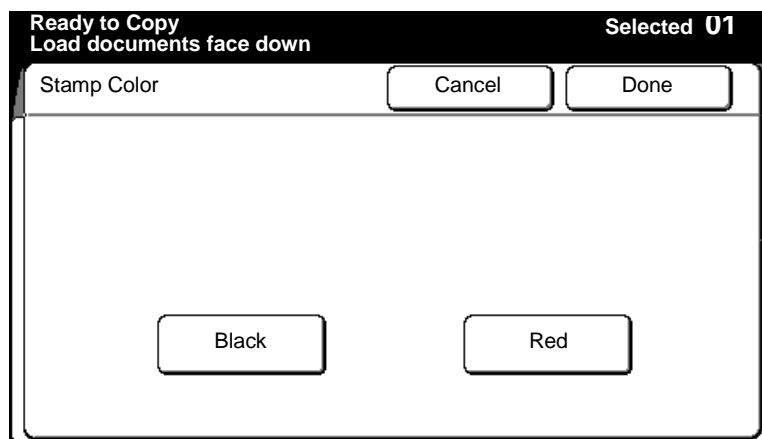

5. Select **red** or **black**.
6. Select **done** to return to the stamper screen.



# Folder



*Note: If your system is set up with a folder, do not put A or A4 size media into the tray 5, short edge feed. Refer to your user guide for detailed information.*

## Introduction

This **folder feature** sets up the fold default for copy mode. There are three fold options available, P1, P2, and P3. You can also select no fold (this option is usually for systems with a stacker. You can not fold Film/Mylar or vellum media.

## Procedure

1. Select the **finishing** feature group tab. If needed, refer to page 129.
2. Select the **folder button**, on the finishing screen.

The **folder screen** is displayed.

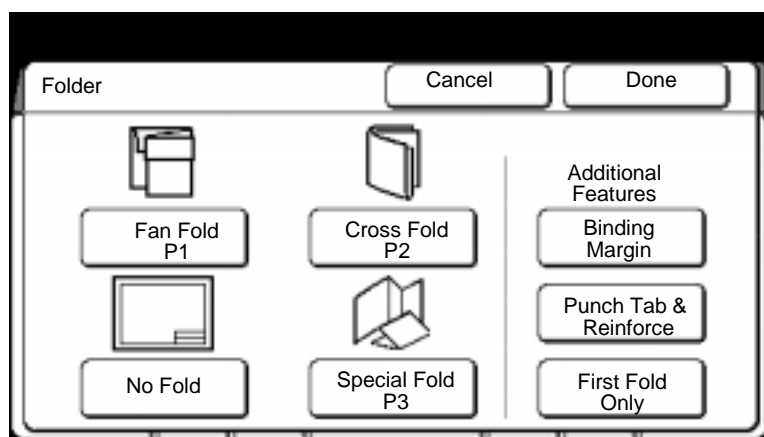

3. Select the desired fold default for copy mode; **P1**, **P2**, **no fold**, or **P3**. To change P1, P2, or P3 parameters, refer to page 203.



**Caution:** You can set up P1, P2, or P3 to folds other than P1= fan fold, P2 = cross fold, and P3 = special fold at the folder, but the above screen displays P1= fan fold, P2 = cross fold, and P3 = special fold. Ensure to power off and power on, the folder, after changing any of the folds, other than what is displayed on the above touch screen.

- |                     |  |
|---------------------|--|
| <b>Fan fold</b>     | Produces copies folded to A-size, but all panels may not be equal in size. With fan fold you can add a binding margin.   |
| <b>Cross fold</b>   | Produces copies folded in A-size, with all panels of equal size. You can not add a binding margin when cross fold is selected.   |
| <b>No fold</b>      | If no fold is selected, the right column of the screen changes to the exit column. Select the desired exit option; <b>printer</b> or <b>folder</b> .   |
| <b>Special fold</b> | Produces other folds according to the setup of the folder. If your folder provides other fold operations, follow the folder user guide to set the machine to the other fold. Select the <b>P3</b> option, to set the fold default to special fold. |

## Folder (continued)

---

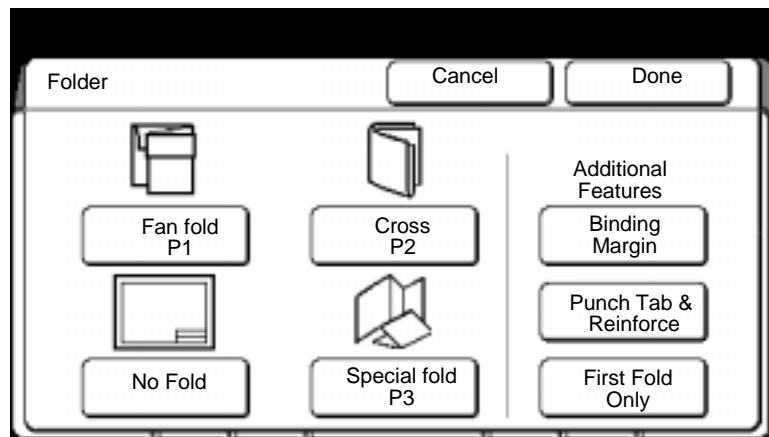

4. If available and desired select the desired additional features.

**Binding margin** The default preset margin value from custom presets is used (If needed, refer to folder setup, page 203).

**Punch tab & reinforce** Select if your output media is punch tab or reinforced media.

**First fold only** This feature performs the first fold only (first fold is perpendicular to media travel). All copies exit the front of the printer.

To cancel your selections, select **cancel**.

5. Insert the document to make copies, or select **done** as required to select other touch screen features.

## Paper exit (for machines with no folder)

### Introduction

If your machine does not have a folder, the finishing screen displays the paper exit icon, instead of the folder icon. The **paper exit feature** allows you to choose the printer media exit area. There are two paper exit options; top and side.

Option	Function
<b>Top</b>	Media exit to the copy output tray (top of printer).
<b>Side</b>	Media exits from the printer side.

### Procedure

1. Select the **finishing** feature group tab. If needed, refer to page 129.

The **finishing screen** is displayed..

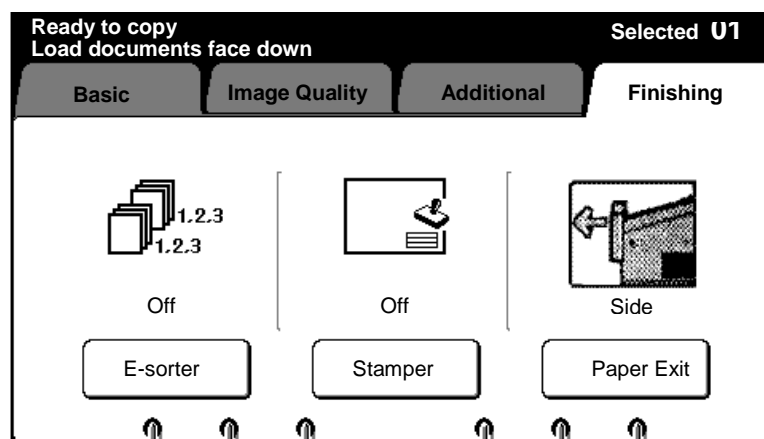

2. To change the paper exit area, select **paper exit button**. Else continue to step 5.

The **paper exit screen** is displayed.

3. Select the desired paper exit area; **top** or **side**.

To cancel your selection, select **cancel**.

4. Select **done**.
5. Insert the document to make copies.

# Stored jobs

## Introduction

The **stored jobs feature** is a convenient tool you can use to store frequently printed jobs or jobs that require complex feature programming. The MAX 200 can store a maximum of 80 jobs. Once you store a job, you can recall the job for print at any time.

It is a good idea to keep a catalog of your stored jobs and their feature settings. There are two logs and the end of this chapter; **Stored jobs log** and **Job feature log**.



*Note: Job numbers 79 and 80 have been setup to program the E-sorter.*

## How to store, recall or delete a job

### Procedure

1. If you want to store a job, select the desired copy features on the touch screen. Else continue to the next step.

The screenshot shows a touch screen interface with the following elements:

- Top row: A lamp icon, a "Check / Repair" button, a "Meter Check" button, a "Custom Presets" button, and a "Press to Open" button.
- Second row: "Information" button, a numeric keypad (1, 2, 3), and a "Document Counter" button.
- Third row: "Review" button, a numeric keypad (4, 5, 6).
- Fourth row: "Stored Jobs" button, a numeric keypad (7, 8, 9).
- Fifth row: "Power Save" button, a "." button, a "0" button, and a "Clear" button.
- Sixth row: "Interrupt" button with a flag icon, and a "Stop Document" button with a stop icon.
- Bottom row: "Clear All" button, a "Stop Copy" button with a stop icon, and a large empty rectangular area.

2. Press the **stored job button**.  
The stored job indicator lamp is lit and the **stored job screen** is displayed.

## How to store, recall or delete a job (continued)

---

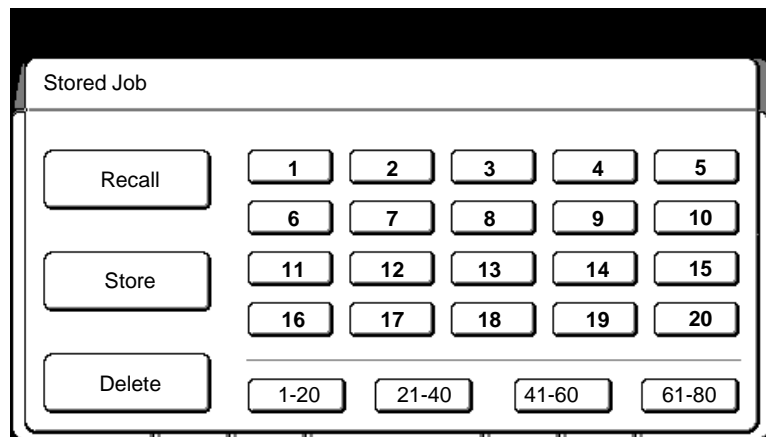

3. Select the desired stored job option; **recall**, **store**, or **delete**.
4. Select the desired number you want (1- 80) for the above selection (store, recall or delete).
  - If **recall** is selected, you may want to review the job settings. If desired, press the **review button**. For detailed information on how to use the review button, refer to page 25.
  - If **delete** is selected, a confirmation screen is displayed. Select **yes** to delete.
  - If **store** is selected, your job is assigned to the selected number (in step 4) and stored into machine memory.
5. To save your selections and exit, press the **stored job button**.



## Job feature log

Copy feature	Programmed feature					
<b>Media size</b>	E	D	C	B	A	
<b>Media type</b>	Other: _____					
	Vellum	Bond	Film			
<b>Reduction/enlargement</b>	200%	64.7%	25%			
	100%	129.4%	50%	Other: _____		
<b>Media cut</b>	Standard		Synchronized		Long copy	
	Variable length					
<b>Image density</b>	Black	Darker	Normal		Lighter	
	Red	Darker	Normal		Lighter	
<b>Document image type</b>	Line	Line/picture		Picture		
	Photo	Low contrast		Dark contrast		
	<b>Background suppression:</b>					
	Off					
	Fixed:	Maximum	Normal	Minimum		
	Variable:	Maximum	Normal	Minimum		
<b>Print color</b>	Black	Red	Black/red			
<b>Sharpness</b>	Maximum	Normal	Minimum			
<b>Scan color</b>	Red	Green	Other: _____			
	Blue	Yellow	Black			
<b>Scan color sensitivity</b>	Red	Blue	Green	Yellow	Others	Black
	Light					
	Normal					
	Dark					
<b>Image location</b>	From top: _____ mm					
	To right: _____ mm					
<b>Editing</b>	<b>Overall</b>					
	<b>Marker</b>		Outside area	Inside area		
	Marker color		Red	Yellow	Blue	
	<b>Coordinates</b>		Outside area	Inside area		
	X1: _____ mm		Y1: _____ mm			
	X2: _____ mm		Y2: _____ mm			
	Trim	Mask	Contrast reversal		Mirror image	
	Color drop					
	Red	Yellow	Green	Blue	Black	Others
	Color exchange					
	Red	Yellow	Green	Blue	Black	Others

## Job feature log (continued)

Copy feature	Programmed feature
<b>E-sorter</b>	Off                      On/sets banner sheets                      Yes      No
<b>Stamper</b>	On                      Off <b>Stamp location:</b> Auto or      Manual:                      X: ____ mm                      Y: ____ mm <b>Numbering:</b> Print                      No print Fixed                      Sequential <b>Date stamp:</b> Print                      No print Current                      Variable
<b>Folder connected</b>	Off Collation/with banner sheet                      Yes                      No Program      Number _____ P1 _____                      P2 _____ P3 _____ <b>Additional feature:</b> Binding margin: _____ mm Punch tab & reinforce First fold only <b>No fold: Exit</b> Printer                      Folder
<b>No folder is connected</b>	<b>Paper exit</b> Top                      Side



---

## How to customize the MAX 200

---

The MAX 200 provides you with the ability to customize various machine defaults. Defaults are machine features or options that are selected automatically without any operator intervention.

Use the custom presets feature to access the defaults. If desired, you can change any of these defaults to meet your specific needs. The custom presets screen contains three feature groups; system, copy, and storage/disk manager.

The following sections are in this chapter:

- Identifying the system features
- Identifying the copy features
- Identifying the storage/disk manager features
- How to enter custom presets
- How to change the system features
- How to change the copy features
- How to change the storage/disk manager features

## Identifying the system features

This section provides a identifies the custom presets system features. The factory default is shown bold.

Feature	Feature description and options
Time & date, page 176.	Sets up the current time and date for the machine. Options: Year, Month, Day, Hour, Minute <b>(2000,1,21,0,0)</b> .
Auto power off, page 177.	The machine automatically turns off after the preset time has elapsed. Options: <b>No</b> , 1, 2, 3, 4, 5 Hours.
Power save, page 178	The machine automatically reduces machine power consumption when the machine is not used for a selected period of time. Options: <b>No</b> , 1, 3, 5, 10, 20, 30 minutes.
Auto clear/backlight off, page 179.  Auto clear  Backlight off	After the preset time has elapsed, the machine automatically returns to the custom presets default settings.  After the preset time has elapsed, the touch screen backlight will turn off.  Each of these features can be on or off. The option times apply to each feature. Options: <b>No</b> , 30 sec., 1 minute, 1 minute 30 sec., 2 minutes, 2 minutes 30 sec., 3 minutes.
Attention tone, page 182.	Alerts the user when an accepted or unaccepted button is pressed. Options: <b>on</b> or off.  Normal one beep sounds when a button is pressed.  Alarm two beeps when an unacceptable button is pressed.  Ready to copy when the warm-up cycle is complete, when the machine beeps.
Document width, page 181.	Sets up the document width series the scanner recognizes. Options: 8.5 inch <b>9 inch</b>

## Identifying the system features (continued)

Feature	Feature description and options
<p>Plotter setup, page 183.</p> <p>Set default time to plot, page 183.</p> <p>Set delay time to copy, page 185.</p> <p>Folder, page 187.</p>	<p>Allows access to setup the plotter interface defaults.</p> <p>Sets up the delay time for switching to copy mode from plot mode. Options: <b>10 sec.</b>, 1 minute, 3 minutes, 5 minutes, 10 minutes, 20 minutes.</p> <p>Sets up the delay time from copy mode to plot mode. Options: <b>no delay</b>, 30 sec., 1 minute, 3 minutes, 5 minutes, 7 minutes, 10 minutes.</p> <p>Sets up the default fold for plot mode (this feature is not used with some plotter software). Options: P1, <b>no fold</b>, P2, P3.</p>
<p>Loading stamp data, page 190.</p>	<p>Sets the default for stamp data to be loaded manually or automatic. Options: auto load, <b>manual load</b>.</p>
<p>Additional setting, page 192.</p> <p>Automatic switching from roll to tray (copy mode)</p> <p>Automatic switching from roll to tray (plot mode)</p> <p>The starting point of stamp location</p> <p>Synchronized cutting with auto mode</p> <p>Default cut mode for auto mode when default for manual mode is set to long copy.</p>	<p>Provides additional system settings for future needs.</p> <p>Code: <b>10</b> Options: <b>on (0)</b>, off (1).</p> <p>Code: <b>11</b> Options: <b>on (0)</b>, off (1).</p> <p>Code: <b>110</b> Options: <b>lead edge (0)</b>, tail edge (1)</p> <p>Code: <b>200</b> Options: <b>off (0)</b>, on (1)</p> <p>Code: <b>210</b> Options: <b>standard (0)</b>, synchronized (1)</p>

## Identifying the copy features

This section provides a identifies the custom presets copy features.  
The factory default is shown bold.

Feature	Feature description and options
Reduce/enlarge presets, page 194.	Set the desired percentage for the 6 presets. Options: Preset 1- 25% to 400% ( <b>200%</b> ) Preset 2- 25% to 400% ( <b>141.1%</b> ) Preset 3- 25% to 400% ( <b>100%</b> ) Preset 4- 25% to 400% ( <b>70.7%</b> ) Preset 5- 25% to 400% ( <b>50.0%</b> ) Preset 6- 25% to 400% ( <b>25.0%</b> )
Media type and width for auto mode, page 196.	To program the auto media sizes to a specific media type. Options: E Bond, Vellum, Film, <b>Off</b> D Bond, Vellum, Film, <b>Off</b> C Bond, Vellum, Film, <b>Off</b> B Bond, Vellum, Film, <b>Off</b> A Bond, Vellum, Film, <b>Off</b>
Stamp location and orientation, page 198.	Sets up the stamp location and orientation (for the normal default) for each feed direction and media size, for the auto option on page 151.
E portrait	Location options: Min. (0 mm, 0 mm) Max (841 mm, 1189 mm) ( <b>5 mm, 10 mm</b> ). Direction options: <b>Normal</b> , 90°, 180°, 270° rotated.
D portrait	Location options: Min. (0 mm, 0 mm) Max (594 mm, 841 mm) ( <b>5 mm, 10 mm</b> ). Direction options: <b>Normal</b> , 90°, 180°, 270° rotated.
D landscape	Location options: Min. (0 mm, 0 mm) Max (841 mm, 594 mm) ( <b>5 mm, 10 mm</b> ). Direction options: <b>Normal</b> , 90°, 180°, 270° rotated.
C portrait	Location options: Min. (0 mm, 0 mm) Max (420 mm, 594 mm) ( <b>5 mm, 10 mm</b> ). Direction options: <b>Normal</b> , 90°, 180°, 270° rotated.
C landscape	Location options: Min. (0 mm, 0 mm) Max (594 mm, 420 mm) ( <b>5 mm, 10 mm</b> ). Direction options: <b>Normal</b> , 90°, 180°, 270° rotated.
B portrait	Location options: Min. (0 mm, 0 mm) Max (297 mm, 420 mm) ( <b>5 mm, 10 mm</b> ). Direction options: <b>Normal</b> , 90°, 180°, 270° rotated.
B landscape	Location options: Min. (0 mm, 0 mm) Max (420 mm, 297 mm) ( <b>5 mm, 10 mm</b> ). Direction options: <b>Normal</b> , 90°, 180°, 270° rotated.
A portrait	Location options: Min. (0 mm, 0 mm) Max (210 mm, 297 mm) ( <b>5 mm, 10 mm</b> ). Direction options: <b>Normal</b> , 90°, 180°, 270° rotated.
A landscape	Location options: Min. (0 mm, 0 mm) Max (297 mm, 210 mm) ( <b>5 mm, 10 mm</b> ). Direction options: <b>Normal</b> , 90°, 180°, 270° rotated.

## Identifying the copy features (continued)

Feature	Feature description and options
Date stamp format, page 201. Year Month Zero suppress Symbol	Modifies the stamp format.  Options: <b>YYYY</b> , 'YY, YY Options: <b>mm</b> , abc Options: <b>On</b> , Off Options: / . - or ,
Folder, page 203.	Sets up the MAX 200 folder programs for P1, P2 and P3.
Auto/ manual mode, page 212. Set magnification default Set media source default	Sets up the machine default mode of operation. It also sets up the media source default for manual mode.  Options: <b>Auto mode</b> , manual mode (sets up the default mode of operation).  Options: <b>Roll 1</b> , roll 2, roll 3, roll 4 , cut sheet tray (sets up the media source default for manual mode).
Media cut mode and document orientation, page 214. Media cut  Standard cut orientation default	Sets up the media cut default for auto and manual mode.  Options: <b>Standard</b> - for auto or manual mode Synchronized - for auto or manual mode <i>Note: To enable synchronized cut in auto mode, code 200 must be enabled in system features-additional settings, refer to page 169.</i> Long copy - for manual mode only <i>Note: To enable long copy for manual mode and synchronize or standard for auto mode, code 210 must be set in system features-additional settings, refer to page 169.</i>  Options: <b>Portrait</b> , landscape.
Lead/trail edge default for synchronize, page 216. Lead edge margin Trail edge margin	Sets up the default lead and trail edge margins for synchronized and long copy cut.  Options: Min. – 90 mm. Max – 999 mm <b>(0 mm)</b>  Options: Min. – 90 mm. Max – 999 mm <b>(0 mm)</b>

## Identifying the copy features (continued)

Feature	Feature description and options
Variable length default, page 218. Roll 1 Roll 2 Roll 3 Roll 4	Sets up the default output media length, for each roll.  Options: Min. – 210 mm, Max. – 4161 mm <b>(0 mm)</b> Options: Min. – 210 mm, Max. – 4161 mm <b>(0 mm)</b> Options: Min. – 210 mm, Max. – 4161 mm <b>(0 mm)</b> Options: Min. – 210 mm, Max. – 4161 mm <b>(0 mm)</b>
Background suppression level default, page 220. Fixed Variable	Sets up the default levels for variable and fixed backgrounds.  Options: 20 levels <b>(Level: 0)</b> Options: 9 levels <b>(Level: 0)</b>
Image density, page 223. Black Red	Sets up the image density levels for black and red.  Options: 9 levels <b>(Normal)</b> Options: 9 levels <b>(Normal)</b>
Document image type, page 224.	Sets the default document image type. Options: <b>Line</b> , Line/Picture, Picture, Photo
Scan to print color default, page 225.	Sets the default for scan to print color. Options: <b>Red</b> , Blue, Green, Yellow, Black, Others.
Color recognition range, page 226. Red (marker color) Blue (marker color) Yellow (marker color) Red (scanner sensitivity) Blue (scanner sensitivity) Green (scanner sensitivity) Yellow (scanner sensitivity)	Sets the default for the color recognition range.  Options: 0 – 100 (CCW) <b>(50 – 70 CCW)</b> Options: 150 – 270 (CCW) <b>(195 – 230 CCW)</b> Options: 270 – 360 (CCW) <b>(340 – 5 CCW)</b> Options: 0 – 226 (CCW) <b>(28 – 90 CCW)</b> Options: 90 – 360 (CCW) <b>(185 – 236 CCW)</b> Options: 128 – 360 (CCW) <b>(236 – 360 CCW)</b> Options: 225 – (360) – 90 (CCW) <b>(0 – 28 CCW)</b>

## Identifying the copy features (continued)

Feature	Feature description and options
Marker area recognition, page 229.	Sets up the edit marker default recognition area and the edit marker default marker color, the machine recognizes.
Recognition area	Options: <b>Inside marker include line</b> , inside marker exclude line, marker line only.
Marker color	Options:       Red, blue, yellow
Additional setting, page 231.	Provides additional copy settings for future needs.
Auto mode document feed direction default	Code: <b>20</b> Options: Landscape 1, <b>portrait 0</b> .

## Identifying the storage/disk manager features

This section provides a identifies the custom presets storage/disk manager features.

Feature	Feature description and options
Stamp creation/deletion, page 233.	Create, store, or delete a stamp. Options:       Stamp create/store, stamp delete.
Disk manager (format/duplication), page 245.	Formats the floppy disk or copies stamp data from the floppy disk. Options:       Format disk for stamp, copy disk for stamp.
E-sorter program storage, page 249.	A maximum of 300 programs can be created. Each program can have up to 40 customers associated with it. Options:       1 to 300 programs.

# How to enter custom presets

## Introduction

The **custom presets feature** provides access to various machine defaults. You can customize these defaults to meet your specific needs.

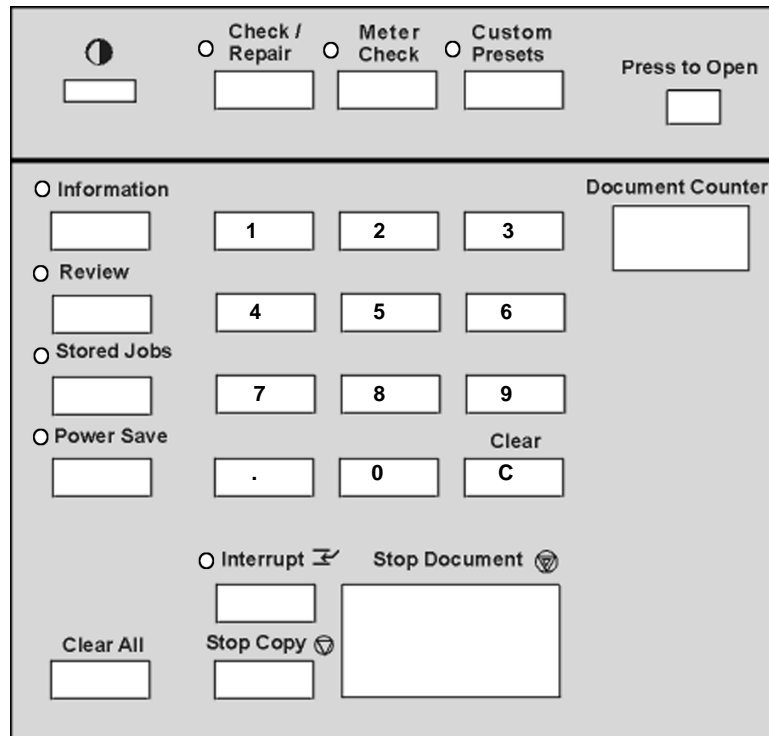

## Procedure

1. Press the **press to open** latch, lift up the scanner control panel cover.
2. If the machine is in plot mode, enter the copy mode. Else continue to the next step. For detailed information on how to enter copy mode, refer to page 277.
3. Press the **custom presets button**.  
The **system features screen** is displayed.



## How to enter custom presets (continued)

---

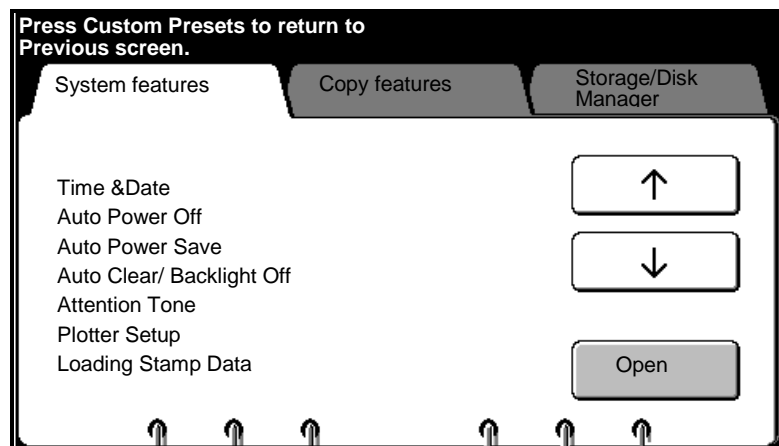

4. Select the desired custom presets tab. **System**, **copy** or **storage/disk manager**.
5. Select the desired feature using the arrow buttons.
6. Select **open**.
7. Go to the desired selection:
  - **System features**, page 176.
  - **Copy features**, page 194.
  - **Storage/disk manager**, page 233.

# How to change the system features

## Time & date

### Introduction

The **time & date feature** sets up the current time and date for the machine.

### Procedure

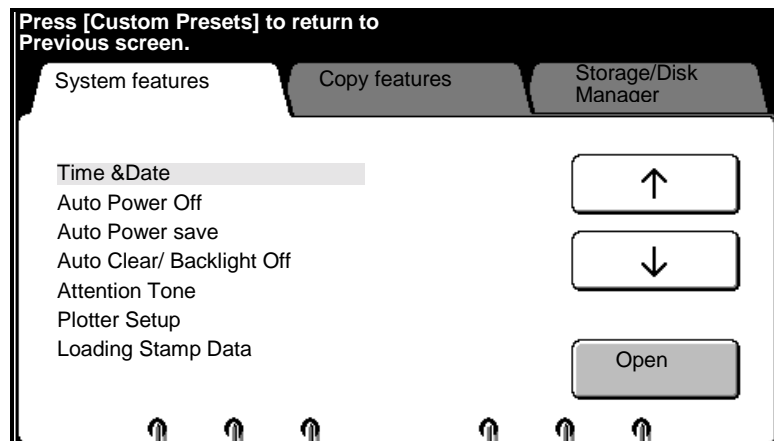

1. Enter custom presets. If needed, refer to page 174.
2. Select the **system features** tab.
3. Use the arrow buttons to select the **time & date** feature.
4. Select **open**.

The **time & date screen** is displayed.

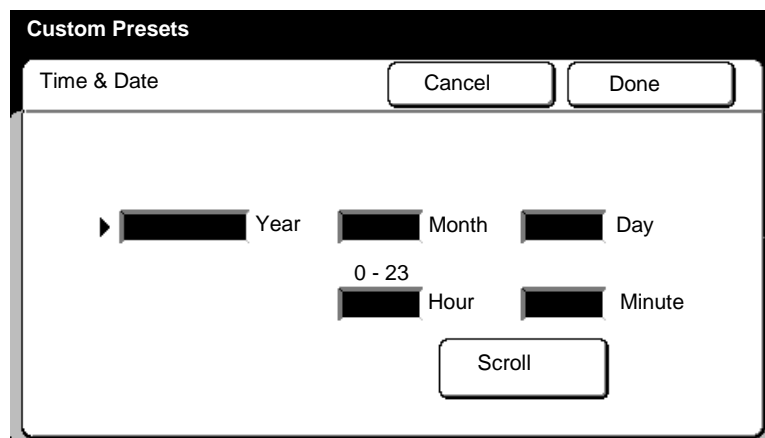

5. Select **scroll** to move to different fields. Use the numeric keypad to enter the data.
6. Select **done** to store your changes and exit from this screen.  
To cancel the changes and exit from this screen, select **cancel**.
7. To exit, press the **custom presets button**.

# How to change the system features (continued)

## Auto power off

### Introduction

The **auto power off feature** switches the machine power off, if the machine is not used for a selected period of time. You set the time period.

### Procedure

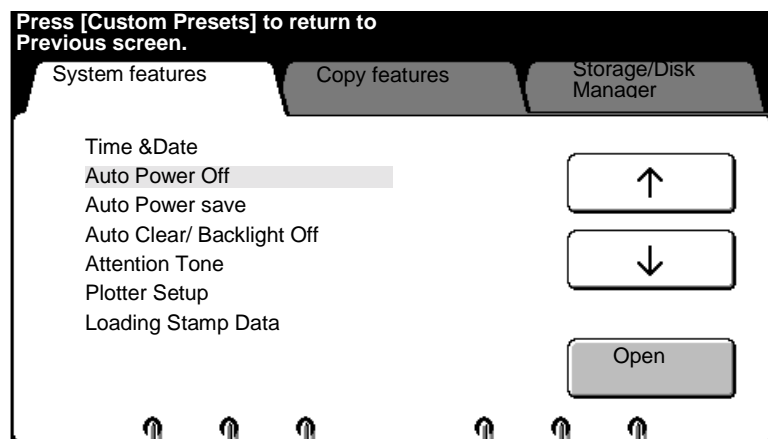

1. Enter custom presets. If needed, refer to page 174.
2. Select the **system features** tab.
3. Use the arrow buttons to select the **auto power off** feature.
4. Select **open**.

The **auto power off screen** is displayed.

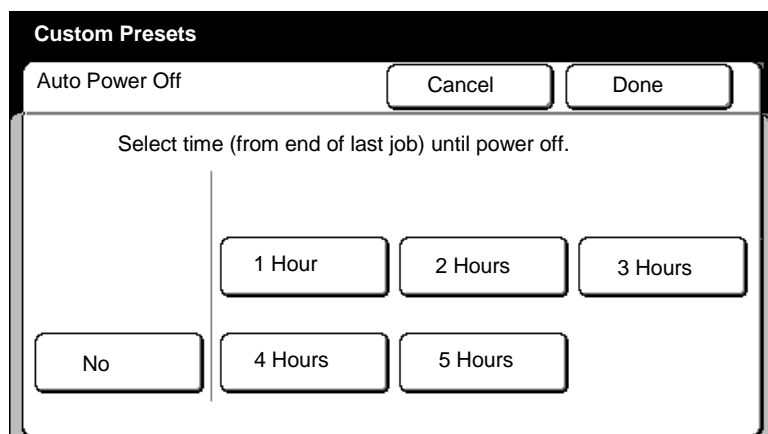

5. Select the desired default time; **No, 1 – 5 hours**.
6. Select **done** to store your changes and exit from this screen.  
To cancel the changes and exit from this screen, select **cancel**.
7. To exit, press the **custom presets button**.

# How to change the system features (continued)

## Auto power save

### Introduction

The **auto power save feature** reduces the machine power if the machine is not used for a selected period of time. You set the time period.

### Procedure

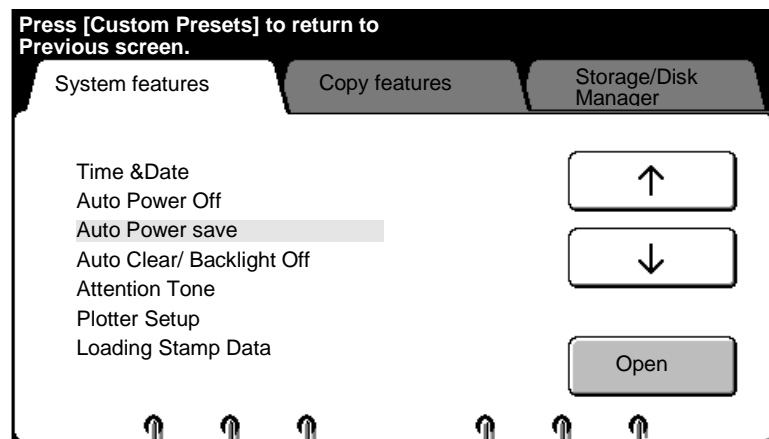

1. Enter custom presets. If needed, refer to page 174.
2. Select the **system features** tab.
3. Use the arrow buttons to select the **power save** feature.
4. Select **open**.

The **auto power save screen** is displayed.

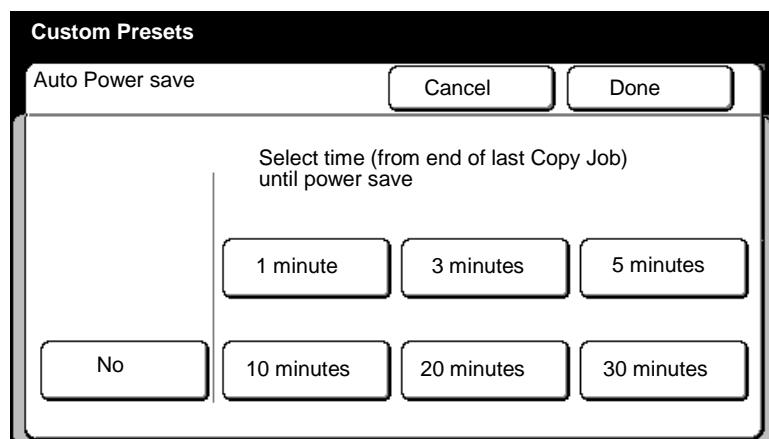

5. Select the desired time; **No, 1 – 30 minutes**.
6. Select **done** to store your changes and exit from this screen.  
To cancel the changes and exit from this screen, select **cancel**.
7. To exit, press the **custom presets button**.

## How to change the system features (continued)

### Auto clear/backlight off

#### Introduction

After a job is completed, the **auto clear feature** resets the job settings to the default values. To meet your requirements, change the time it takes for the machine to reset the default values.

The **backlight feature** sets the period of time for the touch screen backlight to turn off, after a job is complete. You set the default time period.

If both **auto clear** and **backlight** are set to yes, then each feature occurs at the same time.

#### Procedure

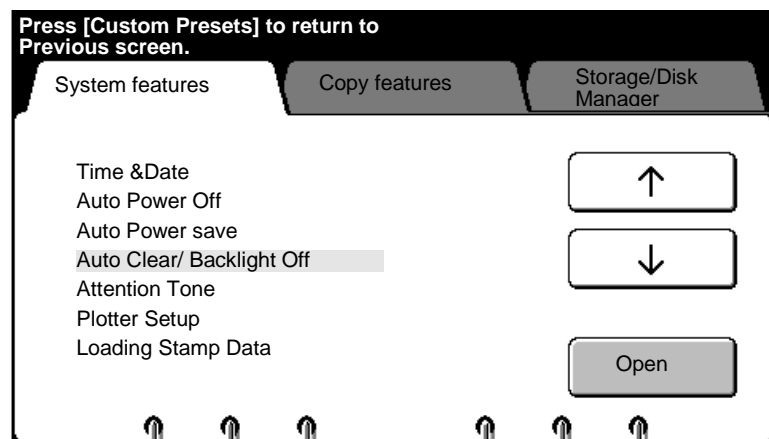

1. Enter custom presets. If needed, refer to page 174.
2. Select the **system features** tab.
3. Use the arrow buttons to select the **auto clear/backlight off** feature.
4. Select **open**.

The **auto clear/backlight off screen** is displayed.

## How to change the system features (continued)

---

### Auto clear/backlight off (continued)

---

The screenshot shows a menu titled "Custom Presets" with a sub-header "Auto Clear/ Backlight Off". At the top right are "Cancel" and "Done" buttons. The menu is divided into two sections: "Auto Clear" and "Backlight off".

Auto Clear		Select delay time from end of last copy job	
Yes	No	30 sec	1 Min
		1 Min 30 sec	2 Min
Backlight off		2 Min 30 sec	3 Min
Yes	No		

5. Select the desired auto clear option, **yes** or **no**.  
If **yes** is select, select the desired time. Else continue to the next step.
6. Select the desired backlight option, **yes** or **no**.
7. Select **done** to store your changes and exit from this screen.  
To cancel the changes and exit from this screen, select **cancel**.
8. To exit, press the **custom presets button**.

# How to change the system features (continued)

## Document width

### Introduction

The **document width feature** sets up the document series the scanner recognizes in auto mode.

### Procedure

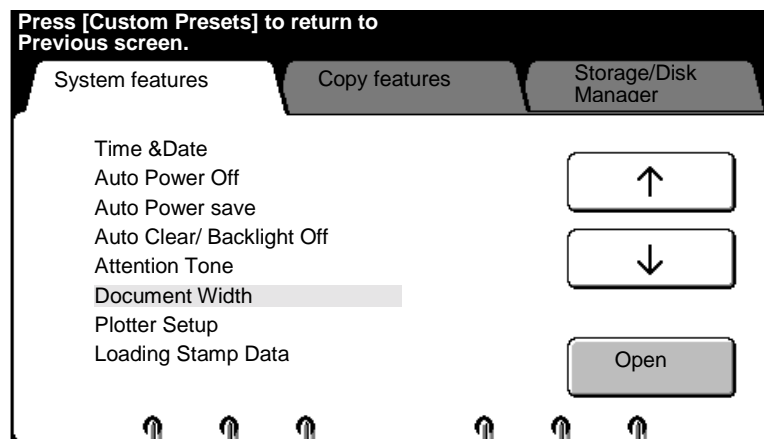

1. Enter custom presets. If needed, refer to page 174.
2. Select the **system features** tab.
3. Use the arrow buttons to select the **document width** feature.
4. Select **open**.

The **document width screen** is displayed.

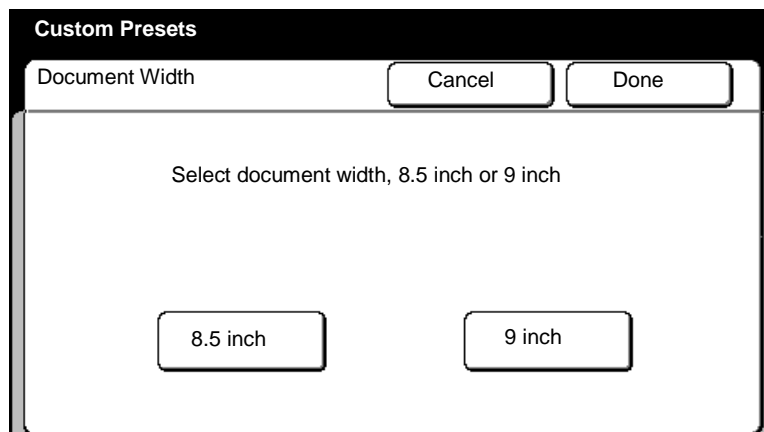

5. Select **8.5 inch** or **9 inch**.
6. Select **done** to store your changes and exit from this screen.  
To cancel the changes and exit from this screen, select **cancel**.
7. To exit, press the **custom presets button**.

# How to change the system features (continued)

## Attention tone

### Introduction

The **attention tone feature** sets up an audible tone to inform you of certain machine conditions.

### Procedure

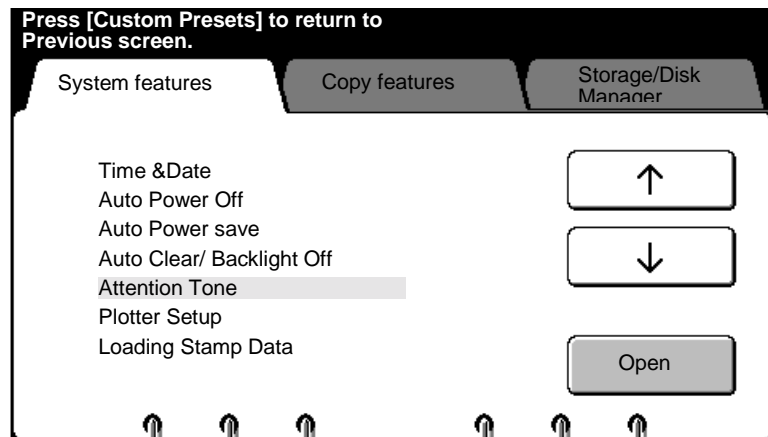

1. Enter custom presets. If needed, refer to page 174.
2. Select the **system features** tab.
3. Use the arrow buttons to select the **attention tone** feature.
4. Select **open**.

The **attention tone screen** is displayed.

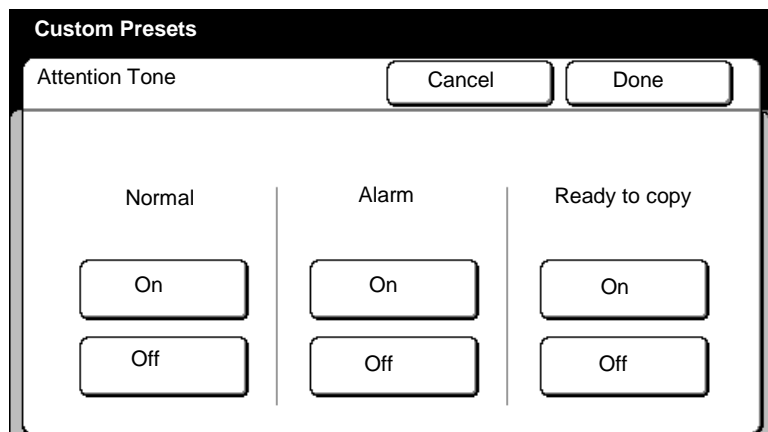

5. Select the desired option; **on** or **off**.

**Normal** The machine beeps once when a button is pressed.

**Alarm** When an unavailable button is pressed, the machine beeps twice

**Ready to copy** When the warm-up cycle is complete, the machine beeps.

6. Select **done** to store your changes and exit from this screen.

To cancel the changes and exit from this screen, select **cancel**.

7. To exit, press the **custom presets button**.



# How to change the system features (continued)

## Plotter setup

### Introduction

The **plotter setup** allows access to the plotter setup features. There are three setup features available:

Feature	Function
<b>Set default time to plot</b>	Sets up the time delay from copy mode to plot mode. Refer to page 183.
<b>Set delay time to copy mode</b>	Sets up the time delay it takes from plot mode to copy mode. Refer to page 185.
<b>Folder</b>	Sets up the fold default for plot mode. Refer to page 187.

### Set default time to plot

### Procedure

1. Enter custom presets. If needed, refer to page 174.

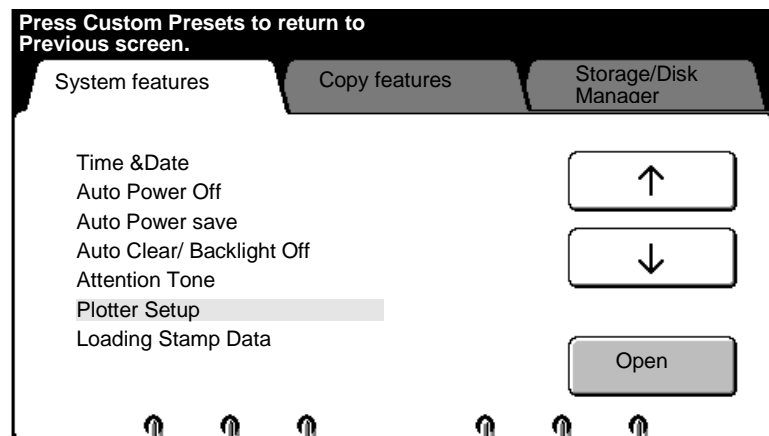

2. Select the **system features** tab.
3. Use the arrows to select the **plotter setup** feature.
4. Select **open**.

The **plotter setup** screen is displayed.

## How to change the system features (continued)

### Plotter setup (continued)

#### Set default time to plot (continued)

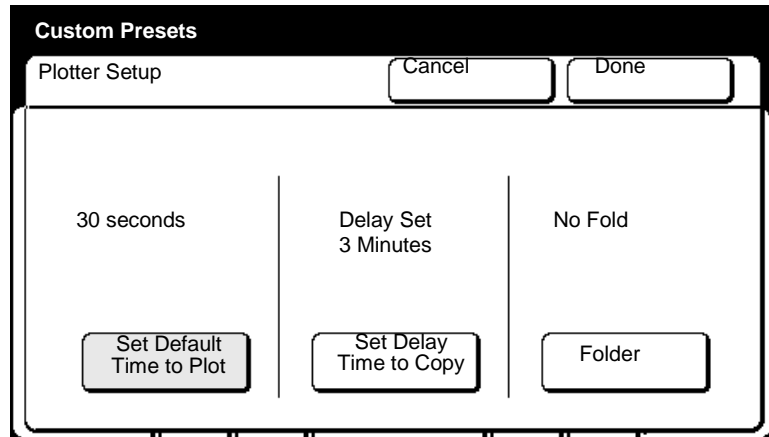

5. Select **set default time to plot**.

The **set default time to plot mode screen** is displayed.

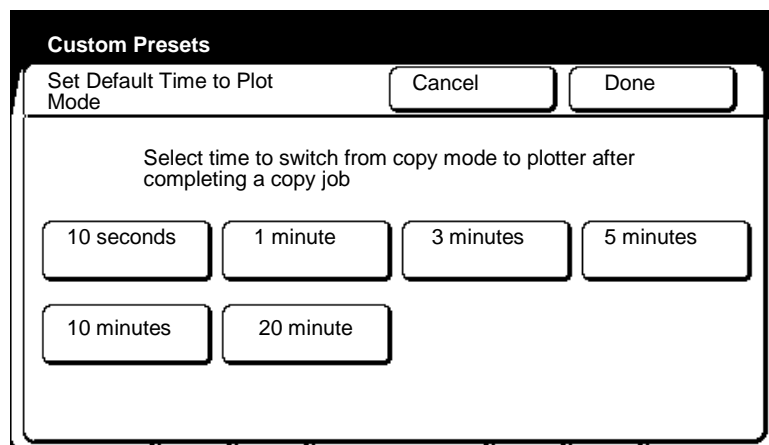

6. Select the desire time; **10 seconds, 1, 3, 5, 10, 20 minutes**.
7. Select **done** to store your changes and to exit from the current screen.  
To cancel the changes and exit from this screen, select **cancel**.
8. To exit, press the **custom presets button**.

# How to change the system features (continued)

## Plotter setup (continued)

### Set delay time to copy mode

#### Procedure

1. Enter custom presets. If needed, refer to page 174.

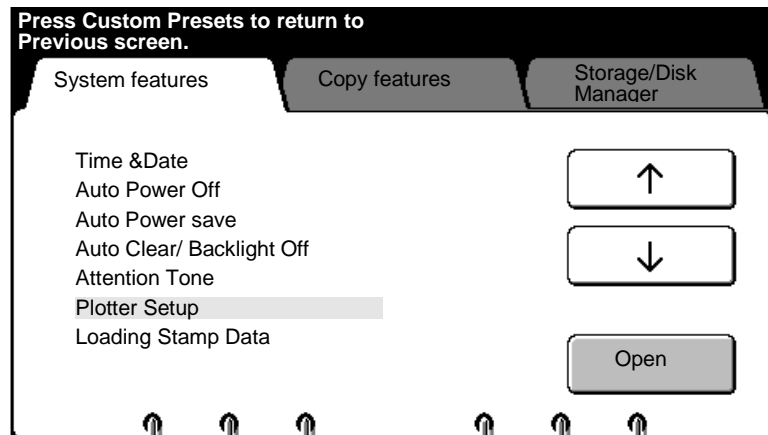

2. Select the **system features** tab.
3. Use the arrows to select the **plotter setup** feature.
4. Select **open**.

The **plotter setup** screen is displayed.

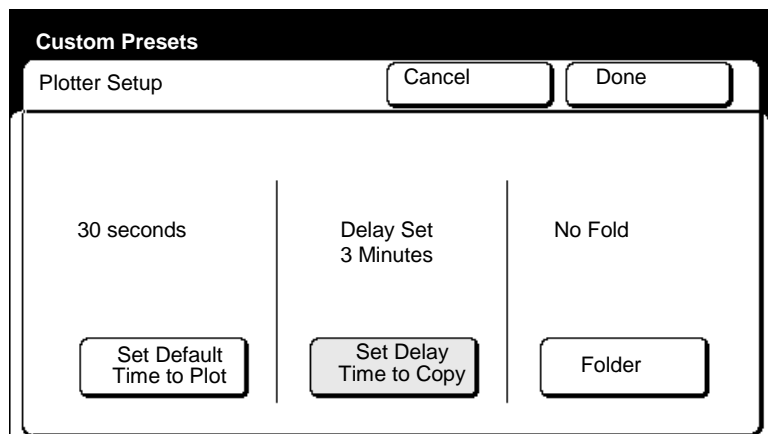

5. Select **set delay time to copy**.

The **set delay time to copy** screen is displayed.

## How to change the system features (continued)

---

### Plotter setup (continued)

---

#### Set delay time to copy mode (continued)

---

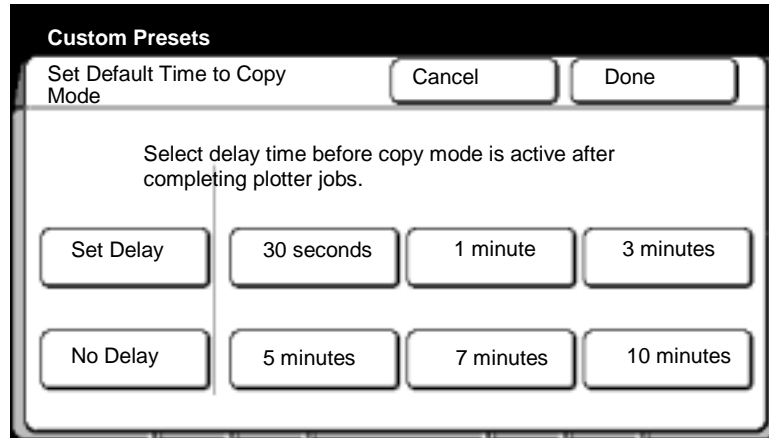

6. Select the desired option; **set delay** or **no delay**.  
If **set delay** is selected, select the desired time default; **30 seconds, 1, 3, 5, 7, 10 minutes**.
7. Select **done** to store your changes and exit from this screen.  
To cancel the changes and exit from this screen, select cancel.
8. To exit, press the **custom presets button**.

# How to change the system features (continued)

## Plotter setup (continued)

### Folder



*Note: If your system has a folder, do not put A or A4 size cut sheet into the tray 5, short edge feed. Refer to your user guide for detailed information.*



*Note: Film/Mylar and vellum can not be folded.*

#### Introduction

This **folder feature** sets up the fold default for plot mode.

There are three fold options available, P1, P2, and P3. You can also select no fold (this option is usually for systems with a stacker).

#### Procedure

1. Enter custom presets. If needed, refer to page 174.

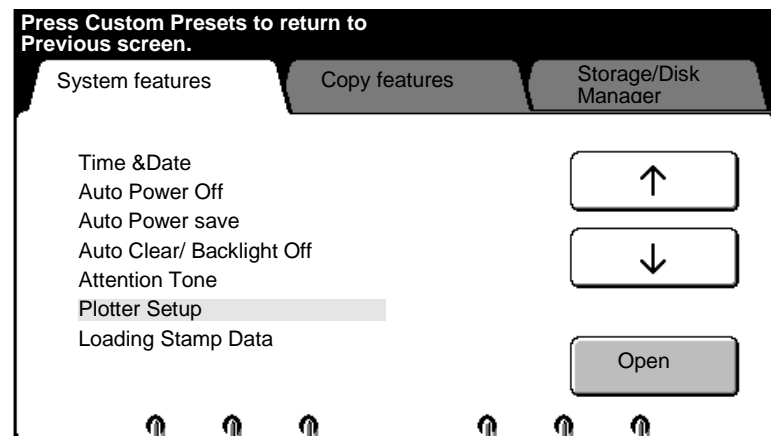

2. Select the **system features** tab.
3. Use the arrows to select the **plotter setup** feature.
4. Select **open**.

The **plotter setup screen** is displayed.

## How to change the system features (continued)

### Plotter setup (continued)

#### Folder (continued)

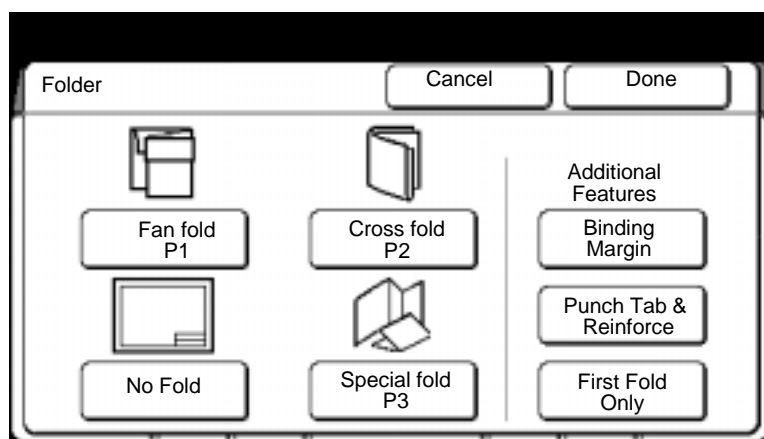

5. Select the desired fold default for plot mode; **P1**, **P2**, **no fold**, or **P3**. To change P1, P2, or P3 parameters, refer to page 203.



**Caution:** You can set up P1, P2, or P3 to folds other than P1= fan fold, P2 = cross fold, and P3 = special fold at the folder, but the above screen displays P1= fan fold, P2 = cross fold, and P3 = special fold. Ensure to power off and power on, the folder, after changing any of the folds, other than what is displayed on the above touch screen.

- |                     |   |
|---------------------|---|
| <b>Fan fold</b>     | Produces copies folded to A-size, but all panels may not be equal in size. With fan fold you can add a binding margin.  |
| <b>Cross fold</b>   | Produces copies folded in A-size, with all panels of equal size. You can not add a binding margin when cross fold is selected.  |
| <b>No fold</b>      | If no fold is selected, the right column of the screen changes to the exit column. Select the desired exit option; <b>printer</b> or <b>folder</b> .  |
| <b>Special fold</b> | Produces other folds according to the setup of the folder. If your folder provides other fold operations, follow the folder user guide to set the machine to the other fold.<br><br>Select the <b>P3</b> option, to set the fold default to special fold. |

## How to change the system features (continued)

---

### Plotter setup (continued)

---

#### Folder (continued)

---

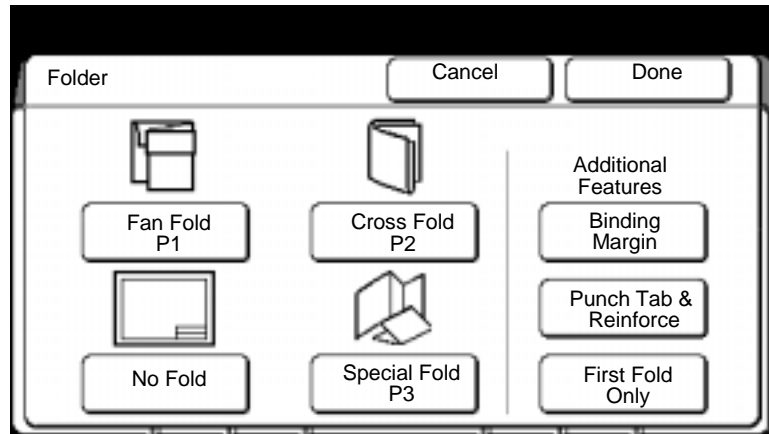

6. If available and desired select the desired additional features.

**Binding margin** The default preset margin value from custom presets is used (If needed, refer to folder setup, page 203).

**Punch tab & reinforce** Select if your output media is punch tab or reinforced.

**First fold only** This feature performs the first fold only for fan or cross fold (first fold is perpendicular to media travel). All copies exit the front of the printer.

To cancel your selections, select **cancel**.

7. Insert the document to make copies, or select **done** as required to select other touch screen features.

## How to change the system features (continued)

### Loading stamp data

#### Introduction

The **loading stamp data feature** allows you to load stamp data automatically or manually from the floppy disk drive.

If the loading stamp feature is set to auto, the machine automatically loads the stamp data at power-on. When set to manual, the machine allows you to load the stamp data from the stamp pattern screen.

#### Procedure

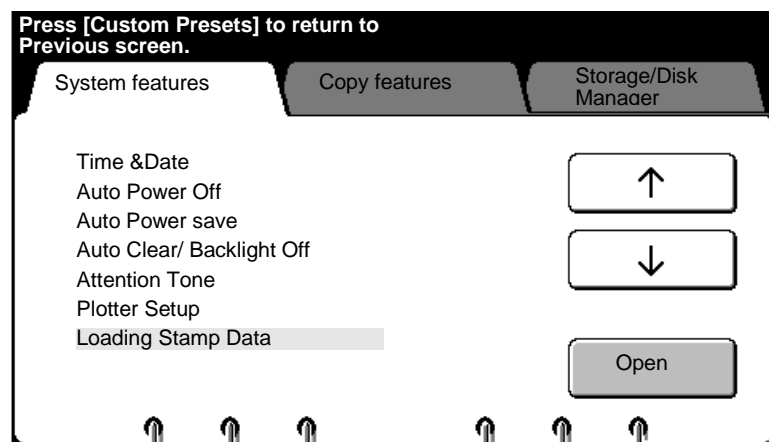

1. Enter custom presets. If needed, refer to page 174.
2. Select the **system features** tab.
3. Use the arrow buttons to select the **loading stamp data** feature.
4. Select **open**.

The **loading stamp data screen** is displayed.



## How to change the system features (continued)

---

### Loading stamp data (continued)

---

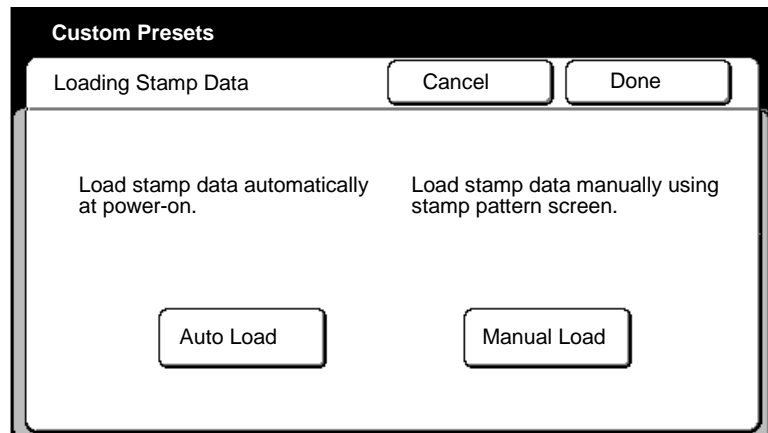

5. Select the desired load option.
  - Auto load** Stamp data is automatically loaded from the floppy disk drive at power-on.
  - Manual load** Stamps are loaded from the stamp pattern screen.
6. Select **done** to store your changes and exit from this screen.  
To cancel the changes and exit from this screen, select **cancel**.
7. To exit, press the **custom presets button**.

# How to change the system features (continued)

## Additional setting

### Introduction

The **additional setting feature** provides additional system default settings, for future needs.

Depending on the code entered, the MAX 200 allows you to further customize your machine. If needed, service will provide you with the additional setting code and field value.

The identified additional settings codes are:

- Automatic switching from roll to tray (copy mode), code 10.
- Automatic switching from roll to tray (plot mode), code 11.
- Trail edge starting point of stamp location, code 110.
- Enable synchronize cut in auto mode, code 200.
- Default cut mode for auto mode, when manual mode cut default is set to long copy, code 210.

For detailed information about the identified codes, refer to page 169.

### Procedure

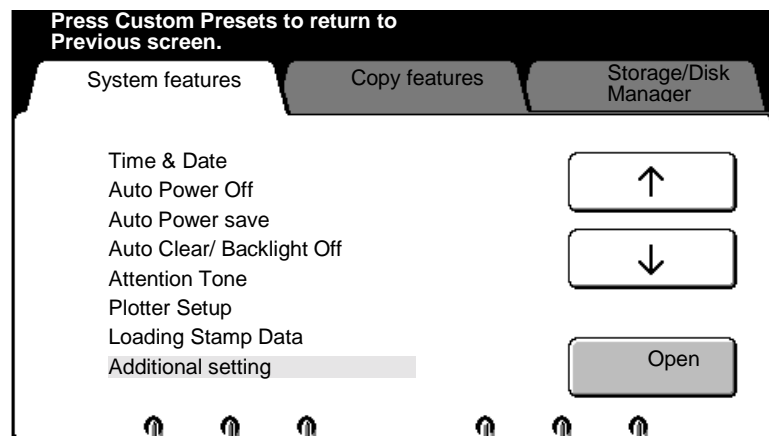

1. Enter custom presets. If needed, refer to page 174.
2. Select the **system features** tab.
3. Use the arrow buttons to select the **additional setting** feature.
4. Select **open**.

The **additional setting (system feature) screen** is displayed.

## How to change the system features (continued)

---

### Additional setting (continued)

---

The screenshot shows a dialog box titled "Custom Presets" with a subtitle "Additional Setting (System Feature)". At the top right of the dialog are "Cancel" and "Done" buttons. The main area contains three input fields: "Code", "Current", and "New". The "Code" field is currently empty. The "Current" field contains a value. The "New" field is currently empty. At the bottom right of the dialog is a "Scroll" button.

5. Enter the additional setting code in the code field, using the numeric keypad (service supplies code or it is listed on page 169).  
The code is displayed in the code field.
6. Select **scroll** to move to the new field.  
The current value is displayed in the current field.
7. Enter the value in the new field, using the numeric keypad (service supplies code or it is listed on page 169).  
The new value is displayed in the new field.
8. Select **done** to store your changes and exit from this screen.  
To cancel the changes and exit from this screen, select **cancel**.
9. To exit, press the **custom presets button**.

# How to change the copy features

---

## Reduce/enlarge presets

---

### Introduction

The **reduce/enlarge presets feature** sets up the default reduce and enlarge presets.

### Procedure

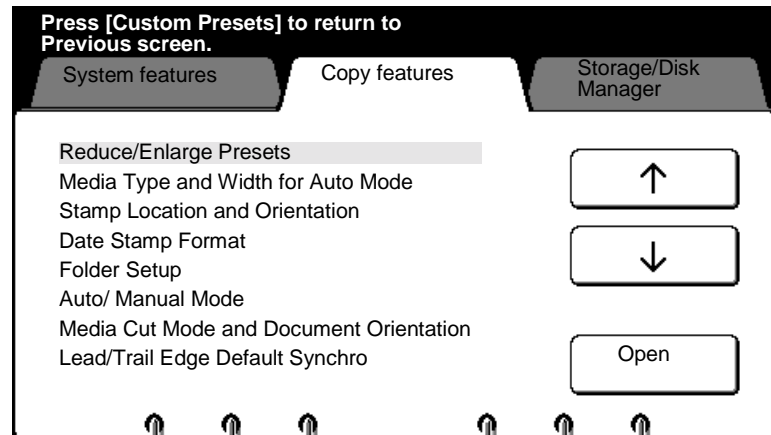

1. Enter custom presets. If needed, refer to page 174.
2. Select the **copy features** tab.
3. Use the arrow buttons to select the **reduce/enlarge presets** feature.
4. Select **open**.

The **reduce/enlarge presets screen** is displayed.

## How to change the copy features (continued)

---

### Reduce/enlarge presets (continued)

---

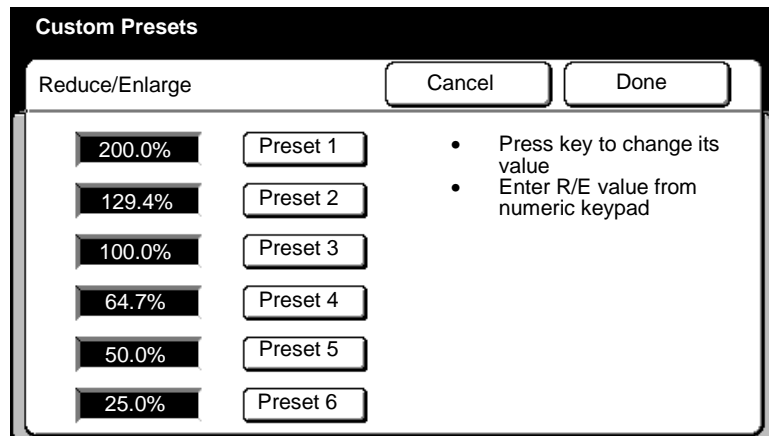

5. Select the desired **preset number**. Use the numeric keypad to enter the desired percentage.  
Any percentage from 25 to 400% in 0.1% increments may be entered. The new value is displayed in the % window.
6. Select **done** to store your changes and exit from this screen.  
To cancel the changes and exit from this screen, select **cancel**.
7. To exit, press the **custom presets button**.

# How to change the copy features (continued)

## Media type and width for auto mode

### Introduction

The **media type and width for auto mode feature** sets up the default media type for each output size (for auto mode). This custom presets feature enables the auto mode panel to display the identified roll information.

### Procedure

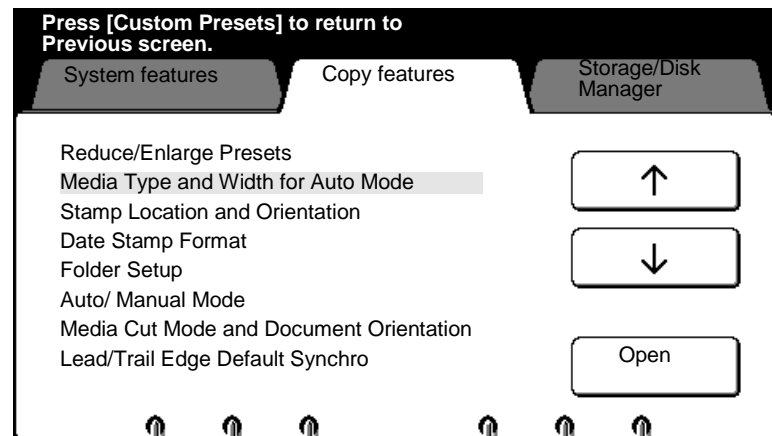

1. Enter custom presets. If needed, refer to page 174.
2. Select the **copy features** tab.
3. Use the arrow buttons to select the **media type and width for auto mode** feature.
4. Select **open**.

The **media type and width for auto mode screen** is displayed.

## How to change the copy features (continued)

---

### Media type and width for auto mode (continued)

---

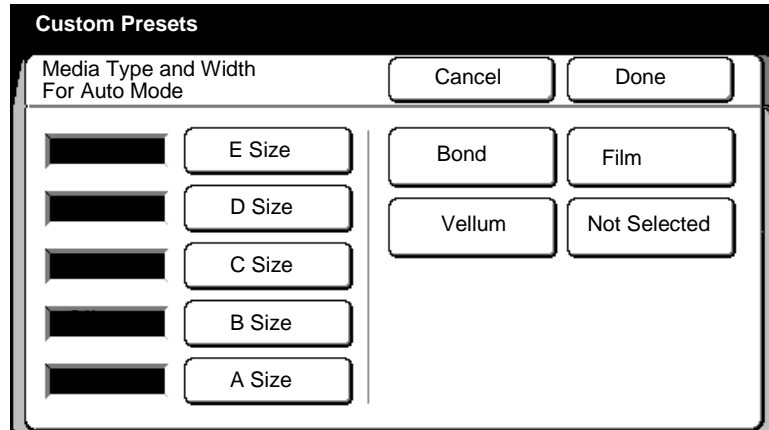

5. Select the sheet **size**.
6. Select the desired **media type**, for the size. If you do not want to specify the media type, select **not selected**.
7. Repeat steps 5 and 6 for other sizes. Else continue.
8. Select **done** to store your changes and exit from this screen.  
To cancel the changes and exit from this screen, select **cancel**.
9. To exit, press the **custom presets button**.

# How to change the copy features (continued)

## Stamp location and orientation

### Introduction

The **stamp location and orientation feature** sets up the stamp location and orientation, for each media size and feed direction for the stamper auto option. The auto option is on page 151.

To learn how to create a stamp pattern, refer to page 237.

<b>Stamp location</b>	<b>Auto</b>	Sets up the stamp location parameters for the auto option on page 151.
<b>Stamp orientation</b>	<b>Normal - 270°</b>	Sets up the auto stamp orientation for the auto option on page 151.

### Procedure

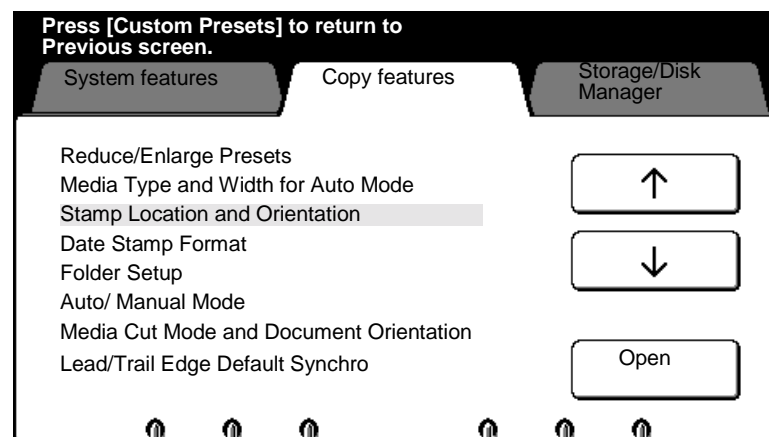

1. Enter custom presets. If needed, refer to page 174.
2. Select the **copy features** tab.
3. Use the arrow buttons to select the **stamp location and orientation** feature.
4. Select **open**.

The **stamp location and orientation screen** is displayed



## How to change the copy features (continued)

### Stamp location and orientation (continued)

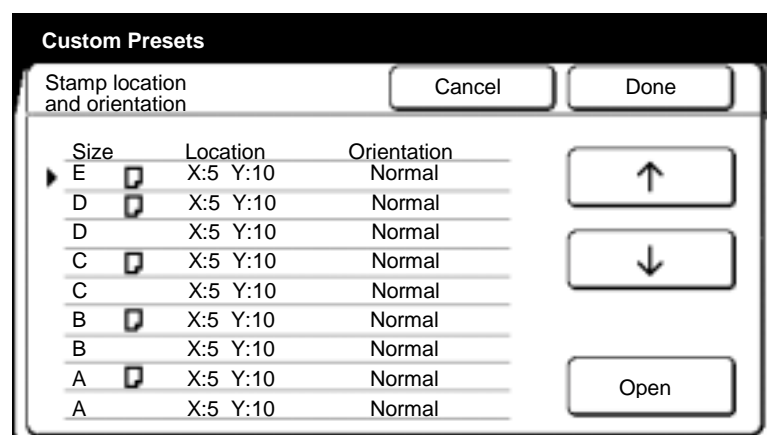

5. To change the stamp location, use the arrow buttons to select the desired document size and feed direction.

6. Select **open**.

The **stamp location and orientation screen** is displayed.

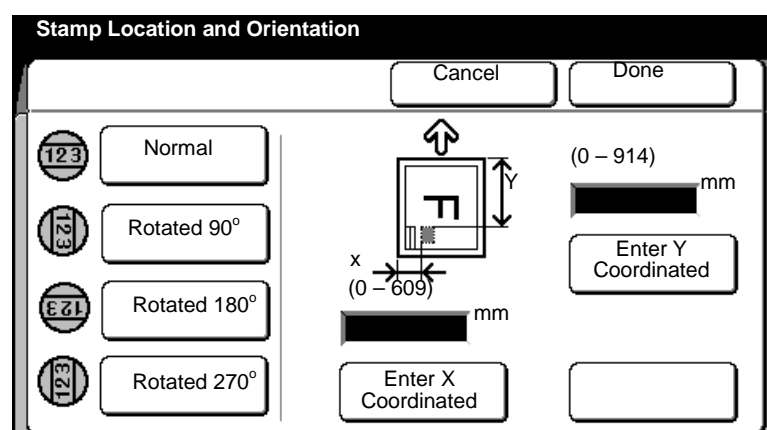

7. Select the desired stamp orientation for the normal option on page 151; **Normal**, **90°**, **180°**, or **270°**.

When the stamp image is scanned (normally portrait), the scanned position becomes the default for normal. When 90°, 180°, or 270° is selected, the stamp is rotated 90°, 180°, or 270° from the default.

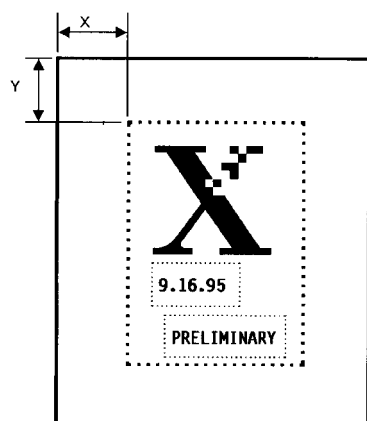

8. Select **enter x coordinate** (you are setting up the x coordinate of the stamp location). Enter the desired dimension using the numeric keypad.

Measure from the left edge of the paper to the left side of the desired stamp location.

## How to change the copy features (continued)

### Stamp location and orientation (continued)

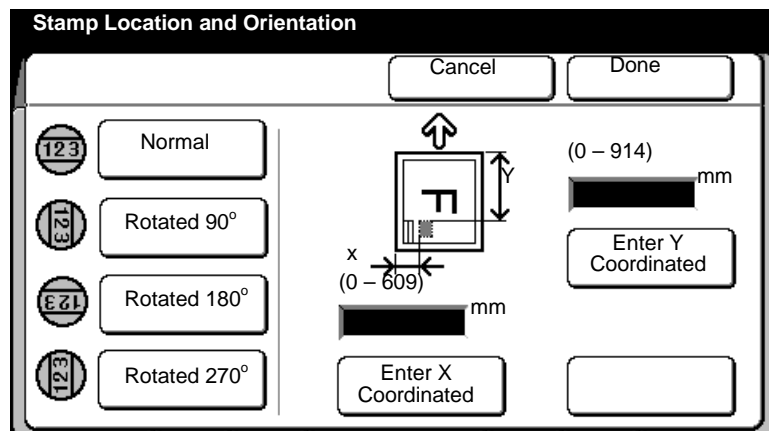
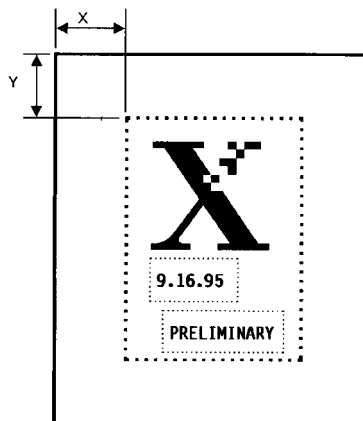

9. Select **enter y coordinate** (you are setting up the y coordinate of the stamp location). Enter the desired dimension using the numeric keypad.

Measure from the lead edge of the paper to the top of the stamp location or refer to additional setting code 110, on page 173.

10. Select **done** to store your changes and exit from this screen.

To cancel the changes and exit from this screen, select **cancel**.

11. To exit, press the **custom presets button**.

# How to change the copy features (continued)

## Date stamp format

### Introduction

The **date stamp format feature** sets up the default format for the date stamp. The date stamp is printed as 14 point Gothic, and can not be changed.

### Procedure

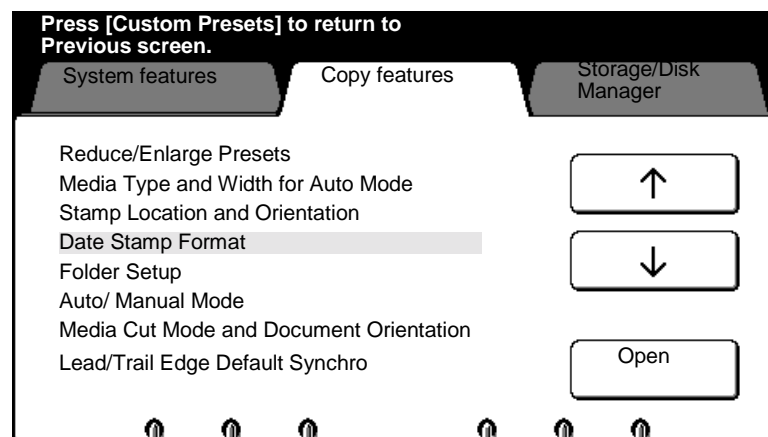

1. Enter custom presets. If needed, refer to page 174.
2. Select the **copy features** tab.
3. Use the arrow buttons to select the **date stamp format** feature.
4. Select **open**.

The **date stamp format screen** is displayed.

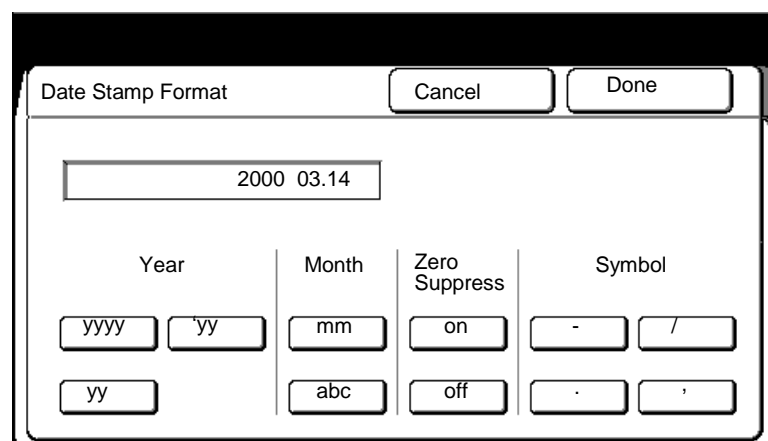

5. Select the desired year format, **yyyy**, **'yy**, **yy**.

## How to change the copy features (continued)

---

### Date stamp format (continued)

---

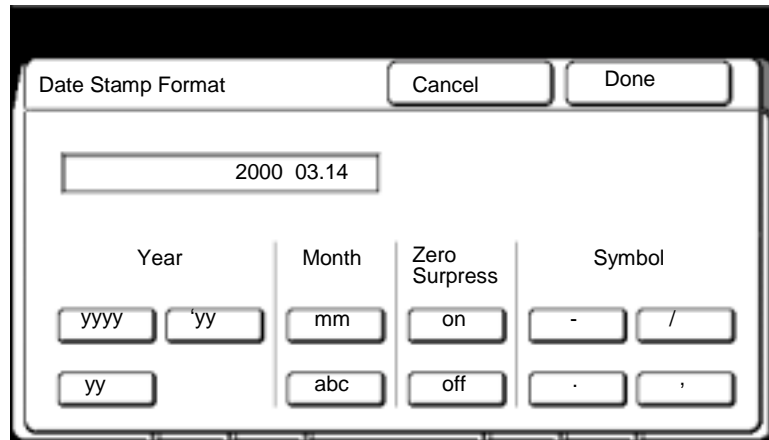

6. Select the desired month format.
  - mm** Prints the month, 01 – 12.
  - abc** Prints the month, JAN, FEB, MAR, APR, MAY, JUN, JUL, AUG, SEP, OCT, NOV or DEC.
7. If needed, select the zero suppress button.

If **off** is selected, the zero suppress option removes the month and day zeros. Example: The date stamp would read 2000.3.14.
8. Select the desired symbol.

The selected symbol is printed between the year, day and month.
9. Select **done** to store your changes and exit from this screen.

To cancel the changes and exit from this screen, select **cancel**.
10. To exit, press the **custom presets button**.

# How to change the copy features (continued)

## Folder setup



*Note: If your system is set up with a folder, do not put A or A4 size media into the tray 5, short edge feed. Refer to your user guide for detailed information.*

### Introduction

The MAX 200 **folder setup feature**, sets up the MAX 200 fold parameters for three folds assigned to P1, P2 and P3. For detailed information on the type of folds refer to the section, *Folder terminology*.

Once the MAX 200 program fold parameters are setup, you can program the fold default for copy mode and plot mode. To go directly to the folder setup procedure go to page 205.

- To setup the fold default for copy mode, refer to page 159.
- To setup the fold default for plot mode, refer to page 187.

To go directly to the folder setup procedure go to page 205.

## Folder terminology

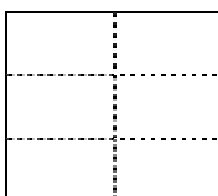
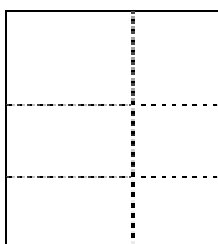

### Fan fold

Creates packages folded to A-size, panels do not need to be equal size. Binding margins can be added to fan fold.

### Cross fold

Creates packages folded to A-size, panels are not equal in size. No binding margin can be added.

### Other packet sizes available

Punch, tab, reinforce	Smaller, Bigger	Packet size
Off	Smaller	185 x 297 mm
Off	Standard	190 x 297 mm
Off	Bigger	198 x 297 mm
On	Smaller	198 x 297 <sup>2</sup> mm
On	Standard	198 x 297 mm or 210 x 297 <sup>3</sup> mm
On	Bigger	210 x 297 mm

<sup>2</sup> Tabs sticks out 12 mm from paper, the full packet is 198+ 12= 210 mm wide.

<sup>3</sup> The folder can be set to 198 or 210 as the standard size for tabs to be added to.

# How to change the copy features (continued)

---

## Folder setup (continued)

---

### Folder terminology (continued)

---

#### Special fold

If your folder provides other folds, you can setup the folder default to special fold. This option creates a fold according to the setup at the folder. The width of the package is set at the folder. Refer to your folder user guide for detailed information.

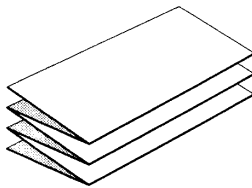

#### First fold

The first of two folds, it is always perpendicular to the copy length as the media travels through the printer. Package exits out the front of the machine.

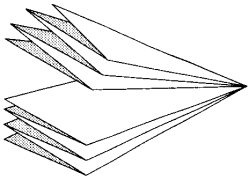

#### Second fold

The second of two folds, it is always parallel to the copy length as the media travels through the printer.

#### Finishing

This feature is available when the fold can be altered by 5mm bigger or smaller.

#### Output processing

This feature is available when your folder can do special stacking after folding to separate the copies of the same set. When alternate is selected, the folder rotates every other set or offsets every other set. This feature can not be used to instruct the folder to insert banner pages.



*Note: Output processing can be selected with E-Sorter.*

#### Binding margin

This feature is available when the fold offers a binding margin. Dependent on the fold selection the binding margin value can be set to off or to 0, 20, 25, 30, or 50 mm.



*Note: Some folds may only enable only some of these sizes.*

#### Tab & reinforce

This feature is available when the fold can add binding holes to the output either by punching the holes or by adding an adhesive tab.

# How to change the copy features (continued)

## Folder setup (continued)



*Note: The binding margin is setup in this feature, you can not change the binding margin from other machine features.*

### Procedure

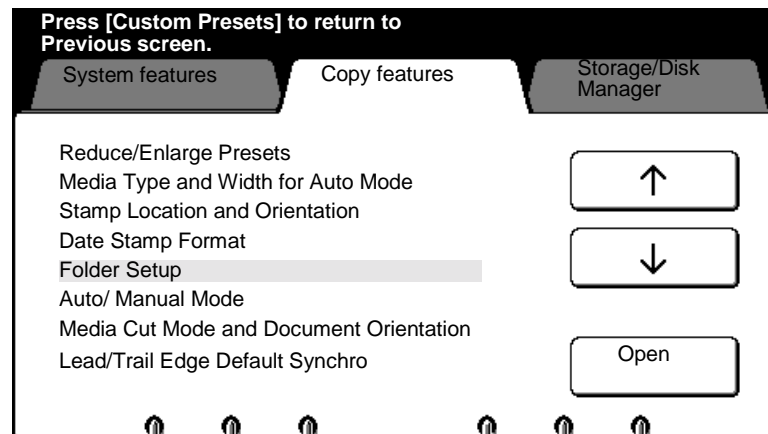

1. Enter custom presets. If needed, refer to page 174.
2. Select the **copy features** tab.
3. Use the arrow buttons to select the **folder** feature.
4. Select **open**.

The **folder setup screen** is displayed



*Note: To cancel the changes and exit from the screen, select **cancel**.*

## How to change the copy features (continued)

---

### Folder setup (continued)

---

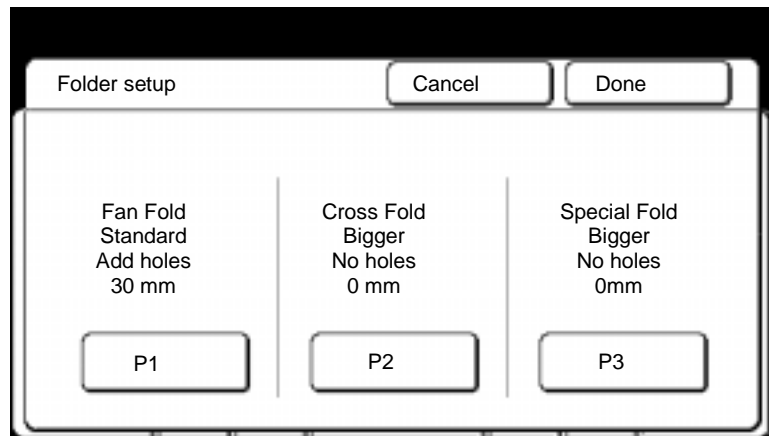

5. Select the desired fold program you want to setup.



**Caution:** You can set up P1, P2, or P3 to folds other than P1= fan fold, P2 = cross fold, and P3 = special fold at the folder, but the above screen displays P1= fan fold, P2 = cross fold, and P3 = special fold. Ensure to power off and power on, the folder, after changing any of the folds, other than what is displayed on the above touch screen.

**P1** Assigns the fold parameters to P1.

**P2** Assigns the fold parameters to P2.

**P3** Assigns the fold parameters to P3.

The **fold program screen** is displayed.



## How to change the copy features (continued)

### Folder setup (continued)

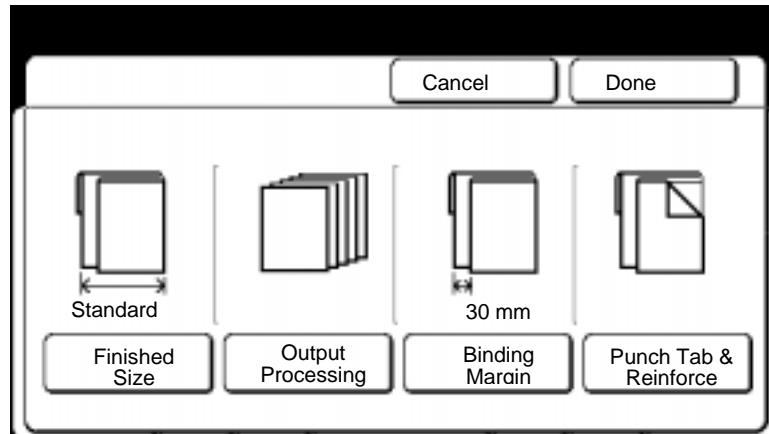

6. If available and desired select **finished size**. If not available go to step 9.

The **finished screen** is displayed.

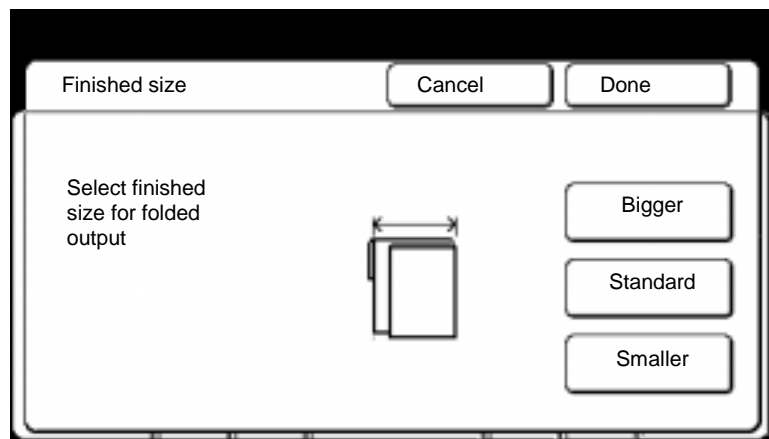

7. Select the desired finished size.

**Bigger** Increases the folded width by 5 mm.

**Standard** Folded width for A series is 216 mm, B series is 229 mm.

**Smaller** Decreases the folded width by 5 mm.

8. Select **done**.

The **fold program screen** is displayed.

## How to change the copy features (continued)

---

### Folder setup (continued)

---

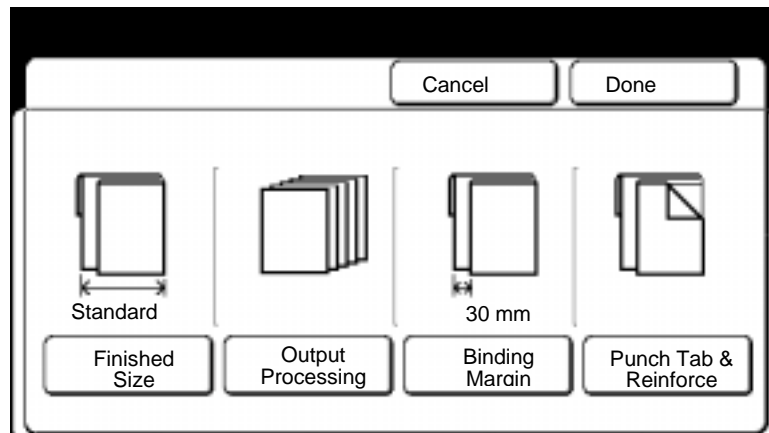

9. If available and desired select **output processing**. If not available continue to step 12.

The **output processing** is displayed.

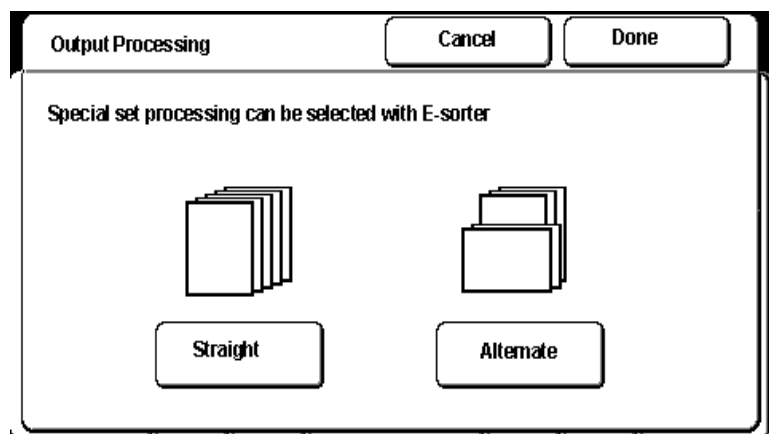

10. Select the desired option.

11. Select **done**.

The **fold program screen** is displayed.

## How to change the copy features (continued)

### Folder setup (continued)

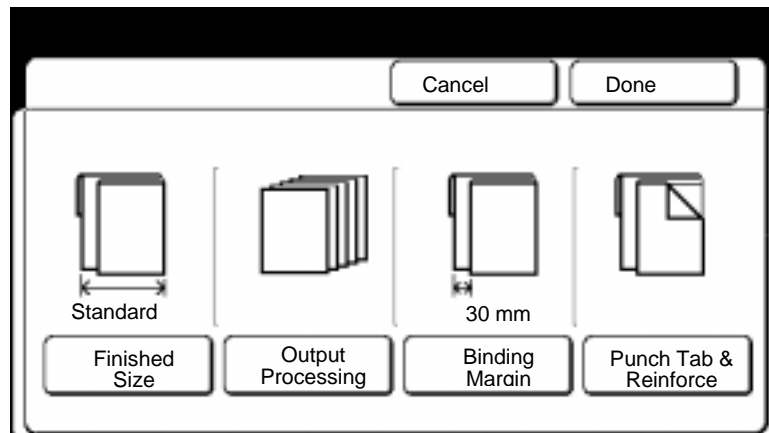

12. If available and desired select **binding margin**. Else continue to step 16.

The **binding margin** screen is displayed.

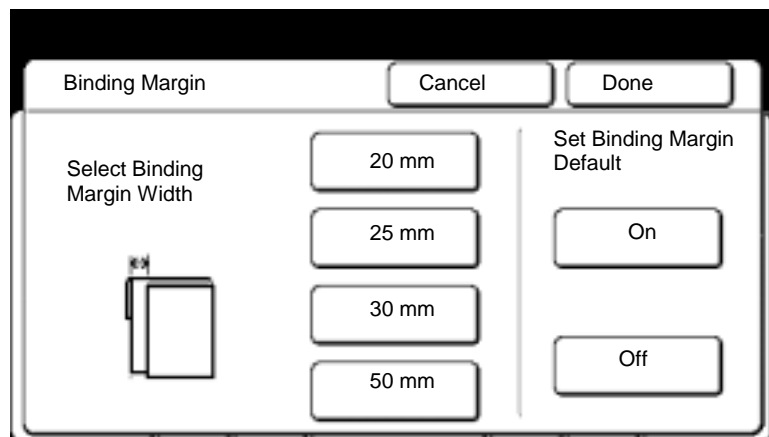

13. If available and desired select desired margin.

14. Select **on** or **off** to set the binding margin default.

15. Select **done**.

The **fold program** screen is displayed.

## How to change the copy features (continued)

---

### Folder setup (continued)

---

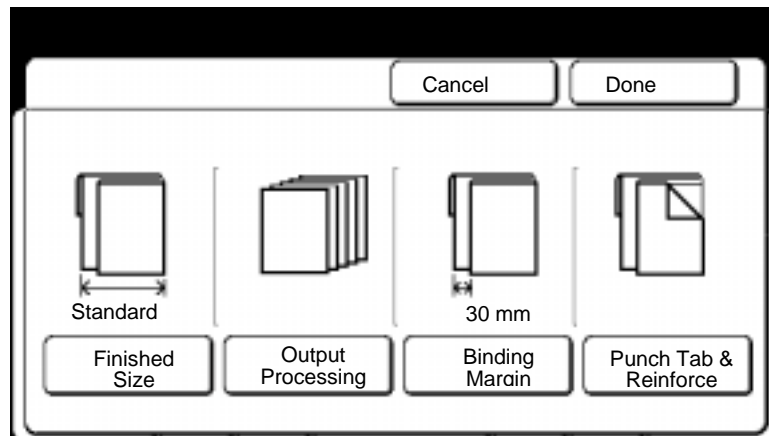

16. If available and desired select **punch tab & reinforce**. Else continue to step 19.

The **punch tab & reinforce screen** is displayed.

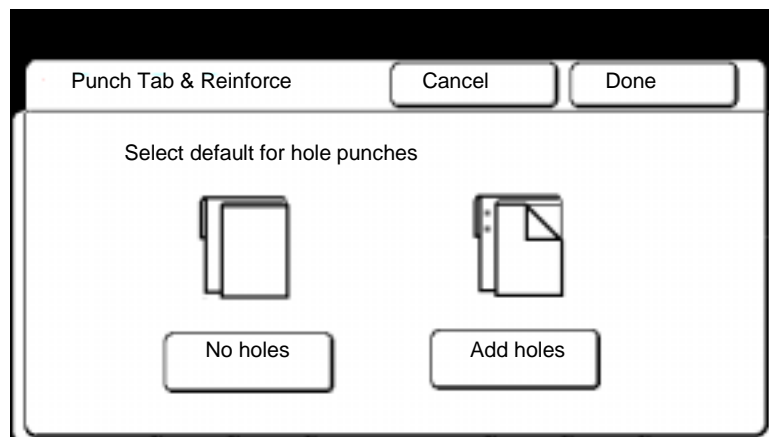

17. Select **no holes** or **add holes**.
18. Select **done**.
19. Select **done** to return to the **fold setup screen**.

The **folder setup screen** is displayed.

## How to change the copy features (continued)

---

### Folder setup (continued)

---

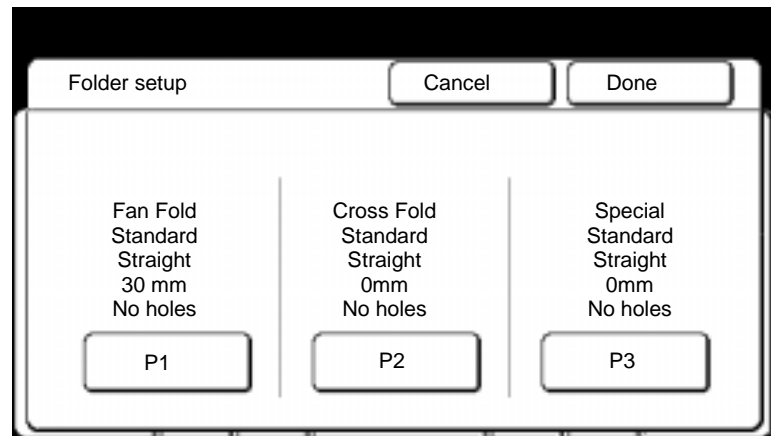

20. If desired, setup other fold programs (P1, P2 or P3). Repeat steps 5 –16. Else continue.
21. Select **done** to save the MAX 200 fold parameters for each program and exit from this screen.
22. To exit, press the **custom presets button**.

# How to change the copy features (continued)

## Auto/manual mode

### Introduction

The **auto/manual mode feature** sets up the default mode of operation for the machine to auto mode or manual mode. It also sets up the default media source tray for each mode of operation.

### Procedure

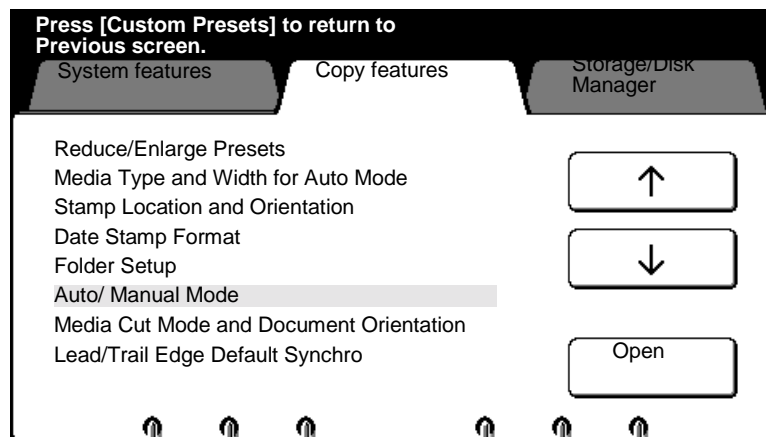

1. Enter custom presets. If needed, refer to page 174.
2. Select the **copy features** tab.
3. Use the arrow buttons to select the **auto/manual** feature.
4. Select **open**.

The **auto/manual mode screen** is displayed.

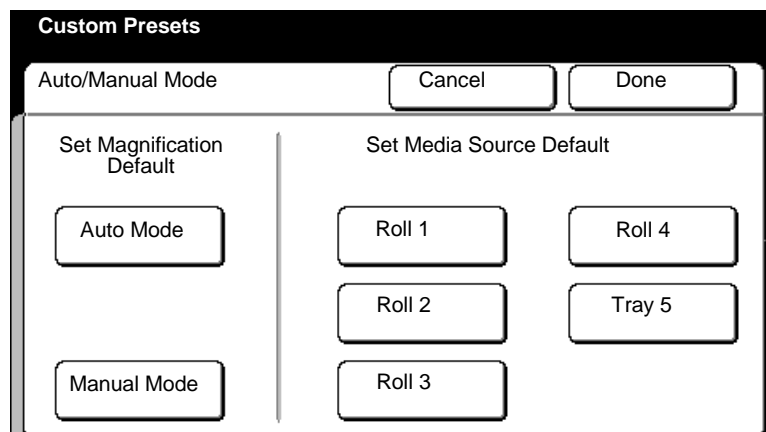

## How to change the copy features (continued)

---

### Auto/manual mode (continued)

---

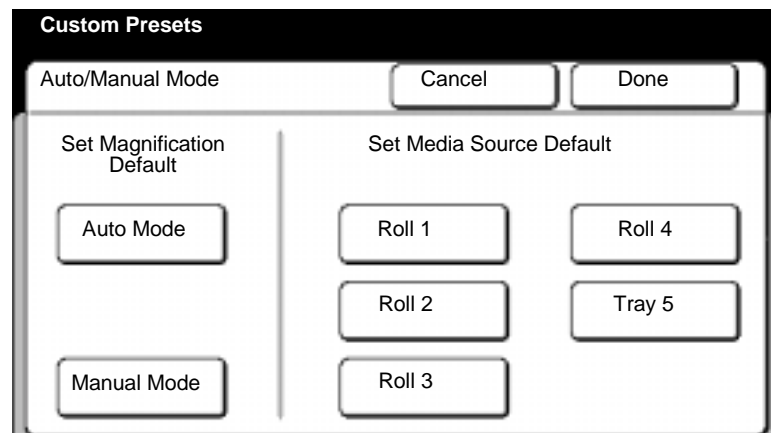

5. Select the set magnification default, **auto** or **manual**. This sets up the default mode of operation for the machine.  
If **manual** is selected, also select the media source default tray for manual.
6. Select **done** to store your changes and exit from this screen.  
To cancel the changes and exit from this screen, select **cancel**.
7. To exit, press the **custom presets button**.

# How to change the copy features (continued)

## Media cut mode and document orientation

### Introduction

The **media cut mode and document orientation feature** sets up the default cut for manual mode and the orientation default for standard cut, located on page 80.

### Procedure

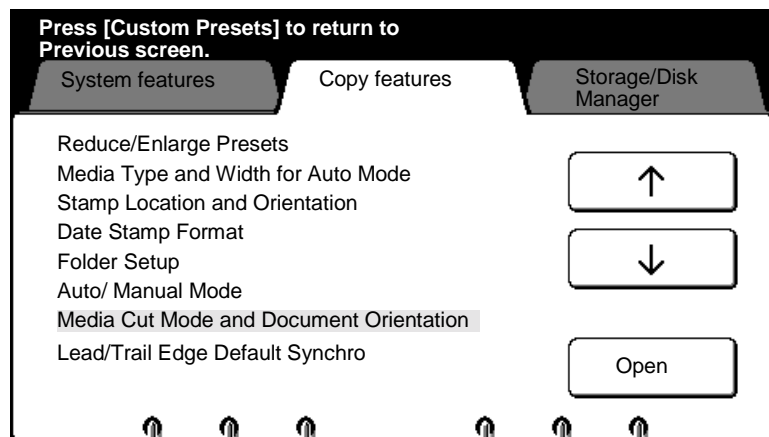

1. Enter custom presets. If needed, refer to page 174.
2. Select the **copy features** tab.
3. Use the arrow buttons to select the **media cut mode and document orientation** feature.
4. Select **open**.

The **media cut mode and document orientation screen** is displayed.



## How to change the copy features (continued)

---

### Media cut mode and document orientation (continued)

---

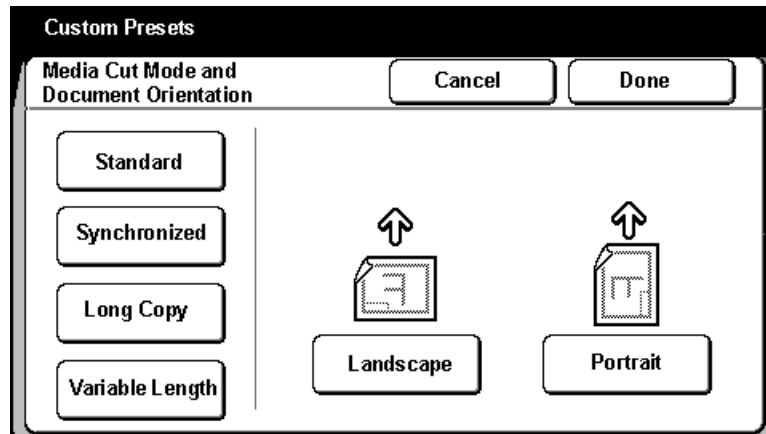

5. Select the desired cut mode:
  - **Standard** – for auto and manual mode
  - **Synchronized** – for auto or manual mode, for auto mode you must also set code 200 to **on**, refer to page 169.
  - **Long copy** – for manual mode only, to set auto mode to synchronize or standard you must set code 210 (refer to page 169).
  - **Variable length** – for manual mode only, to set auto mode to synchronize or standard you must set code 210 (refer to page 169).
6. Select the default feed orientation for standard; **landscape** or **portrait**.
7. Select **done** to store your changes and exit from this screen.  
To cancel the changes and exit from this screen, select **cancel**.
8. To exit, press the **custom presets button**.

# How to change the copy features (continued)

## Lead/trail edge default for synchronized

### Introduction

The **lead/trail edge default for synchronized feature** sets up the lead and trail edge default margins for synchronized and long copy.

### Procedure

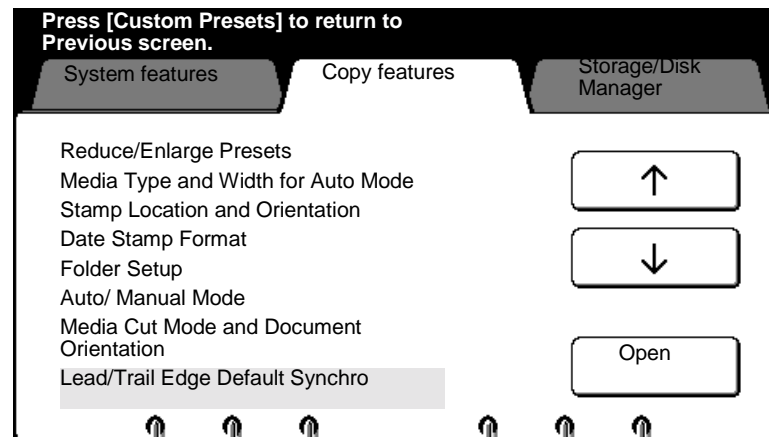

1. Enter custom presets. If needed, refer to page 174.
2. Select the **copy features** tab.
3. Use the arrow buttons to select the **lead/trail edge default for synchronize** feature.
4. Select **open**.

The **lead/trail edge default for synchronize** screen is displayed.

## How to change the copy features (continued)

---

### Lead/trail edge default for synchronized (continued)

---

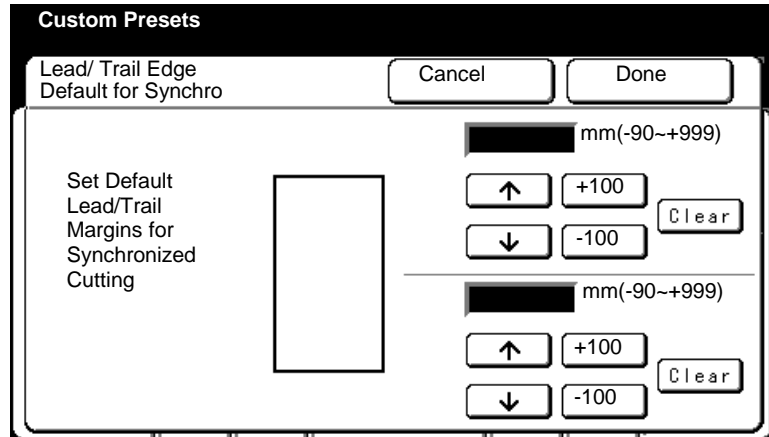

5. Use the **arrow buttons** to set the desired lead and trail edge dimension. The **± 100 buttons**, increase or decrease the dimension by 100. Select the **clear button**, to clear wrong data.  
A margin value can be set in 1 mm increments from – 90 mm to + 999 mm. A minus margin value cuts the copy media shorter than the document.
6. Select **done** to store your changes and exit from this screen.  
To cancel the changes and exit from this screen, select **cancel**.
7. To exit, press the **custom presets button**.

## How to change the copy features (continued)

### Variable length default



*Note: When the set variable length is longer than the original length, the excess is output blank.*

#### Introduction

The **variable length default feature** sets up the default cut length for each roll, for the variable length option, located on page 85.

#### Procedure

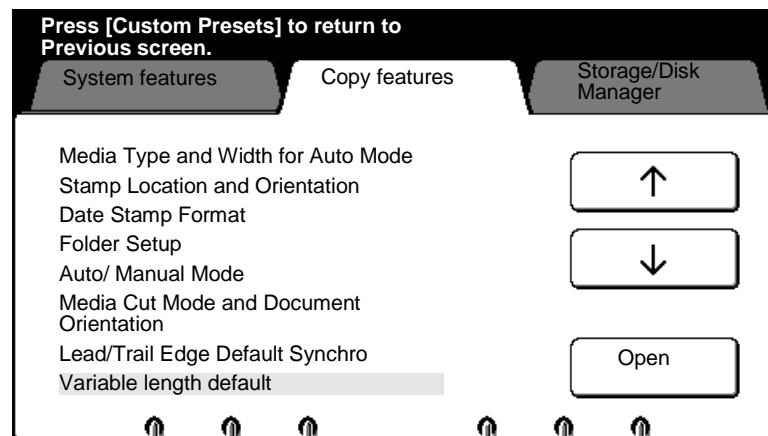

1. Enter custom presets. If needed, refer to page 174.
2. Select the **copy features** tab.
3. Use the arrow buttons to select the **variable length default** feature.
4. Select **open**.

The **variable length default screen** is displayed.

## How to change the copy features (continued)

---

### Variable length default (continued)

---

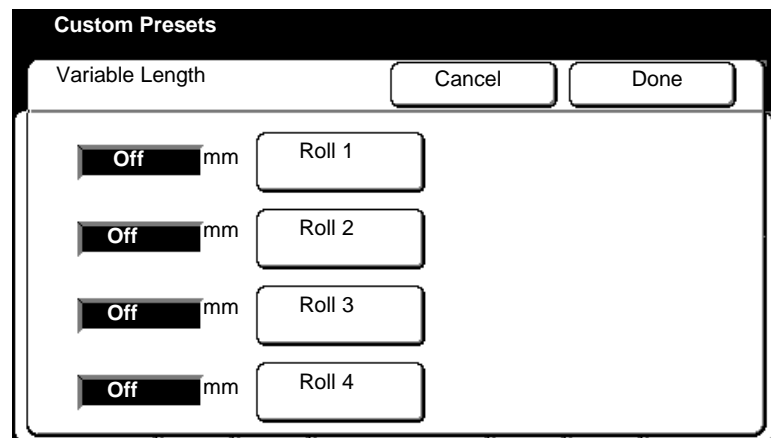

5. Select the desired roll; **roll 1** , **roll 2**, **roll 3**, or **roll 4**.
6. Enter the desired length for the selected roll (range is 210 mm – 4161 mm). Use the numeric keypad to enter dimension..
7. If needed, repeat step 5 and 6, for other rolls. Else continue.
8. Select **done** to store your changes and exit from this screen.  
To cancel the changes and exit from this screen, select **cancel**.
9. To exit, press the **custom presets button**.

# How to change the copy features (continued)

## Background suppression level default

### Introduction

The **background suppression level default feature** sets up the default background suppression levels for variable (default 1) and fixed (default 2), located on page 88.

### Procedure

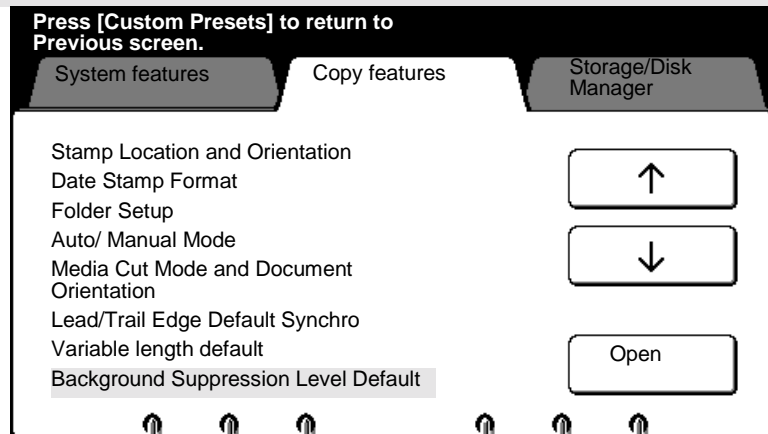

1. Enter custom presets. If needed, refer to page 174.
2. Select the **copy features** tab.
3. Use the arrow buttons to select the **background suppression level default** feature.
4. Select **open**.

The **background suppression level default screen** is displayed.

## How to change the copy features (continued)

### Background suppression level default (continued)

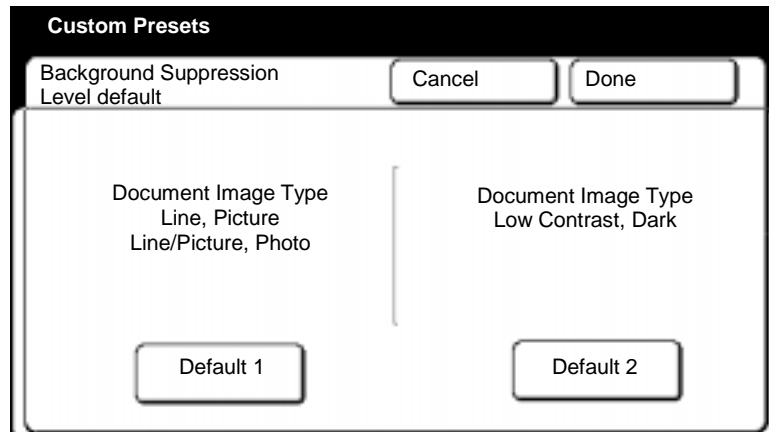

5. Select **default 1** or **default 2**.  
If **default 1** is selected go to step 6.  
If **default 2** is selected go to step 7.
6. Adjust the variable and fixed default levels using the **arrow buttons**. When complete go to step 8.

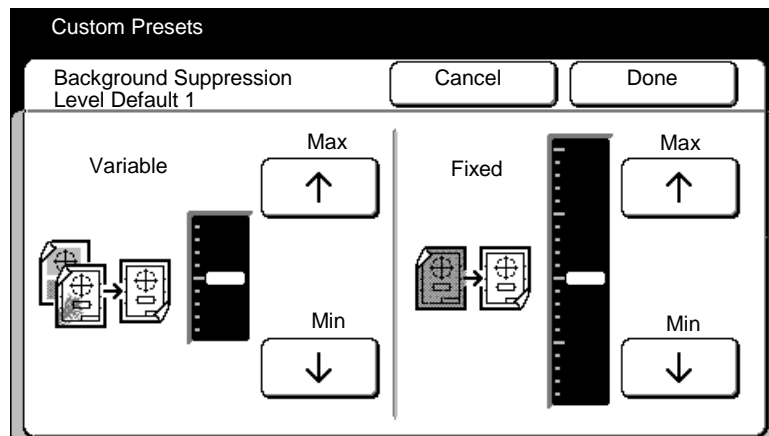

## How to change the copy features (continued)

---

### Background suppression level default (continued)

---

- Adjust the fixed default level using the **arrow buttons**.

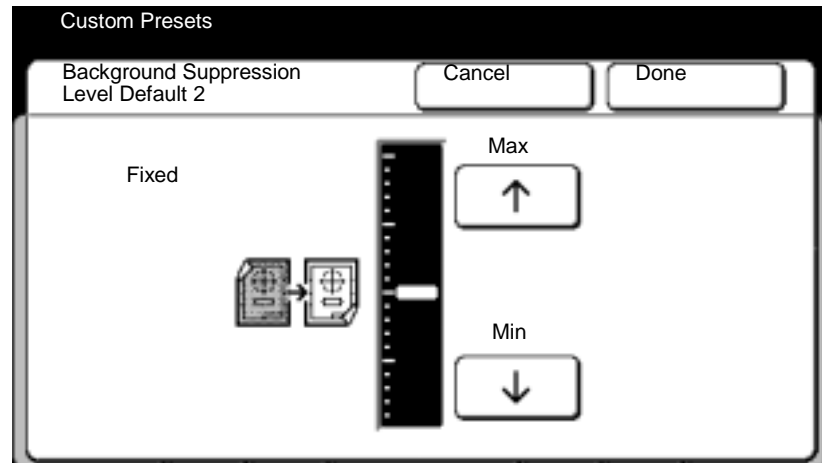

- Select **done** to store your changes and exit from the default screen.  
To cancel the changes and exit from the default screen, select **cancel**.
- To exit from custom presets, press the **custom presets button**.



# How to change the copy features (continued)

## Image density

### Introduction

The **image density feature** sets up the image density default on the image density screen, located on page 87.

### Procedure

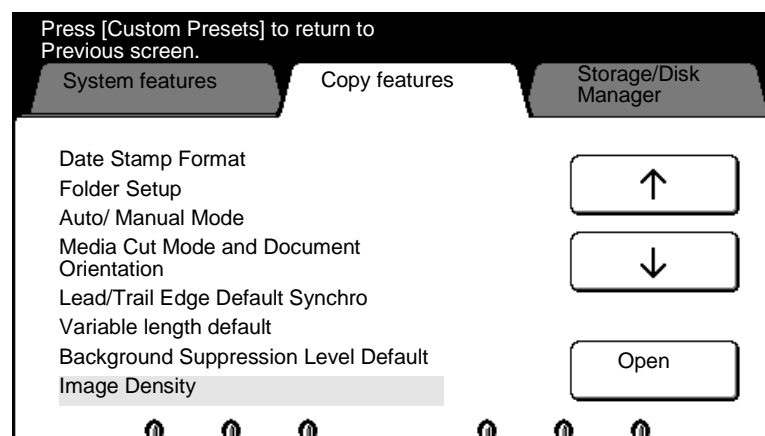

1. Enter custom presets. If needed, refer to page 174.
2. Select the **copy features** tab.
3. Use the arrow buttons to select the **image density** feature.
4. Select **open**.

The **image density screen** is displayed.

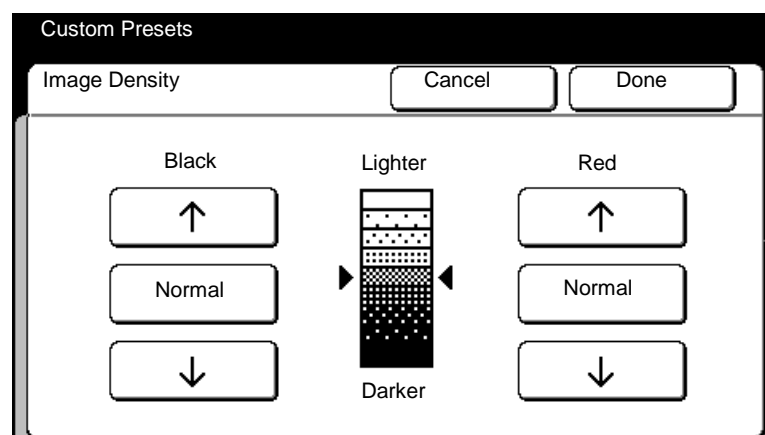

5. Use the arrow buttons to set the default image density for black and red.
6. Select **done** to store your changes and exit from this screen.  
To cancel the changes and exit from this screen, select **cancel**.
7. To exit, press the **custom presets button**.

# How to change the copy features (continued)

## Document image type

### Introduction

The **document image type feature** sets up the document image type default, located on page 88.

When a document is scanned, the machine makes adjustments to meet specific image quality conditions, for the selected default. When setting up this feature, select the document image type you scan the most.

### Procedure

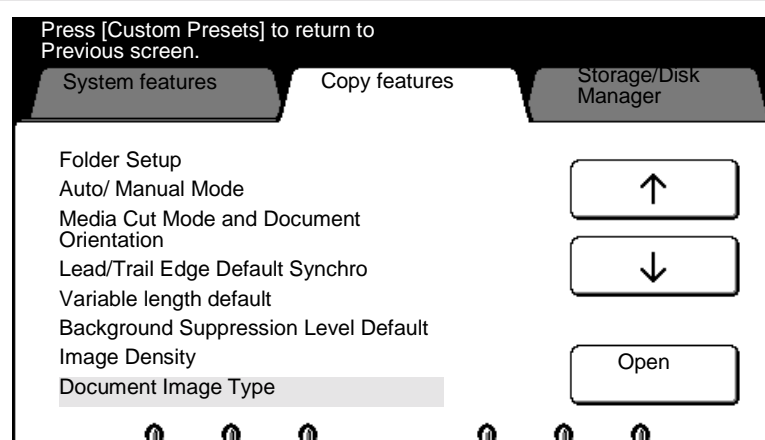

1. Enter custom presets. If needed, refer to page 174.
2. Select the **copy features** tab.
3. Use the arrow buttons to select the **document image type** feature.
4. Select **open**.

The **document image type screen** is displayed.

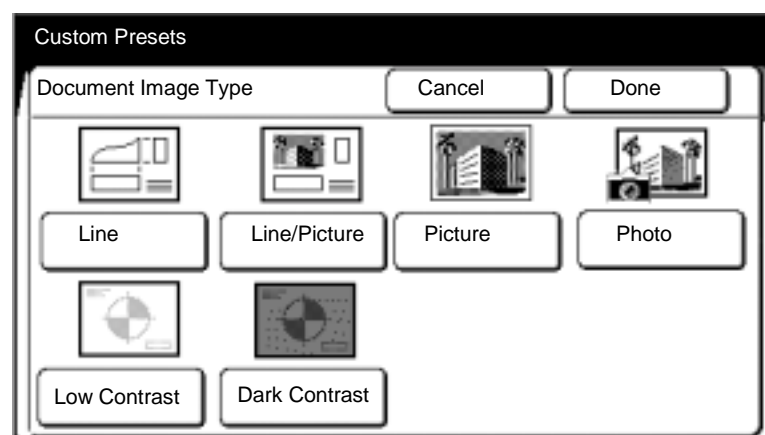

5. Select the desired document image type default; **line**, **line/picture**, **picture**, **photo**, **low contrast**, or **dark contrast**.
6. Select **done** to store your changes and exit from this screen.  
To cancel the changes and exit from this screen, select **cancel**.
7. To exit, press the **custom presets button**.

# How to change the copy features (continued)

## Scan to print color default

### Introduction

The **scan to print color default feature** sets up the colors the scanner recognizes to be printed in red.

### Procedure

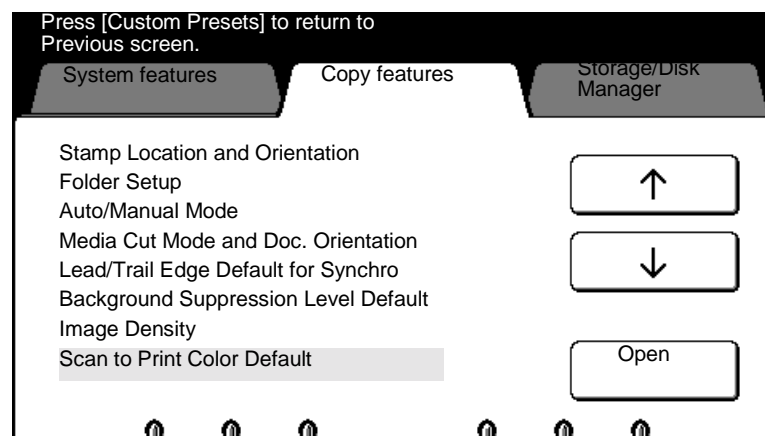

1. Enter custom presets. If needed, refer to page 174.
2. Select the **copy features** tab.
3. Use the arrow buttons to select the **scan to print color default** feature.
4. Select **open**.

The **scan to print color default screen** is displayed.

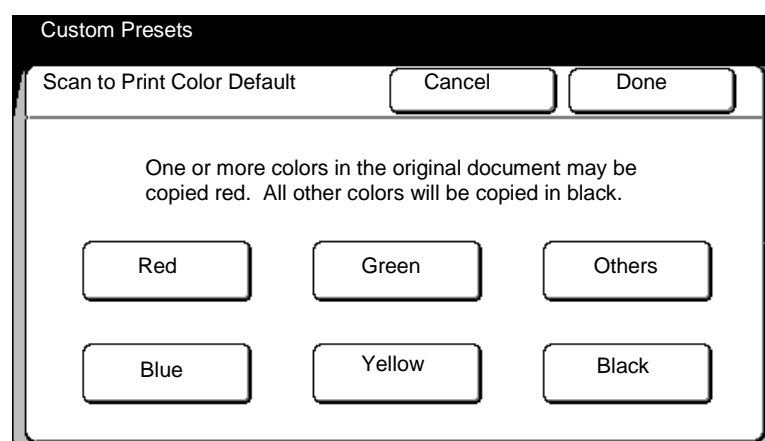

5. Select the desired colors to be printed in red; **red, green, others, blue, yellow** or **black**.
  - Multiple colors can be selected.
  - Others specify colors other than red, blue, green, yellow, and achromatic colors.
6. Select **done** to store your changes and exit from this screen.  
To cancel the changes and exit from this screen, select **cancel**.
7. To exit, press the **custom presets button**.

## How to change the copy features (continued)

### Color recognition range



*Note: You do not want the color ranges to overlap. If you increase the range on one color, be sure to decrease the range for the adjacent color.*

#### Introduction

The **color recognition range feature** allows you to adjust the color range (in angles) the scanner uses to recognize a color.

#### Procedure

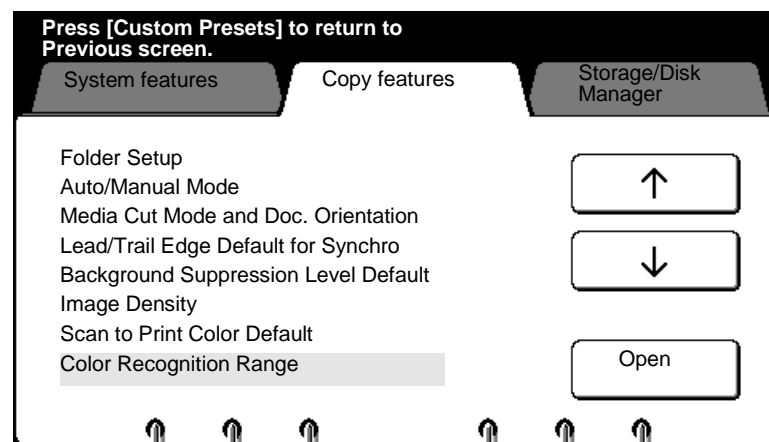

1. Enter custom presets. If needed, refer to page 174.
2. Select the **copy features** tab.
3. Use the arrow buttons to select the **color recognition range** feature.
4. Select **open**.

The **color recognition range screen** is displayed.

## How to change the copy features (continued)

### Color recognition range (continued)

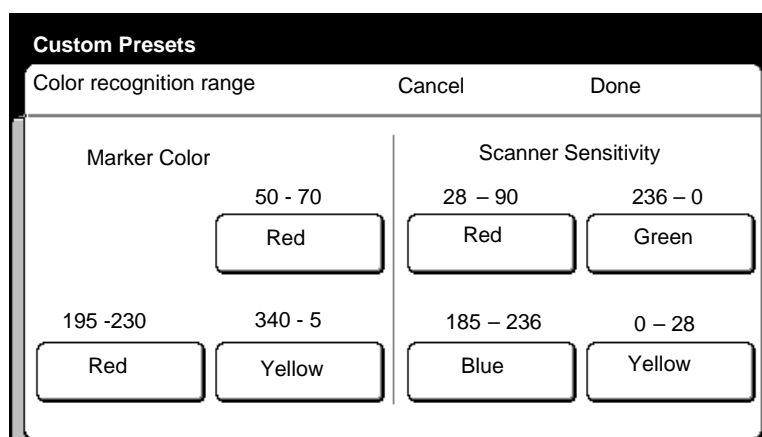

5. Select the desired scanner sensitivity color range, you want to change; **red**, **green**, **blue**, or **yellow**.

The **color recognition wheel screen** is displayed.

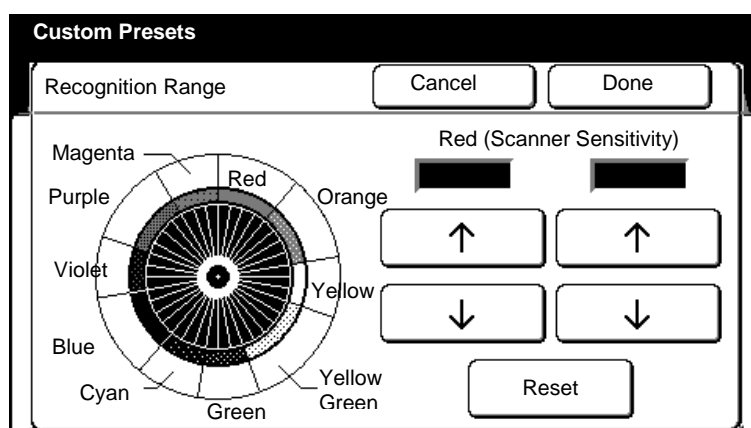

6. If needed, there is an example on how to change the range on page 228. Else continue to the next step.



*Note: You do not want the color ranges to overlap. If you increase the range on one color, be sure to decrease the range for the adjacent color.*

7. Use the left arrow buttons to specify the beginning point of the recognition range. Use the right arrow buttons to specify the end point of the recognition range

Select the **reset**, to return to the default settings.

To cancel the changes and exit from this screen, select **cancel**.

8. If needed, repeat step 4 – 6, to change other color ranges. Else continue to the next step.
9. Select **done** to store your changes and exit from this screen.
10. To exit, press the **custom presets button**.

# How to change the copy features (continued)

## Color recognition range (continued)

### Color Recognition wheel

#### Introduction

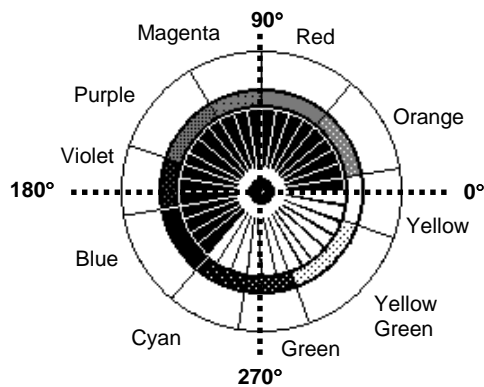

Positions on the wheel are given by an angle. As the angle increases or decreases, the shaded area of the wheel changes to reflect the scanner sensitivity.



*Note: If you increase above 359, the angle is automatically adjusted to 0.*

The table below lists the factory default range and available ranges.

Color	Marker		Scanner	
	Range	Default	Range	Default
Red	0 - 100	50 - 70	0 - 226	28 - 90
Yellow	270 - 30	340 - 5	225 - 90	0 - 28
Blue	150 - 270	195 - 230	90 - 0	185 - 236
Green	-	-	123 - 0	236 - 0

#### Example

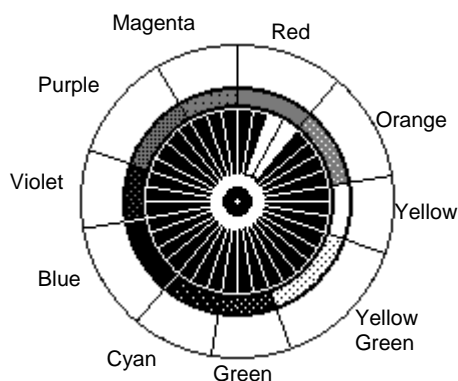

**Current red (marker color) range 50 - 70**

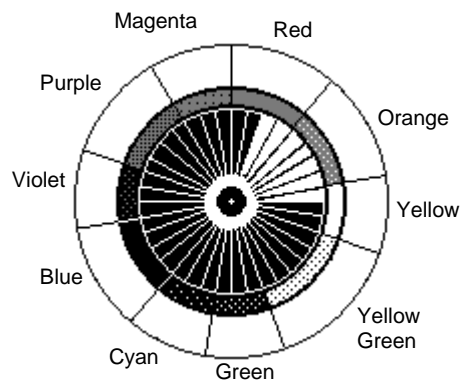

**New red (marker color) range 0 - 70**

#### Problem:

Lets imagine the red edit marker that you are using is not being recognized. Look at the current red marker setting, it is set to 50 - 70. This setting only covers the higher end of red on the color wheel. The marker you are using has a lot of orange and yellow in it.

#### Solution:

Therefore, you will need to change the color range to include orange and yellow recognition. Change the first number in the range to 0. When the new range is set to 0 - 70, the machine looks for red that contains yellow and orange.

# How to change the copy features (continued)

## Marker area recognition

### Introduction

The **marker area recognition feature** sets up the marker color default the scanner recognizes. It also defines on how the scanner recognizes the wide marker line on your document.

### Procedure

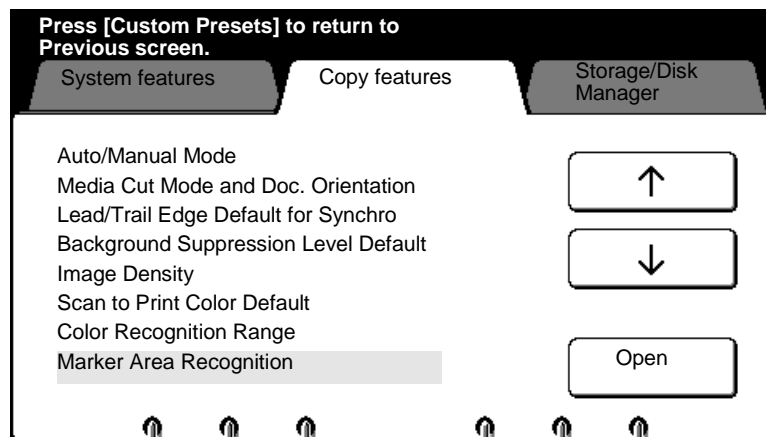

1. Enter custom presets. If needed, refer to page 174.
2. Select the **copy features** tab.
3. Use the arrow buttons to select the **marker area recognition** feature.
4. Select **open**.

The **marker area recognition screen** is displayed.

## How to change the copy features (continued)

---

### Marker area recognition (continued)

---

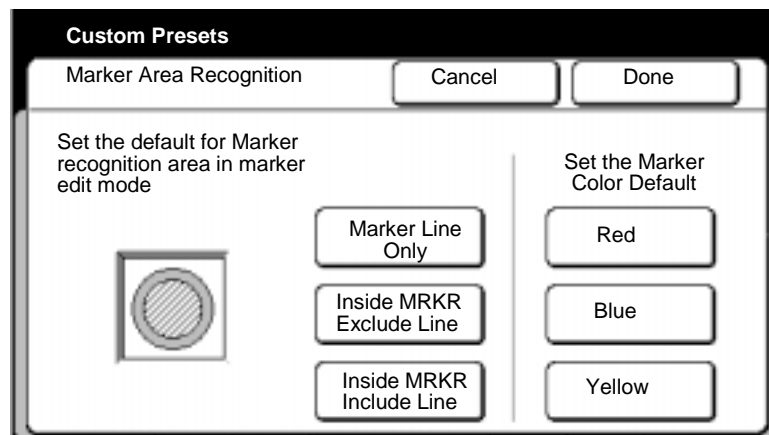

5. Select how the scanner recognizes the wide marker line on your document.

<b>Marker line only</b>	Machine recognizes marker line only.
<b>Inside MRKR exclude line</b>	Machine recognizes inside the marker line, but does not include marker line.
<b>Inside MRKR include line</b>	Machine recognizes inside the marker line and includes the marker line.
6. Select the desired marker color default; **red**, **blue** or **yellow**.
7. Select **done** to store your changes and exit from this screen.

To cancel the changes and exit from this screen, select **cancel**.
8. To exit, press the **custom presets button**.



# How to change the copy features (continued)

## Additional setting

### Introduction

The **additional setting feature** provides additional copy default settings, for future needs. Depending on the code entered, the MAX 200 allows you to further customize your machine. If needed, service will provide you with the additional setting code and field data.

The identified additional settings codes are:

- Auto mode documentation feed direction default, code 20.

For detailed information on the identified codes, refer to page 173.

### Procedure

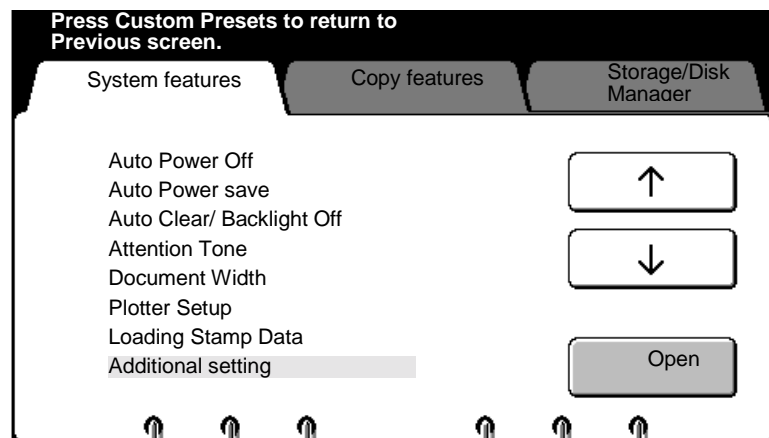

1. Enter custom presets. If needed, refer to page 174.
2. Select the **system features** tab.
3. Use the arrow buttons to select the **additional setting** feature.
4. Select **open**.

The **additional setting (copy feature) screen** is displayed.

## How to change the copy features (continued)

---

### Additional setting (continued)

---

The screenshot shows a dialog box titled 'Custom Presets' with a sub-header 'Additional Setting (Copy Feature)'. At the top right of the dialog are 'Cancel' and 'Done' buttons. The main area contains three input fields: 'Code', 'Current', and 'New'. The 'Code' field has a blacked-out value. The 'Current' field is empty. The 'New' field has a blacked-out value. A 'Scroll' button is located at the bottom right of the dialog.

5. Enter the additional setting code using the numeric keypad, in the code field (service supplies code or it is listed on page 173).  
The code is displayed in the code field.
6. Select **scroll** to move to the new field.  
The current value is displayed in the current field.
7. Enter the value in the new field, using the numeric keypad (service supplies code or it is listed on page 173).  
The new value is displayed in the new field.
8. Select **done** to store your changes and exit from this screen.  
To cancel the changes and exit from this screen, select **cancel**.
9. To exit, press the **custom presets button**.

# How to change the storage/disk manager features

---

## Stamp creation/deletion

---



*Note: The format used by the floppy drive is unique to MAX 200; it can not read or write PC, Macintosh, or UNIX files. You must format your floppy disk from the MAX 200. If needed, refer to page 245.*



*Note: If you want to include a date stamp or a numbering stamp at a later time, be sure to include enough space for the other stamping features on your stamp design. All stamp patterns can not exceed 70 mm squared = 4900 mm<sup>2</sup>.*

### Introduction

The **stamp creation/deletion feature** allows you to setup the stamp image parameters and then create and store the stamp pattern. The **stamp creation/deletion feature** also allows you to delete a specific stamp pattern.

Once you setup the stamp parameters, you can scan the stamp image. The next step is to store the stamp pattern. If needed, you can add other stamp features to the stored stamp pattern or change the location and orientation of the stored stamp pattern from the stumper screen, located on page 139.

To go directly to the section on how to create a stamp, refer to page 234 or go to the procedure on how to create a stamp, refer to page 237.

### Custom presets Function feature

<b>Creation</b>	Setup the stamp parameters, create and store and the stamp. Refer to page 237.
-----------------	--

<b>Deletion</b>	To Delete stamp patterns. Refer to page 242.
-----------------	--

## How to change the storage/disk manager features (continued)

### Stamp creation/deletion (continued)

#### How to create a stamp



*Note: If needed, you can setup your start position, for the stamp location, to be the lead edge or trail edge of your document. If needed, refer to page 192.*

#### Introduction

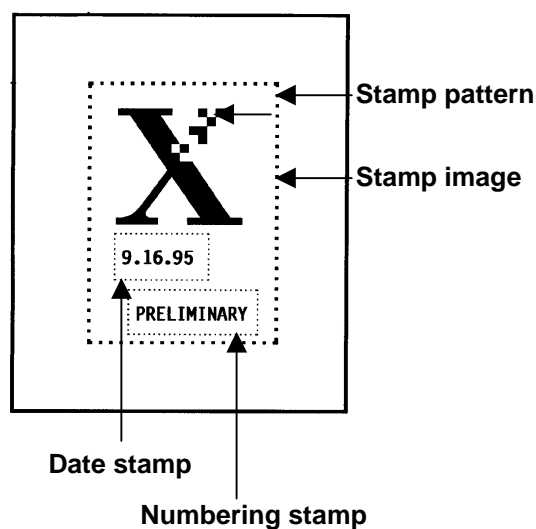

With the MAX 200, a stamp pattern is created and then stored on a floppy disk. You later program the machine to add the stamp to each copy made.

In this section, you will learn how to setup the location parameters to scan the image, and then store the image. Once the image is stored it is referred to, as the stamp pattern.

The example at the far left corner has combined a scanned image (the X), the date stamp (9.16.95), and the numbering stamp (PRELIMINARY). The dotted line represents the total stamp pattern area.

Each feature can be used by itself, or combined with the other stamp features to meet your design requirements. The procedure to create a stamp is divided into four sets of measurements:

- The **first set of measurements** defines the starting position of the stamp pattern.
- The **second set of measurements** sets the stamp pattern width and height.
- The **third set of measurements** positions the date stamp feature.
- The **fourth set of measurements** positions the number stamp feature.

# How to change the storage/disk manager features (continued)

## Stamp creation/deletion (continued)

### How to create a stamp (continued)

#### Procedure:

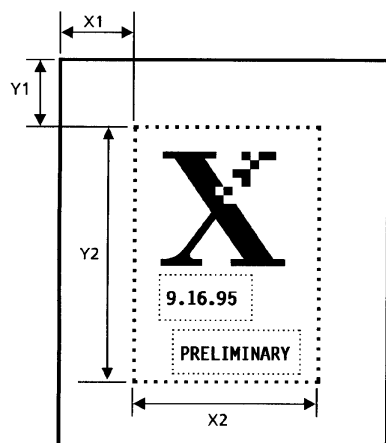

#### First set of measurements:

The first step is the stamp pattern design. The stamp pattern shown to the left has a scanned image (the X), and date (9.16.95), and numbering (PRELIMINARY).

Once the stamp has been designed, it is necessary to make several sets of measurements. These measurements are entered on the stamp create/store screen (custom presets). These sets of measurements are used by the scanner to create the stamp.



*Note: If you are going to include the date stamp and or the numbering stamp, ensure to include enough room for these features.*

The first set of measurements tells the scanner where to begin scanning. These measurements are called the **start position** X and Y coordinates.

**X1** Distance from the left edge of the paper to the left edge of the stamp pattern.

**Y1** Distance from the top edge of the paper to the top edge of the stamp pattern.

#### Second set of measurements:

The second set of measurements tells the scanner height and width of the stamp pattern. These measurements are called the **end position** X and Y coordinates.

**X2** The width of the stamp pattern.

**Y2** The height of the stamp pattern.

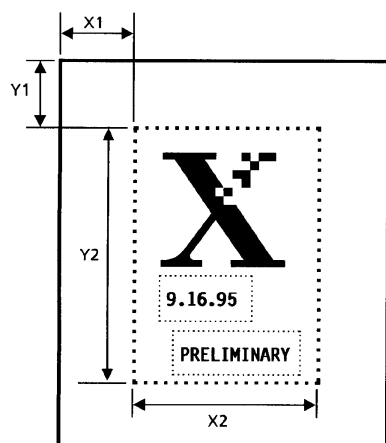

## How to change the storage/disk manager features (continued)

---

### Stamp creation/deletion (continued)

---

#### How to create a stamp (continued)

---

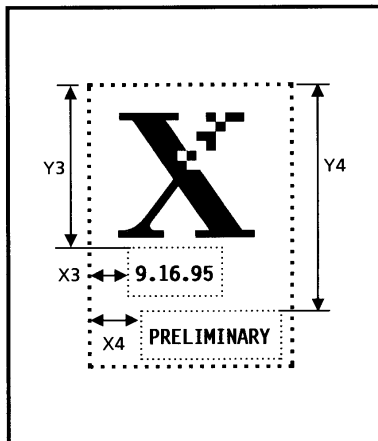

##### Third set of measurements:

If needed, the third set of measurements position the date stamp information. These measurements are called the **position of date** X and Y coordinates.

- X3** The distance from the left edge of the stamp pattern to the left edge of the date.
- Y3** The distance from the top of the stamp pattern to the top of the date.

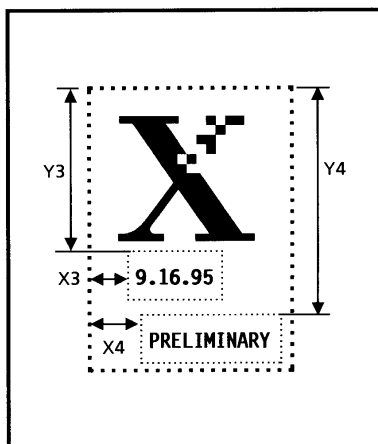

##### Fourth set of measurements:

If needed, the fourth set of measurements positions the number information. These measurements are called the **position of number** X and Y coordinates.

- X4** The distance from the left edge of the stamp pattern to the left edge of the numbering.
- Y4** The distance from the top of the stamp pattern to the top of the numbering.

## How to change the storage/disk manager features (continued)

---

### Stamp creation/deletion (continued)

---

#### Stamp creation

---



*Note: If needed, you can setup your start position, for the stamp location, to be the lead edge or trail edge of your document. If needed, refer to page 192.*



*Note: Ensure to have a formatted disk to save the stamp pattern you have created. If needed, refer to the format procedure on page 245.*

#### Procedure

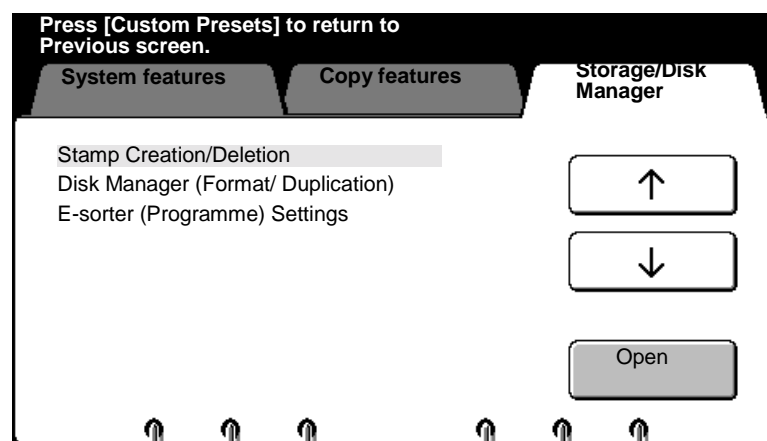

1. Enter custom presets. If needed, refer to page 174.
2. Select the **storage/disk manager** tab.
3. Use the arrow buttons to select the **stamp creation/ deletion** feature.
4. Select **open**.

The **stamp creation/deletion screen** is displayed.

## How to change the storage/disk manager features (continued)

### Stamp creation/deletion (continued)

#### Stamp creation (continued)

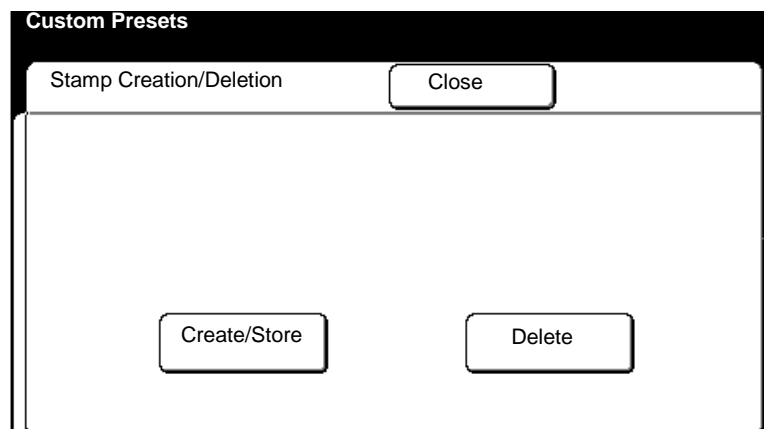

5. Select **create/store**.

The **stamp create/store screen** is displayed.

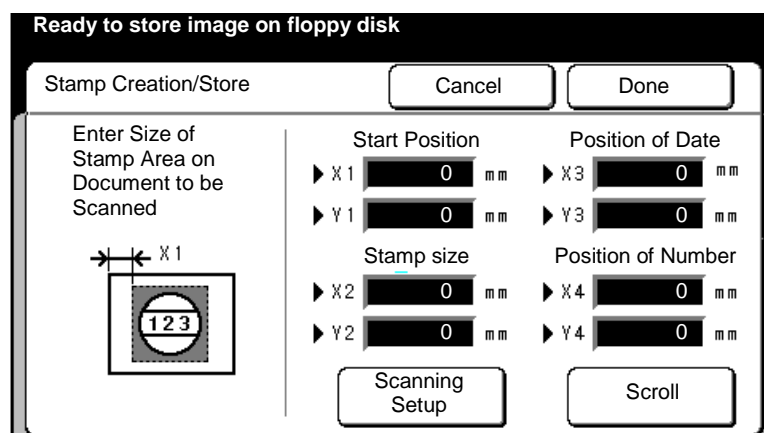

Select **scroll** to move to next desired field.

6. Use the keypad to enter the X1 and Y1 **start position** dimensions (defines the stamp pattern starting position).
7. Use the keypad to enter the X2 and Y2 **end position** dimensions (sets the width and height of the stamp pattern).



*Note: All stamp patterns can not exceed 70 mm squared = 4900 mm<sup>2</sup>.*

8. If needed, enter the X3 and Y3 **position of date** dimensions (sets the position of the date stamp).
9. If needed, enter the X4 and Y4 **position of number** dimensions (sets the position of the numbering stamp).



## How to change the storage/disk manager features (continued)

### Stamp creation/deletion (continued)

#### Stamp creation (continued)

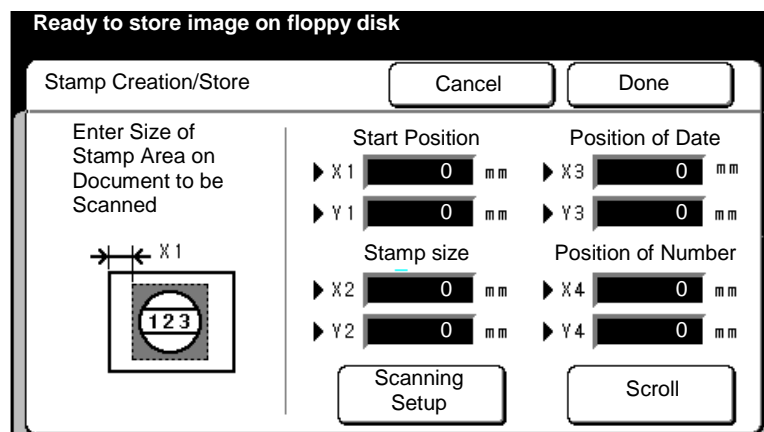

10. If needed, select **scanning setup**. Else continue to step 13.

- The scanning setup option allows you to modify the background suppression, image density, or reduce and enlarge the stamp pattern.



*Note: A message is displayed if the stamp size exceeds 4900 mm<sup>2</sup>. If the end position measurements are greater than 4900 mm<sup>2</sup> (X2, Y2) you can reduce the size by changing the X2, Y2 measurements or select the scanning setup option and reduce the image size.*

The **scanning setup** screen is displayed.

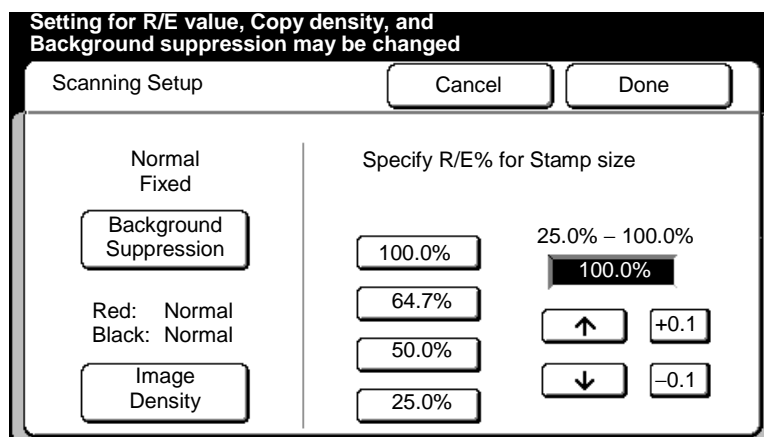

## How to change the storage/disk manager features (continued)

### Stamp creation/deletion (continued)

#### Stamp creation (continued)

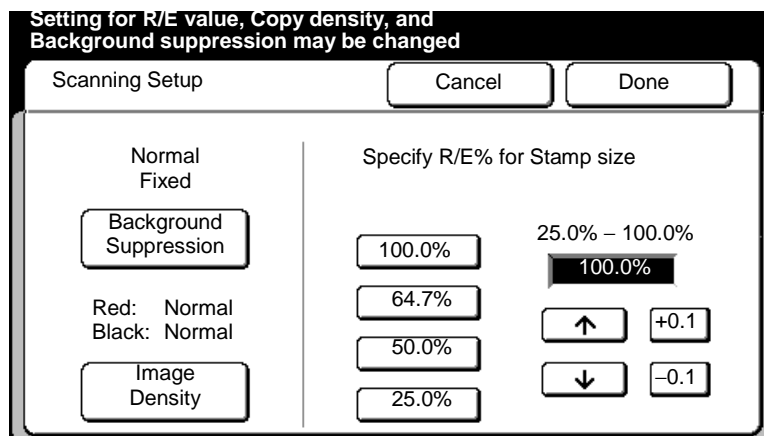

11. Select the desired selection buttons, on the scanning setup screen.



*Note: The current settings are displayed.*

If **background suppression** is selected, there are three options:

- Fixed** Select when the background of the stamp image is uniform.
- Variable** Select when the background of the stamp image is not uniform.
- Off** Select when you want to disable the background suppression option.

If **image density** is selected, use the arrow buttons to adjust the black and red density levels.

If the **R/E% for stamp size** is needed, select the desired percentage using the **arrow buttons**. To further adjust the percentage use the **± 0.1 buttons**

12. To save the scanning setup changes, ensure to select **done** for each change.

The **stamp create/store screen** is displayed.

## How to change the storage/disk manager features (continued)

### Stamp creation/deletion (continued)

#### Stamp creation (continued)

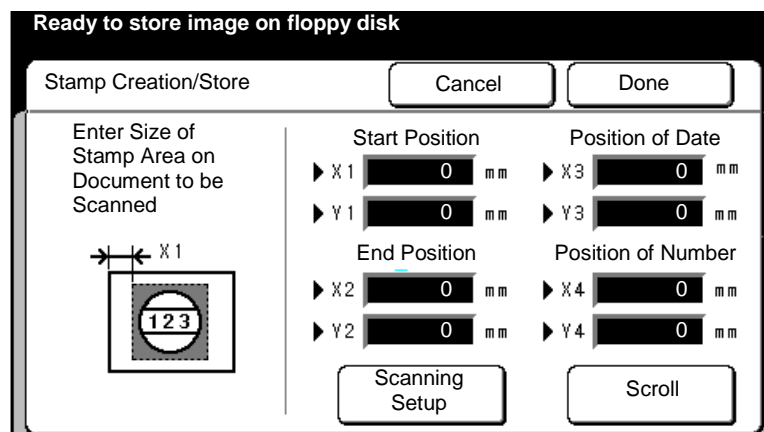

13. Insert the document with the stamp image, face down into the scanner.

The **stamp create/store screen** is displayed.

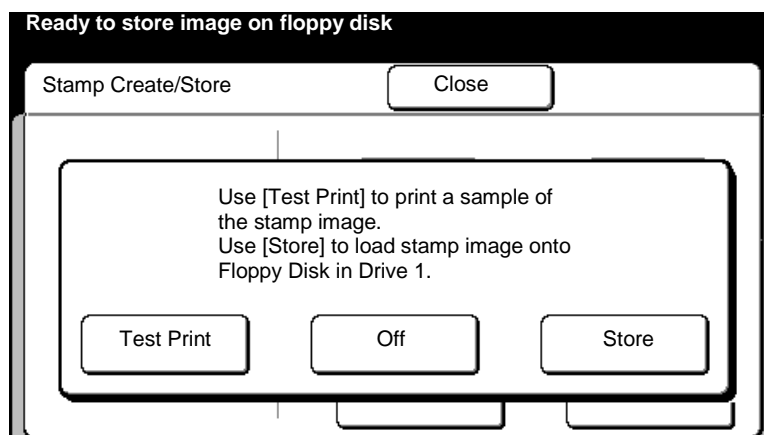

14. Select the desired button.

**Test print** Select to print the stamp pattern for review.

**Off** Select to modify the stamp pattern. When all modifications are complete select **done** and go to step 11.

**Store** Select to store the stamp pattern to the formatted floppy. You can store up to 40 stamp patterns.

Before the stamp is stored, a confirm screen is displayed. Select **confirm**.

The **stamp creation/deletion screen** is displayed.

15. To exit from the stamp creation/deletion screen, select **done** or **cancel**.

16. To exit custom presets, press the **custom presets button**.

## How to change the storage/disk manager features (continued)

---

### Stamp creation/deletion (continued)

---

#### Stamp deletion

---

##### Procedure

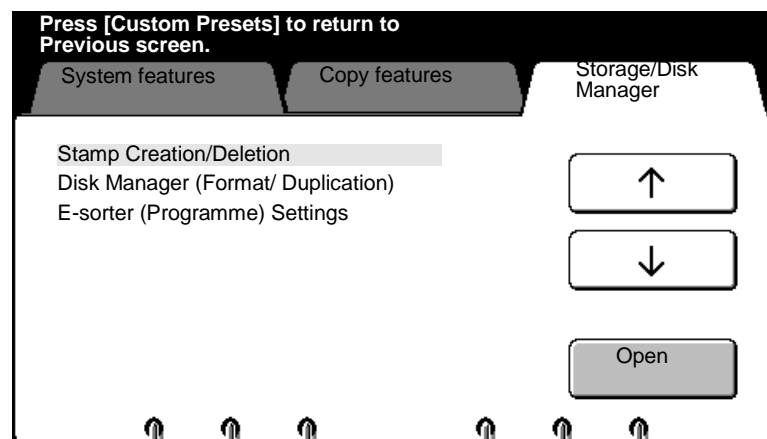

1. Enter custom presets. If needed, refer to page 174.
2. Select the **storage/disk manager** tab.
3. Use the arrow buttons to select the **stamp creation/deletion** feature.
4. Select **open**.

The **stamp creation/deletion screen** is displayed.

## How to change the storage/disk manager features (continued)

---

### Stamp creation/deletion (continued)

---

#### Stamp deletion (continued)

---

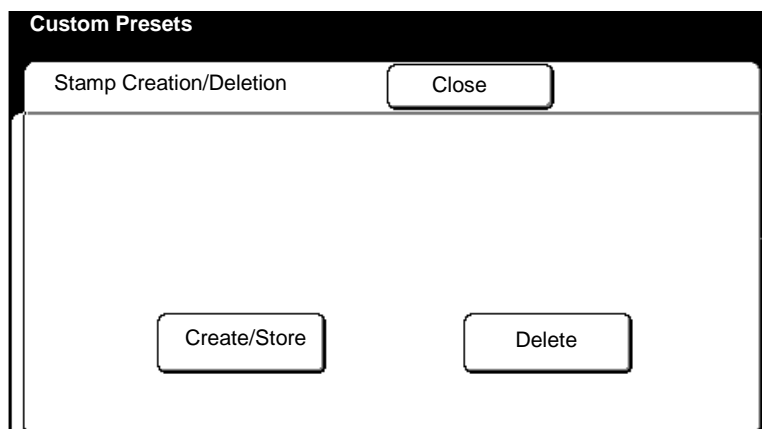

5. Select **delete**.

The **stamp deletion screen** is displayed.

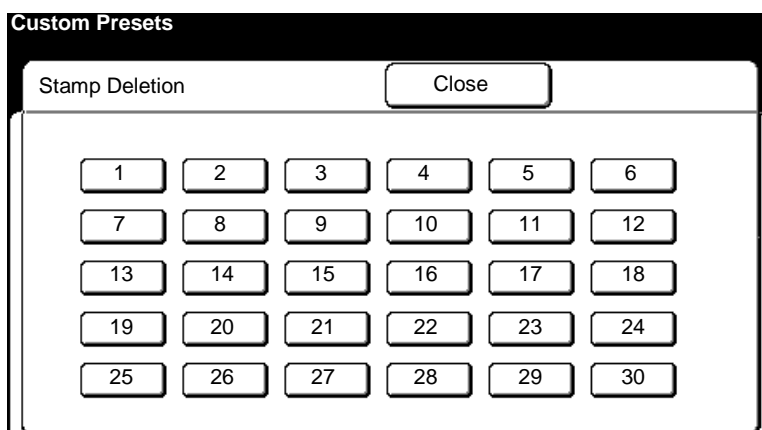

6. Select the desired stamp pattern number you want to delete.

- Only raised buttons are available for deletion.

An overlay screen is displayed.

7. Select **yes** to delete, **no** to cancel deletion.

If **yes** is selected, a **confirm screen** is displayed. Select **confirm**. The selected stamp pattern is deleted from the floppy disk.

## How to change the storage/disk manager features (continued)

---

### Stamp creation/deletion (continued)

---

#### Stamp deletion (continued)

---

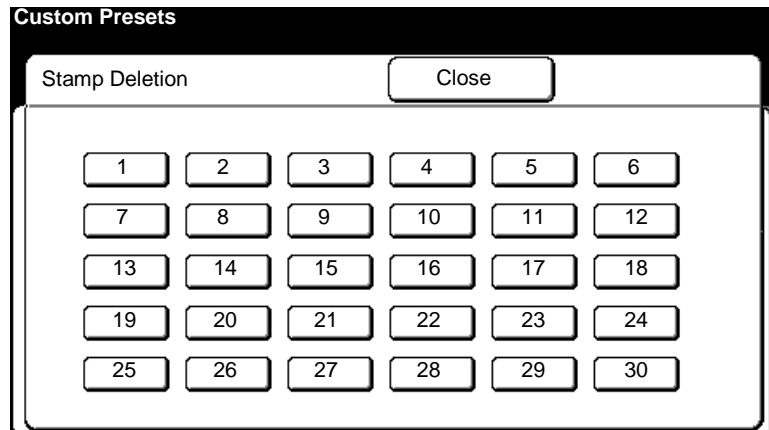

- Repeat steps 6 and 7, as necessary, to delete the stamps you no longer need.
- Select **close** when you are done.

The **stamp creation/deletion screen** is displayed.

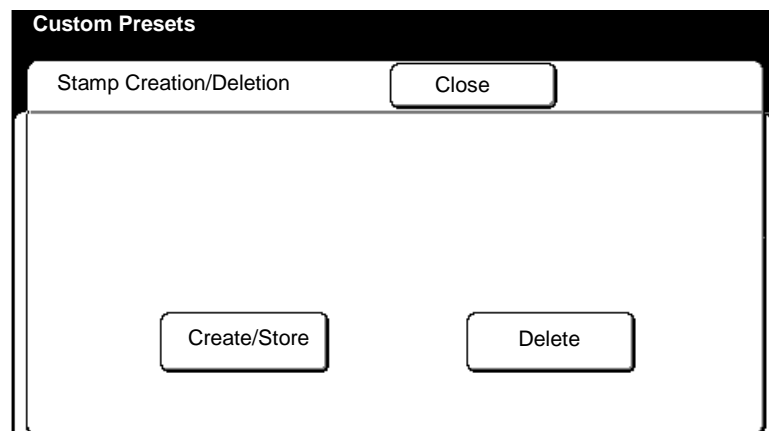

- Select **close** to exit the screen.
- To exit custom presets, press the **custom presets button**.

# How to change the storage/disk manager features (continued)

## Disk manager (format/duplication)



*Note: The format used by the floppy drive is unique to MAX 200; it can not read or write PC, Macintosh, or UNIX files. You must format your floppy disk from the MAX 200.*

### Introduction

The **disk manager (format/duplication) feature** allows you to format or make a back-up copy disk, for MAX 200 only.

#### Custom presets Function feature

**Format** Select to format the floppy disk for MAX 200. Refer to page 245.

**Duplication** Select to create a stamp pattern back-up disk. Refer to page 247.

### Format

### Procedure

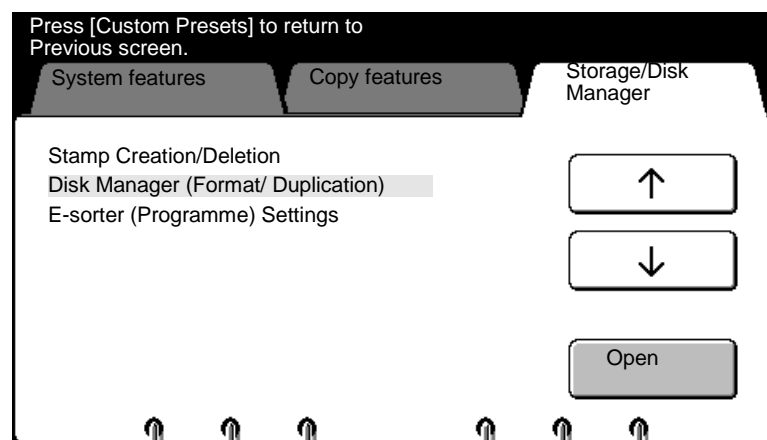

1. Enter custom presets. If needed, refer to page 174.
2. Select the **storage/disk manager** tab.
3. Use the arrow buttons to select the **disk manager (format/duplication)** feature.
4. Select **open**.

The **disk manager screen** is displayed.

## How to change the storage/disk manager features (continued)

---

### Disk manager (format/duplication) (continued)

---

#### Format (continued)

---

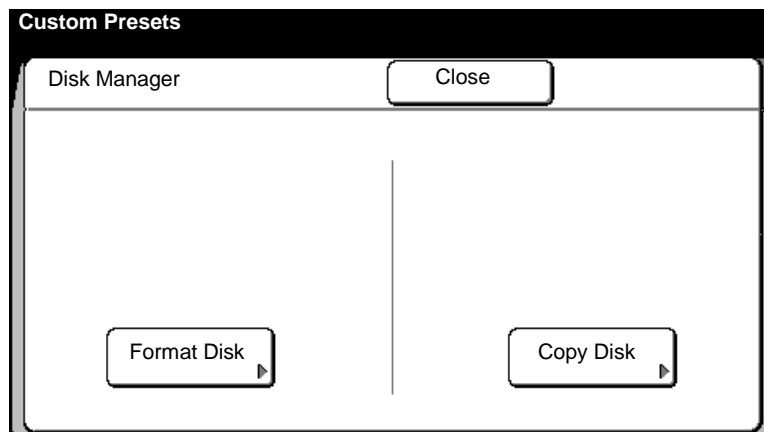

5. Select **format disk**.  
The **format disk for screen** is displayed.
6. Ensure a floppy disk is loaded into the disk drive.
7. Select **start**.  
The disk is formatted.
8. Select **confirm**, to return to the disk manager screen.
9. Select **close**, to exit the disk manager screen.
10. To exit custom presets, press the **custom presets button**.



## How to change the storage/disk manager features (continued)

---

### Disk manager (format/duplication) (continued)

#### Duplication

##### Procedure

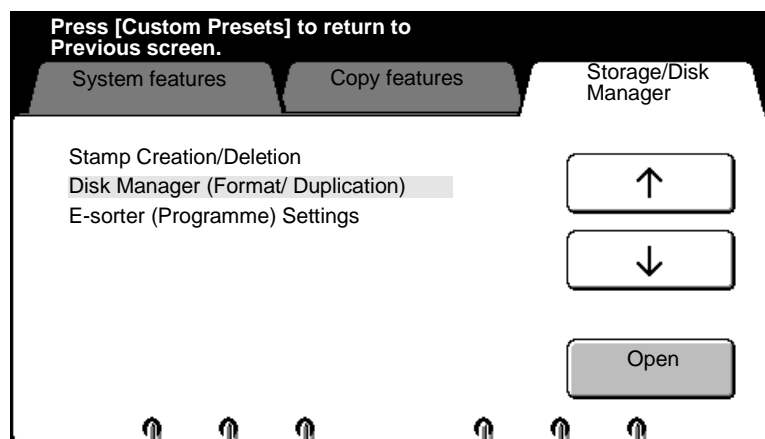

1. Enter custom presets. If needed, refer to page 174.
2. Select the **storage/disk manager** tab.
3. Use the arrow buttons to select the **disk manager (format/duplication)** feature.
4. Select **open**.  
The **disk manager (format/ duplication) screen** is displayed.

## How to change the storage/disk manager features (continued)

---

### Disk manager (format/duplication) (continued)

---

#### Duplication (continued)

---

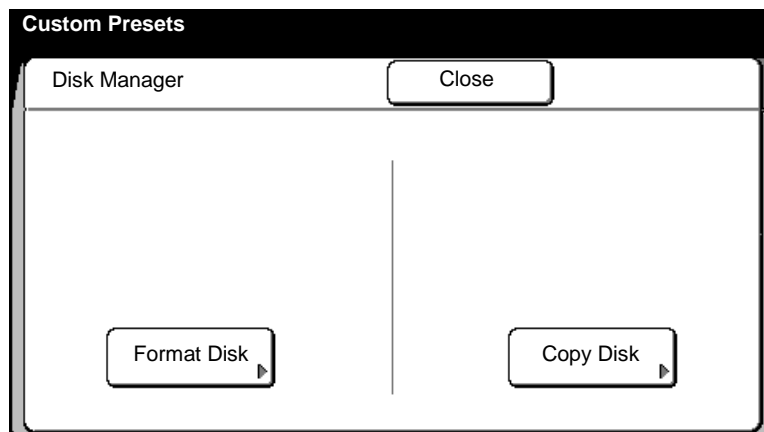

5. Select **copy disk**.  
The **copy disk for screen** is displayed.
6. Load the source disk (containing the data) into the disk drive.
7. Select **start**.  
When complete, remove the source disk from the floppy drive.
8. Load a (MAX 200 formatted) destination disk into the disk drive.  
If needed, refer to page 245.
9. Select **start**.
10. When the duplication process is complete, **select** confirm.  
The **disk manager screen** is displayed.

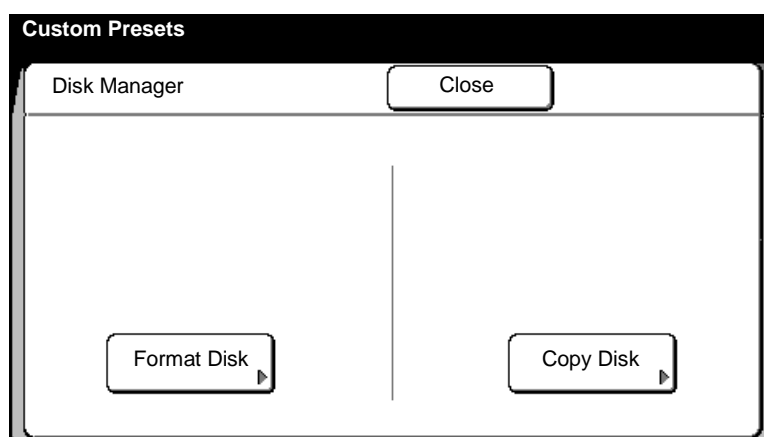

11. Select **close** to exit the disk manager screen.
12. To exit custom presets, press the **custom presets button**.

## How to change the storage/disk manager features (continued)

---

### E-sorter (program) settings

---

#### Introduction

The **E-sorter program settings feature** allows you to setup, modify, or delete an E-sorter program. The MAX 200 can store a maximum of 300 programs, into memory. Each program can have a maximum of 40 customers.

Lets say you have a set of drawings, one electrical, one plumbing, and one mechanical and you have four different customers. The **E-sorter program setting feature** allows you to print as many copies of each document to each customer.

The chart below is setup for program number 1. As you can see, this is a convenient tool for users to automate the copy function for jobs that have a complex distribution list.

	Program 1		
	Copy quantity for each document		
Customer number	Electrical document	Plumbing document	Mechanical document
1	Print 2	Print 0	Print 1
2	Print 0	Print 0	Print 1
3	Print 1	Print 0	Print 1
4	Print 1	Print 10	Print 1

Once the program is setup, you can print the deliver pattern automatically using the E-sorter program screen, on 135.

If needed, you can automatically setup each program to the same job settings from a specific stored job number.

To help setup your E-sorter programs use the above chart as an example for each of your E-sorter programs.

## How to change the storage/disk manager features (continued)

---

### E-sorter (program) settings (continued)

---

#### Procedure

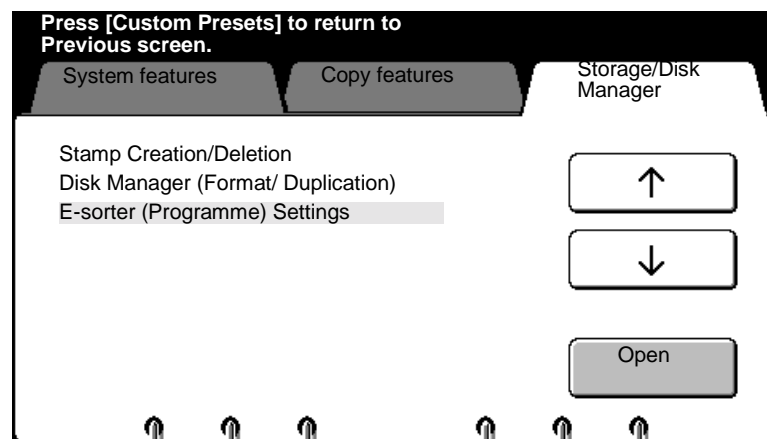

1. Enter custom presets. If needed, refer to page 174.
2. Select the **storage/disk manager** tab.
3. Use the arrow buttons to select the **E-sorter (program) settings** feature.
4. Select **open**.

The **E-sorter (program) settings** screen is displayed.

## How to change the storage/disk manager features (continued)

---

### E-sorter (program) settings (continued)

---

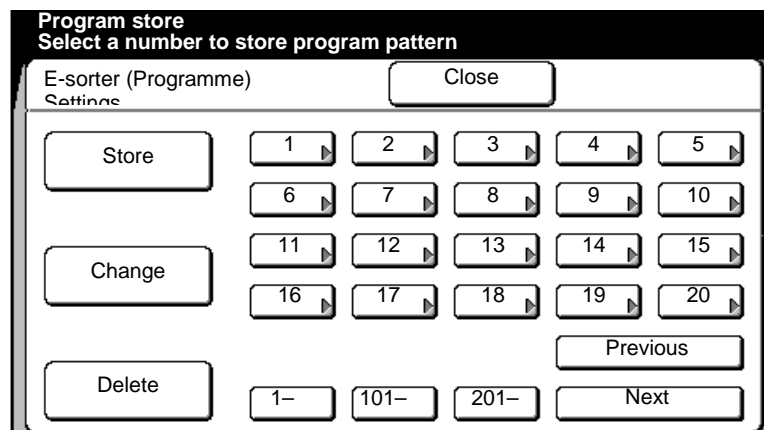

5. Select the desired option; **Store**, **change** or **delete**.
  - Store** Select to setup and store a E-sorter program.
  - Change** Select to change a specific E-sorter program that is already stored.
  - Delete** Select to delete an entire E-sorter program.
6. Select a program number. Available numbers are shown raised.
7. Refer to the selected option, from step 5:
  - **Store**, page 252.
  - **Change**, page 254.
  - **Delete**, page 255.

## How to change the storage/disk manager features (continued)

### E-sorter (program) settings (continued)

#### Store

The **selected E-sorter program number screen** is displayed (If 5 was selected from the previous step, the screen below would display **Store: 5**).

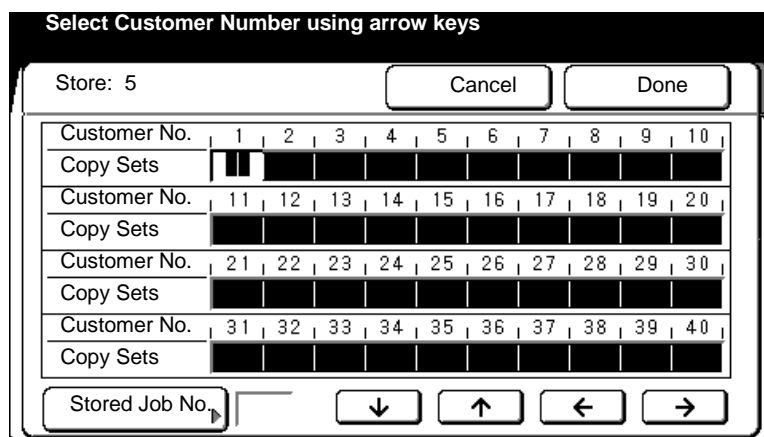

- Use the **arrow buttons** to select the desired customer number.
- Enter the number of desired copy sets for each desired customer number, using the numeric keypad.

If you would like to apply the copy features from a stored job, select the stored job no. button. Else continue to step 12.

The **store screen** is displayed.

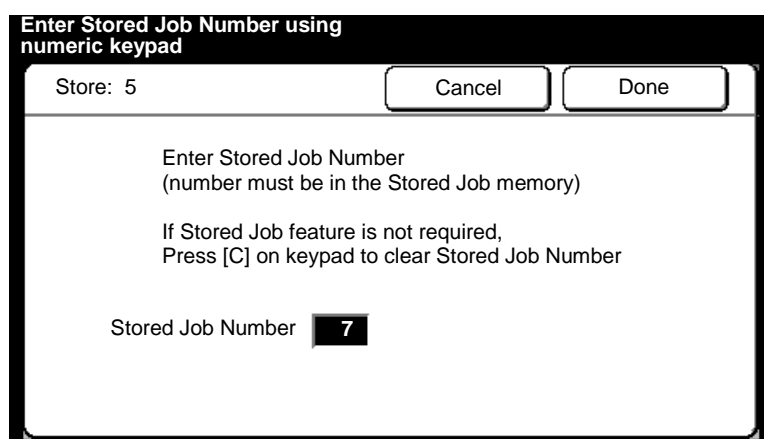

- Use the numeric keypad to enter the stored job number (the screen above displays stored job number 7).

Only the following settings are transferred to the program, auto mode, the cut mode, stamping setup, document feed direction and the reduction and enlargement settings.

- Select **done**.

## How to change the storage/disk manager features (continued)

### E-sorter (program) settings (continued)

#### Store (continued)

The E-sorter program screen is displayed.

The screenshot shows a screen titled "Select Customer Number using arrow keys" and "Enter number of copies using numeric". At the top, it displays "Store: 5" with "Cancel" and "Done" buttons. Below this is a grid of 40 customer entries, each with a "Customer No." and "Copy Sets" field. The "Copy Sets" field for the first customer shows two bars. At the bottom, there is a "Stored Job No." field with the number "7" and four arrow buttons (down, up, left, right).

12. Select **done**, to exit the above screen.

The E-sorter (program) settings screen is displayed.

The screenshot shows a screen titled "Program store" and "Select a number to store program pattern". It features a "Close" button at the top right. The main area is divided into three sections: "Store" with buttons 1-5, "Change" with buttons 6-20, and "Delete" with buttons 1-, 101-, 201-, and "Next". A "Previous" button is also present.

13. Select **close** to exit this screen.
14. To exit custom presets, press the **custom presets. button.**

## How to change the storage/disk manager features (continued)

### E-sorter (program) settings (continued)

#### Change

The selected **E-sorter program screen** is displayed. This example displays E-sorter program 5, with stored job no. 7.

The screenshot shows a screen with the following elements:

- Header: "Select Customer Number using arrow keys" and "Enter number of copies using numeric".
- Top bar: "Store: 5" on the left, "Cancel" and "Done" buttons on the right.
- Grid of customer numbers and copy sets:

Customer No.	1	2	3	4	5	6	7	8	9	10
Copy Sets			2							
Customer No.	11	12	13	14	15	16	17	18	19	20
Copy Sets										
Customer No.	21	22	23	24	25	26	27	28	29	30
Copy Sets										
Customer No.	31	32	33	34	35	36	37	38	39	40
Copy Sets										
- Bottom bar: "Stored Job No." with a numeric keypad showing "7", and four arrow buttons (down, up, left, right).

8. Use the **arrow buttons** to select the desired customer number.

You can change the copy quantity information or create a new customer. Use the numeric keypad to enter data.



*Note: In this example it shows customer no. 3 has a copy quantity of 2.*

9. To assign or change the stored job number setting to this program, select **stored job no.** Use the numeric keypad and enter the stored job number. To exit the **store job screen**, select **done**. Else continue to the next step.

To cancel the changes and exit from this screen, select **cancel**.

9. When all customer data is entered, select **done**.
10. The **E-sorter (program) settings screen** is displayed. Select **close** to exit.
11. To exit custom presets, press the **custom presets button**.



## How to change the storage/disk manager features (continued)

### E-sorter (program) settings (continued)

#### Delete

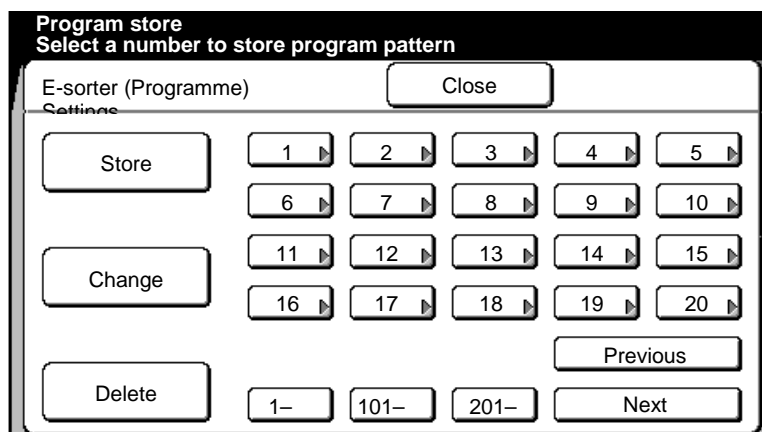

8. Select **yes** or **no**.

If **yes** is selected, the selected pattern is deleted.

If **no** is selected, the selected pattern is not deleted.

The **E-sorter (program) settings screen** is displayed.

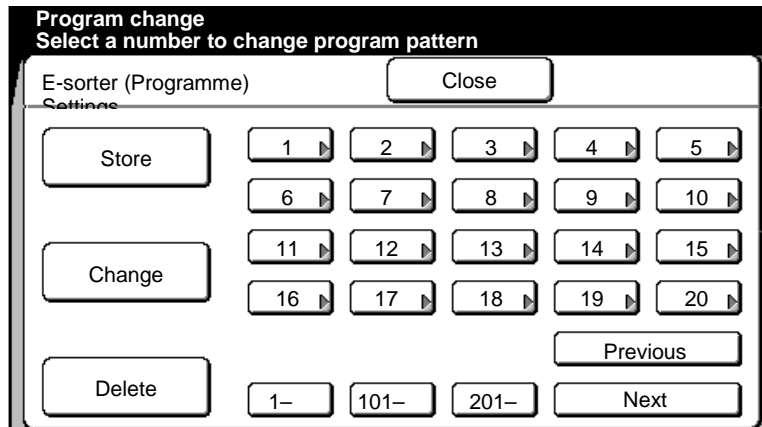

9. Select **close**, to exit from this screen.

10. To exit, press the **custom presets** button.

---

## Care

---

### Cleaning the scanner platen glass

---

To avoid image quality problems, clean the platen glass on the scanner periodically. Dirt on the platen glass or the white platen roll may cause dark streaks along the entire copy length.

Use the following procedure if dark streaks appear on copies due to dirt build-up, on the platen glass or white platen roll.



*Note: Do not use abrasive glass cleaner or solvents on the scanner platen glass.*

#### Procedure

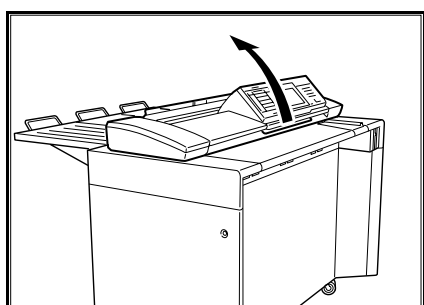

1. Lift up on the release lever to open the scanner cover.

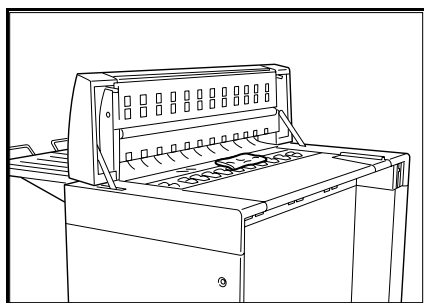

2. Clean the platen glass and roller with a soft, clean cloth dampened with water or glass cleaner.

Do not use thinner, benzene, or any other volatile-cleaning agent.

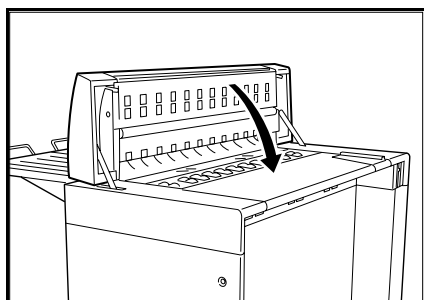

3. Close the scanner cover.

### Ordering supplies

---



To order supplies for the MAX 200 call 1-800-538-6468. A supplies representative will assist you with evaluating your supply needs. You can reach the 24-hour fax order line at 1-800-204-5403.



For more information, visit the Xerox Engineering Systems web site at <http://www.xes.com>.

---

## Problem solving

---

This chapter identifies some machine problems that may occur, the recommended solutions, and information on how to clear document and media jams.

Use the information in this chapter to assist you with a machine problem when they occur. If needed, also refer to the network controller server manual.

Should you be unable to resolve a problem, place a call to your Xerox Engineering Systems representative.



*Note: This problem solving section only lists problems for the scanner and printer. If your machine is equipped with the optional folder or stacker, refer to their user guide for any problems.*

---

## Problem solving chart

---

This section lists various printer or scanner problems, that may occur and the suggested solution for each problem.

Problems	Suggested solutions
There are no indicators or messages displayed on the scanner control panel.	Ensure that the circuit breaker is switched on. Call for electrical assistance to ensure power is at the scanner or printer control panels.  Ensure that the scanner is plugged in.  Use the brightness control dial and adjust the display contrast.  Ensure that the ground fault protectors have not been activated. For detailed information about MAX 200 power, refer to page 41.
The <b>ready to copy</b> message is not displayed.	Resolve any error messages that are displayed.
Documents cannot be fed into the machine.	Follow the messages on the display.
Copies have black streaks or spots.	Clean the scanner platen glass with a moisten cloth if necessary.  Clean the white platen roll with a soft dry cloth if necessary.  For detailed information on how to clean the scanner platen glass, refer to page 256.
Copies are contaminated (excess toner).	Adjust the image density.  Check the condition of your document. Adjust the background suppression.

## Problem solving chart (continued)

---

Problems	Suggested solutions
Copy image is partially deleted.	<p>Press the <b>review button</b>. Ensure that the appropriated features are selected.</p> <ul style="list-style-type: none"><li>• Ensure that the media width and length are appropriate for document size being copied.</li><li>• Ensure that the document has been fed in the correct direction.</li><li>• Ensure the correct edit features are selected.</li></ul> <p>Ensure the image quality selections are appropriate for the documents being copied.</p> <p>If the media is moist, replace it.</p>
Copies are wrinkled.	<p>If the media is moist, load fresh media.</p>
Media jams repeatedly.	<p>Check for jammed or torn media left in the machine.</p> <p>Check the copy media for folds, wrinkles, and tears. Replace it if necessary.</p> <p>Ensure that the media is loaded correctly. Reset the media trays and rolls.</p> <p>Check that the media is within specifications. Use the recommended media.</p>
Document jams repeatedly.	<p>Check document for folds, wrinkles and tears. Replace or repair if necessary.</p> <p>Use a document carrier for smaller documents.</p>

## Clearing a scanner jam

---

When a scanner document jam occurs, the scanner stops feeding the document and a error message is displayed. The copy in progress will be fed out to the output tray.

### Procedure

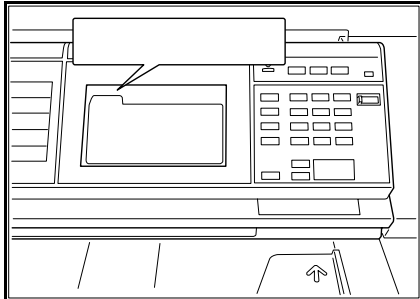

1. Document jam message is displayed.

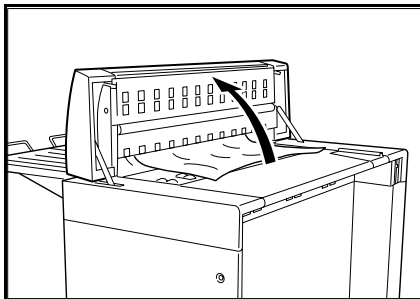

2. Lift the release lever to open the scanner cover.

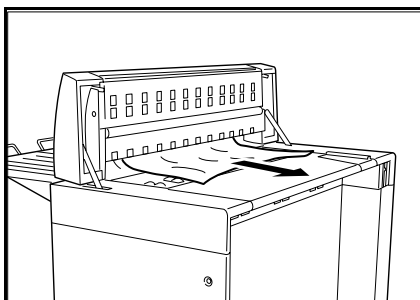

3. Carefully remove the jammed document.

## Clearing a printer jam

---

When a printer jam occurs, an error message is displayed. Along with the error message, use the printer diagram indicator lamps to guide you to the printer area that needs attention.

If the jam occurs during the scanning process, the document image is stored into memory and the jammed copies are remade, once the jam is cleared.

### Procedure

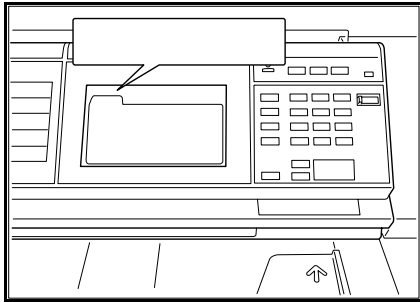

1. Document jam message is displayed.

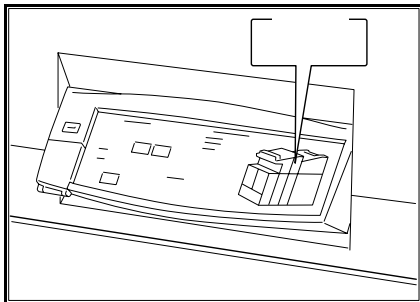

2. The printer diagram indicates the media jam area.
3. Go to the appropriate media jam procedure.
  - For indicator lamps 1- 4, refer to page 261.
  - For indicator lamp 5, refer to page 262.
  - For indicator lamps 6 or 7, refer to page 263.
  - For indicator lamp 8, refer to page 264.
  - For indicator lamp 9, refer to page 266.
  - For indicator lamp 10, refer to page 268.
  - For indicator lamp 11 or 12, refer to page 270.

## Clearing a printer jam (continued)

### Indicator lamps 1 - 4

When indicator lamps 1 to 4 are lit, the following problem may occur:

- Roll media was not loaded correctly.
- Media cannot be feed normally from the RFC drawer.

#### Procedure



*Note: This procedure can be used for all the RFC drawers.*

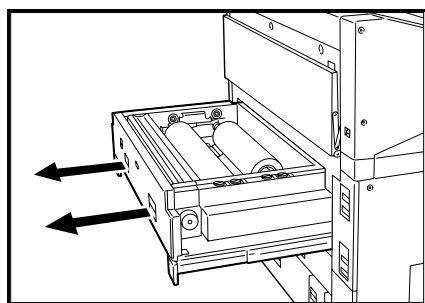

1. Pull out the RFC drawer.
2. Ensure each roll is not folded or torn.

If needed, cut it with a scissors or manual cutter (page 53).

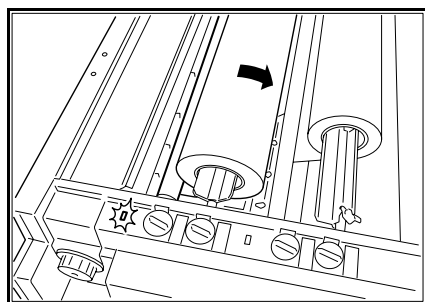

3. Rotate the media roll toward the back of the RFC drawer, and place the lead edge of the roll under the roller.
4. Feed the media roll until you hear a beep and the paper set indicator lamp is lit.



**Caution:** If the media roll is not loaded correctly, the paper set indicator lamp will not light.

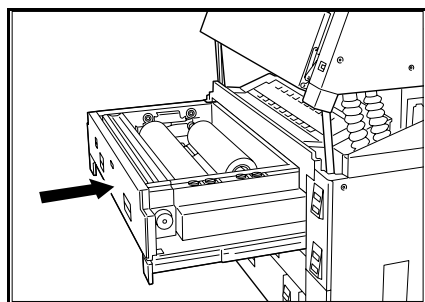

5. Push in the RFC drawer until it stops

## Clearing a printer jam (continued)

### Indicator lamp 5

When indicator lamp 5 is lit, there is a problem in the cut sheet tray.

#### Procedure

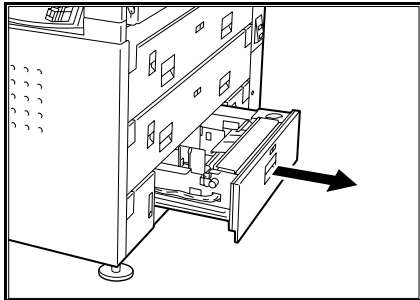

1. Pull out the cut sheet paper tray.

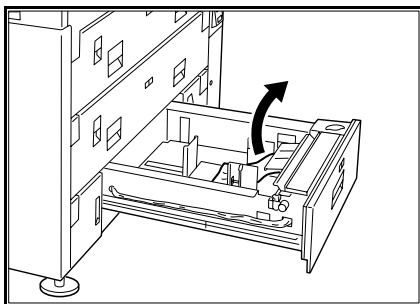

2. If applicable, remove any jammed paper.
3. Remove the media stack.

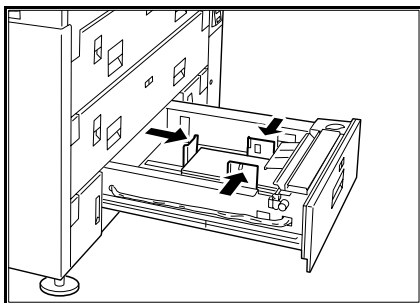

4. Reload the cut sheet media into the tray.  
Ensure the three paper guides are positioned correctly.

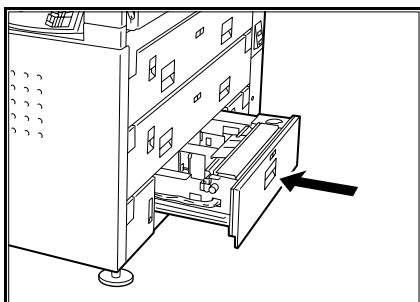

5. Push in the tray until it stops.



## Clearing a printer jam (continued)

---

### Indicator lamps 6 or 7

---

When indicator lamp 6 is lit, a media jam has occurred between the RFC drawer 1 and the xerographic area of the machine.

When indicator lamp 7 is lit, a media jam has occurred between the RFC drawer 2 and the xerographic area of the machine.

#### Procedure

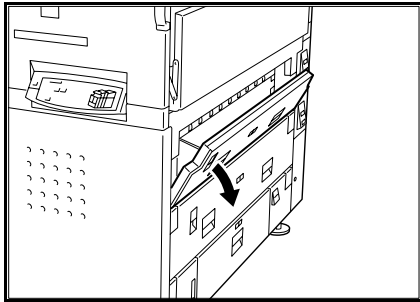

1. If indicator lamp 6 is lit, open the RFC drawer 1 cover or if indicator lamp 7 is lit, open the RFC drawer 2

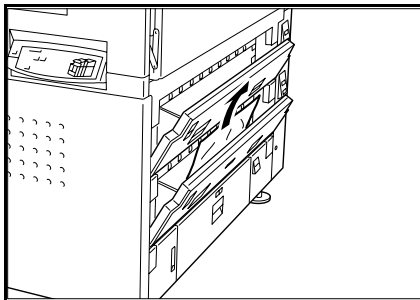

2. Remove the media jam. If needed, cut the media manually (page 53) and return to this procedure to perform the next step.



*Note: This example shows media being removed from the RFC drawer 2.*

3. Close the RFC cover.



**Caution:** A message is displayed, until all RFC covers are closed correctly.

## Clearing a printer jam (continued)

---

### Indicator lamp 8

---

When indicator lamp 8 is lit, a media jam has occurred between the manual feed tray and xerographic area.

#### Procedure

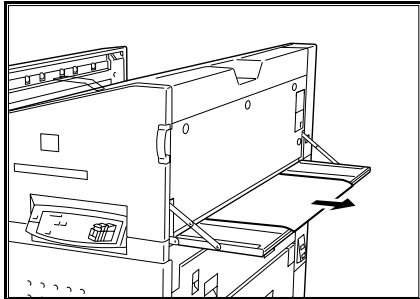

1. Carefully, pull out any cut sheet media on the manual feed tray.  
If there is no media on the tray go to the next step.

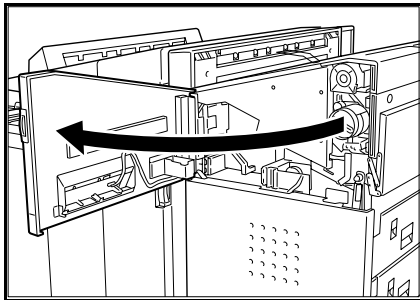

2. If no paper is visible, open the front door of the printer.

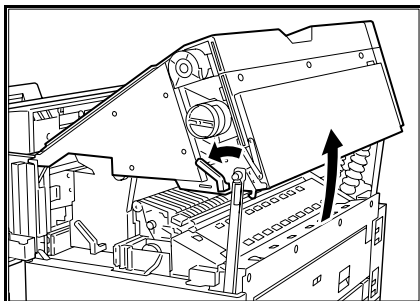

3. Rotate the latch-handle counterclockwise to open the upper area of the printer.
4. Raise the upper area of the printer until the stopper is latched.

## Clearing a printer jam (continued)

---

### Indicator lamp 8(continued)

---

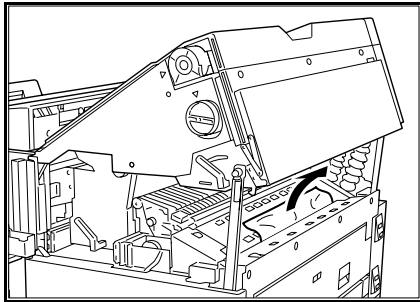

**Caution:** When removing media, try not to tear the media.

5. Remove the media jam.

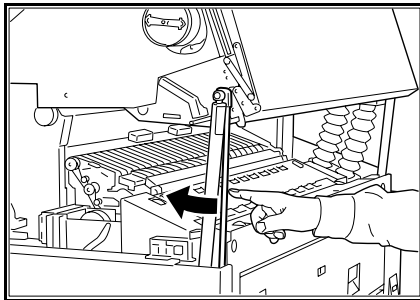

6. Push to unlock the stopper.

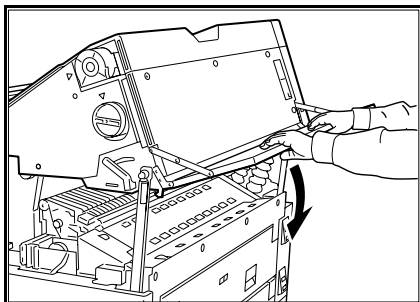

7. Close the upper area of the printer.

If needed, push down on the center of the manual feed tray.



**Caution:** To avoid hitting the tray, ensure the tray is in the closed position, after using.

8. Close the front door of the printer.

## Clearing a printer jam (continued)

### Indicator lamp 9

When indicator lamp 9 is lit, the paper jam occurred before the xerographic area under the drum.

#### Procedure

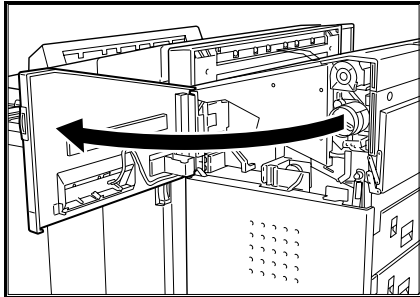

1. Open the front door of the printer.

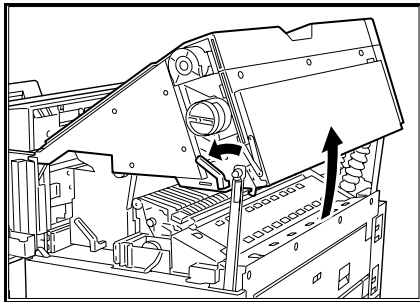

2. Rotate the latch-handle counterclockwise to open the upper area of the printer.

3. Raise the upper area of the printer until the stopper is latched.

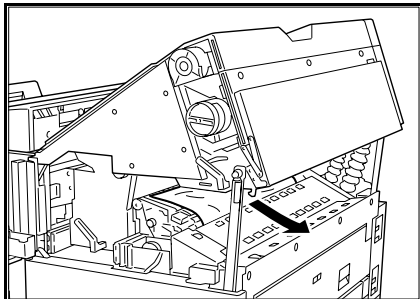

**Caution:** When removing media, try not to tear the media.

4. If the media is cut, remove the media jam and continue to the next step.

If the media is not cut, go to the manual cut procedure (page 53) and return to this procedure to perform the next step.

## Clearing a printer jam (continued)

---

### Indicator lamp 9 (continued)

---

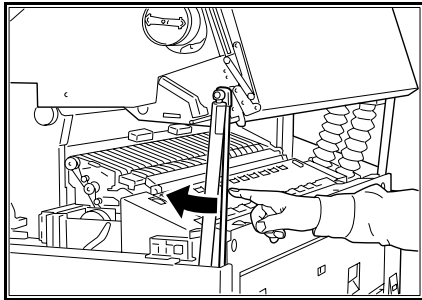

5. Push to unlock the stopper.

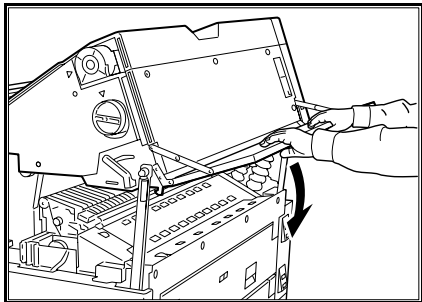

6. Close the upper area of the printer.  
If needed, push down on the center of the manual feed tray.



**Caution:** To avoid hitting the tray, ensure the tray is in the closed position, after using.

7. Close the front door of the printer.

## Clearing a printer jam (continued)

### Indicator lamp 10

When indicator lamp 10 is lit, there is a media jam in the fuser area.

#### Procedure

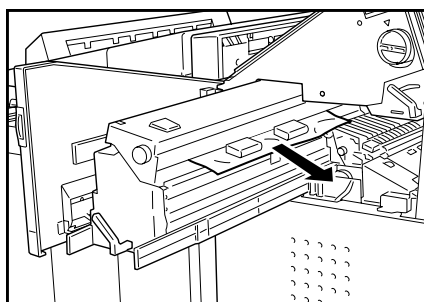
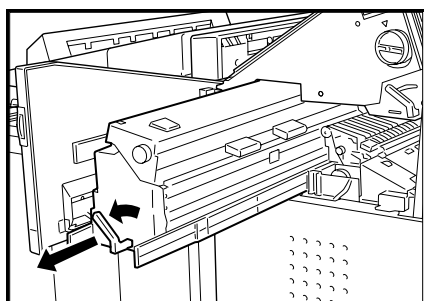
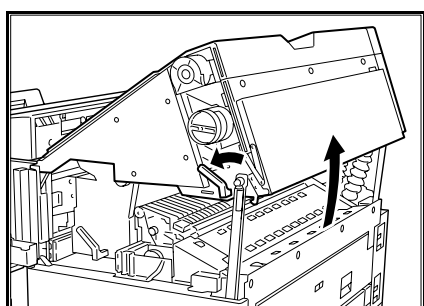
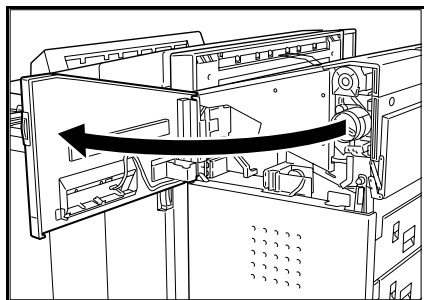

1. First complete the procedure for indicator lamp 9, on page 266. If the jam is not cleared, continue to the next step.

2. Open the front door of the printer.

3. Rotate the latch-handle counterclockwise to open the upper area of the printer.



*Note: If the open light is off or blinking, the latch handle can not open the upper area of the printer.*

4. Lift the upper area of the printer until the stopper is latched.



**Warning: The fuser area is extremely hot. Never touch areas other than the handle when clearing a media jam.**

5. Rotate the fuser lever counterclockwise and gently pull the fuser out.



**Warning: Sharp fuser parts are labeled; use care to avoid touching them.**

6. Remove the jammed media in the direction of the arrow. If it is removed from the left side of the fuser, unfused toner could contaminate the next copy.

## Clearing a printer jam (continued)

---

### Indicator lamp 10 (continued)

---

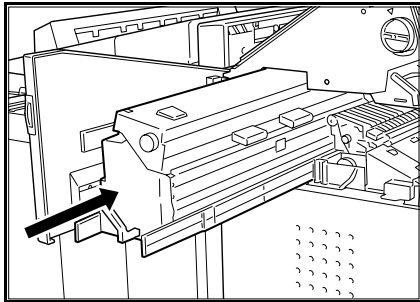

7. Slide the fuser back into the printer until it stops.

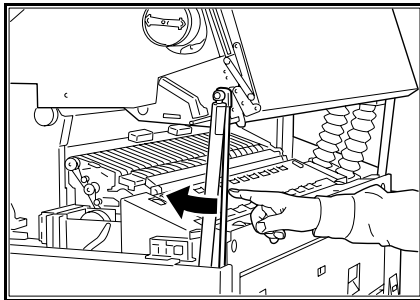

8. Push the stopper to unlock.

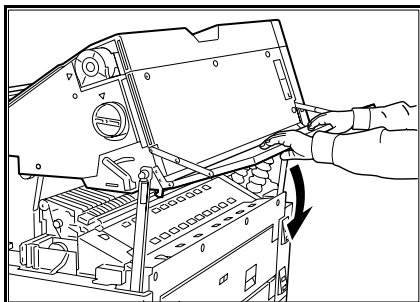

9. Close the upper area of the printer.

If needed, push down on the center of the manual feed tray.



**Caution:** To avoid hitting the tray, ensure the tray is in the closed position, after using.

10. Close the front door of the printer.

If the door does not close, ensure the fuser is pushed in all the way.

## Clearing a printer jam (continued)

---

### Indicator lamp 11 or 12

---

When the printer indicator lamp 11 or 12 is lit, a media jam has occurred in the printer output area.

#### Procedure

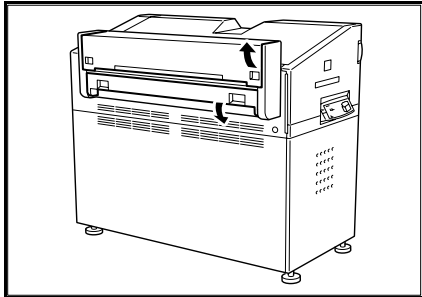

1. Open the printer left doors.

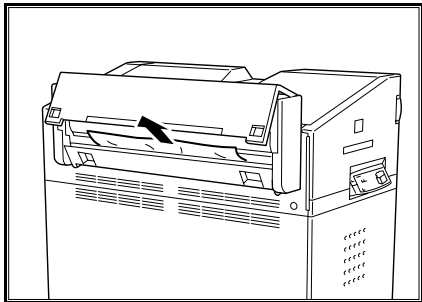

**Warning:** The area inside the left doors of the printer reaches high temperatures. Take care when removing a media jam in this area.

2. Remove the media jam.



**Caution:** When removing media, try not to tear the media.

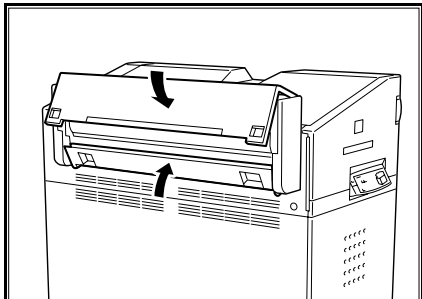

3. Close the printer left doors.

A message is displayed, on the printer control panel, until all printer doors are closed correctly.



# Replacing the toner cartridge

There are two toner cartridges, black (upper) and red (lower). The same procedure applies to each cartridge.



*Note: Do not remove the toner cartridge unless a message on the printer control panel is displayed.*

## Procedure

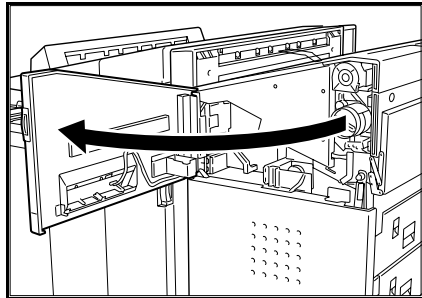

1. Open the printer front door.

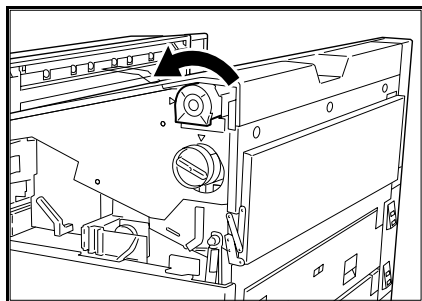

2. Rotate the toner cartridge counterclockwise until it stops.
  - The toner cartridge may be difficult to turn.
  - The toner cartridge lid is closed automatically when the cartridge is unlocked.

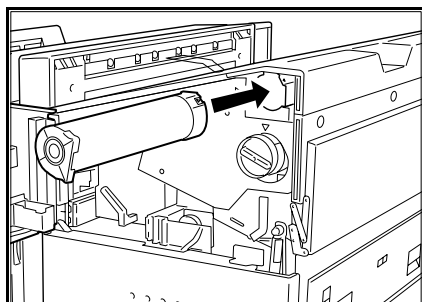

3. Remove the toner cartridge slowly.

Carefully remove the toner cartridge to keep loose toner from spilling.

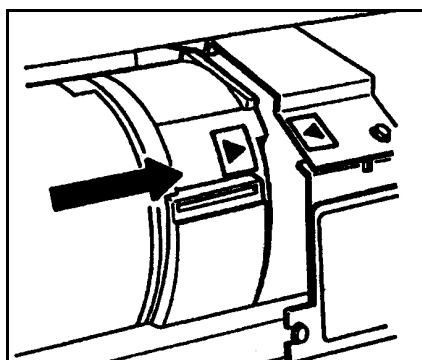

4. Shake the new toner cartridge.
5. Place the new toner cartridge into the holder; align the symbols shown.

## Replacing the toner cartridge (continued)

---

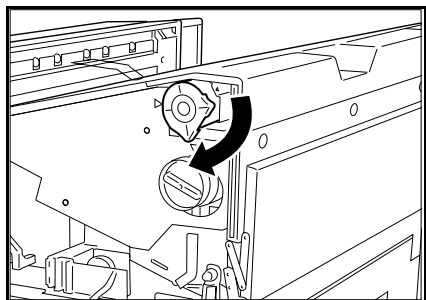

6. Rotate the toner cartridge clockwise until it stops.  
Make sure that both arrow symbols are aligned.

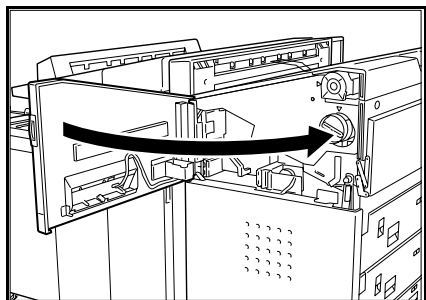

7. Close the printer front door.

## Relatch the fuser

When the printer control panel displays the message **relatch fuser**, the fuser is not set correctly. Follow this procedure to relatch the fuser.



**Warning:** The fuser area is extremely hot. Never touch areas other than the handle.



**Warning:** Sharp fuser parts are labeled. Use care to avoid touching them.

### Procedure

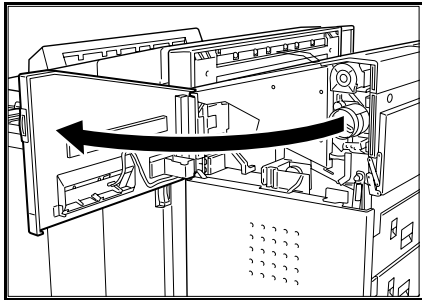

1. Open the printer front door.

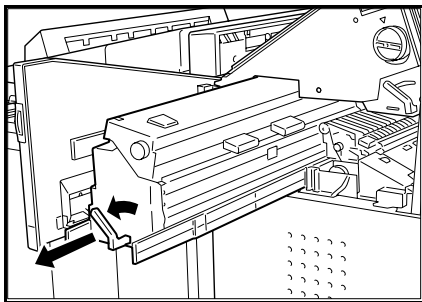

**Warning:** The fuser area is extremely hot. Never touch areas other than the handle when clearing a media jam.

2. Rotate the fuser handle counterclockwise and gently pull the fuser out.



**Warning:** Sharp fuser parts are labeled; use care to avoid touching them.

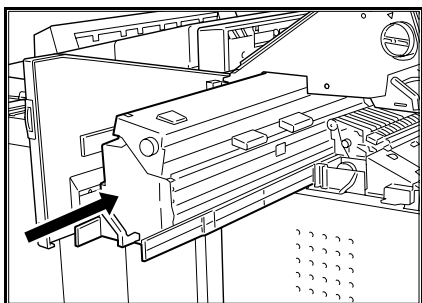

3. Slide the fuser back into the printer until it stops.

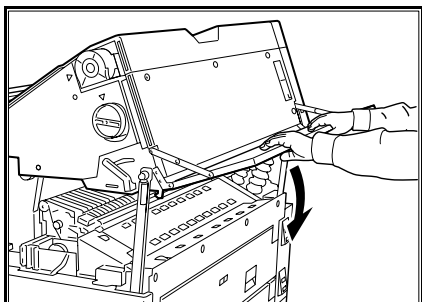

4. Close the upper area of the printer.

If needed, push down on the center of the manual feed tray.



**Caution:** To avoid hitting the tray, ensure the tray is in the closed position, after using.

5. Close the front door of the printer.

If the door does not close, ensure the fuser is pushed in all the way.

## Calling for service

---

Should you be unable to resolve a problem, place a call to your Xerox Engineering Systems service representative.

The service representative will assist you in keeping your MAX 200 operating and if required, will arrange for a customer service engineer to inspect your MAX 200 and restore its performance.

When calling service, the machine serial number is required, you can access the serial number by selecting the meter check feature. For detailed information on how to obtain the serial number, refer to page 24.

The following information is needed when you call for service:

**Customer account name:** \_\_\_\_\_

**Customer account number:** \_\_\_\_\_

**Machine type:** \_\_\_\_\_

**Scanner serial number:** \_\_\_\_\_

**Printer serial number:** \_\_\_\_\_

**Purchase date:** \_\_\_\_\_



United States XES      1-877-3627 or 1-877-XES-DNCS.  
Customer First Center



Canada                      1-800-939-3769.



For more information, visit the Xerox Engineering Systems web site at <http://www.xes.com>.

## Scanner interface (optional)

### Overview

The **scanner interface feature** is an optional feature, it allows you to scan your documents and send them to a host workstation.

Use the following procedure to scan your documents. For detailed information on how to use the plotter software, refer to the plotter software user guide.

### Procedure

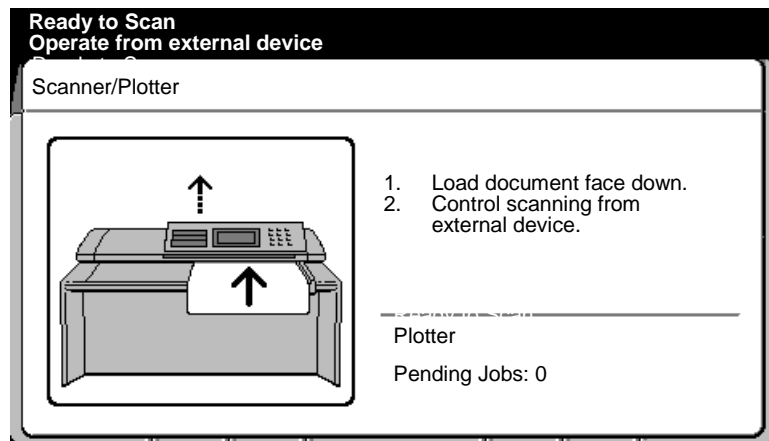

1. Select the scanning mode from the host workstation.
2. After a short wait, the scanner interface screen is displayed.
3. Insert the document to be scanned when the **ready to scan** message is displayed.

---

## Plotter interface (optional)

---

### Overview

---

The **plotter interface feature** is optional. It allows you to send a document from a host workstation to the scanner, which is then immediately printed.

You also have the option to make copies from the scanner (copy mode). When the plotter interface is installed, the machine always defaults to plot mode. In order to make copies from the scanner (copy mode), the MAX 200 must be in copy mode. For detailed information on how to enter copy mode, refer to page 277.

Custom presets has three plotter setup features, they are:

Feature	Function
<b>Set default time to plot</b>	You can set the predetermined delay time it takes the machine to return to plot mode after making a copy (copy mode). Refer to page 183.
<b>Set delay time to copy mode</b>	You can set the predetermined delay time before copy mode is active, after completing a plotter job. Refer to page 185.
<b>Folder</b>	Setup the fold default for the plot mode. Refer to page 187. To setup the fold parameters for each fold, refer to page 203.

## Overview (continued)

### How to enter copy mode from plot mode

When the plotter interface kit is installed, your machine defaults to the plot mode. In order to make copies from the scanner (copy mode) or enter custom presets, the machine must be in copy mode.

Use the procedure, in this section, to enter copy mode from plot mode.

#### Procedure

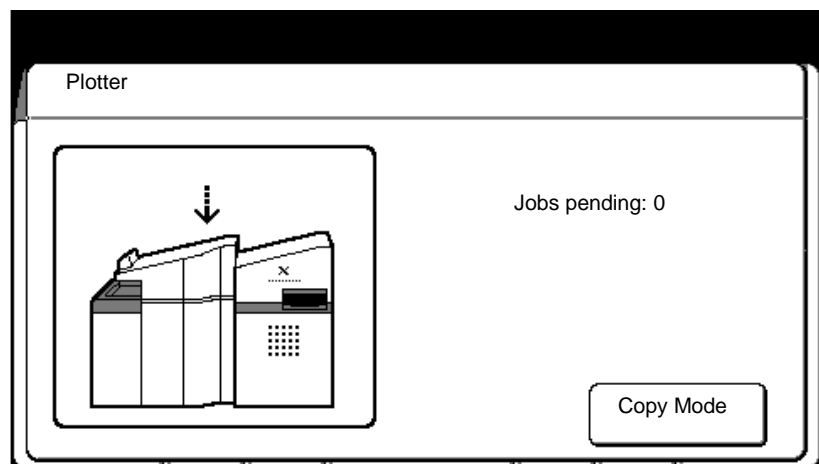

1. Select **copy mode**.

The **basic feature group screen** is displayed.

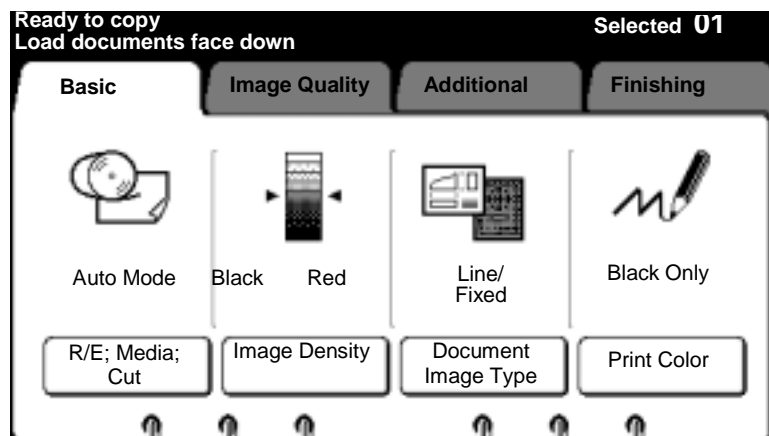

---

## Technical data

---

## Printer specifications

---

### Physical characteristics

---

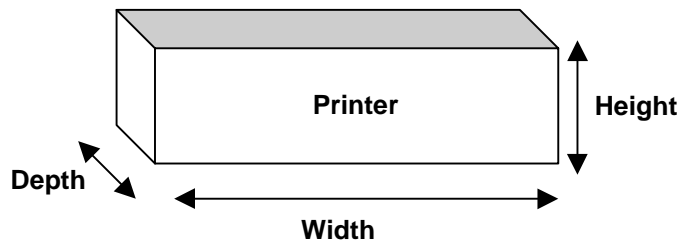

Printer	
Height	54 inches
Width	37 inches
Depth	64 inches
Weight	1807 lb.
Maximum elevation	0 –6560 feet

### Floor space requirements

---

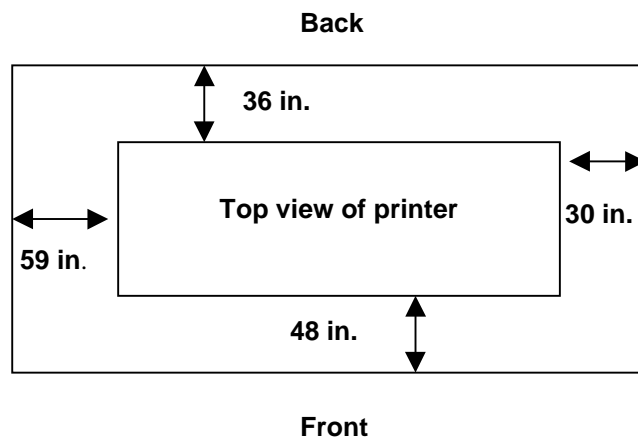



# Scanner specifications

---

## Physical characteristics

---

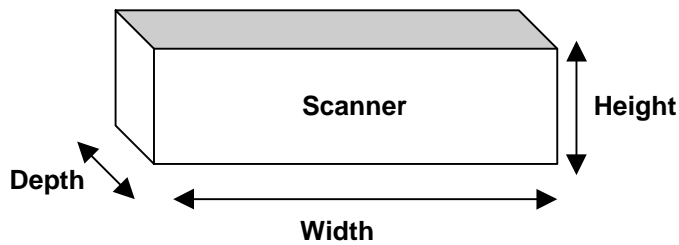

Scanner (with extended guide)	
Height	45.3 inches
Width	54 inches
Depth	56 inches
Weight	574.6 lb.

## Floor space requirements

---

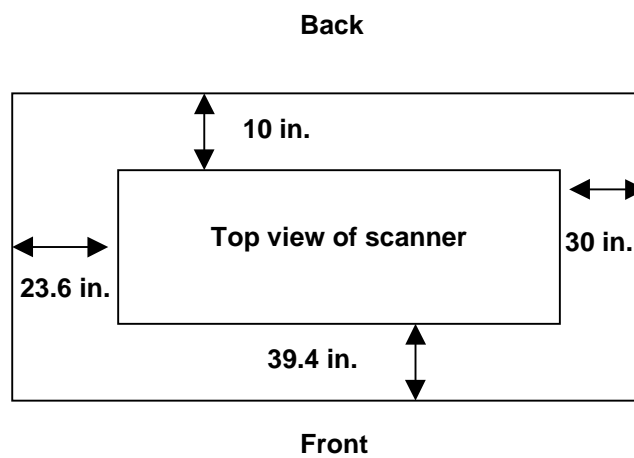

## System requirements

---

**Height clearance**

96 inches from floor to nearest overhead obstruction within the floor space requirements.

**Moveably**

Requires a service call.

**Room size**

600 cubic foot (17 cubic meters) with 0 air change/hour.

## Electrical

<b>Electrical specifications</b>	210 to 246 VAC
----------------------------------	----------------

<b>Voltage</b>		
Scanner	120 VAC	
Printer	Single phase 214 to 250 VAC Three phase 185 to 215 VAC	
<b>Current (Amps)</b>		
Scanner	20 A	
Printer	30 A	
Power consumption (Watts)	Scanner	Printer
Running	1100	5800
Standby	1000	5100

## Environmental data

<b>Operating range</b>	
Relative humidity	15% to 85%
Temperature	50 <sup>0</sup> F to 90 <sup>0</sup> F
<b>Heat output</b>	
Running	11,068 BTU/hr.
Standby	2700 BTU/hr.
<b>Audible noise (scanner and printer)</b>	
Running	49.5 db (A) or less
Standby	64 db (A) continuous 72 db (A) maximum
<b>Ozone</b>	
	Concentration based on simulation model: Daily copy volume: 8250 copies/8 hours Room size: 17 m <sup>3</sup> 0 Air changes per hour 77.6 ug/min 0.009 ppm (time weighted average) 0.016 ppm (peak) threshold limit value (0.10 ppm)
<b>Total dust</b>	
	0.04 mg/m <sup>3</sup> threshold limit value (10 mg/m <sup>3</sup> )
<b>Organics</b>	
	<10ppb

## Media specifications

	Roll media	Cut media	Manual feed tray media
<b>Media size</b>	ISO, E, D, C, B, A size widths	8.5 x 11 inch to 12 x 18 inch, long edge or short edge feed.	ISO, E, D, C, B, A, size widths
<b>Media weight</b>	20 lb.	20 to 24 lb.	20 lb.
<b>Media type</b>	Bond, vellum, film	Bond	Bond, vellum, film

## System capability

<b>Scanner resolution</b>	15.7 dots/mm (400 dpi)
<b>Warm-up time</b>	Max. 5 minutes (when breaker switch is held ON)
<b>First copy output time</b>	20 seconds for E
<b>Lead edge registration</b>	Roll $\pm 3.0$ mm Cut sheet B $\pm 2$ mm Cut sheet A $\pm 0.5$ mm
<b>Side registration</b>	Maximum of $\pm 1.5$ mm difference in multiple prints.
<b>Skew</b>	Maximum of 1.5 mm per 200 mm length
<b>Lead edge deletion</b>	Roll media (outside diameter of 100 mm or greater) = 5 mm Roll media (outside diameter of less than 100 mm) = 5 mm Cut sheet = 5 mm
<b>Trail edge deletion</b>	Roll media (outside diameter of 100 mm or greater) = 5 mm Roll media (outside diameter of less than 100 mm) = 5 mm Cut sheet = 5 mm
<b>Image area size</b>	880 mm wide
<b>Continuous prints (per minute)</b>	A: 29 minimum SEF, 36.5 minimum LEF B: 22.2 minimum SEF, 29 minimum LEF C: 16.9 minimum SEF, 22.2 minimum LEF D: 12.5 minimum SEF, 16.9 minimum LEF E: 9.1 minimum SEF
<b>Copy output tray capacity (printer)</b>	100 E-size sheets
<b>Document exit tray (scanner)</b>	50 D-size sheets 50 E-size sheets with extension bar pulled out
<b>Document size</b>	36 inch maximum width 0.05 mm to 0.2 mm thickness

## Material safety data sheet (MSDS) information

---

 United States 1-800-828-6571.

 Other countries Please call your regional Xerox Engineering Systems office.

 For more information, visit the Xerox environment web site at <http://www/Xerox/com/enviroment.html>.

## Free Manuals Download Website

<http://myh66.com>

<http://usermanuals.us>

<http://www.somanuals.com>

<http://www.4manuals.cc>

<http://www.manual-lib.com>

<http://www.404manual.com>

<http://www.luxmanual.com>

<http://aubethermostatmanual.com>

Golf course search by state

<http://golfingnear.com>

Email search by domain

<http://emailbydomain.com>

Auto manuals search

<http://auto.somanuals.com>

TV manuals search

<http://tv.somanuals.com>