

WorkCentre Pro[®] 65/75/90 CopyCentre[™] C65/C75/C90

User Guide

May 2003

604S13900

Xerox Model _____

Serial Number _____

The Document Company Xerox ,
Bessemer Road,
Welwyn Garden City,
Hertfordshire AL7 1HE
England

©2003 by Xerox Corporation. All rights reserved.

Copyright protection claimed includes all forms and matters of copyrighted material and information now allowed by statutory or judicial law or hereinafter granted, including without limitation material generated from the software programmes that are displayed on the screen such as icons, screen display looks, etc.

XEROX®, The Document Company® and the stylised X and identifying product names and numbers are registered trademarks of XEROX CORPORATION or Xerox (Europe) limited.

The Document Centre ST model includes an implementation of LZW licensed under U.S. Patent 4,558,302.

Product names used in this guide may be trademarks or registered trademarks of their respective companies and are hereby acknowledged.

This document contains images of screens that were created using Zinc Application Framework software version 3.5 © January 1997 Zinc Software Inc.



As an ENERGY STAR® partner, Xerox Corporation has determined that this product meets the ENERGY STAR® guidelines for energy efficiency.



RAL, the German Institute for Quality Assurance and Labeling, has awarded the Document Centre 255 and 265 DC the Blue Angel Environmental Label, distinguishing it as a machine which satisfies Blue Angel criteria for environmental acceptability in terms of machine design, manufacture, and operation.

Whilst the information in this Guide is correct at the time of first publication, Xerox reserves the right at any time to change the information without notice. Changes are made periodically to this document. Changes and technical updates will be added in subsequent editions.

The Document Centre ST model includes software provided by the Internet Software Consortium.

Copyright (c) 1995, 1996, 1997, 1998, 1999, 2000, 2001, 2002, 2003

The Internet Software Consortium - DHCP. All rights reserved.

Redistribution and use in source and binary forms, with or without modification, are permitted provided that the following conditions are met:

Redistributions of source code must retain the above copyright notice, this list of conditions and the following disclaimer.

Redistributions in binary form must reproduce the above copyright notice, this list of conditions and the following disclaimer in the documentation and/or other materials provided with the distribution.

Neither the name of The Internet Software Consortium - DHCP nor the names of its contributors may be used to endorse or promote products derived from this software without specific prior written permission.

This Software Is Provided By The Internet Software Consortium And Contributors "As Is" And Any Express Or Implied Warranties, Including, But Not Limited To, The Implied Warranties Of Merchantability And Fitness For A Particular Purpose Are Disclaimed. In No Event Shall The Internet Software Consortium Or Contributors Be Liable For Any Direct, Indirect, Incidental, Special, Exemplary, Or Consequential Damages (Including, But Not Limited To, Procurement Of Substitute Goods Or Services; Loss Of Use, Data, Or Profits; Or Business Interruption) However Caused And On Any Theory Of Liability, Whether In Contract, Strict Liability, Or Tort (Including Negligence Or Otherwise) Arising In Any Way Out Of The Use Of This Software, Even If Advised Of The Possibility Of Such Damage.



Approvals and Certifications

The CE marking applied to this product symbolises XEROX Limited Declaration of Conformity with the following applicable Directives of the European Union as of the dates indicated:

January 1, 1995:

Council Directive 73/23/EEC amended by Council Directive 93/68/EEC, approximation of the laws of the member states related to low voltage equipment.

January 1, 1996:

Council Directive 89/336/EEC, approximation of the laws of the member states related to electromagnetic compatibility.

March 9, 1999:

Council Directive 99/5/EC, on radio equipment and telecommunications terminal equipment and the mutual recognition of their conformity.

A full declaration, defining the relevant directives and referenced standards can be obtained from your XEROX Limited representative or by contacting:

Environment Health & Safety,
The Document Company Xerox,
Bessemer Road,
Welwyn Garden City,
Hertfordshire AL7 1HE
ENGLAND.

WARNING

This product is certified manufactured and tested in compliance with strict safety and radio frequency interference regulations. Any unauthorised alteration which, includes the addition of new functions or the connection of external devices, may impact this certification. Please contact your local XEROX Limited representative for a list of approved accessories.

WARNING

In order to allow this equipment to operate in proximity to Industrial, Scientific and Medical (ISM) equipment, the external radiation from the ISM equipment may have to be limited or special mitigation measures taken.

WARNING

Shielded cables must be used with this equipment to maintain compliance with Council Directive 89/336/EEC.

The Electricity at Work Regulation (in England and Wales) UK ONLY

Electricity at Work Regulations:

The Electricity at Work Regulation 1989 came into force in England and Wales on the 1 April 1990. This 1989 Regulation places a duty on all employers and self-employed persons to ensure the electrical system in their premises are constructed, maintained and operated in such a manner as to prevent, so far as reasonably practical, danger. This includes ensuring all electrical equipment connected to such electrical systems are safely constructed, maintained and operated.

All Xerox equipment have been designed to exacting safety standards. They have all undergone a variety of stringent safety tests including earth bond, insulation resistance and electrical strength tests. Xerox manufacturing plants have been awarded ISO 9000 quality certification and are subject to regular audits by the British Standards Institution or equivalent national standards body.

Xerox equipment which has been properly and regularly serviced and maintained should not have to undergo additional specific safety tests pursuant to the 1989 Regulation. Customers wishing to complete safety testing should contact Xerox (see page 1) for advice prior to any test implementation.

Xerox equipment should, however, be properly and regularly serviced and maintained at all times.

QUESTION:What is the Electricity at Work Regulation?

ANSWER:The Electricity at Work Regulation 1989 came into force in England and Wales on the 1 April 1990. This 1989 Regulation places a duty on all employers and self-employed persons to ensure the electrical systems in their premises are constructed, maintained and operated in such a manner as to prevent, so far as reasonably practicable, danger. This includes ensuring all electrical products connected to such electrical systems are safely constructed, maintained and operated.

QUESTION:Does Xerox comply with the Electricity at Work Regulation?

ANSWER:The regulation places a duty on all employers and self-employed persons to ensure the electrical systems in their premises are, effectively safe.

The regulation does not impose on, amongst others, manufacturers or suppliers of such electrical systems.

However, rest assured that all Xerox equipment which Xerox and its authorised distributors supplies to customers, conform with all the relevant safety legislation and standards.

QUESTION: Is Xerox equipment safe?

ANSWER: All Xerox equipment supplied by Xerox and their authorised distributors conform to all relevant safety legislation and standards.

QUESTION: Is the Xerox equipment in my premises safe?

ANSWER: All Xerox equipment supplied by Xerox and its authorised distributors conform to all relevant safety legislation and standards. However, like all electrical equipment, they have to be regularly serviced and maintained by competent persons.

Xerox Customer Service Engineers ensure Xerox equipment is serviced and maintained to exacting Xerox safety standards. If you would like your Xerox equipment to be serviced and maintained to such high standards, please contact your local Xerox Customer Service Organisation. They will be pleased to assist you.

QUESTION: Does the Xerox equipment in my premises comply with the Electricity at Work Regulations?

ANSWER: All employers and self-employed persons must ensure that the electrical systems in their premises are safe. This will include ensuring Xerox equipment in such premises is safe.

Xerox Product Safety function has prepared a guide which contains a list of tests which may be completed by your Xerox Customer Service Organisation. THESE TESTS MUST BE CARRIED OUT ONLY BY PERSONS WHO POSSESS THE RELEVANT SKILL, KNOWLEDGE AND EXPERIENCE TO CARRY OUT SUCH TESTS.

Please contact the Xerox Customer Service Organisation for further information.

THE USE OF INAPPROPRIATE TEST PROCEDURES AND TEST EQUIPMENT MAY PROVIDE MISLEADING RESULTS AND MAY CAUSE DEATH, PERSONAL INJURY AND/OR DAMAGE TO PROPERTY.

QUESTION: I would like to carry out my own safety tests on the Xerox equipment in my premises.

ANSWER: You may, of course, request such tests as you deem necessary to satisfy yourself that your Xerox equipment is safe. Your Xerox Customer Support will be pleased to advise you on such testing.

QUESTION: I require records of all tests

ANSWER:After safety testing, your Xerox Customer Service Engineer will provide you with a certificate which details the results of all tests completed.

In the event of any defect being noted, the Xerox equipment will be switched off and disconnected from the supply until the defect has been corrected. You will be advised of such action to enable such defects to be corrected.

PLEASE NOTE: YOU MUST ENSURE THAT YOUR XEROX EQUIPMENT IS SAFE AT ALL TIMES

Please contact us if you have any queries regarding the information provided in this document.

Xerox Product Safety,
Bessemer Road,
Welwyn Garden City,
Herts AL7 1HE, England

Radio Equipment & Telecommunications Terminal Equipment Directive 99/5/EC

The Xerox WorkCentre Pro/CopyCentre RDT modem option has been self-certified by Xerox (Europe) Limited in accordance with Directive 99/5/EC and has been designed to work with the national analogue public switched telephone networks (PSTN) and compatible PBXs of the following countries:

Austria	Germany	Luxembourg
Sweden	Belgium	Greece
Netherlands	Switzerland	Denmark
Iceland	Norway	United Kingdom
France	Ireland	Portugal
Finland	Italy	Spain

In the event of problems, you should contact your local Xerox representative in the first instance.

The modem may be configured to be compatible with other country networks. Please contact your Xerox representative if the modem needs to be reconnected to another country's network. There are no user-adjustable settings in the modem.

NOTE: Although the modem can use either loop disconnect (pulse) or DTMF (tone) signalling it is recommended that it is set to use DTMF signalling. DTMF signalling provides reliable and faster call set-up.

Modification, connection to external control software or to external control apparatus not authorised by Xerox, will invalidate the product's certification.

Table of Contents

Safety Notes	1
Symbology	2
Electrical Safety	2
Emergency Power Off	4
Disconnect Device	4
Ozone Information	5
Laser Safety	6
Operational Safety	7
Safety Extra Low Voltage Approval	9
Welcome	11
Features for printing from your workstation	12
Printing from the Embedded Web Server (Internet Services)	13
Printing from the USB Port (Optional Feature)	14
Features at the machine	15
Quick Reference	18
Quick Start	27
Making Copies	28
Authentication Overview	30
Authentication Login	31

Scanning Documents (Optional Feature)	32
Faxing Documents (Optional Feature)	34
Loading paper	36
Using the Job Queue	37
Internal Auditor Login	38
Network Accounting (Optional Feature) Login	39
Security Features	40
Getting a Secure Print (Networked Models)	41
Try These Jobs	43
Making Copies	44
Stapling Copy Jobs	45
Making 2-Sided Copies	48
Improving Image Quality	49
Removing Unwanted Marks on the Edges of Copies	50
Copying Pages from Books or other Bound Documents	51
Using Reduction/Enlargement	52
Shifting an Image	53
Adding covers	54
Placing Multiple Images on a Single Page	55
Making Transparencies with Dividers	56
Making Brochures and Booklets	57
Making Folded Booklets (optional Professional Finisher)	58
Making Tri-Fold Sheets (optional Professional Finisher)	59
Mixed Size Originals Overview	60
Mixed Size Originals	61
Build Job - Overview	62
Copying Bound Documents using Build Job	63
Using Build Job and Sample Set	64
Using Tabs/Build Job	65
Creating Tab Masters	67
Network Faxing Overview (Optional Feature)	68

Faxing a Document70
Network Scanning Overview (Optional Feature)72
Scanning Options73
Internet Fax Overview (Optional Feature)75
E-mail Overview (Optional Feature)77
Sending an Internet Fax or E-mail without a template78
Document Management Fields Overview79
Creating Document Management Fields80

Index

Safety Notes

Your Xerox product and supplies have been designed and tested to meet strict safety requirements. These include safety agency examination and approval, and compliance to established environmental standards. Please read the following instructions carefully before operating the machine and refer to them as needed to ensure the continued safe operation of your machine. **The safety testing and performance of this product have been verified using Xerox materials only.**

Follow all warnings and instructions marked on or supplied with the product.

Symbology



This symbol on the machine indicates heated surface

Electrical Safety

CAUTION



Ensure that the power connection for your machine satisfies these requirements.

Model	Power Requirements
WorkCentre Pro 90 CopyCentre C90	220-240V Outlet Dedicated 20A circuit
WorkCentre Pro 65/75 CopyCentre C65/C75	220-240V Outlet 10A or 13A line. The equipment must be connected to a grounded mains outlet

1. The power receptacle for the machine must meet the requirements stated on the data plate on the rear of the machine.
2. The socket outlet shall be installed near the equipment and shall be easily accessible.
3. Use only the power cable supplied with this equipment. Plug the power cable directly into a properly grounded electrical outlet. Do not use an extension cord. If you are not sure whether or not an outlet is properly grounded, consult a qualified electrician.

4. Do not use a ground adapter plug to connect this equipment to an electrical outlet that lacks a ground connection terminal.

WARNING: Improper connection of the equipment grounding conductor can result in severe electrical shock.

5. Do not place this equipment where people might step or trip on the power cable.
6. Do not place objects on the power cable.
7. Do not override or disable electrical or mechanical interlock devices. Covers, guards, and interlock switches are provided to prevent operator access to unsafe areas.
8. Do not obstruct ventilation openings. These openings are provided to prevent overheating of the machine.

WARNING: Never push objects of any kind into slots and openings on this equipment. Contacting a voltage point or shorting out a part could result in electrical shock or fire.

Emergency Power Off

If any of the following conditions occur, turn off the system immediately and **disconnect the power cable from the electrical outlet**. Contact an authorised Xerox Service Representative to correct the problem.

- The system emits unusual odours, or makes unusual noises.
- The power cable is damaged or frayed.
- A wall panel circuit breaker, fuse, or other safety device has been tripped.
- Liquid is spilled into the system.
- The system is exposed to water.
- Any part of the system is damaged.

Disconnect Device

The power cord plug is the disconnect device for this equipment. It is attached to the back of the machine as a plug-in device. To remove all electrical power from the machine, disconnect the power cable from the electrical outlet.

Ozone Information

This product produces ozone during normal operation. The ozone produced is dependent on copy volume and is heavier than air. Install the system in a well ventilated room with the minimum cubic requirements size listed below. Providing the correct environmental parameter will ensure the concentration levels meet safe limits.

The minimum cubic requirements are listed below:

Table 1: Ozone requirements

Model	Ozone Cubic requirement
WorkCentre Pro 65/75/90 CopyCentre C65/C75/C90	30 m ³

To determine if the room has the required volume to meet the ozone requirement, the length of the room multiplied by its width and height should be equal to or greater than the cubic volume listed above.

CAUTION



Use of controls, adjustments or procedures other than those specified in this guide may result in hazardous radiation exposure.

The system complies with international safety standards and is certified as a Class 1 Laser Product.

With specific regard to lasers, the equipment complies with laser product performance standards set by governmental, national, and international agencies as a Class 1 Laser Product. It does not emit hazardous light, as the beam is totally enclosed during all phases of customer operation and maintenance.

LUOKAN 1 LASERLAITE

KLASS 1 LASER APPARAT

VAROITUS!

Laitteen Käyttäminen muulla kuin tässä käyttöohjeessa mainitulla tavalla saattaa altistaa käyttäjän turvallisuusluokan 1 ylittävälle näkymättömälle lasersäteilylle.

VARNING!

Om apparaten används på annat sätt än i denna bruksanvisning specificerats, kan användaren utsättas för osynlig laserstrålning, som överskrider gränsen för laserklass 1.

The equipment is manufactured under a BS5750 Quality system accepted by the British Standards Institution.

The system is also certified in compliance with applicable standards by various national bodies.

Do These

- **Always** connect equipment to a correctly grounded power source receptacle. If in doubt, have the outlet checked by a qualified electrician.
- **Always** follow all warnings and instructions that are marked on or are supplied with the equipment.
- **Always** exercise care when moving or relocating the equipment. Please contact your local Xerox Service Department to arrange relocation of the machine to a location outside of your building.
- **Always** locate the machine on a solid support surface (not on plush carpet) that has adequate strength to support the weight of the machine.
- **Always** locate the machine in an area that has adequate ventilation and room for servicing.
- **Always** use materials and supplies that are specifically designed for your Xerox equipment. Use of unsuitable materials may result in poor performance and possibly a hazardous situation.
- **Always** unplug this equipment from the electrical outlet before cleaning.

NOTE

Your system is equipped with an energy saving device to conserve power when the machine is not in use. The machine may be left on continuously.

- **Always** use caution when installing or modifying telephone lines

Do Not Do These

- **Never** use a ground adapter plug to connect equipment to a power outlet that lacks a ground connection terminal.
- **Never** obstruct ventilation openings. They are provided to prevent overheating.
- **Never** push objects of any kind into the ventilation openings.
- **Never** attempt any maintenance function that is not specifically described in the documentation.
- **Never** remove any covers or guards that are fastened with screws. There are no operator serviceable areas within these covers.
- **Never** position the machine near a radiator or any other heat source.
- **Never** override or “cheat” any of the electrical or mechanical interlock devices.
- **Never** operate the equipment if you notice unusual noises or odours. Disconnect the power cord from the power source receptacle and contact Xerox.
- **Never** install telephone jacks in a wet location unless specifically designated for wet locations
- **Never** touch uninsulated telephone wire or terminals unless the telephone line has been disconnected at the network interface.
- **Avoid** using a telephone (other than a cordless type) during an electrical storm. There may be a remote risk of electrical shock from lightning.

NOTE

If you need additional safety information concerning the machine or Xerox supplied materials, you may call the following number: 01707 353434

Safety Extra Low Voltage Approval

These Xerox Digital Copiers/Printers are in compliance with various governmental agencies and national safety regulations. All system data/communication ports meet the requirements for Safety Extra Low Voltage (SELV) circuits for connection to customer-owned devices and networks. Additions of customer-owned or third-party accessories that are attached to these printers/copiers must meet or exceed the requirements previously listed. All modules that require external connection must be installed per Xerox installation procedures.

Welcome

This User Guide supports the WorkCentre Pro® 65/75/90 and the CopyCentre™ C65/C75/C90 models. CopyCentre models produce copies at the machine. WorkCentre Pro models can copy and accommodate optional features such as scan, e-mail, fax.

Because of the digital design of these systems you can expect:

- more output options. The digital design allows you to create booklets, put multiple images on a single page, insert dividers into a transparency set, and combine multiple segments into a single job.
- fewer jams and damaged originals.
- high quality output.
- to enhance and customise your output to your unique specifications.
- the machine to perform more than one function at a time. You can begin to scan your copy job while the machine is printing another job.

For additional assistance at the machine press the *Help* button. If you have a WorkCentre Pro model, use the CentreWare® Help system or click on the *Help* button in the Printer Driver.

Features for printing from your workstation

If your system is connected to a network, you can use the following features. See your System Administrator to get connected.



CentreWare® Printer Drivers

The Printer Driver extends the productivity power of the system to your desktop.

Some of the types of print jobs you can do are:

- 1-sided or 2-sided
- Stapled sets if you have a Finisher
- Resolutions up to 1800x1800 dpi
- Add standard or customised watermarks
- Secure Printing (print your confidential document after you get to the printer)

CentreWare® Tools

The CentreWare® software suite also offers optional User Management Tools and Network Scanning tools.

Embedded Web Server (Internet Services)

Every system has a Home Page. This web page allows you to send print-ready files to any WorkCentre Pro® via the World Wide Web.

Printing from the Embedded Web Server (Internet Services)

Internet Services allows you to:

- print a document when your printer driver is not available
- send print jobs to your system when you are working from a remote location

Access Internet Services through your web browser. This feature supports print-ready file formats only. All files must be submitted in formats such as PDF, PCL, PostScript or TIFF.

Follow these steps to send a job:

1. Type the system's Internet Protocol (IP) address in your browser. The system's Home Page will open.
2. Select *Services*
3. Make your *Job Submission* selections such as printing, paper, and delivery.
4. Select *Browse* to choose your print-ready file.
5. Select *Submit Job*.

NOTE

If you do not know the machines' IP address, ask your Key Operator or Administrator.

Printing from the USB Port (Optional Feature)

The Universal Serial Bus (USB) Printer Port can be used for printing directly from a PC connected via a USB cable. The USB Print Kit is available upon request. See your System Administrator for more information.

Prerequisites

- the WorkCentre Pro Printer Driver installed or have the Printer Driver CD available
- the USB Port enabled

Connect your WorkCentre Pro to the PC with a standard USB peripheral cable. The PC will detect the USB device. If drivers are already installed, select the WorkCentre Pro printer driver.

If the drivers are not installed, the system will ask to install printer drivers. Use the Printer Driver CD to install WorkCentre Pro printer drivers.

Features at the machine

Using the powerful system features you can:

Scan Once and Print Many

When making copies the system only has to scan a document once regardless of the number of copies or prints needed. This reduces the risk of jams and damage to originals.

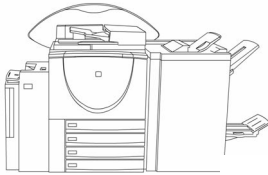

Perform Different Tasks Simultaneously

You can add a job to the job queue by scanning it, even while the system is printing another job.

Make Copies Look Like Originals

The system allows the reproduction of high quality images, especially photographs, graphics, text, or a combination. Compare your output to that from other copiers and see the difference.

Customise Image Size and Placement

You can manipulate the appearance of the image on the output stock.

- Shift the image to create margins for a binding device.
- Automatically reduce, enlarge, or centre your images.
- Print multiple reduced images on a single page.

Use Digital Features to Simplify your Work Process

Use the **Build Job** feature to divide a copy job into different segments and apply different settings to each of the segments. This allows you to:

- combine originals from the Document Glass and the Document Feeder into a single job.
- create a single job, using different programming features for each original.
- feed more than the maximum number of originals through the Document Feeder without reprogramming.

Use the **Transparency** feature to produce transparencies with transparency separators in one step.

Use the **Booklet Creation** feature to automatically sequence and reduce or enlarge the images when making booklets.

Use the **Covers** feature to automatically add covers to your documents.

Use the **Mixed Size Originals** feature to copy or scan mixed size originals simultaneously. Produce copies on uniform size paper or mixed size paper.

Be Environmentally Friendly

This product complies with a variety of international standards for environmental protection.

- This machine is compatible with most recycled paper.
- The Replaceable Units as well as the Toner cartridges are returned to Xerox where they are remanufactured and thereby kept out of landfills.



Scan Documents to Create Electronic Files

This optional feature allows you to create electronic files from your originals which can be:

- filed on a server
- routed over the network to your desktop
- distributed through an e-mail system
- automatically placed into a Document Management Application

Once your original paper document has been converted to an electronic digital document you can change, manage, share and distribute the document in electronic form, using a wide variety of software applications.



Fax Documents

The optional Network Fax connection allows you to send and receive faxes using the WorkCentre Pro® and your computer network.



E-mail Documents

This optional feature enables you to convert a hardcopy document into a Portable Document Format (PDF), single or multi-page Tagged Image File Format (TIFF) attachment and send it to an e-mail server for distribution.



Internet Fax Documents





This optional feature allows you to transmit and receive image files over the internet rather than across telephone lines.

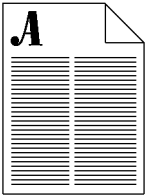

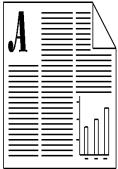
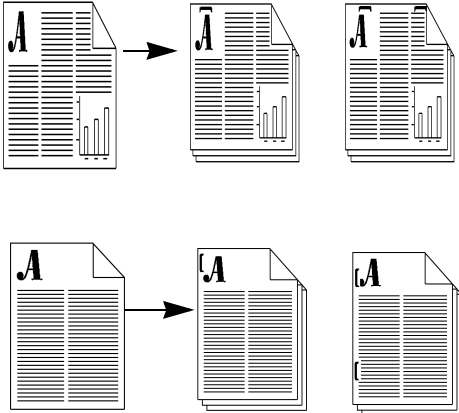

Quick Reference

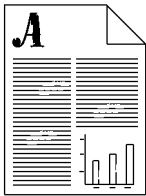
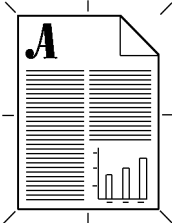
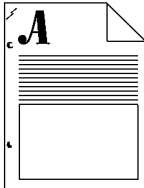
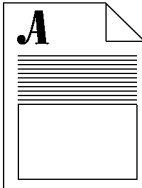
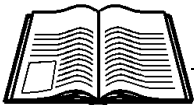
In addition to the typical everyday documents you can produce, the table below lists several applications that you may not have considered.

Most of these jobs can also be done from the Printer Driver or Internet Services if you are connected to a WorkCentre Pro®.

	Your Original	Desired Output	Refer to Page
Making Copies			Page 44
Stapling			Page 45

	Your Original	Desired Output	Refer to Page
<p>2-Sided Copies</p>			<p>Page 48</p>
<p>Improving Image Quality</p>			<p>Page 49</p>
<p>Removing Unwanted Marks</p>			<p>Page 50</p>
<p>Copying Pages From Books or Other Bound Documents</p>			<p>Page 51</p>

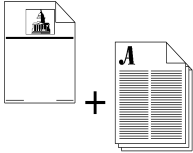
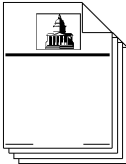
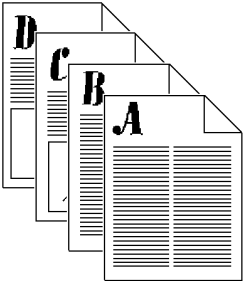
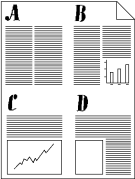
	Your Original	Desired Output	Refer to Page
Using Reduction/Enlargement			Page 52
Shifting an Image			Page 53
Adding Covers			Page 54
Placing Multiple Images on a Single Page			Page 55

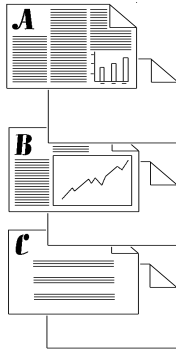
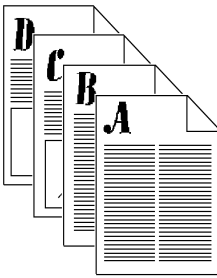
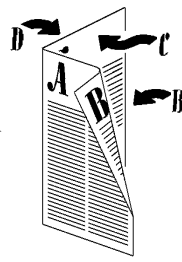
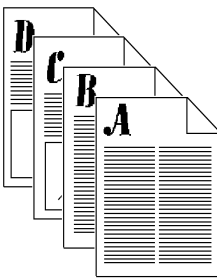
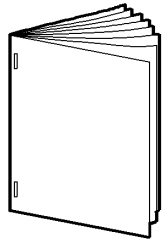
	Your Original	Desired Output	Refer to Page
<p>Making Transparencies with Dividers</p>			<p>Page 56</p>
<p>Making Brochures and Booklets</p>			<p>Page 57</p>
<p>Making Folded Booklets</p>			<p>Page 58</p>

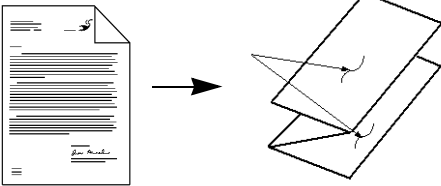
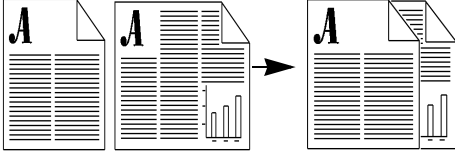
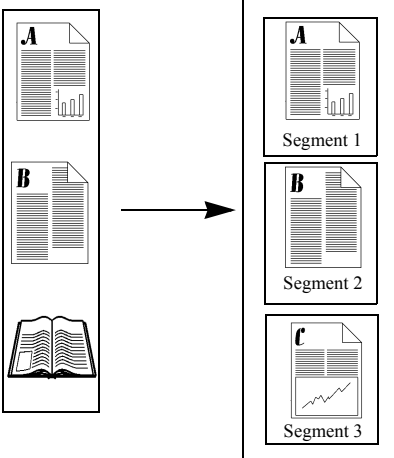
	Your Original	Desired Output	Refer to Page
<p>Making Tri-Fold Sheets</p>			<p>Page 59</p>
<p>Mixed Size Originals</p> <ul style="list-style-type: none"> • Copying • Network Scanning 			<p>Page 60 Page 61</p>
<p>Build Job - Overview</p> <p>Unique Programming for Each Segment</p>			<p>Page 62</p>

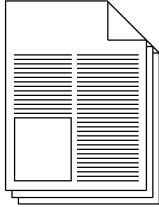
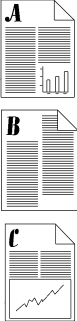
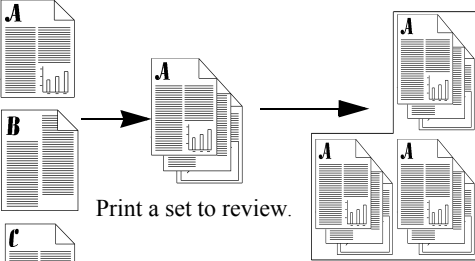
	Your Original	Desired Output	Refer to Page
<p>Copying Bound Documents Using Build Job</p>			<p>Page 63</p>
<p>Using Build Job and Sample Set</p>		 <p>Print a set to review.</p> <p>Print the rest.</p>	<p>Page 64</p>

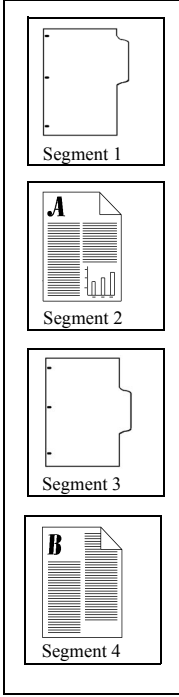
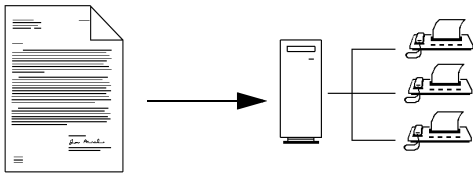

	Your Original	Desired Output	Refer to Page
<p>Using Tabs/Build Job</p>			<p>Page 65 Page 67</p>
<p>Network Faxing</p> <ul style="list-style-type: none"> ● to a Single Number ● to Multiple Numbers 			<p>Page 70</p>

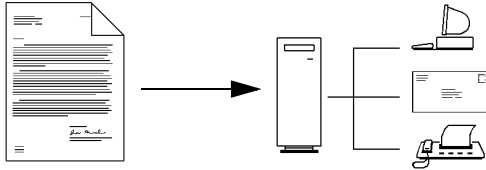
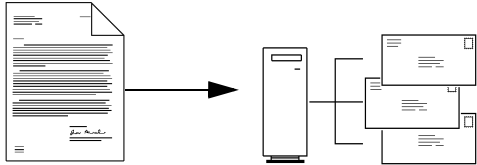
	Your Original	Desired Output	Refer to Page
<p>Network Scanning</p> <ul style="list-style-type: none"> ● to File ● to Desktop ● to E-Mail ● to Fax 		Page 73	
<p>Sending an Internet Fax or E-mail</p>		Page 78	



Quick Start

Scan your originals once using the **Document Feeder** or use the **Document Glass** underneath the cover to scan originals that will not feed through the Document Feeder.

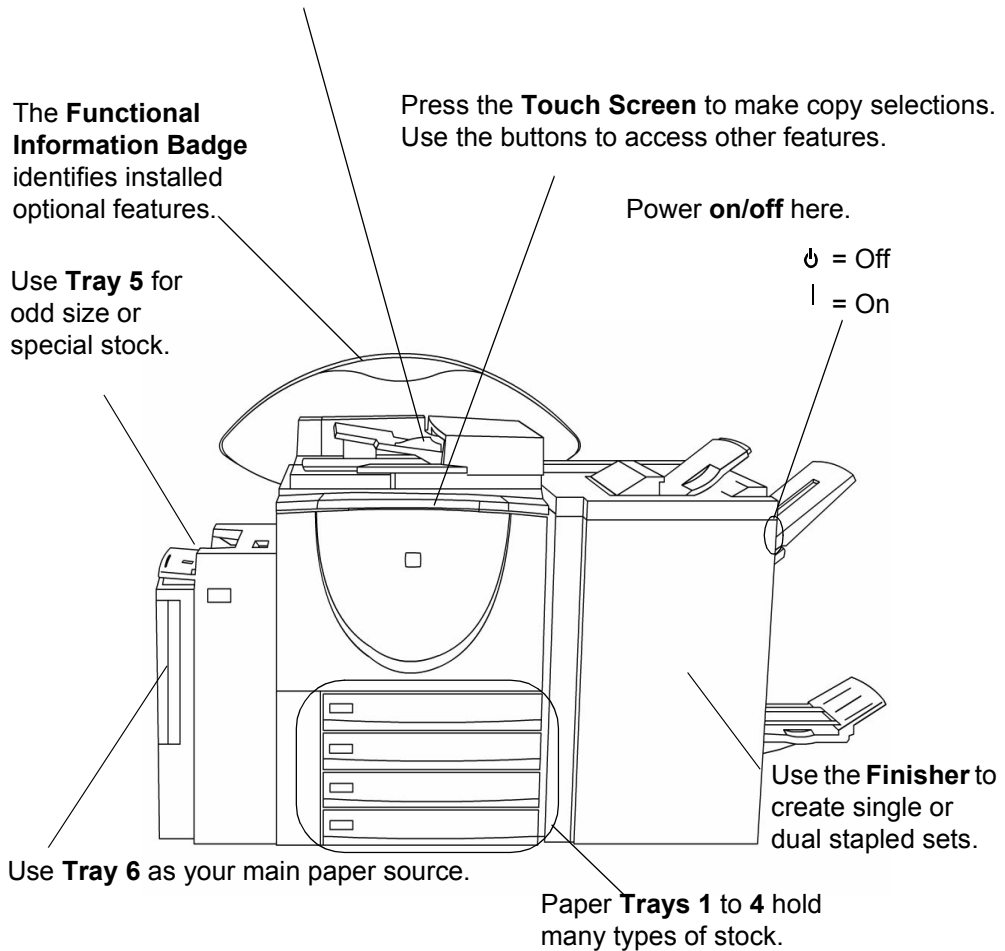

Quick Start

Document Feeder

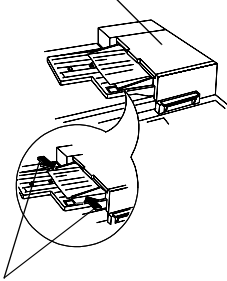

Edge Guides

Document Glass

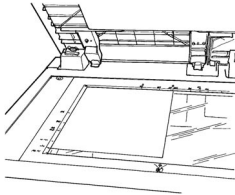

1. Load your Originals

- *If using the Document Feeder...*

Place the originals into the *Document Feeder* face up, with page one on top. The originals should be in good condition, and without staples or paper clips.

Adjust the edge guides against the original. Otherwise, the copies may print incorrectly or the originals may jam.

For fastest performance, place the originals Long Edge Feed with the top of the document away from you.

- *If using the Document Glass...*

Use the *Document Glass* to copy bound, stapled, folded or wrinkled originals, odd or oversize documents, books, or glossy photographs.

Raise the Document Glass Cover.

Place the original face down into the top left corner of the glass. Ensure that the top left corner of the original fits into the corner of the registration edge.

When using the copy features; *Auto Paper*, *Auto%*, *Auto Centre*, or *Bound Originals*, the cover must be raised.

Press Clear All

If necessary, press the *Clear All (AC)* button to reset the selections that were made for the previous job.

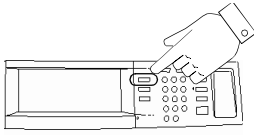

Press the Features button to display Copy, Fax, or Scan Screens

2. Make your selections on the Touch Screen

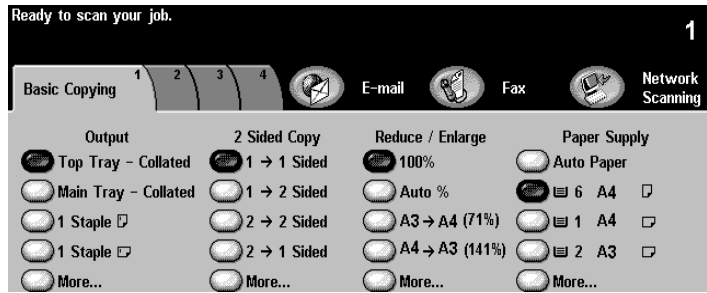

Touch the screen to make your copy selections.

Use the keypad to enter the number of sets.

3. Press Start

After *Start* (◊) has been pressed, the *Job Progress* screen will appear. This screen displays information about your job. After your job is complete, or you press the *Programme Next Job* button, it will close.

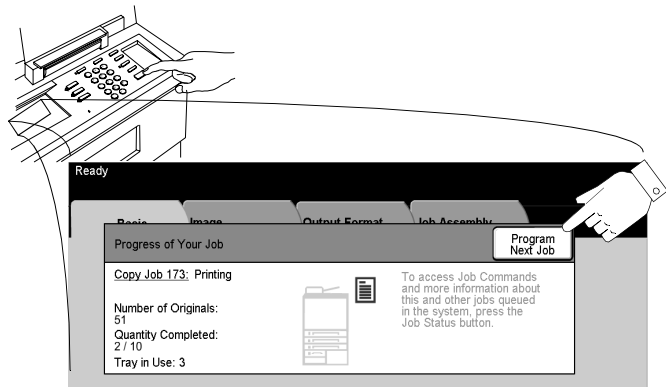

Quick Start

Authentication Overview

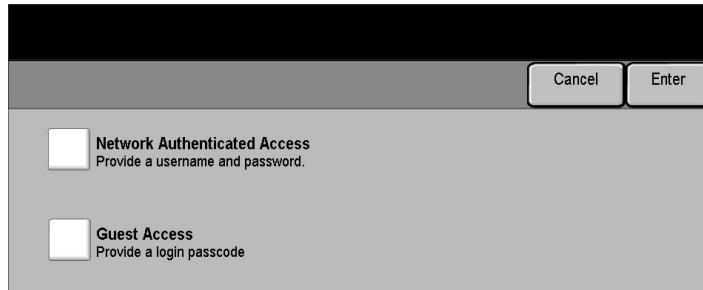

The screenshot shows a dialog box with a dark header bar. Below the header bar, there are two buttons: "Cancel" and "Enter". The main area of the dialog box contains two radio button options. The first option is "Network Authenticated Access" with the subtext "Provide a username and password." The second option is "Guest Access" with the subtext "Provide a login passcode".

Authentication is the verification of user identity and authorization. The Administrator can limit access to system services such as E-mail, Network Scanning, and Network Fax by enabling Authentication.

If Authentication is enabled, you will be presented with a Login Required screen. **Network Authenticated Access** requires a Login Name and Password. See the Administrator to login using the **Guest Access** passcode.

Authentication Login

Using the touch screen:

1. Select Network Authenticated or Guest Access level.
2. Depending on the access level selected, enter the Guest Passcode or your network Login Name and Password
3. Press the Enter button.

The system will validate the login information. If the account information is authenticated the restriction will be released.

Remember to logout to prevent unauthorised access.

NOTE

The system will allow 5 login attempts. If login fails after the last attempt, you will be notified on the local user interface and all users will be locked out of all services offering authentication for a period of 5 minutes.

Scanning Documents (Optional Feature)

Document Feeder

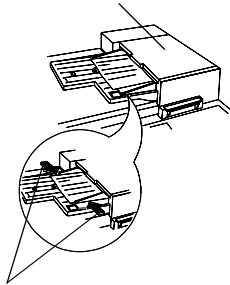

Edge Guides

Document Glass

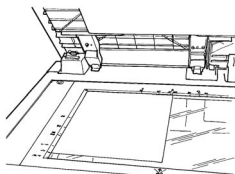

1. Load your Originals

- *If using the Document Feeder...*

Place the originals into the *Document Feeder* face up, with page one on top. The originals should be in good condition, and without staples or paper clips.

Adjust the edge guides against the original. Otherwise, the copies may print incorrectly or the originals may jam.

For fastest performance, place the originals Long Edge Feed with the top of the document away from you.

- *If using the Document Glass...*

Raise the Document Glass Cover.

Place the original face down into the top left corner of the glass. Ensure that the top left corner of the original fits into the corner of the registration edge.

Press Clear All

If necessary, press the *Clear All (AC)* button to reset the selections that were made for the previous job.

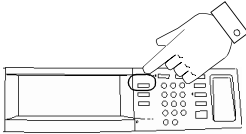

Press the Features button to display Copy, Fax, or Scan

2. Make your selections on the Touch Screen

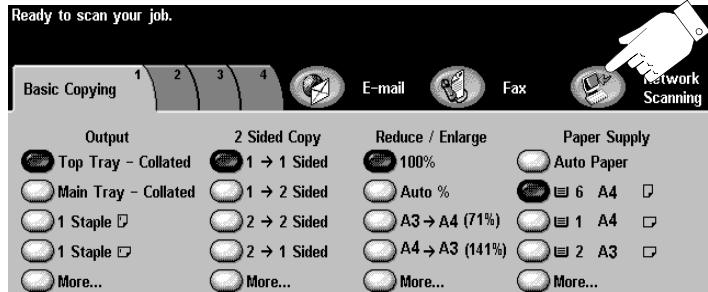

Touch the *Network Scanning* button. If Authentication is active, you must complete a login sequence. Remember to log out to prevent unauthorised access.

Select a template from the Template Destinations list.

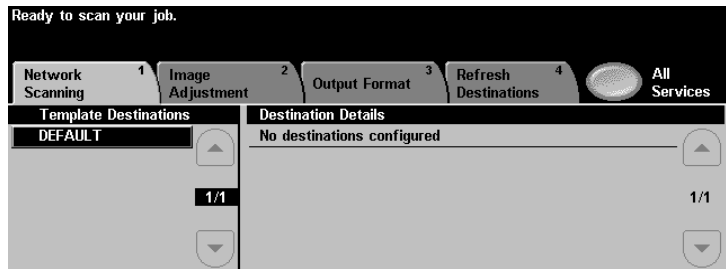

Templates tell the system how to create the scan file and where to send it after it is processed.

For information about templates, refer to page 72.

3. Press Start

After *Start* (◊) has been pressed, the Job Progress screen will appear and display information about your job. After your job is complete, or you press the *Programme Next Job* button, it will close.

Faxing Documents (Optional Feature)

Document Feeder

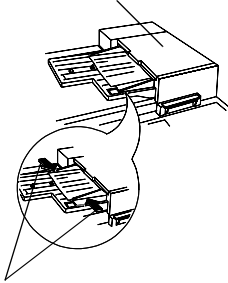

Edge Guides

Document Glass

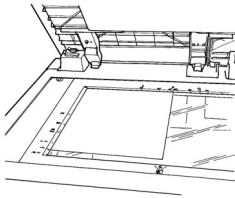

1. Load your Originals

- *If using the Document Feeder...*

Place either 1 or 2 sided originals into the *Document Feeder* face up, with page one on top. The originals should be in good condition, and without staples or paper clips.

Adjust the edge guides against the original. Otherwise, the copies may print incorrectly or the originals may jam.

For fastest performance, place the originals Long Edge Feed with the top of the document away from you.

- *If using the Document Glass...*

Raise the Document Glass Cover.

Place the original face down into the top left corner of the glass. Ensure that the top left corner of the original fits into the corner of the registration edge.

Press Clear All

If necessary, press the *Clear All (AC)* button to reset the selections that were made for the previous job.

NOTE

The system has an Image Rotation feature that enables you to feed originals Long Edge Feed (LEF) even if the destination Fax can only print Short Edge Feed (SEF).

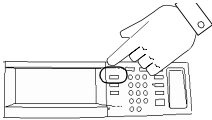

Press the Features button to display Copy, Fax, or Scan

2. Make your selections on the Touch Screen

Touch the *Fax* button. Touch the screen to make your selections. If Authentication is active, you must complete a login sequence. Remember to log out to prevent unauthorised access.

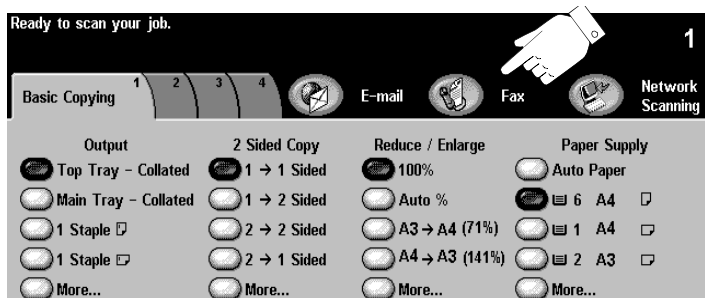

Enter the fax number using the numeric keypad. For multiple numbers Touch the *Add To Send List* button and enter another number. For more information, refer to page 68.

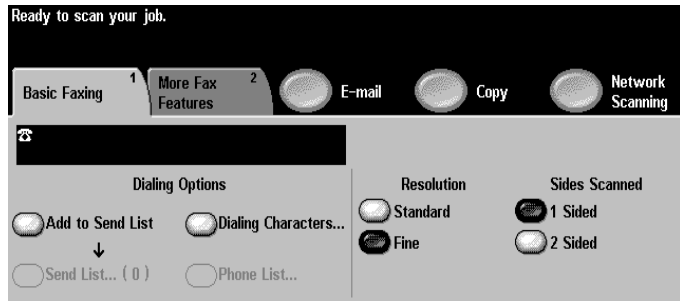

If you have 2 sided originals, select 2 Sided.

3. Press Start

After *Start* (◊) has been pressed, the Job Progress screen will appear. This screen displays information about your job. After your job is complete, or you press the *Programme Next Job* button, it will close.

Loading paper

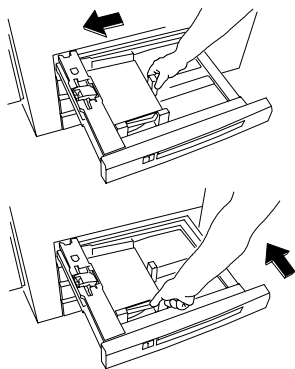

Loading Paper in Trays 1 - 4

1. Pull out the paper tray.
2. Load the paper neatly in the tray. Do not load paper above the maximum fill line mark on the edge guide.
3. Ensure that the edge guides are against the top, bottom, and side edges of the paper.
4. Push in the paper tray.

A pop-up screen may appear on the screen asking you to confirm the paper stock settings or to load the required paper for the tray. Confirm or change the paper and size descriptions as required.

Insert the paper
for Tray 5

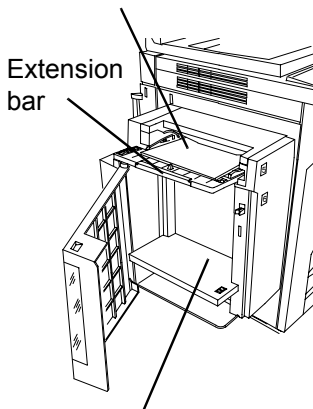

Loading paper in Tray 5, the Bypass Tray

Use Tray 5 to load special or odd-size stock. Insert paper as shown. Do not load paper above the maximum fill line. Pull out the extension bar to accommodate paper that is longer than the tray. Confirm or change the paper and size descriptions as required.

Loading Paper in Tray 6, the High Capacity Feeder

To load paper, open the cover and wait for the tray to lower. When the paper has been loaded, close the cover to raise the tray. Tray 6 can only handle 8.5 x 11 inch or A4 size paper.

Insert paper for Tray 6.

NOTE

Use the labels for instruction on how to orient special stock such as transparencies, labels, or hole-punched stock.

Using the Job Queue

Printing

Select a job to get details or perform operations

All Incomplete Jobs Other Queues

#	Job Name	Owner	Status
1	Microsoft Word	Vanessa Machado	Printing
2	Microsoft PowerPoint	Judy Mitchell	Held
3	Microsoft Word	Judy Mitchell	Waiting for printer
4	Microsoft PowerPoint	Philip Mitchell	Waiting for printer
5	Copy Job 843	Local User	Scheduling
6	Microsoft Word	Philip Mitchell	Held

Press the Job Status button to view the Job Queue

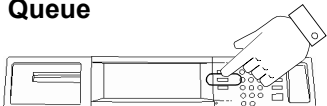

The system provides a queuing feature that sequences the printing of jobs. To view the Job Queue, press the *Job Status* button.

Touch a job in the queue for additional options.

- Press *Delete* to remove a job from the queue. Anyone can delete any job in the Job Queue.
- Press *Promote* to move near the top of the job queue.
- Press *Release* to start to print a held job. This feature is used to print the sets that are automatically held after using the *Sample Set* or *Secure Print* feature.
- Press the *Job Details* button to view detailed information about a job.
- Press *Hold* to hold a job in the queue and print later.
- Press *Required Resources* for information about the resources that are needed for the job.

Touch a job in the queue for additional options.

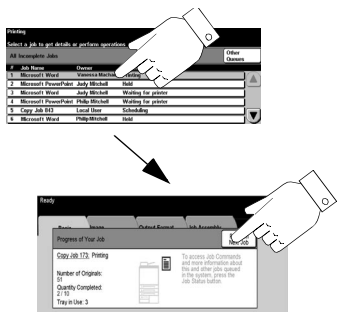

Internal Auditron Login

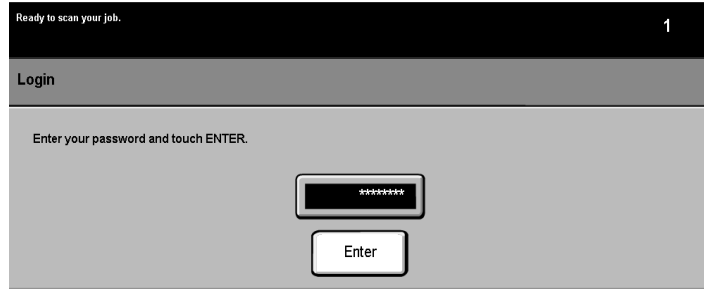

The system is equipped with a standard feature known as the Internal Auditron. This feature controls access to the machine and tracks copy usage.

If the tracking feature is active you will see a screen similar to the one above.

An administrator will assign you a User Number. Use this number in the following procedure to login.

1. At the login screen enter your assigned User Number using the keypad. Press *Enter*.
2. Press *Login to a General Account* or *User Pathways*.

If *User Pathways* is selected, copies will be charged to your User Account.

If *Login to General Accounts* is selected enter the General Account number. Copies will be charged against the General Account number you enter.

3. Make copies as needed.

Remember:

Log out to prevent unauthorised access

Press the *Access* Button on the User Interface then press the *Logout* button on the Touch Screen.

Network Accounting (Optional Feature) Login

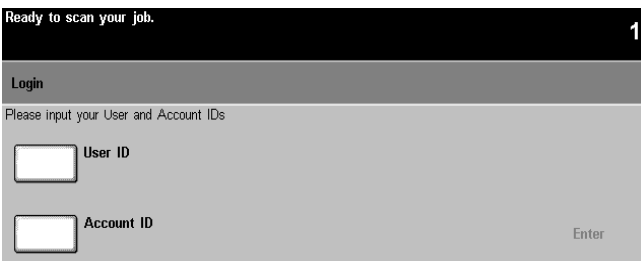

If you see this screen, your site is using a network tracking feature that provides the ability to track copy, print, fax and scan usage.

An administrator will assign you a User and Account ID. Use them to login to the system to access any of the system functions.

Use the following procedure to login:

From the Machine

1. Press the *User ID* button and enter your User ID using the keypad that appears on the *Touch Screen*. Press the *Save* button.
2. Press the *Account ID* button and enter your Account ID using the keypad that appears on the *Touch Screen*. Press the *Save* button. Press the *Enter* button.
3. Start your job.

From the Workstation

When printing to the machine with Network Accounting enabled a screen will appear after you select *Print* from the File menu.

1. Enter your User and Account ID then click *OK*.
2. Enter your Account ID and click *OK*.

Remember:

Log out to prevent unauthorised access

Press either the *Clear All* button or the *Access Button* on the User Interface.

Press the *Logout* button on the Touch Screen.

Security Features

Xerox provides Secure Print and optional Image Overwrite to protect your classified or private information. See your System Administrator for more information about security.

1. Secure Print is a standard network feature. Jobs are held in the print queue until you enter your personal 4-10 digit Secure Print ID.
2. Image Overwrite is available upon request as an optional feature. When available, the overwrite components are enabled by the Machine Administrator.
 - Immediate Image Overwrite ensures that all information related to a job is immediately overwritten after the successful completion of each job. You can view job overwrite status at the machine using the Job Status pathway button located on the User Interface. The system will display a fault message and instructions if the overwrite was unsuccessful.
 - On Demand Image Overwrite irretrievably overwrites all of the physical areas of the disks that hold data. All jobs in the active queue will be deleted and overwritten. Jobs sent during the overwrite process are held and released after the overwrite process has finished.

Getting a Secure Print (Networked Models)

Follow these steps to get a secure print.

At the Workstation

1. In the Windows printer driver, click *Properties* to get to a WorkCentre Pro® Printer Driver.
2. Once in the Printer Driver select the *Paper/Output* tab and click the *Job Type* pull down menu.
3. Select *Secure Print*.
4. Select *Secure Print Setup*, enter a 4-10 Digit Secure Print ID then click *OK*.
5. When you are ready to retrieve your secure print job go to the machine.

At the Machine

1. Press the *Job Status* button to display the job queue. Touch your held job on the touch screen. It should be easily identified by the file name.
2. This will display a screen with additional options.
3. Press *Release Job*. You will be prompted for the Secure Print ID you assigned the job at your workstation.
4. As soon as the correct Print ID is entered, your job will print.

Try These Jobs

This section contains step-by-step instructions to help you get the most from your system.

Most of what you need is in the **Basic Copying** tab.

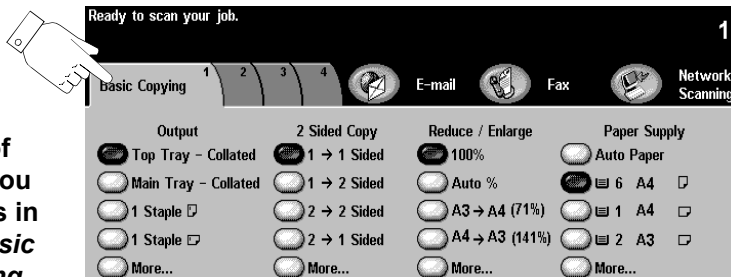

Touch the screen to make selections

Making Copies

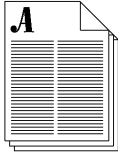
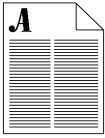

Typical Application

Standard copying tasks.

Procedure

1. Load your originals. Adjust the edge guides as necessary.

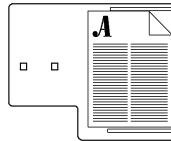

LEF →

Use Long Edge Feed (LEF) for the fastest performance.

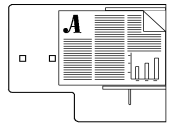

SEF →

Short Edge Feed (SEF) originals require more time to scan.

2. Make your programming selections by touching the screen. The most common selections are on the *Basic Copying* tab (Output, 2-sided Copy, Reduction/Enlargement, and Paper Supply).
3. Use the keypad to enter the number of copy sets.
4. Press the *Start* (◊) button.

HINT

Auto% automatically Reduces or Enlarges your copy based on the paper size in the paper tray you select.

Auto Paper automatically picks the tray holding the paper size based on the size of your original.

Stapling Copy Jobs

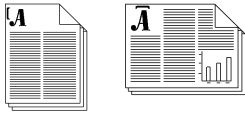

Typical Application

Standard copying tasks with 1 or 2 staples.

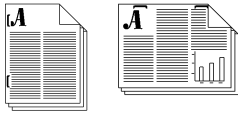







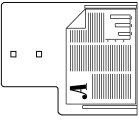

Procedure

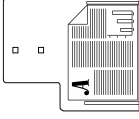
1. Load your originals and make your paper and programming selections based on the table below. Press the **More...** button to access 2 staples.
2. Use keypad to enter the number of copy sets.
3. Press the *Start* (◊) button.

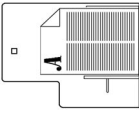
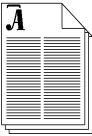
Feed Direction of Common Paper Sizes	Desired Staple Location	Paper Supply	Output Options Select this Staple Button
<p>A4</p>		Auto Paper Supply or select the appropriate size LEF paper.	
<p>A4 A3</p>		Auto Paper Supply or select the appropriate size SEF paper	

Try These Jobs

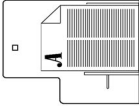
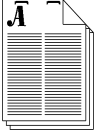
Feed Direction of Common Paper Sizes	Desired Staple Location	Paper Supply	Output Options Select this Staple Button
 <p>A4</p>		<p>Auto Paper Supply or select the appropriate size SEF paper</p>	
 <p>A4</p>		<p>Auto Paper Supply or select the appropriate size LEF paper.</p>	
 <p>A4</p>		<p>To achieve optimum staple location with this feed direction you must select 8.5 inch, SEF Paper Supply.</p>	

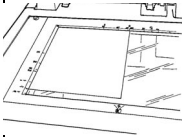
Feed Direction of Common Paper Sizes	Desired Staple Location	Paper Supply	Output Options Select this Staple Button
 <p>A4 A3</p>		<p>Auto Paper Supply or select the appropriate size SEF paper.</p>	
	<p>Build Job is required when stapling copies made from the document glass. See page 62 for more information about Build Job.</p>	<p>Auto Paper Supply or select the appropriate size LEF or SEF paper.</p>	







Making 2-Sided Copies

Typical Application

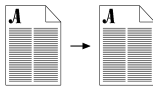
Standard office copying tasks with or without staples.

Procedure

1. Load your originals.
2. Make your programming selections by touching the screen. The most common selections are on the *Basic Copying* tab (Output, 2-sided Copy, Reduction/Enlargement, and Paper Supply).
3. Select which 2-sided option you want. These options are displayed when the *2-sided Copy, More...* selection is pressed.

Option	Originals → Copies	Option	Originals → Copies
1 → 1		2 → 1	
1 → 2		1 → 2 Rotate Side 2	
2 → 2		2 → 2 Rotate Side 2	

4. Use the keypad to enter the number of copy sets.
5. Press the *Start* (◊) button.



Typical Application

Create copies with the best possible image quality.

Procedure

1. Load your originals.
2. Make your desired programming selections from the *Basic Copying* tab.
3. Use the keypad to enter the number of copy sets.
4. Depending on the configuration of your machine press either the *More Copy Features* tab or the *Image Adjustment* tab. Press the *Image Quality* button.
5. Select the setting that best matches your original then press the *Save* button.

<i>Normal</i>	This default setting provides excellent copies for most types of originals.
<i>Halftone Photo</i>	Use for high quality lithographic images such as magazines.
<i>Text</i>	Use for originals that are primarily text and lines.
<i>Photo</i>	Use for photographs without text or graphics.

Lighten/Darken provides controls to adjust the lightness or darkness of the output.

Background Suppression automatically reduces or eliminates the background from coloured originals.

6. Press the *Start* (\blacklozenge) button.

Removing Unwanted Marks on the Edges of Copies

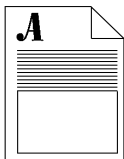
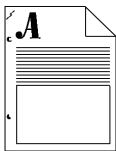

Typical Application

Remove distracting marks on your copies.

Procedure

1. Load your originals.
2. Make your programming selections by touching the screen. The most common selections are on the *Basic Copying* tab (Output, 2-sided Copy, Reduction/Enlargement, and Paper Supply).
3. Use the keypad to enter the number of copy sets.
4. Depending on the configuration of your machine press either the *More Copy Features* tab or the *Image Adjustment* tab.
5. Press the *Edge Erase* button.
6. Select either *Edge Erase* or *Border Erase*.
Use *Edge Erase* to erase any of the margins on the copies independently.
Use *Border Erase* to create a uniform border around your copies.
7. Press the *Save* button.
8. Press the *Start* (◊) button.

HINT

To erase drill hole marks on your copies, set the edge deletion to 15 mm.

Copying Pages from Books or other Bound Documents

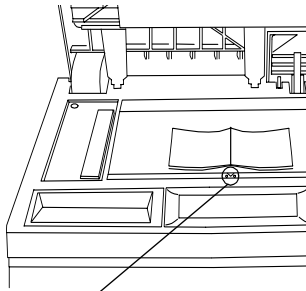

Book Binding Guide
mark

Typical Application

Copy a page from a book or other bound original.

Procedure

1. Open the Document Cover and place the bound original on the Document Glass. Align the spine of the bound document with the Book Binding mark.
2. Touch the screen to make your selections from the *Basic Copying* tab (Output, 2-sided Copy, Reduction/Enlargement, and Paper Supply).
3. Use the keypad to enter the number of copy sets.
4. Depending on the configuration of your machine press either the *More Copy Features* tab or the *Image Adjustment* tab.
5. If necessary, change the image quality setting by pressing the *Image Quality* button. Make the required image adjustments then press the *Save* button.
6. Press the *Bound Originals* button then press the button that identifies which pages you want to copy. (either left, right, or both pages). Press the *Save* button.
7. Press the *Start* (◊) button and your copies will print.
8. Repeat step 6 until all pages are copied.

TIP

If your original has information within 4mm from the bottom, place the original anywhere on the glass at least 4mm away from the front edge.

Using Reduction/Enlargement



Typical Application

Use the automatic Reduction/Enlargement features to adjust the size of the output image.

Procedure

1. Load your originals.
2. Make your programming selections by touching the screen. The most common selections are on the *Basic Copying* tab (Output, 2-sided Copy, Reduction/Enlargement, and Paper Supply).
3. Use the keypad to enter the number of copy sets.
4. In the *Basic Copying* tab under *Reduce/Enlarge*, select an existing preset or press the *More...* button. Select from the additional presets or enter your desired Reduction/Enlargement percentage and press the *Save* button.
5. Press the *Start* (◊) button.

HINT

Custom Auto% will fill the copy page by stretching the image to the edges of the copy page.

Normal Auto% will proportionally enlarge the image until it fills the copy page.

TIP

When using the Document Glass, you can enlarge an image up to 400%. Using the Document Feeder you can enlarge up to 300%.

Shifting an Image

Typical Application

Shift the image on a copy to create a binding edge.

Procedure

1. Determine the amount of space needed to shift the content away from the binding edge.
2. Load your originals.
3. Make your programming selections by touching the screen. The most common selections are on the *Basic Copying* tab (Output, 2-sided Copy, Reduction/Enlargement, and Paper Supply).
4. Use the keypad to enter the number of copy sets.
5. Depending on the configuration of your machine press either the *More Copy Features* tab or the *Image Adjustment* tab.
6. Press the *Image Shift* button, then press the *Margin Shift* button.
7. Enter the amount of margin shift determined in Step 1 and press the *Save* button.
8. Press the *Start* (◊) button.

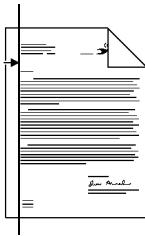
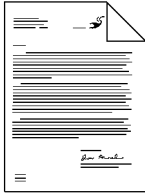

TIP

This feature allows you to shift the image up and down on the page as well as left or right.

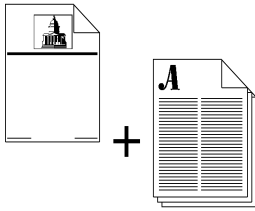

Typical Application

Add covers to any set of documents.

Procedure

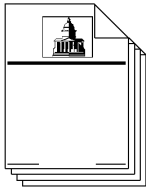

1. Load the cover stock into the Bypass Tray or any appropriate paper tray.
2. Load your originals into the Document Feeder.
3. Make your programming selections by touching the screen. The most common selections are on the *Basic Copying* tab (Output, 2-sided Copy, Reduction/Enlargement, and Paper Supply).
4. Use the keypad to enter the number of copy sets.
5. Depending on the configuration of your machine press the *More Copy Features* tab or the *Image Adjustment* tab.
6. Press the *Image Quality* button then select the appropriate *Original Type*.
7. Press the *Output Format* tab and select *Covers*. Select where you want the cover positioned - Front, Back, or Front and Back then press the *Save* button.
8. Press *Output Cover Images* to select the sides imaged for the cover and press the *Save* button.
9. Press the *Cover Stock* button to select the tray where the cover stock is loaded.
10. Press the *Start* (◀▶) button.

Placing Multiple Images on a Single Page

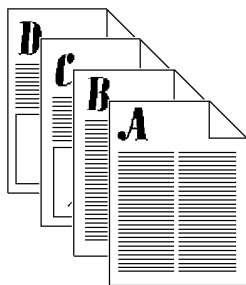

Typical Application

Any situation where you want to present multiple reduced images (thumbnail images) to a reader.

Procedure

1. Load your Originals.
2. Depending on the configuration of your machine press either the *More Copy Features* tab or the *Output Format* tab. If the *More Copy Features* tab is selected press *Output Format* tab.
3. Press the *Multi-Up* button then press *On*.
4. Select the correct orientation of your originals based on the information displayed on the screen.
5. Select the number of rows and columns. Press the *Save* button.
6. Ensure the originals are loaded into the Document Feeder as illustrated on the Multi-Up screen.
7. Make your programming selections by touching the screen. The most common selections are on the *Basic Copying* tab (Output, 2-sided Copy, Reduction/Enlargement, and Paper Supply).
8. Use the keypad to enter the number of copy sets.
9. Press the *Start* (◊) button.

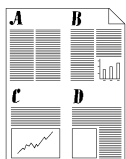

HINT

Sixteen A4 images can be displayed on A4 paper (4 rows x 4 columns).

Making Transparencies with Dividers

Originals

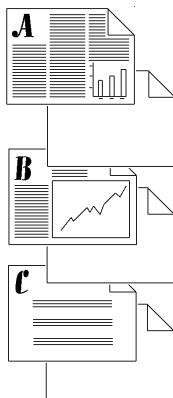
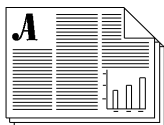

Transparencies with Dividers

Typical Application

Produce transparency sets with divider inserts.

Procedure

1. Ensure that transparencies and divider separator stock are loaded into different paper trays.
2. Load the originals into the Document Feeder.
3. Depending on the configuration of your machine press either the *More Copy Features* tab or the *Output Format* tab. If *More Copy Features* tab is selected press tab 3, *Output Format*.
4. Press the *Transparencies* button.
5. On the Transparency Dividers screen, select either *Blank* or *Imaged Dividers*. Selecting *Imaged Dividers* will produce dividers with the same image as on the transparency.

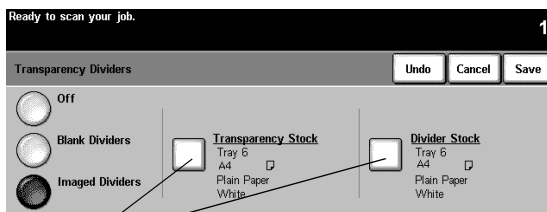

Ensure both tray selections are correct.
Press a button to change the selection.

6. Press the *Transparency Stock* button to change the current tray selection. Press the *Divider Stock* button to change the current divider stock selection.
7. Press the *Start* (◊) button.

Making Brochures and Booklets

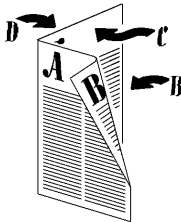
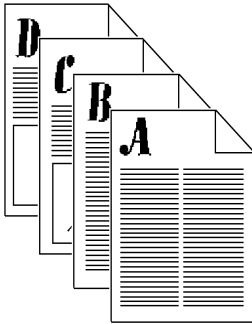

Typical Application

Produce a newsletter.

Procedure

1. Load the originals into the Document Feeder. The originals *must* be oriented Long Edge Feed.
2. Depending on the configuration of your machine press either the *More Copy Features* tab or the *Output Format* tab. If the *More Copy Features* tab is selected press *Output Format* tab.
3. Press the *Booklet Creation* button. Follow the instructions on the screen.
4. Press the Booklet Creation *On* button then press the *Save* button.
5. Press *One- or Two-sided Originals* then press the *Save* button.
6. Make any other necessary selections from the *Basic Copying* tab. Some selections will have already been made when you selected the *Booklet Creation* feature.
7. Select a paper tray. The paper stock *must* be Short Edge Feed.
8. Press the *Start* () button.

HINT

Ensure you do not accidentally select Tray 6, as it will not have the short edge paper needed to complete the job.

Making Folded Booklets (optional Professional Finisher)

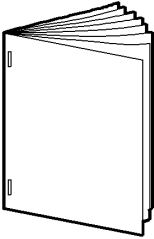

Typical Application

Produce a folded single or multiple sheet booklet with and without staples.

Procedure

1. Place the originals image-up in the Document Feeder. The originals must be oriented Long Edge Feed.
2. Select a Paper Supply with Short Edge Feed stock.
3. Select Output Format > Booklet Creation.
4. Select On >1 or 2 Sided Originals > Save.
5. Select Basic Copying > Select More... in the Output column.
6. Select Booklet Maker > Folded and Stapled > Save.
7. Enter the copy quantity on the keypad.
8. Press the Start button.

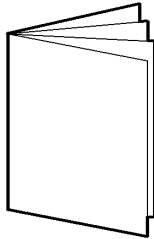

The table illustrates the booklet sheet count based on the number of originals scanned.

Number of Originals Scanned	=	Number of Sheets in the Booklet
4 - 20	=	1 - 5
24 - 40	=	6 - 10
44 - 60	=	11 - 15

Making Tri-Fold Sheets (optional Professional Finisher)

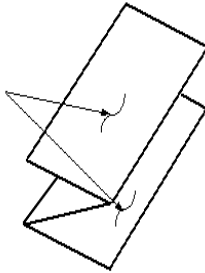

Z-Configuration

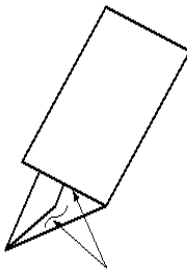

C-Configuration

Typical Application

Produce a single sheet letter fold to fit inside a mailing envelope.

Procedure

1. Place the originals image-up in the Document Feeder. The originals must be oriented Short Edge Feed.
2. Select the Basic Copying tab.
3. Select a Paper Supply with Short Edge Feed stock.
4. Select More... in the Output column > Folding Options.
5. Select Tri-Fold > Z-Configuration > Save.
6. Select Save to confirm fold settings.
7. Enter the copy quantity on the keypad
8. Press the Start button.

You can also make 2 Sided Copy and Reduce/Enlarge selections as required.

Mixed Size Originals Overview

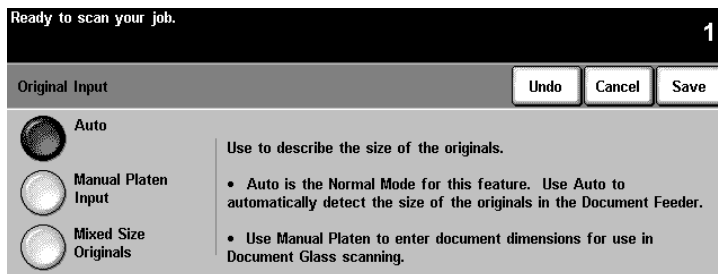

This feature allows you to input mixed size original documents of mixed sizes and process them as a single job to produce:

- mixed size or common size copies
- scan jobs using optional network features such as Network Scanning, Scan to Fax, Scan to E-mail, etc.

The originals must all have the same width and must be fed from the Document Feeder. If valid sizes are not scanned, a warning message will appear and the job will be deleted.

Document Size Value

If the system displays a paper stock error, the machine's document size values might require adjustment by the Machine Administrator.

NOTE

Mixed Size Originals cannot be selected if both Auto Paper and 1-2 Sided options are selected.

Mixed Size Originals

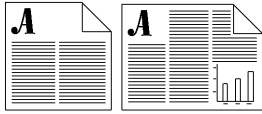

Typical Application

Produce copies or scans of mixed size originals on either the original sizes or a common size automatically.

Procedure

Copying

1. Place the originals face up in the Document Feeder. The originals *must* be the same width.
2. Select the *More Copy Features* tab or tab 2, *Image Adjustment*.
3. Select *Original Input > Mixed Size Originals > Save*.
4. Select the *Basic Copying* tab.
5. Select *Auto Paper* to produce the same size output as the original mixed sizes.

To produce common size output you must select a Paper Supply, Auto% Reduce/Enlarge, Auto Centre on the Image Adjustment tab. The system will determine the reduction%.

6. Enter the copy quantity on the keypad.
7. Press the Start button.

Network Scanning (if available)

Complete steps 1, 2, 3, 7 above.

Build Job - Overview

Build Job is a feature that allows you to divide a job into individual segments and apply unique programming to each individual segment.

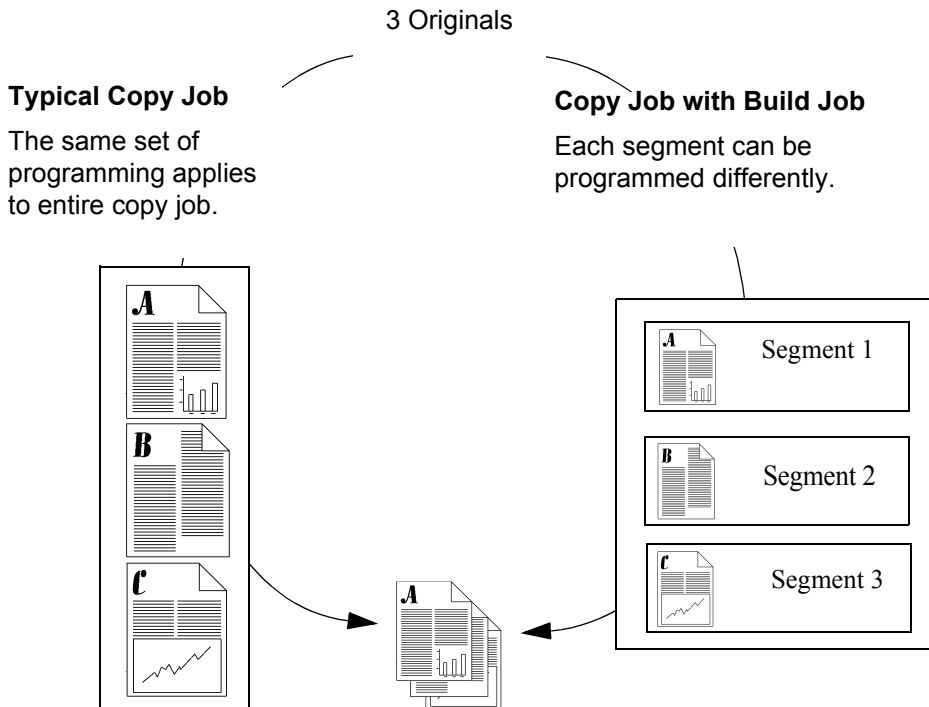

Build Job Examples

- Make image quality settings on one segment that are not required on other segments
- Copy 2-sided and 1-sided originals at the same time
- Make special reductions or enlargements on a segment
- Combine originals from the Document Feeder and the Glass
- Feed more than the maximum number of originals through the Document Feeder

Copying Bound Documents using Build Job

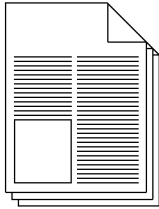
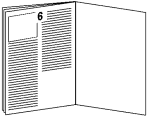
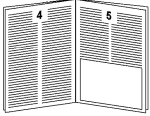
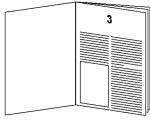

Typical Application

Copy a multipage article that is spread throughout a bound document all at once.

Procedure

1. Open the Document Cover and place the bound original on the Document Glass. Align the spine of the bound document with the Book Binding mark.
2. Make your programming selections by touching the screen. The most common selections are on the *Basic Copying* tab (Output, 2-sided Copy, Reduction/Enlargement, and Paper Supply).
3. Use the keypad to enter the number of copy sets.
4. Depending on the configuration of your machine press the *More Copy Features* tab or the *Job Assembly* tab.
5. Select *Build Job* then the *Build Job On* button. Press *Save*.
6. Press the *Bound Originals* button then press the button that identifies which pages you want to copy.
7. Press the *Start* (◊) button.

NOTE

Use the *Build Job Controls* button to see a sample of the last segment scanned, delete the last segment scanned, or cancel a sample print job that is currently running.

8. Repeat this process until all the pages you want to copy have been scanned.
9. Press the *Build Job Controls* button then select *End Build Job*.

Using Build Job and Sample Set

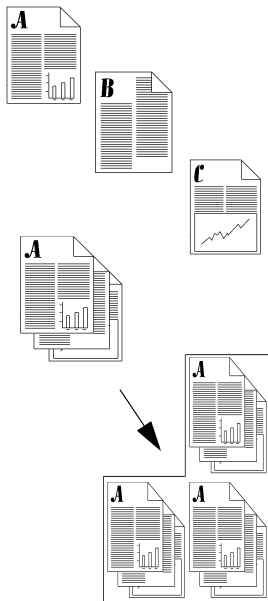

Typical Application

Produce multiple sets of a document where individual segments require unique feature programme selections.

Procedure

1. Load the originals for the first job segment.
2. Depending on the configuration of your machine press the *More Copy Features* tab or the *Job Assembly* tab. If the *More Copy Features* tab is selected press the *Job Assembly* tab.
3. Press *Build Job* then press the *Build Job On* button. Press the *Save* button. Select *Sample Set* and *Save* to produce a single complete set for review.
4. Press the *Basic Copy* tab and programme the appropriate features for the first segment of the job.
5. Press the *Start* (◊) button.
6. Repeat this procedure for each remaining segment.
7. After the final segment has been scanned press *Build Job Controls* then press *End Build Job*.

A single review set will be produced because *Sample Set* was selected.

8. After you review the initial set, press the *Job Status* (Ⓜ) button to display a listing of queued jobs.
9. Touch your job to select it.
10. If you are satisfied with your initial set press *Release*. Otherwise, delete it and start again.

Typical Application

Insert tab stock dividers in the body of copy jobs.

Procedure

Prerequisites:

- Tab masters, see page 67
- Use trays 2, 3 or 4 only
- Tab stock

1. Setup Build Job
 - Select the Job Assembly tab.
 - Select Tabs/Build Job > On > Save.
2. Programme Tab Attributes
 - Select the Basic Copying tab.
 - Select a Tray filled with tab stock.
3. Scan the Tab Master
 - Place the 1st original tab master face up in the Document Feeder > Start.

4. Programme Body Attributes
 - Select the Basic Copying tab.
 - Select a Reduce/Enlarge% as required.
 - Select a Paper Supply without tabs in it.
5. Scan the Body Segment
 - Place the 1st body segment face up in the Document Feeder > Start.
6. Repeat steps 2-5 until all the tab and original segments have been scanned
7. End Build job
 - Select the Build Job Controls button.
 - Select End Build Job.

The entire job will start printing.

NOTE

Copying on tabs is not fully supported on machines configured with an Offsetting Catch Tray.

The Xerox Template

Access the Xerox web site to download templates to create 3, 5, or 8 position tab masters:

1. <http://www.xerox.com>
2. Search using keywords: tab templates
3. In the Search Results, locate the words: **Tab Templates, Supplies Information.**
4. Select Tab Templates
5. On the Tab Template page, under the black Tab Template banner, click the number 1
6. Click to select a template to download

NOTE

Contact the Xerox Welcome Centre if you have questions about Tab Masters on the Xerox web site.

Make Your Own Template

If you do not have access to the internet, you can create a template document.

Type the tab headings on a blank document. The spacing of the tabs will vary depending on the font size that you use. Generally, the tabs are spaced about 51mm apart. You will have to experiment with the creation of the tabs in the document to make sure that they correspond to the appropriate tab location that will be printed. When you have completed the document, you should have 1 tab on each page. For example, if you are using 5 position tabs, you should have a 5 page document with tab data imaged on each page.

Network Faxing Overview (Optional Feature)

Network Faxing is an optional feature that allows you to send and receive faxes using a networked system connected to network fax solution software.

The Key Operator or Administrator can limit access to this feature by enabling Authentication. When Authentication is active you will be required to login before using the Network Fax feature. Remember to log out to prevent unauthorised access.

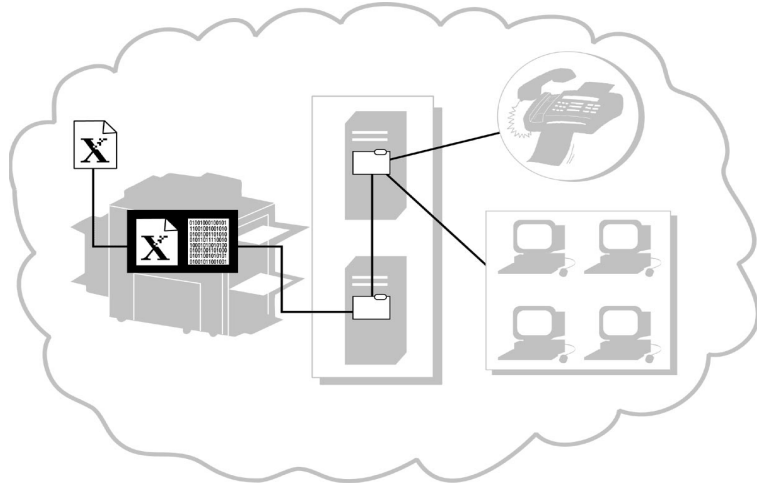

Getting to Know the Process

Sending a FAX

1. The system scans the original paper document and creates a digital file.
2. The digital file and routing information is transferred to a Fax Repository on a Server.
3. The Network Fax Server retrieves the digital file from the Fax Repository, processes it and sends it to the destination.

Receiving a FAX

The Network Fax Server receives an incoming Fax. After it processes the file, the Network Fax software determines the destination of the incoming fax and sends it to the destination.

Faxing a Document

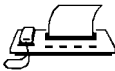

Typical Application

Fax a document to a single number or multiple numbers.

Procedure

1. Load your original face up in the Document Feeder.
2. Press the *Fax* button on the Touch Screen. If Authentication is active, you must complete a login sequence. Remember to log out to prevent unauthorised access.
3. Enter the fax number using the numeric keypad (some configurations require entering a digit and the Dial Pause button to reach an outside line).
4. If originals are 2 Sided, press 2 Sided Originals.

If you are faxing to a single number, skip to step 11.

5. Press *Add to Send List* on the *Touch Screen*.
6. Enter the next fax number using the numeric keypad.
7. Repeat steps 3 and 4 until the last fax number has been added to the list (up to 50 fax numbers may be entered).
8. Press the *Send List* button to verify the numbers entered have been added to the *Send List*.
9. Press the *Close* button after verification.

10. Once all numbers have been entered you may select the desired resolution and number of sides scanned.
11. Press the *Start* (◊) button.
12. If enabled by the network fax solution software, the machine will print a Transmission Report once the fax has been received at the destination fax number.

TIP

Use the Phone List to store up to 30 destination fax numbers to save time when sending a fax.

HINT

You can use the Phone List button to add preprogrammed numbers to the Send List.

Network Scanning Overview (Optional Feature)

Network Scanning is an optional feature that allows you to create and distribute an electronic file from a scanned original.

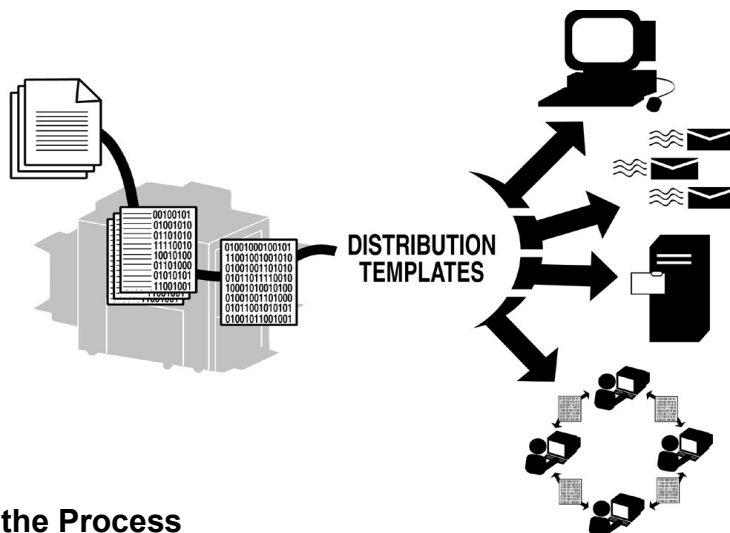

Getting to Know the Process

1. The user decides what type of settings are needed to process the scan job and where the scanned file will need to be sent after it is processed.
2. The user selects a Distribution Template that meets these requirements.
Not all scanning features require the use of a template. You can scan to fax or scan to e-mail without using a template.
3. When the *Start* button is pressed, the system scans the original document and creates a digital file based on the template selected.
4. The system transfers the file to a folder on a file server.
5. Software installed on either a user's workstation or a file server retrieves the file and sends it to the specified destination.

Scanning Options

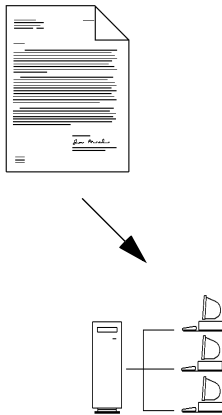

Option	Typical Application
Scan to File	Create an electronic file from a hard copy original to be shared on the network.
Scan to Desktop	Scan a document to your workstation.
Scan to E-mail Distribution	Scan a document to distribute through e-mail: <ul style="list-style-type: none">• using a CentreWare® template• without a CentreWare® template
Scan to Fax	Scan a document to a fax machine via telephone number.
Scan to Internet Fax	Scan a document to a fax machine via an internet address.

Procedure

1. Load your originals.
2. Press the *Network Scanning* button on the *Touch Screen*. If Authentication is active, you must complete a login sequence. Remember to log out to prevent unauthorised access.

NOTE

If you have recently created a new template or modified an existing one using CentreWare® Network Scanning services tools, you must update the template list at the machine so it reflects the latest information.

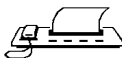
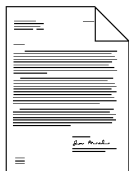

Press the *More Scan Features* tab then the *Update Template List* button. Press the *Update Template List* button then the *Confirm* button.

This may take a few minutes depending upon the number of templates available.

3. Select the desired template in the *Template Name List*. If the desired template does not exist, refer to the *CentreWare® Network Scanning Services* guide for information on creating a template.

You can modify your template by pressing the *Sides Scanned* button to select 1 sided, 2 sided, or 2 sided, Rotate Side 2.

4. Press the *Image Quality* button that corresponds to the correct image orientation of your originals then press the *Save* button.
5. Press the *Start* (◊) button.

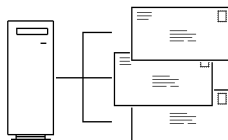
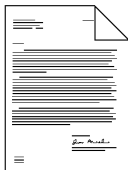

Scan to Desktop only:

6. If enabled, you will receive a message at your workstation indicating a scanned document is in your folder.
7. Use the PaperPort™ software included with the system to edit, or process scanned images.

Internet Fax Overview (Optional Feature)

Internet Fax is an optional feature that is available upon request for networked systems.

The Machine Administrator can limit access to this feature by enabling Authentication. When Authentication is active you will be required to enter a network password or guest passcode. Remember to log out to prevent unauthorised access.

When available, you can send a scanned document to one or more Internet Fax destinations and receive Internet Faxes without requiring connectivity to a telephone connection.

With Internet Fax installed you can:

- Send scanned images over the internet at internet or intranet rates.
- Request that the receiving machine relay the fax onto a basic fax machine. For example you can send an internet fax to another internet fax machine around the world and then relay the fax to a local fax machine to save telephone charges.
- Receive confirmation of delivery in much the same way as the standard fax service by returning a delivery status notification or message for the job via the internet.

Undelivered Internet Fax Jobs

In some cases the receiving device may return undelivered jobs back to your WorkCentre Pro. If your system is configured to receive Internet Fax jobs, undelivered jobs could be returned to the WorkCentre Pro and printed as an incoming fax job.

When sending Internet Fax jobs, check the status of your sent job through the Job Status button. See page 37 for details on the Job Queue and Job Status. If the job is not confirmed or completed, the image file may not have been processed at the destination device.

E-mail Overview (Optional Feature)

E-mail is an optional feature that allows you to send electronic-mail messages without using a template. The system must be connected to the network.

The Key Operator or Administrator can limit access to this feature by enabling Authentication. When Authentication is active you will be required to login before using the E-mail feature. Remember to log out to prevent unauthorised access.

Getting to Know the Process

Sending an E-mail Message

1. The system scans the original paper document and creates a digital file.
2. The system transfers the digital file and routing information to a Simple Mail Transfer Protocol (SMTP) Repository on a Server.
3. The Network Server retrieves the digital file from the SMTP Repository, processes it and sends it to the destination.

Sending an Internet Fax or E-mail without a template

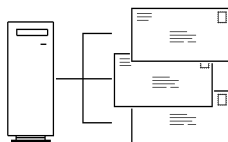
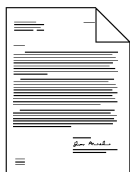

Typical Application

E-mail or Internet Fax a document to a single recipient or multiple recipients.

Procedure

1. Load your original face up in the Document Feeder.
2. Press the *E-mail or Internet Fax* button. If Authentication is active, you must complete a login sequence. Remember to log out to prevent unauthorised access.
3. Select the desired resolution and number of sides scanned. If the originals are 2 Sided, press 2 Sided Originals.
4. Select either the *To...*, *Cc...*, or *Bcc...* button. The *Add Entry* screen will display.
5. Using the touch screen, enter an SMTP-compliant recipient name.

You can choose an *Address Book* and enter the full name or a portion of the name of the recipient.

6. Select the enter button. The system will search the Address Book and list all the names that match.
7. You can examine detailed information on any matches by selecting any line in the search results window. When the correct match is found touch the enter button to add the recipient to the Address List.
8. Repeat steps 4 through 6 until the last recipient has been added to the list (up to 128 recipients may be entered).
9. Press the *Start* (◊) button.

Document Management Fields Overview

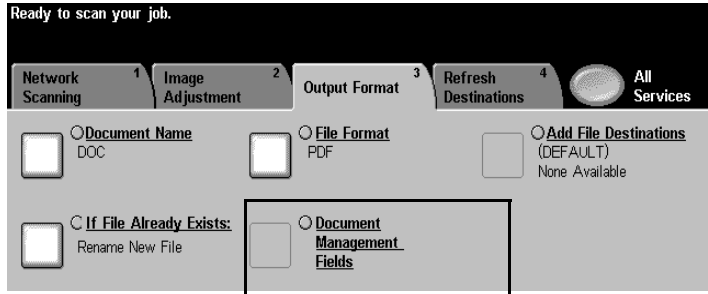

Document Management Fields allow you to create fields that contain variable programmable data. The information is stored in the Job Log with your scanned file. You can use your company's Document Management Information software to access the Job Log to retrieve or route the stored files.

NOTE

This feature is only available when you use a template containing Document Management Fields information. Up to 6 Document Management Fields can be programmed for each template.

Creating Document Management Fields

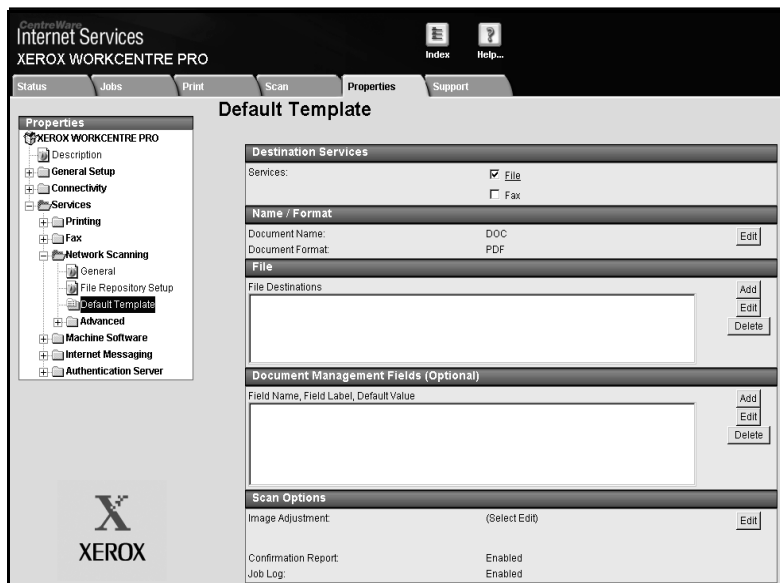

Use Internet Services to create Document Management Fields. You will need the Internet Protocol (IP) address of the system. Your Key Operator or Administrator can provide the address if you do not know it.

1. Type the system's IP address in your browser. The system's Home Page will open.
2. Select *Services*.
3. Select the *Distribution Templates* button.
4. Choose the desired template.

Use the Add, Edit or Delete buttons to create, modify or delete a Document Management Field.

5. Select Add New Field.

Up to 6 fields can be programmed for each template.

Index

A

- Access to Copying 39
- Account ID Number 39
- Address 12
- Auditron
 - Establishing Accounts
 - See Reference Guide
 - Using when enabled 38
- Authentication
 - E-mail 73, 77, 78
 - Fax 35, 68, 70
 - Guest Access 30
 - Internet Fax 75
 - Login Procedures 31
 - Network Access 30
 - Overview 30
 - Unauthorized Access 31
- Auto Paper Selection 44
- Auto Reduction Enlargement 44

B

- Binding Edge 53
- Booklet Creation feature 57, 58
- Booklet Fold 58
- Border Erase 50
- Bound Documents 23
 - Copying 51
- Brochures
 - Making brochures 57
- Build Job 62–67
- Bypass Tray
 - Loading Paper 36

C

- C-Configuration Fold 59
- CentreWare 12
- Clear All button
 - Copying 28
 - Faxing 34
 - Scanning 32

Copy Quality
 See Image Quality 49
Copying
 Adjusting Image Quality 49
 Books 51
 Mixed Size Originals 60
Covers 20
 Adding to a document 54

D

Deleting a job 37
Digital Features 15
Distribution Template 72
Dividers
 Transparency 56
Document Feeder
 Loading Originals
 Copying 28
 Faxing 34
 Scanning 32
Document Glass
 Copying 28
 Faxing 34
 Scanning 32
Document Management Fields
 Creating Fields 80
 Overview 79
Double sided copies 45
Duplex copies 45

E

Edge Erase 50
Electronic Auditron 39

E-mail 17
 Authentication 30, 77, 78
 E-mail without a template 73, 78
 Overview 77
 Using a template 73
Embedded Web Server 12
Enlargement/Reduction 52
Establishing Auditron Accounts
 See Reference Guide

F

Fail, Login 31
Fax, Internet Fax 73
Faxing 17, 34
 Authentication 30, 35
 Overview 68
 Single or Multiple Numbers 70
Finisher 27, 58–59
Folded Booklets 21, 58

H

High Capacity Feeder
 Loading Paper 36

I

Image
 Rotating the second side 48
Image Overwrite 40
Image Quality 49
Internal Auditron 38
Internet Fax 17, 25, 75, 78
Internet Protocol (IP) 13
Internet Services 12, 13

J

- Job Queue 37
- Job Supplement
 - See Build Job 62

L

- Login/Logout, Auditron 38
- Login/Logout, Authentication 31

M

- Masters, Tabs 67
- Mixed Size Originals 60–61
- Moving the image 53
- Multi-Up feature 55

N

- Network Accounting 39
- Network Authenticated Access 30
- Network E-mail
 - Description 17
- Network Faxing 24
 - Authentication 68, 70
 - Description 17
 - Overview 68–69
 - Quick Start 34
 - To a Single Number 24
 - To Multiple Numbers 24
- Network Scanning 25
 - Authentication 30
 - Create electronic files 17
 - Document Management Fields

79

- Mixed Size Originals 61
- Overview 72
- To Desktop 25, 73
- To E-Mail 25, 73
- To Fax 25, 73
- To File 25, 73

Normal 49

O

- On/Off button 27
- Optional Professional Finisher 58–59
- Overwrite 40
- Ozone Information 5

P

- Paper
 - Loading 35
- Pathway 38
- Power 27
- Printer Driver, USB Port 14
- Printing
 - Features 12
 - Internet Services 13
 - USB Port 14
 - Workstation 12
- Professional Finisher 58–59
- Proof
 - See Sample Set 64

Q

Queue

Managing the job queue 37

R

Recycled Paper 16

Reduction/Enlargement 52

Relocation

Ozone requirements 5

S

Safety

Electrical 2

Laser 6

Operational 7

Sample Set 23, 64

Scanning

Authentication 30, 73

Create electronic files 17

Document Management 79

Overview 72

Scan to File 73

Scanning Documents 32

Secure Print 41

Security 40

Image Overwrite

Immediate Image Overwrite

On Demand Image Overwrite

Secure Print

Shifting an image 53

Signature Booklet

See Booklet Creation 57

Stapling 45

Status of Job 37

T

Tab Masters 67

Tabs/Build Job 24, 65

Template

Creating

Refer to CentreWare Network

Scanning Services

E-mail without a template 77

Overview 72

Template List 74

Thumbnails 55

Touch Screen 27

Transparencies 21

Transparency Dividers 56

Tri-Fold 22, 59

C-Configuration

Z-Configuration

Trim

See Border Erase 50

U

Unauthorized Access 31

USB Port Printing 14

User ID 39

User Pathway 38

W

Web Server (Internet Services) 12,
13

Z

Z-Configuration 59

Free Manuals Download Website

<http://myh66.com>

<http://usermanuals.us>

<http://www.somanuals.com>

<http://www.4manuals.cc>

<http://www.manual-lib.com>

<http://www.404manual.com>

<http://www.luxmanual.com>

<http://aubethermostatmanual.com>

Golf course search by state

<http://golfingnear.com>

Email search by domain

<http://emailbydomain.com>

Auto manuals search

<http://auto.somanuals.com>

TV manuals search

<http://tv.somanuals.com>