

# XEROX®

## WorkCentre 4118 User Guide

32N00467



Prepared and Translated by:

Xerox  
GKLS European Operations  
Bessemer Road  
Welwyn Garden City  
Hertfordshire  
AL7 1BU  
ENGLAND

©2006 by Xerox Corporation. All rights reserved.

Copyright protection claimed includes all forms and matters of copyrighted material and information now allowed by statutory or judicial law or hereinafter granted, including without limitations, material generated from the software programs which are displayed on the screen, such as icons, screen displays, looks etc.

Xerox® and all Xerox products mentioned in this publication are trademarks of Xerox Corporation. Product names and trademarks of other companies are hereby acknowledged.

Changes, technical inaccuracies and typographical errors will be corrected in subsequent editions.

# Table of Contents

---

<b>1</b>	<b>Welcome .....</b>	<b>1-1</b>
	Introduction.....	1-2
	About This Guide.....	1-3
	Related Information Sources.....	1-4
	Customer Support .....	1-5
	<b>Safety Notes .....</b>	<b>1-6</b>
	Electrical Safety Information .....	1-7
	Operational Safety Information .....	1-8
	Maintenance Information.....	1-9
	Ozone Safety Information .....	1-9
	Consumables .....	1-10
	Radio Frequency Emissions .....	1-10
	Laser Safety Information .....	1-10
	Product Safety Certification.....	1-11
	<b>Regulatory Information .....</b>	<b>1-12</b>
	FAX Function .....	1-12
	<b>Environmental Compliance .....</b>	<b>1-16</b>
	<b>Illegal Copies.....</b>	<b>1-17</b>
	<b>Product Recycling and Disposal.....</b>	<b>1-20</b>
<b>2</b>	<b>Getting Started .....</b>	<b>2-1</b>
	<b>Unpacking .....</b>	<b>2-2</b>
	CD Contents.....	2-3
	CD Installation.....	2-5
	<b>Machine Overview .....</b>	<b>2-6</b>
	Models and Options .....	2-6
	Component Location .....	2-7
	Control Panel Overview .....	2-9
	2 in 1 Control panel .....	2-9

4 in 1 Control panel .....	2-9
<b>Installing Drum and Toner Cartridges .....</b>	<b>2-12</b>
<b>Making Connections.....</b>	<b>2-14</b>
<b>Powering On the Machine.....</b>	<b>2-16</b>
<b>Loading Paper .....</b>	<b>2-17</b>
<b>Machine Setup .....</b>	<b>2-20</b>
Machine Setup Options .....	2-21
<b>Installing Software.....</b>	<b>2-24</b>
Installing Drivers.....	2-24
System Requirements .....	2-24
Installing Drivers in Windows .....	2-25
Test Print or Scan .....	2-32
<b>3 Copy .....</b>	<b>3-1</b>
<b>Copying Procedure.....</b>	<b>3-2</b>
<b>Basic Copy Features .....</b>	<b>3-6</b>
Feature Description .....	3-6
<b>Special Copy Features .....</b>	<b>3-9</b>
Feature Description .....	3-9
<b>Compatible Features .....</b>	<b>3-13</b>
<b>4 Paper and Other Media.....</b>	<b>4-1</b>
<b>Loading Paper .....</b>	<b>4-2</b>
Preparing Paper for Loading .....	4-2
Using the Paper Trays .....	4-2
Using the Bypass Tray .....	4-5
<b>Setting the Paper Size .....</b>	<b>4-8</b>
<b>Media Specifications .....</b>	<b>4-9</b>
Media Sizes and Types.....	4-9
<b>5 Fax (4 in 1 only).....</b>	<b>5-1</b>
<b>Faxing Procedure .....</b>	<b>5-2</b>
<b>Dialing Methods .....</b>	<b>5-6</b>
<b>Basic Fax Features .....</b>	<b>5-8</b>
Feature Description .....	5-8
<b>Special Fax Features .....</b>	<b>5-10</b>
Feature Description .....	5-10
<b>Fax Forwarding .....</b>	<b>5-14</b>
<b>Mailbox Setup .....</b>	<b>5-15</b>

Create a Mailbox .....	5-15
Delete a Mailbox .....	5-16
<b>Mailbox Procedures.....</b>	<b>5-17</b>
Storing Documents in a Mailbox .....	5-17
Printing Mailbox Contents .....	5-18
Deleting Mailbox Contents .....	5-19
Polling from a Mailbox .....	5-20
Sending to a Mailbox.....	5-21
<b>Fax Setup Options .....</b>	<b>5-22</b>
Changing the Fax Setup Options .....	5-22
Fax Setup Options .....	5-23
<b>6 Print.....</b>	<b>6-1</b>
<b>Printing a Document.....</b>	<b>6-2</b>
<b>Printer Settings .....</b>	<b>6-3</b>
Accessing Printer Settings .....	6-3
<b>PCL Driver .....</b>	<b>6-5</b>
Layout Tab .....	6-6
Paper Tab .....	6-7
Image Options Tab.....	6-8
Output Options Tab.....	6-9
Watermark Tab .....	6-10
About Tab.....	6-11
<b>7 Scan (4 in 1 only) .....</b>	<b>7-1</b>
<b>TWAIN Scanner Program.....</b>	<b>7-2</b>
<b>TWAIN Scanning Procedure .....</b>	<b>7-3</b>
<b>Scanning Using the WIA Driver .....</b>	<b>7-6</b>
WIA Scanning Procedure .....	7-6
<b>8 Machine Administration .....</b>	<b>8-1</b>
<b>Reports .....</b>	<b>8-2</b>
Reports Available .....	8-2
Printing Reports .....	8-3
<b>ControlCentre.....</b>	<b>8-4</b>
Installing ControlCentre.....	8-4
Running ControlCentre .....	8-4
Using ControlCentre.....	8-4
<b>Passcode Protection .....</b>	<b>8-7</b>
Enable Passcode Protection .....	8-7
Change the Passcode.....	8-8

<b>Clear Memory</b> .....	<b>8-9</b>
Clearing the Memory .....	8-9
<b>Maintenance Tools</b> .....	<b>8-10</b>
Check the Serial Number .....	8-10
Notify Toner Low .....	8-11
New Drum .....	8-11
Clean Drum .....	8-12
Billing Counters .....	8-12
<b>Enabling or Disabling Auxiliary Access</b> .....	<b>8-13</b>
<b>9 Maintenance</b> .....	<b>9-1</b>
<b>Cleaning</b> .....	<b>9-2</b>
Cleaning the Document Glass and Constant Velocity Transport (CVT)	
Glass .....	9-2
Control Panel and LCD .....	9-3
Outside Areas of the Machine .....	9-3
<b>Ordering Supplies</b> .....	<b>9-4</b>
<b>Customer Replaceable Units</b> .....	<b>9-5</b>
Toner Cartridge .....	9-5
Drum Cartridge.....	9-8
Replacing the Drum Cartridge.....	9-8
<b>10 Troubleshooting</b> .....	<b>10-1</b>
<b>General</b> .....	<b>10-2</b>
<b>Fault Clearance</b> .....	<b>10-3</b>
Document Jams .....	10-3
Paper Jams .....	10-6
Paper Exit Area .....	10-7
2 Sided Jam .....	10-9
Bypass Tray Jam .....	10-9
<b>Customer Support</b> .....	<b>10-10</b>
<b>LCD Error Messages</b> .....	<b>10-11</b>
<b>Problem and Solutions Charts</b> .....	<b>10-14</b>
Copying Problems .....	10-14
Printing Problems .....	10-15
Faxing Problems Solution Chart .....	10-17
<b>11 Specifications</b> .....	<b>11-1</b>
<b>Introduction</b> .....	<b>11-2</b>
<b>Printer Specifications</b> .....	<b>11-3</b>

<b>Fax Specifications .....</b>	<b>11-4</b>
<b>Scanner and Copier Specifications .....</b>	<b>11-5</b>
<b>General Specifications .....</b>	<b>11-6</b>
<b>Media Specifications .....</b>	<b>11-7</b>
<b>12 Index .....</b>	<b>1-1</b>





# 1 Welcome

---

Thank you for choosing the *Xerox WorkCentre 4118*. This product have been designed for ease of use, but to use your machine to its fullest potential take some time to read the *User Guide*.

- Introduction . . . . . 1-2
- About This Guide . . . . . 1-3
- Related Information Sources . . . . . 1-4
- Customer Support . . . . . 1-5
- Safety Notes . . . . . 1-6
- Regulatory Information . . . . . 1-12
- Environmental Compliance . . . . . 1-16
- Illegal Copies . . . . . 1-17
- Product Recycling and Disposal . . . . . 1-20

# Introduction

## ***Xerox WorkCentre 4118p***

Hereafter the *4118p* will be referred to in this documentation as the 2 in 1 model.

The 2 in 1 model provides digital copying and direct printing at 17 pages per minute A4 or 18 pages per minute letter as standard.

Options available include an additional Paper Tray, Document Feeder, Foreign Interface, Stand and Network Kit. The Network Kit enables network printing, including PostScript, Macintosh and Linux print and scan drivers.

## ***Xerox WorkCentre 4118x***

Hereafter the *4118x* will be referred to in this documentation as the 4 in 1 model.

The 4 in 1 model provides digital copying, direct printing, fax and direct scanning at 17/18 pages per minute.

Options include an additional Paper Tray, Foreign Interface, Stand, and Network Kit. The Network Kit enables network printing including PostScript, Macintosh and Linux print and scan drivers.

- *For instructions on unpacking and setting up the machine ready for use the Quick Install Sheets, or refer to "Getting Started" on page 2-1.*

# About This Guide

Throughout this *User Guide* some terms are used interchangeably:

- Paper is synonymous with media.
- Document is synonymous with original.
- *Xerox WorkCentre 4118* is synonymous with the machine.

The following table offers further information about the conventions used within this Guide.

CONVENTION	DESCRIPTION	EXAMPLE
<b>Italic Typeface</b>	Used to emphasize a word or phrase. In addition, references to other publications are displayed in Italic typeface.	<i>Xerox WorkCentre 4118.</i>
<b>Bracket Text Typeface</b>	Used to emphasize the selection of a feature mode or key.	➤ Select the paper supply source required by pressing [Paper Supply].
<b>Notes</b>	Located in the margins and used to provide additional or useful information about a function or feature.	● <i>For instructions on loading media, refer to "Loading Paper" on page 4-2.</i>
<b>Specification Note</b>	Provides more in-depth specification information relating to the machine.	ⓘ <i>For full media specifications refer to "Media Specifications" on page 11-7.</i>
<b>Caution</b>	Cautions are statements that suggest <i>mechanical</i> damage as a result of an action.	<b>CAUTION: DO NOT use organic or strong chemical solvents or aerosol cleaners or pour fluids directly onto any area.</b>
<b>Warning</b>	Used to alert users to the possibility of <i>personal</i> injury.	<b>WARNING: This product must be connected to a protective earthing circuit.</b>

# Related Information Sources

Information available for the product consists of:

- This *User Guide*
- The *Quick Use Guide*
- The *Quick Install Sheets*
- The *System Administration Guide*
- The Xerox website <http://www.xerox.com>

# Customer Support

If you need assistance during or after product installation, please visit the Xerox website for online solutions and support:

<http://www.xerox.com>

If you require further assistance, call our experts at the *Xerox Welcome Center*, or contact your local representative. When telephoning please provide the machine serial number. Use the space below to make a note of the machine serial number:

# \_\_\_\_\_

To access the serial number open the side cover using the release latch and then open the front door. The serial number is located on the panel above the *Toner Cartridge*.

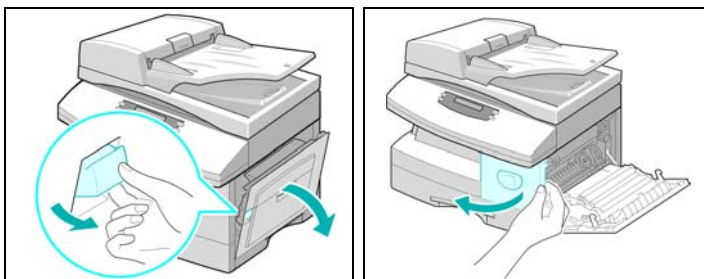

The *Xerox Welcome Center* or local representative telephone number is provided when the machine is installed. For convenience and future reference, please record the telephone number in the space below:

*Xerox Welcome Center* or local representative telephone number:

# \_\_\_\_\_

***Xerox US Welcome Center:*      1-800-821-2797**

***Xerox Canada Welcome Center:*      1-800-93-XEROX (1-800-939-3769)**

# Safety Notes

Read these safety notes carefully before using this product to ensure you operate the equipment safely.

Your Xerox product and supplies have been designed and tested to meet strict safety requirements. These include safety agency approval, and compliance to established environmental standards. Please read the following instructions carefully before operating the product and refer to them as needed to ensure the continued safe operation of your product.

The safety and environment testing and performance of this product have been verified using Xerox materials only.

---

***WARNING: Any unauthorized alternation, which may include the addition of new functions or connection of external devices, may impact the product certification. Please contact your authorized local dealer for more information.***

---

## ***Warning Markings***

All warning instructions marked on or supplied with the product should be followed.



This WARNING symbol alerts users to areas of the product where there is the possibility of personal injury.



This WARNING symbol alerts users to areas of the product where there are heated surfaces, which should not be touched.

## ***Electrical Supply***

This product shall be operated from the type of electrical supply indicated on the product's data plate label. If you are not sure that your electrical supply meets the requirements, please consult your local power company for advice.



---

***WARNING: This product must be connected to a protective earth circuit.***

---

This product is supplied with a plug that has a protective earth pin. This plug will fit only into an earthed electrical outlet. This is a safety feature. To avoid risk of electric shock, contact your electrician to replace the electrical outlet if you are unable to insert the plug into it. Never use an earthed adapter plug to connect the product to an electrical outlet that lacks an earth connection terminal.

## **Operator Accessible Areas**

This equipment has been designed to restrict operator access to safe areas only. Operator access to hazardous areas is restricted with covers or guards which would require a tool to remove. Never remove these covers or guards.

## **Maintenance**

Any operator product maintenance procedures will be described in the user documentation supplied with the product. Do not to carry out any maintenance on this product which is not described in the customer documentation.

## **Cleaning Your Product**

Before cleaning this product, unplug the product from the electrical outlet. Always use materials specifically designated for this product, the use of other materials may result in poor performance and may create a hazardous situation. Do not use aerosol cleaners - they may be explosive and flammable under certain circumstances.

## **Electrical Safety Information**

- Only use the power cord supplied with this equipment.
- Plug the power cord directly into a grounded electrical outlet. Do not use an extension cord. If you do not know whether or not an outlet is grounded, consult a qualified electrician.
- This equipment is to be operated from the type of electrical supply indicated on the product data plate label. If this machine needs to be moved to a different location, contact a Xerox service representative or your authorized local representative or service support organization.
- Improper connection of the equipment-grounding conductor can result in electrical shock.
  - Do not place this equipment where people might step on or trip on the power cord.
  - Do not place objects on the power cord.
  - Do not override or disable electrical or mechanical interlocks.
  - Do not obstruct the ventilation openings.
  - Never push objects of any kind into slots or openings on this equipment
- If any of the following conditions occur, switch off the power to the machine immediately and disconnect the power cord from the electrical outlet. Call an authorized local service representative to correct the problem.
  - The equipment emits unusual noise or odors.
  - The power cord is damaged or frayed.

- A wall panel circuit breaker, fuse, or other safety device has been tripped.
- Liquid is spilled into the copier/printer.
- The equipment is exposed to water.
- Any part of the equipment is damaged.

### **Disconnect Device**

The power cable is the disconnect device for this equipment. It is attached to the back of the machine as a plug-in device. To remove all electrical power from the equipment, disconnect the power cable from the electrical outlet.

## **Operational Safety Information**

To ensure the continued safe operation of your Xerox equipment, follow these safety guidelines at all times.

### **Do These:**

Always connect equipment to a correctly grounded power outlet. If in doubt, have the outlet checked by a qualified electrician.

- This equipment must be connected to a protective earth circuit.  
This equipment is supplied with a plug that has a protective earth pin. This plug will fit only into an earthed electrical outlet. This is a safety feature. To avoid risk of electric shock, contact your electrician to replace the electrical outlet if you are unable to insert the plug into it. Never use a plug that lacks an earth connection terminal to connect the product to an electrical outlet.
- Always follow all warnings and instructions that are marked on or supplied with the equipment.
- Always exercise care when moving or relocating equipment. Please contact your local Xerox Service Department, or your local support organization to arrange relocation of the product to a location outside of your building.
- Always locate the equipment in an area that has adequate ventilation, and the room for servicing. See Install guide for minimum dimensions.
- Always use materials and supplies specifically designed for your Xerox equipment. Use of unsuitable materials may result in poor performance.
- Always unplug this equipment from the electrical outlet before cleaning.



### ***Do Not Do These:***

- Never use a plug that lacks an earth connection terminal to connect the product to an electrical outlet.
- Never attempt any maintenance function that is not specifically described in this documentation.
- This equipment should not be placed in a built-in installation unless proper ventilation is provided. Please contact your Authorized local dealer for further information.
- Never remove covers or guards that are fastened with screws. There are no operator serviceable areas within these covers.
- Never locate the equipment near a radiator or any other heat source.
- Never push objects of any kind into the ventilation openings.
- Never override or "cheat" any of the electrical or mechanical interlock devices.
- Never operate the equipment if you notice unusual noises or odors. Disconnect the power cord from the electrical outlet and contact your local Xerox Service Representative or Service Provider immediately.

## ***Maintenance Information***

Do not attempt any maintenance procedure that is not specifically described in the documentation that is supplied with your copier/printer.

- Do not use aerosol cleaners. The use of cleaners that are not approved may cause poor performance of the equipment, and could create a dangerous condition.
- Use supplies and cleaning materials only as directed in this manual. Keep all of these materials out of the reach of children.
- Do not remove covers or guards that are fastened with screws. There are no parts behind these covers that you can maintain or service.
- Do not perform any maintenance procedures unless you have been trained to do them by an authorized local dealer or unless a procedure is specifically described in the user manuals.

## ***Ozone Safety Information***

This product will produce ozone during normal operation. The ozone produced is heavier than air and is dependent on copy volume. Providing the correct environmental parameters as specified in the Xerox installation procedure will ensure that the concentration levels meet safe limits.

If you need additional information about ozone, please request the Xerox publication Ozone by calling 1-800-828-6571 in the United States and Canada. In other markets please contact your authorized local dealer or Service Provider.

## Consumables

Store all consumables in accordance with the instructions given on the package or container.

- Keep all consumables away from the reach of children.
- Never throw toner, toner cartridges or toner containers into an open flame.

## Radio Frequency Emissions

### ***United States, Canada, Europe, Australia/New Zealand***

Note: This equipment has been tested and found to comply with the limits for a class A digital device, pursuant to Part 15 of the FCC Rules. These limits are designed to provide reasonable protection against harmful interference when the equipment is operated in a commercial environment. This equipment generates, uses, and can radiate radio frequency energy and, if not installed and used in accordance with the instruction manual, may cause harmful interference to radio communications. Operation of this equipment in a residential area is likely to cause harmful interference in which case the user will be required to correct the interference at his own expense.

Changes and modifications to this equipment not specifically approved by Xerox may void the user's authority to operate this equipment.

## Laser Safety Information

---

**CAUTION: Use of controls, adjustments or performance of procedure other than those specified herein may result in hazardous light exposure.**

---

With specific regard to laser safety, the equipment complies with performance standards for laser product set by government, national and international agencies as a Class 1 laser product. It does not emit hazardous light, as the beam is totally enclosed during all phases of customer operation and maintenance.

## Product Safety Certification

This product is certified by the following Agency using the Safety standards listed.

AGENCY	STANDARD
Underwriters Laboratories Inc.	UL60950-1st Edition (USA/Canada)
ETL SEMKO	IEC60950 1strd Edition (2001)

This product was manufactured under a registered ISO9001 Quality system.

# Regulatory Information

## **CE Mark**

The CE mark applied to this product symbolizes Xerox's declaration of conformity with the following applicable Directives of the European Union as of the dates indicated:

January 1, 1995: Council Directive 72/23/EEC amended by Council directive 93/68/EEC, approximation of the laws of the member states related to low voltage equipment.

January 1, 1996: Council directive 89/336/EEC, approximation of the laws of the member states related to electromagnetic compatibility.

March 9, 1999: Council Directive 99/5/EC, on radio equipment and telecommunications terminal equipment and the mutual recognition of their conformity.

A full declaration of conformity, defining the relevant directives and referenced standards, can be obtained from your Authorized local dealer.

---

***WARNING: In order to allow this equipment to operate in proximity to Industrial Scientific and Medical (ISM) equipment, the external radiation from the ISM equipment may have to be limited or special mitigation measures taken.***

---

---

***WARNING: This is a Class A product. In a domestic environment the product may cause radio frequency interference, in which case the user may be required to take adequate measures.***

---

## **FAX Function**

### **USA**

#### **FAX Send Header Requirements:**

The telephone Consumer Protection Act of 1991 makes it unlawful for any person to use a computer or other electronic device, including a Fax machine, to send any message unless such message clearly contains in a margin at the top or bottom of each transmitted page or on the first page of the transmission, the date and time it is sent and an identification of the business or other entity, or other individual sending the message and the telephone number of the sending machine or such business, other entity or individual. (The telephone number provided may not be a 900 number or any other number for which charges exceed local or long distance transmission charges.)

**Data Coupler Information:**

This equipment complies with Part 68 of the FCC rules and the requirements adopted by the Administrative Council for Terminal Attachments (ACTA). On the rear of this equipment is a label that contains, among other information, a product identifier in the format US:AAAEQ##TXXXX. If requested, this number must be provided to the Telephone Company.

A plug and jack used to connect this equipment to the premises wiring and telephone network must comply with the applicable FCC Part 68 rules and requirements adopted by the ACTA. A compliant telephone cord and modular plug is provided with this product. It is designed to be connected to a compatible modular jack that is also compliant.

---

***WARNING: Ask your local Telephone Company for the modular jack type installed on your line. Connecting this machine to an unauthorized jack can damage Telephone Company equipment. You, not Xerox, assume all responsibility and/or liability for any damage caused by the connection of this machine to an unauthorized jack.***

---

You may safely connect the machine to the following standard modular jack: USOC RJ-11C using the compliant telephone line cord (with modular plugs) provided with the installation kit. See installation instructions for details.

The Ringer Equivalence Number (or REN) is used to determine the number of devices that may be connected to a telephone line. Excessive RENs on a telephone line may result in the devices not ringing in response to an incoming call. In most but not all areas, the sum of RENs should not exceed five (5.0). To be certain of the number of devices that may be connected to a line, as determined by the total RENs, contact the local Telephone Company. For products approved after July 23, 2001, the REN for this product is part of the product identifier that has the format US: AAAEQ##TXXXX.

For earlier products, the REN is separately shown on the label.

If this Xerox equipment causes harm to the telephone network, the Telephone Company will notify you in advance that temporary discontinuance of service may be required. But if advance notice isn't practical, the Telephone Company will notify the customer as soon as possible. Also, you will be advised of your right to file a complaint with the FCC if you believe it is necessary.

The Telephone Company may make changes in its facilities, equipment, operations or procedures that could affect the operation of the equipment. If this happens the Telephone Company will provide advance notice in order for you to make necessary modifications to maintain uninterrupted service.

If trouble is experienced with this Xerox equipment, for repair or warranty information, please contact the Xerox Welcome Center telephone number 800-821-2797.

If the equipment is causing harm to the telephone network, the Telephone Company may request that you disconnect the equipment until the problem is resolved.

Repairs to the machine should be made only by a Xerox representative or an authorized Xerox service agency. This applies at any time during or after the service warranty period. If unauthorized repair is performed, the remainder of the warranty period is null and void. This equipment must not be used on party lines. Connection to party line service is subject to state tariffs. Contact the state public utility commission, public service commission or corporation commission for information.

If your office has specially wired alarm equipment connected to the telephone line, ensure the installation of this Xerox equipment does not disable your alarm equipment. If you have questions about what will disable alarm equipment, consult your Telephone Company or a qualified installer.

## **CANADA**

This product meets the applicable Industry Canada technical specifications.

The Ringer Equivalence Number (REN) is an indication of the maximum number of devices allowed to be connected to a telephone interface. The termination on an interface may consist of any combination of devices subject only to the requirement that the sum of the RENs of all the devices does not exceed five. The REN value may be found on the label located on the rear of the equipment.

Repairs to certified equipment should be made by an authorized Canadian maintenance facility designated by the supplier. Any repairs or alterations made by the user to this equipment, or equipment malfunctions, may give the telecommunications company cause to request the user to disconnect the equipment.

Users should ensure for their own protection that the electrical ground connections of the power utility, telephone lines and internal metallic water pipe systems, if present, are connected together. This precaution may be particularly important in rural areas.

---

**CAUTION: Users should not attempt to make such connections themselves, but should contact the appropriate electric inspection authority, or electrician, as appropriate.**

---

## EUROPE

### Radio Equipment & Telecommunications Terminal Equipment Directive:

This Xerox product has been self-certified by Xerox for pan-European single terminal connection to the analogue public switched telephone network (PSTN) in accordance with Directive 1999/5/EC. The product has been designed to work with the national PSTNs and compatible PBXs of the following countries:

Austria	Germany	Luxembourg	Sweden
Belgium	Greece	Netherlands	Switzerland
Denmark	Iceland	Norway	United Kingdom
France	Ireland	Portugal	Finland
Italy	Spain	Czech Republic	Poland
Bulgaria	Romania		

In the event of problems you should contact your local Xerox representative in the first instance. This product has been tested to and is compliant with TBR21, a specification for terminal equipment for use on analogue-switched telephone networks in the European Economic Area. The product may be configured to be compatible with other country networks. Please contact your Xerox representative if it needs to be reconnected to another country's network. There are no user-adjustable settings in the product.

---

**NOTE:** Although this product can use either loop disconnect (pulse) or DTMF (tone) signaling, it is recommended that it is set to use DTMF signaling. DTMF signaling provides reliable and faster call setup.

Modification of this product, connection to external control software or to external control apparatus not authorized by Xerox, will invalidate its certification.

---

# Environmental Compliance

## USA



**Energy Star** - As an ENERGY STAR partner, Xerox Corporation has determined that (the basic configuration of) this product meets the ENERGY STAR guidelines for energy efficiency.

The ENERGY STAR and ENERGY STAR MARK are registered United States trademarks.

The ENERGY STAR Office Equipment Program is a team effort between U.S., European Union and Japanese governments and the office equipment industry to promote energy-efficient copiers, printers, fax, multifunction machine, personal computers, and monitors. Reducing product energy consumption helps combat smog, acid rain and long-term changes to the climate by decreasing the emissions that result from generating electricity.

Xerox ENERGY STAR equipment is preset at the factory to enter a "low power" state and/or shut off completely after a specified period of use. These energy-saving features can reduce product energy consumption in half when compared to conventional equipment.

## Canada



**Environmental Choice - Terra Choice Environmental Serviced, Inc. of Canada** has verified that this product conforms to all applicable Environmental Choice EcoLogo requirements for minimized impact to the environment.

As a participant in the Environmental Choice program, Xerox Corporation has determined that this product meets the Environmental Choice guidelines for energy efficiency.

Environment Canada established the Environmental Choice program in 1988 to help consumers identify environmentally responsible products and services. Copier, printer, digital press and fax products must meet energy efficiency and emissions criteria, and exhibit compatibility with recycled supplies. Currently, Environmental Choice has more than 1600 approved products and 140 licensees. Xerox has been a leader in offering EcoLogo approved products.

## Europe

**Energy** - Xerox Corporation has designed and tested this product to meet the energy restrictions required to establish Group for Efficient Appliances (GEA) compliance and have notified the registration authorities.



## USA

Congress, by statute, has forbidden the reproduction of the following subjects under certain circumstances. Penalties of fine or imprisonment may be imposed on those guilty of making such reproductions.

- Obligations or Securities of the United States Government, such as:

Certificates of Indebtedness National Bank Currency

Coupons from Bonds Federal Reserve Bank Notes

Silver Certificates Gold Certificates

United States Bonds Treasury Notes

Federal Reserve Notes Fractional Notes

Certificates of Deposit Paper Money

Bonds and Obligations of certain agencies of the government, such as FHA, etc.

Bonds. (U.S. Savings Bonds may be photographed only for publicity purposes in connection with the campaign for the sale of such bonds.)

Internal Revenue Stamps. (If it is necessary to reproduce a legal document on which there is a canceled revenue stamp, this may be done provided the reproduction of the document is performed for lawful purposes.)

Postage Stamps, canceled or uncanceled. (For philatelic purposes, Postage Stamps may be photographed, provided the reproduction is in black and white and is less than 75% or more than 150% of the linear dimensions of the original.)

Postal money Orders.

Bills, Checks, or Draft of money drawn by or upon authorized officers of the United States.

Stamps and other representatives of value, of whatever denomination, which have been or may be issued under any Act of Congress.

- Adjusted Compensation Certificates for Veterans of the World Wars.
- Obligations or Securities of any Foreign Government, Bank, or Corporation.
- Copyrighted materials, unless permission of the copyright owner has been obtained or the reproduction falls within the "fair use" or library reproduction rights provisions of the copyright law. Further information of these provisions may be obtained from the Copyright Office, Library of Congress, Washington, D.C. 20559. Ask for Circular R21.

- Certificates of Citizenship or Naturalization. (Foreign Naturalization Certificates may be photographed.)
- Passports. (Foreign Passports may be photographed.)
- Immigration Papers.
- Draft Registration Cards.
- Selective Service Induction Papers that bear any of the following Registrant's information:

Earnings or Income

Dependency Status

Court Record

Previous military service

Physical or mental condition

Exception: United States military discharge certificates may be photographed.

- Badges, Identification Cards, Passes, or Insignia carried by military personnel, or by members of the various Federal Departments, such as FBI, Treasury, etc. (unless photograph is ordered by the head of such department or bureau.)
- Reproducing the following is also prohibited in certain states:  
Automobile Licenses - Drivers' Licenses - Automobile Certificates of Title.

The above list is not all inclusive, and no liability is assumed for its completeness or accuracy. In case of doubt, consult your attorney.

## **Canada**

Parliament, by statute, has forbidden the reproduction of the following subjects under certain circumstances. Penalties of fine or imprisonment may be imposed on those guilty of making such reproductions.

- Current bank notes or current paper money.
- Obligations or securities of a government or bank.
- Exchequer bill paper or revenue paper.
- The public seal of Canada or of a province, or the seal of a public body or authority in Canada, or of a court of law.
- Proclamations, orders, regulations or appointments, or notices thereof (with intent to falsely cause same to purport to have been printed by the Queen's Printer for Canada, or the equivalent printer for a province).
- Marks, brands, seals, wrappers or designs used by or on behalf of the Government of Canada or of a province, the government of a state other than Canada or a department, board, Commission or agency established by the Government of Canada or of a province or of a government of a state other than Canada.

- Impressed or adhesive stamps used for the purpose of revenue by the Government of Canada or of a province or by the government of a state other than Canada.
- Documents, registers or records kept by public officials charged with the duty of making or issuing certified copies thereof, where the copy falsely purports to be a certified copy thereof.
- Copyrighted material or trademarks of any manner or kind without the consent of the copyright or trademark owner.

The above list is provided for your convenience and assistance, but it is not all-inclusive, and no liability is assumed for its completeness accuracy. In case of doubt, consult your solicitor.

### ***Other countries***

Copying certain documents may be illegal in your country. Penalties of fine or imprisonment may be imposed on those found guilty of making such reproductions.

- Currency notes
- Bank notes and cheques
- Bank and government bonds and securities
- Passports and identification cards
- Copyright material or trademarks without the consent of the owner
- Postage stamps and other negotiable instruments

This list is not inclusive and no liability is assumed for either its completeness or accuracy. In case of doubt, contact your legal counsel.

# Product Recycling and Disposal

If you are managing the disposal of your Xerox product, please note that the product contains lead, mercury, and other materials whose disposal may be regulated due to environmental considerations in certain countries or states. The presence of lead and mercury is fully consistent with global regulations applicable at the time that the product was placed on the market.

## ***European Union:***

Some equipment may be used in both a domestic/household and a professional/ business application.

### ***Domestic/Household Environment***



Application of this symbol on your equipment is confirmation that you should not dispose of the equipment in the normal household waste stream.

In accordance with European legislation end of life electrical and electronic equipment subject to disposal must be segregated from household waste.

Private households within EU Member States may return used electrical and electronic equipment to designated collection facilities free of charge. Please contact your local disposal authority for information.

In some Member States when you purchase new equipment your local retailer may be required to take back your old equipment free of charge. Please ask your retailer for information.

### ***Professional/Business Environment***



Application of this symbol on your equipment is confirmation that you must dispose of this equipment in compliance with agreed national Procedures.

In accordance with European legislation end of life electrical and electronic equipment subject to disposal must be managed within agreed procedures.

Prior to disposal please contact your local dealer or Xerox representative for end of life take back information.

## **North America**

Xerox operates an equipment takeback and reuse/recycle program. Contact your Xerox sales representative (1-800-ASK-XEROX) to determine whether this Xerox product is part of the program. For more information about Xerox environmental programs, visit [www.xerox.com/environment](http://www.xerox.com/environment) or for recycling and disposal information, contact your local authorities. In the United States, you may also refer to the Electronic Industries Alliance web site: [www.eiae.org](http://www.eiae.org).

## **Other Countries**

Please contact your local waste authorities and request disposal guidance.



# 2 Getting Started

---

Before you start to use your machine, there are a number of tasks to perform. Using the instructions provided in this chapter, unpack and setup your machine.

- Unpacking . . . . . 2-2
- Machine Overview . . . . . 2-6
- Installing Drum and Toner Cartridges . . . . . 2-12
- Making Connections . . . . . 2-14
- Powering On the Machine . . . . . 2-16
- Loading Paper . . . . . 2-17
- Machine Setup . . . . . 2-20
- Installing Software . . . . . 2-24

# Unpacking

## 1

- Remove the shipping tape from the front, back and sides of the machine.

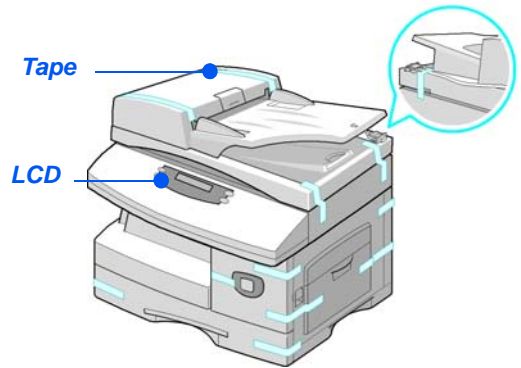

## 2

- To scan or copy a document, the switch must be in the unlock position. If the machine is not being used for a long period of time, or being moved, push the switch to the lock position (🔒).

- Remove the label completely from the scanner module by pulling it straight out, away from the unit.

Make sure that the scan lock has been moved to the unlock position (🔓).

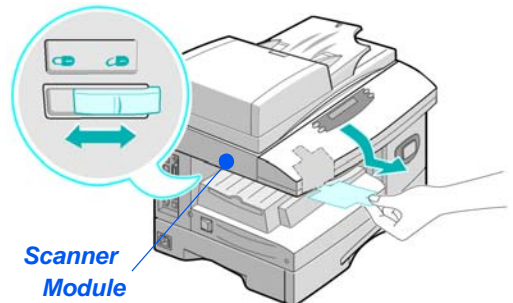

## 3

- Pull open the paper tray and remove the packing material from the tray.

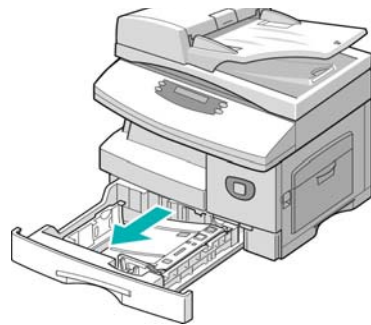



# 4

- The appearance of the power cord and the telephone line cord may vary according to Country.

- Ensure the following components are available:

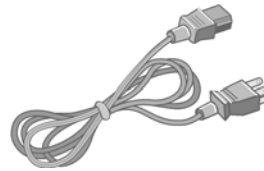

**AC Power Cord**



**User Documentation**

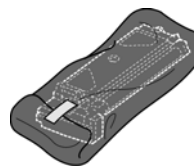

**Starter Toner Cartridge**

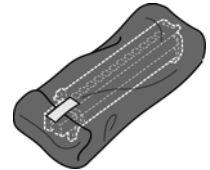

**Drum Cartridge**

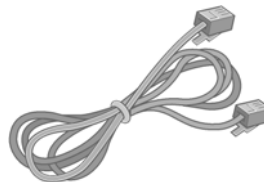

**Telephone Line Cord**

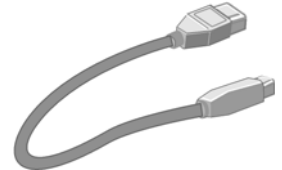

**USB Cable**

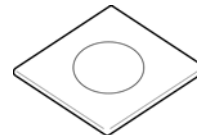

**Software**

## CD Contents

### **User Guide CD**

- The User Guide provides detailed information, technical specifications and procedural step by step instructions on all the features available.

## Drivers CD

- This CD contains the print drivers, TWAIN driver and ControlCentre software available for your machine.
- Print Drivers are available for Windows 98, NT, 2000, ME and XP. Print Drivers are available in PCL5e emulation, PCL6.
- The TWAIN Driver is the interface between your machine and the image manipulation software. TWAIN Driver available for Windows 98, NT, 2000, ME and XP.
- The WIA Driver allows you to scan and manipulate images without using additional software (XP only).
- The ControlCentre software allows you to set the machine's fax number and phonebook entries. Also use ControlCentre to upgrade the machine's firmware.

## Nuance CD

- This CD contains the PaperPort SE 10.0 and OmniPage 4.0 SE software available when scanning from your machine. You will receive 1 CD containing different languages.
- PaperPort SE 10.0 is image manipulation software that has a variety of features.
- OmniPage 4.0 SE is an Optical Character Recognition (OCR) software that converts the scanned image into editable text documents.

**IMPORTANT RESTRICTION:** THE FOLLOWING PROVISION FORMS PART OF THE LEGALLY BINDING AGREEMENT UNDER WHICH YOU ARE LICENSED TO USE THE SOFTWARE CONTAINED IN THIS PACKAGE. BY INSTALLING, COPYING OR USING THE SOFTWARE, YOU AGREE TO BE LEGALLY BOUND BY THE FOLLOWING. IF YOU DO NOT AGREE WITH THE FOLLOWING, DO NOT INSTALL, COPY OR USE THE SOFTWARE:

**This package contains multiple language versions of [PaperPort 10 SE; OmniPage SE v4.0; Image Retriever]. This software is licensed on a single Seat basis only; that is, the software (regardless of language version) may only be used by you on or from a single Seat. A "Seat" means each computer (a) on which the software or a portion of the software is either installed or run, or (b) from which the software is accessed.**

## CD Installation

Insert the appropriate CD into your CD-ROM drive. Use the instructions below to run the required CD.

### **User Guide CD**

- 1** ➤ The program is designed to Autorun. If this is not enabled double-click on the run.exe file on the CD.
- 2** ➤ Select your preferred language.

### **Drivers CD**

- 1** ➤ The program is designed to Autorun. If this is not enabled double-click on the **Xinstall.exe** file on the CD.
- 2** ➤ Follow the instructions in the wizard to install the required application. Multiple applications can be installed on your PC.



Refer to "Installing Drivers" on page 2-24 for further information.

---

### **Nuance CD**

The program is designed to Autorun. If this is not enabled double-click on the **install.exe** file on the CD.

# Machine Overview

## Models and Options

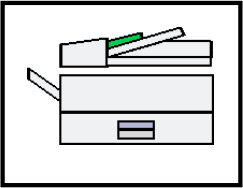
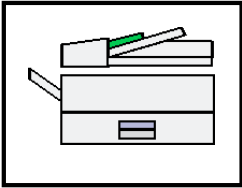
	<i>WorkCentre 4118 (2 in 1)</i>	<i>WorkCentre 4118 (4 in 1)</i>
		
<b>Document Feeder</b>	Option	Standard
<b>Paper Tray 1 &amp; Bypass Tray</b>	Standard	Standard
<b>Digital Copying</b>	Standard	Standard
<b>Direct Printing</b>	Standard	Standard
<b>Network Printing</b>	Option	Option
<b>Direct Scanning</b>	-	Standard
<b>Fax</b>	-	Standard
<b>Paper Tray 2</b>	Option	Option
<b>Cabinet and Stand</b>	Option	Option
<b>Foreign Interface</b>	Option	Option

# Component Location

## Front View:

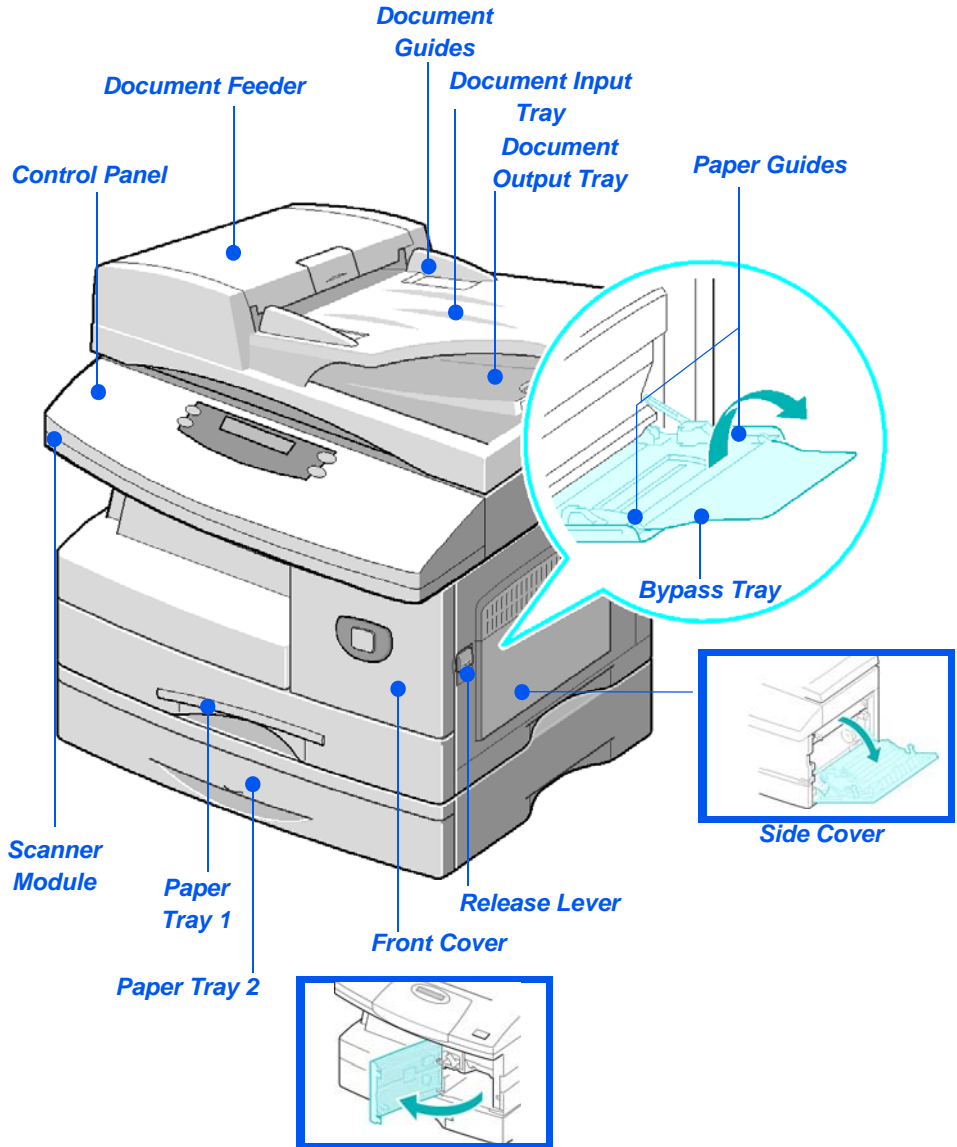

**NOTE:** The components on each model vary, this picture represents the WorkCentre 4118 with the optional Paper Tray 2.

**Rear View:**

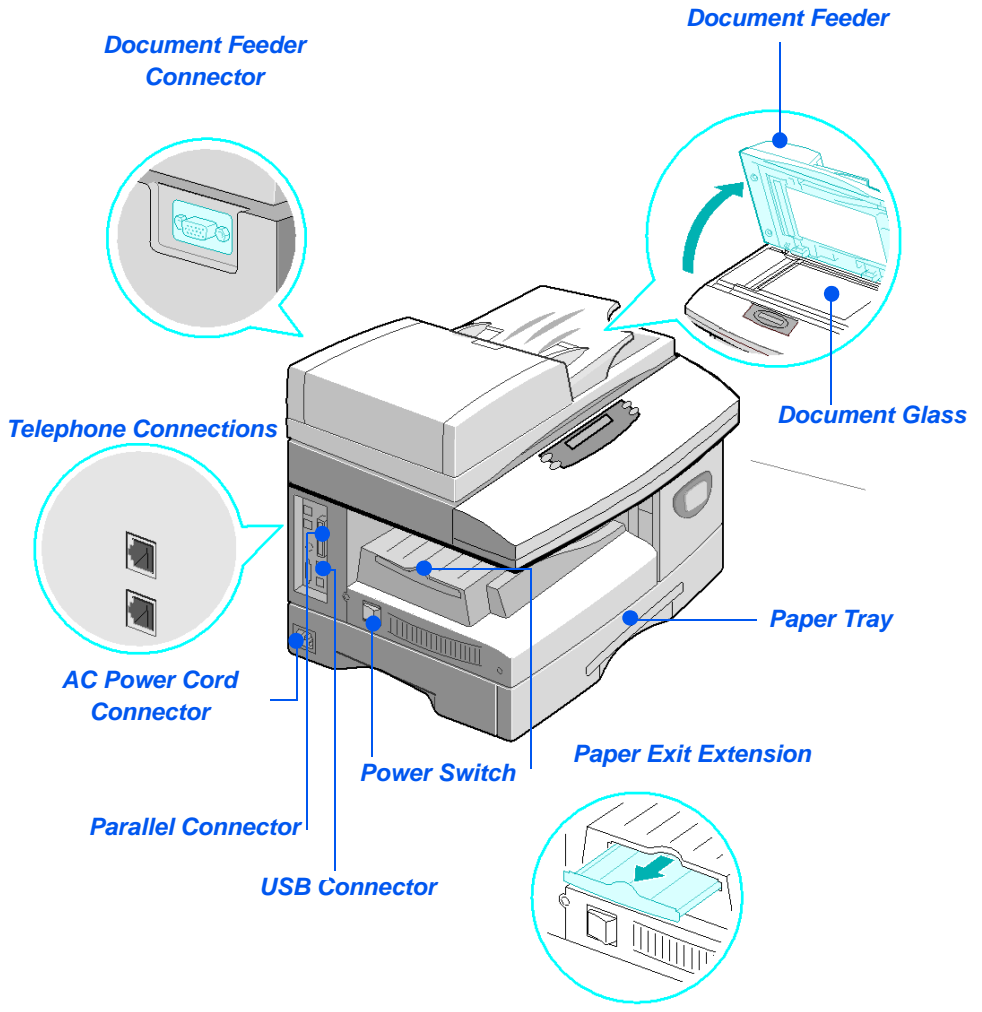

---

**NOTE:** The components on each model vary, this picture represents the WorkCentre 4118, standard configuration.

---

## Control Panel Overview

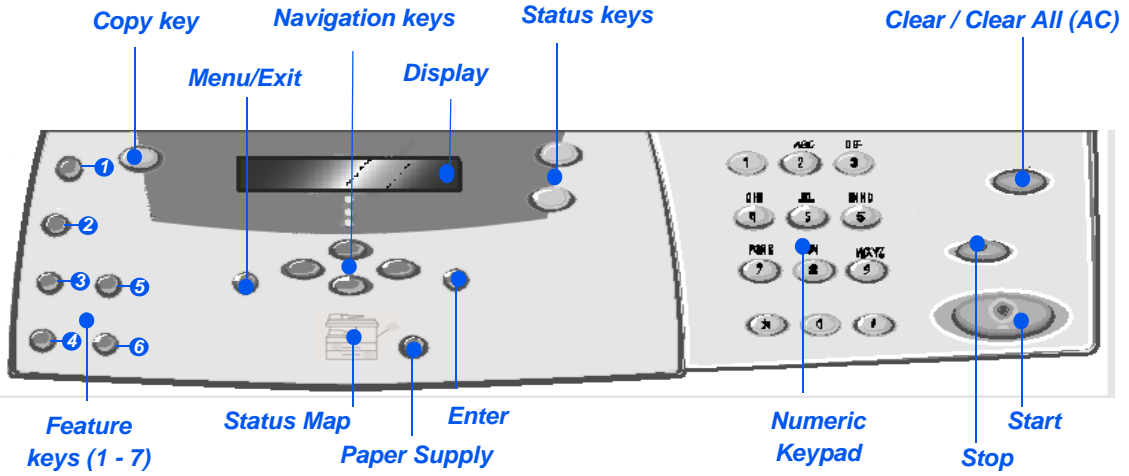



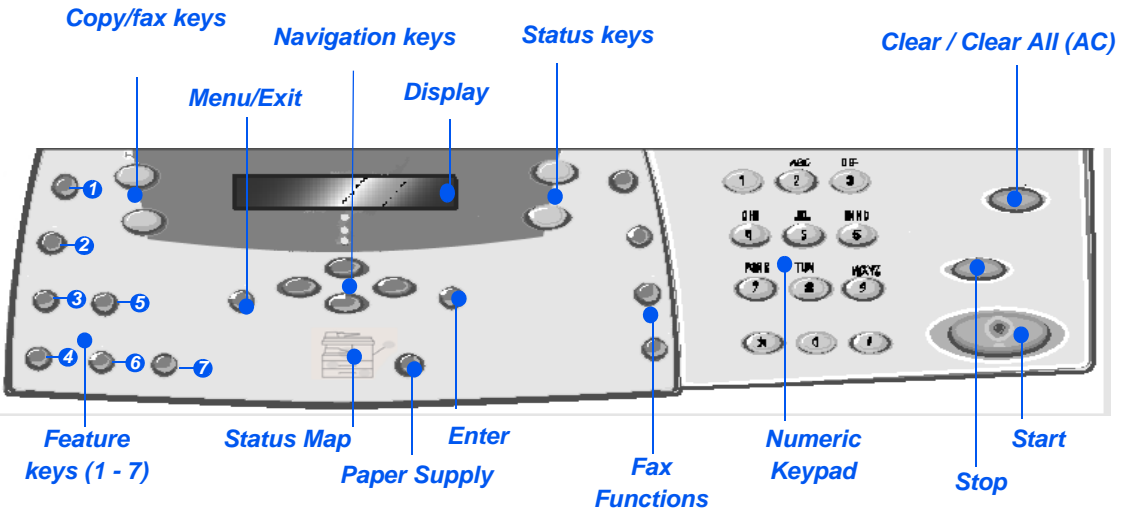





**2 in 1 Control panel**



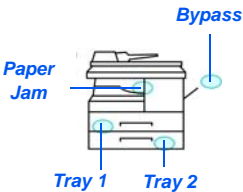

**4 in 1 Control panel**

ITEM	DESCRIPTION
① <b>Lighten/Darken</b>	Use to adjust the contrast level to improve output quality.
② <b>Reduce/Enlarge</b>	Use to adjust copy size from 25% to 400% when using the <i>Document Glass</i> , and 25% to 100% using the <i>Document Feeder</i> .

 <b>1-2 Sided</b>	Use to scan 1 Sided originals and produce 2 Sided output.
 <b>Collated</b>	Use to produce collated output.
 <b>Original Type</b>	Used to select the type of original being scanned.
 <b>Color Original</b>	Use this option when scanning a color original.
 <b>Resolution</b>	Use to adjust the scan resolution (4 in 1 only).
<b>Copy</b>	Select to activate the <i>Copy</i> mode. The <i>Copy</i> key illuminates when selected.
<b>Fax</b>	Select to activate the <i>Fax</i> mode. The <i>Fax</i> key illuminates when selected (4 in 1 only).
<b>Menu/Exit</b>	Use to access the menu functions and also to move up through the menu levels.
<b>Enter</b>	Use to confirm the selection on the display.
<b>Navigation Keys</b> 	Use to scroll through the menu items and the options available for each menu item.
<b>Paper Supply</b>	Use to select a paper type and source. Each press of the <i>Paper Supply</i> key changes the selection. The <i>Status Map</i> indicates the selected tray. <hr/> <b>NOTE:</b> <i>Paper Tray 2 is available as an option.</i> <hr/>
<b>Status Map</b> 	<p>The <i>Status Map</i> identifies which paper tray is selected, when a paper tray is empty and when an error occurs.</p> <p>The <i>Status Map</i> has a light for each paper tray. A paper tray can be selected using the <i>Paper Supply</i> key. Each time the key is pressed, a different tray is selected and a green light displays to indicate the selected tray. When two tray lights display together, the <i>Auto Tray Switching</i> feature is active. This enables the machine to switch to a different tray if the current tray runs out of paper.</p> <p>If a paper tray is empty, the light will flash and if enabled, an error tone will sound.</p> <p>If an error occurs, a red light displays and a message appears on the display providing further information.</p> <hr/>  For a detailed description of the error messages, refer to "LCD Error Messages" on page 10-11. <hr/>



<b>Display</b>	Displays the current status and the menu prompts and selections.
<b>Job Status</b>	Use to view the current job status, add pages to jobs in memory and to delete jobs.
<b>Machine Status</b>	Use to access setup menus and customize the machine.
<b>Manual Group</b>	Use to manually enter multiple destinations for a fax job (4 in 1 only).
<b>Manual Dial</b>	Use to dial a fax number manually (4 in 1 only).
<b>Speed Dial</b>	Use to dial fax numbers and send faxes by entering a <i>Speed Dial</i> number which has been set up previously and stored in the machine's <i>Dial Directory</i> (4 in 1 only).
<b>Pause/Redial</b>	Use to redial the last phone number called or to add a pause when storing a number in the dial directory (4 in 1 only).
<b>Numeric Keypad</b>	Use to enter alphanumeric characters.
<b>Start</b> 	Use to activate a job.
<b>Stop</b> 	Use to stop an operation at any time.
<b>Clear/Clear All (AC)</b>	Press once to clear a current entry e.g. an incorrect number or character entry. Press twice to clear all programmed settings, the display requests confirmation.

# Installing Drum and Toner Cartridges

- 1** ➤ Pull the release latch to open the side cover.

**CAUTION:** Ensure the side cover is always open before opening the front cover.



- 2** ➤ Open the front cover.

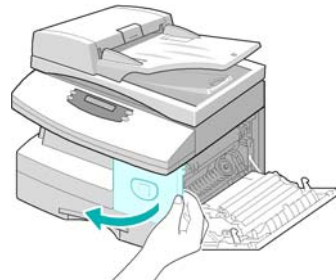

- 3** ➤ If the cartridge locking lever is in the lower position, turn the lever upward until it locks into place.

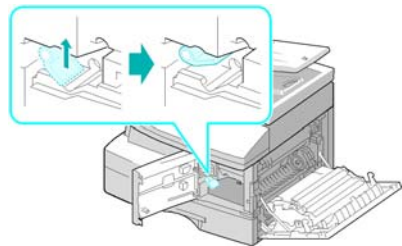

4

- Remove the drum cartridge from its bag and slide it into the machine firmly until it locks into place.

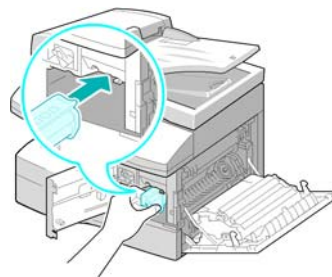

**CAUTION: Do not expose the green drum to light for an extended period. Never expose the drum to direct sunlight or touch the drum surface. Damage or poor image quality may result.**

5

- Xerox has included a Starter Toner Cartridge. Purchased replacement toner cartridges will yield approximately two times the number of copies.

- Remove the starter toner cartridge from its bag.
- Gently shake the cartridge to loosen the toner.

Shaking the cartridge will ensure maximum copies per cartridge.

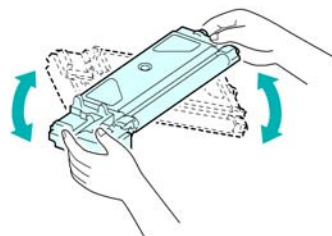

6

- Slide the toner cartridge into the machine, aligning the cartridge to the left of the slot, until it locks into place.

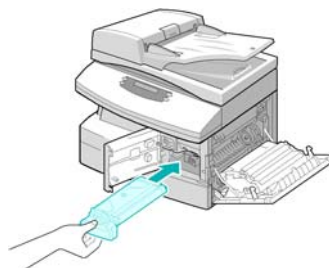

7

- When the drum or toner cartridge need to be replaced a message displays.

- Turn the cartridge locking lever downwards until it locks in place.
- Close the front cover and the side cover.

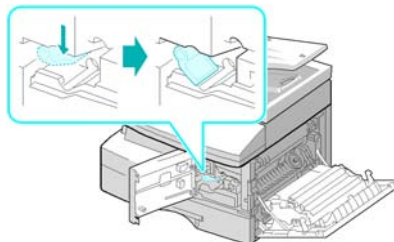

# Making Connections

**1**

## Document Feeder

- Connect the *Document Feeder* cord to the port shown and fasten the side screws.

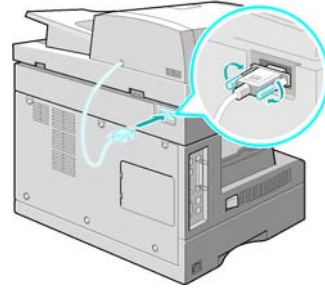
**2**

## Telephone Line (WorkCentre 4118, 4 in 1 only)

- You should use the telephone line cord which is supplied with your machine. If you are replacing it with another vendor's, it should be AWG #26 or larger telecommunication line cord.

- Connect the supplied telephone line to the *LINE* jack and the other end to the wall jack.

If you want to use your machine for receiving both faxes and voice calls, you will need to connect a telephone and/or answering machine.

- If required, plug the cord of your extension phone into the *EXT* jack.

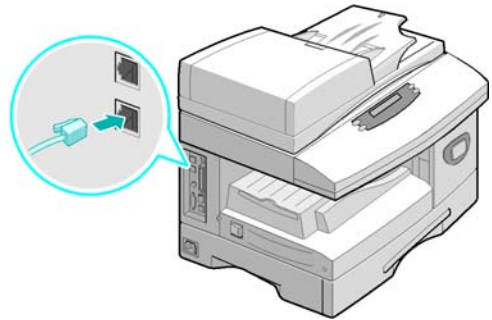

### 3 USB or Parallel Port Cable

**CAUTION:** Shut down the computer before connecting the cable.

- Connect the *USB Cable* which came with your machine.

**OR**

- If you want to use a parallel print cable, only use an IEEE-1284 compliant cable and connect it to the parallel connector on your machine.

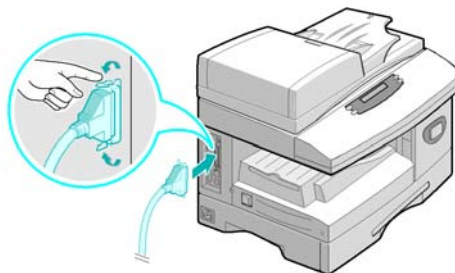
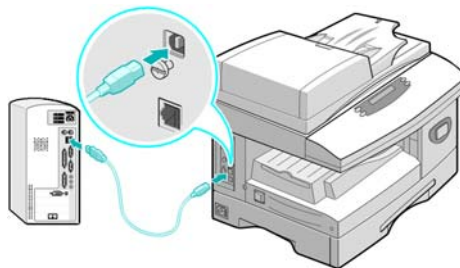

 Only connect one of the above cables. If you are using a USB cable, you must be running Windows 98, Me, 2000 or XP. When using the USB connection, your machine provides two USB modes; Fast and Slow. Fast is the default mode. Some PC User's may experience poor functionality in the default mode. If this occurs, select the Slow mode. For information about changing the USB mode, refer to "Machine Setup" on page 2-20.

# Powering On the Machine

**1**

- Connect the *AC Power Cord* to the machine and a power outlet.

The power cord must be plugged into a grounded power socket.

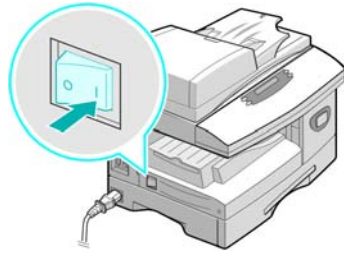
**2**

- Press the *ON/OFF* switch to the ON ( I ) position.

The machine displays 'Warming Up Please Wait...'.  
'

# Loading Paper

## 1

- An additional Paper Tray is available as an option. The instructions for loading both paper trays are the same.

- Pull open the Paper Tray.

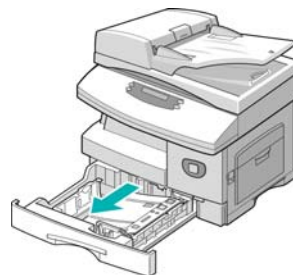

## 2

- Push down on the pressure plate until it locks into position.

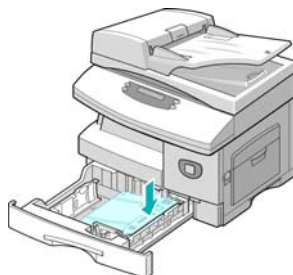

## 3

- Adjust the rear paper guide to the required paper length.

It is preset to A4 or Letter size depending on country.

- To load another size, lift the rear guide out of the current position and into the required position.

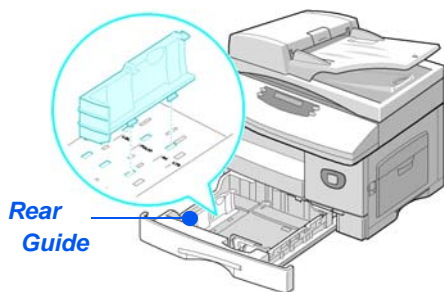

- 
- ① *The Paper Trays can hold a maximum of 550 sheets of 80 g/m<sup>2</sup> (20 lb) plain paper. You can use A4, Folio, Letter or Legal size paper only.*
-

**4**

- If you experience problems with paper feed, turn the paper around and if the problem continues, use the Bypass Tray.

- Fan the paper and insert it into the tray.

If loading Letterhead, ensure the design is face-up and the top edge of the sheet is placed at the right side.

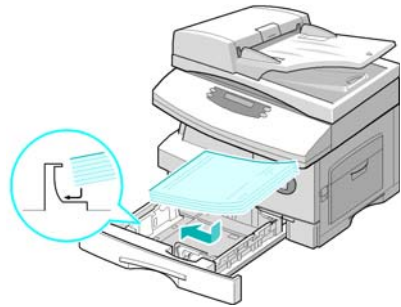
**5**

- Ensure that the paper is positioned under the snubbers.

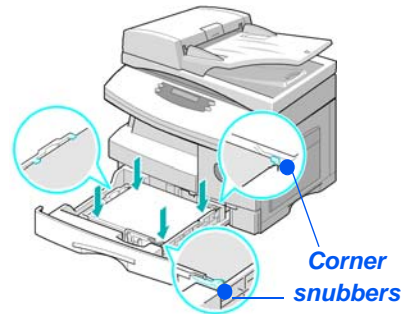

- Do not fill above the *Maximum Fill Line*.

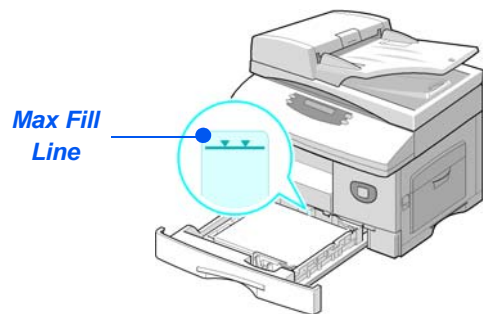



**6**

- When printing from your PC, ensure you select the Paper Source and the correct paper size from your software application.

- Position the side guide by squeezing the lever and sliding it toward the stack of paper, until it gently touches the side of the stack.

Do not allow the guide to press against the edge of the paper tightly.

- Close the Paper Tray.

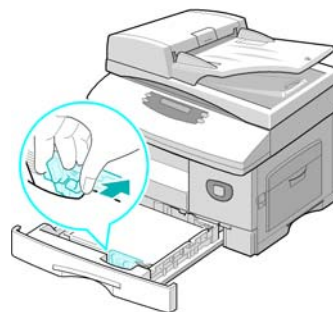

Refer to "Machine Setup" starting on page 2-20 to set the correct size for the Paper Tray. For more detailed information about Paper Supply, refer to the Chapter "Paper and Other Media" starting on page 4-1.

# Machine Setup

Use the following instructions to customize your machine to meet your individual requirements.

- 1 ➤ Press the [Machine Status] key.

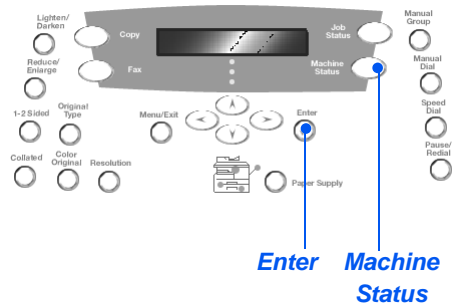

- 2 ➤ Using the *Navigation Keys* select [Machine Setup] and press [Enter].
- 3 ➤ Using the *Navigation Keys* select the required setup option and press [Enter].
  - Using the “*Machine Setup Options*” starting on page 2-21 customize the settings to meet your requirements.
  - Press [Enter] to save your selections.
- 4 ➤ Press [Menu/Exit] to exit each menu level and return to standby mode.

## Machine Setup Options

OPTION	SETTINGS	DESCRIPTION
Tray 1 Size	<i>LTR / A4 / LGL / Folio</i>	Use to set the default paper size for <i>Tray 1</i> . <i>Paper Size</i> options are Letter, A4, Legal (216 x 356 mm / 8.5 x 14 inch) or Folio.
Tray 2 Size	<i>LTR / A4 / LGL / Folio</i>	Use to set the default paper size for <i>Tray 2</i> . <i>Paper Size</i> options are Letter, A4, Legal (216 x 356 mm / 8.5 x 14 inch) or Folio.
Bypass Size	<i>LTR / A4 / LGL / Folio / A5 / Statement</i>	Use to set the default paper size for the <i>Bypass Tray</i> . <i>Paper Size</i> options are Letter, A4, Legal (216 x 356 mm / 8.5 x 14 inch), Folio, A5 or Statement.  <hr/> <p>① <i>If feeding media smaller than A4/Letter through the bypass tray, the setting can remain set at A4, Letter or Legal size.</i>  <i>When copying onto a paper size smaller than A4/Letter, the printed image may be offset and not reproduce correctly, even when Auto Fit is selected.</i></p> <hr/>
Collated	<i>On</i>	Use to produce sets in the order 1,2,3 / 1,2,3 / 1,2,3.
	<i>Off</i>	Use to produce stacks in the order 1,1,1 / 2,2,2 / 3,3,3.
Power Save	<i>On</i>	Use to enable the <i>Power Save</i> feature. If <i>On</i> is selected, set the period of time the machine waits before <i>Power Save</i> is activated. Choose between 15, 30, 60, 120 minutes.
	<i>Off</i>	
Machine Time Out	<i>15 / 30 / 60 / 180 Seconds</i>	Sets the number of seconds the machine remains idle before the current job settings are reset back to the default settings. Use <i>Off</i> to deactivate the option.
	<i>Off</i>	
Stamp RX Name	<i>On</i>	Set to <i>On</i> to enable sender information, the machine ID, the page number, the date and time of reception and the reduction rate of the image to be printed on each page of each received transmission. The information is printed on the bottom edge of each page.
	<i>Off</i>	

OPTION	SETTINGS	DESCRIPTION
Alarm Sound	<i>On</i>	Set to <i>On</i> to enable an alarm sound when an error occurs or a fax communication ends.
	<i>Off</i>	
Key Sound	<i>On</i>	Set to <i>On</i> to enable a sound when any key is pressed.
	<i>Off</i>	
Speaker Control	<i>Low</i>	The speaker can be set to <i>Low</i> , <i>Medium High</i> or <i>Off</i> .
	<i>Med</i>	
	<i>High</i>	
	<i>Off</i>	
Language	<i>English, French, German, Italian, Spanish, Brazilian Portuguese, Dutch, Danish, Swedish, Finnish, Norwegian, Russian</i>	The display uses the language selected.
Localization	<i>Inch</i>	Use to set whether measurements are displayed and entered in inches or millimeters.
	<i>MM</i>	
Select Country	<i>UK, Greece, Turkey, Ukraine, Slovenia, Russia, Yugoslavia, Australia, Hong Kong, New Zealand, South Africa, Israel, Korea, K.Xerox, China, India, Asia_STD, Malaysia, Singapore, USA/Canada, Brazil, Chile, Columbia, Mexico, Argentina, Peru, Germany, France, Austria, Switzerland, Italy, Spain, Portugal, Norway, Finland, Sweden, Netherlands, Denmark, Belgium, Hungary, Poland, Czech, Romania, Bulgaria, Ireland</i>	Setting the <i>Country</i> option sets the correct fax communication settings for each country.
USB Mode	<i>Fast</i>	Use to set the <i>USB</i> speed. <i>Fast</i> is the default mode. Some PC users may experience poor <i>USB</i> implementation in the default mode. If this occurs, select <i>Slow</i> .
	<i>Slow</i>	
Machine ID	<i>Fax</i>	Use to enter the fax number and name of the machine.
	<i>Name</i>	

OPTION	SETTINGS	DESCRIPTION
<b>Date &amp; Time</b>		Enter the current date and time using the <i>Numeric Keypad</i> . Use <i>Clock Mode</i> to set whether the machine uses a 12 or 24 hour clock.
<b>Clock Mode</b>	<i>12 hour</i>	The machine can be configured to display time using either a 12-hour or 24-hour format.
	<i>24 hour</i>	
<b>Toner Save</b>	<i>On</i>	If <i>On</i> , the machine produces a lower quality output to reduce toner consumption. Useful if your machine is used for internal documents only.
	<i>Off</i>	
<b>Discard Size</b>	<i>[00 - 30]</i>	<p>If the <i>Fax Setup</i> option <i>Auto Reduction</i> is set to <i>Off</i>, and the received document is as long or longer than the paper selected, the machine will discard any excess image from the bottom of the page that is longer than the selected length.</p> <p>If the received page is outside the discard margin set, it will print on two sheets of paper at the actual size. Margins can be set between 0 - 30mm (1.2").</p>

# Installing Software

## Installing Drivers

### Programs for Windows

To use your machine as a printer and scanner in Windows, you must install the MFP driver. You can install some or all the following components:

- **Printer driver** - Use this driver to take full advantage of your printer's features. The PCL Print driver is standard. The PostScript driver is available with the optional Network Kit.
- **Scan driver** - TWAIN and Windows Image Acquisition (WIA) driver is available for scanning documents on your machine (4 in 1 only).
- **ControlCentre** - Use this program to create phonebook entries (4 in 1 only), edit printer settings and upgrade machine firmware.

### Macintosh Driver

You can print and scan to and from Macintosh operating systems using your machine. This driver is available with the optional Network Kit.

### Linux Driver

You can print and scan to and from Linux operating systems using your machine. This driver is available with the optional Network Kit.

## System Requirements

Your machine supports the following operating systems.

### Windows 98/Me/NT 4.0/2000/XP

The following table shows Windows requirements.

ITEM	REQUIREMENTS		RECOMMENDED
CPU	Windows 98/Me/NT 4.0/2000	Pentium II 400 MHz or higher	Pentium III 933 MHz
	Windows XP	Pentium III 933 MHz or higher	Pentium IV 1 GHz

ITEM	REQUIREMENTS		RECOMMENDED
RAM	Windows 98/Me/NT 4.0/2000	64 MB or higher	128 MB
	Windows XP	128 MB or higher	256 MB
Free disk space	Windows 98/Me/NT 4.0/2000	300 MB or higher	1 GB
	Windows XP	1 GB or higher	5 GB
Internet Explorer	5.0 or higher		5.5

### **Macintosh**

Macintosh 10.3 or later - with Network Kit option

### **Linux**

Various Linux - with Network Kit option.

## **Installing Drivers in Windows**

All applications should be closed on your PC before beginning installation.

### **Installing Xerox Drivers in Microsoft Windows XP or Windows 2000 using the USB port**

- 1 Insert the *Xerox Drivers CD* into the CD-ROM drive.
- 2 When the language selection window appears, select the appropriate language.



- 3 ➤ Choose the appropriate radio button for the hardware selected and then click [Next].

- 4 ➤ Choose the components you want to install and then click [Next].



- 5 ➤ The confirmation screen summarizes your selections. Either Click [Back] to reselect or Click [Next] to install your selections.



- 6 ➤ When the setup has completed click [Finish].





- 7 ➤ Plug the *USB* cable into the *WorkCentre 4118* and connect it to your Personal Computer (PC).
- 8 ➤ The *Hardware Wizard* will search for and find the drivers. Follow the on screen instructions.

### ***Installing Xerox Drivers in Microsoft Windows XP, 2000, NT or Windows 98/ME using the Parallel port***

- 1 ➤ Plug the *Parallel* cable into the *WorkCentre 4118* and connect it to your PC. Start your PC and switch on the *WorkCentre 4118*.
- 2 ➤ Insert the *Xerox Drivers CD* into the CD-ROM drive. In Microsoft Windows click [Start] and then [Run]. Type [E:\Xinstall.exe], replacing "E" with the letter of your CD-ROM drive and click [OK].
- 3 ➤ When the language selection window appears, select the appropriate language.



- 4 ➤ Choose the appropriate radio button for the WorkCentre you have and select [Next].

- 5 ➤ Choose the components you want to install and then click [Next].



- 6 ➤ The confirmation screen summarizes your selections. Either Click [Back] to reselect or Click [Next] to install your selections.

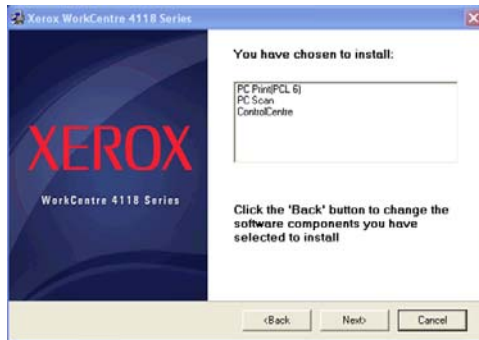

- 7 ➤ Click [Finish]. The driver installation is now complete.



## Installing Xerox Drivers in Microsoft Windows 98 or Windows Millennium using the USB port

- 1 ➤ Plug the *USB* cable into the *WorkCentre 4118* and connect it to your Personal Computer (PC). Start your PC and switch on the *WorkCentre 4118*.
- 2 ➤ Insert the *Xerox Drivers CD* into the CD-ROM drive.
- 3 ➤ The *Add New Hardware Wizard* will display. Click [Next].
- 4 ➤ Confirm that the radio button *Search for the best driver for your device* is chosen. Click [Next].
  - i In Windows Millennium (ME) the add Hardware Wizard will search and find the scan driver. Click [Finish] when this process is complete. Windows ME will then display the *Add New Hardware Wizard* for the print driver, click [Next]. Click [Finish] when this process is complete. The drivers are installed and you can skip to step 9.
  - ii In Windows 98 you must specify the location. Browse to the CD-ROM drive and the "Usb" folder on the CD and click [OK]. Click [Next] when prompted then [Finish]. The *USB composite driver* is then loaded.

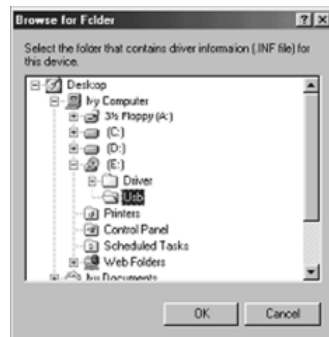

- 5 ➤ The *Add New Hardware Wizard* will display. Click [Next] to install the *USB* hardware driver for the *WorkCentre 4118*.
- 6 ➤ You must specify the location. Browse to the CD-ROM drive and the "Usb" folder on the CD and click [OK]. Click [Next] when prompted then click [Finish].

The *USB* hardware driver for the *WorkCentre 4118* is now loaded.
- 7 ➤ The *Add New Hardware Wizard* will display. Click [Next] to install the *Scan* driver for the *WorkCentre 4118*.

- 8 ➤ Again, you must specify the location. Browse to the CD-ROM drive and the *Driver* folder on the CD. Then click the scan directory and then the Win98ME directory and click [OK]. Click [Next] when prompted then click [Finish].

The scan driver for the *WorkCentre 4118* is now loaded.

- 9 ➤ In Microsoft Windows click [Start] and then [Settings] and then [Printers]. Double-click the [Add Printer] icon.

- 10 ➤ The *Add Printer Wizard* will begin. Click [Next]. Choose *Local Printer* and click [Next].



- 11 ➤ At the next screen click [Have Disk], and browse to your CD-ROM drive. Open the *Driver* directory, then open the *Print* directory, then open the *AddPrint* directory and then choose the *Win9x* directory and click [OK].

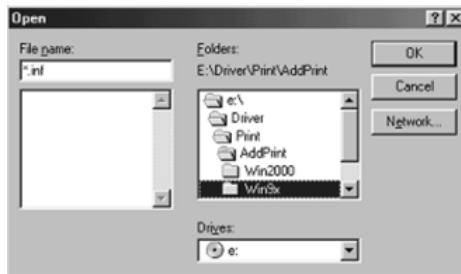

- 12 ➤ The next screen will display the *Xerox WorkCentre 4118* driver, click [Next].

- 13 ➤ Click the port that the printer cable is attached to, in this case *USB* and click [Next].

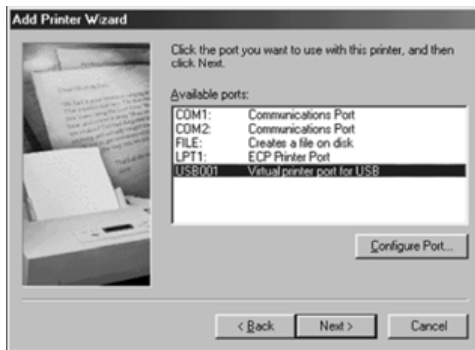

- 14 ➤ You can type in a name for your new printer or accept the default then click [Next].

- 15 ➤ Choose [Yes] to print a test page and click [Finish].

The *WorkCentre 4118* driver will now be installed and a test page should print.

## Test Print or Scan

To ensure the *WorkCentre 4118* has been installed correctly a test print or scan should be submitted from the *Workstation*. Use the following instructions to send a test print or scan.

### Test Print

- 1 Open a document on the *Workstation*.
- 2 Select the *Xerox WorkCentre 4118* as the printer to which the document will be sent.
- 3 Print the selected document on the device and verify that it prints correctly.  
The installation process is now complete.

### Test Scan

- 1 Open the Twain compliant application being used to scan documents.
- 2 Follow the instructions provided in “*Scan (4 in 1 only)*” starting on page 7-1 to scan a document and verify that it scans correctly.  
The installation process is now complete.

# 3 Copy

---

Digital copying is available as standard on the *Xerox WorkCentre 4118*.

- Copying Procedure . . . . . 3-2
- Basic Copy Features . . . . . 3-6
- Special Copy Features . . . . . 3-9
- Compatible Features . . . . . 3-13

# Copy Procedure

## 1 Select Copy Mode

- Ensure *Ready to Copy* displays.

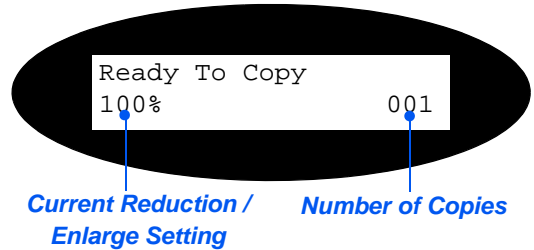

- If necessary, press the [Copy] key to change to *Copy* mode.

The *Copy* key remains illuminated when selected.

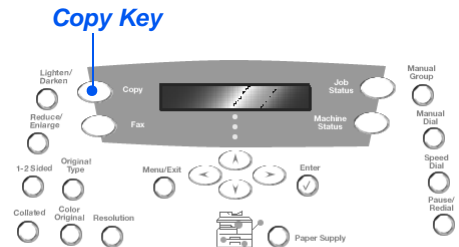

## 2 Select the Paper Supply

- For instructions on loading media, refer to "Loading Paper" on page 4-2.

For full media specifications refer to "Media Specifications" on page 11-7.

- To select a paper tray, press the [Paper Supply] key until the required tray is lit on the *Status Map*.

Tray 1 and the *Bypass Tray* are available as standard, Tray 2 is optional.

If two tray lights display together, the *Auto Tray Switching* feature is active. When one tray runs out of paper, the machine will switch to the other selected tray.

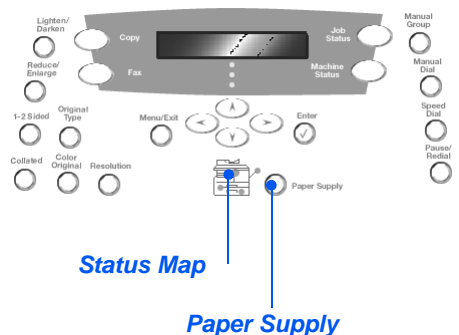





When copying onto a paper size smaller than A4/Letter, the printed image may be offset and not reproduce correctly, even when Auto Fit is selected.

- If the *Bypass Tray* is selected the *Paper Type* option displays. Use the *Navigation Keys* to select the *Paper Type* being loaded and press [Enter].

If using the *Bypass*, remember to load the required stock.

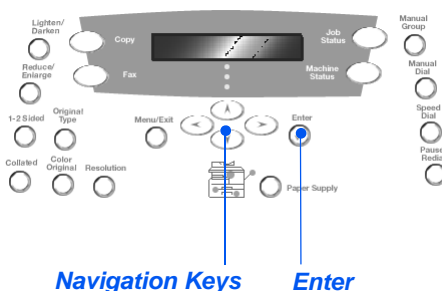

### 3

## Load the Originals

### Document Feeder: (optional on the 2 in 1)

- Remove all staples and paper clips prior to loading.
- Adjust the sliding document guides to the size required.
- Insert the originals neatly into the *Document Feeder*, face up.

The first page should be on top with the headings towards the back or left of the machine.

- Align the stack with the left and rear edges of the tray. Adjust the guides to just touch the edges of the originals.

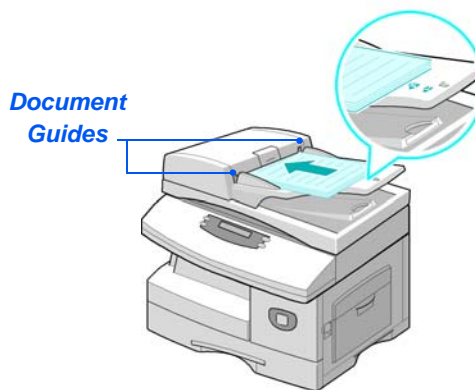

① Up to 40 sheets of 80 g/m<sup>2</sup> (20lb bond) paper can be loaded. Weight ranges from 45 - 105 g/m<sup>2</sup> (12.5 - 28lb). Sizes range from B5 to Legal (7" x 10" to 8.5" x 14"). Refer to "Scanner and Copier Specifications" on page 11-5 for full Document Feeder specifications.

## Document Glass:

- When using the Document Glass, ensure there are no documents in the Document Feeder.
- Raise the Document Feeder or Document Cover and position the original face down on the Document Glass.

Leaving the Document Feeder open while scanning will affect the image quality and toner consumption.

Align with the registration arrow in the rear left corner.

- Lower the Document Feeder or Document Cover.

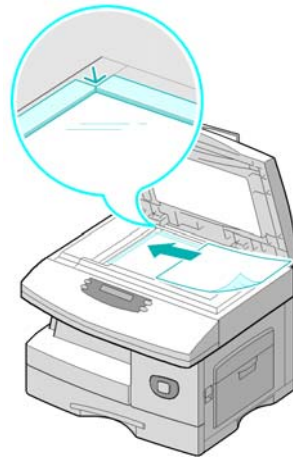

## 4

## Select the Copy Features

- Only those features relevant to the machine configuration will be available.
  - Press the Copy feature key required on the Control Panel.
- Basic features available for Copy jobs are *Lighten/Darken*, *Reduce/Enlarge*, *1-2 Sided*, *Collated*, *Original Type* and *Color Original*.



For information about all the available Copy features, refer to "Basic Copy Features" on page 3-6, and "Special Copy Features" on page 3-9.

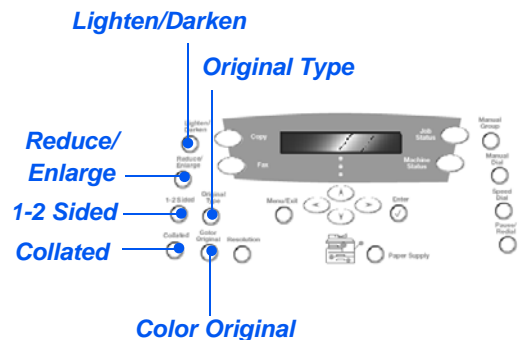

- Using the Navigation Keys, select the setting required for the feature and press [Enter].

## 5 Enter the Quantity

- The maximum copy quantity is 999.
- Use the *Numeric Keypad* to enter the number of copies required.
- If necessary, press [Clear/Clear All] to clear the current quantity and enter a new quantity.

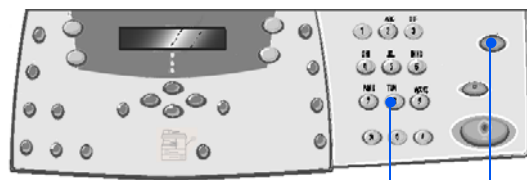

*Numeric Keypad*  
*Clear/Clear All*

## 6

### Press Start

- You can cancel a copy job while it is copying by pressing the [Stop] key twice.
- Press [Start] to begin the copy job.
- If the *Document Glass* is used and *Collated* is *On*, and a quantity higher than 1 has been entered, the [Scan Another?] option displays.
- To scan another original, load the next original and using the *Navigation Keys* select [Yes] and press [Enter].  
  
Continue the procedure until all the originals have been scanned.
- Select [No] when all the originals have been scanned, and press [Enter].  
  
Printing commences and copies are delivered to the *Output Tray*.

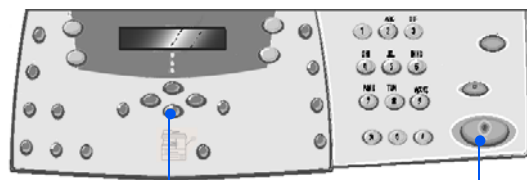

*Navigation Keys*

*Start*

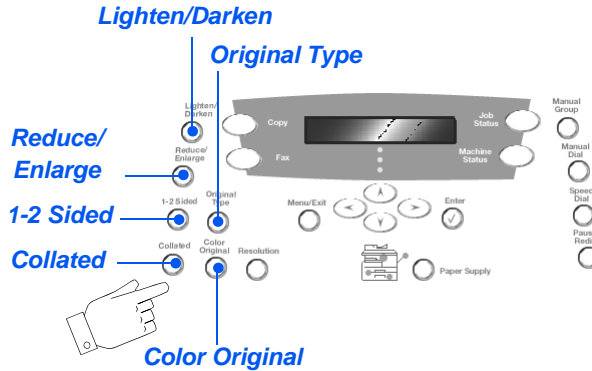

# Basic Copy Features

There are seven basic Copy features available. These features can be selected using the feature keys located on the *Control Panel*.



## Feature Description

FEATURE	OPTIONS	INSTRUCTIONS
<b>Lighten/Darken</b> <ul style="list-style-type: none"> <li>Use to adjust the contrast for a document containing faint or dark images.</li> </ul>	<b>5 Contrast Settings</b>	<ul style="list-style-type: none"> <li>Press [Copy].</li> <li>Press [Lighten/Darken].</li> <li>Using the <i>Navigation Keys</i> select a contrast setting.</li> </ul> <p>Each time the key is pressed the selection block on the display moves to the left or right. As the selection block moves to the right the contrast becomes darker.</p> <ul style="list-style-type: none"> <li>Press [Enter] to save the selection.</li> </ul>
<b>Reduce/Enlarge</b> <ul style="list-style-type: none"> <li>Use to reduce or enlarge an image from 25% to 400%, depending on the input area used.</li> </ul>	<b>25 - 400%</b> <p>Reduce/Enlarge from 25 - 400% using the <i>Document Glass</i>, and from 25 - 100% using the <i>Document Feeder</i>.</p>	<ul style="list-style-type: none"> <li>Press [Copy].</li> <li>Press [Reduce/Enlarge].</li> <li>Enter the percentage required using the <i>Numeric Keypad</i>. The selected number displays.</li> <li>Press [Enter] to save the selection.</li> </ul>

	<b>Clone</b>	<p>Use to print multiple images on a single sheet of paper. The number of images produced is determined automatically based on the original image size.</p> <ul style="list-style-type: none"> <li>• <i>Only available using the Document Glass, ensure the Document Feeder is empty.</i></li> </ul>	<ul style="list-style-type: none"> <li>➤ Press [Copy].</li> <li>➤ Press [Reduce/Enlarge].</li> <li>➤ Using the <i>Navigation Keys</i>, select [Clone] and press [Enter].</li> </ul> <p><i>Clone</i> displays.</p>
	<b>Auto Fit</b>	<p>Use to reduce or enlarge the image to fit the paper size automatically.</p> <ul style="list-style-type: none"> <li>• <i>Only available using the Document Glass, ensure the Document Feeder is empty.</i></li> </ul>	<ul style="list-style-type: none"> <li>➤ Press [Copy].</li> <li>➤ Press [Reduce/Enlarge].</li> <li>➤ Using the <i>Navigation Keys</i>, select [Auto Fit] and press [Enter].</li> </ul> <p><i>Auto Fit</i> displays.</p>
<p><b>1-2 Sided</b></p> <ul style="list-style-type: none"> <li>• <i>Use to produce 1 or 2 sided copy output from 1 sided originals.</i></li> </ul>	<b>1-1 Sided</b>	<p>Use when originals are printed on 1 side and 1-sided copies are required.</p>	<ul style="list-style-type: none"> <li>➤ Press [Copy].</li> <li>➤ Press [2 Sided].</li> <li>➤ Use the <i>Navigation Keys</i> to select the option required and press [Enter] to save the selection.</li> <li>➤ If necessary, use the [Scan Side 2] option to scan side 2. Position side 2 on the <i>Document Glass</i> and select [Yes] then [Enter] to scan side 2.</li> <li>➤ Continue the procedure until all the originals have been scanned.</li> <li>➤ Select [No] when all the originals have been scanned, and press [Enter].</li> </ul>
	<p><b>1-2 Sided Long</b></p> 	<p>Use when originals are printed on 1 side only and 2 Sided copies, with the conventional "head to head" layout are required.</p>	
	<p><b>1-2 Sided Short</b></p> 	<p>Use when originals are printed on 1 side only and 2 Sided copies, with the "head to toe" layout are required.</p>	
<p><b>Collated</b></p> <ul style="list-style-type: none"> <li>• <i>Use to produce collated copy sets.</i></li> </ul>	<b>On</b>	<p>Use to produce collated output e.g. 2 copies of a 3 page job will print one complete document, followed by the second complete document.</p>	<ul style="list-style-type: none"> <li>➤ Press [Copy].</li> <li>➤ Press [Collated].</li> <li>➤ Use the <i>Navigation Keys</i> to select [On] and press [Enter].</li> </ul>

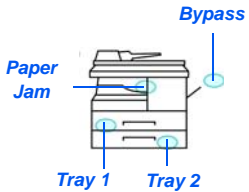
<b>Original Type</b> <ul style="list-style-type: none"> <li>Use to select the type of document being scanned.</li> </ul>	<b>Text</b>	Use for documents containing mostly text.	<ul style="list-style-type: none"> <li>Press [Copy].</li> <li>Press [Original Type].</li> <li>Use the <i>Navigation Keys</i> to select the option required and press [Enter].</li> </ul>
	<b>Mixed</b>	Use for documents with mixed text and graphics.	
	<b>Photo</b>	Use for photographs.	
<b>Color Original</b> <ul style="list-style-type: none"> <li>Use when scanning a color original.</li> </ul>	<b>On</b>	Use when scanning color originals.	<ul style="list-style-type: none"> <li>Press [Copy].</li> <li>Press [Color Original].</li> <li>Use the <i>Navigation Keys</i> to select [On] and press [Enter].</li> </ul>
<b>Paper Supply</b> <ul style="list-style-type: none"> <li>Use to select the paper source.</li> </ul>	<b>Status Map</b>	<p>The <i>Status Map</i> identifies which paper tray is selected, when a paper tray is empty and when an error occurs.</p>  <p>The diagram shows a top-down view of the paper tray area. On the left, there is a 'Paper Jam' indicator. Below it are two trays labeled 'Tray 1' and 'Tray 2'. On the right, there is a 'Bypass' indicator. Each indicator is represented by a small circle with a line pointing to it.</p>	<ul style="list-style-type: none"> <li>Press [Copy].</li> <li>To select a paper tray, press the [Paper Supply] key until the required tray is lit on the <i>Status Map</i>.</li> </ul> <p>The <i>Status Map</i> identifies which paper tray is selected, when a paper tray is empty and when an error occurs. The <i>Status Map</i> has a light for each paper tray.</p> <p>Each time the [Paper Supply] key is pressed, a different tray is selected and a green light displays to indicate the selected tray. When two tray lights display together, the <i>Auto Tray Switching</i> feature is active. This enables the machine to switch to a different tray if the current tray runs out of paper.</p> <p>If a paper tray is empty, the light will flash and if enabled, an error tone will sound.</p>
	<b>Bypass</b>	Use to notify the machine the type of paper loaded in the <i>Bypass Tray</i> .	<ul style="list-style-type: none"> <li>If the <i>Bypass Tray</i> is selected the <i>Paper Type</i> option displays. Use the <i>Navigation Keys</i> to select the <i>Paper Type</i> being loaded and press [Enter].</li> </ul> <p>If using the <i>Bypass</i>, remember to load the required stock.</p>

# Special Copy Features

The special *Copy* features available can be accessed by pressing the *Menu/Exit* key and then selecting *Copy Features* on the display.

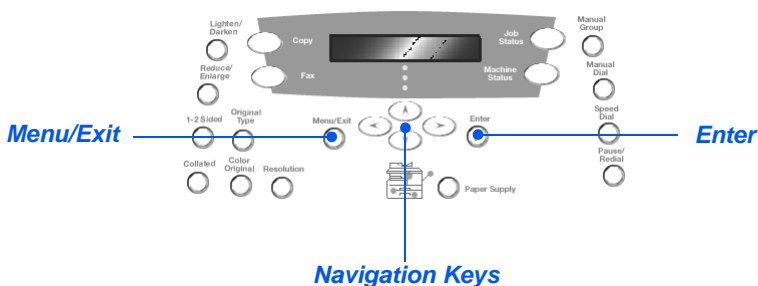

## Feature Description

FEATURE	OPTIONS	TO SELECT
<p><b>ID Card Copy</b></p> <ul style="list-style-type: none"> <li>Use to copy both sides of an ID document e.g. a drivers license, onto one side of paper.</li> </ul>	-	<ul style="list-style-type: none"> <li>Press [Menu/Exit].</li> <li>Using the <i>Navigation Keys</i> select [Copy Features] and press [Enter].</li> <li>Use the <i>Navigation Keys</i> to select [ID Card Copy] and press [Enter].</li> <li>[Press Start S.1] displays. Load <i>Side 1</i> of the original on the <i>Document Glass</i> and press [Start].</li> <li>Repeat for <i>Side 2</i> when [Press Start S.2] displays.</li> </ul> <p>The machine prints both sides of the ID document on one side of paper.</p>

<b>Edge Erase</b> <ul style="list-style-type: none"> <li>Use to 'clean up' the edges of an original e.g. if it is frayed or has hole punch or staple marks.</li> </ul>	<b>Off</b>	Use to de-activate the feature.	<ul style="list-style-type: none"> <li>Press [Menu/Exit].</li> <li>Using the <i>Navigation Keys</i> select [Copy Features] and press [Enter].</li> <li>Use the <i>Navigation Keys</i> to select [Edge Erase] and press [Enter].</li> <li>Select the required <i>Edge Erase</i> option and press [Enter] to save the selection.</li> </ul>
	<b>Small Orig Edges</b>	Use to erase 6 mm (0.25") from the edge of the document.	
	<b>Binder Holes</b>	Use to erase 24 mm (1.0") from the left edge of the document.	
	<b>Book Center &amp; Edges</b>	Use to erase 6 mm (0.25") from the left and right edge of the document.	
	<b>Border Surround</b>	Use to create a border around all edges of the document.	
<b>Margin Shift</b> <ul style="list-style-type: none"> <li>Use to create a binding edge for the document.</li> </ul>	<b>Off</b>	Use to de-activate the feature.	<ul style="list-style-type: none"> <li>Press [Menu/Exit].</li> <li>Using the <i>Navigation Keys</i> select [Copy Features] and press [Enter].</li> <li>Use the <i>Navigation Keys</i> to select [Margin Shift] and press [Enter].</li> <li>Select the required <i>Margin Shift</i> option and press [Enter].</li> <li>If required, enter a shift amount using the <i>Numeric Keypad</i> and press [Enter].</li> </ul>
	<b>Auto Center</b>	Use to center the image on the paper.	
	<b>Left Margin</b>	Use to enter a shift amount for the left margin.	
	<b>Right Margin</b>	Use to enter a shift amount for the right margin.	
	<b>Top Margin</b>	Use to enter a shift amount for the top margin.	
	<b>Bottom Margin</b>	Use to enter a shift amount for the bottom margin.	



<b>Book Copy</b> <ul style="list-style-type: none"> <li>Use when copying bound documents. If the document is too thick, lift the cover until its hinges are caught by the stopper and then close the cover.</li> </ul>	<b>Off</b>	Use to de-activate the feature.	<ul style="list-style-type: none"> <li>Use the <i>Document Glass</i> when copying bound documents.</li> </ul>
	<b>Left Page</b>	Use to scan and copy the left page of a bound document.	<ul style="list-style-type: none"> <li>Press [Menu/Exit].</li> <li>Using the <i>Navigation Keys</i> select [Copy Features] and press [Enter].</li> </ul>
	<b>Right Page</b>	Use to scan and copy the right page of a bound document.	<ul style="list-style-type: none"> <li>Use the <i>Navigation Keys</i> to select [Book Copy] and press [Enter].</li> </ul>
	<b>Both Pages</b>	Use to scan and copy both pages of a bound document.	<ul style="list-style-type: none"> <li>Select the required <i>Book Copy</i> option and press [Enter].</li> </ul>
<b>Auto Suppress</b> <ul style="list-style-type: none"> <li>Use when copying originals which require the background removing.</li> </ul>	<b>On</b>	Use to activate the <i>Auto Suppress</i> feature.	<ul style="list-style-type: none"> <li>Press [Menu/Exit].</li> <li>Using the <i>Navigation Keys</i> select [Copy Features] and press [Enter].</li> </ul>
	<b>Off</b>	Use to de-activate the feature.	<ul style="list-style-type: none"> <li>Use the <i>Navigation Keys</i> to select [Auto Suppress] and press [Enter].</li> <li>Select [On] and press [Enter].</li> </ul>
<b>Covers</b> <ul style="list-style-type: none"> <li>Use to automatically add covers to your copied set using stock taken from another tray.</li> </ul>	<b>Off</b>	Use to de-activate the feature.	<ul style="list-style-type: none"> <li>Press [Menu/Exit].</li> <li>Using the <i>Navigation Keys</i> select [Copy Features] and press [Enter].</li> </ul>
	<b>Front</b>	Use to add a blank or printed front cover to the copies.	<ul style="list-style-type: none"> <li>Use the <i>Navigation Keys</i> to select [Covers] and press [Enter].</li> </ul>
	<b>Back</b>	Use to add a blank or printed back cover to the copies.	<ul style="list-style-type: none"> <li>Select the required <i>Covers</i> option and press [Enter].</li> </ul>
	<b>Front &amp; Back</b>	Use to add a blank or printed front and back cover to the copies.	<ul style="list-style-type: none"> <li>Select the <i>Paper Tray</i> containing the covers stock and press [Enter].</li> <li>Select [Blank] or [Printed] depending on your requirement, and press [Enter].</li> </ul>

<b>Transparencies</b> <ul style="list-style-type: none"> <li>Use to create a single set of transparencies with blank or printed separators.</li> </ul>	<b>Off</b>	Use to de-activate the feature.	<ul style="list-style-type: none"> <li>Press [Menu/Exit].</li> </ul>
	<b>Bypass</b>	Use to create a single set of transparencies with a blank or printed divider between each transparency.	<ul style="list-style-type: none"> <li>Using the <i>Navigation Keys</i> select [Copy Features] and press [Enter].</li> <li>Use the <i>Navigation Keys</i> to select [Transparencies] and press [Enter].</li> <li>Use the <i>Navigation Keys</i> to select [Bypass] and press [Enter].</li> <li>Use the <i>Navigation Keys</i> to select [Off], [Printed] or [Blank] for the separators and press [Enter].</li> <li>Select a <i>Paper Tray</i> for the separators and press [Enter].</li> </ul>
<b>Create Booklet</b> <ul style="list-style-type: none"> <li>Use to copy a document as a 2 Sided job and arrange the pages to produce a booklet when folded.</li> </ul>	<b>On</b>	Use to activate the <i>Create Booklet</i> feature.	<ul style="list-style-type: none"> <li>Press [Menu/Exit].</li> </ul>
	<b>Off</b>	Use to de-activate the feature.	<ul style="list-style-type: none"> <li>Using the <i>Navigation Keys</i> select [Copy Features] and press [Enter].</li> <li>Use the <i>Navigation Keys</i> to select [Create Booklet] and press [Enter].</li> <li>Select [On] and press [Enter].</li> </ul>
<b>N Up</b> <ul style="list-style-type: none"> <li>Use to print 2 or 4 original images reduced on to one page.</li> </ul>	<b>Off</b>	Use to de-activate the feature.	<ul style="list-style-type: none"> <li>Press [Menu/Exit].</li> </ul>
	<b>2 Up</b>	Use to print the images from 2 originals on to one page.	<ul style="list-style-type: none"> <li>Using the <i>Navigation Keys</i> to select [Copy Features] and press [Enter].</li> </ul>
	<b>4 Up</b>	Use to print the images from 4 originals on to one page.	<ul style="list-style-type: none"> <li>Use the <i>Navigation Keys</i> to select [N Up] and press [Enter].</li> <li>Select the required <i>N Up</i> option and press [Enter].</li> </ul>

# Compatible Features

The following table indicates which features are compatible with other features. It also shows which input area can be used for a feature e.g. the *Document Feeder* or *Document Glass*.

COPY FEATURE		Document Feeder or Glass	ID Copy	Book Copy	Create Booklet	N Up	Edge Erase	Margin Shift	Auto Suppress	Covers	Transparencies
<i>ID Copy</i>		Glass									
<i>Book Copy</i>		Glass	X								
<i>Create Booklet</i>		Document Feeder	X	X							
<i>N Up</i>	<i>2 Up</i>	Glass / Document Feeder	X	X	O						
	<i>4 Up</i>	Document Feeder	X	X	X						
<i>Edge Erase</i>	<i>Small Orig Edges</i>	Glass	X	X	X	X					
	<i>Binder Holes</i>	Glass / Document Feeder	X	X	X	O					
	<i>Book Center &amp; Edges</i>	Glass	X	O	X	X					
	<i>Border Surround</i>	Glass / Document Feeder	X	X	O	O					
<i>Margin Shift</i>	<i>Auto Center</i>	Glass	X	X	X	X	O Small Orig Only				
	<i>Left</i>	Glass / Document Feeder	X	O	X	X	O Not Book Center & Edges				
	<i>Right</i>	Glass / Document Feeder	X	O	X	X	O Not Book Center & Edges				
	<i>Top</i>	Glass / Document Feeder	X	O	X	X	O Not Book Center & Edges				
	<i>Bottom</i>	Glass / Document Feeder	X	O	X	X	O Not Book Center & Edges				
<i>Auto Suppress</i>		Glass / Document Feeder	X	O	O	O	O	O			
<i>Covers</i>		Glass / Document Feeder	X	O	X	X	O Not Book Center & Edges	O Not Auto Center	O		
<i>Transparencies</i>		Glass / Document Feeder	X	O	X	X	O	O Not Auto Center	O	X	
<i>R/E</i>	<i>%</i>	Glass / Document Feeder	X	O	X	X	O Binder Holes & Border Surround Only	X	O	O	O
	<i>AutoFit</i>	Glass	X	X	X	X	O Small Orig Only	X	O	X	O
	<i>Clone</i>	Glass	X	O	X	X	O Small Orig Only	X	O	X	O
<i>Collate</i>		Glass / Document Feeder	X	X	X	X	O Not Book Center & Edges	O	O	O	X

**Key:**

- O =Compatible
- X =Incompatible



# 4 Paper and Other Media

---

There is one *Paper Tray* and a *Bypass Tray* as standard on the *Xerox WorkCentre 4118*. A second *Paper Tray* is available to purchase as an option.

- Loading Paper . . . . . 4-2
- Setting the Paper Size . . . . . 4-8
- Media Specifications . . . . . 4-9

# Loading Paper

## Preparing Paper for Loading

Before loading paper into the *Paper Trays*, fan the edges. This procedure separates any sheets of paper that are stuck together and reduces the possibility of paper jams.



To avoid unnecessary paper jams and misfeeds do not remove paper from its packaging until required.

## Using the Paper Trays

### Loading the Paper Trays

Using the instructions provided, load paper into the machine. Up to two *Paper Trays* are available, depending on your machine configuration. The *Paper Trays* can hold a maximum of 550 sheets of 80 g/m<sup>2</sup> (20 lb) plain paper.

**1**

- To load paper, pull open the *Paper Tray*.

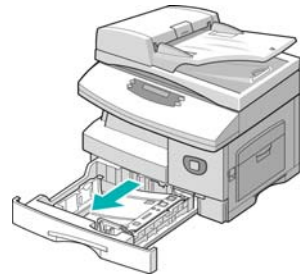
**2**

- Push down on the pressure plate until it locks into position.

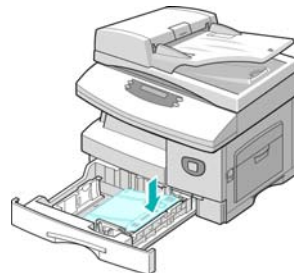

3

- Adjust the rear paper guide to the required paper length.

It is preset to A4 or Letter size depending on country.

- To load another size, lift the rear guide out of the current position and into the required position.

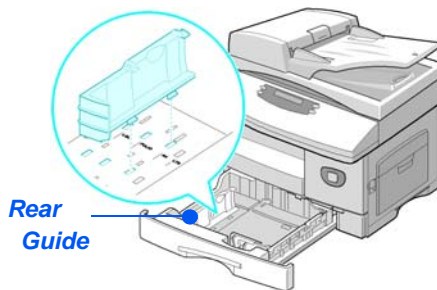

- 
- ① *The Paper Trays can hold a maximum of 550 sheets of 80 g/m<sup>2</sup> (20 lb) plain paper. You can use A4, Letter, Folio or Legal size paper only.*
- 

4

- *If you experience problems with paper feed, turn the paper around and if the problem continues, use the Bypass Tray.*

- Fan the paper and insert it into the tray.

If loading Letterhead, ensure the design is face-up and the top edge of the sheet is placed at the right side.

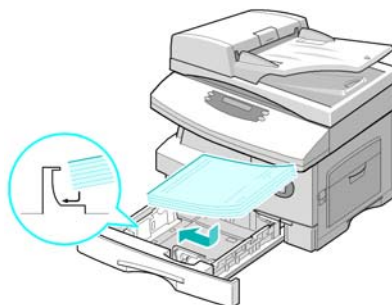

## 5

- Ensure that the paper is positioned under the snubbers.

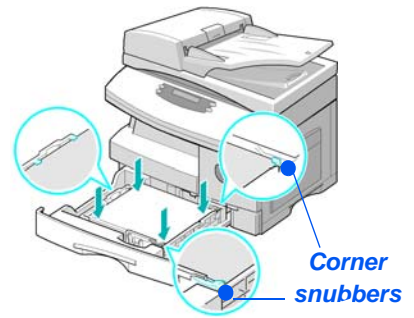

- Do not fill above the *Maximum Fill Line*.

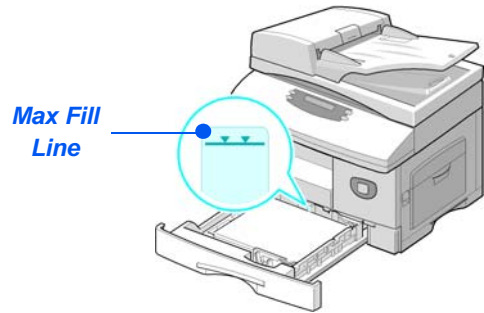

## 6

- When printing from your PC, ensure you select the Paper Source and the correct paper size from your software application.

- Position the side guide by squeezing the lever and sliding it toward the stack of paper, until it gently touches the side of the stack.

Do not allow the guide to press against the edge of the paper tightly.

- Close the *Paper Tray*.

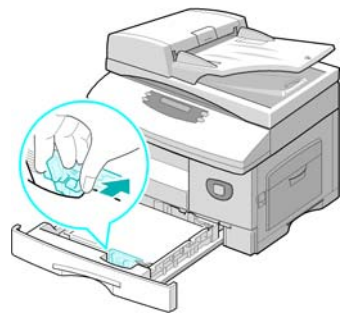

Use the instructions "Setting the Paper Size" on page 4-8 to set the correct size for the Paper Tray.



# 7

- To select a paper tray, press the [Paper Supply] key until the required tray is lit on the *Status Map*.

*Tray 1* and the *Bypass Tray* are available as standard, *Tray 2* is optional.

If two tray lights display together, the *Auto Tray Switching* feature is active. When one tray runs out of paper, the machine will switch to the other selected tray.

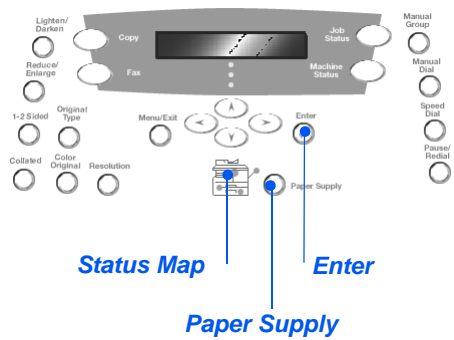

## Using the Bypass Tray

The *Bypass Tray* is located on the right side of your machine. It can be closed when not in use, making the product more compact. Use the *Bypass Tray* to print transparencies, labels, envelopes or postcards in addition to making quick runs of paper types or sizes that are not currently loaded in the paper tray.

Acceptable print media is plain paper with sizes ranging from 98 x 148 mm (3.86 x 5.83 inch), to Legal size (216 x 356 mm / 8.5 x 14 inch) and weighing between 60 g/m<sup>2</sup> and 160 g/m<sup>2</sup> (16 lb and 43 lb).

The following table summarizes the print media allowed and the maximum stacking height for each paper type.

PAPER TYPE	MAXIMUM STACKING HEIGHT
Plain/Bond/Colored and Pre-printed Paper	100 sheets or 9 mm (0.35 inch)
Envelope	10 envelopes or 9 mm (0.35 inch)
Transparency	30 sheets or 9 mm (0.35 inch)
Label	10 sheets or 9 mm (0.35 inch)
Cardstock	10 sheets or 9 mm (0.35 inch)

**i** The height is measured with the stack of sheets laid on a flat surface.

## Loading the Bypass Tray

**1**

- Remove any curl on postcards, envelopes, and labels before loading them into the Bypass Tray.

- Lower the *Bypass Tray*, located on the right side of the product.
- Unfold the *Paper Support* extension.

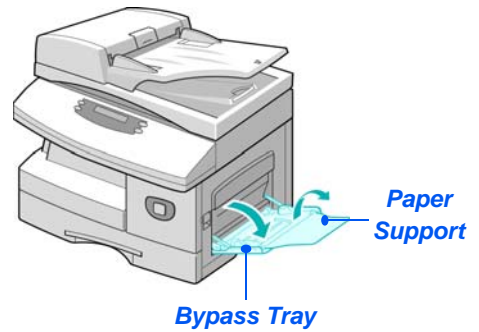

**2**

- Prepare a stack of paper or envelopes for loading by flexing or fanning them back and forth. Straighten the edges on a level surface.

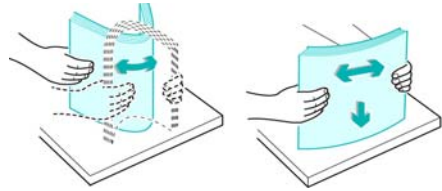

**3**

- Hold transparencies by the edges and avoid touching the print side.

- Load the print material with the print side facing down and against the right edge of the tray.



**4**

- Adjust the paper guide to the width of the stack of print material.

Ensure you have not loaded too much print media. The stack should be under the *Max. Fill Line*.

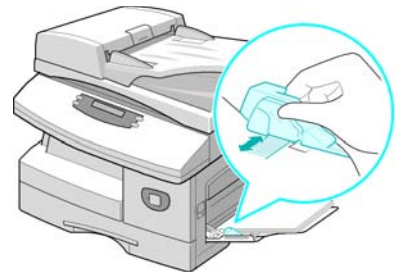

5

- To select the *Bypass Tray*, press the [Paper Supply] key until the *Bypass Tray* is lit on the *Status Map*.
- When the *Bypass Tray* is selected the *Paper Type* option displays. Use the *Navigation Keys* to select the *Paper Type* being loaded and press [Enter].

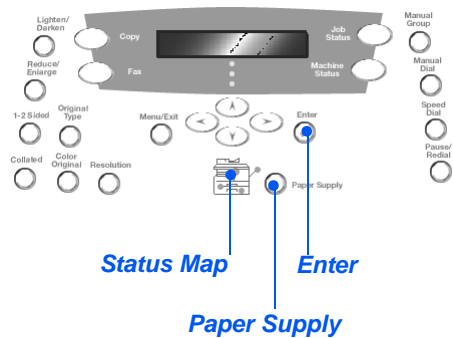

Use the instructions "Setting the Paper Size" on page 4-8 to set the correct size for the Bypass Tray.

# Setting the Paper Size

After loading paper in the *Paper Trays*, you will need to set the default *Paper Size*. Use the following instructions to set the default *Paper Size* for each tray.

- **1** Press the [Machine Status] key on the *Control Panel*.
- **2** Select [Machine Setup] using the *Navigation Keys* and press [Enter].  
The display shows [Tray 1 Size] on the bottom line.  
➤ Press [Enter].
- **3** Use the *Navigation Keys* to select the *Paper Size* required and press [Enter] to save the selection.  
➤ Repeat the procedure for [Tray 2 Size] if available, and [Bypass Size].
- **4** Press [Menu/Exit] to exit each menu level and return to Standby mode.

# Media Specifications

## Media Sizes and Types

The table below identifies the media sizes which can be used in the *Paper Tray* and *Bypass Tray*, and the capacities which can be loaded.

MEDIA SIZE	INPUT SOURCE CAPACITY <sup>a</sup>			
	Paper Tray		Bypass Tray	
<b>Plain paper</b>				
Letter (8.5 x 11 inch)	YES	550	YES	100
Folio (8.5 x 13 inch)	YES	550	YES	100
Legal (8.5 x 14 inch)	YES	550	YES	100
Executive (7.25 x 10.5 inch)	NO	0	YES	100
A4 (210 x 297 mm)	YES	550	YES	100
B5 (182 x 257 mm)	NO	0	YES	100
A5 (148 x 210 mm)	NO	0	YES	100
<b>Envelopes</b>				
No. 10 (8.5 x 14 inch)	NO	0	YES	10
C5 (6.38 x 9.37 inch)	NO	0	YES	10
DL (110 x 220 mm)	NO	0	YES	10
Monarch (3.87 x 7.5 inch)	NO	0	YES	10
B5 (176 x 250 mm)	NO	0	YES	10
<b>Labels<sup>b</sup></b>				
Letter (8.5 x 11 inch)	NO	0	YES	10
A4 (210 x 297 mm)	NO	0	YES	10
<b>Transparency films<sup>b</sup></b>				
Letter (8.5 x 11 inch)	NO	0	YES	30
A4 (210 x 297 mm)	NO	0	YES	30
<b>Card stocks<sup>b</sup></b>				
A6 (105 x 148.5)	NO	0	YES	10
Post Card (4 x 6 inch)	NO	0	YES	10
Hagaki (5.83 x 8.27 inch)	NO	0	YES	10

- ⓘ a. Depending on paper thickness, maximum capacity may be reduced.  
 b. Feed one sheet at a time through the Bypass Tray if jams occur.

**NOTE:** For information about Media weight specifications, refer to "General Specifications" starting on page 11-6.

When selecting or loading paper, envelopes, or other special media please adhere to these guidelines:

- Attempting to print on damp, curled, wrinkled, or torn paper can cause paper jams and poor print quality.
- Use only high quality copier grade paper. Avoid paper with embossed lettering, perforations, or texture that is too smooth or too rough.
- Store paper in its ream wrapper until ready to use. Place cartons on pallets or shelves, not on the floor. Do not place heavy objects on top of the paper, whether it is packaged or unpackaged. Keep it away from moisture, or other conditions that can cause it to wrinkle or curl.
- During storage, moisture-proof wrap (any plastic container or bag) should be used to prevent dust and moisture from contaminating your paper.
- Always use paper and other media that conform with the specifications detailed in “*General Specifications*” on page 11-6.
- Use only well-constructed envelopes with sharp, well creased folds:
  - DO NOT use envelopes with clasps and snaps.
  - DO NOT use envelopes with windows, coated lining, self-adhesive seals, or other synthetic materials.
  - DO NOT use damaged or poorly made envelopes.
- It is recommended that you feed special paper types one sheet at a time.
- Only use the special media recommended for use in laser printers.
- To prevent special media such as transparencies and label sheets from sticking together, remove them from the exit tray as they are printed.
- Place transparencies on a flat surface after removing them from the machine.
- Do not leave the film in the paper tray for long periods of time. Dust and dirt may accumulate on them resulting in spotty printing.
- To avoid smudging caused by fingerprints, handle transparencies and coated paper carefully.
- To avoid fading, do not expose the printed transparencies to prolonged sunlight.
- Store unused media at temperatures between 59°F and 86°F (15°C to 30°C). The relative humidity should be between 10% and 70%.
- Do not load more than 10 sheets of special media into the *Bypass Tray* at a time.
- Verify that your labels’ adhesive material can tolerate fusing temperature of 200°C (392°F) for 0.1 second.

- Ensure that there is no exposed adhesive material between labels. Exposed areas can cause labels to peel off during printing, which can cause paper jams. Exposed adhesive can also cause damage to machine components.
- Do not feed a sheet of labels through the machine more than once. The adhesive backing is designed for one pass through the machine.
- Do not use labels that are separating from the backing sheet or are wrinkled, bubbled, or otherwise damaged.





# 5 Fax (4 in 1 only)

---

The *Fax* function is available as standard on the *Xerox WorkCentre 4118*, 4 in 1 only.

- Faxing Procedure . . . . . 5-2
- Dialing Methods . . . . . 5-6
- Basic Fax Features . . . . . 5-8
- Special Fax Features . . . . . 5-10
- Fax Forwarding . . . . . 5-14
- Mailbox Setup . . . . . 5-15
- Mailbox Procedures . . . . . 5-17
- Fax Setup Options . . . . . 5-22

# Faxing Procedure

## 1 Load the Originals

### **Document Feeder:**

- Remove all staples and paper clips prior to loading.
- Adjust the sliding document guides to the size required.
- Insert the originals neatly into the *Document Feeder*, face up.

The first page should be on top with the headings towards the back or left of the machine.

- Align the stack with the left and rear edges of the tray. Adjust the guides to just touch the edges of the originals.

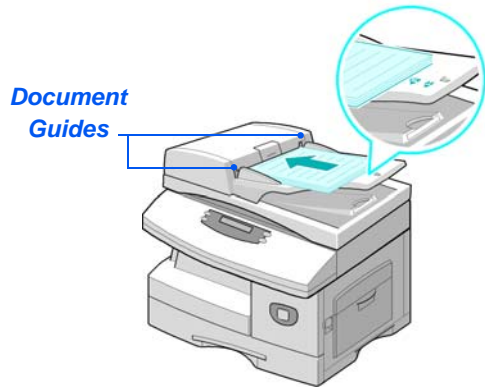

---

ⓘ Up to 40 sheets of 80 g/m<sup>2</sup> (20lb bond) paper can be loaded. Weight ranges from 45 - 105 g/m<sup>2</sup> (12.5 - 28lb). Sizes range from B5 to Legal (7" x 10" to 8.5" x 14"). Refer to "Scanner and Copier Specifications" on page 11-5 for full Document Feeder specifications.

---

## Document Glass:

- Ensure no documents are loaded in the Document Feeder when using the Document Glass.

Leaving the Document Feeder open while scanning will affect the image quality and toner consumption.

- Raise the Document Feeder and position the original face down on the Document Glass.

Align with the registration arrow in the rear left corner.

- Lower the Document Feeder.

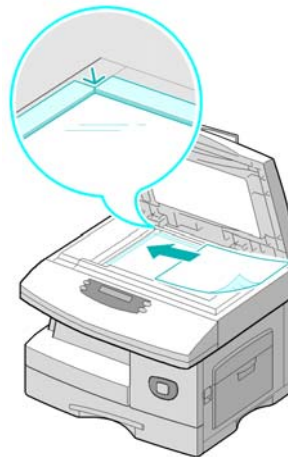

- On completion of the job, ensure the Document Feeder is closed.

## 2

### Select the Fax key

- Press the [Fax] key to activate Fax mode.

The Fax key remains illuminated when selected.

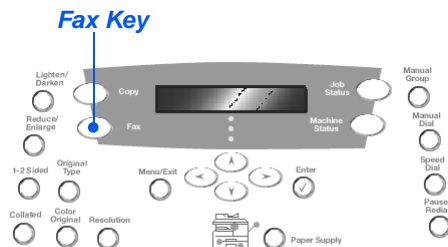

### 3 Select the Fax Features

- For more information about the available Fax features, refer to "Basic Fax Features" on page 5-8, and "Special Fax Features" on page 5-10.

- Press the Fax feature key required on the Control Panel.

Basic features available for Fax jobs are *Lighten/Darken*, *1-2 Sided*, *Original Type*, *Color Original* and *Resolution*.



For information about all the available Fax features, refer to "Basic Fax Features" on page 5-8, and "Special Fax Features" on page 5-10.

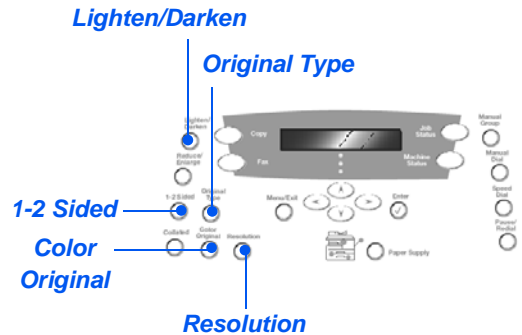

- Using the *Navigation Keys*, select the setting required for the feature and press [Enter].

### 4 Enter the Fax Number

- There are several methods available for entering the remote fax number, for more information refer to "Dialing Methods" on page 5-6.

- Use the *Numeric Keypad* to enter the telephone number of the remote fax machine.
- If an incorrect number is entered, use the *Navigation Keys* to select the incorrect number and then press the correct number.

Pressing the [Clear/Clear All] key will delete the entire fax number entered.

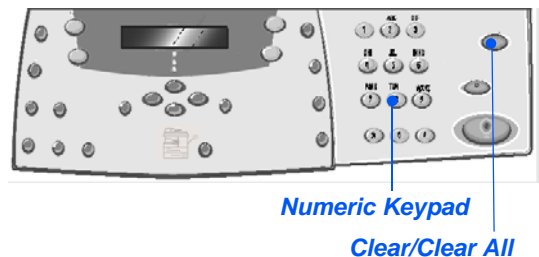

## 5 Press Start

- Press [Start] to begin the *Fax* job.
- If the display shows [Scan Another?] and another original requires scanning, load the next original and select [Yes]. Press [Enter].

Continue the procedure until all the originals have been scanned.

- Select [No] when all the originals have been scanned, and press [Enter].

The *Fax* is scanned and sent.

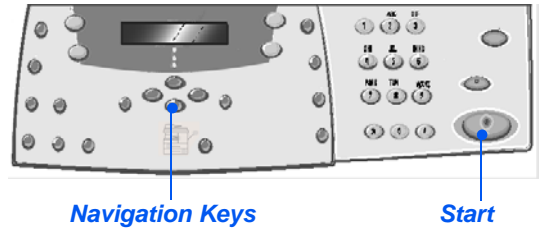

## 6 Job Status

- To view the status of a job, press the [Job Status] key.
- A list of current jobs and the job details displays.
- To delete a job, select the required job and press [Enter]. Select [Cancel Job?] and press [Enter]. A confirmation message displays, select [1:Yes] and press [Enter].
- Press [Menu/Exit] to exit *Job Status*.

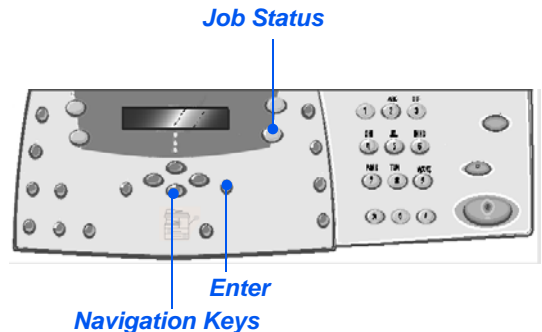

# Dialing Methods

There are several methods which can be used to enter a fax number or a group of fax number. The following table identifies and explains all the dialing methods available.

DIALING METHOD	INSTRUCTIONS
<p><b>Keypad Dialing</b></p> <ul style="list-style-type: none"> <li>• <i>Use when entering the remote fax number using the Numeric Keypad.</i></li> </ul>	<ul style="list-style-type: none"> <li>➤ Load the originals and select the [Fax] key.</li> <li>➤ Use the <i>Numeric Keypad</i> to enter the telephone number of the remote fax machine.</li> <li>➤ Press [Start] to send the fax.</li> </ul>
<p><b>Speed Dialing</b></p> <ul style="list-style-type: none"> <li>• <i>Use to access a fax number which has previously been stored in the machine's memory.</i></li> </ul>	<ul style="list-style-type: none"> <li>➤ Load the originals and select the [Fax] key.</li> <li>➤ Program the features required for the job.</li> <li>➤ Press [Speed Dial] and enter the <i>Speed Dial</i> number (1-200). The name displays and the original is scanned into memory ready for sending.</li> <li>➤ If the original is loaded on the <i>Document Glass</i>, the display asks if you want to send another page. Select [Yes] to add more originals, or [No] to begin transmission. Press [Enter]. The fax number stored in the speed dial location will be dialed automatically and the fax is sent.</li> </ul>
<p><b>Group Dialing</b></p> <ul style="list-style-type: none"> <li>• <i>Use to access a group of numbers which have previously been stored in the machine's memory.</i></li> </ul>	<ul style="list-style-type: none"> <li>➤ Load the originals and select the [Fax] key.</li> <li>➤ Program the features required for the job.</li> <li>➤ Press [Speed Dial] and enter the <i>Group Dial</i> number (1-200).</li> <li>➤ When the required number displays, press [Enter]. The original is scanned into memory.</li> <li>➤ If the original is loaded on the <i>Document Glass</i>, the display asks if you want to send another page. Select [Yes] to add more originals, or [No] to begin transmission. Press [Enter]. The machine automatically sends the fax to each of the numbers in the <i>Group</i>.</li> </ul>

<p><b>Manual group dialing</b></p> <ul style="list-style-type: none"> <li>• <i>Use to manually program a broadcast send to multiple destinations.</i></li> </ul>	<ul style="list-style-type: none"> <li>➤ Load the originals and select [Fax].</li> <li>➤ Press [Manual Group]. The display requests a destination fax number.</li> <li>➤ Enter the first fax number and press [Enter].</li> <li>➤ 'Another No.?' displays. Select [Yes] to add another number and press [Enter].</li> <li>➤ Repeat the procedure until all numbers have been entered. Then select [No] and press [Enter]. The originals are scanned and faxed to the destinations entered.</li> </ul>
<p><b>Manual Dialing</b></p> <ul style="list-style-type: none"> <li>• <i>Use to dial the fax number with the telephone line open.</i></li> </ul>	<ul style="list-style-type: none"> <li>➤ Load the originals and select [Fax].</li> <li>➤ Press [Manual Dial]. The dial tone is audible and the LCD displays 'Phone'.</li> <li>➤ Dial the fax number. When the fax tone is heard, press [Start] to begin faxing.</li> </ul>
<p><b>Redial</b></p> <ul style="list-style-type: none"> <li>• <i>Numbers which have already been entered recently can be quickly accessed using the Redial function.</i></li> </ul>	<ul style="list-style-type: none"> <li>➤ Load the originals and select [Fax].</li> <li>➤ Press [Pause/Redial]. The last number is automatically dialed and the originals are scanned and faxed.</li> </ul> <hr/> <ul style="list-style-type: none"> <li>➤ Load the originals and select [Fax].</li> <li>➤ Press [Pause/Redial] for approximately 2 seconds. The <i>Redial Memory</i> in the machine retains the last 10 numbers dialed.</li> <li>➤ Using the <i>Navigation Keys</i>, select the number required and press [Enter].</li> <li>➤ Press [Start] to dial the number. The fax is automatically scanned and sent.</li> </ul>

# Basic Fax Features

There are five basic *Fax* features available. These features can be selected using the feature keys located on the *Control Panel*.

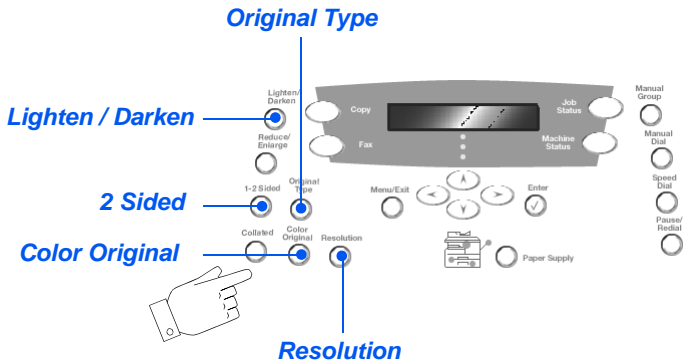

## Feature Description

FEATURE	OPTIONS		INSTRUCTIONS
<b>Lighten/Darken</b> <ul style="list-style-type: none"> <li>Use to adjust the contrast for a document containing faint or dark images.</li> </ul>	<b>5 Contrast Settings</b>		<ul style="list-style-type: none"> <li>Press [Fax].</li> <li>Press [Lighten/Darken].</li> <li>Using the <i>Navigation Keys</i> select a contrast setting.                      Each time the key is pressed the selection block on the display moves to the left or right. As the selection block moves to the right the contrast becomes darker.</li> <li>Press [Enter] to save the selection.</li> </ul>
<b>Original Type</b> <ul style="list-style-type: none"> <li>Use to select the type of document being scanned.</li> </ul>	<b>Text</b>	Use for documents containing mostly text.	<ul style="list-style-type: none"> <li>Press [Fax].</li> <li>Press [Original Type].</li> <li>Using the <i>Navigation Keys</i>, select the option required and press [Enter].</li> </ul>
	<b>Mixed</b>	Use for documents with mixed text and graphics.	
	<b>Photo</b>	Use for photographs.	



<p><b>Color Original</b></p> <ul style="list-style-type: none"> <li>• Use to scan and send a color original.</li> </ul>	<p><b>On</b></p>	<p>Use to scan a color original and send to the remote fax.</p> <ul style="list-style-type: none"> <li>• The remote fax must have the capability to receive a color fax to use this feature.</li> </ul>	<ul style="list-style-type: none"> <li>➤ Press [Fax].</li> <li>➤ Press [Color Original].</li> <li>➤ Using the <i>Navigation Keys</i>, select the [On] and press [Enter].</li> </ul>
<p><b>Resolution</b></p> <ul style="list-style-type: none"> <li>• Use to increase sharpness and clarity.</li> </ul>	<p><b>Standard</b></p>	<p>Use for documents with normal sized characters.</p>	<ul style="list-style-type: none"> <li>➤ Press [Fax].</li> <li>➤ Press [Resolution].</li> </ul>
	<p><b>Fine</b></p>	<p>Use for documents containing small characters or thin lines. Also used when sending a color fax.</p>	<ul style="list-style-type: none"> <li>➤ Using the <i>Navigation Keys</i>, select the option required and press [Enter].</li> </ul>
	<p><b>Super Fine</b></p>	<p>Use for documents containing extremely fine detail. This is available only if the remote machine also supports <i>Super Fine</i> resolution.</p>	

# Special Fax Features

The special *Fax* features available can be accessed by pressing the *Menu/Exit* key and then selecting *Fax Features* on the display.

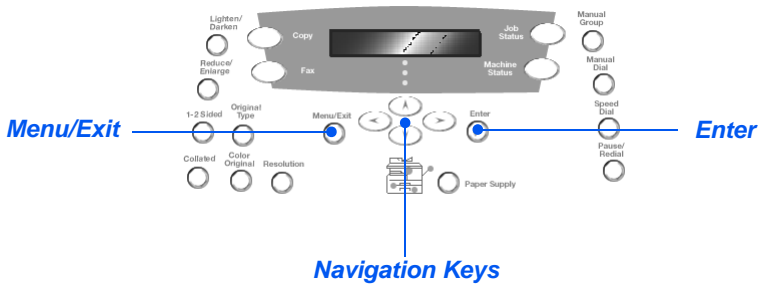

## Feature Description

FEATURE	OPTIONS		INSTRUCTIONS
<b>Toll Save</b> <ul style="list-style-type: none"> <li>Use to set a low rate period for sending faxes.</li> </ul>	<b>Off</b>	Use to de-activate the feature.	<ul style="list-style-type: none"> <li>Press [Menu/Exit].</li> <li>Using the <i>Navigation</i> keys select [Fax Features] and press [Enter].</li> <li>Select [Toll Save] and press [Enter].</li> <li>Select [On] and press [Enter].</li> <li>Select [Start Time] and enter a date and time to start the <i>Toll Save</i> period. Press [Enter].</li> <li>Select [End Time] and enter a date and time to end the <i>Toll Save</i> period. Press [Enter].</li> </ul>
	<b>On</b>	Use to enable the feature.	

<p><b>Memory Fax</b></p> <ul style="list-style-type: none"> <li>● Use to send a fax from memory.</li> </ul>	<p><b>No.</b></p>	<p>Used to enter the fax phone number for the remote machine.</p>	<ul style="list-style-type: none"> <li>➤ Press [Menu/Exit].</li> <li>➤ Using the <i>Navigation Keys</i> select [Fax Features] and press [Enter].</li> <li>➤ Select [Memory Fax] and press [Enter].</li> <li>➤ Enter the fax number for the remote machine. Press [Enter].</li> <li>➤ <i>Another No?</i> displays, if required enter another number and press [Enter].</li> <li>➤ When all the numbers have been entered the originals are scanned and stored in memory. The fax is then sent from memory.</li> </ul>
<p><b>Delay Fax</b></p> <ul style="list-style-type: none"> <li>● Use to set a specific time for sending your fax.</li> <li>● When the machine has more than one fax stored in memory, the status message <i>Delayed Fax</i> is displayed.</li> </ul>			<ul style="list-style-type: none"> <li>➤ Press [Menu/Exit].</li> <li>➤ Using the <i>Navigation Keys</i> select [Fax Features] and press [Enter].</li> <li>➤ Select [Delay Fax] and press [Enter].</li> <li>➤ Enter the fax number using the <i>Numeric Keypad</i> or <i>Speed Dial</i>, and press [Enter]. Enter another number if required. When all numbers have been entered select [No] and press [Enter].</li> <li>➤ Enter a name for the job and press [Enter].</li> <li>➤ The displays shows the current time, enter a time for the delay fax and press [Enter].</li> </ul> <p>If you set a time earlier than the current time, the job will be sent at that time the following day.</p> <p>The originals are scanned into memory ready for sending.</p>

<p><b>Priority Fax</b></p> <ul style="list-style-type: none"> <li>• Use this option to send your fax ahead of reserved operations.</li> </ul>			<ul style="list-style-type: none"> <li>➤ Press [Menu/Exit].</li> <li>➤ Using the <i>Navigation Keys</i> select [Fax Features] and press [Enter].</li> <li>➤ Select [Priority Fax] and press [Enter].</li> <li>➤ Enter the fax number using the <i>Numeric Keypad</i> or <i>Speed Dial</i>, and press [Enter]. Enter another number if required. When all numbers have been entered select [No] and press [Enter].</li> <li>➤ Enter a name for the job and press [Enter].</li> </ul> <p>The originals are scanned into memory ready for sending.</p>
<p><b>Polling</b></p> <ul style="list-style-type: none"> <li>• Polling is used to retrieve documents from remote fax machines. Remote fax machines can also poll your machine.</li> </ul>	<p><b>TX Poll</b></p>	<p>Use to store a document on the machine ready to be polled by a remote fax machine.</p>	<ul style="list-style-type: none"> <li>➤ Press [Menu/Exit].</li> <li>➤ Using the <i>Navigation Keys</i> select [Fax Features] and press [Enter].</li> <li>➤ Select [Polling] and press [Enter].</li> <li>➤ Select [TX Poll] and press [Enter].</li> <li>➤ Enter a 4 digit <i>Poll Code</i> and press [Enter].</li> <li>➤ To store the originals in the <i>Bulletin Board</i> select [On]. If the <i>Bulletin Board</i> is not required, select [Off].</li> <li>➤ Press [Start]. The originals are scanned into memory ready to be polled.</li> </ul>

	<b>Delay RX Poll</b>	Use to retrieve a document from a remote fax machine at a specified time.	<ul style="list-style-type: none"> <li>➤ Press [Menu/Exit].</li> <li>➤ Using the <i>Navigation Keys</i> select [Fax Features] and press [Enter].</li> <li>➤ Select [Polling] and press [Enter].</li> <li>➤ Select [Delay RX Poll] and press [Enter].</li> <li>➤ Enter the fax number using the <i>Numeric Keypad</i> or <i>Speed Dial</i>, and press [Enter].</li> <li>➤ The display shows the current time, enter a start time for the remote fax machine to be polled. Press [Enter] when the correct time displays.  If you set a time earlier than the current time, the job will be sent at that time the following day.</li> <li>➤ Enter a 4 digit <i>Poll Code</i> and press [Enter].  The machine will poll the remote machine at the specified time.</li> </ul>
<b>Batch TX</b>  <ul style="list-style-type: none"> <li>● Use to send faxes that are going to the same location, in one batch.</li> </ul>	<b>On</b>	Activates the <i>Batch TX</i> feature.	<ul style="list-style-type: none"> <li>➤ Press [Menu/Exit].</li> <li>➤ Using the <i>Navigation Keys</i> select [Fax Features] and press [Enter].</li> <li>➤ Use the <i>Navigation Keys</i> to select [Batch TX] and press [Enter].</li> <li>➤ Select [On] and press [Enter]. Enter a <i>Batch Interval</i> between 0 - 99 and press [Enter].</li> </ul>
	<b>Off</b>	Deactivates the <i>Batch TX</i> feature.	
<b>Secure Receive</b>  <ul style="list-style-type: none"> <li>● Feature must be enabled in Fax Setup.</li> </ul>	<b>Print</b>	Print secure faxes	<ul style="list-style-type: none"> <li>➤ Press [Menu/Exit].</li> <li>➤ Using the <i>Navigation Keys</i> select [Fax Features] and press [Enter].</li> <li>➤ Select [Secure Receive] and press [Enter].</li> <li>➤ Select [Print] and press [Enter].</li> <li>➤ Enter a passcode and press [Enter].</li> </ul>

# Fax Forwarding

This feature sets up the forwarding details for faxes. This can be set for received and or transmitted faxes and can also print a copy at the *WorkCentre 4118*.

To configure fax forwarding:

- **1** Press the [Machine Status] button.
- **2** Press ▼ or ▲ until *System Admin Tools* is displayed and press [Enter].  
If the *System Admin Tools* have been passcode protected, type in the password and press [Enter].
- **3** Press ◀ or ▶ until *Forward to Fax* is displayed and press [Enter].
- **4** Press ◀ or ▶ until the required forwarding condition is displayed and press [Enter].  
The choices are:
  - Off - don't forward
  - RX - forward received
  - TX - forward transmitted
  - All - forward RX and TXEnter the fax number to receive the forwarded fax and press [Enter].
- **5** If you want to forward the *Fax* to another number, press ◀ or ▶ until *Yes* is displayed and press [Enter]. Otherwise, choose *No* and press [Enter].  
Enter the fax number to receive the forwarded fax and press [Enter].
- **6** If you want to print a local copy, press ◀ or ▶ until *Yes* is displayed and press [Enter]. Otherwise, choose *No* and press [Enter].
- **7** If you want to delete the assigned recipient of the forwarded faxes, press ◀ or ▶ until *Yes* is displayed and press [Enter]. Otherwise, choose *No* and press [Enter].

# Mailbox Setup

This feature sets up the forwarding details for faxes. This can be set for received and or transmitted faxes and can also print a copy at the *WorkCentre 4118*.

## Create a Mailbox

To create a mailbox:

- **1** Press the [Machine Status] button.
- **2** Press ▼ or ▲ until *System Admin Tools* is displayed and press [Enter].  
If the *System Admin Tools* have been passcode protected, type in the password and press [Enter].
- **3** Press ◀ or ▶ until *Mailbox Setup* is displayed and press [Enter].  
Press ▼ or ▲ until *Mailbox* is displayed and press [Enter].
- **4** Press ◀ or ▶ until *Create* is displayed and press [Enter].
- **5** Press ◀ or ▶ until the required *Mailbox Type* is displayed and press [Enter]. The choices are:  
*Set\_Conf\_MBX (confidential)*  
*Set\_Bull\_MBX (bulletin)*
- **6** Press ◀ or ▶ until *Enter Box No* is displayed and press [Enter].  
Enter the *Mailbox Number* and press [Enter].
- **7** If you want to passcode protect press ◀ or ▶ until *Security* is displayed and press [Enter].  
Press ◀ or ▶ until *Yes* is displayed and press [Enter].  
Enter the passcode using the keypad and press [Enter].  
Enter the *Mailbox Id.* using the keypad and press [Enter].
- **8** If you want to create another Mailbox, press ◀ or ▶ until *Another* is displayed and press [Enter]. Repeat steps 6 and 7.

## Delete a Mailbox

To delete a mailbox:

- **1** Press the [Machine Status] button.
- **2** Press ▼ or ▲ until *System Admin Tools* is displayed and press [Enter].  
If the *System Admin Tools* have been passcode protected, type in the password and press [Enter].
- **3** Press ◀ or ▶ until *Mailbox Setup* is displayed and press [Enter].  
Press ▼ or ▲ until *Mailbox* is displayed and press [Enter].
- **4** Press ◀ or ▶ until *Delete* is displayed and press [Enter]
  - Enter the *Box Number* to be deleted.
  - Enter the *Passcode* for the mailbox.Confirm the deletion.



# Mailbox Procedures

These procedures allow you to store a document in a mailbox, delete a document from a mailbox, print a document from a mailbox and to poll a mailbox. Mailboxes are setup by the *System Administrator*.

## Storing Documents in a Mailbox

- Load the originals you want to store in the mailbox.  
➤ Press the [Menu/Exit] key.

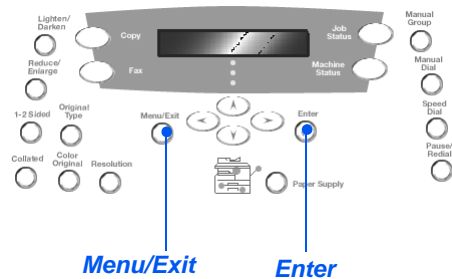

- Using the *Navigation Keys* select [Mailbox] and press [Enter].  
Select [Store] and press [Enter].
- Enter the *Box Number* for the mailbox and press [Enter].  
The originals are scanned and stored in the mailbox. The display shows the number of pages stored.

## Printing Mailbox Contents

**1**

- Press the [Menu/Exit] key.
- Using the *Navigation Keys* select [Mailbox] and press [Enter].

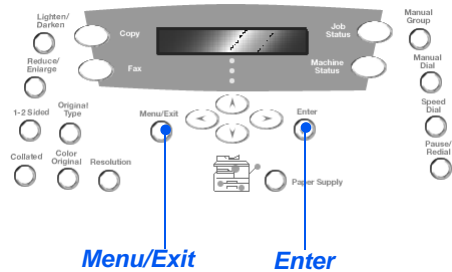

**2**

- Select [Print] and press [Enter]

**3**

- Enter the *Box Number* for the mailbox and press [Enter].
- Enter the *Passcode* for the mailbox and press [Enter].

The contents of the mailbox are printed and deleted.

## Deleting Mailbox Contents

1

- Press the [Menu/Exit] key.
- Using the *Navigation Keys* select [Mailbox] and press [Enter].

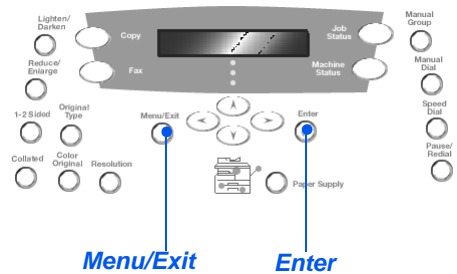

2

- Select [Delete] and press [Enter].

3

- Enter the *Box Number* for the mailbox and press [Enter].
- Enter the *Passcode* for the mailbox and press [Enter].

The contents of the mailbox are deleted.

## Polling from a Mailbox

- 1
  - Press the [Menu/Exit] key.
  - Using the *Navigation Keys* select [Mailbox] and press [Enter].

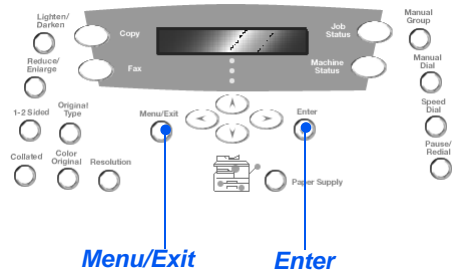

- 2
  - Select [Poll From] and press [Enter].
- 3
  - Enter the *Box Number* to be polled and press [Enter].
  - Enter the *Passcode* for the mailbox and press [Enter].
- 4
  - Enter a remote fax number and press [Enter].
  - The display shows the current time.
  - Enter a *Start Time* for the mailbox to be polled and press [Enter].

If you set a time earlier than the current time, the originals will be retrieved at that time the following day.

The mailbox will be polled at the specified time.

## Sending to a Mailbox

- Press the [Menu/Exit] key.
- Using the *Navigation Keys* select [Mailbox] and press [Enter].

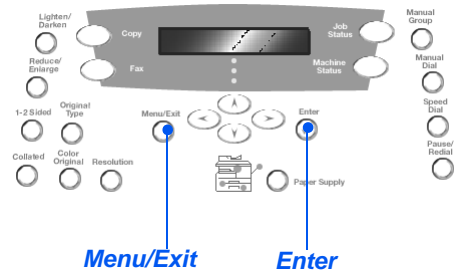

- Select [Send] and press [Enter].
- Enter the *Box Number* for where the originals are to be sent, and press [Enter].
- Enter the *Passcode* for the mailbox and press [Enter].

- Enter a remote fax number and press [Enter].  
The display shows the current time.
- Enter a *Start Time* for the originals to be sent and press [Enter].

If you set a time earlier than the current time, the job will be sent at that time the following day.

The originals will be sent to the mailbox at the specified time.

# Fax Setup Options

## Changing the Fax Setup Options

- 1 ➤ Press the [Machine Status] key.

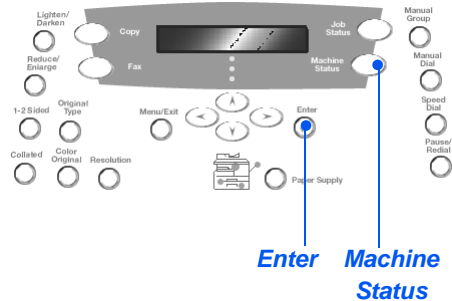

- 2 ➤ Using the *Navigation Keys* select [Fax Setup] and press [Enter].
- 3 ➤ Using the *Navigation Keys* select the required setup option and press [Enter].  
 ➤ Using the *"Fax Setup Options"* starting on page 5-23 customize the settings to meet your requirements.  
 Press [Enter] to save your selections.
- 4 ➤ Press [Menu/Exit] to exit each menu level and return to standby mode.

## Fax Setup Options

The following table lists all the *Fax Setup* options available and provides a instructions for customizing each setting. Instructions for accessing the *Fax Setup* options are provided on page 5-22.

OPTION	SETTINGS	DESCRIPTION
<b>Lighten/Darken</b>	<b><i>5 Contrast Settings</i></b>	Use to set the default <i>Lighten/Darken</i> setting.
<b>Resolution</b>	<b><i>Standard</i></b>	Use to set the default resolution for fax jobs.
	<b><i>Fine</i></b>	
	<b><i>Super Fine</i></b>	
<b>Receive Mode</b>	<b><i>Tel</i></b>	Use to operate in manual mode. When a call is received pick up the external phone handset or press [Manual Dial]. If a fax tone can be heard, press [Start] and replace the handset.
	<b><i>Fax</i></b>	The machine answers the incoming call and immediately switches to fax receive mode.
	<b><i>Ans/Fax</i></b>	Use if attaching an answering machine to the machine. If the machine detects a fax tone, it switches to <i>Fax</i> mode automatically.
	<b><i>DRPD</i></b>	You can receive a call using the <i>Distinctive Ring Pattern Detection (DRPD)</i> feature. This option is available when you setup <i>DRPD</i> mode.
<b>Fax Duplex</b>	<b><i>Off</i></b>	Use to de-activate <i>Fax Duplex</i> .
	<b><i>Long Edge</i></b>	Use to set fax jobs to print 2 sided, with the binding edge on the long edge.
	<b><i>Short Edge</i></b>	Use to set fax jobs to print 2 sided, with the binding edge on the short edge.

<b>Speed Dials</b>	<b>New</b>	<ul style="list-style-type: none"> <li>➤ Enter a <i>Speed Dial</i> number using the <i>Numeric Keypad</i> and then press [Enter]. If a number is already stored in the location a message displays. Enter a different <i>Speed Dial</i> number.</li> <li>➤ Enter the fax number you want to store using the <i>Numeric Keypad</i> and press [Enter]. To insert a pause press the [Pause/Redia] key and a 'P' displays.</li> <li>➤ To assign a name, enter the required name using the <i>Numeric Keypad</i>. If you do not require a name leave empty and press [Enter]. To store more <i>Speed Dial</i> numbers repeat the procedure.</li> </ul>
	<b>Edit</b>	<ul style="list-style-type: none"> <li>➤ If you want to delete a specific <i>Speed Dial</i> number from the group, press the [Speed Dial] key and enter the number. The display shows [Delete]. To add a new number, press the [Speed Dial] key and enter the number, the display shows [Add].</li> </ul>
	<b>Delete</b>	<ul style="list-style-type: none"> <li>➤ Press [Enter]. Repeat the procedure until all the editing has been completed.</li> <li>➤ Press the [Menu/Exit] key when you have finished editing. The name appears in the upper line of the display. Change the name if required and press [Enter].</li> </ul>



<b>Group Dials</b>	<b>New</b>	<ul style="list-style-type: none"> <li>➤ Enter a <i>Group</i> number between 1 and 200 using the <i>Numeric Keypad</i> and then press [Enter].</li> <li>If a number is already stored in the location a message displays.</li> <li>➤ The display asks you to enter a <i>Speed Dial</i> number to add to the <i>Group</i>. Enter the number and then press [Enter].</li> <li>➤ Continue entering <i>Speed Dial</i> numbers until all the group members have been added. Press the [Menu/Exit] key when you have finished entering numbers.</li> <li>➤ To assign a name to the <i>Group</i>, enter the required name. If a name is not required. Press [Enter].</li> <li>➤ To assign another <i>Group</i>, repeat the procedure.</li> </ul>
	<b>Edit</b>	<ul style="list-style-type: none"> <li>➤ If you want to delete a specific <i>Speed Dial</i> number from the <i>Group</i>, press the [Speed Dial] key. The display shows [Delete].</li> <li>To add a new number, press the [Speed Dial] key, the display shows [Add].</li> <li>➤ Press [Enter]. Repeat the procedure until all the editing has been completed.</li> <li>➤ Press the [Menu/Exit] key when you have finished editing. The name appears in the upper line of the display. Change the name if required and press [Enter].</li> </ul>
	<b>Delete</b>	
<b>MSG Confirm</b>	<b>On</b>	Sets the machine to print a transmission report for every fax transmission.
	<b>Off</b>	De-activates printing a transmission report.
	<b>On-Err</b>	Sets the machine to print a transmission report only if an error has occurred.

<b>Auto Reduction</b>	<b>On</b>	Use to activate the machine performing an automatic reduction for over-sized fax jobs.
	<b>Off</b>	Use to de-activate the automatic reduction. Over-sized jobs are printed on two pages.
<b>Prefix Dial</b>	<b>Up to 5 digits</b>	The number entered will be added to the beginning of each fax sent.
<b>Auto Report</b>	<b>On</b>	Use to enable a report listing details about the previous 50 communication operations.
	<b>Off</b>	
<b>ECM Mode</b>	<b>On</b>	Use to switch on <i>ECM</i> for all transmissions. Transmission time may be increased when <i>ECM</i> is enabled.
	<b>Off</b>	Use to switch off <i>ECM</i> .
<b>Redials</b>	<b>[0 - 13]</b>	Use to set the number of redial attempts.
<b>Ring to Answer</b>	<b>[1 - 7]</b>	Use to set the number of rings before answering. This feature is disabled when <i>Receive Mode</i> is set to <i>Ans/Fax</i> .
<b>Redial Term</b>	<b>[1 - 15]</b>	Use to set the number of minutes between redial attempts.
<b>Ringer</b>	<b>Off</b>	Use to set the ringer volume.
	<b>Low</b>	
	<b>Med</b>	
	<b>High</b>	
<b>Junk Fax Setup</b>	<b>On</b>	Use to restrict receipt of junk mail by only allowing faxes to be received from remote machines registered on your machine.
	<b>Off</b>	
<b>Secure Receive</b>	<b>On</b>	Use to set the default option for receiving secure faxes. To switch <i>On</i> , enter passcode, then confirm passcode. To switch <i>Off</i> , enter current passcode. Any secure faxes still in memory will be printed.
	<b>Off</b>	

<b>Fax Auto Tray</b>	<b>Tray 1</b>	Selects the default <i>Paper Tray</i> for <i>Fax</i> jobs.
	<b>Tray 1 &amp; Tray 2</b>	
	<b>All</b>	
<b>Dial Mode</b>	<b>Tone</b>	Selects the default <i>Dial Mode</i> .
	<b>Pulse</b>	
<b>DRPD Mode</b>	<b>Set</b>	<p>You can receive a call using the Distinctive Ring Pattern Detection (DRPD) feature that enables a user to use a single telephone line to answer several different phone numbers. In this menu you can set the machine to recognize which ring patterns to answer.</p> <p>Before using the Distinctive Ring Pattern Detection option, Distinctive Ring service must be installed on your telephone line by the telephone company. To set up Distinctive Ring Pattern Detection you will need another telephone line at your location or someone to dial your fax number from outside.</p> <p>To set up the DRPD mode:</p> <p>From [Fax Setup]:</p> <ul style="list-style-type: none"> <li>➤ Press the scroll button ◀ or ▶ until you see [DRPD Mode] on the bottom line and press [Enter].</li> <li>➤ When [Set] is displayed on the bottom line, press [Enter]. [Waiting Ring] appears on the display.</li> <li>➤ Call your fax number from another telephone. It is not necessary to place the call from a fax machine.</li> <li>➤ When your machine begins to ring, do not answer the call. The machine requires several rings to learn the pattern.</li> </ul>



# 6 Print

---

*Direct Printing* using a *USB* or *Parallel Port* connection is available as standard on the *Xerox WorkCentre 4118*.  
*Networked Printing*, including a PostScript driver, is available as an option.

- Printing a Document ..... 6-2
- Printer Settings ..... 6-3
- PCL Driver ..... 6-5

# Printing a Document

The *Xerox WorkCentre 4118* supports printing from these operating systems:

- Windows XP
- Windows 2000
- Windows NT V4.0
- Windows 98/Millennium Edition
- Mac OS10.3 and Linux are supported in the optional Network Kit

Your *Workstation* and the *Xerox WorkCentre 4118* must be connected and configured for printing from these environments.

A PCL print driver is supplied as standard and a PostScript driver is supplied in the optional Network Kit.



*Instructions for loading drivers and connecting the machine via USB or Parallel port are provided in the Getting Started chapter. For network connections, refer to the System Administration Guide supplied with your Xerox WorkCentre 4118, or contact your System Administrator.*

---

Prior to printing, ensure all relevant connections have been made, the machine is powered on and there is paper in the paper tray.

- 1** ➤ Start the program you are using to create the document and create or open the document requiring printing.
- 2** ➤ Select [Print] or [Print Setup] from the *File* menu.  
Ensure that your *Xerox WorkCentre 4118* is selected as your default printer.
- 3** ➤ Select [Properties] if you want to make any programming selections for your print job.  
➤ Select [OK] to close the *Properties* dialog box.
- 4** ➤ Select [OK] to process and send the print job.  
The job will automatically be printed on your machine.

# Printer Settings

Most Windows software applications allow you to make changes to the printer settings. This includes settings that determine how a print job looks such as paper size, paper orientation, and margins.

Settings made in the application to create the document will usually override settings made in the printer driver.



*You do not need to use any of the control panel keys to use the machine as a printer. For example, if you want to adjust the printing contrast you select the settings in the printer driver, not the **Lighten/Darken** feature on the machine's control panel.*

---

## Accessing Printer Settings

You can access printer settings by using either of these methods.

### **Windows 98/Me**

- Select *File > Print > Properties* or *File > Print Setup* from within any Windows application.

**OR**

- Select *Xerox WorkCentre 4118* printer from the *Printers* folder, then select *File > Properties* (or select the printer icon in the *Printers* folder, and click the right mouse button).

### **Windows NT 4.0**

- Select *File > Print > Properties* or *File > Print Setup* from within any Windows application.

**OR**

- Select *Xerox WorkCentre 4118* printer from the *Printers* folder, click the right mouse button, then select *Document Defaults* from the drop-down list.

### **Windows 2000**

- Select *File > Print* from within any Windows application.

**OR**

- Select *Xerox WorkCentre 4118* printer from the *Printers* folder, click the right mouse button, then select *Properties* and *Printing Preferences* from the drop-down list.

## **Windows XP**

- Select *File > Print > Properties* from within any Windows application.
- Select *Xerox WorkCentre 4118* printer from the *Printers and Faxes* folder, click the right mouse button, then select *Printing Preferences* from the drop-down list.



When the *Printer Properties* are displayed, the print job settings can be reviewed and changed. The *Properties* window consists of six tabs:

- Layout
- Paper
- Image Options
- Output Options
- Watermark
- About

If the *Printer Properties* are accessed through the *Printers* folder, additional Windows-based tabs are available.



*For information on the Windows-based tabs, refer to documentation provided with Windows.*

---

For detailed information about the printer settings available on each tab, please refer to the printer driver on-line *Help*.



*If you access Printer Properties through the Printers folder, any settings made will become the default settings for the printer. Settings made when Printer Properties are accessed through an application File menu and Print or Print Setup will remain active until the application you are printing from is closed.*

---

# Layout Tab

## Landscape

Use to print across the length of the page, spreadsheet style.

## Portrait

Use to print across the width of the page, letter style.

## Rotate 180 Degrees

Use to rotate the images 180 degrees.

## Long Edge

Use this option when you require 2 sided output in a *Book* orientation.

## Short Edge

Use this option when you require 2 sided output in a *Calendar* orientation.

## More Layout Options

Provides access to additional layout features such as multiple pages per side, poster, booklet printing, fit to page and reduce/enlarge.

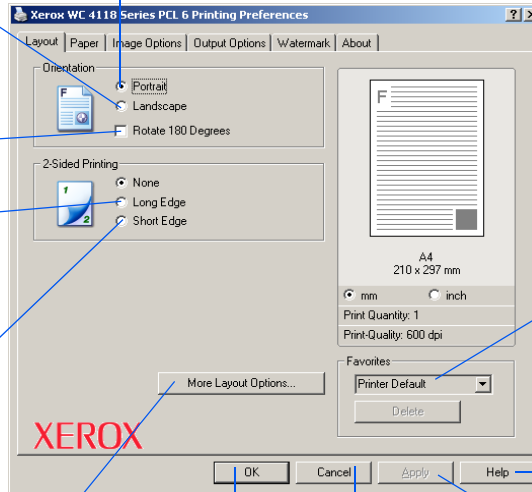

## Favorites

Use this option to store your selections for a particular job. After making selections, enter a job title in the window and select [Save].

## Help

Use to access the *Help* system which provides detailed information about all the Print Driver features.

## OK

Use to accept the selections made and close the dialog.

## Cancel

Closes the dialog and returns all settings to the values in place before the dialog was opened.

## Apply

Saves all the selections made without closing the dialog.

**Size**  
Use to select the size of paper required from the drop down menu.

**Print Quantity**  
Use to select the number of prints required.

**Custom**  
Use to enter a customized paper size.

**Type**  
Use to select the type of paper required.

**Source**  
Use to select the required paper source for the job.

**Cover Page**  
Use to select the required paper source for a cover page.

**Banner Page**  
Use to select whether a banner page is required.

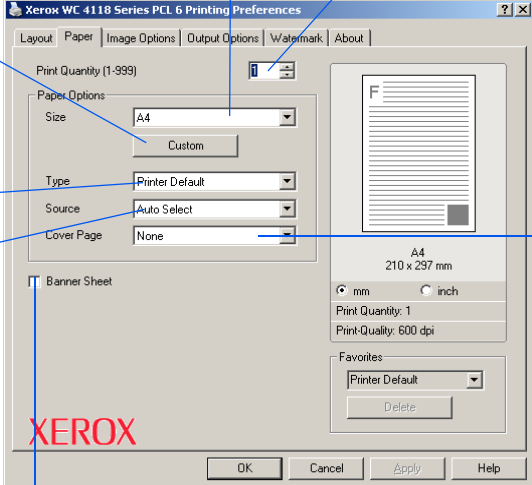

The screenshot shows the 'Paper' tab of the 'Xerox WC 4118 Series PCL 6 Printing Preferences' dialog box. The 'Paper Options' section includes a 'Size' dropdown menu set to 'A4', a 'Custom' button, a 'Type' dropdown menu set to 'Printer Default', a 'Source' dropdown menu set to 'Auto Select', and a 'Cover Page' dropdown menu set to 'None'. The 'Banner Sheet' checkbox is checked. The 'Print Quantity' is set to 1. The 'Print-Quantity' is set to 600 dpi. The 'Favorites' section shows 'Printer Default' as the selected favorite. The 'XEROX' logo is visible in the bottom left corner. The 'OK', 'Cancel', 'Apply', and 'Help' buttons are at the bottom.

### Print Quality Mode

Use to select the print resolution. 1200 dpi produces the highest quality output, 600 dpi is the lowest.

### Image Quality

Use to select the *Image Quality* setting to apply to the job. The options available depend on the resolution selected.

### Toner Save Mode

Use to activate *Toner Save* mode. Produces a lower quality output and uses less toner.

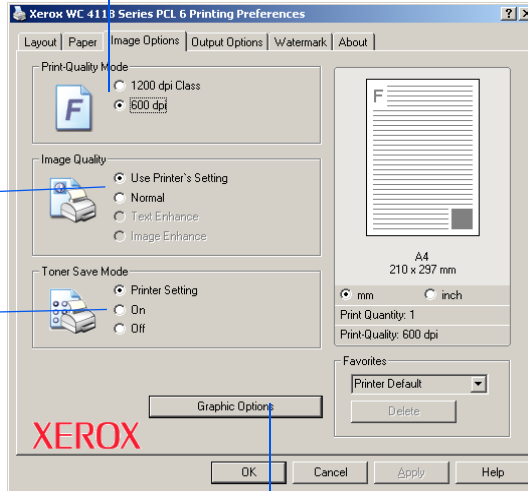

### Graphic Options

Provides access to additional options which allow you to select to print your output as graphics or bitmaps. You can also select to print all text in black.

# Output Options Tab

## Print Order

Use to select a sequence for your print job. Select whether to reverse all pages, print odd pages or print even pages.

## Use Print Fonts

If this option is selected the fonts which are resident on the printer will be used for the job.

## Collate

Select to produce collated output

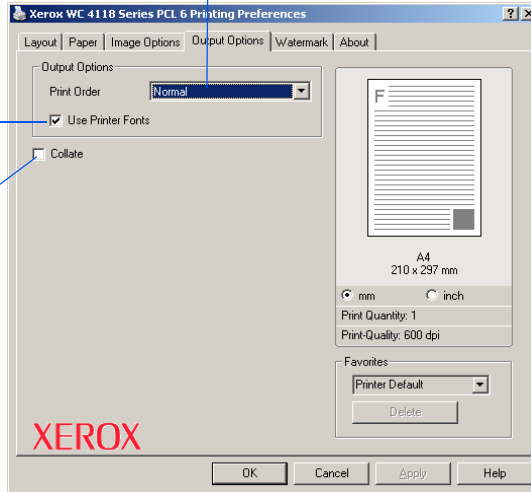

# Watermark Tab

## Current Watermarks

*Watermarks* are background images which print on each page. They are useful for adding information such as Draft or Confidential, or the name of your company. Select the *Watermark* required from the list shown, or create a new *Watermark*.

### Add, Update and Delete

Use these options to create new *Watermarks*, edit *Watermarks* or delete a *Watermark*.

### Watermark Message

Use this window to enter the text you would like to add as a *Watermark*.

### First Page Only

Select this option if you want the *Watermark* to print on the first page only, and not the rest of the document.

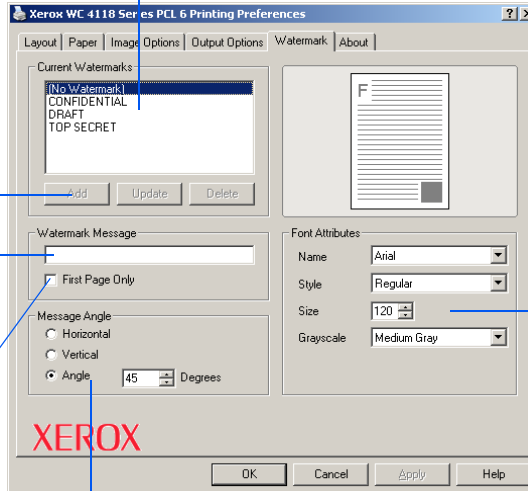

### Font Attributes

Select the font type, style, size and greyscale to use for your *Watermark*.

### Message Angle

Select to print the *Watermark* horizontally, vertically or a specified angle.

## About Tab

The *About Tab* provides information about the printer driver. It provides the program version number and copyright information relating to the printer driver. Clicking on this page will connect you to the Xerox website, provided you have access to the Internet.

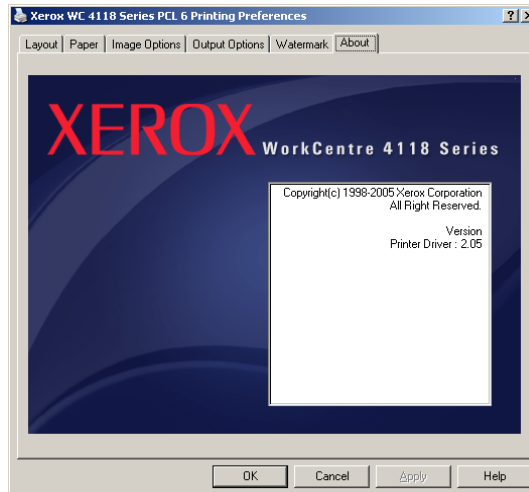





# 7 Scan (4 in 1 only)

---

*Direct Scanning* using a *USB* or *Parallel Port* connection is available as standard on the *Xerox WorkCentre 4118, 4 in 1*. A color scanner is provided as standard.

- TWAIN Scanner Program . . . . . 7-2
- TWAIN Scanning Procedure . . . . . 7-3
- Scanning Using the WIA Driver . . . . . 7-6

# TWAIN Scanner Program

The *Xerox WorkCentre 4118 TWAIN Scanner* program is used to scan images, graphics, photographs, and printed text. Documents can be fed from the *Document Feeder* or placed on the *Document Glass*.

The TWAIN driver is a program for PC printing that supports Windows 98, Windows NT4.0, Windows 2000, Windows ME and Windows XP environments. Using an independent protocol and the *USB* or parallel port, the TWAIN driver converts the scanned image into a standard format that you can edit.

Macintosh 10.3 or higher and Linux TWAIN Scanning are supported with the Network / PS3 Kit.

# TWAIN Scanning Procedure

## 1 Open the Image Editing Application

- For instructions on loading media, refer to "Loading Paper" on page 4-2.

For full media specifications refer to "Media Specifications" on page 11-7.

- Open your image editing application and acquire the WorkCentre 4118 TWAIN Scanner.

This feature allows you to convert hard copy images into electronic images that you can use in other documents.

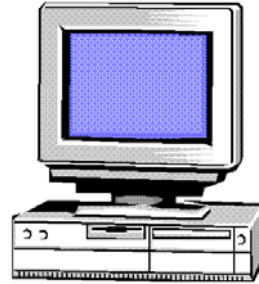

## 2 Load the Originals

### Document Feeder:

- Remove all staples and paper clips prior to loading.
- Adjust the sliding document guides to the size required.
- Insert the originals neatly into the Document Feeder, face up.

The first page should be on top with the headings towards the back or left of the machine.

- Align the stack with the left and rear edges of the tray. Adjust the guides to just touch the edges of the originals.

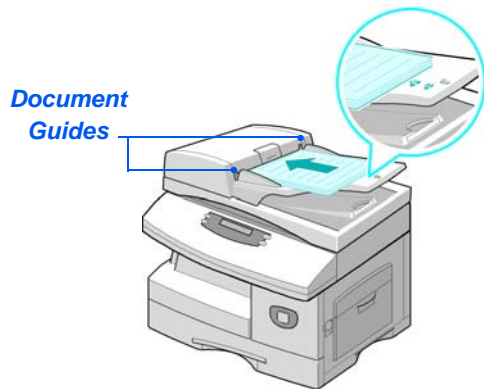

- When using the Document Glass, ensure there are no documents in the Document Feeder.

Leaving the Document Feeder open while scanning will affect the image quality.

- ① Up to 40 sheets of 80 g/m<sup>2</sup> (20lb bond) paper can be loaded. Weight ranges from 45 - 105 g/m<sup>2</sup> (12.5 - 28lb). Sizes range from B5 to Legal (7" x 10" to 8.5" x 14"). Refer to "Scanner and Copier Specifications" on page 11-5 for full Document Feeder specifications.

### Document Glass:

- Raise the Document Feeder and position the original face down on the Document Glass.
- Align with the registration arrow in the rear left corner.
- Lower the Document Feeder.

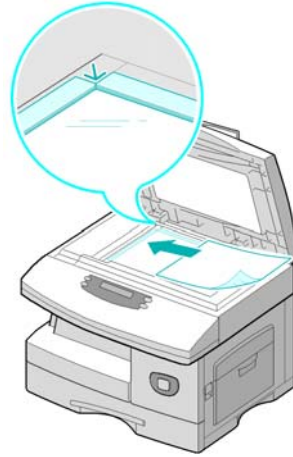

## 3 Select the Scan Features

- For Scanner specifications refer to "Scanner and Copier Specifications" on page 11-5.
- Select [New Scan] in your application to access the TWAIN driver options.
- Customize the settings available on the TWAIN driver for the job, for example *Image Type*, *Resolution*, *Document Type* and *Enlarge/Reduce*.

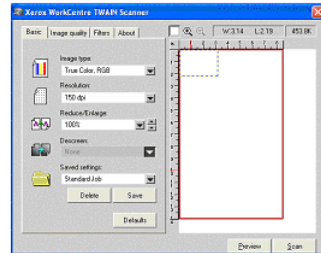

## 4 Select Preview

- Select the [Preview] option on the TWAIN driver window.

The image displays on the screen. This gives you the opportunity to select the specific area you wish to scan.

- If necessary, drag the selection tool to the area requiring scanning.

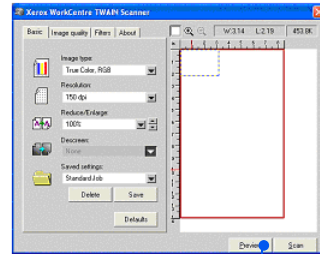

Preview

## 5 Select Scan

- Select the [Scan] option on the TWAIN driver window.

The specified image displays on the screen.

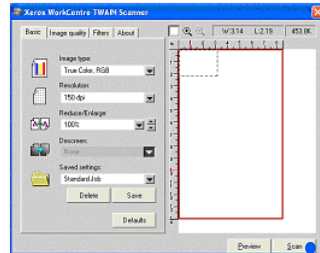

Scan

## 6 Save the Image

- Select [File] and [Save].

The image is saved and can now be used in another document if required.

- Remove your original from the *Document Glass* or *Document Feeder*.

# Scanning Using the WIA Driver

Your machine also supports the *Windows Image Acquisition (WIA)* driver for scanning images. *WIA* is one of the standard components provided by Microsoft® Windows® XP and works with digital cameras and scanners. Unlike the TWAIN driver, the *WIA* driver allows you to scan and easily manipulate images without using additional software.

 *The WIA driver works only on Windows XP with USB port.*

## WIA Scanning Procedure

- 1 ➤ Load the document(s) face up into the *Document Feeder*.  
**OR**  
Place a single document face down on the *Document Glass*.
- 2 ➤ From the *Start* menu on your desktop window, select [Settings], [Control Panel], and then [Scanners and Camera].
- 3 ➤ Double click your scanner driver icon. The *Scanner and Camera Wizard* launches.
- 4 ➤ Choose your scanning preferences and click [Preview] to see how your preferences affect the picture.

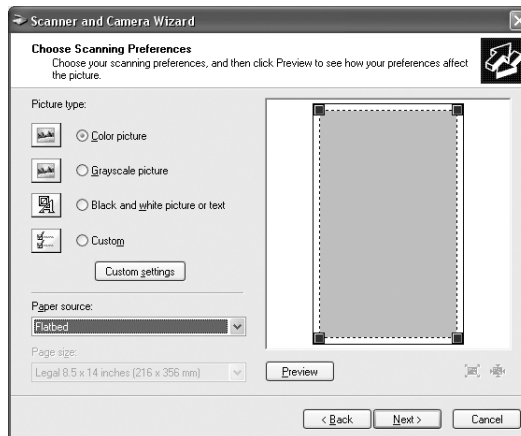

- 5 ➤ Click [Next].

6

➤ Enter a picture name, and select a file format and destination to save the picture.

7

➤ Follow the on-screen instructions to edit the picture after it is copied to your computer.



*If you want to cancel the scan job, press the Cancel button on the Scanner and Camera Wizard.*

---





# 8 Machine Administration

---

*The Xerox WorkCentre 4118 can be customized to meet your individual requirements.*

- Reports ..... 8-2
- ControlCentre ..... 8-4
- Passcode Protection ..... 8-7
- Clear Memory ..... 8-9
- Maintenance Tools..... 8-10
- Enabling or Disabling Auxiliary Access ..... 8-13

# Reports

Various Reports are available to assist in confirming and monitoring machine activity. Reports can be set up to include specific information, or to print automatically.

## Reports Available

REPORT	DESCRIPTION
<b>Fax Phonebook</b>	This list contains all the numbers currently stored in the machine's fax phonebook as <i>Speed Dial</i> and <i>Group Dial</i> numbers.
<b>Fax TX</b>	This report contains information about recent transmission activities.
<b>Fax RX</b>	This report contains information about recent reception activities.
<b>System Data</b>	This report shows the status of the user-selectable options. After settings are changed, print this list to confirm your changes.
<b>Scheduled Jobs</b>	This list identifies the documents currently stored for <i>Delay Send</i> , <i>Priority Send</i> , <i>Group Dial</i> and <i>TX Poll</i> operations. This list shows the starting time and type of operation.
<b>Fax TX Confirm</b>	This list shows a list of confirmed fax transmissions.
<b>Junk Fax List</b>	This list shows the fax numbers defined as junk fax numbers by using the <i>Junk Fax Setup</i> menu.
<b>Billing Counters</b>	This report lists the billing counters and their current amounts.
<b>Connect Page</b>	Provides connection information when the optional Network Kit is installed.
<b>Print All Reports</b>	Use this option to print all the available reports.

# Printing Reports

Use the following instructions to print a report.

**1**

- Press the [Machine Status] key.

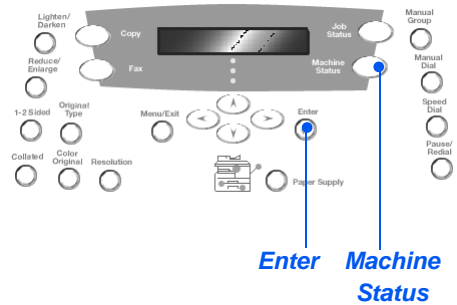

**2**

- Using the *Navigation Keys* select [Reports] and press [Enter].

**3**

- Using the *Navigation Keys* select the required report and press [Enter].  
The report is processed and printed.

# ControlCentre

*ControlCentre* is software available for the *Xerox WorkCentre 4118* which enables *Fax* and *Print* options and features to be setup and viewed remotely using a PC. This tool also enables firmware upgrades.

After setting up *Fax* options, creating phonebooks or setting *Print* options simply click [Apply] on the *ControlCentre* screen to download the new settings to the machine.

## Installing ControlCentre

When *Xerox WorkCentre 4118* software is installed the *ControlCentre* utility is installed automatically.



For information on installing refer to “Maintenance Tools” on page 8-10.

---

## Running ControlCentre

Use the following instructions to run *ControlCentre*:

1

➤ Start the *Windows* software.

2

➤ From *Programs* select [*Xerox WorkCentre 4118*], then [*ControlCentre*].

The *ControlCentre* screen displays.

## Using ControlCentre

The *ControlCentre* software provides three tabs:

- Phonebook (4 in 1 only)
- Firmware Update
- Printer

To exit *ControlCentre*, click the [Exit] key in the bottom of each tab screen.

For further details, click the [Help] key in the bottom of each tab screen.



When the settings on *ControlCentre* are changed, or when *ControlCentre* is run, the settings on the machine and on *ControlCentre* will be automatically updated to the latest settings made either on the machine or on *ControlCentre*.

---

## Phonebook Tab (4 in 1 only)

Click on the [Phonebook] tab to create and edit phonebook entries for use with Fax.

The screenshot shows the ControlCentre application window with the Phonebook tab selected. The interface includes a menu bar (File, About), a toolbar (Phonebook, Printer, Firmware Update), and a main area with a 'Type' dropdown set to 'Speed dial (1 ~ 200)'. There are 'Read' and 'Write' buttons with instructions: 'Press Read button to retrieve phone numbers from the printer.' and 'Press Write button to save phone numbers to the printer.' Below this is a table with columns 'No.', 'Name', and 'Phone Number', containing entries numbered 1 through 12. At the bottom, there are buttons for 'Edit', 'Delete', 'Delete All', 'Group dial...', 'Exit', and 'Help'. Blue callout lines point to these elements with the following text:

- Phonebook entries** (points to the table)
- Retrieves the phonebook entries from the Xerox WorkCentre 4118 to ControlCentre** (points to the Read button)
- Allows a selected phonebook entry to be edited in a separate Edit dialog box** (points to the Edit button)
- Deletes a selected phonebook entry** (points to the Delete button)
- Deletes all phonebook entries** (points to the Delete All button)
- Allows the phonebook entries to be downloaded from ControlCentre to the Xerox WorkCentre 4118** (points to the Write button)

## Firmware Update Tab

Click on the [Firmware Update] tab to update the firmware of the machine.

- This feature should be used by System Administrator only. For further information, please refer to the System Administration Guide.

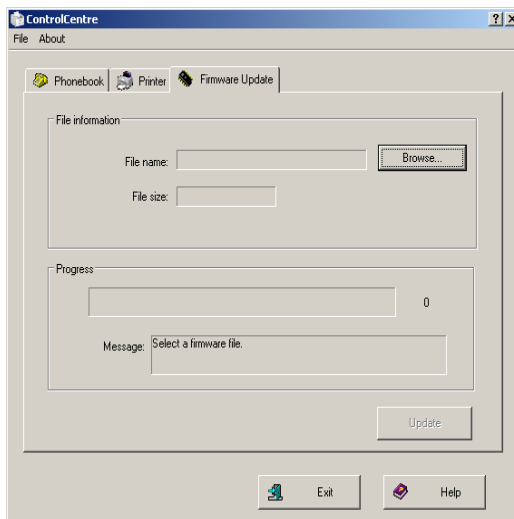

## Printer Tab

Click on the [Printer] tab to set default print options.

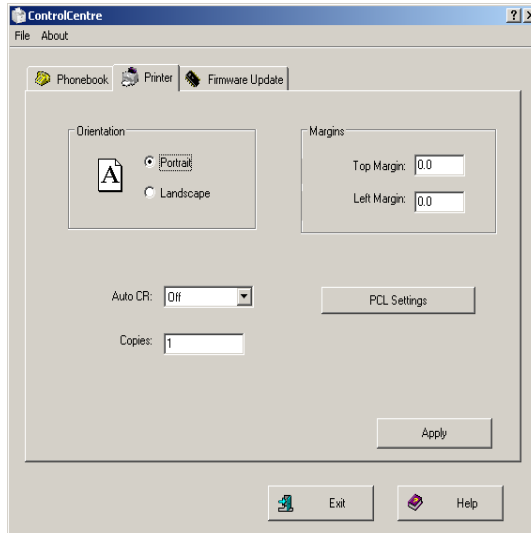

## PCL Button

Click on the [PCL] button on the Printer tab to set options for PCL printing.

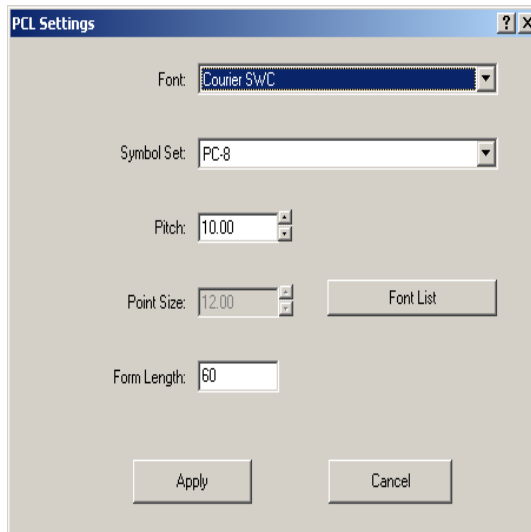

# Passcode Protection

System Administration functions can be restricted to individual users by requiring that a passcode be entered before access to the functions can be granted.

## Enable Passcode Protection

- 1 ➤ Press the [Machine Status] key.
- 2 ➤ Using the *Navigation Keys* select [System Admin Tools] and press [Enter].  
If the *System Admin Tools* have already been passcode protected, type in the password and press [Enter].
- 3 ➤ Select [Passcode Protect] using the *Navigation Keys* and press [Enter].



*When the machine is first installed, the passcode is blank. When you choose Yes, you will be asked to enter the passcode. Simply press [Enter] when requested to enter the passcode.*

- 4 ➤ Using the *Navigation Keys* select the *Function* to protect from the table below and press [Enter].
- 5 ➤ Using the *Navigation Keys* select the *Permissions* from the table below for the function you chose in the previous step. Press [Enter].

FUNCTION	PERMISSIONS
Machine Setup	Protect All
	Allow All
	Allow Tray Sizes
Fax Setup	Protect All
	Allow All
	Allow Speed Dials
	Allow Group Dials
	Allow Speed and Group Dials

<b>System Admin</b>	Protect All
	Allow All
<b>Reports</b>	Protect All
	Allow All

- **6** To protect more *Functions* select [Yes], press [Enter] and repeat steps 4 and 5.  
To end, select [Done] and enter the passcode.
- **7** If you enabled *Passcode Protection*, refer to “*Change the Passcode*” starting on page 8-8 to enter the new passcode.

## Change the Passcode

This procedure is used to change an existing passcode or to enter a passcode after *Passcode Protect* has been enabled.

- **1** Press the [Machine Status] key.
- **2** Using the *Navigation Keys* select [System Admin Tools] and press [Enter].  
➤ If the *System Admin Tools* have already been passcode protected, type in the password and press [Enter].
- **3** Select [Change Passcode] using the *Navigation Keys* and press [Enter].  
➤ Enter the existing passcode and press [Enter].

---

 This will be blank if you have just enabled *Passcode Protection*

---

- **4** Enter the new passcode and press [Enter].
- **5** Confirm the new passcode and press [Enter].



# Clear Memory

This tool is provided to let you clear the data from selected areas of memory. For *Fax*, you can clear the phonebook and both receive and transmit history data.

## Clearing the Memory

- **1** Press the [Machine Status] key.
- **2** Using the *Navigation Keys* select [System Admin Tools] and press [Enter].
  - If the *System Admin Tools* have already been passcode protected, type in the password and press [Enter].
- **3** Select [Clear Memory] using the *Navigation Keys* and press [Enter].
  - Select the option required and press [Enter].

The choices are:

*System Data*

*Fax Phone Book*

*Fax RX History*

*Fax TX History*

# Maintenance Tools

A number of maintenance tools are provided in *System Admin Tools*:

- Serial Number
- Notify Toner Low
- New Drum
- Clean Drum
- Billing Counters



*These tools can also be accessed using Xerox CentreWare, refer to the System Administration Guide for more information.*

---

## Check the Serial Number

- 1** ➤ Press the [Machine Status] key.
- 2** ➤ Using the *Navigation Keys* select [System Admin Tools] and press [Enter].  
➤ If the *System Admin Tools* have already been passcode protected, type in the password and press [Enter].
- 3** ➤ Select [Maintenance] and press [Enter].  
➤ Select [Serial Number] and press [Enter].  
The serial number of the *Xerox WorkCentre 4118* is displayed.  
➤ Press [Menu/Exit] to exit this function.

## Notify Toner Low

If the *Notify Toner* option is set to *On*, when the toner cartridge needs to be replaced, the machine automatically sends a fax to the service company or the dealer to notify them that the machine requires a new toner cartridge. This feature will be activated only when the phone number of the service company or the dealer is stored in the machine's memory.

- 1 Press the [Machine Status] key.
- 2 Using the *Navigation Keys* select [System Admin Tools] and press [Enter].
  - If the *System Admin Tools* have already been passcode protected, type in the password and press [Enter].
- 3 Select [Notify Toner Low] and press [Enter].
- 4 Select [On] and press [Enter].
  - When prompted, enter:
    - Your Customer Number*
    - Your Customer Name*
    - The Supplier's Fax Number*
    - The Suppliers Name*

## New Drum

This function is used to reset the drum counter after the drum has been replaced.

- 1 Press the [Machine Status] key.
- 2 Using the *Navigation Keys* select [System Admin Tools] and press [Enter].
  - If the *System Admin Tools* have already been passcode protected, type in the password and press [Enter].
- 3 Select [New Drum] and press [Enter].
  - To set the drum counter to zero, select [On] and press [Enter]. Otherwise, select [Off] and press [Enter] to exit the selection.

## Clean Drum

If streaks or spots appear on the prints, the drum cartridge may require cleaning. Ensure that paper is loaded prior to selecting this option.

- **1** Press the [Machine Status] button.
- **2** Using the *Navigation Keys* select [System Admin Tools] and press [Enter].
  - If the *System Admin Tools* have already been passcode protected, type in the password and press [Enter].
- **3** Select [Clean Drum] and press [Enter].

The *Xerox WorkCentre 4118* will print a special cleaning page.

## Billing Counters

Billing can display the contents of a number of counters used in the *WorkCentre 4118*. These counters are:

- *Total Impressions* - the total number of prints produced by the machine.
- *Toner Impressions* - the number of prints produced by the toner.
- *Drum Impressions* - the number of prints produced by the drum.
- *ADF Scan Page* - the number of originals scanned from the *Document Feeder*.
- *Platen Scan Page* - the number of originals scanned from the *Document Glass*.
- *Replaced Toner* - the number of prints since the toner was last replaced.
- *Replaced Drum* - the number of prints since the drum was last replaced.

- **1** Press the [Machine Status] key.
- **2** Using the *Navigation Keys* select [System Admin Tools] and press [Enter].
  - If the *System Admin Tools* have already been passcode protected, type in the password and press [Enter].
- **3** Select [Billing] and press [Enter].
  - Select the required *Counter* and press [Enter].

# Enabling or Disabling Auxiliary Access

*Auxiliary Access* is available as an option. It allows a foreign interface board to be recognized. Use these instructions to enable or disable *Auxiliary Access*:

- Press the [Machine Status] key.

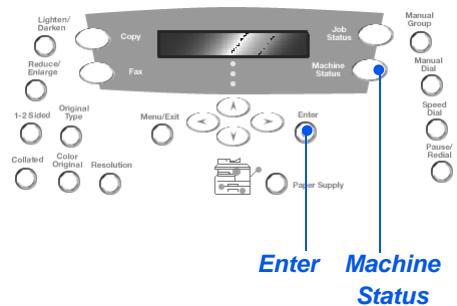

- Using the *Navigation Keys* select [System Admin Tools] and press [Enter].
- If the *System Admin Tools* have already been passcode protected, type in the password and press [Enter].
- Select [Auxiliary Access] and press [Enter].
- To enable *Auxiliary Access*, select [On] is displayed and press [Enter]. Otherwise, select [Off] and press [Enter].



# 9 Maintenance

---

Performing the maintenance tasks enables your machine to continue running at optimum performance. Instructions are provided in this chapter for all the maintenance tasks required.

- Cleaning . . . . . 9-2
- Ordering Supplies . . . . . 9-4
- Customer Replaceable Units . . . . . 9-5

# Cleaning

## Cleaning the Document Glass and Constant Velocity Transport (CVT) Glass

Keeping the *Document Glass* clean helps ensure the best possible output. It is recommended that the *Document Glass* is cleaned at the start of each day and during the day as needed.

The Constant Velocity Transport (CVT) glass is the strip of glass located to the left of the *Document Glass* and is used to scan originals fed through the *Document Feeder*. The CVT glass also requires cleaning.



**CAUTION: DO NOT use organic or strong chemical solvents or aerosol cleaners or pour fluids directly onto any area. Use supplies and cleaning materials only as directed in this documentation. Keep all cleaning materials out of the reach of children.**



**WARNING: DO NOT remove the covers or guards that are fastened with screws or attempt any maintenance procedure that is not specifically described in this documentation.**

- Slightly dampen a soft lint-free cloth or paper towel with water.
- Open the *Document Feeder*.
- Wipe the surface of the *Document Glass* and *CVT Glass* until they are clean and dry.
- Wipe the underside of the *Document Feeder* until it is clean and dry.
- Close the *Document Feeder*.

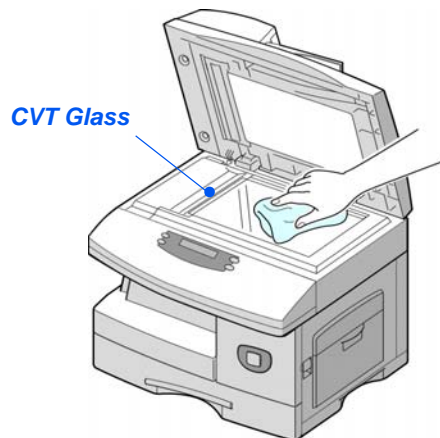



## ***Control Panel and LCD***

Regular cleaning keeps the *Control Panel* and *LCD* free from dust and dirt. To remove finger prints and smudges, clean the *Control Panel* and *LCD* screen with a soft, lint-free cloth, lightly dampened with water.

## ***Outside Areas of the Machine***

Use a cloth moistened with water to clean the outside areas of the machine.

# Ordering Supplies

The *Toner Cartridge* and the *Drum Cartridge* are available as customer replaceable units.

The customer replaceable unit part numbers are listed below:

CUSTOMER REPLACEABLE UNIT	PART NUMBER
Toner Cartridge	006R01278
Drum Cartridge	113R00671

To obtain supplies, contact your local Xerox representative, giving the company name, the product number and the machine serial number.

Use the space below to keep a record of the telephone number.

Supplies Telephone Number:

# \_\_\_\_\_

# Customer Replaceable Units

## Toner Cartridge

### **Expected Cartridge Life**

The life of the toner cartridge depends on the amount of toner used in each printed job. For instance, when printing a typical business letter with about 5% page coverage, expect a toner cartridge life of approximately 8,000 pages (4,000 pages only for the toner cartridge shipped with the machine). The actual number may vary according to the print density of the pages being printed. If printing a lot of graphics the cartridge may require changing more often.

### **Toner Save Mode**

The life of the toner cartridge can be extended by using *Toner Save* mode. The *Toner Save* mode uses less toner than normal printing. The printed image is much lighter, and is adequate for printing drafts or proofs.

---

 For instructions on setting the *Toner Save* mode refer to "Machine Setup" on page 2-20.

---

### **Replacing the Toner Cartridge**

When the toner cartridge is near the end of its life, white streaks or hue change will occur. The *LCD* displays a warning message 'Toner Low'.

When the 'Toner Low' message displays, remove the toner cartridge and gently shake it to temporarily re-establish the print quality. Shaking the cartridge re-distributes the remaining toner in the cartridge. This procedure can only be performed once prior to changing the *Toner Cartridge*.

1

- Pull the release latch to open the side cover.

---

**CAUTION: Ensure the side cover is always open before opening the front cover.**

---

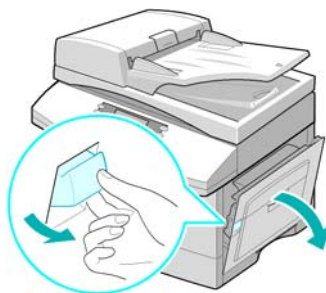

2

- Open the front cover.

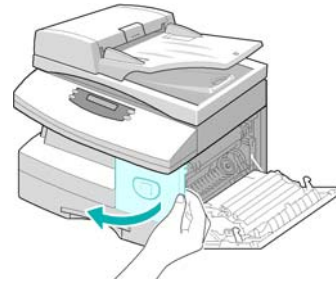

3

- Turn the cartridge locking lever upwards to release the toner cartridge.

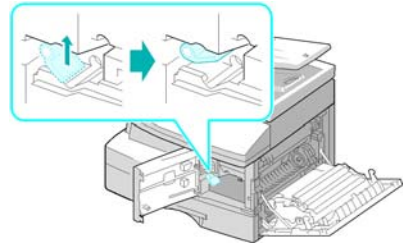

4

- If the toner gets on clothing, wipe it off with a dry cloth and wash clothing in cold water. Hot water sets toner into fabric.

#### **To Re-distribute the Toner:**

- Pull out the toner cartridge and gently shake the cartridge to distribute the toner evenly inside the cartridge.
- Reinstall the toner cartridge, then lock the lever.
- Close the front cover and the side cover.
- The display shows [New Toner?], select [No] and press [Enter].  
The machine returns to standby.

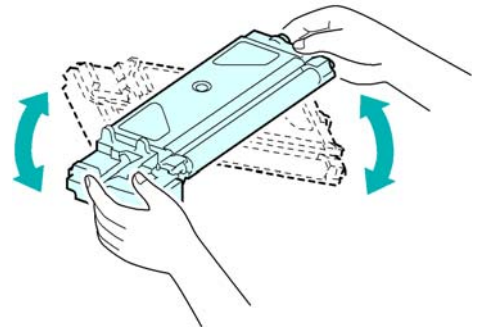

**5****Replacing the Toner Cartridge:**

- Shake the new toner cartridge horizontally four or five times.
- Slide the new toner cartridge in until it locks in place.
- Turn the toner locking lever downwards until it locks in place.
- Close the front cover and the side cover.
- The display shows [New Toner?], select [Yes] and press [Enter].

The machine returns to standby.

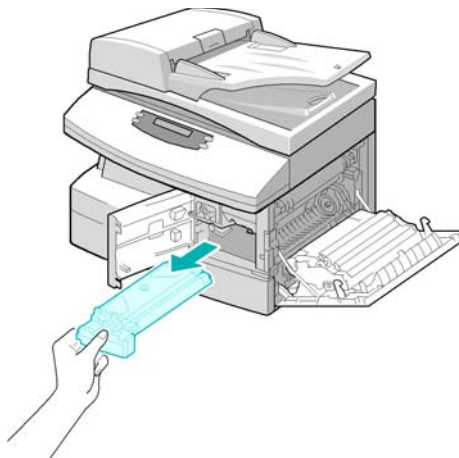
**Setting the Product to Send Toner Low Information**

If the *Notify Toner* menu option is set to *On*, when the toner cartridge needs to be replaced, the machine automatically sends a fax to the service company or the dealer to notify them that the machine requires a new toner cartridge. This feature will be activated only when the phone number of the service company or the dealer is stored in the machine's memory.



*For instructions on setting the Send Toner Low Information to On, refer to "Maintenance Tools" on page 8-10.*

## Drum Cartridge

The *Drum Cartridge* requires replacement when the drum life warning is displayed, after approximately 20,000 copies.

If streaks or spots are being experienced on the prints there is an option for cleaning the drum.

---

 For instructions on *Cleaning the Drum*, refer to “*Maintenance Tools*” on page 8-10.

---



---

**CAUTION:** Do not expose the green drum to light for an extended period. Never expose the drum to direct sunlight or touch the drum surface. Damage or poor image quality may result.

---

## Replacing the Drum Cartridge

The useful life of the drum cartridge is approximately 20,000 copies/prints. A high rate of 2 Sided copying/printing reduces the overall life of a drum. The machine displays ‘Drum Warning’ when the drum is near the end of life. Approximately 1,000 more copies/prints can be made, but a replacement cartridge should be available. Replace the drum cartridge when copy/print quality becomes degraded.

1

- Pull the release latch to open the side cover.

---

**CAUTION:** Ensure the side cover is always open before opening the front cover.

---

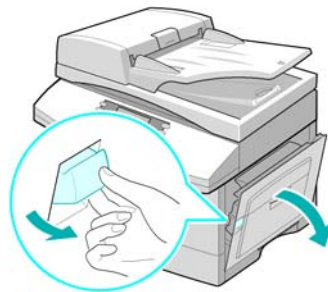

2

- Open the front cover.

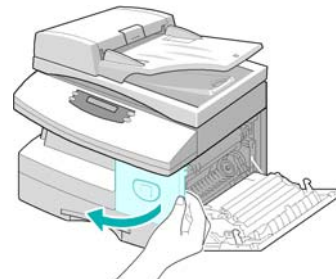

**3**

- *The toner cartridge must be removed to replace the drum cartridge.*

- Turn the cartridge locking lever upwards to release the toner cartridge.

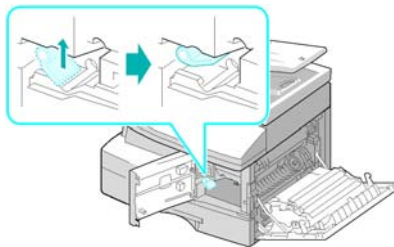
**4**

- Pull out the used drum cartridge.

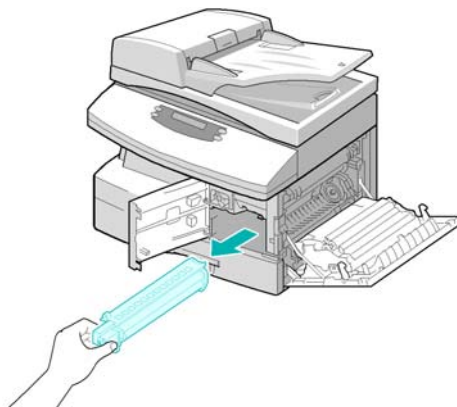
**5**

- Unpack the new drum cartridge and slide it in place, making sure not to touch the surface of the drum.

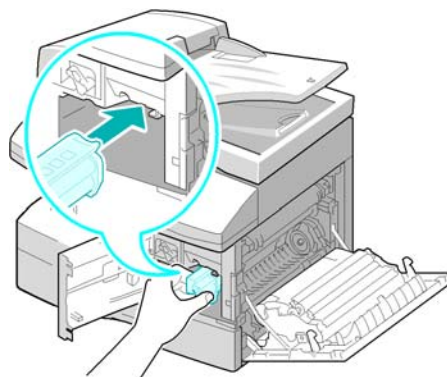

**6**

- Reinstall the toner cartridge, then lock the lever.
- Close the front cover and the side cover.
- The display shows [New Drum Unit?]. Select [Yes] and press [Enter].

The machine returns to Standby mode.

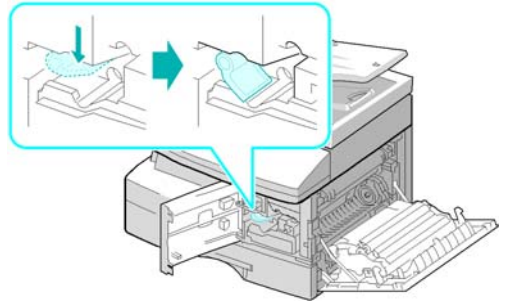

*If the counter is not reset, 'Drum Warning' may appear before the new drum reaches its maximum life. To reset the counter manually refer to the "Maintenance Tools" on page 8-10.*



# 10 Troubleshooting

---

If a problem occurs on your machine, the instructions in this chapter will enable you to identify and clear the fault, or locate further assistance.

- General . . . . . 10-2
- Fault Clearance . . . . . 10-3
- Customer Support . . . . . 10-10
- LCD Error Messages . . . . . 10-11
- Problem and Solutions Charts . . . . . 10-14

# General

A variety of situations can affect the quality of the output. For optimal performance, ensure the following guidelines are followed:

- Do not position the machine in direct sunlight or near a heat source such as a radiator.
- Avoid sudden changes in the environment surrounding the machine. When a change occurs, allow the machine at *least two hours* to adjust to its new environment, depending on the extent of the change.
- Follow routine maintenance schedules for cleaning areas such as the *Document Glass* and *Control Panel*.
- Always set the guides in the *Paper Trays* to the size of the media in the tray.
- Ensure paper clips and paper debris do not contaminate the machine.

# Fault Clearance

When a fault occurs, check the *Status Map* on the *Control Panel*. A red flashing LED identifies the problem area:-

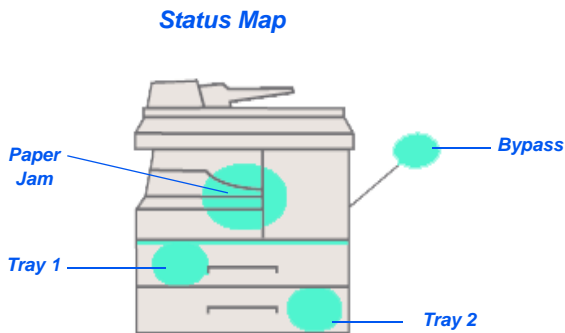

## Document Jams

If a document jams while it is feeding through the *Document Feeder*, 'Document Jam' displays and the *Document Jam LED* on the *Status Map* flashes.

Details for clearing the three areas of the *Document Feeder* are given below.

### Input Misfeed

- Open the *Document Feeder* top cover.



**2**

- Pull the document gently to the right and out of the *Document Feeder*.
- Close the *Document Feeder* top cover.
- Feed the documents back into the *Document Feeder*.



### **Exit Misfeed**

**1**

- Open the *Document Feeder* and turn the roller knob to remove the misfed documents from the exit area.

If the jammed document cannot be easily removed, skip to *Roller Misfeed*.



**2**

- Close the *Document Feeder* and reload the documents.

## ***Roller Misfeed***

**1**

- Open the *Document Feeder*.
- Turn the release knob to enable easy removal of the misfed document from the exit area. Carefully pull the document to the right using both hands.

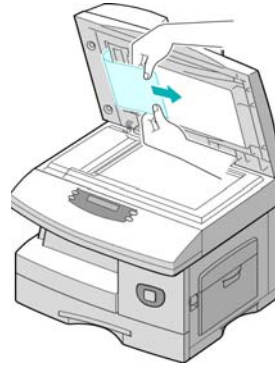
**2**

- Close the *Document Feeder* and reload the documents.

## Paper Jams

If paper jams occur, 'Paper Jam' displays and the *Paper Jam* or *Paper Tray LED* on the *Status Map* flashes to indicate the problem area. Follow the steps below to clear the jam. To avoid tearing paper, pull the jammed paper out gently and slowly.

### Paper Feed Area

If the paper jams in the feed area 'Paper Jam 0' displays.

**1**

- Pull out the *Paper Tray*.
- When the tray is fully out, lift the front part of the tray slightly to release the tray from the machine.

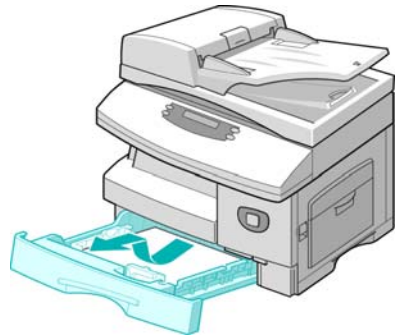
**2**

- Remove the jammed paper by gently pulling it straight out.
- Once you remove the jammed paper, open the side cover and close it to clear the 'Paper Jam 0' message from the display.

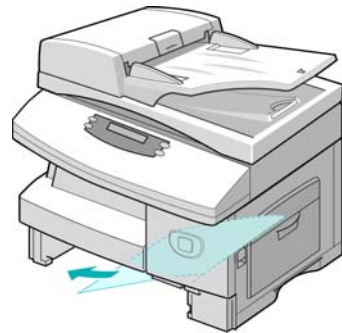
**3**

- If there is any resistance and the paper does not move immediately when pulled, pull the release lever to open the side cover.
- Carefully remove the misfed paper in the direction shown.



**4**

- Close the cover.
- Insert the paper tray. Lower the rear part of the tray to align the rear edge with the corresponding slot in the machine, then insert it completely.

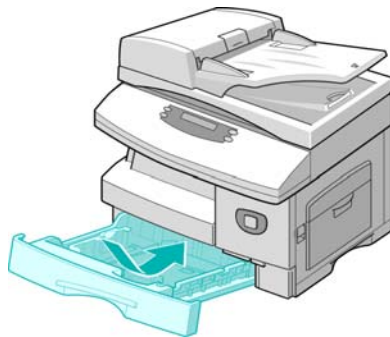

## Paper Exit Area

If the paper is jammed in the exit area, 'Paper Jam 2' displays.

**1**

- Pull the *Release Lever* to open the side cover.

**CAUTION: Ensure the side cover is always open before opening the front cover.**

- Open the front cover.

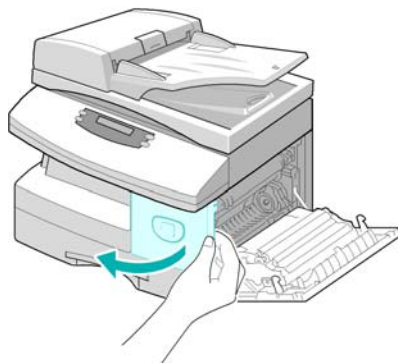

**2**

- Pull down on the *Fuser Lever*. This will release pressure on the paper.

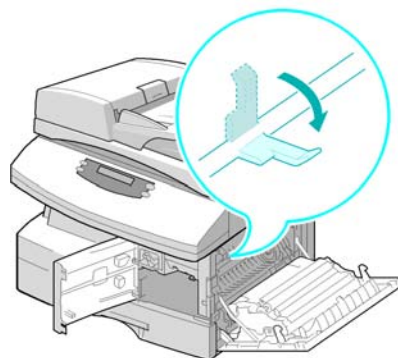

**3**

- Turn the *Jam Remove Lever* in the direction of the arrow to move the paper to the exit area.
- Gently pull the paper out through the exit area.

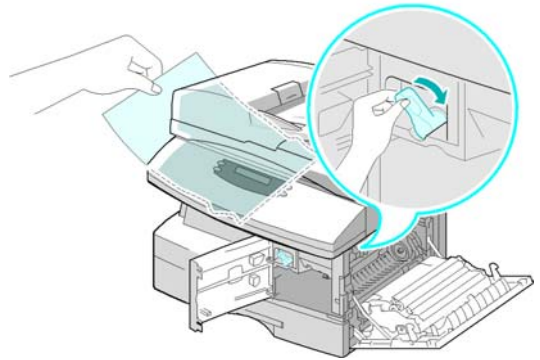

**4**

- Push the *Fuser Lever* up.

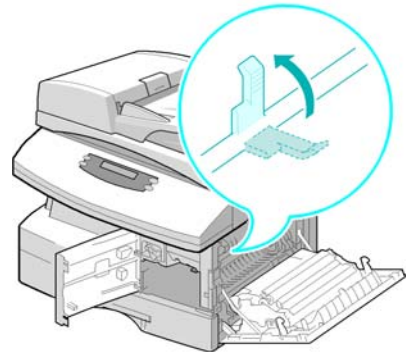

**5**

- Turn the *Jam Remove Lever* back to the original position.
- Close the front cover and side cover.

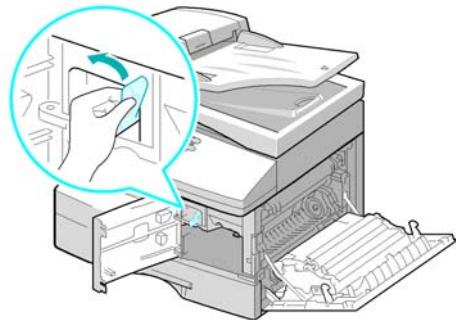



## 2 Sided Jam

If a paper jam occurs in the *2 Sided* module, 'Duplex Jam' displays and the *Paper Jam LED* on the *Status Map* flashes.

- Pull the *Release Lever* to open the side cover.
- Remove the jammed paper.

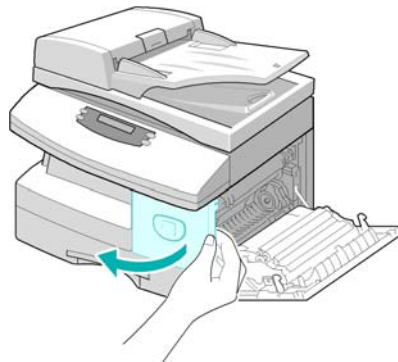

- Close the side cover.

## Bypass Tray Jam

If you try to print using the *Bypass Tray* and the machine does not detect paper due to no paper or improper paper loading, 'Bypass Jam' displays and the *Bypass Tray LED* on the *Status Map* flashes.

'Bypass Jam' may also occur when the paper has not fed correctly in the machine.

- Open the *Bypass Tray* and pull the paper out of the machine.



# Customer Support

If a fault cannot be resolved by following the *LCD* instructions, check the troubleshooting tables in the next section - they may help to solve the problem quickly.

If you need further assistance or information, please visit the Xerox website for online solutions and support:

<http://www.xerox.com>

If the problem persists, contact the *Xerox Welcome Center* or your local Xerox representative. The serial number of the machine will be required, together with any relevant error codes.

---

 For information on locating the serial number, please refer to "Customer Support" on page 1-5.

---

# \_\_\_\_\_

To access the serial number open the side cover using the release latch and then open the front door. The serial number is located on the panel above the *Toner Cartridge*.

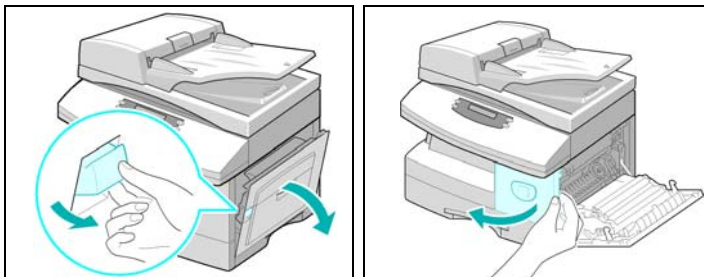

The *Xerox Welcome Center* or local representative telephone number is provided when the machine is installed. For convenience and future reference, please record the telephone number in the space below:

Xerox *Welcome Center* or local representative telephone number:

# \_\_\_\_\_

**Xerox US Welcome Center: 1-800-821-2797**

**Xerox Canada Welcome Center: 1-800-93-XEROX (1-800-939-3769)**

# LCD Error Messages

If an abnormal condition arises in the machine or an incorrect operation is performed, a message indicating the nature of the error is displayed. If this happens, take the corrective action listed in the following table.

DISPLAY	MEANING	SOLUTION
<b>Bypass Jam</b>	The machine detects non feeding from the <i>Bypass Tray</i> .	Open the side cover and remove any jammed paper.  Load paper in the <i>Bypass Tray</i> .
<b>Comm. Err</b>	The machine has a problem in communication.	Try resending the fax.
<b>Document Jam</b>	The loaded document has jammed in the <i>Document Feeder</i> .	Clear the document jam. Refer to " <i>Document Jams</i> " on page 10-3
<b>Door Open</b>	The side cover is not securely latched.	Close the side cover until it locks into place.
<b>Drum Warning</b>	The drum cartridge is near the end of life.	Ensure a replacement cartridge is in stock. Replace the drum cartridge when copy/print quality is degraded. This may show up as dark marks on the edge of the page. Refer to " <i>Drum Cartridge</i> " on page 9-8.
<b>Duplex Jam</b>	Paper has jammed in the middle of <i>2 Sided</i> printing.	Clear the jam. Refer to " <i>2 Sided Jam</i> " on page 10-9.
<b>Drum Empty</b>	The drum cartridge is empty	Replace the drum cartridge. Refer to " <i>Drum Cartridge</i> " on page 9-8.
<b>Fuser Error, Open Heat Error, Heating Error and Overheat</b>	There is a problem in the fuser unit.	Unplug the power cord and plug it back in. If the problem still persists, please call for service.
<b>Group Not Available</b>	You have tried to select a group.	Try again. Check location for a group.
<b>Incompatible</b>	Remote party did not have the requested feature such as polling.	

DISPLAY	MEANING	SOLUTION
<b>Non-Xerox Toner Cart</b>	You have used an unauthorized toner cartridge.	You must use a Xerox approved cartridge.
<b>Operation Not Assigned</b>	The machine has no job to handle.	
<b>Line Busy</b>	The remote fax did not answer.	Try again. Contact recipient to ensure remote machine is functioning correctly.
<b>Line Error</b>	Your machine cannot connect with the remote machine, or has lost contact because of a problem with the phone line.	Try again. If the problem persists, wait an hour or so for the line to clear, then try again.  Or, turn the <i>ECM</i> mode on. Refer to " <i>Fax Setup Options</i> " on page 5-22 for more information.
<b>LSU Error</b>	A problem has occurred in the <i>LSU (Laser Scanning Unit)</i> .	Try <i>Power Off / Power On</i> . Refer to " <i>Powering On the Machine</i> " starting on page 2-16. If the problem still persists, please call for service.
<b>Memory Full</b>	The memory is full	Either delete unnecessary documents, retransmit after more memory becomes available, or split the transmission into more than one operation.
<b>No Answer</b>	The remote fax machine has not answered after several redial attempts.	Try again. Contact recipient to ensure remote machine is functioning correctly.
<b>Poll Code Err.</b>	You have used an incorrect poll code.	
<b>Polling Error</b>	The remote fax machine you want to poll is not ready to respond to your poll.  Or, when setting up to poll another fax machine, you have used an incorrect poll code.	The remote operator should know in advance that you are polling and have the fax machine loaded with the original document.  Enter the correct poll code.
<b>No Developer Cartridge</b>	The toner cartridge is not installed.	Install the toner cartridge. Refer to " <i>Toner Cartridge</i> " on page 9-5.

DISPLAY	MEANING	SOLUTION
<b>No. Not Assigned</b>	The <i>Speed Dial</i> location has no number assigned.	
<b>No Paper</b>	The recording paper in the paper tray has run out.	Load the recording paper in the <i>Paper Tray</i> .
<b>RX Tray Full</b>	Paper is overstacked in the output bin.	Remove paper.
<b>Paper Jam 0</b>	Paper has jammed in the paper feeding area.	Clear the jam. Refer to " <i>Paper Jams</i> " on page 10-6.
<b>Paper Jam 1</b>	Paper has jammed in the fuser area.	Clear the jam. Refer to " <i>Paper Jams</i> " on page 10-6.
<b>Paper Jam 2</b>	Paper has jammed in the paper exit area.	Clear the jam. Refer to page " <i>Paper Jams</i> " on page 10-6.
<b>Power Failure</b>	The machine's memory has not been backed up.	
<b>Toner Empty</b>	The <i>Toner Cartridge</i> has run out. The machine stops.	Replace with a new toner cartridge. Refer to " <i>Toner Cartridge</i> " on page 9-5.
<b>Toner Low</b>	The toner is almost empty.	Take out the toner cartridge and gently shake it. By doing this printing operations can be temporarily resumed.
<b>Retry Redial?</b>	The machine is waiting for the programmed interval to automatically redial.	Press [Start] to immediately redial, or [Stop] to cancel the redial operation.
<b>Function Full</b>	The memory has become full.	Either delete unnecessary documents, or retransmit after more memory becomes available. The transmission can also be split into more than one operation if it is a large job.

# Problem and Solutions Charts

The following chart lists some conditions that may occur and the recommended solutions. Follow the suggested solutions until the problem is corrected. If the problem persists, please call for service.

## Copying Problems

CONDITION	SUGGESTED SOLUTION
<b>The LCD does not turn on</b>	<p>Check that the product is plugged into an electrical receptacle and ensure that there is power to the receptacle.</p> <p>Ensure the <i>ON/OFF</i> switch is in the <i>ON</i> position.</p>
<b>Copies are too light or too dark</b>	<p>If the original is light, use the <i>Lighten/Darken</i> key to darken the image.</p> <p>If the original is dark, use the <i>Lighten/Darken</i> key to lighten the image.</p>
<b>Smears, lines, marks, or spots on copies</b>	<p>If defects are on the original, press the <i>Lighten/Darken</i> key to adjust the image.</p> <p>If no defects are on the original, clean the <i>Document Glass</i> and underside of the <i>Document Feeder</i>.</p> <p>If a line is present when using the <i>Document Feeder</i> and not when using the <i>Document Glass</i>, clean the CVT glass. For stubborn spots use a crumpled up piece of paper or a credit card. Refer to "<i>Cleaning the Document Glass and Constant Velocity Transport (CVT) Glass</i>" on page 9-2.</p> <p>If the problem still persists, clean the <i>Drum Cartridge</i>. Refer to "<i>Maintenance Tools</i>" on page 8-10 for instructions.</p>
<b>Copy image is skewed</b>	<p>Ensure that original is positioned correctly on the <i>Document Glass</i>.</p> <p>Check that copy paper is loaded correctly.</p>
<b>Blank copies</b>	<p>Ensure that the original is face down on the <i>Document Glass</i> or face up in the <i>Document Feeder</i>.</p>
<b>Image rubs off the copy easily</b>	<p>Replace the paper in the tray with paper from a new package.</p> <p>In high humidity areas do not leave paper in the product for extended periods of time.</p>

CONDITION	SUGGESTED SOLUTION
<b>Frequent copy paper jams</b>	<p>Fan the stack of paper, then turn it over in the tray. Replace paper in paper tray with a fresh supply. Check/adjust paper guides.</p> <p>Ensure that the paper is the proper paper weight 80 g/m<sup>2</sup> (20 lb) bond paper is recommended.</p> <p>Check for copy paper or pieces of copy paper remaining in the product after a paper jam has been cleared.</p>
<b>Toner yield is lower than expected and TONER LOW message displays</b>	<p>Toner may be lodged in the cartridge. Remove the <i>Toner Cartridge</i>. Shake the <i>Toner Cartridge</i> and tap along the top of the <i>Toner Cartridge</i> over a waste receptacle. Take care not to touch the exposed toner on the left side of the cartridge.</p>
<b>Fewer copies from the Toner Cartridge than expected</b>	<p>Originals contain pictures, solids, or heavy lines. Originals are forms, newsletters, books etc. The product is being powered on and off frequently. The <i>Document Feeder</i> is being left open while copies are being made.</p>

## Printing Problems

PROBLEM	PROBABLE CAUSE	SUGGESTED SOLUTION
<b>The product does not print</b>	The IEEE-1284 <i>Parallel</i> cable or <i>USB</i> cable is not connected properly.	Check the cable connection.
	The IEEE-1284 <i>Parallel</i> cable or <i>USB</i> cable is defective.	Check the cable with a computer and printer that work. If printing is still not possible, replace the cable.
	The port setting is incorrect.	Check the printer settings in the Windows <i>Control Panel</i> to ensure that the print job is being sent to the correct port. (For Example: LPT1.)
	The toner and drum cartridges are not installed properly.	Check that the toner and drum cartridges are installed properly.
	The printer driver may not be installed properly.	Reinstall the software.
	The <i>Parallel</i> port cable specifications may not be correct.	Use an IEEE-1284 compliant <i>Parallel</i> port cable.

PROBLEM	PROBABLE CAUSE	SUGGESTED SOLUTION
<b>Half of the page is blank</b>	The page layout is too complex.	Reduce the resolution setting from 600 dpi to 300 dpi. Install more RAM in the computer.
	The page orientation may be incorrect.	Change the page orientation in the printer setup dialog.
<b>Printing is too slow</b>	The computer parallel port may not be set for high speed communications.	If the computer is equipped with an ECP parallel port, enable this mode of operation. Refer to the <i>Enabling High Speed Printer Communications</i> section of the PC's user guide.
	Computer may not have enough memory (RAM).	Install more RAM in the computer.
	Print job is too large	Reduce resolution from 1200 dpi to 600 dpi.
<b>Irregular faded patches of print</b>	There is a paper quality problem.	Use only paper that meets the specifications required by the product.
	Toner may be unevenly distributed.	Remove the <i>Toner Cartridge</i> and shake it gently to distribute the toner evenly. Then reinstall the toner cartridge.
<b>Black staining</b>	There is a paper quality problem.	Use only paper that meets the specifications required by the product.
<b>Character voids</b>	The paper may be too dry.	Try printing with a different batch of paper.
<b>Background scatter</b>	The paper may be too damp.	Try printing with a different batch of paper. Do not open packages of paper until necessary so that the paper does not absorb too much moisture from the air.
	Printing over uneven surfaces.	If printing onto envelopes, change the printing layout to avoid printing over areas that have overlapping seams on the reverse side.
<b>Missing characters</b>	The paper may be too damp.	Try printing with a different batch of paper. Do not open packages of paper until necessary so that the paper does not absorb too much moisture from the air.
<b>Back of printout is dirty</b>	The transfer roller may be dirty.	Print a few blank pages to clean the transfer roller.
<b>Incorrect fonts</b>	TrueType fonts may be disabled.	Use the fonts dialog box in the <i>Control Panel</i> to enable TrueType fonts.



PROBLEM	PROBABLE CAUSE	SUGGESTED SOLUTION
Faded graphics	Toner may be low.	Remove the <i>Toner Cartridge</i> and shake it gently to distribute the toner evenly. Then reinstall the <i>Toner Cartridge</i> .  Ensure that a spare <i>Toner Cartridge</i> is available.

## Faxing Problems Solution Chart

PROBLEM	SUGGESTED SOLUTION
Originals are fed diagonally (skewed)	Ensure the <i>Document Guides</i> are adjusted to the width of the original being fed.  Check the original meets the conditions established for use with this device.
The original is not being printed on the paper of the remote Fax even though it is being sent	Ensure the originals were placed face-up in the <i>Document Feeder</i> or face-down on the <i>Document Glass</i> .
Originals are not sent even if operations are carried out normally	Check that the remote <i>Fax</i> is compatible with the machine. This machine supports G3 communications but not G4 communications.
Originals cannot be received even if [Start] is pressed	Ensure the bell rings before picking up the handset.  Ensure the handset is not replaced before pressing [Start]. When answering a call using the handset and a <i>Fax</i> is being received, do not replace the handset until [Start] is pressed and the phone line switches to the machine.  Check the telephone cord has not been disconnected.  Check the power plug has not been unplugged from the power outlet.  Check with the party trying to send the original that there are no problems with the remote fax.
Paper is not collated	Ensure the machine has paper loaded.  Check if a paper jam has occurred.

PROBLEM	SUGGESTED SOLUTION
<b>The received original is printed dark and is illegible or black stripes are printed on the original</b>	<p>Check with the party sending the original that the original is a clean copy.</p> <p>Check with the party sending the original that the problem is not due to a fault or operator error at the remote <i>Fax</i>. For example, dirty scan glass or dirty scan lamp.</p> <p>If the same problem occurs even when copies are made on the machine, clean the drum. Refer to <i>"Maintenance Tools"</i> on page 8-10 for instructions.</p>
<b>Paper is collated but not printed.</b>	<p>Ensure there enough toner.</p> <p>Check with the party sending the fax that the original was placed correctly when scanned at the remote <i>Fax</i>.</p>

# 11 Specifications

---

Use this chapter to identify the specifications for each function of your machine.

- Introduction . . . . . 11-2
- Printer Specifications . . . . . 11-3
- Fax Specifications . . . . . 11-4
- Scanner and Copier Specifications . . . . . 11-5
- General Specifications . . . . . 11-6
- Media Specifications . . . . . 11-7

# Introduction

The *Xerox WorkCentre 4118* adheres to strict specifications, approvals and certifications. These specifications are designed to provide for the safety of users and to ensure that the machine operates in a fully functional state. Use the specifications listed in this chapter to quickly identify the capabilities of the machine.

- *If further specification information is required please refer to [www.xerox.com](http://www.xerox.com).*

# Printer Specifications

ITEM	DESCRIPTION
Emulation	PCL6
Resolution	True 600 x 600 dpi, 1200 dpi class
Printing speed	17 ppm for A4 / 18 ppm for Letter
Effective printing width	208 mm (8.2 inches) for letter / legal (216 x 356 mm / 8.5 x 14 inch) 202 mm (8 inches) for A4

# Fax Specifications

ITEM	DESCRIPTION
<b>Applicable line</b>	G3 PSTN (Public Switched Telephone Network)
<b>Communication Standard</b>	ITU G3, Super G3
<b>Resolutions</b>	Standard 203 x 98 dpi Fine 203 x 196 dpi Super Fine (Fine Photo) 300 x 300 dpi Super Fine 203 x 392 dpi Super Fine 406 x 394 dpi Halftone (Error Diffusion)
<b>Receiving Resolutions</b>	203 x 98 dpi, 203 x 196 dpi, 300 x 300 dpi, 203 x 392 dpi, 406 x 394 dpi
<b>Data coding</b>	MH/MR/MMR/JBIG/JPEG (Color Transmission)
<b>Maximum modem speed</b>	33.6 kbps
<b>Transmission speed</b>	<3 seconds (Standard resolution, MMR, 33.6 kbps)
<b>Fax Memory</b>	8 MB receive
<b>Printing speed</b>	17 ppm (for A4) 18 ppm (letter size)
<b>Effective scanning width</b>	208 mm (8.2 inches)
<b>Effective printing width</b>	208 mm (8.2 inches) for letter / legal (216 x 356 mm / 8.5 x 14) 202 mm (8 inches) for A4
<b>Document width and weight</b>	Document Feeder: 176 ~ 216 mm (7 ~ 8.5 inches) 45 ~ 105 g/m <sup>2</sup> (12.5 ~ 28 lb) Document Glass: Maximum Legal (216 x 356 mm / 8.5 x 14 inch)
<b>Input paper tray capacity</b>	Tray 1 and Tray 2 (optional): 550 sheets 80 g/m <sup>2</sup> (20 lb) Each Bypass Tray: 100 sheets 80 g/m <sup>2</sup> (20 lb)
<b>Document Feeder</b>	Document Feeder: Up to 40 pages 80 g/m <sup>2</sup> (20 lb) Document Glass: 1 page

# Scanner and Copier Specifications

ITEM	DESCRIPTION
<b>Scanning method</b>	CCD, Flat-bed
<b>Copy speed</b>	17 A4 / 18 Letter Copies Per Minute
<b>Scan speed</b>	2.5 msec/line MONO
<b>Scan resolution</b>	600 x 600 dpi ( <i>Document Glass</i> ) 600 x 300 ( <i>Document Feeder</i> )
<b>Scan mode</b>	True Color, 250 Gray, Black and white
<b>Copy mode</b>	Black and White
<b>Effective scanning width</b>	208 mm (8.2 inches)
<b>Maximum document width</b>	216 mm (8.5 inches)
<b>Multi copy range</b>	1 ~ 999
<b>Reduction &amp; Enlargement</b>	25% ~ 400% in 1% increments (from <i>Document Glass</i> ) 25% ~ 100% in 1% increments (from <i>Document Feeder</i> )
<b>Maximum print edge margin</b>	Top, Bottom, Each side 4 mm (0.16 inch)
<b>First Copy Out Time</b>	Under 10 seconds (Normal - Ready) 35 seconds (from Power Save)

# General Specifications

ITEM	DESCRIPTION
<b>Input paper tray capacity</b>	Tray 1 and Tray 2 (optional): 550 sheets 80 g/m <sup>2</sup> (20 lb) Bypass Tray: 100 sheets 80 g/m <sup>2</sup> (20 lb)
<b>Output tray capacity</b>	250 sheets 80 g/m <sup>2</sup> (20 lb), face down
<b>Toner cartridge life</b>	8,000 pages (for Starter Cartridge 4,000 pages) at 5% coverage
<b>Drum life</b>	20,000 pages (5% coverage)
<b>Operating Environment</b>	Temperature: 10 - 32° C / 50 - 90° F (20 ~ 80% RH)
<b>Paper size and weight</b>	Trays 1 & 2: A4, Letter, Folio, Legal (216 x 356 mm / 8.5 x 14 inch 60 ~ 90 g/m <sup>2</sup> (16 ~ 24 lb) Bypass tray: A6 ~ Legal (216 x 356 mm / 8.5 x 14 mm) 60 ~ 160 g/m <sup>2</sup> (16 ~ 43 lb) Duplex: A4, Letter, Folio, Legal (216 x 356 mm / 8.5 x 14 inch) 80 ~ 90 g/m <sup>2</sup> (20 ~ 24 lb)
<b>Original document width and weight</b>	Document Feeder: 176 ~ 216 mm (7 ~ 8.5 inches) 45 ~ 105 g/m <sup>2</sup> (12.5 lb ~ 28 lb) Document Glass: Maximum legal (216 x 356 mm / 8.5 x 14 inch)
<b>Document Feeder capacity</b>	40 sheets 80 g/m <sup>2</sup> (20 lb)
<b>Power rating</b>	AC220 ~ 240V (Europe), 50/60 Hz 3.0A AC110 ~ 127V (US, Canada), 50/60 Hz 6.0A
<b>Power consumption</b>	35 W in Power Save mode 115 W in Standby mode 430 W / 420 W during operation
<b>Weight</b>	32 kg ( <i>Drum and Toner Cartridges included</i> )
<b>Dimensions (WxDxH)</b>	540 x 441 x 488 mm (21 x 17 x 19 inches) without Tray 2 540 x 441 x 619 mm (21 x 17 x 24.4 inches) with Tray 2
<b>Memory Size</b>	64MB



# Media Specifications

ITEM	DESCRIPTION		
Paper types available	<i>Plain paper, OHP film, Label, Envelope, Card, Postcard</i>		
Paper Sizes	<i>Paper Type</i>	<i>W x L (mm)</i>	<i>W x L (Inch)</i>
	Letter	215.9 x 279	8.5 x 11
	Legal	215.9 x 355.6	8.5 X 14
	JIS B5	182 x 257	7.17 x 10.12
	A4	210x 297	8.27 x 11.69
	Executive	184.2 x 266.7	7.25 x 10.5
	A5	148.5 x 210	5.85 x 8.27
	A6 card	105 x 148.5	4.13 x 5.85
	Post Card 4x6	101.6 x 152.4	4 x 6
	HagaKi	100 x 148	3.94 x 5.83
	Envelope 7-3/4	98.4 x 190.5	3.88 x 7.5
	Envelope COM-10	105 x 241	4.12 x 9.5
	Envelope DL	110 x 220	4.33 x 8.66
	Envelope C5	162 x 229	6.38 x 9.02
Custom	98 x 148 ~ 215.9 x 355.6	3.86 x 5.83 ~ 8.5 x 14	

ITEM	DESCRIPTION			
Input Source	Source	Media Types	Sizes	Thickness
	Paper Tray	Plain Paper	A4, Letter, Legal, Folio	60 ~ 90 g/m <sup>2</sup> (16lb ~ 24lb)
	Bypass Tray	Plain Paper, Envelope, Transparency, Label, Cardstock	A4, Letter, Legal, Folio, Executive, A5, B5, A6, Monarch (7 3/4), COM10, #9, C5, DL, Custom	60 ~ 160 g/m <sup>2</sup> (16lb ~ 43lb)
	Duplex	Plain Paper	A4, Letter, Folio, Legal	80 ~ 90 g/m <sup>2</sup> (20lb ~ 24lb)

---

ⓘ B5 means JIS and ISO  
 Transparency film thickness: 150 µm  
 Paper Label thickness: 140 µm

---

# Index

---

## Numerics

2 Sided  
copy 3-7

## A

About this guide 1-3  
Adding Paper 2-17  
Administration Tools  
    Clear Memory 8-9  
    Maintenance Tools 8-10  
    Passcode Protection 8-7  
Auto Fit  
    copy 3-7  
Auto Suppress  
    copy 3-11  
Auto Tray Switching 2-10, 3-2, 3-8, 4-5

## B

Basic Troubleshooting  
    Copier Problems Solution Chart 10-14  
    Faxing Problems Solution Chart 10-17  
    LCD Error Messages 10-11  
    Printing Problems Solution Chart 10-15  
    Solving Problems 10-14  
Batch TX 5-13  
Billing Counters 8-12  
Book Copy  
    copy 3-11  
Bypass Tray 4-5

## C

Calling for Service 1-5

Cancel Scan 7-7  
Clean Drum 8-12  
Cleaning 9-2  
    Control Panel and LCD Display 9-3  
    Document Glass and Constant Velocity Transport Glass (CVT) 9-2  
    Outside Areas 9-3  
Clear Memory 8-9  
Clone  
    copy 3-7  
Collated  
    copy 3-7  
Color Original 5-9  
    copy 3-8  
    Fax 5-9  
Component Location 2-7  
Connections 2-14  
Constant Velocity Transport Glass (CVT) 9-2  
Control Panel Overview 2-9  
ControlCentre 8-4  
    Firmware Update Tab 8-5  
    Installing 8-4  
    PCL Button 8-6  
    Phonebook Tab 8-5  
    Printer Tab 8-6  
    Running ControlCentre 8-4  
    Using ControlCentre 8-4  
Conventions 1-3  
Copier Problems Solution Chart 10-14  
Copy 3-6  
    1-2 Sided 3-7  
    Auto Fit 3-7  
    Auto Suppress 3-11  
    Book Copy 3-11

- Clone **3-7**
- collated **3-7**
- Color Original **3-8**
- Covers **3-11**
- Create Booklet **3-12**
- Edge Erase **3-10**
- ID Card Copy **3-9**
- Lighten/Darken **3-6**
- Margin Shift **3-10**
- N Up **3-12**
- Original Type **3-8**
- Paper Supply **3-8**
- Reduce/Enlarge **3-6**
- start **3-5**
- Transparencies **3-12**
- Copy Feature selection **3-4**
- Copy Features **3-6**
- Copy Mode **3-2**
- Copy quantity **3-5**
- Copying Procedure **3-2**
- Covers
  - copy **3-11**
- Create Booklet
  - copy **3-12**
- Customer Replaceable Units **9-5**
  - Drum Cartridge **9-8**
  - Toner Cartridge **9-5**
- Customer Support **1-5**

**D**

- Delay Fax **5-11**
- Dialing Methods
  - Keypad Dialing **5-6**
  - Manual Dialing **5-7**
  - Manual Group Dialing **5-7**
  - Redial **5-7**
- Document Feeder **3-3, 5-2, 7-3**
- Document Glass **3-4, 5-3, 7-4**
  - Cleaning **9-2**
- Drum Cartridge **9-8**
  - Replacing the Drum Cartridge **9-8**
- Drum Cartridge, installing **2-12**
- Drum Cleaning **8-12**
- Drum Replacement **8-11**

**E**

- Edge Erase
  - copy **3-10**
- Enter the Fax Number **5-4**
- Enter the quantity **3-5**
- Error Messages **10-11**
- Expected Toner Cartridge Life **9-5**
- External Connections **2-14**

**F**

- Fault Clearance **10-3**
- Fax **5-9**
  - Batch TX **5-13**
  - Delay Fax **5-11**
  - Fax Forwarding **5-14**
  - Lighten/Darken **5-8**
  - Mailbox Setup **5-15**
  - Memory Fax **5-11**
  - Original Type **5-8**
  - Polling **5-12**
  - Priority Fax **5-12**
  - Secure Receive **5-13**
  - start **5-5**
  - Toll Save **5-10**
- Fax Features **5-8**
- Fax Forwarding **5-14**
- Fax Number **5-4**
- Fax Setup Options **5-22**
- Fax Specification **11-4**
- Faxing Problems Solution Chart **10-17**
- Faxing Procedure **5-2**
- Features
  - Fax **5-8**
- Firmware Update Tab **8-5**

**G**

- General Problems **10-2**
- General Specification **11-6**
- Getting Started
  - Copying Procedure **3-2**
  - Loading Paper **4-2**

**I**

- ID Card Copy

copy **3-9**  
 Information Sources **1-4**  
 Installing ControlCentre **8-4**  
 Installing Drum and Toner Cartridges **2-12**  
 Installing Software **2-24**  
 Introduction **1-2**

**J**

Job Status **5-5**

**K**

Keypad Dialing **5-6**

**L**

LCD Error Messages **10-11**  
 Lighten/Darken  
   copy **3-6**  
   fax **5-8**  
 Loading documents **3-3, 3-4, 5-2, 5-3, 7-3, 7-4**  
 Loading Paper **2-17, 4-2**

  Bypass Tray **4-5**

  Paper Tray **4-2**

  Preparation **4-2**

  Stock Types **4-9**

Local Connection

  Test Print **2-32**

  Test Scan **2-32**

Location of Components **2-7**

**M**

Machine Overview **2-6**

Machine Setup **2-20**

  ControlCentre **8-4**

Machine Setup Options **2-21**

Mailbox **5-17**

Mailbox Setup **5-15**

Maintenance Tools

  Billing Counters **8-12**

  Check Serial Number **8-10**

  Clean Drum **8-12**

  New Drum **8-11**

  Notify Toner Low **8-11**

Making Connections **2-14**

Manual Dialing **5-7**

Manual Group Dialing **5-7**

Margin Shift

  copy **3-10**

Media Specifications **4-9, 11-7**

Memory Fax **5-11**

Models and Options **2-6**

**N**

N Up

  copy **3-12**

**O**

Options **2-6**

Ordering Supplies **9-4**

Original Type

  copy **3-8**

  fax **5-8**

Overview Control Panel **2-9**

**P**

Paper Specification **11-7**

Paper Supply

  Auto Tray Switching **2-10, 3-2, 3-8, 4-5**

  Bypass Tray **4-5**

  copy **3-8**

  Loading Paper **4-2**

  Paper Tray **4-2**

  Preparation **4-2**

  Stock Types **4-9**

Paper Supply selection **3-2**

Paper Tray **4-2**

Paper, loading **2-17**

Passcode Protection **8-7**

  Change the Passcode **8-8**

  Enable **8-7**

PCL Button **8-6**

Phonebook Tab **8-5**

Polling **5-12**

Power Off **2-16**

Power On **2-16**

Preparing paper for loading **4-2**

Print **6-2**

Printer Specification **11-3**

Printer Tab **8-6**

Printing a Document **6-2**  
 Printing Problems Solution Chart **10-15**  
 Printing Procedure **6-2**  
 Priority Fax **5-12**  
 Problem Solving **10-14**  
 Problems  
   Fault Clearance **10-3**  
   General **10-2**

**Q**

Quantity **3-5**

**R**

Redial **5-7**  
 Reduce/Enlarge  
   copy **3-6**  
 Regulations **1-6**  
 Related Information Sources **1-4**  
 Replacing the Drum Cartridge **9-8**  
 Replacing the Toner Cartridge **9-5, 9-7**  
 Resolution **5-9**  
   Fax **5-9**  
 Running ControlCentre **8-4**

**S**

Safety **1-6**  
 Scan  
   Canceling a Scan **7-7**  
   TWAIN **7-3**  
   WIA driver **7-6**  
 Scanner and Copier Specification **11-5**  
 Scanning Procedure **7-3**  
 Secure Receive **5-13**  
 Selecting Copy Features **3-4**  
 Selecting Copy Mode **3-2**  
 Selecting Start **3-5, 5-5**  
 Selecting the Paper Supply **3-2**  
 Sending a Fax **5-2**  
 Serial Number **8-10**  
 Serial number **1-5**  
 Setting the Product to Send Toner Low Information  
   **9-7**  
 Setting up the Machine **2-20, 2-21**  
   ControlCentre **8-4**

  Installing ControlCentre 5.0 **8-4**  
 Software Installation **2-24**  
 Solutions, Copier Problems **10-14**  
 Solutions, Faxing Problems **10-17**  
 Solutions, Printing Problems **10-15**  
 Solving Problems **10-14**  
 Specifications  
   Fax **11-4**  
   General **11-6**  
   Paper **11-7**  
   Printer **11-3**  
   Scanner and Copier **11-5**  
 Specifications, Media **4-9**  
 Start **3-5, 5-5**  
 Status Map  
   Auto Tray Switching **2-10**  
 Stock Types **4-9**  
 Switching Off **2-16**  
 Switching On **2-16**  
 System Requirements  
   Windows **2-24**  
 System Setup  
   Installing ControlCentre **8-4**

**T**

Toll Save **5-10**  
 Toner Cartridge **9-5**  
   Expected Cartridge Life **9-5**  
   Replacing the Toner Cartridge **9-5, 9-7**  
   Setting the Product to Send Toner Low Information  
     **9-7**  
   Toner Save Mode **9-5**  
 Toner Cartridge, installing **2-12**  
 Toner Low Information **9-7**  
 Toner Low Notification **8-11**  
 Toner Save Mode **9-5**  
 Transparencies  
   copy **3-12**  
 Troubleshooting  
   Copier Problems Solution Chart **10-14**  
   Fault Clearance **10-3**  
   Faxing Problems Solution Chart **10-17**  
   General Problems **10-2**  
   LCD Error Messages **10-11**  
   Printing Problems Solution Chart **10-15**

Solving Problems **10-14**

TWAIN **7-3**

## **U**

Unpacking **2-2**

User Interface **2-9**

Using ControlCentre **8-4**

Using the Document Feeder **3-3**

Using the document feeder **5-2, 7-3**

Using the Document Glass **3-4**

Using the document glass **5-3, 7-4**

## **W**

Welcome **1-2**

Welcome Center **1-5**

Canada **1-5, 10-10**

US **1-5, 10-10**

WIA driver **7-6**

## **X**

Xerox Website **1-5**

Xerox Welcome Center **1-5**





## Free Manuals Download Website

<http://myh66.com>

<http://usermanuals.us>

<http://www.somanuals.com>

<http://www.4manuals.cc>

<http://www.manual-lib.com>

<http://www.404manual.com>

<http://www.luxmanual.com>

<http://aubethermostatmanual.com>

Golf course search by state

<http://golfingnear.com>

Email search by domain

<http://emailbydomain.com>

Auto manuals search

<http://auto.somanuals.com>

TV manuals search

<http://tv.somanuals.com>