

InfoScan™ TS Elite

User Manual

Table of Contents

Introduction.....	3
Contact and Support Information	3
Getting Started.....	4
The Pen Parts	4
The Pen Power Supply	5
Unpacking the Pen.....	6
Installing the WizCom Desktop	6
Learning to Scan (using the Trainer).....	7
The Pen User Interface.....	8
The Pen Keys	8
The Pen Main Menu.....	9
Connect to PC.....	9
The Preferences Menu.....	9
The Information Menu	11
Icons and Indicators	11
The Pen Applications	13
Notes	13
The Notes Functions	13
The Notes Toolbar	13
Toolbar Options.....	14
Notes Tutorial.....	17
Editing and Inserting Text	23
Scan to PC.....	25
The Scan to PC Functions	25
The Scan to PC Toolbar.....	26
Toolbar Options.....	26
Scan to PC Tutorial	27
The WizCom Desktop.....	32
Introduction to the Desktop	32
The Desktop Modes	32
The Desktop User Interface	34
The Desktop Main Menu.....	34
The Desktop Tabs.....	34
The Task Bar Icons and Menu.....	36

Table of Contents

Managing Notes Files Using the Desktop	37
Tips.....	39
Changing Scanning Settings	39
Scanning Guidelines	41
Pen Maintenance	42
Troubleshooting Pen-PC Communications	42
Product Specification	44
Pen Specification.....	44
Desktop Specification.....	44

Introduction

Congratulations on your choice of a state-of-the-art scanning Pen from WizCom Technologies. WizCom makes personal, portable scanning Pens that assist with reading, understanding and utilizing text.

Inside the tip of the Pen is a sophisticated electronic eye. This eye enables you to scan different types of printed information directly into your Pen. The scanned text can then be edited and transferred to the PC.

The Pen comes with a touch screen and stylus, allowing easy manipulation of the Pen user interface and quick editing of scanned texts with the **Virtual Keyboard**.

Use this guide to find out about setting up and using your WizCom product.

Contact and Support Information

Contact us at 888 777 0552 (Toll free in USA) or +1 978 727 0026 or email usa.support@wizcomtech.com. Visit our website <http://www.wizcomtech.com> to register your product.

Getting Started

The Pen Parts

On the **Front Panel** you can see:

1. Pen tip with optical scanning head (beneath the protective cover)
2. 5-way button (Enter and direction keys)
3. Power/Escape key (red)
4. Touch Screen Display

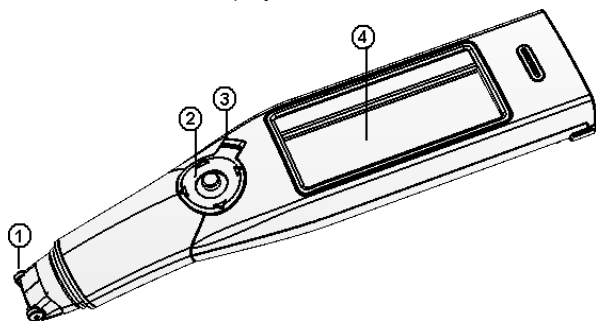

Pen Front Panel

On the **Top Panel** you can see:

1. USB Cable Outlet
2. Infrared Screen
3. Stylus Slot
4. Insertion point for headphones

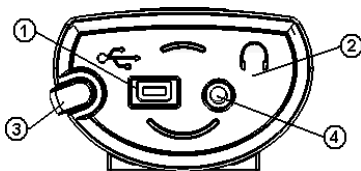

Pen Top Panel

*Important: Before using the headphones, adjust the volume using the **Voice Settings** option in the **Preferences** menu.*

On the **Back Panel** you can see the battery compartment.

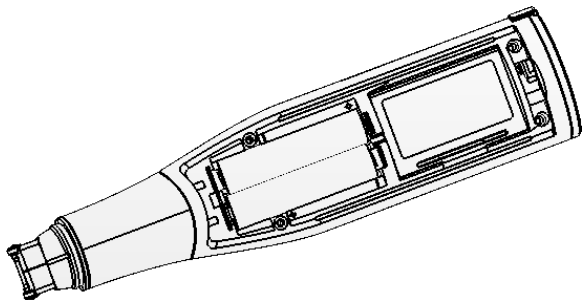

Pen Back Panel

The Pen Power Supply

The Pen comes with 2 AAA Alkaline batteries.

Safety Points (Batteries)

CAUTION: Risk of explosion if battery is replaced by an incorrect type. Use AAA Alkaline batteries only.

- Always place 2 fresh batteries in the Pen. It is not advisable to use the Pen with batteries that are not at the same voltage level.
- Do not combine different types of batteries (e.g. rechargeable and non-rechargeable).
- Dispose of used batteries according to the manufacturer's instructions.

Preserving Battery Usage

To optimize battery usage, go to **Set Auto Shut-Off Time** in **Preferences** in the **Pen Main Menu** and modify the settings according to your needs.

External Power Supply (using the USB cable)

Connecting the Pen to the PC using the USB cable automatically activates the power supply from the PC. This has the following implications:

- The Pen uses the external power supply when connected to the PC, so batteries last longer.
- **CAUTION:** *Unsaved information may be lost if the USB cable disconnects while using without batteries. It is very important that the Pen always contains batteries, even when connected to the PC.*
- **Set Auto Shut-Off Time** in **Preferences** is disabled when the Pen is connected to the PC.

Unpacking the Pen

To get started:

1. Remove the Pen from the protective case.
2. Lift the battery cover on the back of the Pen by pushing the tab down and out.
3. Insert the batteries into the Pen with the positive and negative terminals corresponding to the markings on the sides of the battery compartment.
Note: Make sure that your Pen always contains batteries, even when connected to the PC.
4. Close the battery compartment.
5. Remove the protective cover from the Pen tip.
6. Turn the Pen on by pressing the red power key.

The Pen is ready to scan!

Installing the WizCom Desktop

Important: Do not connect the USB cable to the PC before installing the WizCom Desktop.

To install the WizCom Desktop do the following:

1. Insert the CD-ROM that was supplied with the Pen.
2. The CD-ROM Main Menu will appear on the PC screen.
3. Click on WizCom Desktop Installation and follow the instructions for installing the Desktop and the USB driver.

Learning to Scan (using the Trainer)

This tutorial will help you learn to scan using the plastic Trainer supplied in the package.

1. Slide the Trainer onto the tip of the Pen (instead of the cap) and press into place.
2. Turn the Pen on by pressing the red Power key. If you don't see the **Notes** screen, select the **Notes** icon from the **Pen Main Menu** by tapping on it with the stylus or by using the direction keys.
3. The following screen should be visible:

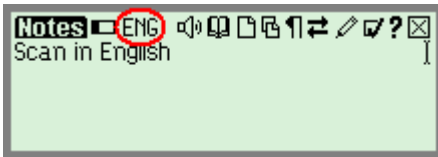

If the scanning language is not set to **English**, select from the toolbar by tapping with the stylus or by pressing ESC (red key) and using the direction keys. Choose **Set Language for New File** from the drop-down menu and select **English**.

4. Place the Trainer at the end of the practice sentence with the Pen facing the text.
5. Position the Pen so that the text is centered between the feet of the Trainer.
6. Glide the Pen from right to left in a straight line over the text. Start scanning 1cm from the end of the sentence and finish 1cm after.

Use the following **English** practice sentence:

This sentence will help me practice scanning.

*Note: The Pen default is set to right-handed scanning. To change the Pen display to left-handed scanning, use the **Set Right-/Left- Handed** option from **Preferences** in the **Pen Main Menu**.*

The Pen User Interface

The Pen Keys

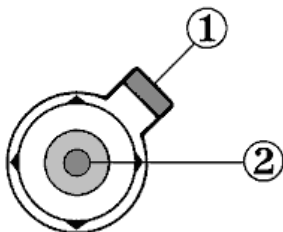

1. Power/Escape (ESC) Key

a. Power:

Start up – Short press to turn the Pen on
Shut down - Long press to turn the Pen off

Note: To turn the Pen off, hold down the Power key until the progress bar reaches the end.

b. Escape:

Activate/deactivate toolbar
Close submenus and pop-ups

2. 5-way Button

a. Enter key:

- Select highlighted option by pressing the key
- Define or translate words within **Notes** files by cross-referencing to the selected dictionary
- Activate **Send** in **Scan to PC** when in **non-Auto Send** mode

b. Direction keys:

Activate the direction keys by pushing the 5-way button in the desired direction

1. Right/Left direction keys:

Scroll right or left

2. Up/Down direction keys:

- Scroll up or down
- Create a new paragraph in **Notes** using the Down key

The Pen Main Menu

To access the **Pen Main Menu**, exit the application you are currently working in (**Notes** or **Scan to PC**), by selecting from the application toolbar. Use the stylus, or press the ESC key and scroll with the right/left direction keys.



The Pen Main Menu

The following items appear in the **Pen Main Menu**:

- **Notes** (See page 13)
- **Scan to PC** (See page 25)
- **Connect to PC**
- **Preferences**
- **Information**

Connect to PC

Use this option to communicate with the WizCom Desktop. Selecting this option while the WizCom Desktop is running on the PC will establish Pen-PC Communications and allow you to move or copy **Notes** files from the Pen to your PC, or to delete files currently stored on the Pen.

The Preferences Menu

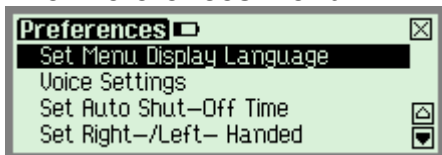

Modify the default Pen settings using this menu, which can be accessed via the **Pen Main Menu** or through the **Preferences** option in the **Settings** menu of each application. To accept changes press Enter or select **OK**. To return to the **Preferences** menu without making changes, press ESC or .

Set Menu Display Language

The menu display language is the language in which the menus and messages appear (The Pen UI). Use this option to change the menu display language.

Voice Settings

Use this option to modify the volume, pitch and reading speed on the Pen. This affects the way text is read aloud in **Notes**.

Set Auto Shut-Off Time

If the Pen is not in use it will shut down automatically after two minutes. Use this option to change the automatic shut-off time setting.

Note: The auto shut-off feature is disabled while the Pen is connected to the PC.

Set Right-/Left- Handed

Use this option to switch between right and left-handed scanning. The Pen default is set to right-handed scanning.

Set Screen Contrast

Use this option to adjust the brightness of the display. Move the slider bar by dragging with the stylus or using the direction keys.

Calibrate Touch Screen

At times the stylus touch may become inaccurate. If so, the touch screen will need to be recalibrated.

The touch screen can be calibrated by selecting the option in the **Preferences** menu. Follow the instructions to calibrate the screen. A message will appear if calibration is successful.

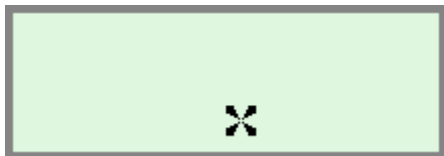

Touch Screen Calibration

The Information Menu

View Memory Status

Use this option to see how much memory is available on the Pen for storing new files.

Compact Memory

Maximize free space on the Pen's extension card by compacting the Pen file system.

Serial Number

Use this option to view the Pen serial number.









About

















Use this option to view the Pen version and copyright information.

Icons and Indicators

The table below contains a list of icons and graphic indicators. Icons can be selected by tapping on them with the stylus, or by using the 5-way button.

Indicators cannot be selected and represent the current state of the Pen.

Graphic	Function
Common Toolbar Icons	
	Settings: Display the Settings menu options.
	Help: Display the Help menu options.
	Pen Main Menu: Exit the application.
The Notes Toolbar	
	Read Aloud: Hear text on screen read aloud.
	Translate/Define Word: Define or translate words by cross-referencing to the selected dictionary.
	New File: Create a new file.
	File Operations: Open, rename or delete existing files.
	Paragraph: Create a new paragraph or delete an existing one.

Graphic	Function		
	Beaming: Send and receive files via infrared communications. Files can be transferred using IrOBEX compatible devices, such as PDAs (Palm, IPAQ etc), or Smartphones.		
	Edit: Activate the Virtual Keyboard to edit text.		
The Scan to PC Toolbar			
	Send: When the Auto Send function is disabled, selecting this icon will send the scanned line to the PC.		
	Auto Send: Indicates that scanned text will be sent immediately to the PC.		
Settings Menu – toggle options			
	Indicates that the option is OFF.		
	Indicates that the option is ON.		
Scanning Settings indicators			
	Indicates ready to scan.		
	Indicates ready to scan inverse text (white text on dark background).		
ENG	Language Indicator: Shows the scanning language the Pen is currently set to scan (i.e. ENG = English).		
	Inverse Mode: Indicates that the Pen is set to scan inverse text (white text on dark background).		
123	Numeric Mode: Indicates that the Pen is set to scan numbers only.		
Scrollbars			
	Scroll using the stylus.		
	Inactive scrollbars indicate that there is no text to scroll through.		
Battery Indicators			
 High	 Medium	 Low	 Empty
External Power Indicators			
	Indicates that the Pen is powered by the PC but the Pen contains batteries.		
	Indicates that the Pen is powered by the PC and the Pen contains no batteries.		

The Pen Applications

Notes

The Notes Functions

Notes is used primarily for scanning text and storing it on the Pen for future transfer to the PC using the WizCom Desktop.

Text can also be inserted manually using the **Virtual Keyboard**, and files can be transferred using infrared communications between the Pen and other IrOBEX compatible devices.

Notes can also be used to define or translate text from within a file using the dictionaries installed on the Pen.

For a step-by-step guide to using **Notes** see the **Notes Tutorial** on page 17.

Transferring Files

Files can be transferred from the Pen in two ways:

1. **Transferring files using the WizCom Desktop**
Files are saved on the Pen and then transferred to the PC using the WizCom Desktop. For information on how to manage files using the WizCom Desktop, see **Managing Notes Files using the WizCom Desktop** on page 37.
2. **Beaming Files Using Infrared Communications**
Files can be beamed and received using infrared communications. For instructions see **Beaming** on page 15.

The Notes Toolbar

The toolbar appears on the top right corner of the screen. It can be accessed using either the stylus or the Pen keys.

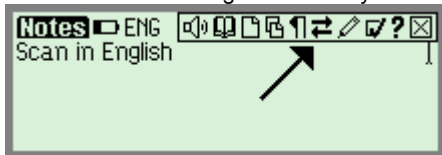

Accessing the Toolbar

Using the Stylus

- Tap the icon to open the toolbar item. The tool-tip will appear, followed by the drop down menu.
- Tap with the stylus to select a menu option or scroll up/down by activating the scroll bar.
- To deselect the toolbar, simply tap in a space outside the menu or toolbar.

Using the Pen Keys

- Press ESC to access the toolbar. The leftmost toolbar item will be highlighted.
- Use the Right/Left direction keys to scroll between the toolbar items and press Enter to access the desired menu.
- Scroll up/down within the menu using the Up/Down direction keys. Exit the menu by pressing ESC and then press ESC again to deselect the toolbar.

Toolbar Options

Read Aloud

Hear scanned or inserted text read aloud in supported languages. This icon does not appear if the selected dictionary does not contain support for reading aloud.

Translate/Define Word (cross-reference)

Use this function to view the translation or definition of words within **Notes** files. The cross-reference function is available only when the source language of one or more of the dictionaries installed on the Pen corresponds to the selected scanning language.

If there is more than one dictionary on the Pen whose source language is the same as the current scanning language, the

Select Dictionary option appears in  on the **Notes** toolbar. Use this option to switch between the dictionaries.

Accessing the cross-reference function:

- Use the stylus or the direction keys to place the cursor at the word you wish to view.
- Select  from the **Notes** toolbar or press ENT to view the dictionary entry.

New File 

Create a new file. If there is scanned text on the screen, selecting  will automatically save the previous file under a default file name.

File Operations 

Use this option to open or delete stored files, or to rename the current file.

Paragraph 

Use this option to create or delete paragraphs.

Beaming 

Use this option to beam and receive files using infrared communications. Files can be transferred using IrOBEX compatible devices, such as PDAs (Palm, IPAQ etc), or Smartphones.

Note: Only files saved as text files (.txt) can be sent to the Pen.

Using infrared communications to beam and receive files:

1. Beaming Files

- a. In the **Notes** application, open the **Notes** file you wish to beam.
- b. Confirm that the infrared port on the receiving device is enabled to receive.
- c. Align the Pen's infrared screen (see **The Pen Parts** on page 4) with the infrared component on the receiving device.
- d. Select **Beam Current File** from  in the **Notes** toolbar.
- e. Wait for the success confirmation message on the Pen.

2. Receiving Files

- a. Make sure that the sending device is set to send a text file.
- b. Select **Receive File** from  in the **Notes** toolbar.
- c. Align the Pen's infrared screen (see **The Pen Parts** on page 4) with the infrared component on the sending device.

- d. Initiate infrared file sending from the sending device.
- e. Wait for the success confirmation message on the Pen.
- f. The file from the sending device will open on the Pen screen, and will be saved automatically into the **Notes** files system.

Edit

Access the **Virtual Keyboard** to modify scanned text or to insert new text. See ***Editing and Inserting Text*** on page 23 for information on using the **Virtual Keyboard**.

Settings

The **Settings** menu contains the following options:

Enlarged Font	Change the display setting to enlarged font.
Inverse	Scan inverse text (white text on dark background).
Numeric	Use this option to scan numbers.
Set Language for New File	Change the scanning language for the next new file. See <i>Selecting a Language for Scanning</i> on page 40.
Select Dictionary	Choose the dictionary you wish to use for cross-referencing. This option only appears if there is more than one dictionary available for the source language.
Preferences	Display the Preferences menu (from the Pen Main Menu).

Help ?

The **Help** menu contains the following options:

Icons	An explanation of icons and graphic indicators.
Keys	An explanation of the Pen keys and their functions.

Notes Tutorial

This tutorial will take you through the basic use of the **Notes** application.

The tutorial has two parts:



- Using **Notes** on the Pen
- Transferring **Notes** files to the PC using the WizCom Desktop

Using Notes

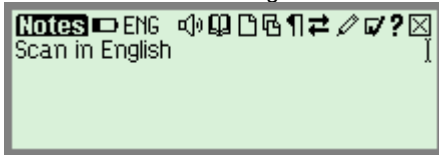
Press the red power key to turn the Pen on. Make sure you are in **Notes**. The following screen should appear:



*Note: If you don't see the **Notes** screen, select the **Notes** icon from the **Pen Main Menu** by tapping on it with the stylus or by using the direction keys.*

Select  to create a new file. If the scanning language is not set to **English**, select  from the toolbar by tapping with the stylus or by pressing ESC (red key) and using the direction keys. Choose **Set Language for New File** from the drop-down menu and select **English**.

1. Scanning a line of text

Scan the following line:

Roll the scanning device over printed words

The following screen should be visible:

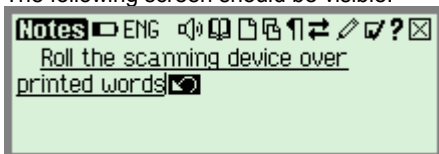

2. Inserting and deleting paragraphs

Select  from the **Notes** toolbar. You will see a drop-down menu with two options:



- Select **New Paragraph**. The cursor should move down to the next line.
- Scan the following line:

and see how the words appear on your Pen.

The following screen should be visible:

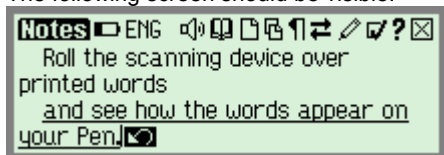

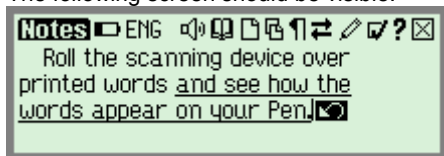

- Go back to  and select **Delete Paragraph**. A confirmation message should appear. Select **OK**. The new paragraph should disappear and the cursor should return to the end of the first line.
- Scan the above sentence again.

The following screen should be visible:



3. Deleting and Editing text

- Select  to delete the last scan (which is underlined).
- Select  to open the **Virtual Keyboard**. Insert the following characters using the stylus:

or tap them in.

- c. Select to close the **Virtual Keyboard**.

The edited text should appear on the screen:

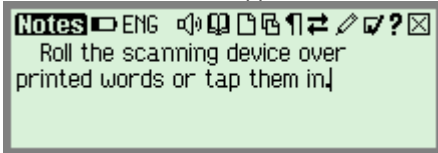

4. Cross-referencing words using the installed dictionaries



- a. Using the stylus, tap the word 'device'. The blinking cursor should appear at the point you tapped.
- b. Select  from the Notes toolbar.

Note:

- *If this is your first time using this function, and there is more than one dictionary on the Pen whose source language matches the current scanning language, the **Select Dictionary** pop-up will appear. Select the AHD Office dictionary. If you have already used this function, go to  and choose **Select Dictionary**.*
- *If there is only one dictionary corresponding to the current scanning language, this dictionary will be selected automatically.*

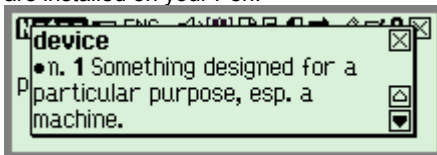
A pop-up similar to the following should be visible. The dictionary entry will vary depending on which dictionaries are installed on your Pen.



- c. Scroll through the dictionary entry using  and .
- d. Select  or press ESC to close the pop-up.

5. Hear scanned text read aloud

Select  from the **Notes** toolbar. The entire sentence will be read aloud.

Note: This function is only available when the Pen contains support for reading aloud in the selected language.

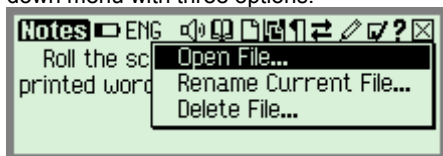

6. Working with files

Select  from the **Notes** toolbar. You will see a drop-down menu with three options:





- Select **Rename Current File**. The **Virtual Keyboard** will open and the file name 'file001' will appear highlighted in the editing area. This is the default file name.
- Using the stylus, change the name of the file to 'scanning'. Select to accept changes.
- Select  to create another file. Scan in the following text:

This is another scanning example.

- Go to  and select **Rename Current File**. Change the file name to 'example'. Select .
- Go back to  and select **Open File**. You will see that there are now two files on your Pen. Open the previous file, 'scanning'.
- Go to  and select **Delete File**. You will see both files again. Select the second file and press when prompted.

Note: All scanned text is automatically saved in the current file under a default file name. If you have scanned text on your screen and you choose to create a new file, you can return to the previous text by

selecting **Open File** in  and scrolling down to the last file saved.

Select  from the **Notes** toolbar to close **Notes** and return to the **Pen Main Menu**.

Transferring Notes files to the PC using the WizCom Desktop

The WizCom Desktop must be installed in order to connect the Pen to the PC and transfer files.

If you have not yet installed the WizCom Desktop see ***Installing the WizCom Desktop*** on page 6.

Make sure the USB cable is connected to both Pen and PC.

On the PC:

1. Launch the WizCom Desktop. If the WizCom Desktop is not already running, it can be activated by double-clicking on the WizCom Desktop icon on the Windows Desktop.
2. The WizCom Desktop icon  will appear in the Windows task bar, in **Offline** mode (gray).

On the Pen:

From the **Pen Main Menu** select **Connect to PC**.

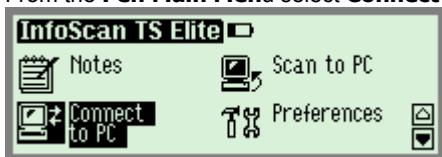

Connect to PC in the Pen Main Menu

The message **"Connecting to PC..."** will appear.

*Note: If the message **"Error Connecting to PC"** appears, check that the USB cable is connected to both the Pen and PC, and that the **WizCom Desktop** has been installed correctly and is running on the PC (the gray icon is visible in the notification area of the Windows taskbar).*

Pen-PC Communications:

When the Pen and PC successfully establish communications, the message "**Connected to PC. Press ESC key on Pen to exit**" will appear on the Pen screen.

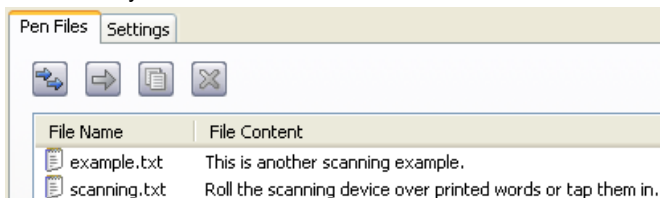

The WizCom Desktop will appear on the PC screen, and the icon in the taskbar will change from **Offline** to **Online** (green).

The **Pen Files** tab on the **WizCom Desktop** will display the files currently on the Pen:



A section of the WizCom Desktop showing files currently on the Pen.

Managing Files using the WizCom Desktop

1. Using the mouse, select the file 'example.txt' and press . This will copy the file to the PC. A browser window will appear, allowing you to change the destination folder.
2. Next, with the same file highlighted, select . This will delete the file from the Pen and from the WizCom Desktop. When the confirmation pop-up appears, select **OK**.
3. Select the remaining file and press . This will move 'scanning.txt' from the Pen to the PC. A browser window will appear, allowing you to change the destination folder.

The **Pen Files** tab in the WizCom Desktop should now be empty.

Note: Moving or deleting files using the WizCom Desktop will also delete them from the Pen.

i Files can be managed using the WizCom Desktop buttons or by clicking in the edit menu bar in the WizCom Desktop Menu. To move all the files on the Pen select the **Move all Pen Files to PC** option.

Press the ESC key on the Pen to disconnect the Pen from the WizCom Desktop. The Pen returns to the **Pen Main Menu** and the WizCom Desktop switches back to **Offline** mode.

Editing and Inserting Text

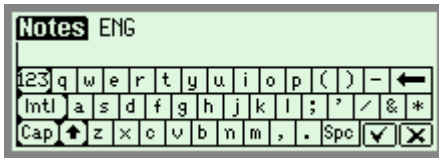

Use the **Virtual Keyboard** to input or edit text with the stylus. To access the **Virtual Keyboard** select  from the application toolbar.





The English Virtual Keyboard

The Editing Area

This is the insertion point for new text, as indicated by the blinking cursor. Use the stylus to enter or edit new text with the character keys, or scan text directly into the editing area.

Scanned text is underlined. Tapping any key other than  or  will accept the inserted text.







Text can be erased by:

1. Using  to delete individual characters.
2. Highlighting the text with the stylus and either selecting , or typing/scanning over the highlighted text.

The Keyboard

The keyboard layout corresponds to the selected scanning language settings.

The Keys:

	Backspace Tap to delete characters to the left of the cursor.
 or ESC	Close and Cancel Tap to reject all changes and return to the application screen.
 or Enter	Close and Save Tap to accept all changes and return to the application screen.
	Shift Tap to switch to uppercase characters. The keyboard will automatically return to the regular layout after selecting one character.
	Caps Lock Tap to view the upper-case character keyboard. Tap again to return to regular layout.
	International Tap to switch to the international keyboard. The keyboard will automatically return to the regular layout after selecting one character.
	Numeric Tap to view the numeric keyboard. Tap again to return to regular layout.

Scan to PC

The Scan to PC Functions

Scan to PC is used to scan text and send it directly to the PC. Text can be scanned into any file or application on the PC that has a blinking cursor.

The WizCom Desktop must be running and active on the PC screen. If there is no **Scan to PC** compatible application open on screen, the text will still be sent from the Pen, but will not be accessible on the PC.

For a step-by-step guide to using **Scan to PC**, see the ***Scan to PC Tutorial*** on page 27.

Scanning Modes

Scan to PC has two scanning modes:

Auto Send

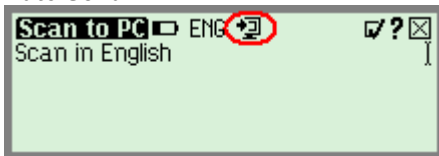

When this option is selected in the **Scan to PC** toolbar settings menu, any text that is scanned is sent directly into an open file on the PC that has a blinking cursor.

Non-Auto Send

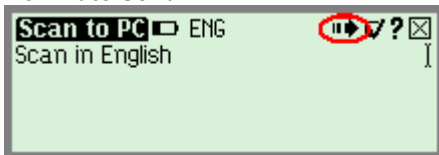

When the **Auto Send** option in the **Scan to PC** toolbar settings menu is disabled, **Scan to PC** changes to **non-Auto Send** mode. Scanned text is shown on the screen, and the user can choose whether to send the text or not.

When text is scanned, the **Send** option is highlighted on the toolbar. The user can either send the scanned text, or erase the scanned text by scanning again.

The Scan to PC Toolbar

The toolbar appears on the top right corner of the screen. It can be accessed using either the stylus or the Pen keys.

See **Accessing the Toolbar** on page 14.

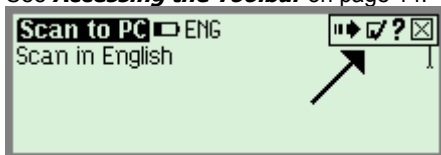

The Scan to PC Toolbar

Toolbar Options

Send ⇨

Use this option to send scanned text to the PC when **Auto Send** is not selected in the **Settings** menu.

Settings ☑

The **Settings** menu contains the following options:

Enlarged Font	Change the display setting to enlarged font.
Auto Send	Alternate between Auto Send and non-Auto Send modes. See Scanning Modes on page 25.
Inverse	Scan inverse text (white text on dark background).
Numeric	Use this option to scan numbers.
Change Scanning Language	Change the scanning language for the next scanned text. See Selecting a Language for Scanning on page 40.
Preferences	Display the Preferences menu (from the Pen Main Menu).

Help ?

The **Help** menu contains the following options:

Icons	An explanation of icons and graphic indicators.
Keys	An explanation of the Pen keys and their functions.

Scan to PC Tutorial

This tutorial will take you through the basic use of **Scan to PC**.

Scan to PC is used to scan text and send it directly to the PC. Text can be scanned into any file or application on the PC that has a blinking cursor.

The WizCom Desktop must be running in order to use **Scan to PC**. If you have not yet installed the WizCom Desktop see ***Installing the WizCom Desktop*** on page 6.

Establishing Pen-PC Communications

Make sure the USB cable is connected to both the Pen and PC.

On the PC:

Launch the WizCom Desktop. If the WizCom Desktop is not already running, it can be activated by double-clicking on the WizCom Desktop icon on the Windows Desktop.

The WizCom Desktop icon will appear in the Windows task bar, in **Offline** mode (gray).

On the Pen:

1. Press the red power key to turn the Pen on. If you do not see the **Pen Main Menu**, select to exit the current application and return to the **Pen Main Menu**.
2. From the **Pen Main Menu** select **Scan to PC**.



Scan to PC in the Pen Main Menu

The message "**Connecting to PC...**" will appear.

*Note: If the message "**Error Connecting to PC**" appears, check that the USB cable is connected to both the Pen and PC, and that the WizCom Desktop has*

been installed correctly and is running (the gray icon is visible in the notification area of the Windows taskbar).

Pen-PC Communications:

When the Pen and PC successfully establish communications, the WizCom Desktop icon in the taskbar will change from offline to **Scanning to PC** mode (green and yellow). The Pen will enter the **Scan to PC** application. The following screen should be visible:

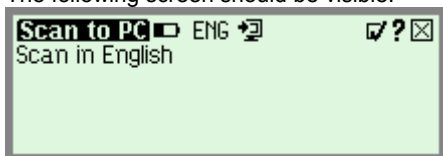

Scan to PC

Set the scanning language to **English** as follows:

1. Select from the toolbar by tapping with the stylus or by pressing ESC (red key) and using the direction keys.
2. Choose **Set Scanning Language** from the drop-down menu and select **English**.

Using Scan to PC

On the PC:

1. Open a **Microsoft Word** Document.
2. Set the language to **English** using the language option in the **Formatting Toolbar**.

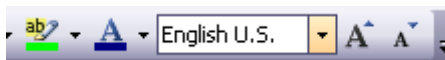

The Language option in the Formatting Toolbar

3. Make sure that a blinking cursor is visible, indicating that text can be inserted into the document.

Scan to PC can be used with any computer application that text can be inserted into (has a blinking cursor), e.g. most Microsoft Office applications, MSN Messenger and the address bar of Internet Explorer.

On the Pen:

Scan to PC has two modes: **Auto Send** and **non-Auto Send**. The Pen's default setting is **Auto Send**.

Using **Auto Send** mode:

1. In confirm that the **Auto Send** option is on (checked), and that  appears on the top of the screen.
2. Scan the following line:

Auto Send mode sends my text directly to the PC.

The '**Sending...**' message appears on the Pen Screen:

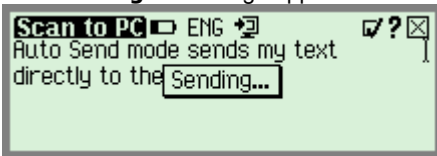

Sending text to the PC

The scanned text is sent to the PC with the following result:

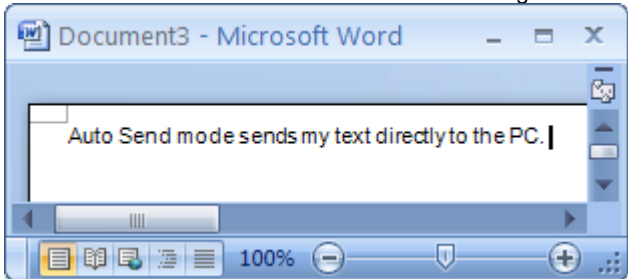

The scanned text appearing in the MS Word file

Using **non-Auto Send** mode:

1. In change the **Auto Send** option to off (not checked), and see that  (the **Send** icon) is now visible in the toolbar.
2. Scan the following line:

Select Send to send this text to the PC.

The Pen Applications

The following screen should appear:

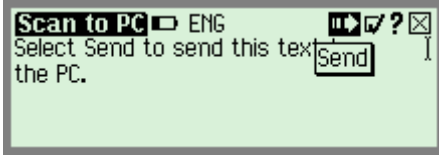

Scan to PC in non-Auto Send mode

❗ Scanning Tips: In **non-Auto Send** mode, if the scanning results are bad, simply scan again before you send the text, and the text on screen will be replaced with the newly scanned text. This is not possible in **Auto Send** mode, as the text is sent immediately to the PC.

3. Make sure the same Microsoft Word file as before is open on the PC and that the blinking cursor is visible.
4. On the Pen select **Send** by either tapping on it with the stylus or pressing the Enter key.
5. The '**Sending...**' box should appear on the Pen screen.

The scanned text is sent to the PC with the following result:

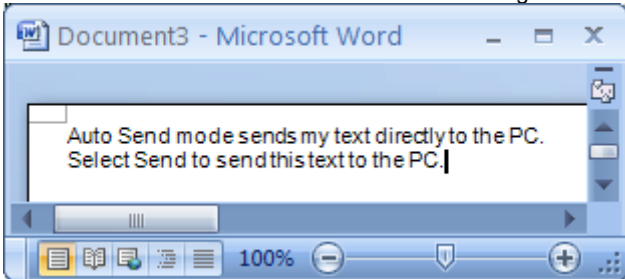

The scanned text appearing in the MS Word file

Changing Scan to PC Settings in the WizCom Desktop

The **Scan to PC** settings in the WizCom Desktop determine what key is inserted after each line of text is sent to the PC application. The default setting is **Space**, meaning that a space is inserted after each scan appears in the application.

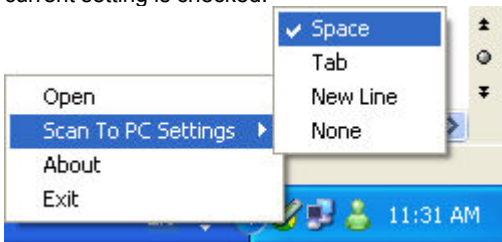

To change the setting:

1. Click on the WizCom Desktop icon  (green and yellow) in the notification area of the Windows taskbar. A menu list will appear.
2. From the menu list, click on **Scan to PC Settings**. A list will appear, showing the four available options. The current setting is checked.



Scan to PC Settings in the WizCom Desktop taskbar menu

3. Select the setting you wish to use. This setting will be applied for the next scans.

To exit **Scan to PC**, select  from the **Scan to PC** toolbar. The Pen will return to the **Pen Main Menu**, and the **WizCom Desktop** icon will revert to **Offline** mode  (grey).

The WizCom Desktop

Introduction to the Desktop

The WizCom Desktop has two main functions:

- The management of **Notes** files on the PC
- Scanning text to the PC using **Scan to PC**

Instructions for installing the WizCom Desktop and establishing Pen-PC Communications can be found on p6.

Launching the Desktop

By default, the Desktop is launched upon startup of Windows. This setting can be changed in the **Settings** tab of the Desktop.

The Desktop icon will appear in the Windows taskbar in **Offline** mode  (gray), and the following message will appear:

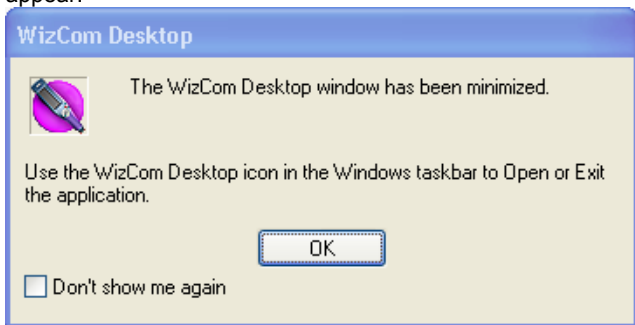

If the Desktop is not already running, it can be activated by clicking on the Desktop icon on the Windows Desktop. The above message will appear once again, and the Desktop icon will appear in the taskbar.

The Desktop Modes



The Desktop runs in three different modes:

- **Offline**
- **Online**
- **Scanning to PC**

The current mode can be seen on the Desktop and in the notification area of the Windows taskbar.

Offline



The Desktop runs in **Offline** mode when Pen-PC communications have not been established.

- The **Offline** icon  (gray) appears in the notification area of the Windows taskbar.
- Selecting **Open** from the taskbar will open the Desktop in the **Settings** tab. The **Pen Files** tab is inaccessible.
- The **Offline** mode indicator  (red) is seen at the bottom of the Desktop window.

*Note: Selecting **Connect to PC** or **Scan to PC** from the **Pen Main Menu** will switch the working mode.*

Online



The Desktop is in **Online** mode when communicating with the Pen through **Connect to PC** in the **Pen Main Menu**.

- The **Online** icon  (green) appears in the notification area of the Windows taskbar.
- The Desktop opens on screen in the **Pen Files** tab.
- The **Online** mode indicator  (green) is seen at the bottom of the Desktop window.

*Note: Exiting Pen-PC Communications by selecting the ESC key on the Pen will switch the Desktop to **Offline** mode and minimize the Desktop.*

Scanning to PC

The Desktop is in **Scanning to PC** mode when communicating with the Pen through **Scan to PC** in the **Pen Main Menu**.

- The **Scanning to PC** icon  (green and yellow) appears in the notification area of the Windows taskbar.
- Selecting **Open** from the taskbar will open the Desktop in the **Settings** tab. The **Pen Files** tab is inaccessible.
- The **Scanning to PC** mode indicator  (yellow) is seen at the bottom of the Desktop window.

*Note: Exiting Pen-PC Communications by selecting  from the **Scan to PC** toolbar on the Pen will switch the Desktop to **Offline** mode.*

The Desktop User Interface

The Desktop Main Menu

The Desktop Main Menu contains four menus:

Menu	Options
File	Exit: Exits the WizCom Desktop.
Edit	Move files from Pen to PC: Moves the selected files to the PC and deletes them from the Pen Copy files from Pen to PC: Copies the selected files to the PC Delete files from Pen: Deletes the selected files from the Pen Move all Pen files to PC: Moves all the Pen files to the PC and deletes them from the Pen Select all files: Selects all the files in the Pen Files list <i>Note: This menu is only available in Online mode</i>
View	Use this menu to switch between the Desktop tabs: Pen Files - only available in Online mode Settings
Help	View User Manual: Displays the help file for your Pen About: Displays version and copyright information for the Desktop

The Desktop Tabs

There are two tabs on the **Desktop**:

1. The Pen Files Tab

Notes files are managed using this tab. The tab is only available when the Pen is connected to the PC using the **Connect to PC** option from the **Pen Main Menu**.

All files currently on the Pen are displayed in the **Pen Files** pane, as seen in the following example:

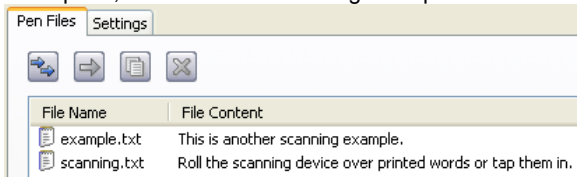

The Memory Status Bar

The Memory Status Bar at the bottom of the Desktop window, shows the **Data Files Memory Status** of the Pen.

Used Space shows the amount of space used by files currently on the Pen, and **Free Space** shows how much space is left for new files.

Used Space: 128 KB
 Free Space: 5671 KB

The Memory Status Bar

2. The Settings Tab

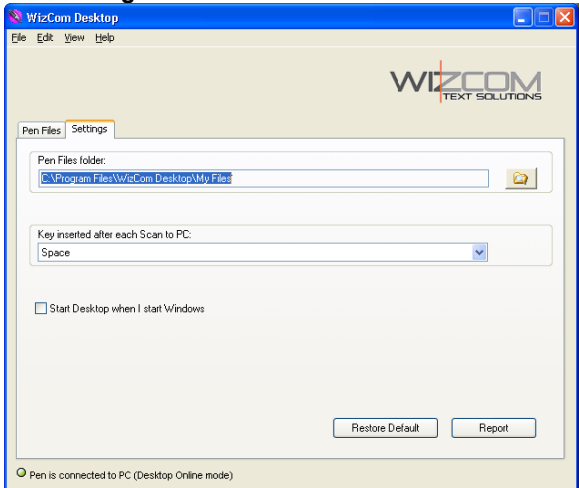

Use the **Settings** tab to do the following:

1. **Pen Files folder:** Change the default folder for copying and moving files from the Pen to the PC.
2. **Key inserted after each Scan to PC:** Select the key to be inserted after each line of text is sent to the PC application. There are four options: **Space**, **Tab**, **New Line** and **None**.
3. **Start Desktop when I start Windows:** Change the default Desktop start-up setting. Deselecting the box means that the Desktop will only start when its icon is selected from the Windows Desktop.

Use the buttons in the **Settings** tab to do the following:

1. **Restore Default:** Restore the **Settings** options to their default settings.
2. **Report:** Generate a report with information about the Pen and PC software you are using. The report is used to assist with technical support and is only available when the Pen is online.

The Task Bar Icons and Menu

The Desktop icon appears in the notification area of the Windows taskbar when the Desktop is running. Clicking the icon will open the Desktop window.

The icon has three modes:

- **Offline** 🚫 (gray)
- **Online** 🟢 (green)
- **Scanning to PC** 🟢🟡 (green and yellow)

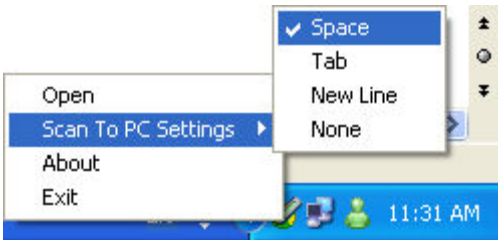

The taskbar menu

Clicking on the taskbar icon opens the taskbar menu. The taskbar menu has the following four options:

1. **Open:** Opens the Desktop window.
2. **Scan to PC Settings:** Allows you to determine what key is inserted after each line of text is sent to the PC application. There are four options: **Space**, **Tab**, **New Line** and **None**.
3. **Exit:** Exits the WizCom Desktop.
4. **About:** Displays version and copyright information for the Desktop.

Managing Notes Files Using the Desktop

Managing Notes files

Files can be moved, copied or deleted from the Pen using the Desktop. To do this, files must first be selected from the **Pen Files** tab.

You can select files using any of the following methods:

1. Select individual files with the mouse.
2. Use the **Select all files** option in the **Edit** menu.
3. Select Ctrl+A on the PC keyboard to select all files.

Notes files are managed using the following four options:



Move all Pen files to PC

Use this option to move all Pen files to the PC. All files will be deleted from the Pen. The option can be accessed in three ways:

1. From the **Edit** menu.
2. Using the **Move all Pen files to PC** icon  in the **Pen Files tab**.
3. By selecting Ctrl+V on the PC keyboard.



Move files from Pen to PC

Use this option to move selected Pen files to the PC. All moved files will be deleted from the Pen. The option can be accessed in three ways:

1. From the **Edit** menu.
2. Using the **Move files from Pen to PC** icon  in the **Pen Files** tab.
3. By selecting Ctrl+M on the PC keyboard.



Copy files from Pen to PC

Use this option to copy selected Pen files to the PC. Copied files will not be deleted from the Pen. The option can be accessed in three ways:

1. From the **Edit** menu.
2. Using the **Copy files from Pen to PC** icon  in the **Pen Files** tab.
3. By selecting Ctrl+C on the PC keyboard.



Delete files from Pen

Use this option to delete selected Pen files. The option can be accessed in three ways:

1. From the **Edit** menu.
2. Using the **Delete files from Pen** icon  in the **Pen Files** tab.
3. By selecting Delete on the PC keyboard.

Tips

Changing Scanning Settings

Scanning settings can be modified via the **Settings** menus in **Notes** and **Scan to PC**.

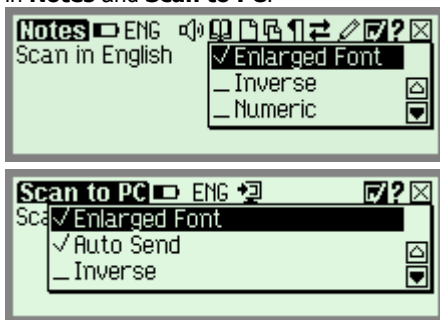

The Settings menus in Notes and Scan to PC

Changing the Font Size

There are two font sizes to choose from – regular and enlarged. You can change the font size by selecting or deselecting the **Enlarged Font** option in the **Settings** menu in the Pen applications.

*Note: The default setting is **Enlarged Font**.*

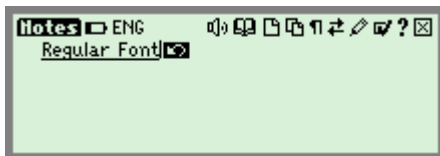

Regular Font

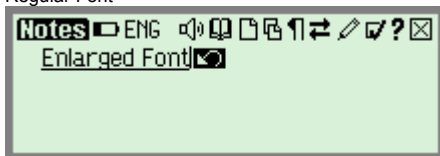

Enlarged Font

Inverse

The default scanning setting allows you to scan dark text on a light background. To enable scanning of light text on a dark background, select the **Inverse** option in the **Settings** menu.

Numeric

Use this option when scanning numbers only.

Selecting a Language for Scanning

Files can be scanned in various languages.

In **Notes**, the language setting can be changed through **Set Language for New File**. This setting allows you to change the scanning language for the next new file you open in **Notes**.

Note: The scanning language will only change when you open a new file. The current file will still retain the previous scanning language setting.

In **Scan to PC**, the language setting can be changed through **Change Scanning Language**.

If you are working in **Auto Send** mode, the language change will be applied immediately. If you are working in **non-Auto Send** mode and there is unsent text on the screen, a confirmation message will appear before the language is changed.

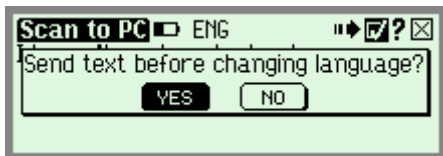

Change Scanning Language confirmation in Scan to PC

Scanning Guidelines

Scanning Mode

The Pen is in scanning mode when the red light at the tip of the Pen is blinking. Scanning mode is disabled when you are not in **Notes** or **Scan to PC**, or when accessing a toolbar menu.

Scanning Restrictions

The Pen scans and recognizes printed text in a wide range of languages, font types and point sizes (6-22 points, up to 8mm) and in a variety of colors on contrasting backgrounds (except red on white, white on red, blue on black and black on blue).

It does not recognize handwriting, cursive fonts, mathematical symbols or other profession-specific signs.

Scanning Direction

Text can be scanned from right to left or from left to right. Both will produce the same results.

Troubleshooting Poor Character Recognition

Poor character recognition may occur for the following reasons:

- Low quality scanning material.
- The scanning settings are not set correctly (e.g. **Inverse**).
- Holding the Pen at the wrong scanning angle.
- Scanning too fast.

Tips for Good Scanning

To ensure optimum scanning results:

- Hold the Pen at the correct scanning angle.
- Place the scanning material on a flat surface.
- Ensure scanning material is good quality and pages are not creased. Note that poorly photocopied materials may provide bad results.
- Do not scan too fast.

Pen Maintenance

To keep your product in good condition, follow these guidelines:

- Store in protective case when not in use.
- Keep away from excessive moisture and temperature extremes.
- Clean using a soft, damp cloth.
- Do not use soap or other cleaning aids on the touch screen.
- Avoid exposing to direct sunlight for extended periods of time.
- Avoid scratching or damaging the touch screen.

CAUTION: To reduce the risk of electrical shock or damage to the internal components, do not spray liquid directly on the screen or allow excess liquid to drip inside your Pen.

Troubleshooting Pen-PC Communications

If you receive an error message when attempting to select **Connect to PC** or **Scan to PC** from the **Pen Main Menu**, please follow the instructions below to confirm that you have successfully followed the installation procedures.



Confirm that:

1. Both the **Desktop** and the USB driver have been successfully installed, as instructed in the CD-ROM. If they have not been installed, or there were problems with the installation, insert the CD-ROM and click on the **WizCom Desktop Installation** button for instructions on installing the software and the USB driver.
2. The WizCom Desktop is running. Click on the WizCom Desktop icon on the Windows desktop to launch the application. If you fail to launch the WizCom Desktop, and receive a message indicating that you should install the **WizCom Pen** USB driver, do the following:

- a. Connect the USB cable to both Pen and PC.

- b. The **Add New Hardware Wizard** should appear.
 - c. Select the recommended path for installing the driver.
 - d. During the installation, a pop up message appears warning that the driver has 'not passed Windows Logo testing' - select **Continue Anyway**.
 - e. Complete the **Add New Hardware Wizard**.
3. The PC connector side of the USB cable is connected to a USB port on your PC
 4. The Pen connector side of the USB cable is connected to the USB outlet on the Pen **Top Panel**.

If you have followed all the above steps and you are still having problems, it may be that the **WizCom Pen** USB Driver has only been partially installed. To rectify this:

1. Make sure the Desktop is NOT running (if you can see the icon  in the notification area of the Windows taskbar, right-click on it and select **Exit** to completely shut down the application).
2. Connect the Pen to the PC with the USB cable as explained above in steps 3 and 4.
3. Access the Windows Device Manager as follows:
 - a. Right click the **My Computer** icon from the Windows desktop.
 - b. Select **Properties**.
 - c. Select the **Hardware** tab.
 - d. Click on **Device Manager**.
(Alternatively, from the Windows taskbar, go to **Start/Settings/Control Panel** and click on **System/Hardware/Device Manager**).
4. Open the **Imaging Devices** folder of the **Device Manager**.
5. If the **WizCom Pen** appears listed - with a yellow exclamation mark  - it means the driver has not been successfully installed.
6. Right click this icon and select **Update Driver**.

Product Specification

Pen Specification

Feature	Description
Display Type	Touch Screen Monochromatic FSTN Resolution: 208 x 65 Size: 61mm x 20mm / 2.4" x .8"
Keypad	<ul style="list-style-type: none"> ▪ Navigation Switch (Enter, Up, Down, Left, Right) ▪ Push Button - Power/ESC
CPU	ARM7 ASIC, 16 bit, 80 MHz
Memory	
▪ SRAM	64 K x 16 bit
▪ ROM/RAM	8 MB
Optical Scanner	<ul style="list-style-type: none"> ▪ 128 pixels linear array image sensor ▪ 400 DPI resolution
Communications	
IRDA, 115,200 bps	Optional
USB1.1	Yes
Power	
Internal Power	2 x 1.5V AAA Alkaline batteries
External Power	USB cable connected to PC
Current Consumption	<ul style="list-style-type: none"> ▪ Idle mode - 42 mA ▪ Max. (Peak) - 212 mA
Size	L x W x H: 177.5 mm x 41.5 mm x 33 mm (7" x 1.62" x 1.3")
Weight	<ul style="list-style-type: none"> ▪ 77 grams (2.716 oz.) without batteries ▪ 100 grams (3.527 oz.) with batteries
Safety	<ul style="list-style-type: none"> ▪ CE ▪ UL ▪ FCC class B
Operating Temperature Range	0°C - 40°C

Desktop Specification

The **WizCom Desktop** is compatible with Windows XP and Vista. Installing the Desktop on a PC with an incompatible operating system may cause it to operate ineffectively.

The PC must have an available USB port.

44 Download from [Www.Somanuals.com](http://www.Somanuals.com). All Manuals Search And Download.

Free Manuals Download Website

<http://myh66.com>

<http://usermanuals.us>

<http://www.somanuals.com>

<http://www.4manuals.cc>

<http://www.manual-lib.com>

<http://www.404manual.com>

<http://www.luxmanual.com>

<http://aubethermostatmanual.com>

Golf course search by state

<http://golfingnear.com>

Email search by domain

<http://emailbydomain.com>

Auto manuals search

<http://auto.somanuals.com>

TV manuals search

<http://tv.somanuals.com>