

OPERATION GUIDE

1F97-51

7-Day Programmable Electronic
Digital Thermostat



WHITE-RODGERS

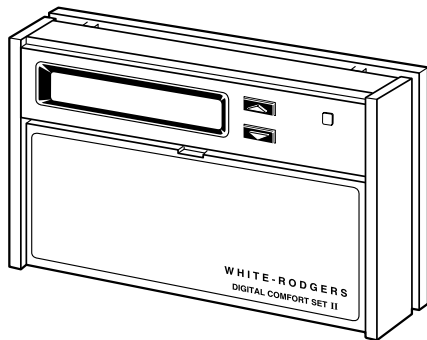

Operator: Save this booklet for future use!

About Your New Thermostat . . .

Your new White-Rodgers Digital Thermostat uses the technology of a solid-state microcomputer to provide precise time/temperature control. This thermostat offers you the flexibility to design heating and cooling programs that fit your needs.

Please read this manual thoroughly before operating or programming your thermostat. If you have questions, write to us at the address shown on the back cover of this manual.

In This Guide . . .

YOUR NEW THERMOSTAT'S

FEATURES 4

OPERATING YOUR THERMOSTAT 5

PARTS OF THE THERMOSTAT

The Back Of the Thermostat Body

The Display

The Thermostat Buttons

OPERATING FEATURES

PROGRAMMING YOUR

THERMOSTAT 16

PLANNING FOR YOUR NEEDS

ENTERING YOUR PROGRAM

Set Current Time and Day

Select Heating and Cooling Temperatures

Program Heating/Cooling Times and
Heating Temperatures

Program Cooling Temperatures

Using the HOLD/COPY Button

CHECK YOUR PROGRAMMING

QUESTIONS AND ANSWERS 31

**Operator: Save this
booklet for future use!**

YOUR NEW THERMOSTAT'S FEATURES

- Seven independent day programming
- Simultaneous heat and cool program storage
- Four separate time/temperature settings per 24-hour period
- Computed Energy Management Recovery (EMR)
- Armchair programming capability
- Backlit LCD displays continuous set point, time, and room temperature
- 1.5 volt "AA" Energizer® alkaline battery backup
- Preprogrammed temperature control
- Adjustable cycle times
- Compressor short cycle protection
- Programmable blower control
- Blower delay in the cooling cycle
- Audio and visual prompting during operation
- Two hour temperature override
- Manual program override (HOLD temperature)
- °F/°C convertibility
- Temperature range 40° to 99°F

OPERATING YOUR THERMOSTAT

Before you begin programming your thermostat, you should be familiar with its features and with the display and the location and operation of the thermostat buttons. The information in this section will help you become familiar with your new thermostat so that you can easily program it.

Your thermostat consists of two parts: the **thermostat body** and the **subbase**.

 **CAUTION**

Remove power from the system at the circuit breaker/fuse box before removing or attaching the thermostat body. Equipment damage and/or personal injury could occur.

The subbase is attached to the wall, but you can remove the thermostat body for easy programming. To remove the thermostat body from the subbase, grasp the thermostat body and gently pull it straight out from the subbase. To attach the thermostat body, line up the two terminal pins on the lower section of the thermostat back with the matching connector on the subbase. Insert these, then gently pivot the thermostat body up to connect the six pin connectors on the upper portion of the thermostat back. Gently push until the snap connectors engage. **DO NOT FORCE OR PRY THE THERMOSTAT**, as this may damage the unit.

PARTS OF THE THERMOSTAT

The Back of The Thermostat Body

Turn the thermostat body over. On the back are the 3 “AA” Energizer® alkaline batteries.

The “AA” Energizer® alkaline batteries provide power to the thermostat when the 24 VAC power is interrupted (for example, when you remove the thermostat from the wall for programming).

Fresh batteries will maintain the stored program for approximately a year. If power loss is long enough for the program to be lost, the thermostat will automatically return to the factory programmed temperatures (64°F heating and 82°F cooling) when power is restored. You must reprogram the thermostat if this happens.

If the word **BATTERY** is flashing in the display

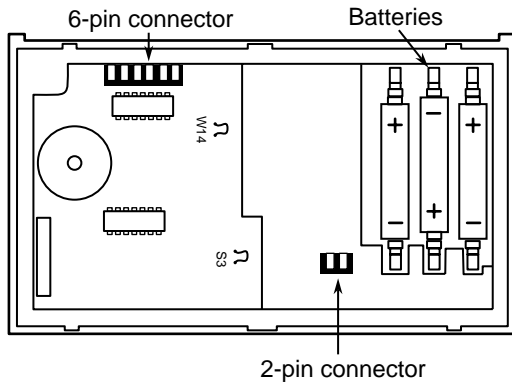



BACK OF THERMOSTAT BODY

window, the batteries are low and should be replaced with fresh “AA” Energizer® alkaline batteries.

! CAUTION

Use  to turn thermostat OFF before removing thermostat from the wall to replace the batteries.

On the following pages there are brief descriptions of the display and the thermostat buttons.



Other than  and , the buttons are located behind the thermostat door. To open the door, use your fingernail in the indentation at the top of the door to pull it out from the top, then swing it down on its hinges.

The Display

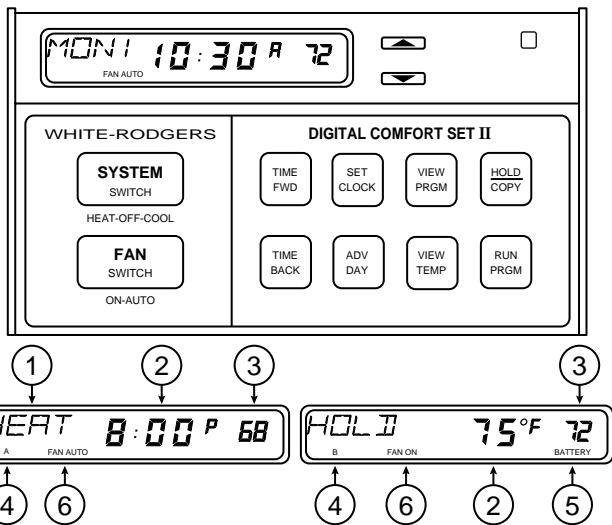
- ① Continuously displays system mode (**HEAT**, **OFF**, **COOL**, **HOLD**). During programming, the day of the week is displayed (**MON**, **TUE**, **WED**, etc.).
- ② Alternately displays room temperature (**F** denotes degrees Fahrenheit and **C** denotes degrees Celsius) and time of day (**A** denotes AM time and **P** denotes PM time).
- ③ Displays the setpoint temperature.
- ④ In **VIEW TEMP** mode, **A**, **B**, **C**, and **D** are the 1st, 2nd, 3rd, and 4th heating or cooling temperatures available for programming.
- ⑤ The word **BATTERY** flashes on the display when the “AA” alkaline batteries are weak and should be replaced. The word **BATTERY** is displayed continuously (non-flashing) when thermostat is running on battery power only.
- ⑥ **FAN ON** is displayed when the blower is operating continuously. **FAN AUTO** is displayed during automatic fan operation (when the blower cycles with the heating or cooling system).



The Thermostat Buttons

- ⑦ Sets the system mode (**HEAT**ing, **OFF**, or **COOL**ing).
- ⑧ Selects fan operation (see #6, above). This button is also used to program the fan to run continuously during a program period.
- ⑨ Runs display forward or backward through time, day, or anticipation settings during programming.
- ⑩ Used with  and  to set current time and day of the week.
- ⑪ Used during programming to set the day of the week to be programmed. Also used with  to enter anticipation setting mode.
- ⑫ Used to initiate or review thermostat programming.
- ⑬ Used to select heating and cooling temperatures to be programmed.
- ⑭ Used to manually override programming to hold at a selected temperature (when **HOLD** is displayed). Also used to copy one day's programming into another (when **COPY** is displayed).
- ⑮ Used to start program operation after programming. Also used to return thermostat to program operation after being in **HOLD** mode.
- ⑯ (Red arrow) Raises temperature setting (99°F or 37°C maximum).

⑰ (Blue arrow) Lowers temperature setting (40°F or 4°C minimum).

⑱ The red indicator light glows whenever heating, cooling, or fan are in operation.

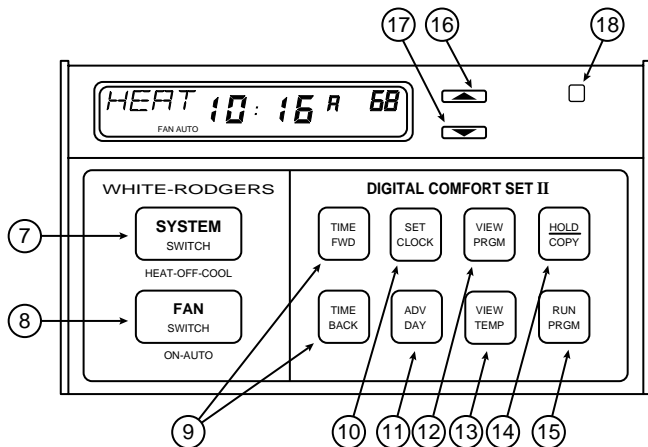



OPERATING FEATURES







Now that you are familiar with the thermostat display and buttons, read the following information to learn about the many features of the thermostat.

- **COMPUTED ENERGY MANAGEMENT RECOVERY (EMR)** — The thermostat's microcomputer can be set to automatically calculate the time it will take to change the temperature to the next program setting. Then the thermostat will activate the heating or cooling system to change the temperature so that the desired temperature is reached at the beginning of the next program period. As an example of this feature, assume that you have programmed your thermostat to provide an overnight heating temperature of 62°F, and that during the next program period, beginning at 6:00 AM,

you have programmed a temperature of 70°F. The thermostat will automatically activate the heating system at 5:00 AM, so that the programmed 70°F temperature is reached by about 6:00 AM.

The thermostat is configured at the factory so that this feature is disabled. If you wish to have this feature, refer to the installation instructions for this thermostat, or contact your local heating/cooling contractor.



- **TWO HOUR TEMPERATURE OVERRIDE** — Press  or  until the display shows the temperature you want. The thermostat will override current programming and keep the room temperature at the selected temperature for two hours. After two hours, the thermostat will automatically revert to the program.

- HOLD TEMPERATURE** — The thermostat can hold any temperature within its range for an indefinite period, without reverting to the program. Press . **HOLD** will be displayed. Then choose the desired hold temperature by pressing  or . The thermostat will hold the room temperature at the selected setting until you press  to start program operation again. This feature is ideal for energy conservation when the building is unoccupied for an extended period of time.
- °F/°C CONVERTIBILITY** — Press  and  at the same time until the temperature display is in °C (Celsius). To display °F, repeat the process.







- ADJUSTABLE HEATING AND COOLING CYCLE TIMES (ANTICIPATION)** — If the heating/cooling system is turning on and off too often (short cycles) or not often enough (long cycles), you may want to adjust the anticipation setting.

 **CAUTION**

A cooling anticipation setting of less than 10 may cause decreased compressor life.



To adjust **heat** anticipation, press  and  at the same time. The display will show **HEAT 5** (this is the factory preprogrammed heating anticipation setting). You may select any anticipation setting from 4 to 40 (**note that for hydronic systems, a minimum anticipation setting of 15 is recommended**).

Whenever adjusting anticipation, increase or decrease the displayed number by only one or two digits, then let the system run for a while to see if the adjustment is sufficient.

If the heat cycles are too short, press  to increase the cycle time. If the heat cycles are too long, press  to decrease the cycle time. To set **cooling** anticipation, press  and  at the same time again. The display will show **COOL 14** (factory preprogrammed cooling anticipation). Use the  and  buttons to adjust anticipation. Press  to return to your program.

- **LOW BATTERY INDICATOR** — The three “AA” alkaline batteries will maintain thermostat programming for approximately one year if power to the thermostat fails. The word **BATTERY** will flash on the display if the “AA” alkaline batteries are low and should be replaced. The thermostat will also make a beeping sound every five minutes when batteries need replacing. To override the beeping, press any button on the keypad. The beeping will stop for 15 hours, then start again. You may again stop the beeping by pressing any button on the keypad. After turning the beep off three times, the thermostat will quit beeping. However, you should always change the batteries as soon as possible to ensure that programming will not be lost in the event of a power outage. You should also change the batteries at **least once a year.**

The word **BATTERY** will be displayed continuously (non-flashing) when 24 VAC power is not being supplied to the thermostat and the thermostat is operating on battery power only.

- **AUDIO PROMPTING** — Each time you press a button, the thermostat will beep.
 - **BACKLIT DISPLAY** — When you press any button on the thermostat, the display is lit for approximately eight seconds.
 - **SYSTEM INDICATOR LIGHT** — The red light on the upper right part of the thermostat indicates system operation (see **PARTS OF THE THERMOSTAT**).
- **COMPRESSOR SHORT CYCLE PROTECTION** — To protect your compressor from potential damage due to rapid cycling, this thermostat has a built-in delay of 5 minutes between cooling cycles. The following may cause a time delay in **COOL**:
 - a) Return of power after a power outage.
 - b) Pressing  to change operating modes.
 - c) Pressing , creating a call for **COOL** too soon after a previous call.

PROGRAMMING YOUR THERMOSTAT

Now you are ready to program your thermostat. This section will help you plan your thermostat's program to meet your needs.

For maximum comfort and efficiency, keep the following guidelines in mind when planning your program.

- When heating (cooling) your building, program the temperatures to be cooler (warmer) when the building is vacant or during periods of low activity.
- During early morning hours, the need for cooling is usually minimal.

PLANNING FOR YOUR NEEDS

First, answer the following questions to help you decide what your needs are. If you are using the

thermostat for a commercial application (a store, office building, etc.), answer questions 1 through 4. If you are using the thermostat in your home, answer questions 5 through 8.

FOR COMMERCIAL APPLICATIONS:

- 1a. What time does the first person arrive at the building in the morning?
 - b. What temperature should the building be at this time? (heating? cooling?) These will be your **MOR** (morning) temperature settings.
- 2a. What time do the building occupants reach a maximum activity level (using lights, equipment, meeting rooms, etc.)?
 - b. What temperature should the building be at this time? These will be your **DAY** temperature settings.

- 3a. What time do the building occupants reach a minimum activity level (limited personnel in building)?
 - b. What temperature should the building be at this time? These will be your **EVE** (evening) temperature settings.
 - 4a. What time does the building become vacant?
 - b. What temperature should the building be at this time? These will be your **NHT** (night) temperature settings.
- IN YOUR HOME:
- 5a. What time does the first person get up in the morning?
 - b. What temperature should the house be at this time? These will be your **MOR** (morning) temperature settings.
 - 6a. What time does the last person leave the house in the morning?
 - b. What temperature should the house be at this time? These will be your **DAY** temperature settings.
 - 7a. What time does the first person arrive home in the evening?
 - b. What temperature should the house be at this time? These will be your **EVE** (evening) temperature settings.
 - 8a. What time does the last person go to bed at night?
 - b. What temperature should the house be at this time? These will be your **NHT** (night) temperature settings.

Now look at the factory preprogrammed times and temperatures shown at right. If this program will suit your needs, simply press  to begin running the factory preset program.

If you want to change the preprogrammed times and temperatures, follow these steps.

1. Determine the heating and cooling temperatures you want to use. You may select up to four heating temperatures (**HEAT A**, **HEAT B**, **HEAT C**, and **HEAT D**), and up to four cooling temperatures (**COOL A**, **COOL B**, **COOL C**, and **COOL D**). Use the table on the following page to write down the temperatures you have selected.
2. Determine the time periods during which you will program the temperatures you have just selected. You must program four periods for each day (periods 1, 2, 3, and 4).

FACTORY PREPROGRAMMING CHART					
Heating Program for ALL days of the Week:			Cooling Program for ALL Days of the Week:		
PERIOD	TIME	TEMP	PERIOD	TIME	TEMP
1	5:00 AM	70	1	5:00 AM	78
2	9:00 AM	70	2	9:00 AM	82
3	4:00 PM	70	3	4:00 PM	78
4	10:00 PM	64	4	10:00 PM	78

However, you may use the same heating and cooling temperatures for consecutive time periods. Also keep in mind that, for any given day, you can only program one set of times for both heating and cooling (for example, if you select 5:00 AM to begin heating period 1 on Monday, then your cooling period 1 for Monday will also begin at 5:00 AM). However, you may choose different time periods for each day separately (for example, heating/cooling period 1 on Monday may begin at 5:00 AM, but heating/cooling period 1 on Saturday may begin at

9:00 AM). Use the table on the following page to plan your program time periods, and the temperatures you want during each period. You may also want to look at the sample program table to get an idea of how the thermostat can be programmed.

Temperature Designation	Your Selected Temperatures*	Factory Preprogrammed Temperature
HEAT A	_____	70
HEAT B	_____	70
HEAT C	_____	70
HEAT D	_____	64
COOL A	_____	78
COOL B	_____	82
COOL C	_____	78
COOL D	_____	78

* You may only program heating temperatures you have selected into the heating program and cooling temperatures into the cooling program (for example, you cannot program the COOL A temperature into your heating program). You may program the temperatures you choose in any order, and you may use the same temperature in consecutive program periods (for example, you may program period 1 with temperature B and periods 2, 3, and 4 with temperature A). You do not have to use all possible temperature choices (for example, you may want to select temperatures for HEAT A and HEAT B only – in this case, the HEAT C and HEAT D temperatures would stay the same as previously programmed).

Heating/Cooling Schedule Plan

THIS THERMOSTAT ALLOWS ONE SET OF TIMES FOR BOTH HEATING AND COOLING

	Period 1			Period 2			Period 3			Period 4		
	Time	Heat Temp.	Cool Temp.	Time	Heat Temp.	Cool Temp.	Time	Heat Temp.	Cool Temp.	Time	Heat Temp.	Cool Temp.
Monday												
Tuesday												
Wednesday												
Thursday												
Friday												
Saturday												
Sunday												

Joe's Restaurant

Closed Mondays

Open Tues. – Sat. 10:30 AM to 10:00 PM

Open Sunday 6:30 AM to 2:00 PM

**SAMPLE
Heating/Cooling Schedule Plan**

HEAT A = 65° COOL A = 80°

HEAT B = 68° COOL B = 78°

HEAT C = 70° COOL C = 76°

HEAT D = 72° COOL D = 74°

THIS THERMOSTAT ALLOWS ONE SET OF TIMES FOR BOTH HEATING AND COOLING

	Period 1			Period 2			Period 3			Period 4		
	Time	Heat Temp.	Cool Temp.	Time	Heat Temp.	Cool Temp.	Time	Heat Temp.	Cool Temp.	Time	Heat Temp.	Cool Temp.
Monday	5:00 AM	65° (A)	80° (A)	9:00 AM	65° (A)	80° (A)	3:30 PM	65° (A)	80° (A)	11:30 PM	65° (A)	80° (A)
Tuesday	5:00 AM	65° (A)	80° (A)	9:00 AM	70° (C)	76° (C)	3:30 PM	72° (D)	74° (D)	11:30 PM	65° (A)	80° (A)
Wednesday	5:00 AM	65° (A)	80° (A)	9:00 AM	70° (C)	76° (C)	3:30 PM	72° (D)	74° (D)	11:30 PM	65° (A)	80° (A)
Thursday	5:00 AM	65° (A)	80° (A)	9:00 AM	70° (C)	76° (C)	3:30 PM	72° (D)	74° (D)	11:30 PM	65° (A)	80° (A)
Friday	5:00 AM	65° (A)	80° (A)	9:00 AM	70° (C)	76° (C)	3:30 PM	72° (D)	74° (D)	11:30 PM	65° (A)	80° (A)
Saturday	5:00 AM	65° (A)	80° (A)	9:00 AM	70° (C)	76° (C)	3:30 PM	72° (D)	74° (D)	11:30 PM	65° (A)	80° (A)
Sunday	5:00 AM	70° (C)	78° (B)	9:00 AM	70° (C)	76° (C)	3:30 PM	68° (B)	76° (C)	11:30 PM	65° (A)	80° (A)

ENTERING YOUR PROGRAM



Follow these steps to enter the heating/cooling program you have selected.

We recommend that you remove the thermostat from the wall for programming (especially for entering cooling programming). Fresh "AA" Energizer® alkaline batteries must be installed to perform off-wall programming. **BE SURE SYSTEM SWITCH IS SET TO OFF POSITION BEFORE REATTACHING THERMOSTAT TO SUBBASE!**

Set Current Time and Day

1. Press  once. The display will show minutes only.



EXAMPLE: 

2. Press and hold either  or  until you

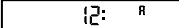

reach the correct minutes.

3. Press  once. The display window will show the hour only.

EXAMPLE: 



4. Press and hold either  or  until you reach the correct hour and AM/PM designation (**AM** begins at midnight; **PM** begins at noon).





5. Press  once. The display will show the day of the week as an abbreviation (**MON** for Monday, **TUE** for Tuesday, etc.).







6. Press and hold either  or  until you reach the current day of the week.





7. Press  once. The display will show the correct time and room temperature alternately.

Select Heating and Cooling Temperatures



During programming, if you don't press any buttons for 5 minutes, the thermostat will enter the **HOLD** mode and will maintain a constant temperature. The display will revert to the alternating time/temperature display. To resume programming after this happens, press  until you are at the point where you stopped programming. Then you may continue to enter your programs normally. If you want to stop programming at any time, simply press  to resume program operation.

1. Press  until **HEAT** is displayed.
2. Press  once. The display will continue to show **HEAT**. Below **HEAT** is the letter **A**, representing the first programmed heating temperature (**HEAT A**). At the right of the display is the currently programmed **HEAT A** setting.
3. Press either  or  to change the temperature to your selected **HEAT A** setting. (If you only want to program a temperature for **HEAT A**, skip to step 7.)
4. Press  once. The letter **A** will change to the letter **B**, representing **HEAT B**.

5. Press either  or  to change the temperature to your selected **HEAT B** setting (if you only want to program temperatures for **HEAT A** and **HEAT B**, skip to step 7).
6. Repeat steps 4 and 5 to select **HEAT C** and **HEAT D** temperature settings, if desired.
7. Press .
8. Press  until **COOL** is displayed.
9. Press  once. The display will show **COOL** and **A**, representing the first programmed cooling temperature (**COOL A**).
10. Press either  or  to change the temperature to your selected **COOL A** setting (if you only want to program a temperature for **COOL A**, skip to step 13).







11. Press  once. Press  or  to set your selected **COOL B** setting (if you only want to program temperatures for **COOL A** and **COOL B**, skip to step 13).
12. Repeat step 11 to select **COOL C** and **COOL D** temperature settings, if desired.
13. Press .

Program Heating/Cooling Times and Heating Temperatures



1. Press  until **HEAT** is displayed.
2. Press  once. **MON**, the abbreviation for Monday, and the number **1**, representing the **first** heating/cooling period, will be displayed. Also displayed are the currently

programmed start time for heating/cooling period 1 and the currently programmed **HEAT A, B, C, or D** temperature for heating/cooling period 1.



EXAMPLE: 



- To change the displayed start time to your selected start time for Monday's period 1, press  or  until your selected time appears. The time will change in 15-minute increments. **The time that you program will be the start time of Monday's period 1 for both heating and cooling programs.**
- If the temperature displayed is not the **HEAT A, B, C, or D** temperature you want for Monday's period 1, press  or  (if you continue to press  or , the display will alternately display the **HEAT A,**

B, C, or D temperatures you have already programmed).

- If you want the fan to run continuously during this time period, press  until **PRG FAN** appears in the display (if you skip this step, the fan will cycle automatically with the heating/cooling system).
- After selecting the desired heating temperature for Monday's heating/cooling period 1, press . The currently programmed start time and heating temperature for Monday's period 2 will be displayed.
- Repeat steps 3 through 5 to select the start time, heating temperature, and fan operation for Monday's heating/cooling period 2.
- Repeat steps 3 through 7 for Monday's heating/cooling periods 3 and 4.

NOTE









The thermostat has a built-in **COPY** feature. **This feature automatically copies the heating and cooling programs you select for Monday into Tuesday's through Sunday's programs.** If you want to have the same programming every day, after you program Monday's schedule, you simply press  to start the thermostat's programmed operation. Every day will then use the same program you set for Monday. You may also use the  button to copy any day's program into any other day (see **USING THE HOLD/COPY BUTTON**).

- To enter Tuesday's through Sunday's heating programs, use the  button as described below, or press  until the correct day's abbreviation appears in the display and repeat the above steps to program each day's heating/cooling periods and heating temperatures.
- When you have completed programming your heating/cooling periods and heating temperatures, press .

Program Cooling Temperatures

CAUTION



If outside temperature is below 50°F, we recommend that you remove the thermostat from the wall before proceeding with the following steps to program cooling temperatures. Personal injury and/or property damage could result from air conditioner compressor slugging. Fresh “AA” alkaline batteries (such as Energizer® brand) must be installed to perform off-wall programming. Programming away from the wall should prevent accidental compressor operation. **BE SURE TO PRESS  UNTIL OFF IS DISPLAYED BEFORE REATTACHING THE THERMOSTAT TO THE SUBBASE!**

1. To program cooling temperatures for the heating/cooling periods you have already set, press  until **COOL** is displayed.
2. Press  once. The Monday heating/cooling period 1 start time you programmed earlier will be displayed, along with the currently programmed **COOL A, B, C, or D** temperature.
3. Press  or  to display the **COOL A, B, C, or D** temperature you want for Monday's heating/cooling period 1. If you want the fan to run continuously during this period, press  until **PRG FAN** is displayed.
4. Press , then press  or  to select Monday's **COOL A, B, C, or D** tem-

perature for period 2. If you want the fan to run continuously during this period, press



until **PRG FAN** is displayed.

- Repeat step 4 for Monday's heating cooling periods 3 and 4.
- Use the  button, or press  to choose other days to program. Remember, once you enter Monday's program, Monday's program is automatically copied into Tuesday's through Sunday's programs.
- After you enter or copy heating and cooling programs for all seven days, press  to begin program operation.







Using the HOLD/COPY Button

You can use the button to copy any day's entire heating/cooling program into any other day's program. However, you must perform each copy function separately. Each time you begin a **COPY** operation, you must start with the day's program you wish to copy **FROM**. A **COPY** operation is not complete until  has been pressed **twice**.

NOTE

For most efficient programming, you should enter both the heating and cooling programs for the day you wish to copy **FROM** before using the **COPY** function, since the **COPY** function copies the entire day's programming to other days.





- Press  once.

2. Press  until the day you want to copy **from** is displayed. If you have not completed programming for this day, do so before proceeding.
3. Press  once. **COPY** will appear on the display. A number from 1 to 7 will also be displayed, representing the day you have selected to copy from (Monday is 1, Tuesday is 2, etc.). For example, if in step 2 you selected to copy Wednesday's program, when you press , **COPY 3** will be displayed.
4. Press  to select the day you want to copy the program **TO**.
5. Press . **COPY** will disappear from the display, and the display will show the copied heating/cooling time and temperature for the day you copied **to**.
6. Repeat the above steps to copy any day's programming into any other day's program.
7. Press  to begin program operation.

CHECK YOUR PROGRAMMING



Follow these steps to check your thermostat programming one final time before beginning thermostat operation.

1. Press  until **HEAT** is displayed.

2. Press and hold  to view the heating/cooling period times and heating temperatures for Monday.
3. Press  once to advance to Tuesday.
4. Press and hold  to view heating/cooling periods and heating temperatures for Tuesday.
5. Repeat steps 3 and 4 to review all remaining days' programming. If you find an error in any day's programming, go back to the programming instructions to correct the error.
6. Press .
7. Press  until **COOL** is displayed.



8. Repeat steps 2 through 5 to check cooling temperatures.
9. Press  to begin program operation.

YOUR THERMOSTAT IS NOW COMPLETELY PROGRAMMED AND READY TO AUTOMATICALLY PROVIDE MAXIMUM COMFORT AND EFFICIENCY!

Press  until **OFF** is displayed. Reattach thermostat to subbase. Then press  to select the operation mode you want (**HEAT** or **COOL**). Press  until **FAN AUTO** is displayed (automatic cycling).

QUESTIONS AND ANSWERS

1. **How can I permanently change a part of my program?**

Press  and  until you reach the time/temperature schedule you want. Then press



 or  and  or  to change the program. See **PROGRAMMING YOUR THERMOSTAT**.

2. **How can I have no change in temperature from one time period to another?**

Simply select the same temperature for each consecutive time period. For example, you may select the same **COOL A** temperature for period 2 as you did for period 1, which means the temperature will not change

from **COOL A** when period 2 begins. See **PROGRAMMING YOUR THERMOSTAT**.

3. **How can I finish my programming if the display has already changed to time/temperature?**

During programming, if no buttons are pressed for five minutes, the thermostat will enter the **HOLD** mode and maintain a constant temperature. The display will change to the time/temperature mode. To resume programming, press  and  until you return to the point where you stopped programming. Then you may continue to program the thermostat normally. If you want to

stop programming at this point, press  to start the normal program function. See **PROGRAMMING YOUR THERMOSTAT**.

4. What happens if the electricity goes off or is manually shut off?

If you have not installed 3 “AA” alkaline batteries, the display will go blank and the program will be lost in approximately one minute. When electricity is restored, the clock will reset itself to 12:00 PM (noon) and the thermostat will maintain a heating temperature of 64°F and a cooling temperature of 82°F until you reenter your program. Setpoint temperature will not be displayed.

If fresh “AA” Energizer® alkaline batteries are installed, the program will be main-

tained for about one year with no 24 VAC power present to the thermostat. See **OPERATING YOUR THERMOSTAT**.

5. Why is the fan running constantly, regardless of system operation?



You have programmed the fan to run continuously during this program period. To

override the programmed fan, press  until **FAN AUTO** is displayed. To change the programming, see **PROGRAMMING YOUR THERMOSTAT**.

6. What can cause the thermostat display to freeze or go blank?

A completely blank display may indicate that power has been lost to the thermostat and the backup batteries are also dead. However, if there is power to the thermostat

and the display is blank or frozen, static discharge is probably the cause.

During periods of low humidity (especially during cold weather), you may feel or see a spark discharge when you touch the thermostat. This may cause the program to be lost or the thermostat to display incorrectly. To correct this, remove the thermostat from the wall and disconnect the batteries. Wait about two minutes, then reconnect the batteries. The thermostat will revert to the factory preset program until you reprogram the thermostat. If you don't want to reprogram the thermostat immediately, press  until **OFF** is displayed and replace the thermostat on the wall. Press  until **HEAT** or **COOL** is displayed, then press

 to begin the factory preset program. Or you may reprogram the thermostat, then replace it on the wall.

To prevent further static discharge problems, touch another object to release static build-up before touching the thermostat. See **OPERATING YOUR THERMOSTAT**.

7. The display is flashing **BATTERY**. What does this mean?

The "AA" batteries installed in the thermostat are low and should be replaced with fresh "AA" Energizer® alkaline batteries. See **OPERATING YOUR THERMOSTAT**.

8. The thermostat beeps every few minutes. What does this mean?

The thermostat will beep every five minutes when the batteries are low and need replacing. To override the beeping, press any button on the keypad. The beeping will stop for 15 hours, then start again. You may again stop the beeping by pressing any button on the keypad. After turning the beep off three times, the thermostat will quit beeping. However, you risk losing your thermostat programming if you continue to turn off the beep and do not change the batteries. See **OPERATING YOUR THERMOSTAT**.

9. The display shows a continuous (non-flashing) BATTERY. What does this mean?

The thermostat is not being supplied with 24 VAC power. The thermostat is operating on battery power alone. See **OPERATING YOUR THERMOSTAT**.

10. Why won't the compressor turn on, even though the thermostat display is functioning normally?

Either the compressor lockout feature is in operation or the thermostat is not currently calling for cool. Wait about 5 minutes for the compressor lockout to expire. If the system is still not running, read the cautionary statement below. Then, **if conditions permit**, use the  button to move the temperature below the setpoint temperature. See **OPERATING YOUR THERMOSTAT**.

⚠ CAUTION

If the outside temperature is below 50°F, **DO NOT** use the  button to move the temperature below the setpoint temperature. Property damage may result due to compressor slugging.

11. Why doesn't the temperature change at the time I programmed?

There may be a number of causes for this situation. The following are primary reasons.

- The **EMR** function is operating. The **EMR** function will automatically bring on the system automatically to bring the temperature to the selected level by the beginning of the next program period. See **OPERATING YOUR THERMOSTAT**.

- You have programmed the incorrect day or time. Check your programming (be sure that the times you programmed are correct AM or PM times). See **PROGRAMMING YOUR THERMOSTAT**.
- The thermostat is in the **HOLD** mode. Press  to start program operation. See **OPERATING YOUR THERMOSTAT**.
- The compressor lockout feature is operating; wait about 5 minutes for system to begin running. See **OPERATING YOUR THERMOSTAT**.



12. Why does the blower fan keep running after the system has turned off?

- You have programmed the fan to run continuously during this period. See **PROGRAMMING YOUR THERMOSTAT**.
- The blower delay feature is operating. This energy saving feature continues to blow conditioned air through the ducts after the system has turned off, rather than letting the air dissipate.

13. Why is the system turning on and off so frequently (seldom)?

The anticipation setting is too low (high). To change anticipation settings, see **OPERATING YOUR THERMOSTAT**.

14. Between heating and cooling seasons, I want to turn my system off. Can I do this without affecting my thermostat programming?

Any time you wish to turn your system off, simply press  until the display shows **OFF**. This will not affect your thermostat's programming in any way. To turn the system back on, press  until **HEAT**, **COOL**, etc. is displayed. The system will automatically begin operating according to the current thermostat program, unless the thermostat is in the **HOLD** mode. See **OPERATING YOUR THERMOSTAT**.

15. I live in an area where daylight savings time is observed. How do I change the thermostat clock twice a year without affecting thermostat programming?

To change your clock, follow the instructions for setting current time and day. See **ENTERING YOUR PROGRAM**. Thermostat programming is not affected when you change the clock.

16. Do I have to reprogram my thermostat after I change the batteries?

When the thermostat is on the wall and the system has power, the thermostat is being powered by a 24 VAC source. If power is lost, or if the thermostat is removed from the wall, the program will be retained for approximately **one minute** if there are no batteries installed or if the installed batteries are dead. If you are changing the batteries

after seeing a flashing **BATTERY** on the display, the installed batteries may be dead.

If you remove the old batteries and install fresh ones within one minute, you should not lose your thermostat programming. After installing new batteries, follow the procedures in **CHECK YOUR PROGRAMMING** to determine whether your programming was maintained. If the thermostat maintains

programming, press  until **OFF** is displayed, put the thermostat back on the

wall, press  to select the operating

mode you want, then press  to start program operation. If the program is lost, reprogram the thermostat. See **PROGRAMMING YOUR THERMOSTAT**.

NOTES

If you need further information on programming or operation, write to:

White-Rodgers Division, Emerson Electric Co.
9797 Reavis Road
St. Louis, MO 63123-5398
Attn: Technical Service Department



Part No. 37-5101B

Replaces 37-5101A

9522

Free Manuals Download Website

<http://myh66.com>

<http://usermanuals.us>

<http://www.somanuals.com>

<http://www.4manuals.cc>

<http://www.manual-lib.com>

<http://www.404manual.com>

<http://www.luxmanual.com>

<http://aubethermostatmanual.com>

Golf course search by state

<http://golfingnear.com>

Email search by domain

<http://emailbydomain.com>

Auto manuals search

<http://auto.somanuals.com>

TV manuals search

<http://tv.somanuals.com>