

OPERATION GUIDE

1F94W-71

7 Day Multi-stage/Heat Pump
Electronic Digital Thermostat



WHITE-RODGERS

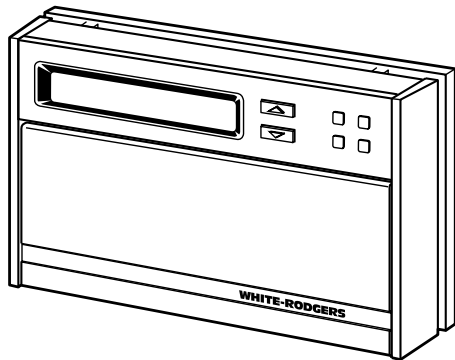

Operator: Save this booklet for future use!

About Your New Thermostat . . .

Your new Digital COMFORT SET II Multi-stage/Heat Pump Thermostat uses the technology of a solid-state microcomputer to provide precise time/temperature control. The COMFORT SET II Thermostat offers you the flexibility to design heating and cooling programs that fit your needs.

Please read this manual thoroughly before operating or programming your thermostat. If you have questions, you may write to our Technical Service Department at the address shown on the back cover of this booklet.

In This Guide . . .

YOUR NEW THERMOSTAT'S

FEATURES 4

OPERATING YOUR THERMOSTAT 5

PARTS OF THE THERMOSTAT

The Back Of the Thermostat Body

The Display

The Thermostat Buttons

OPERATING FEATURES

PROGRAMMING YOUR

THERMOSTAT 18

PLANNING FOR YOUR NEEDS

ENTERING YOUR PROGRAM

Set Current Time and Day

Program Heating and Cooling
Temperatures

Program Heating/Cooling Times
and Heating Temperatures

Program Cooling Temperatures
Using the HOLD/COPY Button

CHECK YOUR PROGRAMMING

QUESTIONS AND ANSWERS 33

**Operator: Save this
booklet for future use!**

YOUR NEW THERMOSTAT'S FEATURES

- Computed Energy Management Recovery (EMR)
- Automatic changeover (operator-selectable)
- Separate setback programming for 7 independent days
- Simultaneous heat and cool program storage
- Four separate time/temperature settings per 24-hour period
- Armchair programming capability
- Up to 3 stages of heat and up to 2 stages of cool
- Backlit LCD displays continuous set point, time, and room temperature
- 9 volt Energizer® alkaline battery backup
- Preprogrammed temperature control
- Adjustable cycle times
- Compressor short cycle protection
- Compressor long term cycle protection
- Blower delay in the cooling cycle
- Audio and visual prompting during operation
- Two hour temperature override
- Manual program override (HOLD temperature)
- °F/°C convertibility
- Keypad lockout (operator-selectable)
- Temperature range 40° to 99°F
- Compatible with Remote Sensor (installer-selectable)

OPERATING YOUR THERMOSTAT

Before you begin programming your thermostat, you should be familiar with its features and with the display and the location and operation of the thermostat buttons. The information in this section will help you become familiar with your new thermostat so that you can easily program it.

Your thermostat consists of two parts: the **thermostat body** and the **subbase**.

CAUTION

Use  to turn thermostat **OFF** before removing or attaching the thermostat body. Equipment damage and/or personal injury could occur.

The subbase is attached to the wall, but you can remove the thermostat body for easy programming. To remove the thermostat body from the subbase, grasp the thermostat body and gently pull it out from the bottom of the subbase and pivot up. To attach the thermostat body, line up the four terminal pins on the upper section of the thermostat back with the matching connector on the subbase. Insert these, then gently pivot the thermostat body down to connect the eight pin connectors on the lower portion of the thermostat back. Gently push until the snap connectors engage. **DO NOT FORCE OR PRY THE THERMOSTAT** as this may damage the unit.

PARTS OF THE THERMOSTAT

The Back of The Thermostat Body

Turn the thermostat body over. On the back are the 9 volt Energizer® alkaline battery and the option switches.

1. The 9 volt Energizer® alkaline battery provides power to the thermostat when the 24 VAC power is interrupted (for example, when you remove the thermostat from the wall for programming). A fresh battery will maintain the stored program for approximately a week. If power loss is long enough for the program to be lost, the thermostat will automatically return to the factory programmed temperatures (64°F heating and 82°F cooling) when power is restored. You must reprogram the thermostat if this happens.

If the word **BATTERY** is flashing in the display window, the battery is low and should be replaced with a fresh 9 volt Energizer® alkaline battery. The battery will provide power for all functions except the display light, which works only on 24 VAC power.

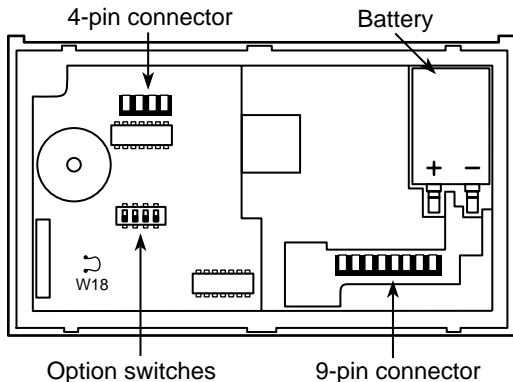



BACK OF THERMOSTAT BODY

 **CAUTION**

Use  to turn thermostat **OFF** before removing thermostat from the wall to replace the battery.

2. You may adjust the option switches for keypad lockout and automatic changeover from heat to cool (see **OPERATING FEATURES**).

Other than  and , the buttons are located behind the thermostat door. To open the door, use your fingernail in the indentation at the top center of the door. Pull the door out, then swing the door down on its hinges.



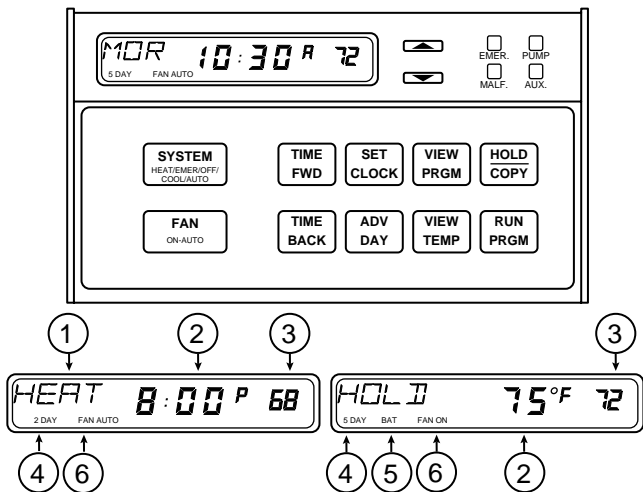

Following are brief descriptions of the display and the thermostat buttons.

The Display

- ① Continuously displays system mode (**HEAT**, **EMER**, **OFF**, **COOL**, **AUTO**, **HOLD**). During programming, the day of the week is displayed (**MO**, **TU**, **WE**, etc.).
- ② Alternately displays room temperature (**F** denotes degrees Fahrenheit and **C** denotes degrees Celsius) and time of day (**A** denotes AM time and **P** denotes PM time).
- ③ Displays the setpoint temperature.
- ④ When  is pressed, **A** is displayed when the setpoint temperature displayed (at the far right) is the 1st programmed heating or cooling temperature (depending on mode). **B** is displayed when the 2nd programmed heating or cooling temperature is being displayed.
- ⑤ **FAN ON** is displayed when the blower is operating continuously. **FAN AUTO** is displayed during automatic fan operation (when the blower cycles with the heating or cooling system).
- ⑥ The word **BATTERY** flashes on the display when the 9 volt alkaline battery power is weak and should be replaced.



The Thermostat Buttons

- ⑦ Sets the system mode (**HEAT**ing, **OFF**, **COOL**ing, or **AUTO**matic changeover).
- ⑧ Selects fan operation (see #5, above).
- ⑨ Runs display forward or backward through time, day, or anticipation settings during programming.
- ⑩ Used with  and  to set current time and day of the week.
- ⑪ Used during programming to set the day of the week to be programmed.
- ⑫ Used to initiate or review programming (program viewing automatically begins with Monday's program; use  button to view programming for following days).
- ⑬ Used with  and  to select setpoint temperatures.
- ⑭ Used to manually override programming to hold at a selected temperature (when **HOLD** is displayed). Also used to copy one day's programming to another day (when **COPY** is displayed).
- ⑮ Used to start program operation after programming. Also used to return thermostat to program operation after being in **HOLD** mode.
- ⑯ (Red arrow) Raises temperature setting (99°F or 37°C maximum).
- ⑰ (Blue arrow) Lowers temperature setting (40°F or 4°C minimum).

⑱ **EMER** light indicates that the system is in the emergency mode (the heat pump compressor is off and the auxiliary heat system is maintaining the setpoint temperature — there is a 5- to 10-minute startup delay on the first emergency cycle). **MALF** light indicates a heat pump system malfunction (re-

fer to heat pump manufacturer's operating manual). A continuous (non-flashing) **PUMP** light indicates that the heat pump compressor is functioning — a flashing **PUMP** light indicates that the compressor is locked out. **AUX** light indicates that the auxiliary system is operating.

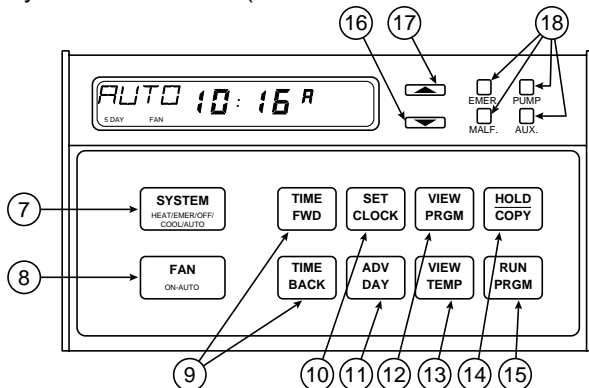



OPERATING FEATURES

Now that you are familiar with the thermostat display and buttons, read the following information to learn about the many features of the thermostat.

- **COMPUTED ENERGY MANAGEMENT RECOVERY (EMR)** — The thermostat's microcomputer automatically calculates the time it will take to change the temperature to the next program setting. Then the thermostat will activate the heating or cooling system to change the temperature so that the desired temperature is reached at the beginning of the next program period. As an example of this feature, assume that you have programmed your thermostat to provide an overnight heating temperature of 62°F, and that during the next program

period, beginning at 6:00 AM, you have programmed a temperature of 70°F. The thermostat will automatically activate the heating system at about 5:00 AM, so that the programmed 70°F temperature is reached by about 6:00 AM.

- **AUTOMATIC CHANGEOVER** — You can set the thermostat to automatically switch the system from heating to cooling as needed. First you must move option switch #4 (located on the back of the thermostat body) to the **ON** position, if it has not already been done. To do this, press  to turn thermostat OFF. Then remove the thermostat body from the wall. Check the position of switch #4 (the last switch on the right). If it is **ON** (up), simply put the thermostat back on the wall. If the switch is **OFF** (down), remove the battery, then use a pencil or

small screwdriver to move the switch to the **ON** position (see figure at right). Leave the battery out of the thermostat for at least **two minutes**, to allow the thermostat to reset itself. **DO NOT MOVE OPTION SWITCHES #1 OR #2**, as this may affect thermostat operation. [Option switch #3 enables/disables keypad lockout (see **TOTAL KEYPAD LOCKOUT**)]. Replace the battery, re-program the thermostat, if necessary, put the thermostat back on the wall, and restore 24 VAC power. To set the thermostat for automatic changeover after programming, press  to set the thermostat to **AUTO** (the setpoint temperature display is **blank** in the **AUTO** mode). The system will now automatically switch between heating and cooling, depending on the actual room temperature.

Download from Www.Somanuals.com. All Manuals Search And Download.



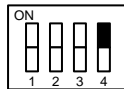



Automatic Changeover

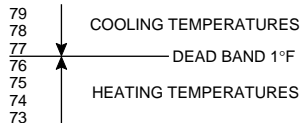



Switch #1 set at installation (**DO NOT CHANGE**)
Switch #2 set at installation (**DO NOT CHANGE**)
Switch #3 (see **TOTAL KEYPAD LOCKOUT**)
Switch #4 **ON**

In the **AUTO** mode, the thermostat will not allow the temperature separation between the highest heat setting and the lowest cool setting to be less than 1°F. For example, if the highest heat setting is 76°F, the lowest cool setting cannot be below 77°F (see diagram below).







- **TWO HOUR TEMPERATURE OVERRIDE** — Press  or  until the display shows the temperature you want. The thermostat will override current programming and keep the room temperature at the selected temperature for two hours. After two hours, the thermostat will automatically revert to the program.
- **HOLD TEMPERATURE** — The thermostat can hold any temperature within its range for an indefinite period, without reverting to the program. Press . **HOLD** will be displayed. Then choose the desired hold temperature by pressing  or . The thermostat will hold the room temperature at the selected setting until you press  to start program operation again. This feature is ideal for energy conservation when









the building is unoccupied for an extended period of time.

- **°F/°C CONVERTIBILITY** — Press  and  at the same time until the temperature display is in °C (Celsius). To display °F, repeat the process.
- **ADJUSTABLE HEATING AND COOLING CYCLE TIMES (ANTICIPATION)** — If the heating/cooling system is turning on and off too often (short cycles) or not often enough (long cycles), you may want to adjust the anticipation setting.

CAUTION

A cooling anticipation setting of less than 10 may cause decreased compressor life.



To adjust **heat** anticipation, press  and  at the same time. The display will show **HEAT 18** (this is the factory preprogrammed heating anticipation setting). You may select any anticipation setting from 4 to 40 (**note that for add-on heat pump systems, a minimum anticipation setting of 10 is recommended**). Whenever adjusting anticipation, increase or decrease the displayed number by only one or two digits, then let the system run for a while to see if the adjustment is sufficient. If the heat cycles are too short, press  to increase the cycle time. If the heat cycles are too long, press  to decrease the cycle time. To set **cooling** anticipation, press  and

 at the same time again. The display will show **COOL 14** (factory preprogrammed cooling anticipation). Use the  and  buttons to adjust anticipation. To set **auxiliary heat** anticipation, press  and  at the same time again. The display will show **AUX 8** (factory preprogrammed cooling anticipation). Use the  and  buttons to adjust anticipation. Press  to return to your program.

- **LOW BATTERY INDICATOR** — The word **BATTERY** will flash on the display if the 9 volt alkaline battery is low and should be replaced.

- **AUDIO PROMPTING** — Each time you press a button, the thermostat will beep (this feature works only when the thermostat is attached to the wall and 24 VAC power is present to the thermostat).
- **BACKLIT DISPLAY** — When you press any button on the thermostat, the display is lit for approximately eight seconds (this feature works only when the thermostat is attached to the wall and 24 VAC power is present to the thermostat).
- **SYSTEM INDICATOR LIGHTS** — The four lights on the upper right part of the thermostat indicate system operation (see **PARTS OF THE THERMOSTAT**).
- **COMPRESSOR SHORT CYCLE PROTECTION** — To protect your compressor from potential damage due to rapid cycling, this thermostat has a built-in delay of 5 minutes

between heat pump heating and cooling cycles. The following may cause a time delay in **COOL**:

- a) Return of power after a power outage.
- b) Pressing  to change operating modes.
- c) Pressing  or , creating a call for **HEAT** or **COOL** too soon after a previous call.

- **COMPRESSOR LONG TERM CYCLE PROTECTION** — If your system begins to operate too soon after an extended power outage, the compressor may be damaged due to crankcase oil temperature change. This thermostat has a built-in time delay of one hour less than the length of the power loss (up to 12 hours). When power is restored to the system, heaters in the system

will begin to heat the crankcase oils. The thermostat's time delay will lock out the compressor to prevent its operation until the compressor oil is sufficiently warmed. During the lockout time period, the auxiliary heating system will operate to maintain a setpoint temperature.

For example, if a power outage of three hours occurs, the compressor will be locked out for two hours.

- **TOTAL KEYPAD LOCKOUT** — When option switch #3 is in the total keypad lockout position (**ON**), programs cannot be altered and all buttons are disabled.

NOTE

Programming should be completed and battery should be installed **before** changing option switch #3.

Total Keypad Lockout

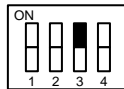

Switch #1 set at installation (**DO NOT CHANGE**)

Switch #2 set at installation (**DO NOT CHANGE**)

Switch #3 **ON**

Switch #4 (see **AUTOMATIC CHANGEOVER**)

Switches #1 and #2 are set at installation and should not be changed. To enable total keypad lockout, move option switch #3 to **ON** (see figure above). **DO NOT MOVE OPTION SWITCHES #1 OR #2**, as this may affect thermostat operation [option switch #4 enables/disables automatic changeover (see **AUTOMATIC CHANGEOVER**)]. To disable total keypad lockout, move option switch #3 to **OFF**.

PROGRAMMING YOUR THERMOSTAT

Now you are ready to program your thermostat. This section will help you plan your thermostat's program to meet your needs.

For maximum comfort and efficiency, keep the following guidelines in mind when planning your program.

- When heating (cooling) your building, program the temperatures to be cooler (warmer) when the building is vacant or during periods of low activity.
- During early morning hours, the need for cooling is usually minimal.

PLANNING FOR YOUR NEEDS

First, answer the following questions to help you decide what your needs are. If you are using the

thermostat for a commercial application (a store, office building, etc.), answer questions 1 through 4. If you are using the thermostat in your home, answer questions 5 through 8.

FOR COMMERCIAL APPLICATIONS:

- 1a. What time does the first person arrive at the building in the morning?
 - b. What temperature should the building be at this time? (heating? cooling?)
- 2a. What time do the building occupants reach a maximum activity level (using lights, equipment, meeting rooms, etc.)?
 - b. What temperature should the building be at this time?

- 3a. What time do the building occupants reach a minimum activity level (limited personnel in building)?
- b. What temperature should the building be at this time?
- 4a. What time does the building become vacant?
- b. What temperature should the building be at this time?

IN YOUR HOME:

- 5a. What time does the first person get up in the morning?
- b. What temperature should the house be at this time?
- 6a. What time does the last person leave the house in the morning?
- b. What temperature should the house be at this time?

- 7a. What time does the first person arrive home in the evening?
- b. What temperature should the house be at this time?
- 8a. What time does the last person go to bed at night?
- b. What temperature should the house be at this time?

Now look at the factory preprogrammed times and temperatures shown on the following page. If this program will suit your needs, simply press  to begin running the factory preset program.

FACTORY PREPROGRAMMING

Heating Program for ALL days of the Week:

PERIOD	TIME	TEMP
1	5:00 AM	70°F
2	9:00 AM	70°F
3	4:00 PM	70°F
4	10:00 PM	64°F

Cooling Program for ALL Days of the Week:

PERIOD	TIME	TEMP
1	5:00 AM	78°F
2	9:00 AM	82°F
3	4:00 PM	78°F
4	10:00 PM	78°F

If you want to change the preprogrammed times and temperatures, follow these steps.

1. Determine the heating and cooling temperatures you want to use. You may select up to four heating temperatures (**HEAT A**, **HEAT B**, **HEAT C**, and **HEAT D**), and up to four cooling temperatures (**COOL A**, **COOL B**, **COOL C**, **COOL D**). Use the table at the right to write down the temperatures you have selected.

Temperature Designation	Your Selected Temperature	Factory Preprogrammed Temperature
HEAT A	_____	70°F
HEAT B	_____	64°F
HEAT C	_____	---
HEAT D	_____	---
COOL A	_____	78°F
COOL B	_____	82°F
COOL C	_____	---
COOL D	_____	---

NOTE

To operate properly in the **AUTO** mode, there must be a **minimum 1°F separation** between the highest heat temperature and the lowest cool temperature (see diagram below).

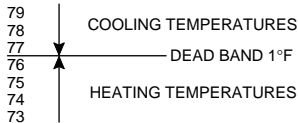

2. Determine the time periods during which you will program the temperatures you have just selected. You must program 4 periods for each day (periods 1, 2, 3 & 4). However, you may use the same heating and cooling temperatures for consecutive time periods. Also keep in mind that, for any given day,

you can only program one set of times for both heating and cooling (for example, if you select 5:00 AM to begin heating period 1 on Monday, then your cooling period 1 for Monday will also begin at 5:00 AM). However, you may choose different time periods for each day separately (for example, heating/cooling period 1 on Monday may begin at 5:00 AM, but heating/cooling period 1 on Saturday may begin at 9:00 AM). Use the following table to plan your program time periods, and the temperatures you want during each period. You may also want to look at the sample program table to get an idea of how the thermostat can be programmed.

Heating/Cooling Schedule Plan

THIS THERMOSTAT ALLOWS ONE SET OF TIMES FOR BOTH HEATING AND COOLING

	Period 1			Period 2			Period 3			Period 4		
	Time	Heat Temp.	Cool Temp.	Time	Heat Temp.	Cool Temp.	Time	Heat Temp.	Cool Temp.	Time	Heat Temp.	Cool Temp.
Monday												
Tuesday												
Wednesday												
Thursday												
Friday												
Saturday												
Sunday												

Joe's Restaurant

Closed Mon.

Open Tues.-Sat. 10:30 AM-10:00 PM

Open Sun. 6:30 AM-2:00 PM

SAMPLE Heating/Cooling Schedule Plan

HEAT A = 65°F COOL A = 80°F

HEAT B = 68°F COOL B = 78°F

HEAT C = 70°F COOL C = 76°F

HEAT D = 72°F COOL D = 74°F

THIS THERMOSTAT ALLOWS ONE SET OF TIMES FOR BOTH HEATING AND COOLING

	Period 1			Period 2			Period 3			Period 4		
	Time	Heat Temp.	Cool Temp.	Time	Heat Temp.	Cool Temp.	Time	Heat Temp.	Cool Temp.	Time	Heat Temp.	Cool Temp.
Monday	5:00 AM	65° (A)	80° (A)	9:00 AM	65° (A)	80° (A)	3:30 PM	65° (A)	80° (A)	11:30 PM	65° (A)	80° (A)
Tuesday	5:00 AM	65° (A)	80° (A)	9:00 AM	70° (C)	76° (C)	3:30 PM	72° (D)	74° (D)	11:30 PM	65° (A)	80° (A)
Wednesday	5:00 AM	65° (A)	80° (A)	9:00 AM	70° (C)	76° (C)	3:30 PM	72° (D)	74° (D)	11:30 PM	65° (A)	80° (A)
Thursday	5:00 AM	65° (A)	80° (A)	9:00 AM	70° (C)	76° (C)	3:30 PM	72° (D)	74° (D)	11:30 PM	65° (A)	80° (A)
Friday	5:00 AM	65° (A)	80° (A)	9:00 AM	70° (C)	76° (C)	3:30 PM	72° (D)	74° (D)	11:30 PM	65° (A)	80° (A)
Saturday	5:00 AM	65° (A)	80° (A)	9:00 AM	70° (C)	76° (C)	3:30 PM	72° (D)	74° (D)	11:30 PM	65° (A)	80° (A)
Sunday	5:00 AM	70° (C)	78° (B)	9:00 AM	70° (C)	76° (C)	3:30 PM	68° (B)	76° (C)	11:30 PM	65° (A)	80° (A)

ENTERING YOUR PROGRAM

Follow these steps to enter the heating/cooling program you have selected.

NOTE



We recommend that you remove the thermostat from the wall for programming (especially for entering cooling programming). A fresh 9 volt Energizer® alkaline battery must be installed to perform off-wall programming. **BE SURE SYSTEM SWITCH IS SET TO OFF POSITION BEFORE REATTACHING THERMOSTAT TO SUBBASE!**

You cannot program the thermostat with the **SYSTEM SWITCH** in the **AUTO** position.

Set Current Time and Day

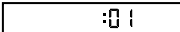

1. Press  once. The display will show minutes only.





EXAMPLE: 

2. Press and hold either  or  until you reach the correct minutes.

3. Press  once. The display window will show the hour only.

EXAMPLE: 





4. Press and hold either  or  until you reach the correct hour and AM/PM designation (**AM** begins at midnight; **PM** begins at noon).









5. Press  once. The display will show the day of the week as an abbreviation (**MO** for Monday, **TU** for Tuesday, etc.).
6. Press and hold either  or  until you reach the current day of the week.
7. Press  once. The display will show the correct time and room temperature alternately.





Program Heating/Cooling Temperatures

During programming, if you don't press any buttons for 5 minutes, the thermostat will enter the **HOLD** mode and will maintain a constant temperature. The display will revert to the alternating time/temperature display. To resume programming after this happens, press  until



you are at the point where you stopped programming. Then you may continue to enter your program normally. If you want to stop programming at any time, simply press  to resume program operation.

1. Press  until **HEAT** is displayed.
2. Press  once. The display will continue to show **HEAT**. Below **HEAT** is the letter **A**, representing the first programmed heating temperature (**HEAT A**). At the right of the display is the currently programmed **HEAT A** setting.
3. Press either  or  to change the temperature to your selected **HEAT A** setting.

4. Press  once. The letter **A** will change to the letter **B**, representing **HEAT B**.
5. Press either  or  to change the temperature to your selected **HEAT B** setting.
6. Repeat steps 4 and 5 to select **HEAT C** and **HEAT D** temperature settings.
7. Press  .
8. Press  until **COOL** is displayed.
9. Press  once. The display will show **COOL** and **A**, representing the first programmed cooling temperature (**COOL A**).
10. Press either  or  to change the temperature to your selected **COOL A** setting.





11. Press  once. Press  or  to set your selected **COOL B** setting.
12. Repeat step 11 to select **COOL C** and **COOL D** temperature settings.
13. Press  .



Program Heating/Cooling Times and Heating Temperatures

1. Press  until **HEAT** is displayed.
2. Press  once. **MO**, the abbreviation for Monday, and the number **1**, representing the **first** heating/cooling period, will appear in the display. Also displayed are the currently programmed start time for heating/cooling period 1 and the currently programmed **HEAT A, B, C, or D** temperature for heating/cooling period 1.

EXAMPLE: 

This display window shows that for Monday's heating/cooling period 1, the start time is 5:00 AM, and 70° is the programmed temperature (this example reflects factory pre-programming, where 70° is the **HEAT A** temperature).

3. To change the displayed start time to your selected start time for Monday's period 1, press  or  until your selected time appears. The time will change in 15 minute increments. **The time you select will be the start time of Monday's period 1 for both heating and cooling.**
4. If the temperature displayed is not the **HEAT A, B, C, or D** temperature you want for Monday's period 1, press  or  (if



you continue to press  or , the display will alternately display the **HEAT A, B, C, or D** temperatures you previously selected).

5. After selecting the desired heating temperature for heating/cooling Monday's period 1, press . The currently programmed start time and heating temperature for Monday's heating/cooling period 2 will be displayed.
6. Repeat steps 3 and 4 to select the start time and heating temperature for Monday's heating/cooling period 2.
7. Repeat steps 3 through 6 for Monday's heating/cooling periods 3 and 4.

NOTE

The thermostat has a built-in **COPY** feature. **This feature automatically copies the heating and cooling programs you select for Monday into Tuesday through Sunday's programs.** If you want to have the same programming every day, after you program Monday's schedule, you simply press  to start the thermostat's programmed operation. Every day will then use the same program you set for Monday.







You may also choose to use the  button to copy any day's heating and cooling program into any other day's program (see **USING THE HOLD/COPY BUTTON**).



8. To enter Tuesday's through Sunday's heating programs, use the  button (see **USING THE HOLD/COPY BUTTON**), or press  until the correct day's abbreviation appears in the display. Repeat the above steps to program each day's heating/cooling periods and heating temperatures.
9. When you have completed programming your heating/cooling periods and heating temperatures, press .

Program Cooling Temperatures

CAUTION

If outside temperature is below 50°F, we recommend that you remove the thermostat from the wall before proceeding with the following steps to program cooling temperatures. Personal injury or property damage may occur due to air conditioner compressor slugging. A fresh 9 volt Energizer® alkaline battery must be installed to perform off-wall programming. Programming away from the wall should prevent accidental compressor operation. USE  TO TURN THERMOSTAT OFF BEFORE REATTACHING THE THERMOSTAT TO THE SUBBASE!

1. To program cooling temperatures for the heating/cooling periods you have already set, press  until **COOL** is displayed.
2. Press  once. The Monday heating/cooling period 1 start time you just programmed will appear, and the currently programmed cooling temperature (**A**, **B**, **C**, or **D**) will be displayed.
3. Press  or  to display the **COOL A**, **B**, **C**, or **D** temperature you want for Monday's heating/cooling period 1.
4. Press , then press  or  to select Monday's **COOL A**, **B**, **C**, or **D** temperature for period 2.
5. Repeat steps 3 and 4 for Monday's heating/cooling periods 3 and 4.



6. Use the  button, or press  to choose other days to program. Remember, once you enter Monday's program, Monday's program is automatically copied into Tuesday's through Sunday's programs.
7. After you enter or copy heating and cooling programs for all 7 days, press  to begin program operation.

Using The HOLD/COPY Button

You can copy the entire heating/cooling program into any or all other days' programs. However, you must perform each copy function separately. Each time you begin a **COPY** operation, you must start with the day's program you wish to copy **FROM**. A **COPY** operation is not complete until  has been pressed **TWICE**.



NOTE

For most efficient programming, you should enter both the heating and cooling programs for the day you wish to copy **FROM** before using the **COPY** function, since the **COPY** function copies the entire day's programming to other days.

1. Press  .
2. Press  until the day you want to copy **FROM** is displayed. If you have not completed programming for this day, do so before proceeding.
3. Press  once. **COPY** will appear on the display. A number from **1** to **7** will also appear, representing the day you have selected to copy (Monday is **1**, Tuesday is **2**, Wednesday is **3**, etc.). For example, if in





step 2 you selected to copy Wednesday's program, when you press , COPY 3 will appear in the display (as shown below).

EXAMPLE: 



4. Press  to select the day you want to copy the program **TO**.
5. Press . **COPY** will disappear from the display, and the display will show the copied heating/cooling time and temperature for the day you copied **TO**.
6. Repeat the above steps to copy any day's programming into any other day's program.
7. Press  to begin program operation.

CHECK YOUR PROGRAMMING



Follow these steps to check your thermostat programming one final time before beginning thermostat operation.

1. Press  until **HEAT** is displayed.
2. Press and hold  to view the heating/cooling period times and heating temperatures for Monday.
3. Press  once to advance to Tuesday.
4. Press and hold  to view heating/cooling periods and heating temperatures for Tuesday.
5. Repeat steps 3 and 4 to review all remaining days' programming. If you find an error in any day's programming, go back

to the programming instructions to correct the error.

6. Press  .
7. Press  until **COOL** is displayed.
8. Repeat steps 2 through 5 to check cooling temperatures.
9. Press  to begin program operation.

YOUR THERMOSTAT IS NOW COMPLETELY PROGRAMMED AND READY TO AUTOMATICALLY PROVIDE MAXIMUM COMFORT AND EFFICIENCY!





Press  until **OFF** is displayed. Reattach thermostat to subbase. Then press  to select the operation mode you want (**HEAT, COOL, AUTO**).

NOTE

When you have completed programming, you may set option switch #3 (see **TOTAL KEYPAD LOCKOUT** in the **OPERATING FEATURES** section).

QUESTIONS AND ANSWERS

1. How can I permanently change a part of my program?

Press  until you reach the time/temperature schedule you want. Then press  or  and  and  to change the program (remember, when you change the time, you are changing it for both the heating and cooling programs). See **PROGRAMMING YOUR THERMOSTAT**.

2. How can I have no change in temperature from one time period to another?

Simply select the same temperature for each consecutive time period. For example, you may select the same **COOL A** temperature for period 2 as you did for period 1,

which means the temperature will not change from **COOL A** when period 2 begins. See **PROGRAMMING YOUR THERMOSTAT**.

3. How can I finish my programming if the display has already changed to time/temperature?

During programming, if no buttons are pressed for five minutes, the thermostat will enter the **HOLD** mode and maintain a constant temperature. The display will change to the time/temperature mode. To resume programming, press  until you return to the point where you stopped programming. Then you may continue to program the thermostat normally. If you want to stop

programming at this point, press  to start the normal program function. See **PROGRAMMING YOUR THERMOSTAT**.

4. What happens if the electricity goes off or is manually shut off?

If you have not installed a 9 volt alkaline battery, the display will go blank and the program will be lost in five seconds. When electricity is restored, the thermostat will maintain a heating temperature of 64°F and a cooling temperature of 82°F until you reenter your program. Setpoint temperature will not be displayed.

If a fresh 9 volt Energizer® alkaline battery is installed, the program will be maintained for about one week with no 24 VAC power present to the thermostat. See **OPERATING YOUR THERMOSTAT**.



5. Why can't I program the thermostat in the AUTO mode?

The thermostat can only be programmed in the **HEAT** and **COOL** modes. See **PROGRAMMING YOUR THERMOSTAT**.

6. What can cause the thermostat display to freeze or go blank?

A completely blank display may indicate that power has been lost to the thermostat and the backup battery is also dead. However, if there is power to the thermostat and the display is blank or frozen, static discharge is probably the cause.

During periods of low humidity (especially during cold weather), you may feel or see a spark discharge when you touch the thermostat. This may cause the program to be lost or the thermostat to display incorrectly.

To correct this, remove the thermostat from the wall and remove the battery for at least two minutes. After reinstalling the battery, the thermostat will revert to the factory preset program until you reprogram the thermostat. If you don't want to reprogram the thermostat immediately, press  until **OFF** is displayed and replace the thermostat on the wall. Then press  to begin the factory preset program.

To prevent further static discharge problems, touch another object to release static build-up before touching the thermostat. See **OPERATING YOUR THERMOSTAT**.

7. Why won't the setpoint temperature go to the temperature I want?

In the **AUTO** mode, the highest heating setpoint temperature you select must be at least 1°F lower than the lowest cooling setpoint temperature you select (for example, if 70°F is your lowest selected cooling temperature, you cannot select a heating temperature any higher than 68°F). If such a conflict exists, set the lowest cooling temperature higher in order to set the heating temperature higher. To set a lower cooling temperature, you must select a lower heating temperature. See **PROGRAMMING YOUR THERMOSTAT**.



8. Why doesn't the display light come on when I press a button? Why don't I hear a beep when I press a button?

The display light and audio prompting (beep) only work when the thermostat is on the wall and 24 VAC power is present to the thermostat. See **OPERATING YOUR THERMOSTAT**.

9. The display is flashing BATTERY. What does this mean?

The 9 volt battery installed in the thermostat is low and should be replaced with a fresh 9 volt Energizer® alkaline battery. See **OPERATING YOUR THERMOSTAT**.

10. Why won't the system turn on, even though the thermostat display is functioning normally?

Either the compressor lockout feature is in operation or the thermostat is not currently calling for heat or cool. Wait about 5 minutes for the compressor lockout to expire. If the system is still not running, read the cautionary statement at the right. Then, **if conditions permit**, use the  or  buttons to move the temperature above or below the setpoint temperature. See **OPERATING YOUR THERMOSTAT**.

! CAUTION

If the outside temperature is below 50°F, **DO NOT** use the  button to move the temperature below the setpoint temperature. Property damage may result due to compressor slugging.

11. Why doesn't the temperature change at the time I programmed?

There are a number of causes for this situation. The following are primary reasons.

- The **EMR** function is operating. The **EMR** function will automatically turn on the system early enough to bring the temperature to the selected level by the beginning of the next program period. See **OPERATING YOUR THERMOSTAT**.

- You have programmed the incorrect day or time. Check your programming (be sure that the times you programmed are correct AM or PM times). See **PROGRAMMING YOUR THERMOSTAT**.
- The thermostat is in the **HOLD** mode. Press  to start program operation. See **OPERATING YOUR THERMOSTAT**.
- The compressor lockout feature is operating; wait about 5 minutes for system to begin running. See **OPERATING YOUR THERMOSTAT**.

12. Why does the blower fan keep running after the system has turned off?

The blower delay feature is operating. This energy saving feature continues to blow conditioned air through the ducts after the system has turned off, rather than letting the air dissipate.

13. Why is the system turning on and off so frequently (seldom)?

The anticipation setting is too low (high). To change anticipation settings, see **OPERATING YOUR THERMOSTAT**.

14. Between heating and cooling seasons, I want to turn my system off. Can I do this without affecting my thermostat programming?

Any time you wish to turn your system off, press  until the display shows **OFF**.

This will not affect your thermostat's programming in any way. To turn the system back on, press  until **HEAT, COOL,** etc. is displayed. The system will automatically begin operating according to the current thermostat program, unless the thermostat is in the **HOLD** mode. See **OPERATING YOUR THERMOSTAT**.

15. I live in an area where daylight savings time is observed. How do I change the thermostat clock twice a year without affecting thermostat programming?

To change your clock, follow the instructions for setting current time and day. See **ENTERING YOUR PROGRAM**. Thermostat programming is not affected when you change the clock.

16. Do I have to reprogram my thermostat after I change the battery?

When the thermostat is on the wall and the system has power, the thermostat is being powered by a 24 VAC source. If power is lost, or if the thermostat is removed from the wall, the program will be retained for approximately **one minute** if there is no battery installed or if the installed battery is

dead. If you are changing the battery after seeing a flashing **BATTERY** on the display, the installed battery may be dead. If you remove the old battery and install a fresh one within one minute, you may not lose your thermostat programming. After installing a new battery, follow the procedures in **CHECK YOUR PROGRAMMING** to determine whether your programming was maintained. If the thermostat maintains program-

ming, press  until **OFF** is displayed, put the thermostat back on the wall, press

 to select the operating mode you

want, then press  to start program operation. If programming is lost, you must reprogram the thermostat. See **PROGRAMMING YOUR THERMOSTAT**.

If you need further information on programming or operation, you may write to our Technical Service Department at the address shown below.



WHITE-RODGERS DIVISION
EMERSON ELECTRIC CO.
9797 REAVIS ROAD
ST. LOUIS, MISSOURI 63123-5398

Part No. 37-5525A

9529

Free Manuals Download Website

<http://myh66.com>

<http://usermanuals.us>

<http://www.somanuals.com>

<http://www.4manuals.cc>

<http://www.manual-lib.com>

<http://www.404manual.com>

<http://www.luxmanual.com>

<http://aubethermostatmanual.com>

Golf course search by state

<http://golfingnear.com>

Email search by domain

<http://emailbydomain.com>

Auto manuals search

<http://auto.somanuals.com>

TV manuals search

<http://tv.somanuals.com>