

OPERATION GUIDE 1F70 Series (1F70-1F76)

Automatic Clock Thermostats

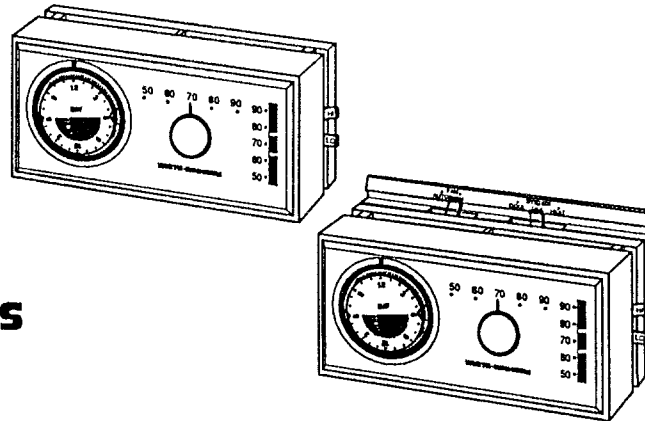

WHITE-RODGERS

Operator: Save this booklet for future use!

About Your New Thermostat . . .

Your new thermostat can save 10 to 16% on annual heating fuel bills, depending on the climate of the city where you live. With the fuel you save, the thermostat can pay for itself in less than one year in most locations. Setting temperatures lower also provides additional comfort. Most families enjoy sleeping in cooler temperatures in both summer and winter. Your thermostat will automatically maintain comfortable temperatures for you.

NOTE

This operation guide is a universal manual for all variations of the entire line of mechanical clock thermostats. Your thermostat may not have every feature and may vary slightly.

Please read this manual thoroughly before installing, operating or programming your thermostat. If you have questions, please write to us at the address shown on the back cover of this guide.

In This Guide . . .

PARTS OF THE THERMOSTAT	4	SET THERMOSTAT SWITCHES AND
OPERATING THE THERMOSTAT	6	TEMPERATURE LEVERS
SELECT SETBACK-SETUP TIMES		Setting the Fan and System Switches
SET AND START THE TIMER		Setting the Temperature Levers
		Setting the Program Advance Switch
		REPLACING THE BATTERY

**Operator: Save this
booklet for future use!**

PARTS OF THE THERMOSTAT

Refer to fig. 1 for location of the following parts of the thermostat (fig. 1 shows heating/cooling thermostat model with cover removed).

1. Timer dial (rotates counterclockwise to remove/replace timer selectors or to set current time).
2. **BLUE** timer selectors are used to select the **setback** times (the times when the thermostat will begin to maintain the lower temperature, indicated by the blue (**LO**) temperature lever).
3. **RED** timer selectors are used to select the **setup** times (the times when the thermostat will begin to maintain the higher temperature, indicated by the red (**HI**) temperature lever).
4. Time reference marker indicates current time.
5. Fan selector switch (heating/cooling model only). In **AUTO** position, fan cycles with heating or cooling system. In **ON** position, fan runs continuously, regardless of system operation.
6. System selector switch (heating/cooling model only). In **COOL** position, cooling system operates. In **OFF** position, neither heating nor cooling system operates (but fan may still run if fan switch is in the **ON** position). In **HEAT** position, heating system operates.
7. Red (**HI**) temperature lever indicates the **high** temperature to be maintained.

4

8. Blue (LO) temperature lever indicates the **low** temperature to be maintained.
9. Battery (size varies by model; some models may not have a battery).
10. Anticipator (not adjustable on all models).

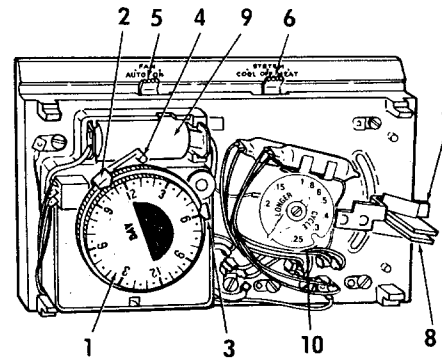

Figure 1. Thermostat with cover removed.

OPERATING THE THERMOSTAT

SELECT SETBACK-SETUP TIMES

The timer has been preset to lower (set back) the temperature at 11:00 PM (with the **BLUE** timer selector) and raise (set up) the temperature at 6:00 AM (with the **RED** timer selector). Additional sets of selectors are stored inside the thermostat cover on some models. Use them if you want more than one setback-setup time period (you must use the selectors in pairs, one red and one blue, for proper setback-setup operation).

Refer to Table 1 for suggestions on how to set timer selectors and temperature levers for proper setup/setback operation.

If you want to use only the preset setback-setup times, skip this section and go to **SET AND START THE TIMER**.

NOTE

Depending on local weather conditions and the temperature you select, it may take several hours to cool to a desired temperature.

During the air conditioning season, you may wish to maintain a higher temperature during the day and a lower temperature during the night. This may be even more desirable if no one is at home during the day. In this case, set the red timer selector to the AM time you want the house temperature to rise to the high setting. Set the

TABLE 1. Suggested Timer Selector/Temperature Lever Settings for Seasonal Operation

<p>1. Cooler at night and warmer during day (normal winter settings)</p>	<p>Set BLUE TIMER SELECTOR at time in evening when lower temperature is desired. Set BLUE (LO) TEMPERATURE LEVER at the lower temperature desired. Set RED TIMER SELECTOR at time in morning when higher temperature is desired. Set RED (HI) TEMPERATURE LEVER at the higher temperature desired.</p>
<p>2. Cooler during day and warmer at night (normal summer settings)</p>	<p>Set RED TIMER SELECTOR at time in evening when higher temperature is desired. Set RED (HI) TEMPERATURE LEVER at the higher temperature desired. Set BLUE TIMER SELECTOR at time in morning when lower temperature is desired. Set BLUE (LO) TEMPERATURE LEVER at the lower temperature desired.</p>
<p>3. Constant 24 hour temperature level</p>	<p>Set BLUE and RED TEMPERATURE LEVERS together at the temperature desired to maintain the same temperature constantly, regardless of timer selector settings.</p>

blue timer selector to the PM time you want the house temperature to return to the low setting

1. To remove the timer selectors, turn the dial counterclockwise until the selector to be removed is at the bottom of the dial (see fig. 2).
2. Hold the timer dial securely. Carefully snap the timer selectors off the dial.
3. Turn the dial counterclockwise until the desired setback or setup time is near the bottom of the dial.
4. Hold the timer dial and snap the timer selectors back on the dial at the desired times for lowering the temperature (BLUE selector) or raising the temperature (RED selector).

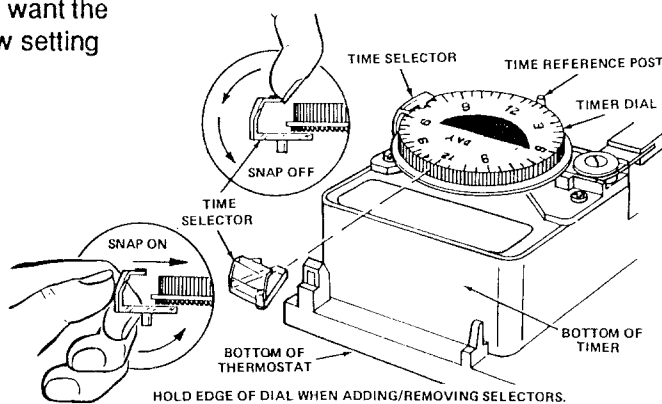

Figure 2. Removing/replacing timer selectors.

Be sure you have selected the proper AM or PM setting.

SET AND START THE TIMER

After the time selectors are in place, follow these steps to set and start the timer.

1. Turn the dial **at least one complete counterclockwise revolution past the correct time of day.**
2. Continue to turn the dial counterclockwise until correct time is **ONE HOUR** past the time reference marker (see fig. 3). If you turn the dial more than two hours past the correct time, start again at step 1.
3. Turn the dial clockwise to the correct time (be sure you have selected the proper AM or PM time setting).

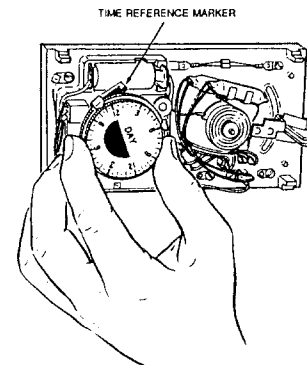

Figure 3. Setting timer clock.

On some models, the timer is powered by an alkaline or rechargeable Nicad battery. There is a battery included in the thermostat models that require one (see fig. 4). For shipping, a cardboard strip has been inserted between the contact and the battery. **TO START THE TIMER, YOU MUST FOLLOW THESE STEPS TO REMOVE THE CARDBOARD STRIP!**

1. Lift and grasp the tab on the cardboard strip.
2. Hold one finger on the battery to hold it in place.
3. Gently pull the tab straight out. If the timer does not start, remove the battery and reinsert it (see **REPLACING THE BATTERY**).
4. Replace the thermostat cover.

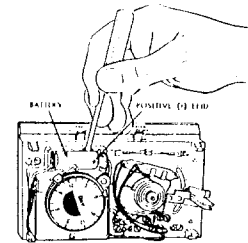

Figure 4. Battery location.

SET THERMOSTAT SWITCHES AND TEMPERATURE LEVERS

NOTE

Turn on electrical power to system, if you have not already done so.

Setting the Fan and System Switches

If you have a heating/cooling thermostat, Fig. 5 shows how the heating/cooling system and fan work when the switches are in various positions. Use the system switch to select either heating or cooling, or to turn the heating/cooling system off. Use the fan switch to control fan operation. When the fan switch is in the **AUTO** position, the fan will cycle with the heating or cooling system (the fan will not run if the system switch is in the **OFF** position and the fan switch is in the **AUTO** position). When the fan switch is in the **ON** position, the fan will run continuously, regardless of system switch position (even if the system switch is set to **OFF**, the fan will run if the fan switch is in the **ON** position).

■ Shows switch position						OPERATION
FAN		SYSTEM				
<input type="checkbox"/>	<input type="checkbox"/>	<input type="checkbox"/>	<input type="checkbox"/>	<input type="checkbox"/>	<input type="checkbox"/>	
AUTO	ON	COOL	OFF	HEAT		
<input checked="" type="checkbox"/>	<input type="checkbox"/>	<input type="checkbox"/>	<input checked="" type="checkbox"/>	<input type="checkbox"/>	<input type="checkbox"/>	No heating; no cooling; no fan
<input type="checkbox"/>	<input checked="" type="checkbox"/>	<input type="checkbox"/>	<input checked="" type="checkbox"/>	<input type="checkbox"/>	<input type="checkbox"/>	No heating; no cooling; fan runs continuously
<input type="checkbox"/>	<input checked="" type="checkbox"/>	<input checked="" type="checkbox"/>	<input type="checkbox"/>	<input type="checkbox"/>	<input type="checkbox"/>	Cooling system cycles from thermostat; fan runs continuously
<input checked="" type="checkbox"/>	<input type="checkbox"/>	<input checked="" type="checkbox"/>	<input type="checkbox"/>	<input type="checkbox"/>	<input type="checkbox"/>	Cooling system and fan cycle from thermostat
<input checked="" type="checkbox"/>	<input type="checkbox"/>	<input type="checkbox"/>	<input type="checkbox"/>	<input checked="" type="checkbox"/>	<input type="checkbox"/>	Heating system cycles from thermostat; fan cycles from fan control on furnace
<input type="checkbox"/>	<input checked="" type="checkbox"/>	<input type="checkbox"/>	<input type="checkbox"/>	<input type="checkbox"/>	<input checked="" type="checkbox"/>	Heating system cycles from thermostat; fan runs continuously

Figure 5. Subbase Switching and Thermostat/System Operation.

Setting the Temperature Levers

Move the **HI** temperature setting lever to the highest temperature desired. Move the **LO** temperature setting lever to the lowest temperature desired (see fig. 6). The difference between the two temperature settings is the amount of setback or setup that will occur at the times you have selected with the red and blue timer selectors. If the two temperature levers are together, the thermostat will maintain a constant temperature (no setbacks or setups will occur). For example, if the two levers are set together at 75°F, the room temperature will be maintained at 75°, no matter how many timer selectors you have used.

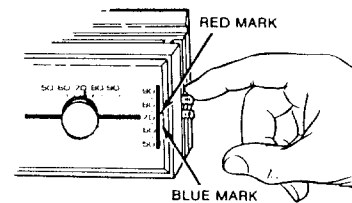

Figure 6. Setting temperature levers.

Setting the Program Advance Switch

⚠ CAUTION

The program advance switch cannot be moved within one hour before or after a timer selector has changed the setback/setup time period.

The program advance switch is an extension of the timer switch, and is located at the top of the thermostat between the thermostat base and

cover (see fig. 7). The switch allows the operator to manually override the current setback or setup time period. If the thermostat is in a setback time period (in the **blue** position) when you move the switch, the thermostat will go into a setup time period. The switch does not cause a permanent change in timer operation. Normal operation will resume when the bypassed setback or setup period has elapsed.

REPLACING THE BATTERY

If the timer slows down or stops, the battery should be replaced. If your thermostat uses "AA" alkaline batteries, you should routinely replace the batteries once a year to ensure proper clock operation. If your thermostat uses a Nicad battery, the normal battery life is six years. The system will continue to operate if the battery is dead, but the setback/setup feature

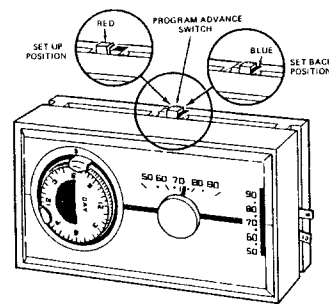

Figure 7. Program advance switch.

will not operate. Follow these steps to replace the battery.

1. Use a small screwdriver to pry the battery out (see fig. 8).
2. Install a fresh battery, with the positive (+) end to the right.

If you have a Nicad battery: If the clock stops after the fresh battery is installed, move both temperature levers to the lowest setting. The automatic recharging circuit is then connected to the battery. Leave the temperature levers at the lowest setting for two to three hours; this will provide sufficient battery charging to operate timer. The battery will then automatically be recharged whenever the thermostat is not calling for heat or cool.

After replacing and charging the battery, let the system cycle for at least three hours, then check to see that the clock is maintaining the proper time.

NOTE

If the Nicad battery is installed on a day when extreme outdoor temperatures are experienced

14

and the heating or cooling system operate for long periods of time, it may take as much as 24 to 48 hours to charge the battery. If you wish to charge the battery more quickly, move the system switch to the **OFF** position. The battery then will fully charge in approximately 3 hours (however, the system **will not operate** with the system switch in the **OFF** position).

3. After the battery has been replaced, refer to **SET AND START THE TIMER** to reset and start timer operation.

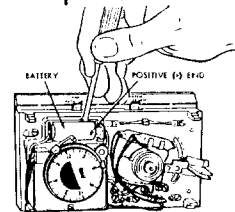

Figure 8. Battery replacement.

WARRANTY INFORMATION

THIS WARRANTY STATEMENT SUPERSEDES ALL WARRANTY STATEMENTS DATED PRIOR TO MARCH 1, 1988.

White-Rodgers Division of Emerson Electric Co. ("Seller") warrants that its products purchased for resale (the "Products") will be free from defects in material and workmanship under normal use and service for a period of twelve (12) months from date of installation. Seller's obligation under this warranty, and Purchaser's exclusive remedy for the breach thereof, shall be limited to, at Seller's option, Seller's replacement of any defective Product F.O.B. Seller's factory, or Seller's issuance of a credit in the amount of the purchase price of such Product for resale as described below. Seller shall have the option of requiring the return of any defective Product, transportation charges prepaid, before recognizing any claim. This warranty shall not apply to any Product (1) which has been repaired or altered outside Seller's factory or by other than Seller in any manner so as, in Seller's judgement, to affect its serviceability or proper operation; (2) which has been subjected by persons other than Seller to improper handling, operation, maintenance, repair or alteration; or (3) which has been subjected to misuse, negligence, or accident.

This warranty extends only to persons or organizations who purchase the Products for resale. THE FOREGOING CONSTITUTES SELLER'S SOLE RESPONSIBILITY UNDER THIS WARRANTY, AND PURCHASER'S EXCLUSIVE REMEDY FOR BREACH THEREOF. EXCEPT AS OTHERWISE EXPRESSLY SET FORTH IN THIS AGREEMENT, THERE ARE NO OTHER WARRANTIES, EXPRESS OR IMPLIED, WHETHER OF MERCHANTABILITY, FITNESS FOR A PARTICULAR PURPOSE, OR OTHERWISE. SELLER SHALL NOT BE LIABLE FOR ANY SPECIAL, INDIRECT, INCIDENTAL OR CONSEQUENTIAL DAMAGES IN CONNECTION WITH THE SALE, RESALE OR USE OF THE PRODUCTS.

Complete warranty information and instructions for replacing/returning warranty products can be found in the White-Rodgers Product Catalog, or by telephoning or writing to:

White-Rodgers Division
Emerson Electric Co.
9797 Reavis Road
St. Louis, Missouri 63123-5329
(314) 577-1300

WARRANTY INFORMATION FOR CONSUMERS

When you purchase a White-Rodgers Division product, it is typically for replacement of a device which has failed on existing residential or commercial equipment, or a component of new equipment purchased for modernization.

While our warranty does not extend to you, your contractor or dealer is protected by a one-year product warranty from White-Rodgers. Your supplier can rely on a nearby White-Rodgers wholesaler for prompt credit or replacement.

If you need further information on programming or operation, you may write:

WHITE-RODGERS DIVISION

Emerson Electric Co.
9797 Reavis Road
St. Louis, MO 63123
ATTN: Customer Service



Part No. 37-5028A

9147

Free Manuals Download Website

<http://myh66.com>

<http://usermanuals.us>

<http://www.somanuals.com>

<http://www.4manuals.cc>

<http://www.manual-lib.com>

<http://www.404manual.com>

<http://www.luxmanual.com>

<http://aubethermostatmanual.com>

Golf course search by state

<http://golfingnear.com>

Email search by domain

<http://emailbydomain.com>

Auto manuals search

<http://auto.somanuals.com>

TV manuals search

<http://tv.somanuals.com>