

Technika

EXCLUSIVELY FROM **TESCO**

MC-429ID

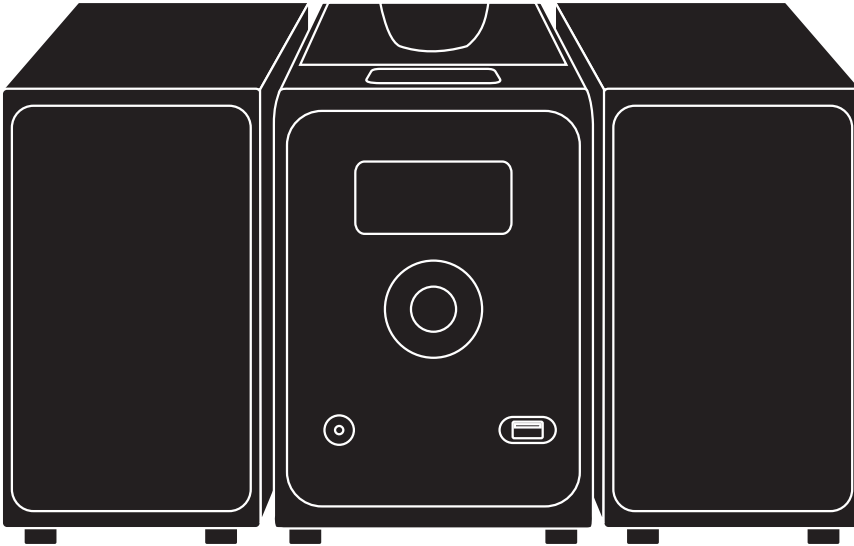

Owner's Handbook

Mini DAB/CD/MP3 audio system with iPod dock

Download from www.Somanuals.com. All Manuals Search And Download.



IMPORTANT SAFETY INFORMATION



This symbol indicates that there are important operating and maintenance instructions in the literature accompanying this unit.



This symbol indicates that dangerous voltage constituting a risk of electric shock is present within this unit.

Read these instructions.

Keep these instructions.

Heed all warnings.

Follow all instructions.

Do not use this apparatus near water.

Clean only with a slightly damp cloth.

Do not block any ventilation openings.

Install in accordance with the manufacturer's instructions.

Do not install or operate near any heat sources such as radiators, stoves, or other apparatus that produce heat.

Unplug this apparatus during lightning storms or when unused for long periods of time.

Refer all servicing to qualified service personnel. Servicing is required when the apparatus has been damaged in any way, such as the power-supply cord or plug is damaged, liquid has been spilled or objects have fallen into the apparatus, the

apparatus has been exposed to rain or moisture, does not operate normally, or has been dropped.

Warning: To reduce the risk of fire or electrical shock, do not expose this product to rain or moisture. The product must not be exposed to dripping and splashing and no object filled with liquids such as a vase of flowers should be placed on the product.

No naked flame sources such as candles should be placed on the product.

Caution: Changes or modifications not expressly approved by the manufacturer could void the user's authority to operate this device.

Caution: Usage of controls or adjustments or performance of procedures other than those specified herein may result in hazardous exposure.

IMPORTANT

This equipment generates, uses and can radiate radio frequency energy and, if not installed and used in accordance with the instructions, may cause harmful interference to radio communication. However, this is no guarantee that interference will not occur in a particular installation. If this equipment does cause harmful interference to radio or television reception, which can be determined by turning the equipment off and on, the user is encouraged to try to correct the interference by one of the following measures:

- Reorient or relocate the receiving antenna.
- Increase the separation between the equipment and receiver.
- Connect the equipment into an outlet on a circuit different from that to which the receiver is connected.
- Consult the dealer or an experienced radio/TV technician for help.

WARNING: DANGER OF RADIATION



These labels tell you that the unit contains a laser component. Opening the CD compartment lid and defeating the safety interlocks will expose the user to radiation from the laser beam. Do not stare into the laser while it is operating.

ELECTRICAL INFORMATION

Mains Supply: The mains operating voltage of this unit is marked on a rating plate on the underside of the unit.

The means of disconnecting this appliance from the mains supply is the mains plug. This should be unobstructed and readily operable at all times.

INDEX

INDEX

Introduction	2
Unpacking	2
Placement	3
Connecting speakers.....	3
Controls and connections.....	4
Display features	5
Remote control	6
Getting started	7
Setting the clock.....	7
Standby control, Volume.....	7
Listening to DAB radio	8
Listening to FM radio.....	8
Presets.....	8
DAB & FM Display modes.....	9
DAB Scanning, Advanced DAB operation	10
Listening to a CD.....	11
CD repeat and shuffle	11
Programming tracks from a CD.....	12
Listening to a MP3/WMA disc/USB drive	13
Programming MP3/WMA tracks.....	15
iPod adaptors	16
Playing an iPod.....	17
Aux sources.....	18
EQ & Bass boost	18
Headphones	18
Timer & Sleep functions.....	19
System reset	19
Care & maintenance	20
Specifications	20

INTRODUCTION

Introduction

DAB (Digital Audio Broadcasting) technology allows many more radio stations compared to FM. DAB transmissions do away with problems of hiss and fade that plague AM and FM broadcasts and are less likely to be affected by adverse weather conditions or other sources of interference. In addition to speech and music DAB transmissions carry high levels of data - far greater than the limited RDS information available on FM stations.

Unlike FM, DAB is broadcast on many frequencies. Many countries in Europe, including the UK use Band III (174-230 MHz); others, France for example, use the L-Band (1452-1492 MHz). Germany uses both bands.

Your radio can tune Band III. Countries in Europe that use Band III include: Belgium, Denmark, Holland, Italy, Norway, Portugal, Spain, Sweden, Switzerland. Your radio will tune stations in all these countries.

Your radio cannot receive French or German stations broadcasting in the L-Band though FM services are available all over Europe.

Being digital, DAB transmissions can have a wider frequency range and greater dynamics than that available with FM technology.

FM reception is available on your system for use in those locations where there is no usable DAB service.

A headphone output is provided for personal listening.

PRELIMINARIES

UNPACKING

Carefully unpack the unit. If it is damaged, please return it to your nearest Tesco store for replacement. Remember to take your purchase receipt with you.

Retain the User Handbook. If you pass the unit on to a third party make sure you pass on the handbook.

We suggest you retain the packaging. If you dispose of it, do so having regard to any recycling regulations in your area.

CONTENTS

The carton should contain:

- The MC-429ID audio system
- 2 x Loudspeakers
- Remote control with 2 x AAA batteries
- Operating Manual

If any items are missing or damaged, contact your nearest TESCO store for a replacement. Have your receipt ready when you call. Retain the packaging. If you dispose of it, do so having regard to any recycling regulations in your area.

PREPARATION FOR USE

PLACEMENT

Place the unit on a sturdy table or shelf where it cannot get knocked over and where there is a clear line of sight to the remote handset.

Make sure that there is a clearance of 10cm (4 inches) around the unit for ventilation.

LOUDSPEAKERS

Placing the speakers

Unwrap the speaker wires from the ties securing them to the back of each speaker.

Place a speaker on either side of the main unit, preferably at the same height, and with at least 150mm between each speaker and the main unit.

Connecting the speakers

1. Locate the block of 4 speaker terminals on the back of the unit,.
2. Lift the latches on the left channel speaker terminals as shown in the drawing.

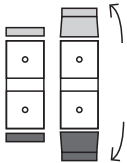

3. Feed the wires from the left speaker into the two terminals, observing the colour code with the black-striped wire connecting to the bottom black terminal.

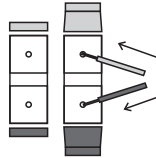

4. Press the latches down to lock the wires in place.

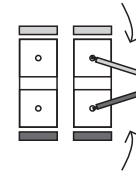

5. Repeat to connect the right speaker to the right channel speaker terminals.
6. Check that the bare ends of the wires are not exposed and cannot touch together.

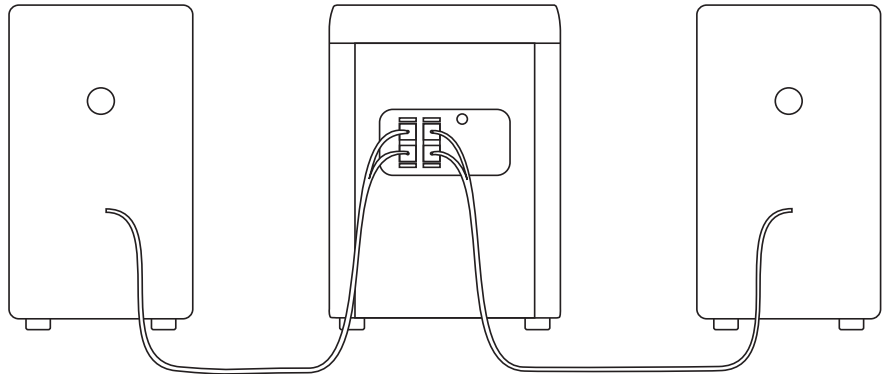

CONTROLS & CONNECTIONS

FRONT & TOP VIEW

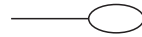

NOTE: This symbol indicates a touch-sensitive area of the front panel. Lightly touch in this area to operate the function.

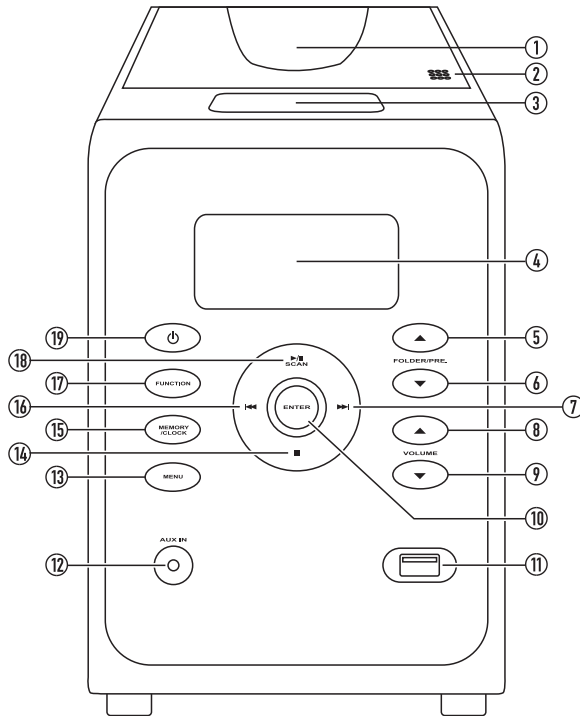

- ① Disc compartment lid
- ② Lid OPEN/CLOSE area
- ③ iPod docking bay
- ④ Display
- ⑤ Next folder touchpad
- ⑥ Previous folder touchpad
- ⑦ Skip forward button
- ⑧ Volume up touchpad
- ⑨ Volume down touchpad
- ⑩ Enter button
- ⑪ USB jack
- ⑫ Aux In jack
- ⑬ Menu touchpad
- ⑭ Stop button
- ⑮ Memory/clock touchpad
- ⑯ Skip back button
- ⑰ Function touchpad
- ⑱ Play/Paus/Scan button
- ⑲ Standby touchpad

BACK VIEW

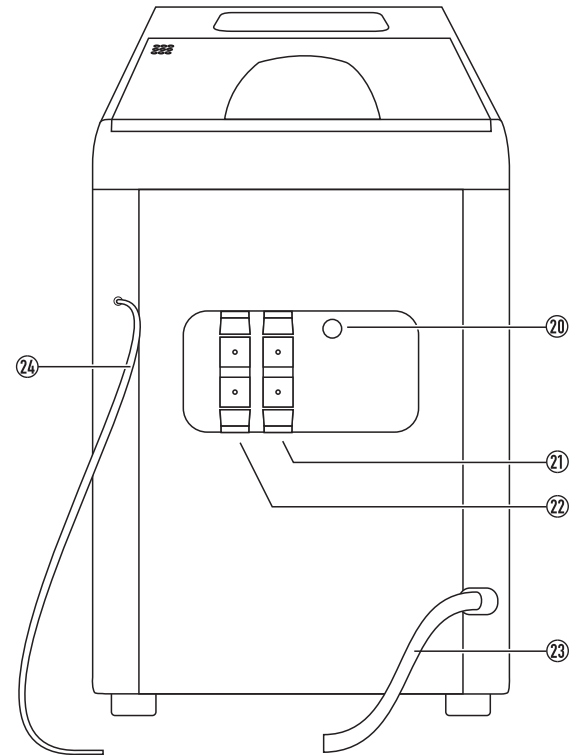

DISPLAY FEATURES

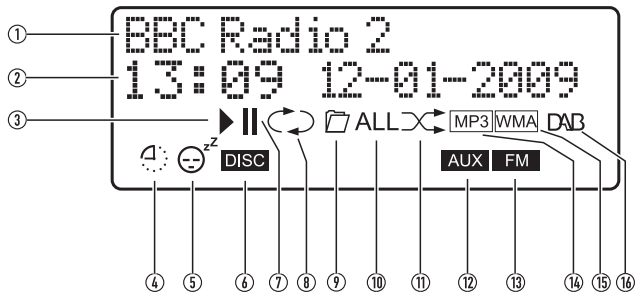

- ① Text display for tracks/stations
- ② Text display for information
- ③ Play symbol
- ④ Timer set symbol
- ⑤ Sleep symbol
- ⑥ Disc loaded symbol
- ⑦ Pause symbol
- ⑧ Repeat mode symbol
- ⑨ Repeat folder symbol
- ⑩ Repeat All symbol
- ⑪ Shuffle symbol
- ⑫ Aux mode symbol
- ⑬ FM mode symbol
- ⑭ MP3 format symbol
- ⑮ WMA format symbol
- ⑯ DAB mode symbol

REMOTE CONTROL

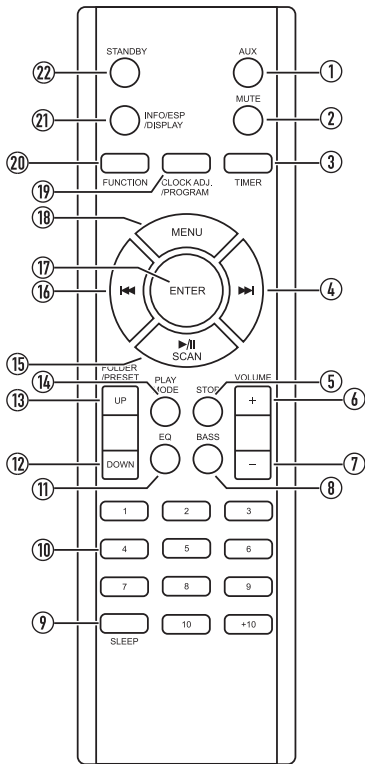

- ① Aux mode button
- ② Mute button
- ③ Timer button
- ④ Next button
- ⑤ Stop button
- ⑥ Volume up button
- ⑦ Volume down button
- ⑧ Bass button
- ⑨ Sleep button
- ⑩ Numeric keypad
- ⑪ EQ button
- ⑫ Previous folder button
- ⑬ Next folder button
- ⑭ Play mode button
- ⑮ Play/Pause/Scan button
- ⑯ Previous button
- ⑰ Enter button
- ⑱ Menu button
- ⑲ Clock set/Program button
- ⑳ Function button
- ㉑ Info/ESP/Display button
- ㉒ Standby button

REMOTE CONTROL BATTERIES

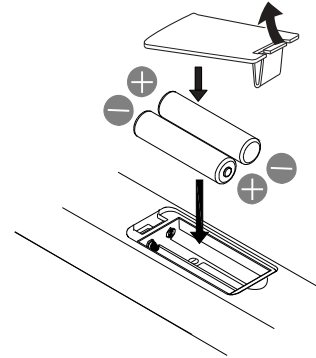

FITTING OR REPLACING THE REMOTE CONTROL BATTERIES

When replacing the batteries in the remote control, refer to the diagram above.

1. Press the catch on the battery door across.
2. While holding the catch, open the battery door.
3. Fit two AAA batteries observing polarity as shown. When replacing the batteries, use only the same AAA type specified.
4. Re-fit the battery door and clip it in place.

DISPOSAL OF BATTERIES

Dispose of used batteries with regard to the recycling regulations in your area. Do NOT short circuit batteries or throw them into water, the general rubbish or in a fire.

Weak batteries can leak and damage the remote control. Replace them in good time!

GETTING STARTED

REMOVING THE PACKING FROM THE CD PLAYER

Before connecting power to your audio system, the protective packing should be removed from the CD compartment.

To remove the protective packing:

- Open the CD compartment by pressing down on the **OPEN/CLOSE** area marked at the front corner of the CD lid.

The lid will open.

- Remove any cardboard protective packing from the CD compartment.
- Close the CD lid.

DAB/FM RADIO AERIAL

Before using your radio for DAB or FM reception, unwrap and fully extend the aerial wire. You may need to adjust the position of the aerial wire for maximum signal strength.

CONNECTING POWER

- Check that the mains voltage marked on the rating plate under the unit is the same as the voltage in your area.
- Plug the AC power cord into the AC inlet
- Plug the mains plug into the wall socket and switch the mains power on.

SETTING THE CLOCK

Automatic clock setting:

The clock time will set automatically when a DAB station is first tuned.

In areas where DAB reception is not available, manual clock setting will be necessary.

To set the clock manually:

- With the system set to Standby, press and hold the **CLOCK ADJ./PROGRAM** button on the remote control.

The display will show the legend '24 HOUR' with the digits 24 flashing.

NOTE: The display will not light during clock setting.

- Press the **◀◀** or **▶▶** buttons to select 24 hour or 12 hour mode for the clock.
- Press the **CLOCK ADJ./PROGRAM** button.

The display will show the time currently set with the hours digits flashing.

- Press the **◀◀** or **▶▶** buttons to set the hours digits to the correct time.
- Press the **CLOCK ADJ./PROGRAM** button.

The display will show the time currently set with the minutes digits flashing.



- Press the **◀◀** or **▶▶** buttons to set the minutes digits to the correct time.
- Press the **CLOCK ADJ./PROGRAM** button.

The clock settings will be stored.

STANDBY CONTROL



STANDBY CONTROL

To turn the system on:

- Touch the  touchpad or press the /STANDBY button on the remote control.

The display will light and the system will set to play the last function used. If this was radio, the last station played will be selected.

To turn the system off:

- Touch the  touchpad or press the /STANDBY button on the remote control.

The system and display light will switch off. The clock will continue to run whilst mains power is connected.

ADJUSTING THE VOLUME

VOLUME CONTROL

To increase the volume:

- Touch the **VOLUME ▲** touchpad or press the **VOLUME +** button on the remote control.

To decrease the volume:

- Touch the **VOLUME ▼** touchpad or press the **VOLUME -** button on the remote control.

MUTE

The Mute function will set the volume to minimum.

To mute the volume:

- Press the **MUTE** button on the remote control to set mute at any time.
- Press the **MUTE** button again to restore the volume to its previous setting.

LISTENING TO DAB RADIO

SELECTING DAB RADIO OPERATION

To select DAB radio operation:

- Touch the **FUNCTION** touchpad (or press the **FUNCTION** button on the remote control) repeatedly until 'DAB' is displayed.

After a few seconds, the radio will tune to the last-used station.

INITIAL DAB RADIO SCAN

When DAB radio is used for the first time:

The system scans all usable stations (full scan) and stores them alphanumerically -1 Radio, 2 Radio, AA Radio...

The initial scan will take a few minutes and a progress bar will be displayed with the number of services found.

After the scan, the clock will be set, the radio will display the first station in the sequence and begin playing at the default system volume of 13.

Note: If no stations are found after the scan, it may be that the



Number of services found

signal in your current location is too weak. If this happens, switch the radio off and move it to a location with a stronger signal. Repeat the scan process in the new location.

The stations found will be stored in an alphanumeric list.

TO SELECT ANOTHER STATION

- Press the **◀▶** or **▶▶** button to browse the list of stations on the display.
- When you find the station name you want to listen to, press the **ENTER** button.

LISTENING TO FM RADIO

To change to the FM band

- Touch the **FUNCTION** touchpad (or press the **FUNCTION** button on the remote control) repeatedly until 'FM' is displayed.

To manually tune to FM stations

- Press the **◀▶** or **▶▶** button repeatedly to tune down or up the band one frequency step at a time.

To auto-tune to FM stations

- Press the **▶II/SCAN** button to tune to the next station in the band.
- To change the sweep direction, press the **◀◀** button (to tune down) or **▶▶** button (to tune up) before pressing the **▶II/SCAN** button.

Tuning will stop automatically when the station is reached.

STATION PRESETS

DAB and FM presets

Your radio can store up to 10 of your favourite stations as presets (numbers 0-9) on both the DAB and FM bands for quick recall.

To store a preset

- Tune to the station you want to store as a preset.
- From the remote control, press and **hold** the **NUMBER (0-9)** button for the preset location you want to store.

The display will confirm that the station has been stored in this preset number.

To recall a preset

- Press the **NUMBER (0-9)** button briefly to recall a station stored in this preset number.

The radio will re-tune to the preset station number that you selected.

DAB & FM DISPLAY MODES

DAB DISPLAY MODES

When playing a DAB station you can change the information on the display by changing the display mode.

To change the display mode:

Press the **INFO** button repeatedly to cycle through the options listed in the chart below.

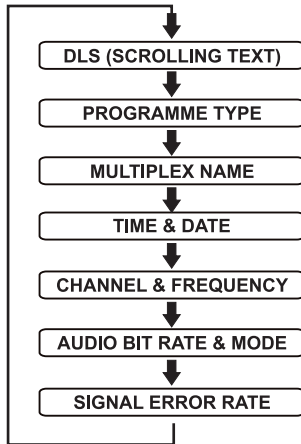

DLS (SCROLLING TEXT): This is a scrolling message giving real-time information - song titles, news headlines, etc.

PROGRAMME TYPE: This describes (when available) the style of the programme being broadcast.

MULTIPLEX NAME (GROUP NAME): is the name of the DAB Multiplex that is currently tuned.

TIME & DATE: Shows the current time and date. Time and date are updated by broadcasted information.

CHANNEL AND FREQUENCY: The Channel and Frequency display shows the multiplex channel number and the multiplex frequency for the station currently tuned.

BIT RATE: DAB allows broadcasters to vary the BIT RATE (or the amount by which an audio signal can be compressed) depending on the type of broadcast. This enables the amount of stations on a multiplex to be maximised. Speech and News are often broadcast at a lower Bit Rate; music needs a higher Bit Rate for good fidelity.

SIGNAL ERROR RATE: This Signal Error Rate is a measure of the signal quality. The lower the figure, the better the signal quality. The Signal Error Rate display is helpful when setting up the aerial wire. Move the wire to minimise the reading on your favourite stations.

FM DISPLAY MODES

Some FM stations broadcast additional 'RDS' station information. When RDS data is present on an FM transmission, 'RDS' will be displayed as shown below.

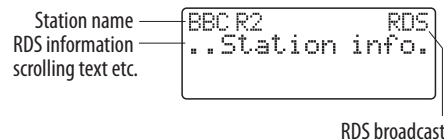

When playing an FM station you can change the information on the display by changing the display mode.

To change the display mode:

Press the **INFO** button repeatedly to cycle through the options listed in the chart below.

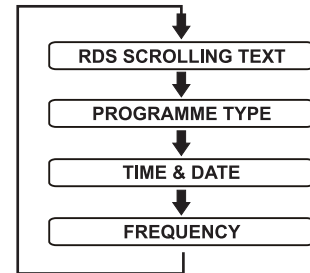

RDS (SCROLLING TEXT): This is a scrolling message giving real-time information - song titles, news headlines, etc.

PROGRAMME TYPE: This describes (when available) the style of the programme being broadcast.

TIME & DATE: Shows the current time and date. Time and date are updated by broadcasted information.

FREQUENCY: The Frequency display shows the frequency for the station currently tuned.

DAB SCANNING

When first used, your audio system scanned the DAB band for available stations. The station services found were then stored in your system's memory.

You can re-scan the band at any time if you move to a different area or just to refresh the stored list of available stations.

TO START A FULL SCAN

- Select the DAB band.
- Press the ►||/SCAN button to start a scan.

The unit will now display the legend 'SCANNING' and a bargraph to show scan progress. The number of services found during the scan will be shown at the right side of the display.

After running a scan the radio will re-tune to the last tuned station, or if this is not available, the first station found in alphabetical sequence.

DAB ADVANCED OPERATION

The DAB radio of your audio system includes several advanced features.

To select the advanced features:

- Touch the **MENU** touchpad on the front panel (or press the **MENU** button on the on the remote control) to open the advanced operation menu.
- To scroll through the menu options below, press the ◀◀ or ▶▶ button.

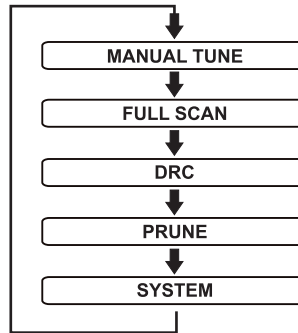

- To select a menu option, press the **ENTER** button.

MANUAL TUNE

Manual tuning may be used to tune the band by frequency or multiplex. A station multiplex may then be selected and displayed with a signal strength bargraph to assist with aligning the aerial for best signal.

To tune manually:

- Select Manual Tune from the menu.
- Press the ◀◀ or ▶▶ button to scroll through the multiplex numbers and frequencies.

- To select a multiplex, press the **ENTER** button. *The selected multiplex number will be displayed with (if present) the multiplex name and signal strength.*

- Press the ◀◀ or ▶▶ button to re-tune to another multiplex.

FULL SCAN

You can start a local or full scan by selecting these menu options. This is an alternative method of starting a scan to that described in the SCANNING section on this page.

DRC VALUE

DRC is Dynamic Range Compression. Enabling DRC may improve the sound of DAB radio when listening in a noisy room. You can set the DRC value with this menu option.

- Select DRC from the menu.
- Press the ◀◀ or ▶▶ button to select the DRC value you prefer from the options of Off, high or low.
- Press the **ENTER** button to confirm your selection.

PRUNE: If your station list includes stations that you can no longer receive (you may have moved to a different area), you can select the 'Prune' option to remove any stations that can no longer be received from the Station List.

SYSTEM

If you choose this option, the radio's software version is displayed. This is purely an aid for technicians should your radio ever need service.

LISTENING TO A CD

LOADING DISCS

To select CD operation:

- Touch the **FUNCTION** touchpad (or press the **FUNCTION** button on the remote control) repeatedly until 'CD' is displayed.

Loading a disc:

- Press the **OPEN/CLOSE** area at the front corner of the disc lid on top of the unit.

The lid will open slowly.

- Gently place a disc on the centre spindle with the label side upward.
- Once in place, press the centre of the disc until it clicks into place on the turntable.
- Close the lid and press the **OPEN/CLOSE** area until it latches shut.

After a few seconds the disc will read and the disc data will be displayed.

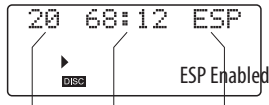

Total number
of tracks on
the CD

Total play
time

ESP Enabled

Unloading a disc:

- If the disc is playing, press the **STOP/■** button and wait a few seconds for the disc to stop.
- Press the **OPEN/CLOSE** area at the front of the CD lid.

The lid will open slowly.

Grip the disc at the sides and lift it out of the disc compartment.

CD PLAYBACK, PAUSE:

- Load the CD.
- Press the **▶||/SCAN** button to start the CD playing.
- When a CD is playing, pressing the **▶||/SCAN** button at any time will pause playback. Press the button again to re-start play.

Selecting tracks:

- Press the **◀◀** or **▶▶** button **briefly** to select the previous or next track from the disc.

NOTE: The first press of the **◀◀** button will replay the current track.

Direct access track selection:

- Press a number button to select a track number (or two numbers if the number is greater than 9).
- Press the **▶||/SCAN** button to skip to your chosen track.

Fast search:

- To fast search through a track, press and hold the **◀◀** or **▶▶** button.

The player will fast search through the track at high speed in the chosen direction until the button is released.

CD REPEAT AND SHUFFLE

REPEAT AND SHUFFLE FUNCTIONS

You can repeat a single track, the whole disc or select shuffle to play the tracks in a random sequence.

To set a repeat or shuffle mode:

- Press the **PLAY MODE** button on the remote control to cycle through the options of 'Repeat 1' (repeat current track), 'Repeat All' (Repeat the disc) or Shuffle (play tracks in a random sequence).

The Repeat, Repeat All or Shuffle symbol will be displayed.

ESP SYSTEM

The ESP system is an anti-shock feature for CD playback.

To toggle ESP on or off:

- Press the **INFO/ESP/DISPLAY** button when playing a CD.

The ESP legend will be displayed when ESP is switched on.

PROGRAMMING TRACKS FROM A CD

CD PROGRAMMING

When playing a CD, you can store a random sequence of up to 64 tracks to play in your preferred order.

Program entry takes place when the disc is stopped.

STORING A PROGRAM

To store a CD program:

- Load the disc you want to play, wait for the disc to read.
- Touch the **MEMORY/CLOCK** touchpad on the front panel or press the **CLOCK ADJ./PROGRAM** button on the remote control.

The Program Entry display will appear, prompting for the first track number to program (P-01).

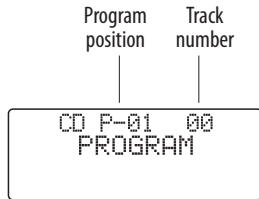

- Press the **◀◀** or **▶▶** button to select the track number for the first track you want to program.
- Touch the **MEMORY/CLOCK** touchpad on the front panel or press the **CLOCK ADJ./PROGRAM** button on the remote control to store this track into the program memory.

The track will be stored and the program counter will increase to P-02.

- Repeat the above two steps to store the next and subsequent tracks in your program sequence.

Playing the program

- When you have finished entering all tracks in your program, press the **▶||/SCAN** button to start the program playing.

Navigating the programmed tracks:

When the program is playing, the play and pause buttons work as normal and you can skip between tracks in the program by pressing the **◀◀** or **▶▶** button.

Clearing a program

- If the CD is playing, press the **STOP/■** button to stop the disc.
- Once the disc has stopped, press the **STOP/■** button again.

The Program will clear from memory.

NOTE: Opening the disc loading door will also clear the program.

Repeat function

- When a program is stored you can set a repeat mode in the normal way if required.

LISTENING TO A MP3/WMA DISC OR MP3/WMA FILES STORED ON A USB DRIVE

MP3/WMA PLAYBACK:

Your system can also play MP3 or WMA music compilations recorded onto a CD-ROM compilation or stored on a USB drive. The files may all be stored in the 'root' directory of the disc/drive or organised in a set of sub-folders (usually by album).

If your music tracks have been saved to include artist and title information this will be displayed as the tracks are playing.

LOADING A CD-ROM MP3/WMA DISC

Loading a disc:

- Press the **OPEN/CLOSE** area at the front corner of the disc lid on top of the unit.

The lid will open slowly.

- Gently place a disc on the centre spindle with the label side upward.
- Once in place, press the centre of the disc until it clicks into place on the turntable.
- Close the lid and press the **OPEN/CLOSE** area until it latches shut.

After a few seconds the disc will read and the disc data will be displayed.

Unloading a disc:

- If the disc is playing, press the **STOP/■** button and wait a few seconds for the disc to stop.
- Press the **OPEN/CLOSE** area at the front corner of the CD lid.

The lid will open slowly.

Grip the disc at the sides and lift it out of the disc compartment.

DOCKING A USB DRIVE

If you have saved your MP3/WMA music files to a USB drive you can dock the drive to the front panel USB jack.

To dock a USB drive:

- Plug the USB drive into the USB jack on the front panel.

Removing a USB drive:

- A USB drive may be removed from the dock as required.

LISTENING TO A MP3/WMA DISC OR MP3/WMA FILES STORED ON A USB DRIVE

SELECTING MP3/WMA PLAYBACK:

- Touch the **FUNCTION** touchpad or press the **FUNCTION** button on the remote control repeatedly until 'CD' is displayed (to play from a compilation CD-ROM) or until 'USB' is displayed (to play from a docked USB drive).

MP3/WMA DISPLAY

Once you have loaded your disc/drive and selected disc or USB playback, the contents of the disc/drive will be displayed.

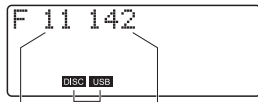

Total number of folders on the disc/drive

Total number of MP3/WMA tracks on the disc/drive

Indicates playback from disc or USB drive

PLAYBACK CONTROL:

Play/pause:

- Load the MP3/WMA disc or USB drive.
The number of tracks on the disc (and folders if applicable) will be displayed.
- Press the ►||/SCAN button to start the disc playing.
- When a disc is playing, pressing the ►||/SCAN button at any time will pause the CD. Press the button again to re-start play.

Selecting tracks:

- Press the ◀◀ or ▶▶ button **briefly** to select the previous or next track from the disc.

NOTE: The first press of the ◀◀ button will replay the current track.

Fast search:

- To fast search through a track, press and hold the ◀◀ or ▶▶ button.

The player will fast search through the track at high speed in the chosen direction until the button is released.

If the music files on the disc are organised into folders you can change between folders.

To change folders (if there are more than 1):

- Touch the FOLDER ▲ or ▼ touchpad (or press the **FOLDER/PRESET UP or DN** button on the remote control) to scroll through the folders on the disc.
- When you have selected the folder you want, you can then search for tracks within the folder using the ◀◀ or ▶▶ button.

Direct access track selection:

- Press a number button to select a track number.
- Press the ►||/SCAN button to skip to your chosen track.

REPEAT AND SHUFFLE FUNCTIONS

You can repeat a single track, the current folder, the whole disc or select shuffle to play the tracks in a random sequence.

To set a repeat or shuffle mode:

- Press the **PLAY MODE** button on the remote control to cycle through the options of 'Repeat 1' (repeat current track), 'Repeat Folder' (Repeat all tracks in the current folder), 'Repeat All' (Repeat the disc) or Shuffle (play tracks in a random sequence).

The Repeat, Repeat Folder, Repeat All or Shuffle symbol will be displayed.

PROGRAM PLAY OF MP3/WMA FILES STORED ON A DISC OR USB DRIVE

STORING A MP3/WMA PROGRAM

Some MP3/WMA compilations will be arranged with all tracks in the 'root' folder of the disc/drive, others will be arranged within a set of folders (usually the music albums). The same sequence is used for both types of track storage.

To store a MP3/WMA program:

- Load the disc/drive you want to play, and wait for it to read.
- Touch the **MEMORY/CLOCK** touchpad on the front panel or press the **CLOCK ADJ./PROGRAM** button on the remote control.

The Program Entry display will appear, prompting for the first folder, then track number to program (P-01).

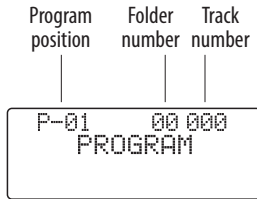

- Press the **◀◀** or **▶▶** button to select the folder number for the first track you want to program.

NOTE: If all tracks are arranged in the 'root' directory of the disc, only 'Folder 1' (01) will be selectable at this stage.

- Touch the **MEMORY/CLOCK** touchpad on the front panel or press the **CLOCK ADJ./PROGRAM** button on the remote control to select this folder.

- Press the **◀◀** or **▶▶** button to select the track number within this folder for the first track you want to program.
- Touch the **MEMORY/CLOCK** touchpad on the front panel or press the **CLOCK ADJ./PROGRAM** button on the remote control to store this track into the memory.

The track will be stored and the program counter will increase to P-02.

- Repeat the previous four steps to store the next and subsequent tracks in your program sequence.

Playing the program

- When you have finished entering all tracks in your program, press the **▶||/SCAN** button to start the program playing.

Clearing a program

- If the CD is playing, press the **STOP/■** button to stop the disc.
- Once the disc has stopped, press the **STOP/■** button again.

The Program will clear from memory.

NOTE: Opening the disc loading door will also clear the program.

Navigating the programmed tracks:

When the program is playing, the play and pause buttons work as normal and you can skip between tracks in the program by pressing the **◀◀** or **▶▶** buttons.

Repeat function

- When a program is stored you can set Repeat 1 or Repeat All mode in the normal way if required.

iPod ADAPTORS

Before docking your iPod you must first check if your iPod has a docking connector. Early iPod models do not have one and cannot be docked to your unit. The docking connector is located on the base of the iPod as shown below.

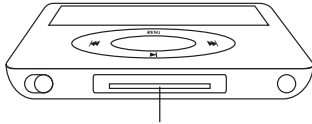

Docking Connector

Before docking your iPod, you must fit the correct iPod adaptor to the docking bay. Each iPod adaptor matches the shape of a particular iPod and is necessary to ensure that your iPod is securely held when docked.

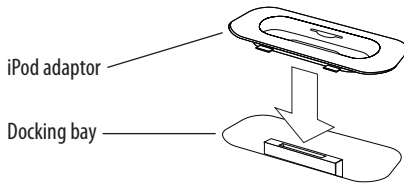

FITTING THE iPod ADAPTOR

When your iPod was new it may have been supplied with a standard dock adaptor in the packaging. If so, fit the adaptor by pressing it gently into the Docking Bay as shown above.

NOTE: Do not dock an iPod without fitting the correct adaptor, you may damage the iPod and your unit.

SELECTING AN ADAPTOR

If you don't have a dock adaptor

If your iPod was not supplied with a standard dock adaptor, or if you have lost the adaptor, you can buy one from Apple on-line. To determine the exact model of your iPod, refer to this web-link - <http://support.apple.com/kb/HT1353>. You can then browse the iPod accessories page on the Apple website to find an adaptor for your iPod model that can be purchased on-line.

CONNECTING OTHER iPod MODELS (INC SHUFFLE)

To connect your iPod via the AUX IN jack:

- Using a 3.5mm stereo jack cable (not supplied), connect one end of the cable to the headphone socket of the iPod, and the other end to the AUX IN jack on the front panel.

Headphone jack

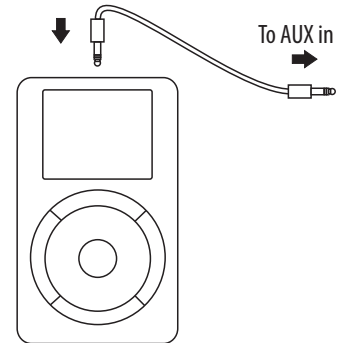

- To listen to your iPod, follow the instructions on page 15 for playing equipment connected to the AUX IN jack.

NOTE:- The volume control of the iPod must be turned up when playing through the AUX IN jack.

NOTE:- An iPod connected to the AUX IN jack cannot be operated from the remote control.

DOCKING AN iPod

DOCKING YOUR iPod

To dock your iPod:

- Check that the correct iPod adaptor is fitted to the docking bay.
- Locate the iPod on the Docking Connector and press it gently home.

To remove your iPod from the dock:

- Grip the iPod at the sides.
- Lift the iPod gently from the dock.

PLAYING FROM AN iPod

To play music from your iPod

- Press the **FUNCTION** button repeatedly until 'iPod' is displayed.

You can now operate your iPod functions from the controls on the front panel or remote control.

Playback functions:

- Press the **▶||/SCAN** button to toggle the iPod between Play and Pause mode at any time.
- Press the **◀◀** or **▶▶** button to select the previous or next track.

iPod menu functions:

You can press the **MENU**, **ENTER** and **FOLDER/PRESET UP** or **DN** buttons on the remote control (or the front panel touchpads) to navigate the iPod menus.

- To move up through the iPod menus, press **MENU**.
- To scroll up and down menu items, press the **FOLDER/PRESET UP (▲)** or **DN (▼)** touchpads/buttons.
- To select menu items, press the **ENTER** button.

From the iPod menu you can select from Music, Photo or Video playback, then select from tracks, playlists, pictures and movies that are stored on your iPod.

iPod repeat modes:

Press the **PLAY MODE** button on the remote control repeatedly to cycle through 'Repeat 1', 'Repeat All' or 'Repeat Off' modes on the iPod (the mode set will display on the iPod screen).

CHARGING AN iPod

When an iPod is docked and the unit is switched on, the iPod will begin to charge automatically.

NOTE:- The iPod will stop charging if the unit is set to Standby.

PLAYING VIA THE AUX JACK

To play music from an iPod or Personal Audio player connected to the AUX IN jack -

- Touch the **FUNCTION** touchpad repeatedly until 'AUX' is displayed (or press the **AUX** button on the remote control).
- Set the iPod or Personal Audio player to play.
- Turn the volume level on your Personal Audio player up to about half level.
- Set the volume on your audio system to the level you require. If the volume will not set high enough you may need to increase the volume setting on the player.

NOTE:- It is not possible to navigate the menu system of an iPod or other personal audio player with the remote control of the audio system if it is connected via the AUX IN jack.

EQ & BASS BOOST

You can change the equalisation of the sound or boost the level of bass to suit your taste.

To select an EQ response:

- Press the **EQ** button on the remote control repeatedly to cycle through the EQ options optimised as shown below.

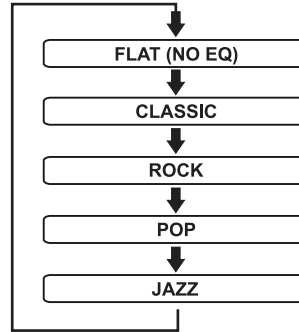

As each setting is selected, the sound EQ will change.

To select bass boost:

- Press the **BASS** button on the remote control to toggle bass boost (DBBS) on or off.

HEADPHONES

There is a headphone output socket on the back panel of the unit. If headphones are connected to this socket for private listening, the speakers will cut out automatically.

SETTING THE TIMER

Your system includes a timer that enables you to set times for the system to switch on and switch off automatically.

To set the timer:

- Press the **TIMER** button on the remote control to step through each stage in timer setting, shown in the sequence below.
- To make changes to a setting, press the ◀◀ or ▶▶ button.
- Press the **TIMER** button to confirm each setting and move on to set the next.

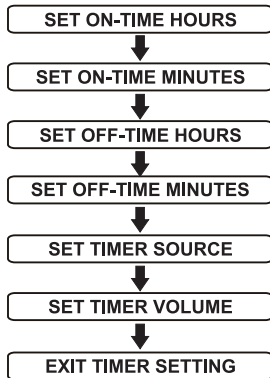

Activating the timer:

When timer setting is complete, the timer can be switched on or off by pressing the **TIMER** button.

The Timer symbol shows on the display when the timer is activated.

SLEEP MODE

THE SLEEP FUNCTION

The Sleep function allows you to program your system to switch itself off after a set period in 10 minute steps from 90 minutes down to 10 minutes.

To activate the Sleep function:

- Press the **SLEEP** button.
- The display will show Sleep 90.*
- Now press the **SLEEP** button repeatedly until your required sleep time (in minutes) appears on the display.

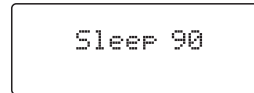

When sleep mode is set, the sleep symbol will appear on the display to confirm that sleep mode is set.

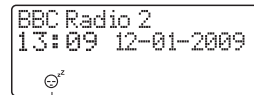

Sleep symbol

Your system will continue to play, then will set to Standby when the sleep time expires.

To check the Sleep time remaining:

- Press the **SLEEP** button during Sleep mode.

The Sleep time remaining will be shown on the display.

To cancel the Sleep function:

- Press the **SLEEP** button repeatedly until the sleep symbol disappears, or set the unit to Standby..

SYSTEM RESET

DAB is a terrestrial system and frequencies in different areas vary. If you move the radio to another part of the country performing a Full Scan may not be enough to re program the radio you may need to reset the radio.

To restore the factory settings:

- Set the system to DAB mode.
- Press and **hold** the **MEMORY/CLOCK** button on the front panel until the display flashes 'Factory Reset'.
- Press the ▶◀/SCAN button to confirm factory reset.

The unit will now scan for DAB broadcast stations in your area.

After reset the settings are returned to the factory defaults and all the presets are erased.

CARE AND MAINTENANCE

AFTER USING YOUR SYSTEM

- Set to Standby.
- Switch the unit off at the mains and unplug it if you are leaving it unattended for a long period (holidays etc).

CARE AND CLEANING

All care and cleaning operations should be carried out with the unit unplugged from the mains power.
Occasionally wipe the cabinet with a lint free duster. Never clean the unit with liquids or solvents.
Loudspeaker grilles can be cleaned carefully with a soft brush.

SPECIFICATIONS

SPECIFICATIONS

Supply Voltage :230 V~, 50Hz
Power Consumption20 W
Tuning Range FM87.5-108MHz
Tuning Range AM522-1620kHz
Net Weight:4.095 kg



Class II construction double insulated.
This product must not be connected to earth.



WARRANTY

Your Tesco appliance is covered by a warranty for 12 months from the date of purchase. If a fault develops during this period, please contact the TESCO electrical help line on 0845 456 6767. Please have your original purchase receipt with you when you call. This warranty in no way affects your consumer rights.



UK: Waste electrical products /batteries should not be disposed of with household waste. Separate disposal facilities exist, for your nearest facilities. See www.recycle-more.co.uk or in-store for details.

ROI: Produced after 13th August 2005. Waste electrical products/batteries should not be disposed of with household waste. Please recycle where facilities exist. Check with your Local Authority or retailer for recycling advice.

Technika

Tesco Stores Ltd,
Delamare Road, Cheshunt, Herts, EN8 9SL

► **Technika Helpline: 0845 456 6767** (Calls cost up to 4p per minute from a BT landline, other providers may vary)

MC4291D V0.1

Free Manuals Download Website

<http://myh66.com>

<http://usermanuals.us>

<http://www.somanuals.com>

<http://www.4manuals.cc>

<http://www.manual-lib.com>

<http://www.404manual.com>

<http://www.luxmanual.com>

<http://aubethermostatmanual.com>

Golf course search by state

<http://golfingnear.com>

Email search by domain

<http://emailbydomain.com>

Auto manuals search

<http://auto.somanuals.com>

TV manuals search

<http://tv.somanuals.com>