

**SUZUKI**

**Pianos**

**HP-97**

**DIGITAL UPRIGHT PIANO**



**OWNER'S MANUAL**

**SUZUKI**



# WELCOME!

We would like to express our appreciation and congratulate you for purchasing this Suzuki digital piano. With proper care this piano will provide you with years of musical enjoyment. Suzuki's Advanced State of the art electronics are combined with an elegant cabinet that will add beauty and sophistication to any home or studio environment. Some of the features your new piano is equipped with include:

- ◆ an authentic acoustic piano feel
- ◆ Suzuki's acclaimed stereo imaging sampling of the 30 acoustic instrument voices offering unmatched realism
- ◆ metronome feature with variable tempo to facilitate practice
- ◆ compact and dynamic sound delivery system
- ◆ three track recorder that allows you to record and playback your performances
- ◆ digital effects to further enhance the instrument voices
- ◆ over 50 prerecorded play along songs
- ◆ MIDI controls and compatibility
- ◆ audio outputs, and pedal and headphone jacks for versatile play

You will find many more features and functions listed within this owners manual. In order to make the most of your Suzuki Piano's performance potential and musical features, we suggest that you take a few minutes to read this owner's manual. After your manual review please store it in a safe place for later reference.



The Suzuki Piano Division includes portable keyboards, home and stage digital pianos, and the elegant digital grand ensembles plus the Suzuki Acoustic upright and grand piano models.

**SUZUKI**

# GENERAL PRECAUTIONS

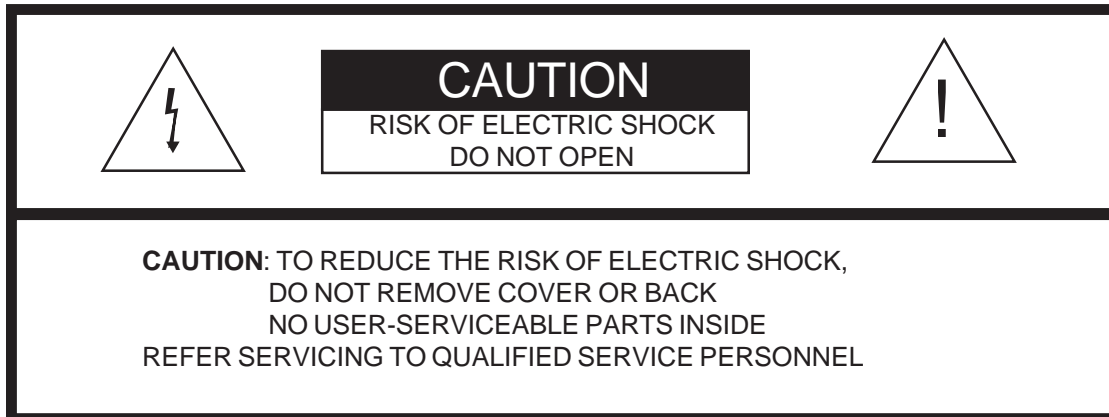

## INSTRUCTIONS PERTAINING TO A RISK OF FIRE, ELECTRIC SHOCK OR INJURY:

The lightning flash with arrowhead symbol, within an equilateral triangle, is intended to alert the user to the presence of uninsulated or “dangerous voltage” within the product’s enclosure that may be of sufficient magnitude to constitute a risk of electric shock to persons.

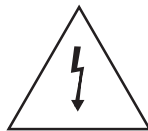

The exclamation point within an equilateral triangle is intended to alert the user to the presence of important operation and maintenance or servicing instructions in the manual accompanying the product.



1. **CAUTION:** Any changes or modifications in construction of this device which are not expressly approved by the party responsible for compliance could void the user’s authority to operate the equipment.
2. **NOTE:** This equipment has been tested and found to comply with the limit for a Class A digital device, pursuant to part 15 of the FCC rules. These limits are designed to provide reasonable protection against harmful interference when the equipment is operated in a noncommercial environment. This equipment generates, uses, and can radiate radio frequency energy and if not installed and used in accordance with the instruction manual, may cause harmful interference to radio communications. Operation of this equipment in a residential area is likely to cause harmful interference in which case the user will be required to correct the interference at his own expense.

# TAKING CARE OF YOUR DIGITAL PIANO

This Suzuki digital piano will supply you with years of musical enjoyment if you follow the simple rules listed below.

## SERVICE AND MODIFICATION

This product should be serviced by qualified service personnel when,

- ◆ the power supply cord or the plug has been damaged,
- ◆ liquid has been spattered into the unit or it has been exposed to rain,
- ◆ the instrument does not appear to operate normally or exhibits a marked change in performance,
- ◆ the instrument has been dropped or the cabinet has been damaged.
- ◆ Do not attempt to open the piano or make any change in the circuits or parts of the unit.

## HANDLING AND TRANSPORT

- ◆ Never apply excessive force to the controls, connectors or other parts of the instrument.
- ◆ Always unplug cables by gripping the plug firmly, not by pulling on the cable.
- ◆ Disconnect all cables before moving the instrument.
- ◆ Physical shocks caused by dropping, bumping, or placing heavy objects on the instrument can result in scratches and/or more serious damage.
- ◆ Carefully check the amplifier volume control before stating to play. Excessive volume can cause permanent hearing loss.

## CLEANING

- ◆ Clean the cabinet and panel with a dry soft cloth. A wax based polish may be used on the cabinet, although rubbing with a soft cloth will usually suffice. Do not use paint thinner or petrochemical based polishes.
- ◆ To maintain the luster of the keys and buttons wipe with a clean, lightly dampened cloth, and then polish with a soft dry cloth.

## LOCATION

Do not expose the instrument to the following conditions to avoid deformation, discoloration, or more serious damage,

- ◆ direct sunlight (near a window),
- ◆ high temperatures (near a heat source, outside, or in a car during the daytime),
- ◆ excessive humidity,
- ◆ excessive dust,
- ◆ strong vibration.
- ◆ Leave enough space around the piano for it to be properly ventilated.
- ◆ This instrument contains digital circuitry and may cause interference if placed too close to radio or television receivers. If interference occurs, move the instrument further away from the affected equipment.
- ◆ Avoid placing vinyl objects on top of the instrument, vinyl can stick to and discolor the surface.

## POWER

- ◆ Turn the power switch off when the instrument is not in use.
- ◆ To avoid damage to the instrument and other devices to which it is connected, turn the power switches of all related devices off prior to connection or disconnection of MIDI cables.
- ◆ Turn the power off if the main cable is damaged or the instrument is spattered with liquid.
- ◆ Do not switch the unit on and off in quick succession, this places an undue load on the electronic components.
- ◆ Unplug the AC power cord during an electrical storm.
- ◆ Avoid plugging the AC adaptor into the same AC outlet as appliances with high power consumption, such as electric heaters or ovens.

# TABLE OF CONTENTS

<b>EASY SET UP AND QUICK PLAY</b> .....	7
<b>ASSEMBLY</b> .....	8
HG-415 .....	8
HP-97 Furniture Stand .....	12
<b>PANEL CONTROLS</b> .....	15
<b>DEMO</b> .....	20
<b>KEYBOARD VOICES</b> .....	21
Voice Selection .....	21
Layer (dual) .....	22
Lower (split) .....	23
<b>FUNCTIONS</b> .....	24
Function Mode .....	24
Touch Mode .....	25
Metronome Volume .....	26
Split Point .....	26
Reverb Level .....	27
Chorus Level .....	27
Song Volume .....	28
Octave .....	28
Layer Octave .....	28
Lower Octave .....	28
Pedal Assign .....	29
Master Tune .....	29
Grade .....	30
<b>REGISTRATION</b> .....	31
<b>RECORD</b> .....	32
Recording .....	32
Playback .....	33
Erasing Tracks .....	34
<b>PLAY ALONG SONGS</b> .....	35
<b>MIDI</b> .....	37
<b>MIDI IMPLEMENTATION CHART</b> .....	38
<b>VOICE LIST</b> .....	39
<b>VOICE DESCRIPTIONS</b> .....	40
<b>CONNECTOR PANEL</b> .....	43
<b>PEDALS</b> .....	44
<b>SPECIFICATIONS</b> .....	45
<b>WARRANTY</b> .....	46

# EASY SET UP AND QUICK PLAY

EASY SET UP AND QUICK PLAY IN FOUR SIMPLE STEPS

**1**

**CHECK THE  
PACKAGE  
CONTENTS**

**2**

**ASSEMBLE THE  
PIANO STAND**

**3**

**PLACE THE PIANO  
ON THE STAND  
AND PLUG THE  
AC CORD INTO  
THE AC OUTLET**

**4**

**TURN THE POWER  
SWITCH ON,  
ADJUST THE  
VOLUME AND  
BEGIN TO PLAY**

# ASSEMBLY HP-97

## 1

### CHECK THE PACKAGE CONTENTS

**CHECK THE PACKAGE CONTENTS** - Please make sure your package contains the following items prior to assembly.

ITEM	QTY
1. PIANO .....	1
2. PEDAL BOARD CROSSPIECE .....	1
3. RIGHT LEG .....	1
4. LEFT LEG .....	1
5. BACK PANEL .....	6
6. PLASTIC SCREW COVERS .....	4
7. LEG/PEDAL BOARD SCREWS .....	4
8. HAND BOLTS .....	4
11. BACK PANEL SCREWS .....	10
12. AC POWER CORD .....	1



### STAND PIECES

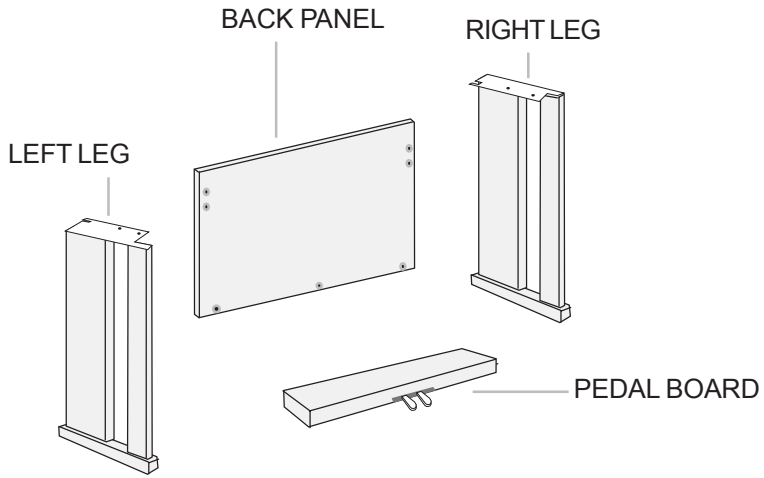



# ASSEMBLY HP-97

## 2

### ASSEMBLE THE PIANO STAND

#### LEG & PEDAL ASSY

#### ASSEMBLE THE PIANO STAND

**NOTE:** Do all your final tightening only after the assembly has been completed.

1. Attach the horizontal pedal assembly to the two legs. Use the four Leg Bolts.  
  
Insert the Leg Bolts up through the holes on the side leg and into the Pedal Assembly and tighten. Remembering to do all your final tightening only after the assembly is complete.

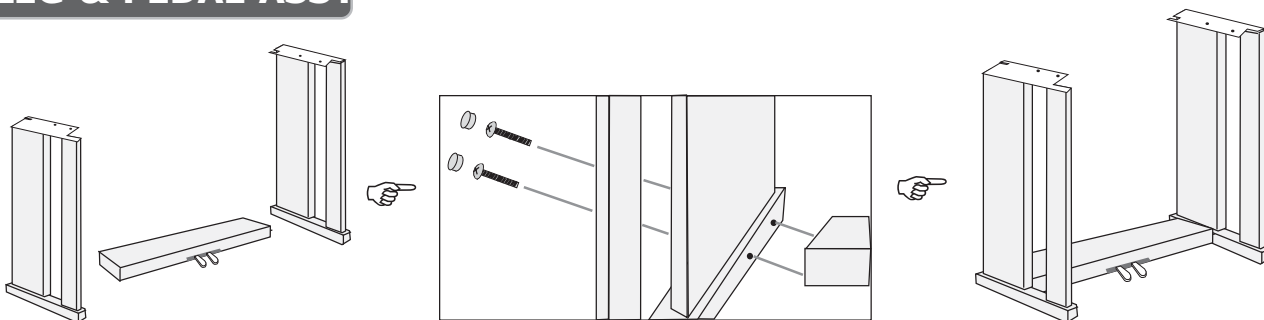

#### ASSEMBLE THE PIANO STAND

**NOTE:** Do all your final tightening only after the assembly has been completed.

2. Attach the Back Panel to the bracket on each of the two legs. Use four of the Back Panel Bolts to attach this piece.
3. Attach the Back Panel to the Pedal Board Assembly. Use five of the Back Panel Bolts to attach this piece.

#### BACK PANEL ASSY

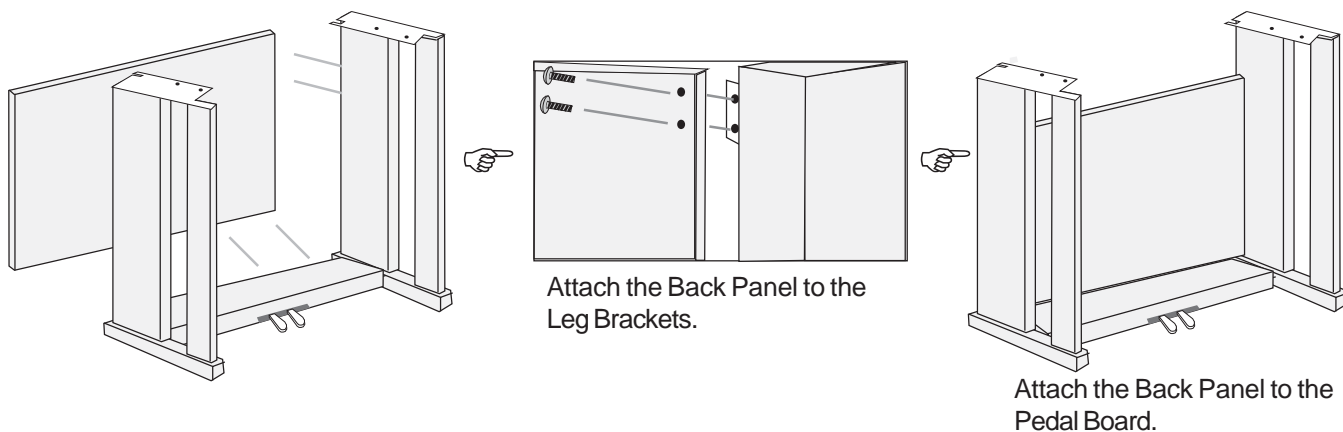

# ASSEMBLY HP-97

## 3

### PLACE THE PIANO ON THE STAND, ATTACH THE CABLES AND PLUG IN

4. Attach the piano to the stand using the four Hand Bolts.
5. Plug in the Pedal Board Cable located in the Pedal Board to the bottom, back portion of the bottom right hand side of the piano.
6. If everything is in its proper place then you should do all your final tightening now.

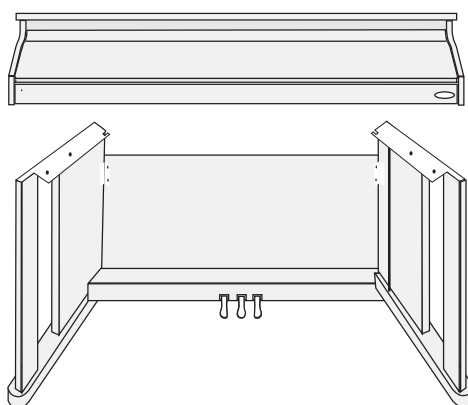

NOTE THE NOTCH IN THE LEG PLATE FITS AROUND THE HAND BOLT

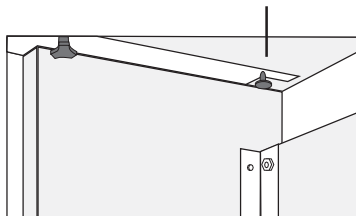

Attach the piano to the stand with the Hand Bolts.

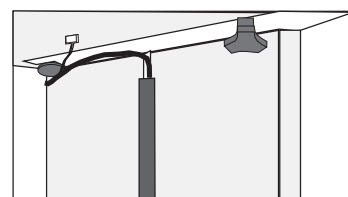

Plug in the Pedal Board Cable located in the Pedal Board to the bottom of the piano.

## 4

### PLUG IN, TURN ON, ADJUST THE VOLUME AND BEGIN TO PLAY

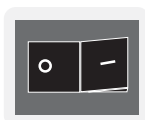

POWER

1. **PLUG IN THE AC CORD** - Plug the AC Cord into the AC Receptacle Jack on the back left portion of the panel. Then plug the AC cord into the 110V wall outlet.
2. **TURN THE POWER SWITCH ON** - Turn on the power switch located on the left side of the keyboard (O is off, and - is on). The display will welcome you and set the voice to Grand Piano automatically. The display will show "01: Grand Piano1".  
**NOTE:** When you turn the power off, do not turn the power back on immediately. Wait at least five seconds to turn the power back on so that the circuit can properly reset.
3. **SET THE VOLUME TO THE DESIRED SETTING** - Adjust the volume control to a comfortable level by sliding the Master Volume control left, for softer sound or right, for louder sound.

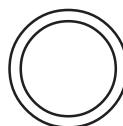

MIN MASTER VOLUME MAX

4. **BEGIN TO PLAY!**

# PANEL CONTROLS

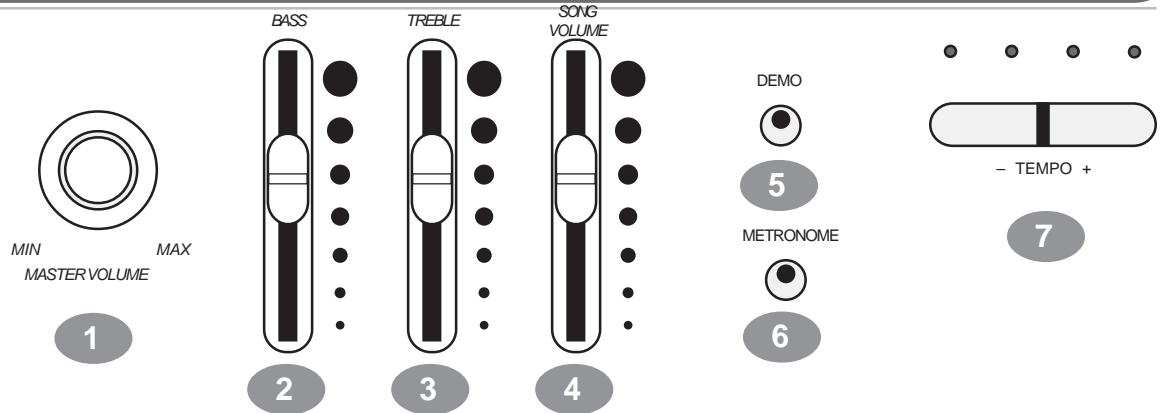

The elegant control panel is designed for simplicity of operation and is divided into several distinct sections. The following is a brief description of all the features located on the control panel.

- 1. MASTER VOLUME** - Use this rotary control button to adjust the overall volume of the keyboard.
- 2. BASS TONE CONTROL**- Slide this controller to adjust the bass tone level. To add more Bass to the overall tone of the sound delivery system slide the Bass control higher.
- 3. TREBLE TONE CONTROL**- Slide this controller to adjust the Treble tone level. To add more Treble to the overall tone of the sound delivery system slide the Treble control higher.
- 4. SONG VOLUME** - Slide this controller to adjust the volume of the built-in play along songs, the keyboard instrument voice will not be affected.
- 5. DEMO** - Press the DEMO button. The first demo song will play back instantly. This piano has ten different demonstration songs. To access an individual demo song press the +/YES or -/NO buttons when the Demo Feature is engaged. The Demo Songs will continue to play consecutively until the DEMO button or the PLAY/STOP button is pressed.  
**NOTE: HG-415** - this panel buttons are located at the far right end of the control panel
- 6. METRONOME** - Press the METRONOME button to engage the built-in metronome. Use the +/YES and -/NO buttons with the metronome engaged to choose the meter of your choice, 2/4, 3/4, 4/4 or 5/4 time.  
**NOTE: HG-415** - this panel buttons are located at the far right end of the control panel
- 7. TEMPO** - Press one of the TEMPO buttons, the current tempo value will appear on the display. You can use the TEMPO +, TEMPO – buttons, or the +/YES and -/NO buttons to change the tempo value range from 40 to 240 bpm (beats per minute). Press the TEMPO + or TEMPO – buttons or the +/YES and -/NO buttons simultaneously to recall the default tempo setting. After three seconds the display will revert to the selected voice. There is a four-dot beat indicator above the tempo buttons. It indicates the tempo and beat for the accompaniment that is playing.

# PANEL CONTROLS

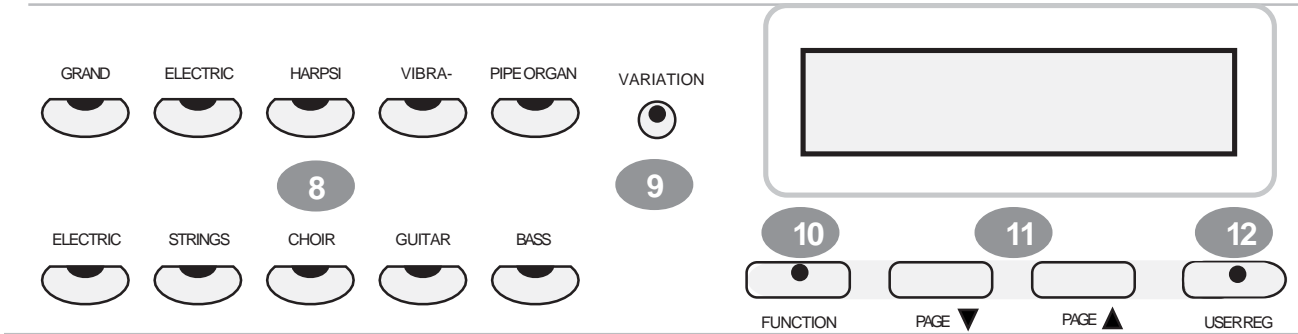

- 8. INSTRUMENT VOICE SELECT BUTTONS-** There are 10 instrument voices buttons and 30 instrument voices. You can instantly select an instrument voice by pressing one of the instrument voice select buttons. You can select the variation of the engaged voice by pressing the variation button. There is a total of 3 instrument voices per instrument voice button. There is a complete list of all 30 voices listed in the back of the manual. Please see the Voice section of this manual for more information.
- 9. VARIATION** - This button selects the variation of the initial instrument voice button sound. Pressing the VARIATION button one time turns the button LED green while pressing the button a second time turns the button LED red. Pressing the button a third time turns the button LED off. Green LED denotes the first variation of the initial voice selection. Red LED denotes the second variation of the initial voice selection. When the LED is off the initial voice selection is heard.
- 10. FUNCTION** - The FUNCTION button is used to access the function menu. The function menu can be used to adjust or change the parameters of a number of settings. The reverb level, chorus level, touch, split point for voice, split point, tuning etc. are all set from the function menu. Please see the Function section of this manual for more information.
- 11. PAGE** - The PAGE buttons (up and down) are used to access the different menus in the Function feature. When the FUNCTION button has been pressed use the PAGE Down or PAGE Up buttons to access the Function menu selections.
- 12. USER REG** - Registration is used to store keyboard settings. Press the USER REG button to engage the registration memory mode. There are two keyboard memory settings. See Registration Section of this manual for more information.

# PANEL CONTROLS

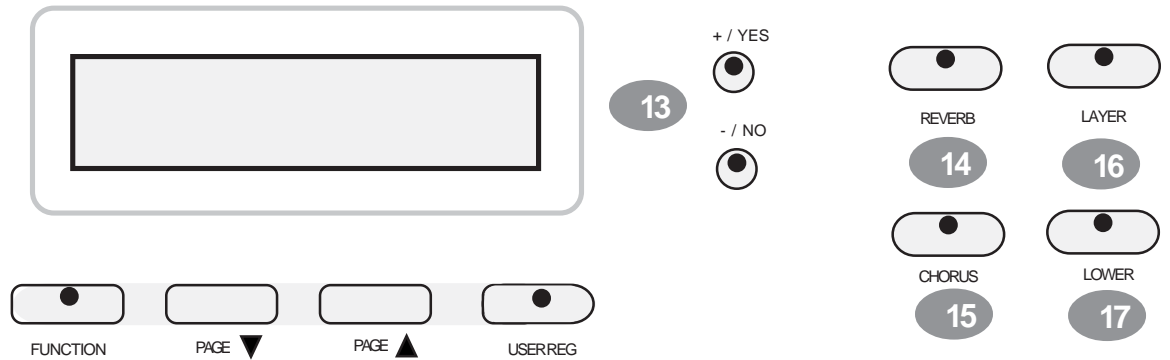

- 13. ENTER KEYS** - Use the +/YES, -/NO buttons directly while using the voice or function settings. These buttons are also used to access or alter many of the function features or when input is necessary.
- 13. REVERB** - The reverb effect is engaged automatically when the power is turned on. Reverb simulates the effect of playing in a big room or hall where the sound reverberates off the walls and ceiling. Press the REVERB button to turn off the reverb effect. You can switch the reverb feature on and off by pressing the REVERB button. Reverb depth can be changed in the function menu. Please see the Function Section for more information.
- 15. CHORUS** - The Chorus effect adds depth and spaciousness to the selected keyboard voice. Press the CHORUS button to engage the chorus effect and the indicator will light up. Press the button again to turn off the chorus effect. Chorus depth can be changed in the function menu. Please see the Function Section for more information.
- 16. LAYER** - Engaging the LAYER button will put the keyboard in the layer mode. Layer refers to an additional voice that is "tone mixed" with the selected keyboard voice. The assigned layer voice will be heard together with the original voice. To select a new layered instrument voice use the +/YES or -/NO buttons within 3 seconds after the LAYER button has been engaged.
- 17. LOWER** - With the Lower feature engaged the keyboard operates in the "split" mode. In the Lower mode the keyboard is divided into two sections. In the right hand section the original and/or layered voice will sound, and in the left hand section a different voice can be assigned to sound when the keys are played. To select a new Lower instrument voice use the +/YES or -/NO buttons within three seconds after the LOWER button has been engaged.

# PANEL CONTROLS

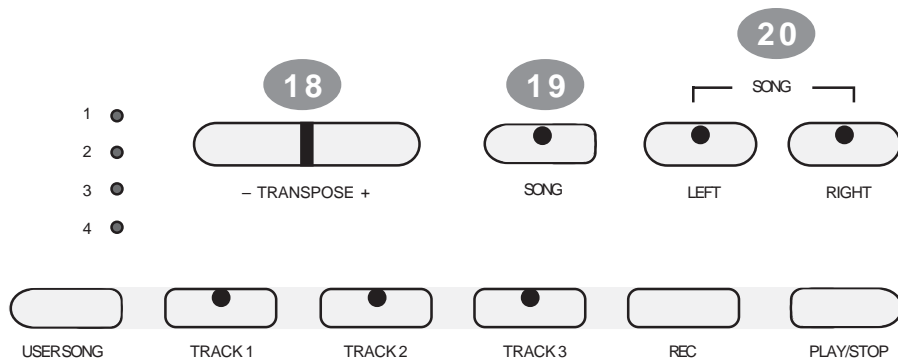

- 18.** **TRANPOSE** - The transpose feature can shift the pitch of the keyboard up or down in semitone intervals up to a maximum of 24 semitones. Press one of the TRANSPOSE buttons, the current transpose value will appear on the display. Use the TRANSPOSE + or TRANSPOSE – buttons to set the transpose value range from –12, one octave lower, to 12, one octave higher. Press the + and – Transpose value buttons simultaneously to recall the default value of 0. After three seconds the display will return to the currently selected instrument voice.
- 19.** **SONG** - This “Play Along Songs” or “Music Teacher” feature can be used as an aid to learn the 50+ songs built into this piano. The SONG button turns the “music teacher” function on and off. Please see the Play Along Song section of this manual for more information.
- 20.** **LEFT , RIGHT** - These buttons are used in conjunction with the SONG button. It allows the player to play along with the prerecorded traditional songs contained within this piano. The LEFT button will play the right hand of the selected song, so that the user can practice the Left Hand portion of the song. The RIGHT button will play the Left Hand of the selected song, so that the user can practice the Right Hand portion of the song. When engaging the LEFT and RIGHT buttons simultaneously only the metronome count will sound and the user should play both the Left and Right portions of the selected song. Please see the Play Along Song section of this manual for more information.

# PANEL CONTROLS

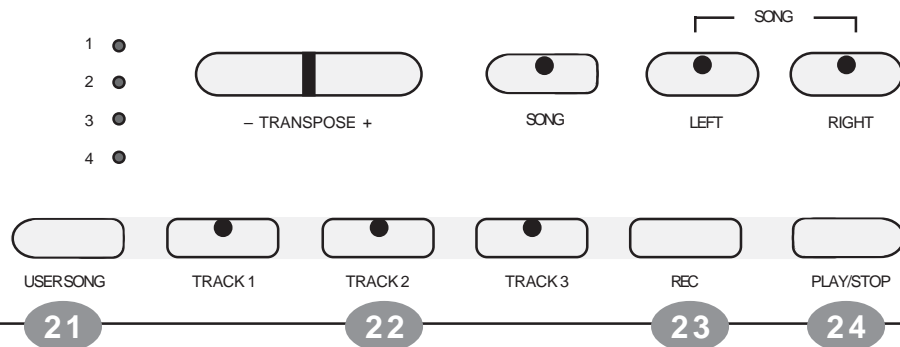

- 21. USER SONG** - The USER SONG button accesses one of the four available song settings for recording or playback. Use the +/YES, -/NO buttons to select the song you wish, if there is recorded information on any of the three tracks their indicator lights will light up. Please see the Record section of this manual for more information.
- 22. TRACK 1, TRACK 2 AND TRACK 3** - There are three tracks for recording your performance for each song composition. These tracks are assigned by the TRACK 1/2/3 buttons. Please see the Record section of this manual for more information.
- 23. REC** - This unit is able to record four songs, each with 3 tracks. It will record all note events as they are performed. This recorded information is nonvolatile and therefore will not be lost when the power is turned off. To Record press and hold down the RECORD button then press the track button you want to record in. Recording begins as soon as you start to play on any section of the keyboard. Press the RECORD or PLAY/STOP button again to stop recording. Please see the Record section of the manual for more information.
- 24. PLAY/STOP** - Press the PLAY/STOP button to hear selected tracks that you have recorded. Press the PLAY/STOP button again to stop the playback. Please see the Record section of this manual for more information.

# DEMO

**PLAYING THE DEMONSTRATION SONGS** - This piano has ten different demonstration songs that are designed to showcase the different sampled voices that are available. The display will show the song number with a “d” prefix. When playing all the songs, “ALL” will appear on the display initially, and will change to the demo song number as it plays. After exiting the demonstration mode the display will revert to its initial default instrument voice LCD display.

**NOTE HG-415** LCD displays two character lines but in this same character style format.

DEMO



1. **PLAY ALL DEMO SONGS** - Press the DEMO button. The first demo song will playback instantly. This unit has ten demo songs. All songs will then play repeatedly until you press the DEMO button again to stop the demonstration.

ALL:Demo Song

2. **PLAY A SINGLE DEMO SONG** - Use the +/YES or the –/NO buttons to change songs while the demo is playing. The selected Demo songs will play consecutively until you press the DEMO button or the PLAY/STOP button to stop.

DEMO



+ / YES



- / NO



ALL:Demo Song

There are 50+ play along songs that can also be played back for demonstration. Please see the Play Along Song section of this manual for more information.



# KEYBOARD VOICES

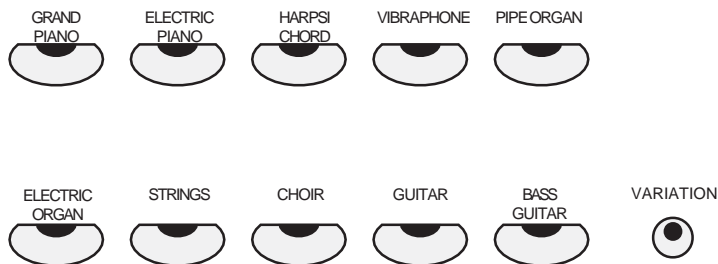

## INSTRUMENT VOICES

Each instrument voice has its own sound quality and texture. Therefore there may be instances where certain voices depending on the various settings could cause the sound delivery system to make a slight distortion or buzzing sound. This is normal and can be adjusted by changing the volume, digital effects (Reverb or Chorus) or Touch sensitivity settings.

**VOICE SELECTION** - There are 30 instrument voices and 10 sound button groups. The complete list of all 30 voices is in the back of this manual.

**QUICK SELECT INSTRUMENT VOICES** - There are ten voices that can be selected quickly by pressing one of the ten voice select buttons. Each one of these Instrument Voice Buttons has three instruments related to that sound group. You can access the other instrument voices by using the VARIATION Button or by pressing the +/YES or the -/NO Buttons.

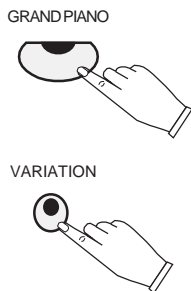

## SELECTING ONE OF THE 30 INSTRUMENT VOICES

1. Press the VOICE Select Button that correspond to the group of instrument voices that you would like to play. The main instrument voice of the selected Sound Group Button will be shown on the LCD display.
2. Press the VARIATION Button to access the other two instrument voices that are available in the Voice Select Button that you have engaged. Every time the Variation Button is pressed the Name of the Instrument Voice on the LCD Display will be changed.



**Note:** When pressing the VARIATION Button one time the Variation Button LED will be **GREEN** indicating the first variation of the original instrument voice. When pressing the button a second time the Variation button LED will be **RED** indicating the second variation of the original instrument voice. When the Variation Button LED is **OFF** the original Voice Select Button instrument voice can be heard.

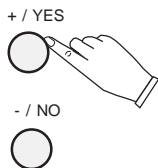

## USE +/YES OR -/NO TO SELECT INSTRUMENT VOICES

1. Press the +/YES or -/NO Buttons to cycle through all 30 instrument voices. Holding either button down will auto repeat the cycle through all 30 voices.

# KEYBOARD VOICES

## LAYER VOICE

**LAYER (DUAL) VOICE** - Layer, or dual, refers to an additional voice that is “tone mixed” with the originally selected keyboard voice. The assigned layer voice will be heard with the original voice when the layer feature is engaged.

### TO USE THE LAYER FUNCTION

1. Press the LAYER button, the currently assigned Layer voice will be shown on the display, and the LED indicator will turn on.
2. Use the +/YES, –/NO buttons or the Quick Select Voice Buttons to select the desired Layer voice.  
**NOTE:** The LCD display will show the layer voice number and name, after three seconds the display will revert to the originally selected main voice.
3. Press the LAYER button again and the LCD display will show the current volume setting for the LAYER Function.
4. Press the LAYER button again to turn the LAYER function off.

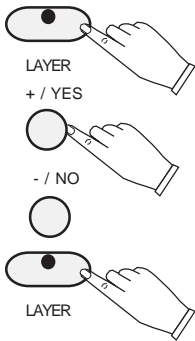

### TO SELECT A DIFFERENT VOICE FOR THE LAYER FUNCTION

1. Press the LAYER button, the currently assigned Layer voice will be shown on the display, and the LED indicator will turn on.
2. Use the +/YES, –/NO buttons or the Quick Select Voice Buttons to select the desired Layer voice.  
**NOTE:** You must select the +/YES, –/NO buttons or the Quick Select Voice Buttons within the three second period that the LAYER voice is displayed on the LCD screen or else the originally selected LAYER voice will remain engaged.



### TO CHANGE THE VOLUME OF THE LAYER VOICE

1. Press the LAYER Button - Its LED will turn on.
2. Press the LAYER Button a second time and the current Layer Volume level is shown on the Display LCD.  
**NOTE:** This Layer Volume setting will be displayed on the LCD screen for three seconds.
3. While the Layer Volume screen is displayed, use the +/YES or the –/NO Buttons to raise or lower the volume of the selected Layer Instrument Voice. The LCD Display Screen will show Volume Setting.

### TO ADD REVERB TO LAYER VOICE

1. Press the FUNCTION Button - Its LED will turn on.
2. Press the PAGE Down Button - Until Layer Reverb (LayerRev.Lvl) is shown on the Display LCD.
3. Press the +/YES Button to display the current Layer Reverb Level and then press the +/YES or the –/NO Buttons to raise or lower the Layer Reverb level of the selected Layer Instrument Voice.

### TO ADD CHORUS TO LAYER VOICE

1. Press the FUNCTION Button - Its LED will turn on.
2. Press the PAGE Down Button - Until Layer Chorus (LayerCho.Lvl) is shown on the Display LCD.
3. Follow step 3 listed above to change the Current Layer Chorus Levels.

# KEYBOARD VOICES

## LOWER VOICE

**LOWER VOICE** - In the lower, or split, mode the keyboard is divided into two separate sections. To the right of the Split Point the currently selected main voice, or the layered and main voice will sound. The keys to the left of the Split Point can play a different instrument voice.

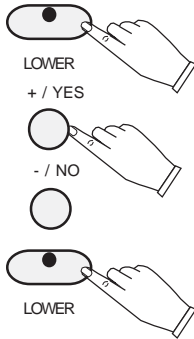

### TO USE THE LOWER FUNCTION

1. Press the LOWER button, the currently assigned Lower voice will be shown on the display, and the LED indicator will turn on.
2. Use the +/YES, -/NO buttons or the Quick Select Voice Buttons to select the desired Lower voice.  
**NOTE:** The LCD display will show the Lower voice number and name, after three seconds the display will revert to the originally selected main voice.
3. Press the LOWER button again and the LCD display will show the current volume setting for the Lower Function.
4. Press the LOWER button again to turn the Lower function off.

### TO SELECT A DIFFERENT VOICE FOR THE LOWER FUNCTION

1. Press the LOWER button, the currently assigned Lower voice will be shown on the display, and the LED indicator will turn on.
2. Use the +/YES, -/NO buttons or the Quick Select Voice Buttons to select the desired Lower voice.  
**NOTE:** You must select the +/YES, -/NO buttons or the Quick Select Voice Buttons within the three second period that the Lower voice is displayed on the LCD screen or else the originally selected Lower voice will remain engaged.

### TO CHANGE THE VOLUME OF THE LOWER VOICE

1. Press the LOWER Button - Its LED will turn on.
2. Press the LOWER Button a second time and the current LOWER Volume level is shown on the Display LCD.  
**NOTE:** This Lower Volume setting will be displayed on the LCD screen for three seconds.
3. While the Lower instrument voice volume is displayed on the LCD screen, use the +/YES or the -/NO Buttons to raise or lower the volume of the selected Lower Instrument Voice. The LCD Display Screen will show the Volume Setting.

### TO ADD REVERB TO LOWER VOICE

1. Press the FUNCTION Button - Its LED will turn on.
2. Press the PAGE Down Button - Until Lower Reverb (LowerRev.Lvl) is shown on the Display LCD.
3. Press the +/YES Button to display the current Lower Reverb Level and then press the +/YES or the -/NO Buttons to raise or lower the Lower Reverb level of the selected Lower Instrument Voice.

### TO ADD CHORUS TO LOWER VOICE

1. Press the FUNCTION Button - Its LED will turn on.
2. Press the PAGE Down Button - Until Lower Chorus (LowerCho.Lvl) is shown on the Display LCD.
3. Follow step 3 listed above to change the Current Lower Chorus Levels.

# FUNCTIONS

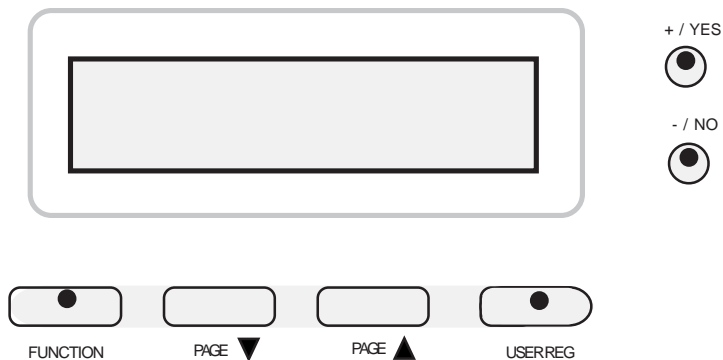

The Function mode is used to set up or to adjust various parameters related to the operation of this keyboard. With the FUNCTION button engaged you may access the menu for the Touch, Metronome Volume, Split Point, Reverb level, Layer Reverb Level, Lower Reverb Level, Chorus level, Layer Chorus Level, Lower Chorus Level, Song Volume, Octave, Layer Octave, Lower Octave, Pedal Assign, Master Tune and Grade selections.

In the pages that follow each of these functions controls will be explained.

## FUNCTION MODE

### USING THE FUNCTION PARAMETER MENU

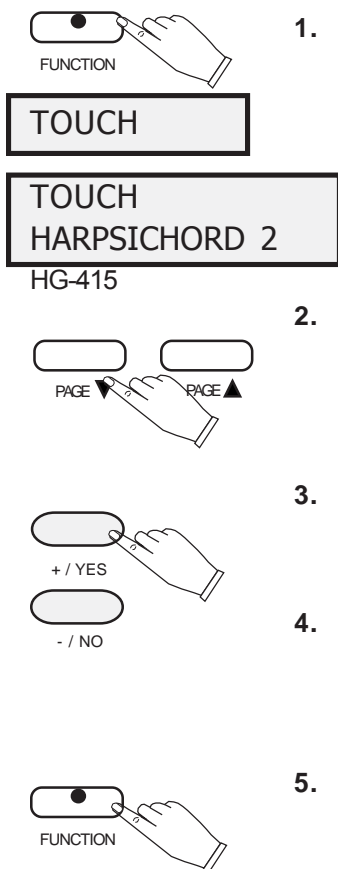

1. Press the FUNCTION button. The first menu item that can be manipulated will appear on the display and the Function LED indicator will turn on.
2. Press the PAGE ▲ or the PAGE ▼ buttons until the menu you wish to access appears on the LCD display screen.
3. Press the +/YES button to show the current parameter for your selected function.
4. Press the +/YES or the –/NO buttons to adjust the parameter.  
**Note:** Pressing the +/YES and the –/NO buttons simultaneously will recall the default setting.
5. To exit this Mode Press the FUNCTION button. It's indicator LED will turn off.

# FUNCTIONS

## TOUCH MODE

This Keyboard offers four types of keyboard touch sensitivity settings: Soft, Normal, Hard and Fixed. These are also known as Velocity sensitivity settings and can help you to suit this keyboard to your playing style. The Normal setting is selected automatically when the piano is turned on.

**Hard** is the most sensitive keyboard response which permits maximum sound levels with a light touch.

**Normal** is an intermediate response suitable for most styles of music. Normal is the default setting.

**Soft** is a less sensitive keyboard response which requires a heavier touch to obtain maximum sound levels.

**Fixed** does not offer any touch sensitivity. Each key plays at full volume no matter how hard the piano key is hit. It is commonly used on Harpsichord and Organ voices.

### USING THE TOUCH SENSITIVITY PARAMETER

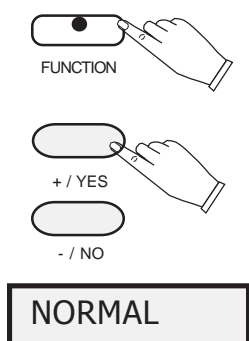

1. Press the FUNCTION button. The Function LED indicator will turn on. The first menu item is Touch which appears on the LCD display.
2. Press the + / YES button to show the Touch Sensitivity setting that is currently engaged.
3. Press the + / YES or the - / NO buttons to change the Touch Sensitivity setting that is currently engaged.
4. Play the Keyboard to confirm that your currently selected Touch setting is correct for your performance.
5. To Exit the Function mode press the FUNCTION button. The Function LED indicator will turn off.

# FUNCTIONS

## METRO VOLUME

The Metronome Volume control function has a range from 00 - 24. The Metronome is engaged and its meter is selected by pressing the METRONOME Control Panel Button.

**NOTE: HG-415** LCD will display two character lines that list both Metro Mode and the currently selected instrument voice.

### USING THE METRO VOLUME PARAMETER

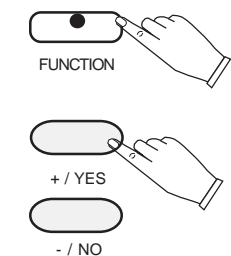

1. Press the FUNCTION button. The Function LED indicator will turn on. The first menu item is Touch which appears on the LCD display.
2. Press the Down Arrow Page button to show the METRO VOLUME on the LCD screen.
3. Press the +/YES to display the current Metro Volume Setting.
4. Press the +/YES or the –/NO buttons to change the Metro Volume setting that is currently engaged.
5. To exit the Function mode press the FUNCTION button. The Function LED indicator will turn off.

## SPLIT POINT

When the Lower mode is engaged the keyboard is divided into two parts at the split point. In the right hand section the original (and Layer voice - if engaged) will sound. In the left hand section a new instrument voice can be assigned, the lower voice. The split point location for the Keyboard can be changed. Its range is from G1 - C7.

**NOTE: HG-415** LCD will display two character lines that list both Split Point Mode and the currently selected instrument voice.

### CHANGING THE SPLIT POINT SETTING

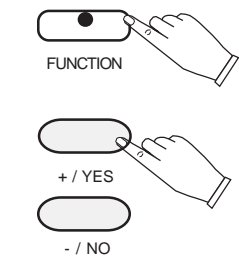

1. Press the FUNCTION button. The Function LED indicator will turn on. The first menu item is Touch which appears on the LCD display.
2. Press the Down Arrow PAGE button twice to show the Split Point on the LCD screen.
3. Press the +/YES to display the current Split Point Setting.
4. Press the +/YES or the –/NO buttons to change the Split Point setting that is currently engaged.
5. To exit the Function mode press the FUNCTION button. The Function LED indicator will turn off.

# FUNCTIONS

## REVERB LEVEL

**REVERB LEVEL SETTING** - Reverb simulates the effect of playing in a big room or hall where the sound reverberates off the walls and ceiling. The reverb effect is engaged automatically when the power is turned on. You can switch the reverb feature on and off by pressing the REVERB button. Select the level of reverb from the Function menu. It's range is from 1 -16.

### USING THE REVERB LEVEL PARAMETER

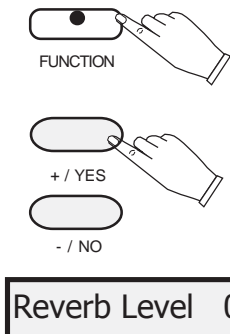

1. Press the FUNCTION button. The Function LED indicator will turn on. The first menu item is Touch which appears on the LCD display.
2. Press the Down Arrow PAGE button three times to show Reverb Level on the LCD screen.
3. Press the +/YES to display the current Reverb Level Setting.
4. Press the +/YES or the –/NO buttons to change the Reverb Level setting that is currently engaged.
5. To exit the Function mode press the FUNCTION button. The Function LED indicator will turn off.

#### Layer Reverb Level

#### Lower Reverb Level

Please follow the steps listed above to alter the current Reverb Level on these voice channels.

Further information on these functions is located in the Layer and Lower sections of this manual.

## CHORUS LEVEL

**CHORUS LEVEL SETTING** - The Chorus effect enriches your selected instrument voice by adding depth and texture.

Press the CHORUS button to engage the chorus effect, the indicator will light up. Adjust the level of chorus in the Function menu. It's range is from 1 - 16.

### USING THE CHORUS LEVEL PARAMETER

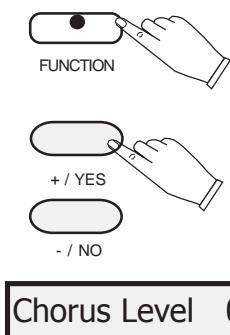

1. Press the FUNCTION button. The Function LED indicator will turn on. The first menu item is Touch which appears on the LCD display.
2. Press the Down Arrow PAGE button six times to show Chorus Level on the LCD screen.
3. Press the +/YES to display the current Chorus Level Setting.
4. Press the +/YES or the –/NO buttons to change the Chorus Level setting that is currently engaged.
5. To exit the Function mode press the FUNCTION button. The Function LED indicator will turn off.

#### Layer Chorus Level

#### Lower Chorus Level

Please follow the steps listed above to alter the current Chorus Level on these voice channels.

Further information on these functions is located in the Layer and Lower sections of the this manual.

# FUNCTIONS

## SONG VOLUME

**SONG VOLUME** - The Song Volume function mode is used strictly as a numerical volume level display. It is not adjustable from the +/YES or -/NO Buttons. It is adjustable only by the Song Volume Slider Control located next to the Bass and Treble sliding controls.

When the Song Volume Function Mode is engaged the LCD screen will show the numerical value of the Song Volume when the Song Volume Slider Control is moved to the left or to the right.

## OCTAVE

**OCTAVE SHIFT** - The Octave Shift function will shift the keyboard note value up or down in entire Octave increments. The range is 2+ to 2- from normal Keyboard note values, where 0 is for normal pitch.

You may want to use this 88 note Octave Shift on certain instrument voices whose frequency ranges differ from the 88 note Acoustic Piano.

### USING THE OCTAVE FUNCTION

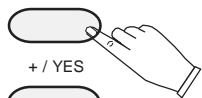
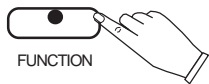

Octave 0

1. Press the FUNCTION button. The Function LED indicator will turn on. The first menu item is Touch which appears on the LCD display.
2. Press the Down Arrow PAGE button until you see Octave on the LCD screen.
3. Press the +/YES to display the current Octave Setting.
4. Press the +/YES or the -/NO buttons to change the Octave Level and move the keyboard note values up or down by one Octave. Octave range is from 2 to -2.
5. To exit the Function mode press the FUNCTION button. The Function LED indicator will turn off.

## LAYER OCTAVE

**LAYER OCTAVE** - The Layer Octave Shift function will shift the keyboard note value up or down in entire Octave increments for the selected Layer Instrument Voice only. Depending on which voice you have selected it may sound better if one of the voice was Octave Shifted.

Follow steps 1-5 listed above to activate the Layer Octave Shift Function.

## LOWER OCTAVE

**LOWER OCTAVE** - The Lower Octave Shift function will shift the Lower keyboard note value up or down in entire Octave increments for the selected Lower Instrument Voice only.

Depending on which voice you have selected it may sound better or it may be easier to play if the voice shifted up or down by one or two Octaves.

Follow steps 1-5 listed above to activate the Lower Octave Shift Function.



# FUNCTIONS

## PEDAL ASSIGN

**LEFT PEDAL FUNCTION MODE** - This function sets the left pedal for normal soft pedal operation or for song Play/ Stop. The Play / Stop selection will allow the player to use the Left Pedal as a control "START/ STOP" button.

### CHANGING THE PEDAL FUNCTION SETTING

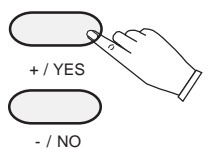
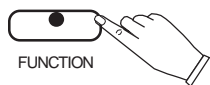

Pedal Assign

1. Press the FUNCTION button. The Function LED indicator will turn on. The first menu item is Touch which appears on the LCD display.
2. Press the Down Arrow PAGE button 13 times to show Pedal Assign on the LCD screen.
3. Press the +/YES to display the current Left Pedal Assignment Setting.
4. Press the +/YES or the –/NO buttons to change the Left Pedal Assignment. You can choose from standard Soft Pedal or Play/Stop. The Play / Stop selection will allow the player to use the Left Pedal as a START/STOP button
5. To exit the Function mode press the FUNCTION button. The Function LED indicator will turn off.

## MASTER TUNE

**MASTER TUNE** - The pitch of this piano is very accurate and stable, it is automatically set to standard A440 pitch when the piano is turned on. The tuning feature makes it possible to tune the pitch of the instrument in fine intervals. If necessary, you can alter the piano pitch. Tuning can be accomplished over –50 to +50 semitone steps, or cents.

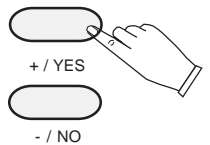

Master Tune 00

### USING THE MASTER TUNE FUNCTION

1. Press the FUNCTION button. The Function LED indicator will turn on. The first menu item is Touch which appears on the LCD display.
2. Press the Down Arrow PAGE button 14 times to show Master Tune on the LCD screen.
3. Press the +/YES to display the current Master Tune Setting.
4. Press the +/YES or the –/NO buttons to change the Master Tune Setting. The range is from -50 to 50.
5. To exit the Function mode press the FUNCTION button. The Function LED indicator will turn off.

# FUNCTIONS

## GRADE

**GRADE** - The GRADE feature of this piano turns the Vocal Grading of the of the Play Along Song feature On or Off. The Vocal Grading feature can only function when the Song Mode is engaged. The Vocal Grading instructor grades on the following scores:

0 - 40% of notes correct and Vocal Instructor will say "Try Again."

41 - 60% of notes correct and Vocal Instructor will say "Good."

61 - 85% of notes correct and Vocal Instructor will say "Very Good."

86- 100% of notes correct and Vocal Instructor will say "Excellent."

### USING THE GRADE FUNCTION

1. Press the FUNCTION button. The Function LED indicator will turn on. The first menu item is Touch which appears on the LCD display.
2. Press the Up Arrow PAGE button 1 time to show Grade on the LCD screen.
3. Press the +/YES to display the current Grade Setting.
4. Press the +/YES or the -/NO buttons to change the Grade Setting. The range is either On or Off.
5. To exit the Function mode press the FUNCTION button. The Function LED indicator will turn off.
6. Press the Song button. The Song LED indicator will turn on. The first song is ALLEGRO which appears on the LCD display.
7. Press the +/YES to Select the song that you want to play along with.
8. Press the LEFT, RIGHT or both LEFT and RIGHT Buttons (depending on which part of the song you which to practice/play - see the Song section of this manual for more information). Their indicator LED's will turn on.
9. Press the PLAY/STOP button to begin the selected Play Along Song. At the end of the song the vocal instructor will announce your grade.

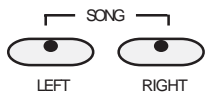
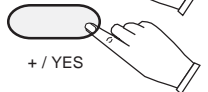
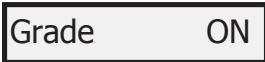
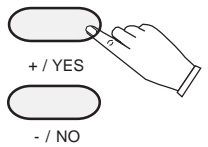

# REGISTRATION

The registration feature offers two memory spots to save your keyboard settings for you to recall at a later time. You can store the desired settings in one button and recall them instantly when needed.

## SAVE REGISTRATION

### USING THE SAVE REGISTRATION FUNCTION

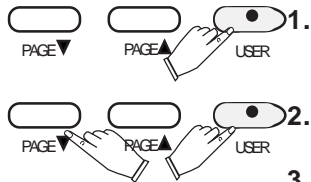

b-1:Store



**NOTE:** To store a second set of your keyboard settings follow steps 1-3 as shown above but instead press the PAGE UP button. The LCD display will show b-2: Store.

## RECALL REGISTRATION

### USING THE RECALL REGISTRATION FUNCTION

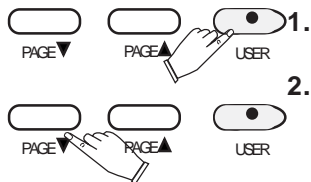

b-1:RegisterBank

# RECORD

- 1 ●
- 2 ●
- 3 ●
- 4 ●



This piano features a three track recorder that let you record what you play on the keyboard and then play it back. Three Tracks mean that you can “overdub” one part on top of another, using a different voice if you like. The recorder feature is a useful adjunct to any keyboard study program, since it lets you hear exactly how you sound from the listener’s perspective. It can also be just plain fun.

This Recorder is able to store four songs, each with up to a 3-track recording. This recorded information is nonvolatile and therefore will not be lost when the power is turned off. All 3 tracks can playback separately or together as a complete song.

The Record function records all settings exactly as you engaged and performed them.

## RECORD

- 1 ●
- 2 ●
- 3 ●
- 4 ●

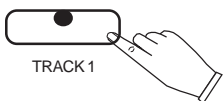
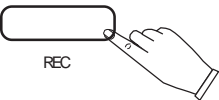
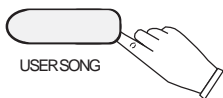

### USING THE RECORDING FEATURE-

1. **Prepare** - Prepare to record by setting the voice, reverb level, octave shifts etc. or other parameters as desired.
2. **Select a Song** - Press the USER SONG button, and use the +/YES, -/NO buttons to select a song, the LED display above the User Song button will show the song number selected. This is where the recorded information will be stored.
3. **Select a track** - There are three tracks available for recording, these are assigned by engaging the TRACK 1, TRACK 2 or TRACK 3 button.

Press and hold down the REC button, then press the track button that you want to record in. The corresponding track indicator LED will blink, and the four dots of the beat indicator will blink with the current Metronome tempo, to show that the recorder is on standby.

**NOTE:** If you already have a recorded track(s) in the selected song, that Track indicator LED will also be lit and the recorded music will play, as a reference for you while you record the new track. If you do not wish for previously recorded tracks to play while you are recording, press the corresponding track button to turn the indicator light off.



**BE AWARE:** Be careful not to hold the REC button down while deselecting a track as that will put that track on Record standby, and immediately erase the existing data from your previous recording.



# RECORD

## RECORDING (continued)

### 4. Record on Track 1, 2 or 3

If the Track LED 1, Track LED 2 or Track LED 3 is selected and blinking the recording will begin as soon as you play the keyboard.

**Note:** the contents in a track will be erased as soon you start to record on that selected track.

It will be replaced by the new note data that you are recording.

### 5. Stop Recording - Press the PLAY/STOP button or the REC button to stop recording.

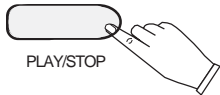

**NOTE:** When the record memory is full, recording will stop automatically and "End" will appear on the display screen.

Expressed in terms of notes, the total number of notes which can be recorded in all three Tracks is about 4500 (The number of notes may be reduced if operations such as depressing the pedal are carried out.)

## PLAYBACK

- 1 ●
- 2 ●
- 3 ●
- 4 ●

**PLAYBACK** - To listen to the passage that you just recorded press the PLAY/STOP Button.

### TO LISTEN TO THE RECORDED USER SONG

1. Press the USER SONG button to select the song you want to play back. Each time you press the USER SONG button the LED above the Button will indicate which song is selected, and the LCD display will show the User Song number.
2. After you have selected your desired User Song, the Track LED indicators will be engaged.  
If you do not wish to hear any of the 3 Tracks, press the corresponding TRACK button to turn that track off.  
It's LED indicator will turn off.
3. Press the PLAY/STOP button to hear the recorded track(s).  
The LED dots of the beat indicator will flash in consecutive order.  
You can change the tempo of your Recorded Track by pressing the +TEMPO- buttons while the recording is being played back.  
You may also accompany the recorded playback on the keyboard while the recording is playing back.
4. Press the PLAY/STOP button to stop the playback.  
Playback will stop automatically when the recording reaches its end.
5. Press the USER SONG button to exit the User Song Mode. The User Song indicator LED's will turn off after USER SONG 4.

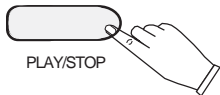
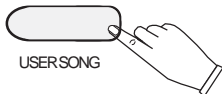

# RECORD

## ERASING TRACKS

- 1 ●
- 2 ●
- 3 ●
- 4 ●

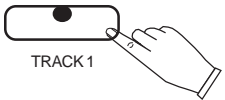
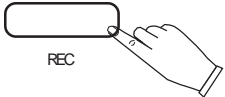
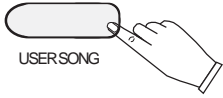

**ERASING TRACK INFORMATION** - To Erase the recorded passage on Track 1, Track 2 or Track 3.

### TO ERASE THE MUSIC RECORDED ON TRACK 1/2/3

1. Press the USER SONG button to select the song you want to Erase. Each time you press the USER SONG button the LED above the User Song Button will indicate which is selected. Also the LCD display will show the User Song number.
2. Press and Hold the REC button down.
3. Press the TRACK button that you which to Erase while you continue to hold down the REC button, to put that track on Record standby. This will immediately erase the existing data from your previous recording.
4. Repeat Step 2 and Step 3 until all the Tracks that you desire are Erased.
5. When the Track has been properly Erased its Track Button LED will not turn on when the USER SONG button is pressed. This indicates that this is no Recorded information on this Track.

# PLAY ALONG SONGS



There are over 50 songs built into this piano for your musical enjoyment. These songs have separate left and right hand parts that can be turned on and off as required so you can practice the corresponding part on the keyboard. The Right - hand part is played by selecting the LEFT Button in the Song Section of the control panel. The Left-hand part is played by selecting the RIGHT Button in the Song Section of the control panel.

You can change the song by pressing the +/YES , -/NO buttons.

## PLAY ALONG SONGS

### USING THE PLAY ALONG SONG FEATURE TO LISTEN TO THE ENTIRE SONG

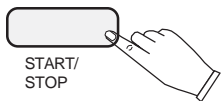
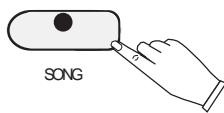

1. Press the SONG button.  
The first song number and abbreviated name of the song will appear on the LCD display.  
Use the +/YES, -/NO buttons to select a song.
2. Press the PLAY/STOP button to hear the both hand parts playing the entire song.

### USING THE SONG FEATURE TO PRACTICE THE RIGHT HAND OF THE SELECTED SONG

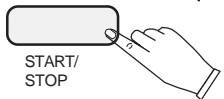
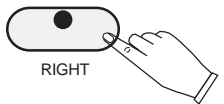
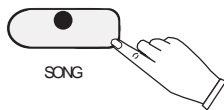

1. Press the SONG button.  
The Song LED will turn on.
2. Press the RIGHT button.  
The Right LED will turn on.
3. Press the PLAY/STOP button.  
You will hear the metronome "count in" the song.  
You will then hear the left hand part of your selected song.
4. Play the right hand melody part of your selected song while the left hand part plays.
5. After the song finishes it will automatically repeat unless the PLAY/STOP button is pressed or the Song Function is disengaged.



**NOTE:** If the Grading function is engaged you will hear the vocal grade of "Try Again", "Good," "Very Good" or "Excellent." To turn off this Function enter the Function mode. For more information see the Function Section of this manual.

### USING THE SONG FEATURE TO PRACTICE THE LEFT HAND OF THE SELECTED SONG

1. Follow steps 1-5 listed above - substituting the LEFT button whenever RIGHT button is mentioned.

# PLAY ALONG SONGS

## PLAY ALONG SONGS

### PRACTICE THE LEFT AND RIGHT HAND OF THE SELECTED SONG

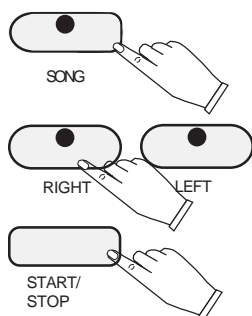

1. Press the SONG button.  
The Song LED will turn on.
2. Press the RIGHT and LEFT buttons.  
The Right and Left LED's will turn on.
3. Press the PLAY/STOP button.  
You will hear the metronome "count in" the song.
4. Play the right and left hand parts of your selected song.  
If it is necessary you can turn on Metronome on to assist in keeping time.
5. After the song finishes it will automatically repeat unless the PLAY/STOP button is pressed or the Song Function is disengaged.

## VOCAL GRADING

Check your progress - You can set this piano to offer a vocal grade at the completion of your play along song performance.

If the Grading function is engaged you will hear the vocal grade of "Try Again", "Good," "Very Good" or "Excellent." To turn off this Function enter the Function mode.

0 - 40% of notes correct and Vocal Instructor will say "Try Again."

41 - 60% of notes correct and Vocal Instructor will say "Good."

61 - 85% of notes correct and Vocal Instructor will say "Very Good."

85- 100% of notes correct and Vocal Instructor will say "Excellent."

### USING THE GRADING FEATURE TO CHECK YOUR PRACTICE PROGRESS

1. Follow steps listed in the Functions Section under "Using the grading function" of this manual to enable the Vocal Grading Function.



# MIDI

MIDI stands for Musical Instrument Digital Interface. This is a world wide standard communication interface that enables electronic musical instruments and computers (of all brands) to communicate with each other so that instructions and other data can pass between them. This exchange of information makes it possible to create a system of MIDI instruments and devices that offers far greater versatility and control than is available with isolated instruments. Whether you interface with computers, sequencers, expanders or other keyboards your musical horizons will be greatly enhanced. For further information on MIDI and MIDI equipment that is available, please contact your local **Suzuki** music store.

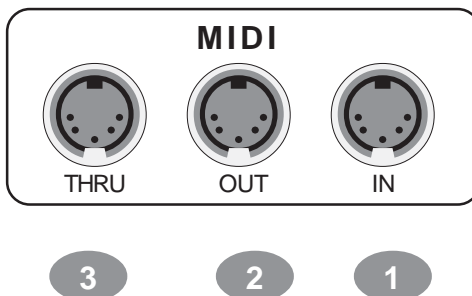

**MIDI CONNECTION** - The MIDI terminals are located on the left side panel of the piano.

1. **MIDI In:** This terminal receives MIDI data from an external MIDI device.
2. **MIDI Out:** This terminal transmits data from this instrument to other MIDI devices. The transmitted data includes the note and touch velocity produced while playing on the keyboard, as well as voice changes, wheel operation, and recorded playback for the melody tracks. Demo songs and auto accompaniment are not transmitted.
3. **MIDI Thru** - This terminal transfers data from the IN terminal directly to other MIDI devices.

**For more information regarding transmitted MIDI data please see the next page and or the MIDI implementation chart.**

**MIDI CHANNELS** - The MIDI system in this unit has 16 channels numbered from 1-16. Each of the channels is responsible for a voice. When the instrument receives from an external device, the active channel is determined by the control message. The transmission channels on this keyboard are fixed as follows:

Channel 1: Master voice

Channel 2: Layer voice

Channel 3: Split voice

Please see the MIDI Implementation Chart for more detail.

For further MIDI setup options please see your local Suzuki Music Store.

# MIDI IMPLEMENTATION CHART

Function	Transmitted	Recognized	Remark
Basic Channel	1 CH	1-16 CH	
Channel changed	1-16 CH	1-16 CH	
Default Mode	3	3	
Note	9-120	0-127	
Number : True Voice	*****	0-127	
Velocity: Note On	●	●	
Velocity: Note Off	X	●	
Pitch Bender	●	●	
Control Change: 0	●	X	Variation page
1	X	X	Modulation
5	X	X	Portamento value
7, 10	●	●	Volume, Pan
11	X	●	Expression
64, 66, 67	●	●	Sustain. Sostenuto, Soft Pedal
65	X	X	Portamento yes/no
80, 81	●	●	Reverb, Chorus program
91	●	●	Reverb, Chorus send level
98, 99	X	X	NRPNL, NRPHH
100, 101	X	X	RPNL, RPNH
121	●	●	Reset all controllers
123	●	●	All notes off
Program	●	●	
Change : True#	*****		
System Exclusive	X	X	
Sys. Common: Song Select	X	X	
Sys. Common: Song Position	X	X	
System: Clock	X	X	
Real Time: Commands	X	X	

Mode 1: OMNI ON, POLY  
 Mode 2: OMNI ON, MONO  
 Mode 3: OMNI OFF, POLY  
 Mode 4: OMNI OFF, MONO

## VOICE LIST

Piano #	Instrument Name	LCD Display	MIDI #
01	Grand Piano	Grand Piano	00
02	Bright Grand Piano	Bright Piano	01
03	Honky-Tonk Piano	Honky-Tonk	03
04	Rhodes Piano	RhodesPiano	04
05	Electric Piano 2	Elec.Piano2	05
06	Synth Piano	Synth Piano	54
07	Harpsichord 1	Harpschord1	08
08	Harpsichord 2	Harpschord2	08
09	Clavichord	Clavichord	07
10	Vibraphone 1	Vibraphone 1	11
11	Vibraphone 2	Vibraphone 2	11
12	Glockenspiel	Glockenspiel	09
13	Pipe Organ 1	Pipe Organ1	19
14	Pipe Organ 2	Pipe Organ2	19
15	Pipe Organ 3	Pipe Organ3	20
16	Jazz Organ 1	Elec.Organ1	17
17	Jazz Organ 2	Elec.Organ2	17
18	Rock Organ	Rock Organ	19
19	String Ensemble	StringEnsb1	48
20	Slow String Ensemble	SlowStrings	49
21	Synth Strings	Synth String	50
22	Choir Aahs	Choir Aahs	52
23	Choir Oohs	Choir Oohs	53
24	Synth Voice	Synth Voice	54
25	Acoustic Nylon	Guitar Nylon Guitar	24
26	Acoustic Steel Guitar 1	SteelGuitar1	25
27	Acoustic Steel Guitar 2 with Harmonic	SteelGuitar2	25
28	Acoustic Bass 1	AcousticBass	32
29	Acoustic Bass with Hi Hat	Bass&Hi Hat	32
30	Fretless Bass	FretlessBass	35

# VOICE DESCRIPTIONS

Each of the 30 instrument voice samples on this piano are described below to offer both information ideas on how to use them.

## **01 Grand Piano**

This is a 6' Bosendorfer Grand Piano. The stereo piano sample of this world class piano was taken in Paris, France. Perfect for classical compositions as well as any other style that requires acoustic piano.

## **02 Bright Grand Piano**

This is a 7 foot Grand Piano sampled with popular music in mind. This piano is great for Elton John and rhythmic playing. The sound is crisp and spacious. The 3D samples were taken from the position of the player at Sony studios L.A.

## **03 Honky Tonk Piano**

The same samples as 02 but detuned and chorused. The perfect ragtime piano.

## **04 Rhodes Piano**

A very natural Rhodes warm and rich with slight vibrato. Great for 70s ballads and R&B. The samples were taken from a vintage Fender Rhodes piano. The same instrument which was used on the famous pop/rock song "Dreamweaver".

## **05 Electric Piano 2**

An electronic piano sound created by FM synthesis. This sound is useful for popular music as well as smooth Jazz.

## **06 Synth Piano**

Same as 04 with an added synth pad. Lush and bright great for pop ballads and for adding textures to your accompaniment.

## **07 Harpsichord 1 - single string**

This authentic Italian Harpsichord is the definitive instrument for Baroque music. The 3D samples were taken from the position of the player at Sony studios L.A.

## **08 Harpsichord 2 - double string**

This authentic Italian Harpsichord is the definitive instrument for Baroque music. The 3D samples were taken from the position of the player at Sony studios L.A.

## **09 Clavinet**

The Hohner Clavinet is great for Stevie Wonder "Superstition" and rhythmic "funky" playing.

## **10 Vibraphone 1**

A wonderful instrument for Jazz and smooth Jazz. These amazing 3D samples are taken from the position of the player

# VOICE DESCRIPTIONS

## **11 Vibraphone 2 - vibrato**

Same as 10 but with the typical mechanical vibrato sound.

## **12 Glockenspiel**

Christmas and Mozart. The sweet and tender tone of these 3D samples will enchant your audience.

The 3 Pipe Organ patches have been selected to cover most organ music.

## **13 Pipe Organ 1**

This is a warm organ stop consisting of Principals and Flaute useful for accompaniment.

## **14 Pipe Organ 2**

This is a full tutti Principal stop with 16, 8, 4, and 1 1/3 pipes. This massive stop is great for Bach's "Tocatta and Fugue".

15 a sweet Flaute Mixture, great for sensitive pieces and Christmas music.

## **15 Pipe Organ 3**

The 3D samples were taken from the big organ at the Baylor University in Waco, Texas.

## **16 Jazz Organ**

Made for Jazz solos and accompaniment. The sound has the typical Hammond key clicking and a slow Leslie effect.

## **17 Jazz Organ 2**

Same texture as 16 but with a fast Leslie effect.

## **18 Rock Organ**

Great for Emerson, Lake and Palmer, Rock and Pop music. The Hammond organ was run through tube distortion and a tube Leslie.

## **19 String Ensemble**

Velocity attack strings good for fast string lines in pop and classical music.

The 3D samples reflect the seating positions of the players in a real orchestra and also contain the typical natural vibrato of string instruments. The basses are to the right, cellos are center right, violas center and violins to the center left and left.

## **20 Slow String Ensemble**

Same as 19 with a slow attack. Beautiful for ballads and warm pads.

## **21 Synth Strings**

A great sound for pop ballads and slow tunes. The samples contain warm analog synth components as well as FM sound with a slight filter sweep.

# VOICE DESCRIPTIONS

## **22 Choir AAhs**

Mixed choir with an emphasis on Baritones. Spacious 3D samples great for pads and ballads.

## **23 Choir OOhs**

Mixed choir with an emphasis on Baritones. Velocity adds a "DOOO" articulation. Played softly it makes for wonderful voice pads and accompaniments. Very 3D stereo!

## **24 Synth voice**

22 and 23 mixed to form a OOO - AAAh effect.

## **26 AcousticNylon String**

Great for musical styles from country to classical. A beautifully engineered guitar sample.

## **26 Acoustic Steel String**

For music from Pop to Country.

## **27 Acoustic Steel String With Harmonic**

For music from Pop to Country. This voice adds a guitar string harmonic when piano key is played hard.

## **28 Acoustic Bass 1**

Walk it for Jazz!

## **29 Acoustic Bass with Ride Cymbal**

Great for Bee Bop and Blues.

## **30 Fretless Bass**

Warm electric bass sound for pop and ballads.

# CONNECTOR PANELS

HP-97: These connector jacks are located on the back of the piano.

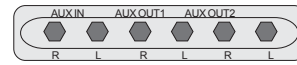
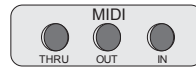

- MIDI IN / MIDI OUT /MIDI THRU** - This piano contains MIDI in/out/thru ports. MIDI jacks allow communication with other products equipped with MIDI interfaces. Please see the MIDI section of this manual for further details.
- AUX LINE IN** - This left and right stereo audio input jacks allows the user to play external audio equipment such as CD player or Expander Module etc. through the pianos sound delivery system.
- AUX LINE OUT (1 & 2)** - This left and right stereo audio output jacks supplies the piano's output signal to external amplification (with or without speaker output).
- PHONE 1 / PHONE 2** - You can play in total silence, without disturbing others in the room, by plugging a set of headphones into one of the appropriate sockets located on the left side of the piano. When headphones are plugged into either of these jacks the main speaker system is turned off. Two sets of headphones may be used. These headphone jacks are located directly under the piano on the left side of the piano.
- A/C RECEPTACLE JACK** - Plug the supplied A/C cord into bottom of piano for this A/C Receptacle Jack



# PEDALS

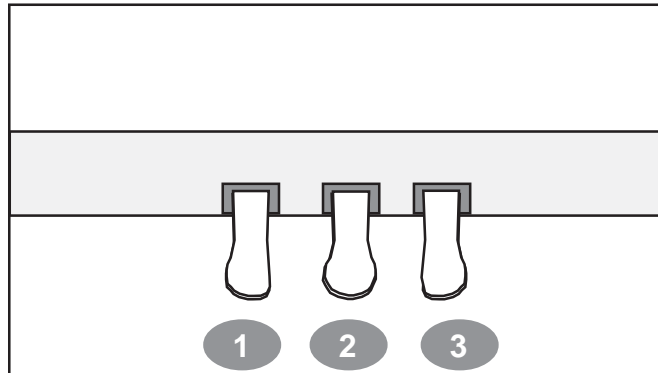

## PEDALS

1. **SOFT PEDAL** - When the left pedal is engaged the piano volume is reduced and the timbre slightly altered on the notes that are played.
2. **FUNCTION PEDAL** - This center pedal can be used to trigger various events, such as start/stop. Pedal function is assigned in the setup menu, "Pedal Assign". Please see the Setup section of this manual for more information.
3. **SUSTAIN PEDAL** - When the right pedal is engaged all volumes of the keys as they are played will decay gradually as if you were continuing to hold down the piano keys.



# SPECIFICATIONS

## SPECIFICATIONS

### KEYBOARD

88-note, hammer-action keyboard

POLYPHONY: 64

### VOICES

30 Voices

### VOICE MODE

Layer (dual) voice

Lower (split) voice

### VOICE EFFECTS

Reverb

Chorus

Octave

### SETUP

Power: On/Off

Main Volume Control: Min-Max

Bass EQ Control: Min-Max

Treble EQ Control: Min-Max

Song Volume Control: Min-Max

INPUT BUTTONS: +/YES, -/NO

DISPLAY: HP-97:16 Character LCD

REGISTRATION MEMORY: 2

DEMONSTRATION: Ten songs,

RECORDING: Four songs, 3 track recording

### OVERALL CONTROL

Transpose

Tempo

Touch response: soft, normal, hard, fixed

Voice split point

### FUNCTION

Metronome

Reverb level

Chorus level

Touch Sensitivity

Split point for voice

Master Tune

### AUXILIARY JACKS

Headphone x 2

Aux. In

Aux. Out x 2

Power In

MIDI In/Out/Thru

### PEDALS

Sustain Pedal

Auxiliary Pedal (sostenudo)

Soft Pedal

VOLTAGE: AC 120V INPUT

AMPLIFIER: 60W x 2

### DIMENSIONS

HP-97: 55" W x 21" D x 35.5" H

WEIGHT: HP-97: 165 LBS. INCLD. STAND

### STANDARD ACCESSORIES

AC Cord

Owner's manual

# WARRANTY

**This product, except the exterior cosmetic parts, is warranted by the Suzuki Corporation to the original purchaser to be free from defects in material and workmanship under normal use as follows:**

- 1. For a period of one year from the date of purchase, the Suzuki Corporation will pay the labor charges to repair the defective product. After this one year period, you must pay all labor charges.**
- 2. In addition, the Suzuki Corporation will supply, at no charge, new or rebuilt replacements for defective parts for a period of one year from the date of purchase.**

**In the event repairs are needed, the original purchaser will return the product to an Authorized Suzuki Retail Center with the original proof of purchase.** The dealer will then repair the product or return it to the Suzuki distribution center in San Diego, California for repairs. Upon completion of the repair, the unit will be returned to the music store freight prepaid. This warranty will not apply to this product if it has been misused, abused, or altered. This warranty is void if the product has been opened. Without limiting the foregoing, bending, dropping of unit, or visible cracks and/or scratches are presumed to be defects resulting from misuse or abuse.

Neither this warranty nor any other warranty expressed or implied, including implied warranties of merchantable, shall extend beyond the warranty period. No responsibility is assumed for any incidental or consequential damages.

**In the United States Contact:**

Suzuki Corporation  
San Diego Distribution Center  
P.O. Box 261030  
San Diego, CA 92196

**In all other Countries Contact:** Original retailer where product was purchased for additional warranty details.

# NOTES

# SUZUKI

DIGITAL UPRIGHT PIANO

## HP-97

OWNER'S MANUAL



**SUZUKI**

P.O. BOX 261030  
SAN DIEGO, CALIFORNIA 92196  
(858) 566-9710

Visit us on the web at [www.suzukipianos.com/hp-97](http://www.suzukipianos.com/hp-97)

Copyright Suzuki Musical Instrument Corporation

## Free Manuals Download Website

<http://myh66.com>

<http://usermanuals.us>

<http://www.somanuals.com>

<http://www.4manuals.cc>

<http://www.manual-lib.com>

<http://www.404manual.com>

<http://www.luxmanual.com>

<http://aubethermostatmanual.com>

Golf course search by state

<http://golfingnear.com>

Email search by domain

<http://emailbydomain.com>

Auto manuals search

<http://auto.somanuals.com>

TV manuals search

<http://tv.somanuals.com>