

Sunbeam

Artista

Pump espresso machine with
stainless steel thermoblock

Instruction Booklet
EM5900

Please read these instructions carefully
and retain for future reference.



Contents

Sunbeam's Safety Precautions	2
About espresso coffee	3
Features of your Sunbeam Artista	4
Using the control panel	7
Reference guide to using your espresso machine	10
Preparing your espresso machine before use	15
Guide to the perfect espresso	16
Guide to milk texturing	18
Using the hot water function	19
Espresso Recipes	20
Care and Cleaning	22
Descaling	24
Advanced programming options	26
Trouble shooting guide	30

Important instructions – retain for future use.

تأكد من تفهم احتياطات السلامة المذكورة اعلاه

請務必理解上述的安全預防措施。

Assurez-vous que les précautions ci-dessus relatives à la sécurité sont bien comprises

Versichern Sie sich daß die obenstehenden Sicherheitsmaßnahmen Verstanden werden

Βεβαιώνετε πως οι παραπάνω προφυλάξεις ασφαλείας γίνονται κατανοητές

Pastikan bahwa tindakan-tindakan keselamatan seperti di atas dimengerti anda

Accertatevi che le suddette norme di sicurezza siano comprese a dovere

上記の注意事項をよくお読みになり、安全を御確認ください

Уверете се дека погоре споменатите мерки на претпазливост се добро разбрани

Asegúrese de que las precauciones de seguridad precedentes sean bien comprendidas

کاری بکنید کہ احتیاطهای بالا حتماً درک بشوند

ต้องแน่ใจว่า ข้อควรระวังเรื่องความปลอดภัยข้างต้น เป็นที่เข้าใจกันดี

Yukarda belirtilen güvenlik önlemlerinin anlaşılığundan emin olunuz

Xin kiểm chắc rằng những biện pháp làm an toàn kể trên được hiểu rõ

Sunbeam's Safety Precautions

SAFETY PRECAUTIONS FOR YOUR SUNBEAM ESPRESSO MACHINE.

- Always place the unit on a flat, level surface.
- Do not operate without water in reservoir. Fill reservoir with only clean and cold water. Observe the maximum filling volume is 2.5 litres.
- Do not remove the filter handle during the espresso pour or water flow as the unit is under pressure. Removing the filter handle during either of these operations can lead to a scalding or injury.
- The steam wand becomes very hot during texturing milk and water flow. This may cause

burns in case of contact, therefore avoid any direct contact with the steam wand.

- Always disconnect the plug from the power outlet prior to cleaning the espresso machine or if there is any problem during the coffee making process.
- Do not allow the power cord to come into contact with the hot parts of the espresso machine, including the cup warming plate and steam wand.
- Do not place hands directly under the steam, hot water or coffee pour as this can lead to a scalding or injury.

Sunbeam is very safety conscious when designing and manufacturing consumer products, but it is essential that the product user also exercise care when using an electrical appliance. Listed below are precautions which are essential for the safe use of an electrical appliance:

- Read carefully and save all the instructions provided with an appliance.
- Always turn the power off at the power outlet before you insert or remove a plug. Remove by grasping the plug - do not pull on the cord.
- Turn the power off and remove the plug when the appliance is not in use and before cleaning.
- Do not use your appliance with an extension cord unless this cord has been checked and tested by a qualified technician or service person.
- Always use your appliance from a power outlet of the voltage (A.C. only) marked on the appliance.
- Close supervision is necessary when your appliance is being used by children or infirm persons.

- Young children should be supervised to ensure that they do not play with the appliance.
- Never leave an appliance unattended while in use.
- Do not use an appliance for any purpose other than its intended use.
- Do not place an appliance on or near a hot gas flame, electric element or on a heated oven. Do not place on top of any other appliance.
- Do not let the power cord of an appliance hang over the edge of a table or bench top or touch any hot surface.
- Do not operate any electrical appliance with a damaged cord or after the appliance has been damaged in any manner. If damage is suspected, return the appliance to the nearest Sunbeam Appointed Service Centre for examination, repair or adjustment.
- For additional protection, Sunbeam recommend the use of a residual current device (RCD) with a tripping current not exceeding 30mA in the electrical circuit supplying power to your appliances.
- Do not immerse the appliance in water or any other liquid unless recommended.

If you have any concerns regarding the performance and use of your appliance, please visit www.sunbeam.com.au or contact the Sunbeam Consumer Service Line.

Ensure the above safety precautions are understood.

About espresso coffee

Congratulations on the purchase of your Sunbeam Artista espresso machine.

The mastery of coffee making demands a machine that you can trust to perform time and time again. Powered by a one-piece stainless steel lined thermoblock and an Italian designed and manufactured 15 BAR pump, the espresso machine will deliver the performance a true artist and coffee connoisseur has come to expect.

The Sunbeam Artista makes producing espresso coffees at home a pleasure with its simple to use push button operation. Seamlessly integrated technology monitors and controls the thermoblock heating system to achieve the precise temperature required for each task, whether you are extracting espresso, texturing milk or brewing tea.

Designed and engineered to last, the components and features of the Sunbeam Artista are encased in full metal housing, accentuated by a polished chrome brew head. The elegant styling and craftsmanship employed in its design draw inspiration from the tradition of European espresso machine quality and design. Now you can bring the art of coffee making into your home with the Sunbeam Artista.

We hope you enjoy your new espresso machine and should you need any further assistance, please do not hesitate to contact the Sunbeam Coffee Hotline on 1300 881 861.

Features of your Sunbeam Artista

Warming plate

Effectively pre-warms up to 9 espresso cups

Push button control panel

Easy to use control panel delivers an espresso pour, steam or hot water functions.

Group head

Brass and phenolic filter handle

Extra cup height clearance

Additional clearance between the filter handle and the drip tray is designed to suit taller cups.

Water level indicator

The water level indicator floats through the drip tray grid indicating how full the drip tray is. The indicator is coloured red for easy identification.

Measuring spoon / Tamp

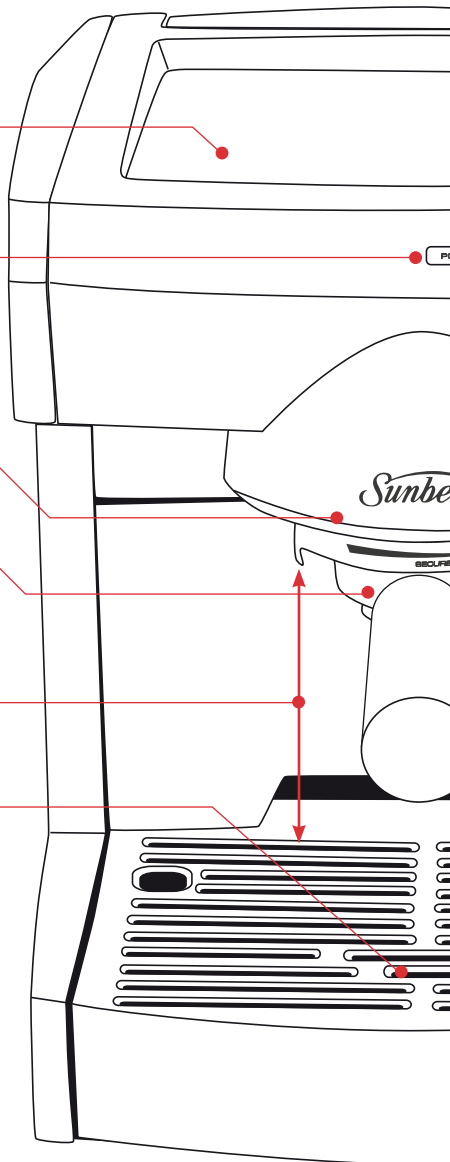
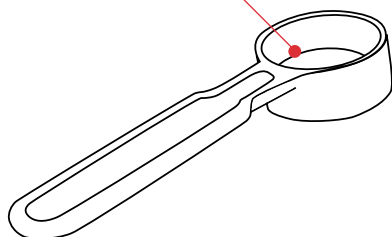

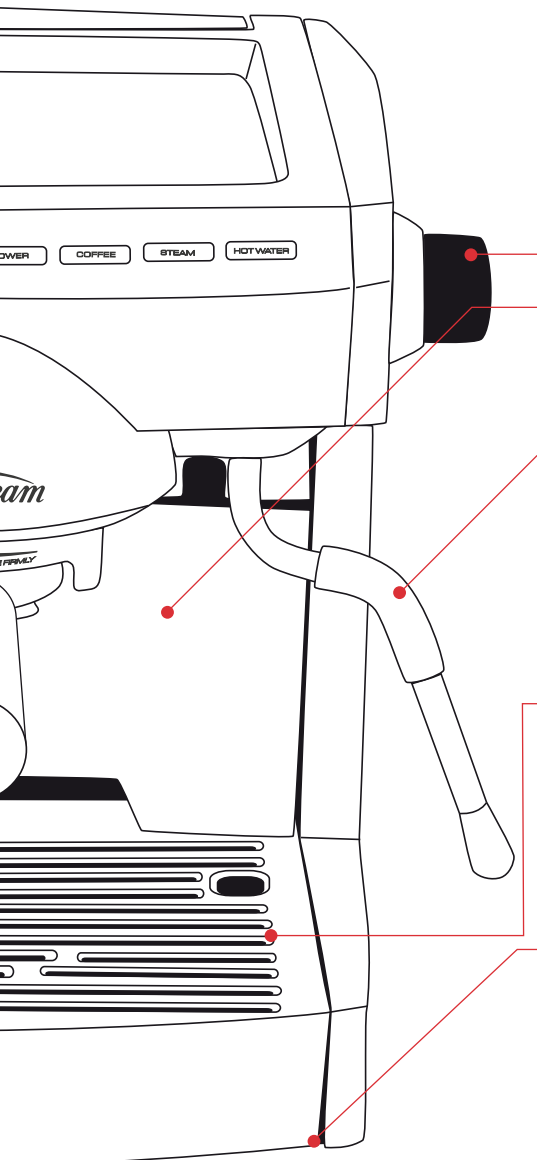

Steam and hot water control dial

2.5L water reservoir

Removable from the front for easy filling at the tap. Water can also be added at the top of the unit.

Steam and hot water wand

Supplies powerful dry steam for achieving silky, dense and rich milk. Also dispenses a controlled flow of hot water. The commercial 360° ball joint allows the steam wand to be moved into the ideal position.

Removable drip tray and grill

The large capacity die-cast metal drip tray is lined with plastic, preventing staining from espresso oils, lightweight for easy removal and designed with no dirt traps for simple wipe down cleaning.

Non-slip rubber feet

Makes the unit sturdy, preventing it from slipping or scratching the benchtop.

600ml jug

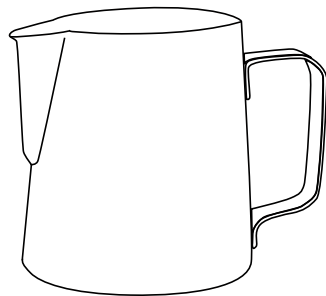

Cleaning tool



Single filter basket

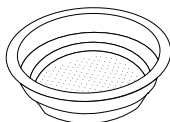

Double filter basket

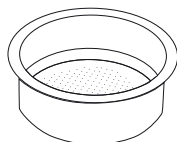

Features of your Sunbeam Artista

15 Bar Pump



The machine is fitted with an Italian designed and manufactured 15 BAR pump which generates the pressure required to deliver a complete extraction of oils, coffee solids and aroma.

Thermoblock Heating System

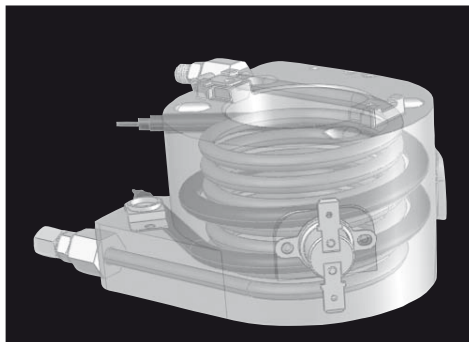

The thermoblock heating system heats the water ensuring the precise temperature is achieved for each function. Additionally, the one-piece construction and stainless steel tubing of the thermoblock effectively slows scale build up and reduces the frequency of cleaning required.

Pre-Infusion

Progressive pre-infusion is programmed into the espresso operation. It is a gradual increase of water pressure pre-soaking the coffee cake before full water pressure is applied. This in turn delivers greater body and sweetness to the espresso.

Crema System



The specially designed crema system consists of a dual-floor filter creating additional back pressure and a stabilising baffle that helps retain temperature and produces a steady pour of espresso. The dual-floor filter baskets are designed to slow the flow of liquid espresso creating a subtle aeration to ensure a golden crema.

Push Button Control Panel



An easy to use control panel enables manual operation of espresso coffee as well as steam and hot water functions. The user is also able to personalise and save their own settings for coffee temperature, steam temperature and steam flow.

Using the control panel

Power

Press the 'POWER' button once to turn the espresso machine on. The light behind the 'POWER' button will illuminate green and start flashing; this is to indicate that your espresso machine is on and is heating up.

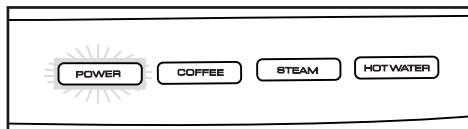

Ready Mode

When the green light behind the 'POWER' button stops flashing and turns to a constant red light, this indicates that the espresso machine is heated and ready to use. The lights behind the 'COFFEE', 'STEAM' and 'HOT WATER' buttons will show a constant green light. The machine is now in Ready Mode as represented below.

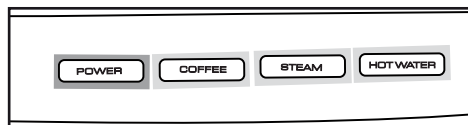

Note: Remember that if the light behind the 'POWER' button is flashing it means the espresso machine is adjusting the temperature of the heating system.

To turn the espresso machine off, simply press the 'POWER' button, the red power light and all other lights on the control panel will turn off.

Espresso

The 'COFFEE' button allows the coffee maker to have complete control over the length of the espresso pour.

Once the espresso machine is switched on and heated, so the machine is in ready mode (see above), the coffee maker is able to use

the espresso coffee operation. The coffee maker simply needs to press the 'COFFEE' button once to start the pour and press again to stop.

Note: Before activating the espresso coffee function ensure that the steam and hot water control dial is in the OFF position.

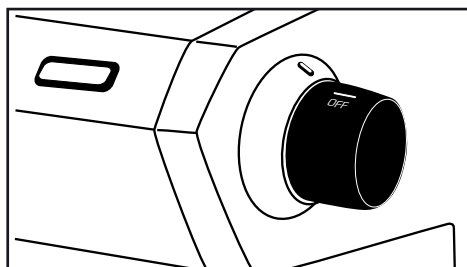

Important: Once the espresso coffee operation is activated, before the espresso pour starts the progressive pre-infusion feature will release three short bursts of gradual water pressure onto the coffee cake. After this the full water pressure is applied and the espresso will pour freely.

Note: When the coffee maker has activated the espresso coffee operation the lights behind the 'STEAM' and 'HOT WATER' buttons will go off. The lights behind the 'POWER' and 'COFFEE' buttons will remain on.

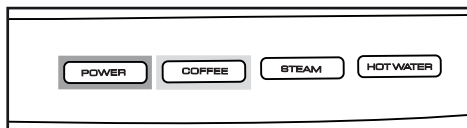

Note: Once the espresso coffee operation has been activated the light behind the 'POWER' button will flash until the temperature of the heating system is correct. Once at the correct temperature the light will remain lit and the espresso pour will start.

Using the control panel (continued)

Steam

The steam function allows the coffee maker to produce steam out of the steam wand for texturing milk.

To activate the steam function, the coffee maker simply needs to press the 'STEAM' button. By design the temperature of the espresso machine will adjust as necessary. There may be a short delay while you wait.

Note: When the coffee maker has activated the steam function the light behind the 'STEAM' button will show a constant green light and the light behind the 'COFFEE' and 'HOT WATER' buttons will go off. Additionally the light behind the 'POWER' button will remain on.

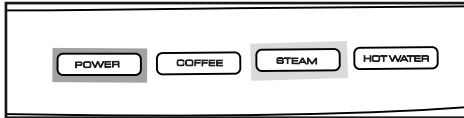

Note: If the light behind the 'STEAM' button is flashing it means the espresso machine is adjusting the temperature of the heating system. You will be able to use the steam while it is heating up but this is not advised as the steam will be wetter than if the machine is fully heated up.

Once the espresso machine is heated to the correct temperature, so the light behind the 'STEAM' button stops flashing and shows a constant green light, the coffee maker is able to use the espresso machine.

The coffee maker simply needs to turn the steam and hot water control dial anti-clockwise to the 'MAX' setting to start and turn it back to the 'OFF' position to stop. Press the 'STEAM' button again to deactivate the steam function.

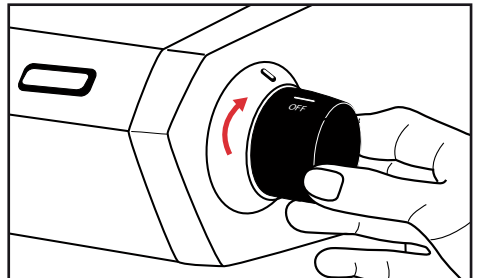
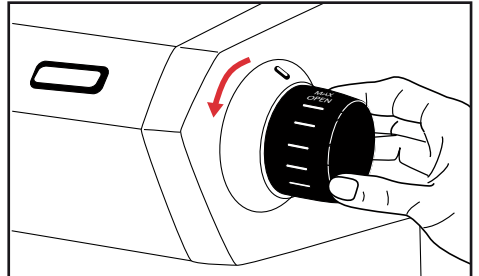

Note: When you have finished steaming, ensure the steam control dial is fully turned off. If the steam control dial is left open, the coffee maker will not be able to switch to the 'COFFEE' or 'HOT WATER' functions.

Note: After 10 minutes of inactivity in the steam mode, the espresso machine will automatically switch back to the ready mode.

Using the control panel (continued)

Hot Water

The hot water function allows the coffee maker to release a controlled flow of hot water for making long blacks, hot chocolates, pre-heating cups and glasses and brewing teas.

To activate the hot water function, the coffee maker simply needs to press the 'HOT WATER' button.

Note: When the coffee maker has activated the hot water function the light behind the 'HOT WATER' button will show a constant green light and the light behind the 'COFFEE' and 'STEAM' buttons will go off. Additionally the light behind the 'POWER' button will remain on.

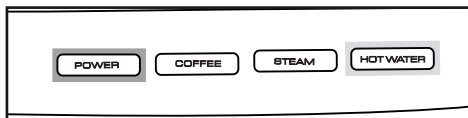

The coffee maker simply needs to turn the steam and hot water control dial anti-clockwise to the 'MAX' setting to start and turn it back to the 'OFF' position to stop.

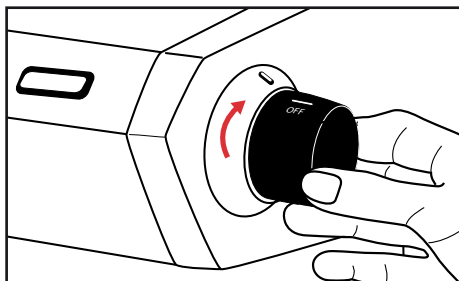
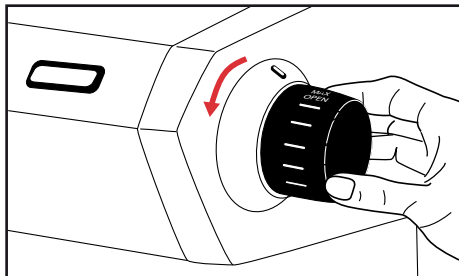

Reference guide to using your espresso machine

The diagrams below and on the following pages are to assist you in operating your Sunbeam Artista espresso machine. Each of the diagrams is numbered. Throughout this instruction booklet reference will be made to these diagrams, so each of them has been numbered for convenience and ease of use.

For example: Fill the water reservoir (1) (2) (3) (4) (5) with cold tap water...

Each time you see these numbers please refer back to the diagrams.

Preparing the espresso machine

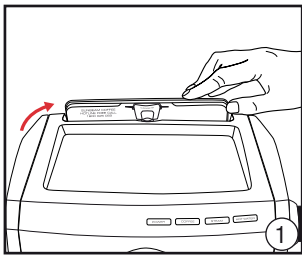

Open lid of water reservoir.

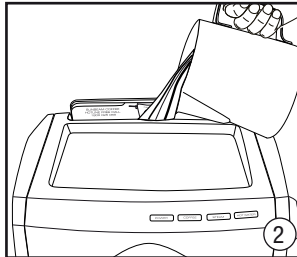

Fill in place with cold water.

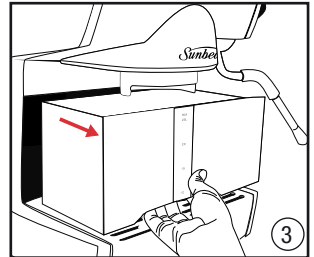

Remove water reservoir from front of unit.

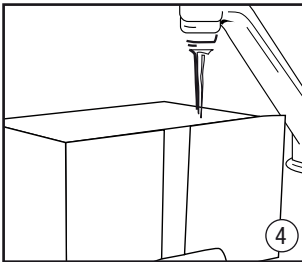

Fill at sink with cold water.

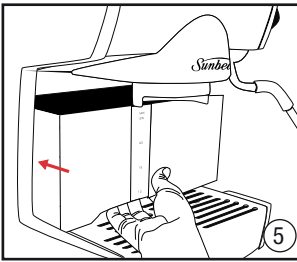

Replace the water reservoir.

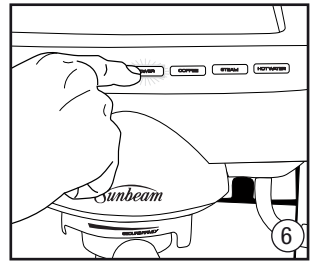

Press 'POWER' button to turn unit on.

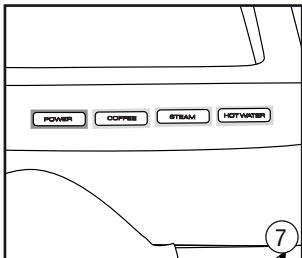

Control panel lit and ready to use. (Ready Mode)

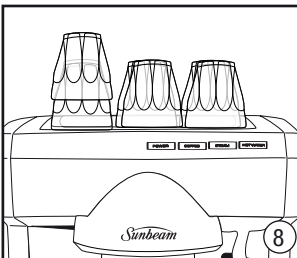

Warming the espresso cups.

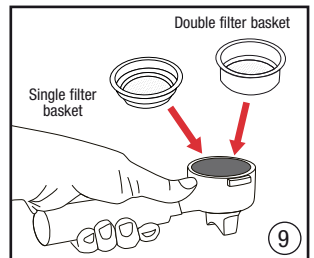

Select appropriate filter and place into group handle.

Reference guide to using your espresso machine (continued)

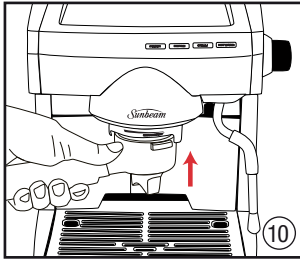

Place group handle onto group head.

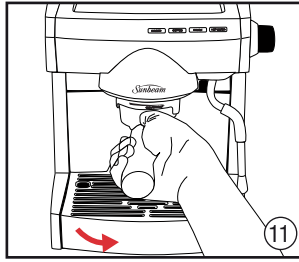

Turn group handle to the right, so it is firmly locked into position.

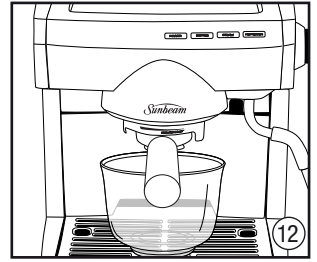

Place large container under both pouring spouts.

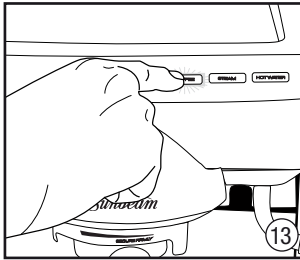

Press the 'COFFEE' button and allow the water to run through. Press button again to stop.

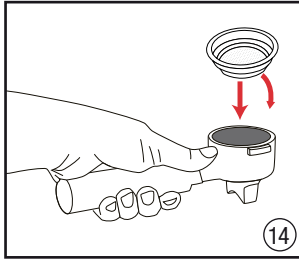

Select appropriate filter and place into group handle.

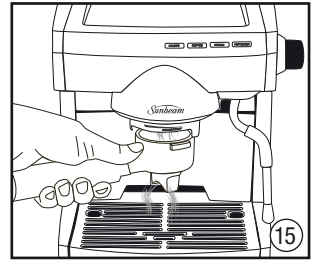

Hold group handle under group head and purge with water to preheat.

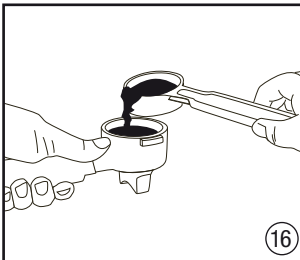

Place finely ground coffee into filter basket.

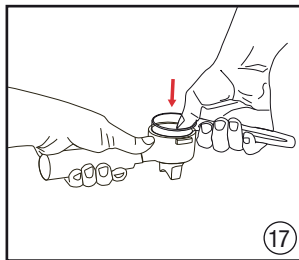

Tamp the coffee grounds. The level of coffee must be 3mm below the filter basket rim.

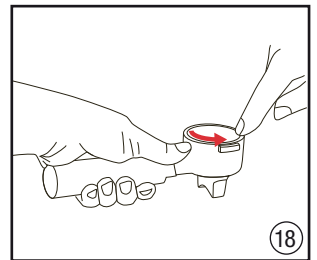

Wipe the edge of filter to remove any coffee grounds.

Reference guide to using your espresso machine (continued)

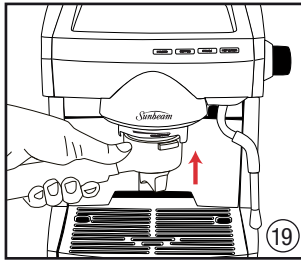

Place group handle onto group head.

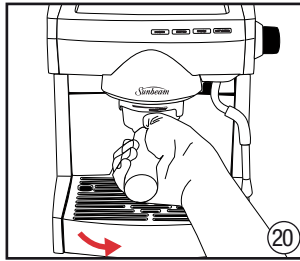

Turn group handle to the right, so it is firmly locked into position.

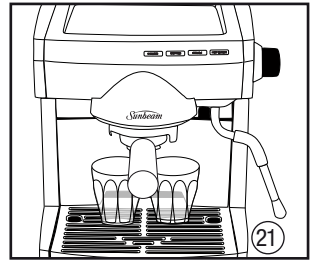

Place glasses/cups below pouring spouts.

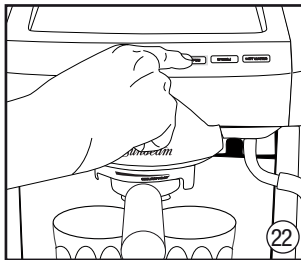

Press the 'COFFEE' button for a continuous pour. Press button again to stop pour.

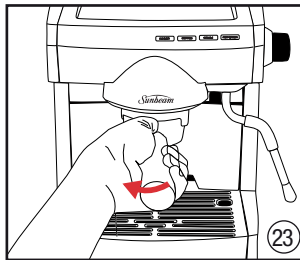

Remove group handle by turning to the left.

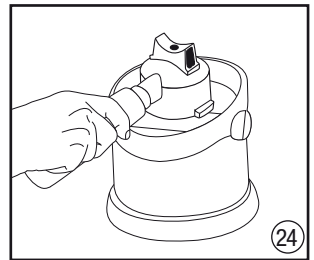

Discard the used coffee grinds.

Texturing milk

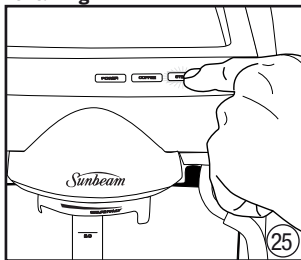

Press the 'STEAM' button to activate steam mode.

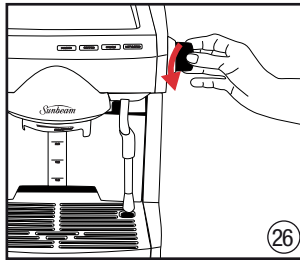

Purge the steam wand by turning dial anti-clockwise.

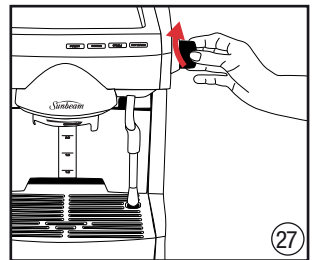

Turn off steam by turning dial clockwise.

Reference guide to using your espresso machine (continued)

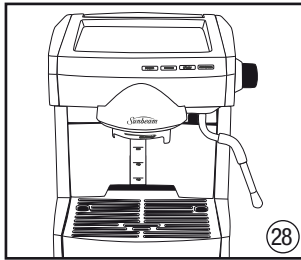

Swing steam wand to the side of espresso machine.

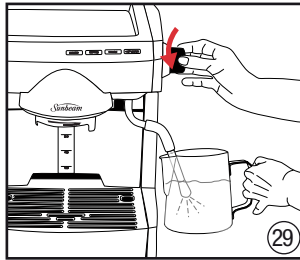

Place steam wand into milk, approx. 1cm below surface and activate the steam function.

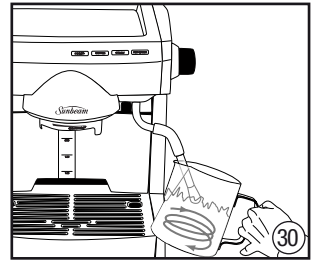

Angle jug to rest steam wand on spout and place nozzle just below surface of the milk.

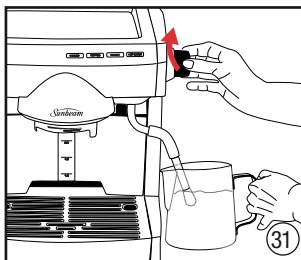

Close the steam by turning dial clockwise.

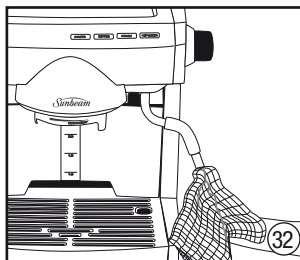

Wipe steam nozzle and wand with damp cloth and purge a small amount of steam.

Hot water

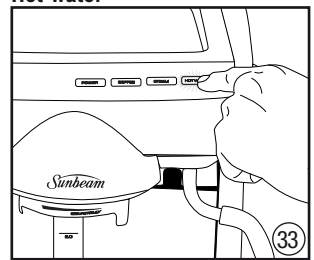

Press the 'HOT WATER' button to activate hot water mode.

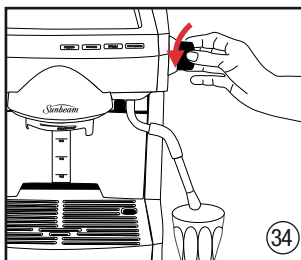

Place cup under hot water nozzle and activate the hot water function by turning dial anti-clockwise.

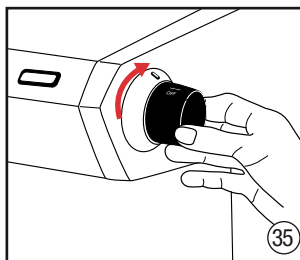

Close the hot water by turning dial clockwise.

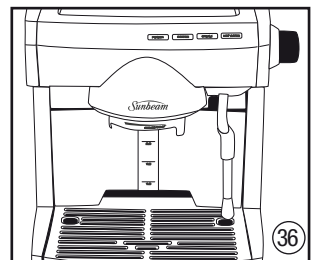

Swing the steam/hot water wand over the drip tray.

Reference guide to using your espresso machine (continued)

Cleaning

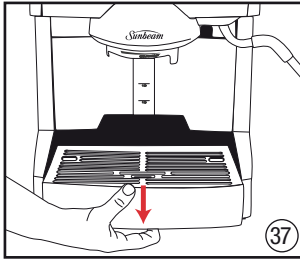

Remove the drip tray.

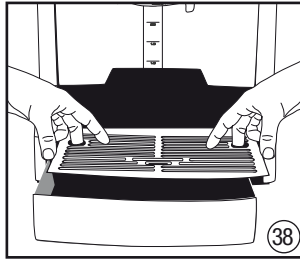

Remove drip tray grill.

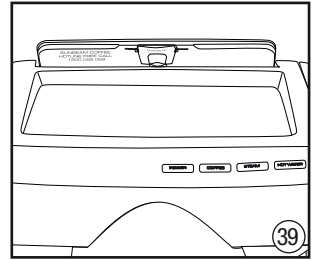

Remove the cleaning pin from under the top lid of the water reservoir.

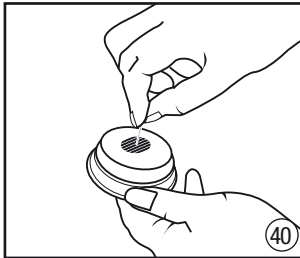

Insert thinner end of cleaning pin into the single hole in the base of the filter.

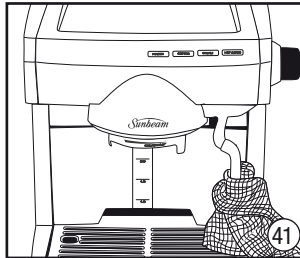

Wrap steam wand with damp cloth and turn steam on for 10 seconds.

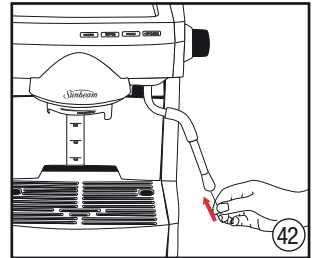

Insert thicker end of cleaning pin into the hole in the base of the steam wand.

Preparing your espresso machine before use

1. Place the espresso machine onto a dry, stable benchtop.
2. Ensure the drip tray and grill are in place.
3. Fill the espresso machine with water. There are a couple of ways in which the water reservoir can be filled;
 - a) Simply lift the lid of the water reservoir at the top of the espresso machine (1) and using a jug, fill with fresh cold water or filtered water (2), then close the lid.
 - b) Alternatively the water reservoir can be removed and filled with fresh cold water. To do so, ensure the group handle has been taken out of the group head and swing the steam wand to the right, out of the way. Then using the handle at the front of the water reservoir simply slide out the reservoir from the front of the espresso machine (3). Then fill with fresh cold water or filtered water (4). Replace the water reservoir firmly by sliding it back into place (5).
4. Insert the power cord into a 230-240V AC power outlet and switch the power on. Press the 'POWER' button once to turn the espresso machine on (6). The light behind the 'POWER' button will illuminate green and start flashing. This is to indicate that your espresso machine is on and is heating up.

When the green light behind the 'POWER' button stops flashing and turns to a constant red light, this indicates that the espresso machine is heated and ready to use. The lights behind the 'COFFEE', 'STEAM' and 'HOT WATER' buttons will also show a constant green light (7). When the control panel is lit in this way, this indicates that the machine is in ready mode.
5. Place glasses and cups on the warming plate (8).

Important: For first time use or if the machine has not been used for some time, it is important that the machine is rinsed as follows:
6. Fit the group handle with either the single or double filter basket (9). Secure the group handle to the group head (10) (11).
7. Place a sufficiently large container under both pouring spouts (12).
8. Once the espresso machine is switched on and heated, so the light behind the 'POWER' button is red and the lights behind the 'COFFEE', 'STEAM' and 'HOT WATER' buttons show a constant green light, the espresso machine is heated and ready to use.

Tip: Remember if the 'POWER' light is flashing green, this indicates that the espresso machine is on and is heating up.
9. Press the 'COFFEE' button (13) and allow the water to run through until the water reservoir is empty.

Note: You will need to press the 'COFFEE' button again to stop the water flow. It does not happen automatically. This allows the user to have full control over their espresso pour.

Guide to the perfect espresso

Preheat Glasses

1. Preheat the glasses/cups by filling them with hot water as this will assist to preserve the crema of the espresso. Set the glasses/cups aside.

Caution: The hot water will be close to boiling temperature. Take care so as not to crack the glasses or burn yourself.

Preheat Group Handle and Filter Basket

2. Select the appropriate filter basket and place it into group handle (14).

Tip: Use the single filter basket for a single serve of espresso and the double filter basket for a double serve of espresso.

3. Take the group handle, hold it under the group head and purge water. With the filter basket positioned under the group head press the 'COFFEE' button to start the water flow and press it again to stop (15).

4. Dry the filter basket.

Dosing and Tamping

5. Using a grinder or the measuring spoon supplied, place the appropriate amount of finely ground coffee into the filter basket (16).

6. Rest the group handle with the filter basket in position onto the benchtop. Take the coffee tamp, apply firm level packing pressure (17), twisting 90 degrees to polish the grounds. This seals the surface of the coffee cake.

7. Brush any excess coffee grounds from around the edge of the filter basket (18).

Important: Be sure to place a sufficient amount of coffee grinds into the filter basket without over dosing it with coffee. Once tamped the level of coffee should be only a few millimetres below the rim of the filter basket. To check this, lock the group handle onto the group head (19)(20).

Then without having made a coffee remove the group handle (23) and inspect the top of the tamped coffee - it should have only a slight indent from the shower screen. Ideally the top of the tamped coffee should be fractionally below the shower screen and then during the espresso pour the coffee cake will expand up and onto the shower screen.

Tip: The coffee dosage and the degree of tamping should remain the same every time you make a coffee. The only thing that should vary is the coarseness of the coffee grounds and this will vary depending on the bean. For example to achieve a slower espresso pour rate use a finer grind and a coarser grind for a faster espresso pour rate.

Note: If purchasing pre-ground coffee or you have someone grind it for you, request/ purchase a very fine grind, the same that would be used for a commercial espresso machine.

Tip: Ensure the coffee tamp is dry because if it is wet the coffee grinds will stick to it.

The Espresso Pour

8. Lock the group handle onto the group head (19)(20).

9. Empty the glasses/cups and place below the pouring spouts (21).

Note: Check to see that the espresso machine is ready for use (see p7 Ready Mode). Remember that if the 'POWER' light is flashing green, this indicates that the espresso machine is on and heating up.

10. Press the 'COFFEE' button to start the espresso pour (22). Press it again to stop the pour.

Important: Should coffee grinds come out from the top of the group handle this is a sign that the group handle has not been firmly locked into position and/or the level of coffee in the basket is too high.

Guide to the perfect espresso (continued)

Pre-Infusion

11. Once the espresso operation has been activated, before the espresso pour starts, the progressive pre-infusion feature will release three short bursts of gradually increasing water pressure onto the coffee cake. After this, the full water pressure is applied to the coffee cake and the espresso will pour freely.
12. Check the espresso pour. The ideal pour starts out dark and then soon after becomes caramel with reddish reflections. The pour should hang vertically on each spout and flow slowly like dripping honey.

Tip: Once the espresso pour starts to lighten in colour you should cut off the pour.

13. Serve espresso immediately.

Caring for your Espresso Machine

13. Remove the group handle from the group head (23).
14. Discard the used coffee grinds from the filter basket (24).

Tip: After each use of the espresso machine we recommend that a small amount of water is cycled through the group head as this will wash out any old or used coffee grinds stuck to the underside of the group head. Simply press the 'COFFEE' button and allow some water to run through. Press button again to stop. We also recommend that a small amount of water is purged through the steam wand after each use.

Eco Mode and Standby Mode

After 1 hour of non-use in Ready Mode the espresso machine will automatically switch to Eco Mode. An indication that the machine is in Eco Mode is the light behind the 'POWER' button will slowly flash red. While in Eco Mode the machine uses reduced power and maintains a lower temperature. While in Eco Mode, the espresso machine functions can easily be reactivated by simply pressing the 'COFFEE', 'STEAM' or 'HOT WATER' buttons. The temperature of the espresso machine will then adjust as necessary.

After a further 1 hour of non-use in Eco Mode the espresso machine will automatically switch to Standby Mode. The lights on the control panel will all switch off. To bring the espresso machine out of Standby Mode simply press the 'POWER' button. The machine will then power on and begin heating up.

Guide to milk texturing

Milk texturing is the steaming of milk. The steam does two things, heats the milk and also the steam mixes air with the milk to form an 'emulsion' of tiny bubbles that gives a silky velvet texture. Similar to making an espresso, perfecting the art of milk texturing takes time and practice.

Tip: Remember espresso is the foundation for all espresso-coffee drinks and the milk is the variable.

Before starting to prepare for milk texturing, ensure the espresso machine is in steam mode, so the red light behind the 'POWER' button and green light behind the 'STEAM' button are illuminated.

Note: Should the espresso machine not be in steam mode, simply press the 'STEAM' button to activate (25).

Tip: It is recommended to use the steam function after first making espresso or using the hot water function. Making coffee in this order will reduce any waiting time or water usage while the machine adjusts to the correct temperature.

1. Determine how much milk is needed based on the number of cups being made or the size of the texturing jug.

Tip: Keep in mind that the volume of milk will increase or 'stretch' during the texturing.

2. Pour cold refrigerated milk into a stainless steel jug, between $\frac{1}{3}$ to $\frac{2}{3}$ full.

Tip: Best results will be achieved by using a clean jug and cold, fresh milk.

3. Purge the steam wand of any water. With the steam wand positioned over the drip tray activate the steam function by turning the steam and hot water control dial anti-clockwise as far as it will go (26). Once any water has been purged close the steam by turning the steam and hot water control dial clockwise (27).

4. Swing the steam wand to the side of the espresso machine (28).
5. Place the steam wand into the milk so that the tip of the steam nozzle is just below the surface of the milk and activate the steam function by turning the steam and hot water control dial anti-clockwise as far as it will go (29).
6. Angle the jug so that the steam wand is resting on the spout of the jug and lower the jug until the tip of the steam nozzle is just below the surface of the milk. The nozzle should sit just off centre in the milk. This will start to create a whirlpool action in the milk (30).

Note: How we introduce the air to the milk will determine the consistency of the foam. If we catch large gulps of air the quality of the foam will reflect this by having large bubbles. If we can introduce air to the milk in a controlled gentle fashion indicated by a gentle hissing sound the milk will have a fine aerated bead in the textured foam.

7. As the steam heats and textures the milk, the level of the milk in the jug will begin to rise. As this happens follow the level of the milk by lowering the jug, always keeping the tip of the steam nozzle just below the surface. This will create a slight hissing noise.

Tip: The amount of foam required will vary depending on the drinks being made, for example a cappuccino requires more foam than a flat white.

8. Close the steam immediately when the milk is heated to between 60-65°C by turning the steam and hot water control dial clockwise (31).

Tip: The optimum drinking temperature of milk is between 60-65°C and we advise you use a milk thermometer to achieve

Guide to milk texturing (continued)

the correct temperature. It's important to remember that if the milk is not heated long enough the drink will be too cool and if heated for too long it will start to boil at around 72°C and all texture will be lost.

Tip: If you don't have a thermometer a good indication that the correct temperature has been reached is when the jug becomes too hot to leave your fingers in contact.

Important: Do not boil the milk as the texture and taste will be affected.

9. Remove the jug, immediately wipe the steam nozzle and wand with a clean damp cloth (32) and purge a small amount of steam.
10. With the jug in hand tap the jug on the bench top to release the trapped air bubbles. Agitate the milk as this helps the milk and froth combine for an even consistency.

Note: After 10 minutes of non-use in steam mode, the espresso machine will automatically return to ready mode.

Using the hot water function

The hot water function is ideal for preheating cups and glasses, brewing teas, preparing long blacks, hot chocolates and filling coffee plungers.

When using the hot water function the espresso machine needs to be in hot water mode, so the red light behind the 'POWER' button and the green light behind the 'HOT WATER' button are illuminated.

Note: Should the espresso machine not be in hot water mode, simply press the 'HOT WATER' button to activate (33).

1. Swing the steam and hot water wand to the side of the espresso machine.
2. Place the cup or container under the steam/hot water nozzle and activate the hot water function by turning the steam and hot water control dial anti-clockwise as far as it will go (34).

Caution: The water from the hot water nozzle will be close to boiling temperature. Take care as boiling water may scald. Additionally, the wand will be hot and may burn.

3. Once you have dispensed the required amount of hot water into the cup or container, close the hot water by turning the steam/hot water control dial clockwise (35).
4. Remove the cup or container and swing the steam/hot water wand over the drip tray to catch any drips of water (36).

Espresso Recipes

ESPRESSO (SHORT BLACK)

Espresso is a concentrated, full bodied coffee with a stable layer of cream on top – known as ‘crema’. An espresso is the foundation of all café coffee. Variations are achieved by adding different amounts of milk and froth.

- 90mL espresso glass or demitasse cup
- single espresso (30-35mL)



MACCHIATO

Macchiato, Italian for ‘to stain or mark’. Traditionally served as a standard espresso with a dash of milk and a small dollop of froth into the middle of the ‘crema’.

- 90mL espresso glass or demitasse cup
- single or double espresso
- marked with steamed milk froth



LONG BLACK

A standard espresso with hot water, served in a regular coffee cup or mug. The hot water is added first so that the ‘crema’ is maintained.

- 190mL cup
- hot water (to taste)
- single or double espresso



FLAT WHITE

Another old favourite, the Flat White is an espresso with steamed milk, served in a regular coffee cup or mug. The layer of frothed milk on top should be 2mm to seal the coffee.

- 190mL cup
- single or double espresso
- steamed milk



Espresso Recipes (continued)

CAFFE LATTE

An espresso with steamed milk, typically served in a glass. The layer of frothed milk on top should be 10mm to seal the coffee.

- 220mL glass or cup
- single or double espresso
- steamed milk



CAFFE MOCHA

Made in a similar way to a cappuccino but with the addition of drinking chocolate. Simply stir the chocolate into the espresso prior to adding the steamed milk and froth.

- 190-240mL cup or tall glass
- single or double espresso
- two teaspoons of drinking chocolate
- two-thirds milky coffee, one-third froth



CAPPUCCINO

This delicious drink is an espresso with steamed milk, topped with creamy froth and a dusting of chocolate. The resulting drink is approximately two-thirds milky coffee, one-third froth.

- 190-240mL cup
- single or double espresso
- two-thirds milky coffee, one-third froth
- dusted with chocolate



CON PANNA

A variation on the original Vienna coffee, this delicious drink is made up of an espresso topped with lightly whipped cream. It can also be dusted with cinnamon or drinking chocolate.

- 190mL cup
- single or double espresso
- lightly whipped cream
- dusted with cinnamon or chocolate



Care and Cleaning

The coffee making process involves extracting oils out of coffee grinds to make espresso coffee. Deposits of these oils build up over time and affect the taste of the coffee and operation of the espresso machine.

Regular cleaning to remove these oils is essential and will maintain the quality of the coffee the espresso machine produces and result in less maintenance being required. This is easy to do by following a few quick and easy cleaning steps after each coffee making session;

- ☑ Cycle water through the group head,
- ☑ Purge steam through the steam wand,
- ☑ Wipe the steam wand clean with a damp cloth immediately after use,
- ☑ Remove the filter basket from the group handle and clean away any old coffee oils, and
- ☑ Empty the drip tray and rinse.

Important: Never wash any of the espresso machine parts or accessories in the dishwasher.

Drip tray and grill

Remove the drip tray and grill at regular intervals to empty (37) (38). Clean with water and a little non-abrasive washing up liquid, rinse and dry.

Over time it is normal for the inside of the drip tray to be stained by the oils in the coffee.

Group head, group handle & filter baskets

The filter baskets and group handle should be rinsed with warm water after each use and then dried thoroughly.

To clean the group head of any old coffee grinds cycle water through and wipe the group head and around the inside rim with a damp cloth.

Should the holes in the filter baskets become clogged with coffee grinds use a fine bristled brush to remove them. Also you can use the cleaning pin which is supplied with the espresso machine. The cleaning tool is located under the top lid of the water reservoir (39). The cleaning tool has two pins at either end. One is the thinner and shorter of the two and is for cleaning out the hole in the filter basket. Insert the cleaning pin into the single hole in the base of the filter (40).

Group head rubber seal

The group head seal is located on the underside of the group head and creates a seal against the group handle during the espresso pour.

Note: During long periods of non-use we recommend that the group handle not be left attached to the group head as this will reduce the life of the seal.

Over time the seal will lose its elasticity and require replacement, depending on use usually every 12 months. Signs that the seal is deteriorating are when the group handle cannot create the necessary seal and steam and/or water escapes from around the group head during the espresso pour. Another sign may be when the group handle locks off to the right rather than the front.

Note: Contact Sunbeam on 1300 881 861 should you think that the group head seal needs replacing. Please do not attempt to change the seal without first consulting Sunbeam.

Care and Cleaning (continued)

Cup warming plate and exterior

Wipe over the unit with a damp cloth and wipe dry. Do not use abrasives or metal scourers as these will scratch the exterior surface.

Steam wand

Keeping the steam arm clean is essential to ensure maximum efficiency of the steam function. A build up of caramelised/dried milk on the steam wand will impair the steaming and texturing ability of the espresso machine. The steam nozzle has been specially designed to be perfectly smooth. This will help to reduce build up of dried milk.

Important: Wipe the steam wand clean with a damp cloth immediately after each use and purge a small amount of steam.

Should the milk dry/caramelize on the steam wand, simply wrap the wand with a clean damp cloth, swing the steam wand over the drip tray and turn the steam on for approximately 10 seconds (41). With the cloth still on the steam wand leave to sit for about 5 minutes and you will find that after this time the dry/caramelised milk will easily wipe away. Repeat process if still dirty.

Important: Never clean the steam wand with an abrasive pad as this will damage the steam wand.

Should the steam wand become blocked, supplied with the espresso machine is a cleaning pin. The cleaning tool is located under the top lid of the water reservoir (39). The cleaning tool has two pins at either end. The thicker, longer pin is for cleaning the steam wand. Insert the cleaning pin into the hole in the base of the steam nozzle (42). Should the steam wand remain blocked unscrew the steam nozzle from the steam wand. Clean the steam nozzle by once again using the cleaning pin then flush under running water.

Descaling

Scale is a surface build up of minerals that naturally occur over time in all appliances that are involved with the heating of water. Therefore the espresso machine will require occasional descaling. It is recommended that the espresso machine is descaled every 4-6 months, this will vary depending on the frequency of use and water hardness.

Descaling solution

Use any of the following when descaling the espresso machine:

- Sunbeam Espresso Machine Descaling Tablets (EM0010)
- Sunbeam Liquid Descaler (KEO100), or
- Vinegar Solution.

Descaling the espresso machine

Note: Ensure the espresso machine is turned off and the power cord is unplugged.

1. Remove the water reservoir and rinse clean. Depending on the descaling solution being used use one of the following:

A. Sunbeam Espresso Machine Descaling Tablets

Fill the water reservoir with 1 litre of warm water and place a descaling tablet into the reservoir. Once the tablet has dissolved replace the reservoir, this takes about 5-7 minutes.

B. Sunbeam Liquid Descaler

Fill the water reservoir with approximately 1.5 litres of water, add 1 capful of Sunbeam Liquid Descaler and replace the reservoir.

C. Vinegar solution

Fill the water reservoir with approximately 1.5 litres of warm water, add 3 tablespoons of vinegar and replace the reservoir.

2. Should the group handle be attached to the group head remove it, rinse thoroughly under running water and set aside.
3. Using a screwdriver unscrew the brewing filter/shower screen from the underside of the group head.
4. Remove and set aside the filter/screen, washer and screw in a safe place.

Important: Be careful not to lose the filter/screen, washer and screw once you have disassembled the group head.

5. Using a small brush scrub in and around the area at the brewing head, removing all coffee grinds.
6. Place a sufficiently large container under the group head.
7. Insert the power cord into a 230-240V AC power outlet and switch the power 'ON'. Press the 'POWER' button once to turn the espresso machine on.

Note: Check to see that the espresso machine is ready for use (see p7 Ready Mode).

Remember if the 'POWER' light is flashing green this indicates that the espresso machine is on and is heating up.

8. Press the 'COFFEE' button and allow half the solution to cycle through the group head and then once again press the 'COFFEE' button to stop the flow.

Important: Do not run descaling solution through the steam wand.

Note: Depending on the size of the container under the group head on occasion this may need to be emptied throughout this process.

9. After half the solution has cycled through press the 'COFFEE' button to stop the flow and then press the 'POWER' button to turn the machine off.

Descaling (continued)

10. Leave the machine off for 10-15 minutes to allow the descaling solution to take affect.
11. Press the 'POWER' button once to turn the espresso machine on.
12. Press the 'COFFEE' button and allow the remaining solution to cycle through the group head. Press button again to stop.
13. Remove the water reservoir from the machine and rinse thoroughly under running water, ensuring that all traces of the descaling solution are removed. Fill with clean water and replace the reservoir.
14. Press the 'COFFEE' button and allow the entire water reservoir to cycle through the group head. Press button again to stop.
Note: Depending on the size of the container under the group head on occasion this may need to be emptied throughout this process.
15. When this is finished remove the container under the group head and give the machine a good wipe over.
16. Carefully replace the rubber seal, brewing filter/shower screen and washer to the group head.
Important: Ensure the screw is tightened well.
17. Fill the water reservoir with fresh water and position it in to the machine.

Advanced Programming Options

Espresso Thermoblock Temperature

The water temperature of this espresso machine has been calibrated to the precise temperature of 92°C at the group head. The temperature of the water at the group head can be modified in increments of 2°C up and down should it be desired.

To do this you need to follow the instructions below:

1. Insert the power cord into a 230-240V AC power outlet and switch the power 'ON' at the mains only, so that no lights are illuminated on the espresso machine control panel (ie. the power outlet should be 'ON' but the espresso machine will be 'OFF').
2. Press and hold down the 'COFFEE' button for 3 seconds.
3. While still holding down the 'COFFEE' button briefly press the 'POWER' button and release.
4. Release the 'COFFEE' button.

Note: This activates the programmability of the Espresso Temperature and to signal this, the machine will output the current setting with a sequence of beeps. See chart below to determine what setting your machine is programmed to.

Beep Sequence	Setting
3 short beeps	+ 3
2 short beeps	+ 2
1 short beep	+ 1
1 short and 1 long beep	Factory Setting
1 long beep	- 1
2 long beeps	- 2
3 long beeps	- 3

Note: The lights behind the 'STEAM' and 'HOT WATER' buttons will start flashing.

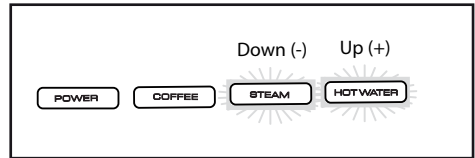

5. Within 30 seconds press and release one of the flashing buttons depending on the required temperature adjustment;

Up (+) a setting : Press 'HOT WATER'

Down (-) a setting : Press 'STEAM'

Note: When you have selected a new temperature setting the machine will sound a sequence of beeps to indicate the new temperature setting.

6. To save your settings press and hold down the 'COFFEE' button for 3 seconds. A single long beep will sound to indicate your settings have been saved.

Note: The espresso machine will then automatically power on and begin heating up.

Note: The machine will stay in programming mode for up to 30 seconds. If you do not select a new temperature setting within 30 seconds the program will automatically return to the Factory Setting and the espresso machine will then power on and begin heating up.

Advanced Programming Options (continued)

Steam Thermoblock Temperature

The steam temperature of this espresso machine has been calibrated to deliver a powerful and dry steam for texturing milk. The temperature of the steam can be modified in increments of 3°C up and down should it be desired.

To do this you need to follow the instructions below:

1. Insert the power cord into a 230-240V AC power outlet and switch the power 'ON' at the mains only, so that no lights are illuminated on the espresso machine control panel (ie. the power outlet should be 'ON' but the espresso machine will be 'OFF').
2. Press and hold down the 'STEAM' button for 3 seconds.
3. While still holding down the 'STEAM' button briefly press the 'POWER' button and release.
4. Release the 'STEAM' button.

Note: This activates the programmability of the Steam Temperature and to signal this, the machine will output the current setting with a sequence of beeps. See chart below to determine what setting your machine is programmed to.

Beep Sequence	Setting
3 short beeps	+ 3
2 short beeps	+ 2
1 short beep	+ 1
1 short and 1 long beep	Factory Setting
1 long beep	- 1
2 long beeps	- 2
3 long beeps	- 3

Note: The lights behind the 'COFFEE' and 'HOT WATER' buttons will start flashing.

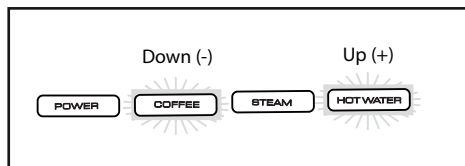

5. Within 30 seconds press and release one of the flashing buttons depending on the required temperature adjustment;

Up (+) a setting : Press 'HOT WATER'

Down (-) a setting : Press 'COFFEE'

Note: When you have selected a new temperature setting the machine will sound a sequence of beeps to indicate the new temperature setting.

6. To save your settings press and hold down the 'STEAM' button for 3 seconds. A single long beep will sound to indicate your settings have been saved.

Note: The espresso machine will then automatically power on and begin heating up.

Note: The machine will stay in programming mode for up to 30 seconds. If you do not select a new temperature setting within 30 seconds the program will automatically return to the Factory Setting and the espresso machine will then power on and begin heating up.

Advanced Programming Options (continued)

Steam Wetness or Steam Pump Rate

The steam pump rate of this espresso machine has been pre-set. Modifying the steam pump rate enables you to make the steam wetter or dryer and aids in the delivery of a powerful, dry steam – ideal for texturing milk. The steam pump rate can be modified in flow rate increments up or down should it be desired.

To do this you need to follow the instructions below:

1. Insert the power cord into a 230-240V AC power outlet and switch the power 'ON' at the mains only, so that no lights are illuminated on the espresso machine control panel (ie. the power outlet should be 'ON' but the espresso machine will be 'OFF').
2. Press and hold down the 'HOT WATER' button for 3 seconds.
3. While still holding down the 'HOT WATER' button briefly press the 'POWER' button and release.
4. Release the 'HOT WATER' button.

Note: This activates the programmability of the steam pump rate and to signal this the machine will output the current setting with a sequence of beeps. See chart below to determine what setting your machine is programmed to.

Beep Sequence	Setting
3 short beeps	+ 3
2 short beeps	+ 2
1 short beep	+ 1
1 short and 1 long beep	Factory Setting
1 long beep	- 1
2 long beeps	- 2
3 long beeps	- 3

Note: The lights behind the 'COFFEE' and 'STEAM' buttons will start flashing.

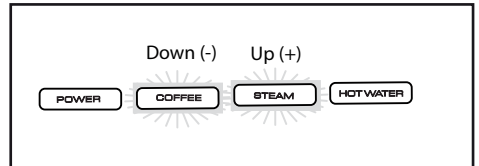

5. Within 30 seconds press and release one of the flashing buttons depending on the required flow rate adjustment;
Up (+) a setting : Press 'STEAM'
Down (-) a setting : Press 'COFFEE'
6. To save your settings press and hold down the 'HOT WATER' button for 3 seconds. A single long beep will sound to indicate your settings have been saved.

Note: The espresso machine will then automatically power on and begin heating up.

Note: The machine will stay in programming mode for up to 30 seconds. If you do not select a new pump rate setting within 30 seconds the program will automatically return to the Factory Setting and the espresso machine will then power on and begin heating up.

Advanced Programming Options (continued)

Factory Reset

To undo any changes made to the program you can revert back to the original factory settings.

To do this you need to follow the instructions below:

1. Insert the power cord into a 230-240V AC power outlet and switch the power 'ON' at the mains only, so that no lights are illuminated on the espresso machine control panel (ie. the power outlet should be 'ON' but the espresso machine will be 'OFF').
2. Press and hold down the 'POWER' button for 3 seconds.
3. Release the 'POWER' button.

Note: This resets ALL the program settings back to factory settings, including the espresso and steam thermoblock temperatures and the steam pump rate.

4. A single long beep will sound to indicate the factory reset has been completed.

Note: The espresso machine will then automatically power on and begin heating up.

Trouble shooting guide

PROBLEM	POSSIBLE CAUSE	WHAT TO DO
Coffee runs down the side of the group handle.	Group handle is not attached correctly, or has not been tightened sufficiently.	Ensure the handle is firmly positioned onto the group head. See "Guide to the perfect espresso" pg 16.
	Edge of filter basket is not free of coffee grinds.	Clean around the top edge of the filter and wipe the group head clean of coffee.
	The group head is dirty.	Wipe group head with a damp cloth.
	The group head is defective.	Contact a Sunbeam Service Centre.
	Group head rubber seal is damaged, or worn.	Contact a Sunbeam Service Centre.
No coffee runs through.	No water in the water reservoir.	Fill reservoir with water.
	Water reservoir not correctly positioned.	Push water reservoir all the way to the back of the unit to ensure it is correctly positioned.
	Steam and hot water control dial left open.	Ensure the steam and hot water control dial is in the off position.
	Group filter may be blocked. The filter is blocked, the coffee grounds are too fine or tamped down too hard.	See "Descaling" pg 24. Empty out the filter and rinse under water to clean. Wipe the group head with a cloth. Repack the filter and do not tamp the grounds so firmly.
Coffee pours out in drops.	Coffee grind is too fine or too compacted.	Ensure you are using an evenly ground coffee and do not compact the grounds so firmly.
	Machine blocked by scale build up.	See "Descaling" pg 24.
Espresso does not have any crema.	Coffee is old or dry.	Use fresh coffee and once you open the coffee be sure to store it in an airtight container.
	Coffee not compacted firmly enough.	Compact coffee grounds more firmly.
	Coffee too coarse.	Grind the coffee to a finer texture or change brands of espresso coffee to a finer grind.

Trouble shooting guide (continued)

Espresso does not have any crema.	Not enough coffee in filter.	See "Guide to the perfect espresso" pg16.
Handle comes off during group.	Coffee tamped too hard.	Tamp the coffee grounds lighter.
	Coffee grind is too fine.	Change to a coarser grind of coffee.
	Filter handle is not attached correctly, or has not been tightened sufficiently.	Ensure the handle is firmly positioned onto the group head. See "Guide to the perfect espresso" pg16.
	Top edge of filter is not free of coffee grinds.	Clean around the edge of the filter and wipe the group head clean of coffee.
	The group head is dirty.	Wipe group head with a damp cloth.
	The group head is defective.	Contact a Sunbeam Service Centre.
	Group head rubber seal is worn or damaged.	Contact a Sunbeam Service Centre.
Coffee is too cold.	Cups, filter basket and group handle are cold.	Pre-heat cups, filters and group handle. See "Guide to the perfect espresso" pg 16.
	If making a cappuccino or latte the milk may not be heated enough.	Ensure that milk is heated properly during texturing, but be sure not to boil the milk. See "Guide to milk texturing" pg 18.
No steam from the steam nozzle.	Steam nozzle is blocked.	See "Care & Cleaning" pg 22.
	'STEAM' mode is not selected.	Press the 'STEAM' button so it is illuminated.
Not enough froth when frothing	Milk is not fresh.	Ensure the milk is fresh.
	Milk temperature is too warm to begin with.	Ensure that the milk is well refrigerated before use.
	Jug	For best texturing results use a stainless steel jug and if possible refrigerate or run the jug under cold water before use.
	Steam nozzle is blocked.	See "Care & Cleaning" pg 22.
	Milk has been boiled.	Start again with fresh, chilled milk.
	Steam nozzle not in correct position.	Position steam nozzle just below the surface of the milk.

Trouble shooting guide (continued)

Uneven cup filling.	Uneven tamping or obstruction in the pouring spouts.	Ensure coffee is tamped evenly and check that there is nothing obstructing the pouring spouts.
	Defective baffle in filter handle.	Contact a Sunbeam Service Centre.
	Bench surface is uneven	Reposition the machine on a level, even surface.
Espresso tastes burnt.	Type of coffee being used.	Experiment with different brands of coffee.
	Appliance has not been rinsed after descaling.	Run a reservoir full of water properly through the machine before making another coffee.
	Coffee pour is too slow as a result of fine grind.	Increase the coarseness of your coffee grind.
Pump makes an unusually load noise.	No water in reservoir.	Fill the water reservoir.
	Water reservoir not correctly positioned.	Replace the water reservoir firmly into the unit.
Machine does not operate.	Group head filter may be blocked.	Remove group handle and clean group head. See "Care & Cleaning" pg 22.
	Machine blocked by scale build up.	See "Descaling " pg 24.

Please contact Sunbeam directly on 1300 881 861, if this guide does not solve your query. We have experienced staff on hand to assist, Monday to Friday.

12 Month Replacement Guarantee

We are so confident of the quality of our product, should this appliance develop any malfunction within 12 months of purchase (3 months commercial use) due to faulty materials or manufacture, we will replace it for you absolutely free.

Should you experience any difficulties with your appliance, please phone our customer service line for advice on 1300 881 861 in Australia, or 0800 786 232 in New Zealand.

Alternatively, simply return the faulty appliance to your place of purchase, along with your purchase receipt.

Your Sunbeam 12 Month Replacement Guarantee naturally does not cover misuse or negligent handling, and excludes breakables such as glass or ceramic items, and normal wear and tear.

Similarly, your 12 Month Replacement Guarantee does not cover damage to household surfaces as a result of water or other substances leaking from your appliance, nor does it cover freight costs.

In Australia, this guarantee is additional to the conditions and guarantees which are mandatory as implied under the Trade Practices Act 1974 and State and Territory legislation.

Sunbeam Service Centres

Sunbeam has established a network of authorised service centres throughout Australia and New Zealand to provide quick, convenient service for our customers.

Should your appliance require repair or service, either during or after the guarantee period, contact your nearest service centre.

For a complete list of Sunbeam's authorised service centres:

Australia

www.sunbeam.com.au/service-centres
1300 881 861

New Zealand

www.sunbeam.co.nz/service-centres
0800 786 232

Consumer Hotline

In Australia

Visit www.sunbeam.com.au

Or call 1300 881 861

In New Zealand

Visit www.sunbeam.co.nz

Or call 0800 786 232



is a registered trademark.

'Artista' is a trademark of Sunbeam Corporation.

Designed and Engineered in Australia.

Made in China to Sunbeam's specification.

Due to minor changes in design or otherwise, the product you buy may differ from the one shown in this leaflet.

© Copyright. Sunbeam Corporation Limited 2008.

ABN 45 000 006 771

Sunbeam Corporation is a division of GUD Holdings Ltd.

Free Manuals Download Website

<http://myh66.com>

<http://usermanuals.us>

<http://www.somanuals.com>

<http://www.4manuals.cc>

<http://www.manual-lib.com>

<http://www.404manual.com>

<http://www.luxmanual.com>

<http://aubethermostatmanual.com>

Golf course search by state

<http://golfingnear.com>

Email search by domain

<http://emailbydomain.com>

Auto manuals search

<http://auto.somanuals.com>

TV manuals search

<http://tv.somanuals.com>