



**DVR-4TN**

**DVR-8TN**

**DVR-16TN**

**DVR-16TS**

**DVR-16TT**

**Triplex+ Digital Video Recorder Family  
With Network/DDNS Video Server**

[www.specotech.com](http://www.specotech.com)



## Caution and Preventive Tips

- Take care not to drop the unit or subject the unit to major shocks or jolts.
- Do not place this unit on an unstable stand, bracket or mount.
- This unit is designed for indoor use only. Do not place the unit near water or in other extremely humid conditions.
- This unit should not be placed in a built-in installation unless proper ventilation is provided.
- Please check the type of power source available before you plug and operate the unit.
- If the clearing is necessary, note to plug the unit from the outlet before uncovering the top cover. Do not use liquid cleaners or aerosol cleaners. Use only a damp cloth for cleaning.
- Always power down the system prior to connecting and disconnecting accessories, with the exception of USB devices.
- **Lithium battery: Danger of explosion if battery is incorrectly replaced.** Replace with the same type of battery or equivalent type recommended by the battery manufacturer. Dispose of used batteries according to the battery manufacturer's instructions.
- **Do not block the fan on the bottom of the unit – enough airflow is needed to protect the unit from overheating.**

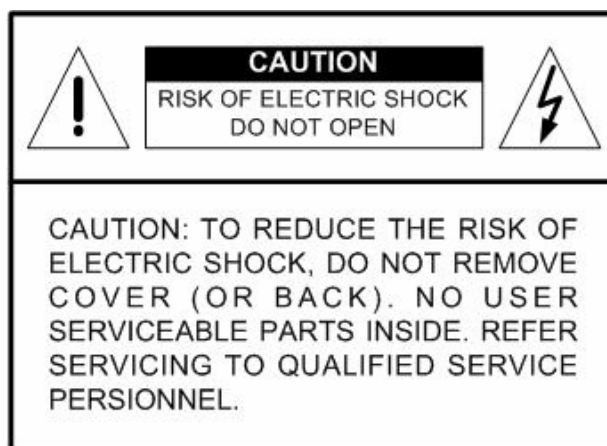

This symbol intends to alert the user to the presence of important operating and maintenance (servicing) instructions in the literature accompanying the appliance.



This symbol intends to alert the user to the presence of unprotected “Dangerous Voltage” within the product’s enclosure that may be strong enough to cause a risk of electric shock.

## Important Information

**Before proceeding, please read and observe all instructions and warnings in this manual.**

Retain this manual with the original bill of sale for future reference and, if necessary, warranty service. When unpacking your unit, check for missing or damaged items. If any item is missing, or if damage is evident, **DO NOT INSTALL OR OPERATE THIS PRODUCT**. Contact your dealer for assistance.

## Rack Mounting

Consult with the supplier or manufacturer of your equipment rack for the proper procedure and hardware for mounting this product in a safe fashion. Avoid uneven loading or mechanical instability when rack-mounting units. Make sure the units are installed to get enough airflow for safe operation. The maximum temperature for rack-mounted units is 104 °F/40 °C. Check product label for power supply requirements to assure that no overloading of supply circuits or over current protection occurs. Main grounding must be reliable and uncompromised by any connections.

## Table of Contents

<b>1. Overview .....</b>	<b>10</b>
1.1 Product Key Features .....	11
1.2 Product Application Diagram.....	12
<b>2. System Setup.....</b>	<b>12</b>
2.1 Position the Unit.....	13
2.2 Selecting Video Format.....	13
2.3 Connecting Devices to the Unit.....	13
2.4 Rear Panel Connections .....	14
<b>3. General System Setup .....</b>	<b>17</b>
3.1 Front Panel Introduction .....	17
3.1.1 LED Definition .....	18
3.1.2 Functional Keys.....	19
3.2 Install HDD to the Unit .....	22
3.3 Power Up / Down the Unit .....	23
3.4 Entering OSD Setup Menu .....	24
3.5 System Date / Time Setting .....	25
3.5.1 Set Date / Time.....	25
3.5.2 Daylight Saving Time.....	26
3.6 Record Schedule / Quality Setting.....	27
3.6.1 Record Mode.....	27
3.6.2 Schedule Setup .....	28
3.6.3 Preset Record Configuration .....	28
3.6.4 Per Camera Configuration.....	29
3.6.5 To Record Event Video Only .....	30
<b>4. Basic Operation.....</b>	<b>30</b>
4.1 Viewing Live / Playback Video .....	30
4.1.1 Viewing Modes.....	30
4.1.2 Digital Zoom .....	31
4.1.3 Viewing Live Cameras.....	31
To Freeze Live Image.....	31
4.1.4 Viewing Recorded Video .....	32
Key Usage in Playback .....	32
Pause Playback and Single Step Forward .....	33
Viewing Live Image in Playback Mode.....	33
4.1.5 Dual Main Output (For DVR-16TT Only) .....	33
4.2 Sequence Setup .....	34

4.2.1	Sequence on Main Monitor.....	34
4.2.2	Call Monitor Control.....	34
4.3	Searching Recorded Video.....	35
4.3.1	Searching by Time.....	36
4.3.2	Searching by Event.....	36
4.4	Video Export.....	37
4.4.1	Export from OSD Setup Menu.....	37
4.4.1.1	Select the External Device.....	38
4.4.1.2	Select Video for Exporting.....	39
4.4.1.3	Digital Signature.....	40
4.4.1.4	Erase Disc.....	40
4.4.2	Quick Video Export through Front Panel.....	40
4.4.2.1	ezBurn Introduction.....	41
4.4.2.2	To Export Normal Video.....	41
4.4.2.3	To Export Event Video.....	42
4.5	Deleting Recorded Video.....	43
4.6	Dome Control.....	44
4.6.1	Dome Connection.....	44
4.6.2	Dome Protocol Setup.....	45
4.6.3	RS485 Setup.....	45
4.6.4	Dome Controlling Key.....	46
4.6.5	Setting Preset Points.....	48
4.6.6	Calling Preset Points.....	49
<b>5.</b>	<b>Advanced System Configuration.....</b>	<b>49</b>
	Key Usage in OSD Menu.....	50
	Key Usage in Virtual Keyboard.....	50
5.1	System Setup.....	51
5.1.1	Version.....	52
5.1.1.1	Model Name & Version.....	52
5.1.1.2	Software Upgrade via Local Device.....	52
5.1.1.3	Software Upgrade via Internet.....	53
5.1.2	Language.....	53
5.1.3	Date / Time.....	54
5.1.3.1	Date / Time Setting.....	54
5.1.3.2	Date / Time Display.....	54
5.1.3.3	Date Display Mode.....	55
5.1.3.4	Time Display Mode.....	55
5.1.3.5	Date/Time Order.....	55
5.1.3.6	Daylight Saving Time.....	55
5.1.3.7	DST Start / End.....	55

---

5.1.3.8	DST Bias.....	56
5.1.4	Unit Name .....	56
5.1.5	Password .....	57
5.1.5.1	Admin / User Password(s) .....	57
5.1.5.2	Enable Password .....	57
5.1.5.3	Load Factory Password .....	58
5.1.6	Network Setup.....	58
5.1.6.1	LAN Select.....	59
5.1.6.2	LAN Setup.....	59
-	DHCP .....	59
-	IP .....	60
-	Netmask.....	60
-	Gateway.....	60
-	DNS .....	61
-	PPPoE Account.....	61
-	PPPoE Password.....	62
-	PPPoE Max Idle.....	62
-	Connect At Booting .....	62
-	Network Restart .....	62
5.1.6.3	Dial-in Setup .....	62
-	Dial-in Service.....	63
-	Dial-in Account.....	63
-	Dial-in Password.....	64
-	Server IP .....	64
-	Client IP .....	65
-	Dial-in Idle Time .....	65
-	Dial-in Max Time .....	65
5.1.6.4	Dial-out Setup .....	65
-	Dial-out DHCP .....	66
-	Dial-out IP .....	66
-	Dial-out Netmask .....	67
-	Dial-out Gateway .....	67
-	Dial-out DNS .....	67
-	Phone Number.....	67
-	Dial-out Account.....	68
-	Dial-out Password.....	68
-	Dial-out Idle Time .....	69
-	Dial-out Max Time .....	69
-	Connect .....	69
5.1.6.5	Trigger Port .....	69

5.1.6.6	Email Address .....	69
5.1.6.7	SMTP Setup.....	70
-	Email via SMTP .....	70
-	SMTP Server .....	71
-	SMTP Port .....	71
-	SMTP Account .....	72
-	SMTP Password .....	72
5.1.6.8	DDNS Setup .....	72
-	Enable DDNS.....	73
-	Host Name .....	73
-	DDNS Port .....	74
-	Submit/Update .....	74
5.1.7	RS485 Setup .....	74
5.1.7.1	Unit ID .....	74
5.1.7.2	Baud Rate .....	74
5.1.7.3	Bits .....	75
5.1.7.4	Stop.....	75
5.1.7.5	Parity.....	75
5.1.8	Audio Output .....	75
5.1.9	Key Beep.....	75
5.2	Monitor Setup .....	76
5.2.1	Show Camera Title .....	76
5.2.2	Monitor Brightness.....	76
5.2.3	Monitor Contrast.....	76
5.2.4	Monitor Chrominance .....	76
5.2.5	Screen Center Adjust .....	77
5.2.6	Show Color Bar .....	77
5.2.7	VGA Resolution .....	77
5.3	Camera Setup.....	78
5.3.1	Camera Select.....	78
5.3.2	Dome Protocol.....	78
5.3.3	Dome ID .....	78
5.3.4	Camera Title .....	79
5.3.5	Covert.....	79
5.3.6	Termination.....	80
5.3.7	Brightness .....	80
5.3.8	Contrast.....	80
5.3.9	Saturation .....	80
5.3.10	Hue.....	80
5.3.11	Audio Association .....	81



5.4	Record Setup.....	81
5.4.1	Record Mode.....	82
5.4.2	Schedule Setup.....	82
5.4.2.1	Day / Night Time Start / End.....	83
5.4.2.2	Weekend Schedule.....	83
5.4.2.3	Weekend Start / End.....	83
5.4.3	Preset Record Configuration.....	83
5.4.4	Per Camera Configuration.....	84
5.4.4.1	Camera Select.....	84
5.4.4.2	Normal PPS.....	84
5.4.4.3	Normal Qlty.....	84
5.4.4.4	Event Max PPS.....	85
5.4.4.5	Event Qlty.....	85
5.4.4.6	Event Active.....	85
5.4.5	ezRecord Setup.....	85
5.4.6	Data Lifetime.....	86
5.4.7	Pre-Alarm Recording.....	87
5.4.8	Circular Recording.....	87
5.4.9	Audio Recording.....	87
5.4.10	Purge Data.....	88
5.4.10.1	Purge All Data.....	88
5.4.10.2	Purge All Event Data.....	88
5.4.10.3	Purge Event Before.....	88
5.4.10.4	Start to Purge.....	88
5.5	Sequence Setup.....	89
5.5.1	Main / Call Monitor Dwell.....	89
5.5.2	Main / Call Monitor Schedule.....	89
5.6	Event Setup.....	90
5.6.1	Internal Buzzer.....	90
5.6.2	Event Icon.....	90
5.6.3	Email Notice.....	91
5.6.4	Event Full Screen.....	91
5.6.5	Event Duration.....	91
5.6.6	Per Channel Config.....	91
5.6.6.1	Channel Select.....	92
5.6.6.2	Video Loss Detect.....	92
5.6.6.3	Motion Detect.....	92
5.6.6.4	Detection Config.....	92
-	Detected Area Setup.....	93
-	Sensitivity.....	93

- Area Threshold .....	93
- Detected Area Percentage .....	93
5.6.6.5 Alarm In .....	94
5.6.6.6 Alarm Out.....	94
5.7 Database Setup .....	94
5.7.1 Total / Free Size of HDD.....	95
5.7.2 Avail. REC Time .....	95
5.7.3 Internal / External Disks .....	95
5.8 Configuration .....	96
5.8.1 Load Factory Default .....	96
5.8.2 Import Configuration.....	96
5.8.3 Export Configuration.....	97
5.8.3.1 Copy Destination.....	97
5.8.3.2 Configuration Name .....	97
5.8.3.3 Begin Export .....	98
5.9 Video Export .....	98
5.9.1 Select Device .....	99
5.9.2 Select Channel.....	99
5.9.3 From / To Time .....	100
5.9.4 Select Events .....	100
5.9.5 Data Type .....	100
5.9.6 Digital Signature .....	101
5.9.7 Erase Disc.....	101
5.9.8 Begin Export.....	101
5.10 Shutdown.....	101
<b>Appendix A: Technical Specifications .....</b>	<b>103</b>
<b>Appendix B: Record Configuration.....</b>	<b>105</b>
<b>Appendix C: Record Duration.....</b>	<b>109</b>
<b>Appendix D: Dial-up Connections via Modem .....</b>	<b>112</b>
Establishing Dial-in Connection .....	112
Establishing Dial-out Connection .....	116
<b>Appendix E: Verifying Digital Signature .....</b>	<b>122</b>
<b>Appendix F: Alarm I/O Pin Definition .....</b>	<b>125</b>
<b>Appendix G: Hard Disk Installation .....</b>	<b>127</b>
<b>Appendix H: HDD PC Player Tool Introduction .....</b>	<b>131</b>
<i>Using EXT2IFS on Your PC.....</i>	131
<i>Start Playing the *.drv file.....</i>	133
<b>Appendix I: IR Remote.....</b>	<b>135</b>
<b>Appendix J: ezRecord Diagram Sample .....</b>	<b>136</b>

## 1. Overview

The **DVR-4TN/8TN/16TN/16TS/16TT** series unit is an integrated digital video recorder that combines the features of a time-lapse audio / video recorder, a multiplexer, and a video server to create a single security CCTV solution.

Its outstanding triplex+ operation enables users to view live or playback recorded video, have remote access through network simultaneously while recording other video, and to view previously recorded video instantly by entering the time and date or selecting recorded video from the event list.

The total number of PPS (Pictures per Second) makes the main difference among these models, shown as below table:

	DVR-4TN/8TN/16TN	DVR-16TS	DVR-16TT
NTSC	120 pps	240 pps	480 pps
PAL	100 pps	200 pps	400 pps

The **DVR-4TN/8TN/16TN/16TS/16TT** series includes **SpecoRemote™**, the remote viewing and configuration software that is a Web-browser plug-in, which allows the user to view live, or recorded video images, and enables remote configuration. The remote software is stored in the **DVR-4TN/8TN/16TN/16TS/16TT** series unit and deployed over a LAN, WAN or Internet connection to remote Windows-based computers. This simplifies the installation and maintenance of the software components so all remote users are kept up to date.

### DVR-4TN



### DVR-8TN



## DVR-16TN/16TS/16TT

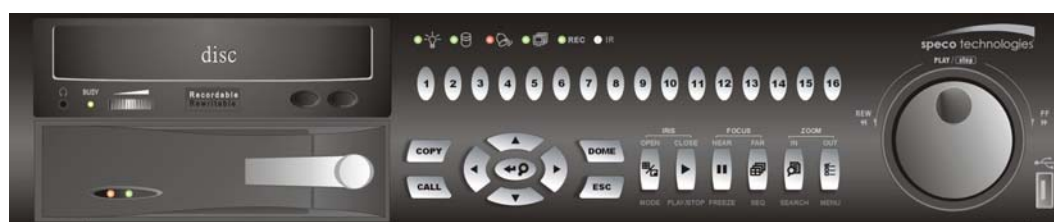

### 1.1 Product Key Features

The **DVR-4TN/8TN/16TN/16TS/16TT** series offers advanced features not typically found in standard multiplexers; it integrates the full features of a DVR, multiplexer and video server (by using the software **SpecoRemote™**). The key features of the **DVR-4TN/8TN/16TN/16TS/16TT** series are listed as follows.

- MPEG-4 high quality compression
- 16 channels for video input
- Triplex+ operation enabling simultaneous viewing live or playback while continuing to record
- **SpecoRemote™** web-based software for remote monitoring and control via LAN or Internet
- Embedded Linux operating system
- Real-time “live display” for each channel
- Recording frame rate up to 480 pps(NTSC)/ 400 pps(PAL)
- 2 Channels of audio recording/ playback
- Three USB2.0 ports for video clip export and/or backup
- Easy software upgrade via USB ThumbDrive®, CD/RW or Internet Remote Application
- Up to 4 internal hard drives support up to 1TB capacity
- IEEE 1394 for external storage
- 2X Digital Zoom available in both live and playback mode
- Export video (AVI) with audio and digital Signature
- Exported AVI file can be played in any PC with DIVX decoder installed
- Automatic camera detection (Plug & Play)
- Covert camera operation provides enhanced security and administrator control
- Per camera configuration for camera settings, frame rate, picture bit rate, alarms, motion detection.
- Programmable day/ night/ weekend scheduling
- Programmable main monitor/ call-monitor switching sequence

- Powerful alarm processor allows flexible alarm trigger and responses, including alarm, motion, and camera failure
- Dome control protocols: Speco, Pelco D, Pelco P, Fastrax 2 and AD422
- Two levels of password security

## 1.2 Product Application Diagram

Connect the unit with other devices as shown in the system diagram below to complete a video surveillance solution. The figure also displays the expandability and flexibility of this digital recording system.

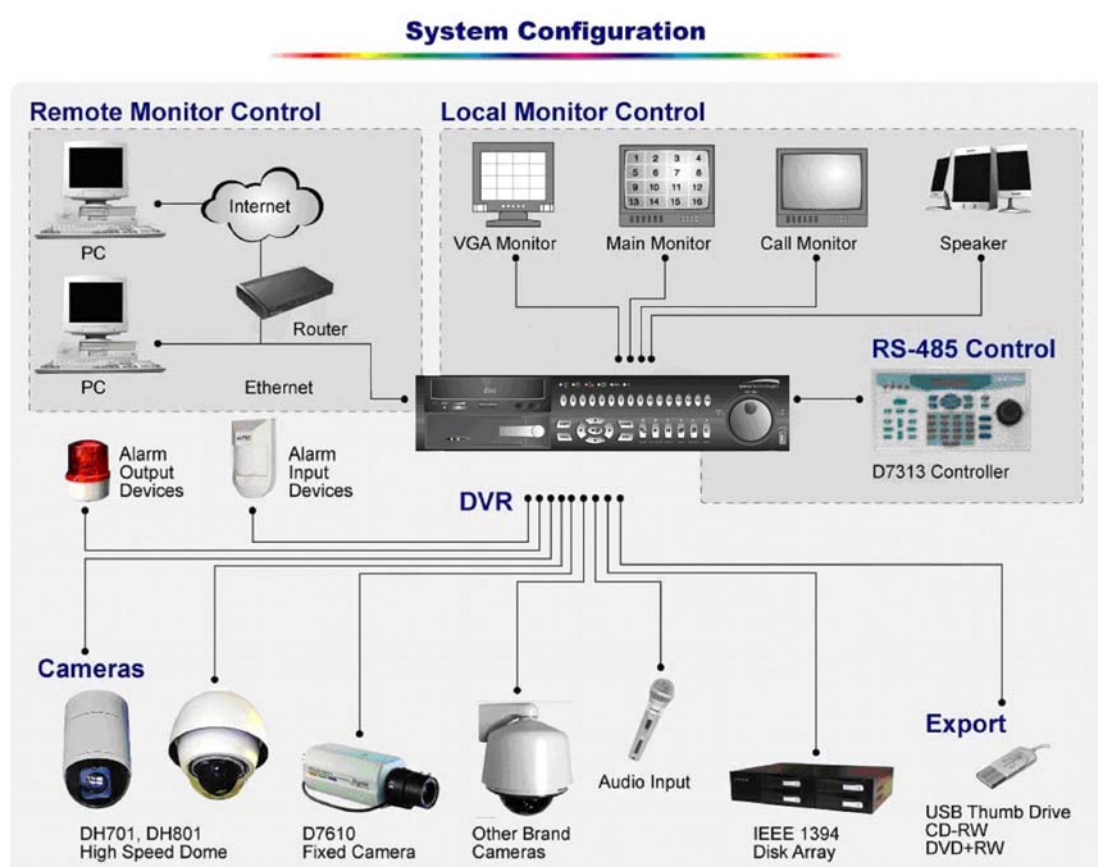

## 2. System Setup

Priority notices and an introduction on system installation will be described in this chapter. Please follow the instructions to operate the unit.

In order to prevent the unit from data loss and system damage that can be caused by a sudden power fluctuation, use of an Uninterruptible Power Supply (UPS) is highly recommended.

## 2.1 Position the Unit

Position / mount the **DVR-4TN/8TN/16TN/16TS/16TT** series unit in an appropriate, steady location and make sure the power is off before making any connections. The area should avoid hindering or blocking the unit from airflow. **Enough airflow is needed to protect the unit from overheating.** The maximum allowable temperature of operating environment is 104°F/40°C.

The unit utilizes heat-conducting techniques to transfer internal heat to the case, especially to the bottom side of the unit.



**NOTE: Be sure not to remove the rubber feet, and always leave a space for air ventilation on the unit's bottom side.**

## 2.2 Selecting Video Format

The **DVR-4TN/ DVR-8TN/ DVR-16TN** series unit is designed to operate under either NTSC or PAL video formats. Please contact a qualified service person to perform the installation procedure.

## 2.3 Connecting Devices to the Unit

This section lists some **important notices that should be read before making any connections** to the **DVR-4TN/8TN/16TN/16TS/16TT** series unit.



**NOTE:** Connect short-term external devices, such as USB ThumbDrive<sup>®</sup>, USB CD-RW, USB Hard Disk Drive, etc., only after the unit is successfully powered up.

### **Connecting Required Devices**

**Before powering up**, you should connect cameras and a main monitor to the unit for basic operation. If needed, connect a call monitor for displaying full screen video of all installed cameras in sequence.

## Connecting Short-term Device

If you plan to install any short-term external devices, such as USB CD-RW, USB Hard Disk Drive, etc, to the **DVR-4TN/8TN/16TN/16TS/16TT** series and want to use them as part of the unit system. **Make sure those devices are connected only after the DVR-4TN/8TN/16TN/16TS/16TT is powered up.** The **DVR-4TN/8TN/16TN/16TS/16TT** series unit can only recognize the external devices after the power-up process is completed.

## 2.4 Rear Panel Connections

There are several connectors on the rear panel of the **DVR-4TN/8TN/16TN/16TS/16TT** series units available for installations. The following figure shows the connectors by name and a detailed description of each connector follows.

There is one difference between the rear panel of different models; **DVR-4TN/8TN/16TN** has an IEEE 1394 connector and **DVR-16TS/TT** has a 1000M LAN Port instead, shown as below figures.

### Rear Panel of DVR-4TN/8TN/16TN:

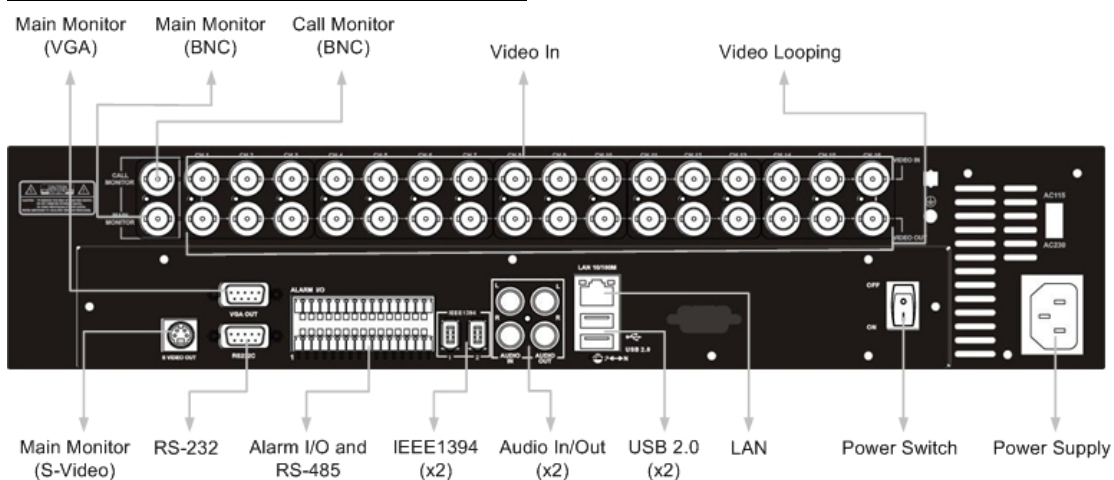

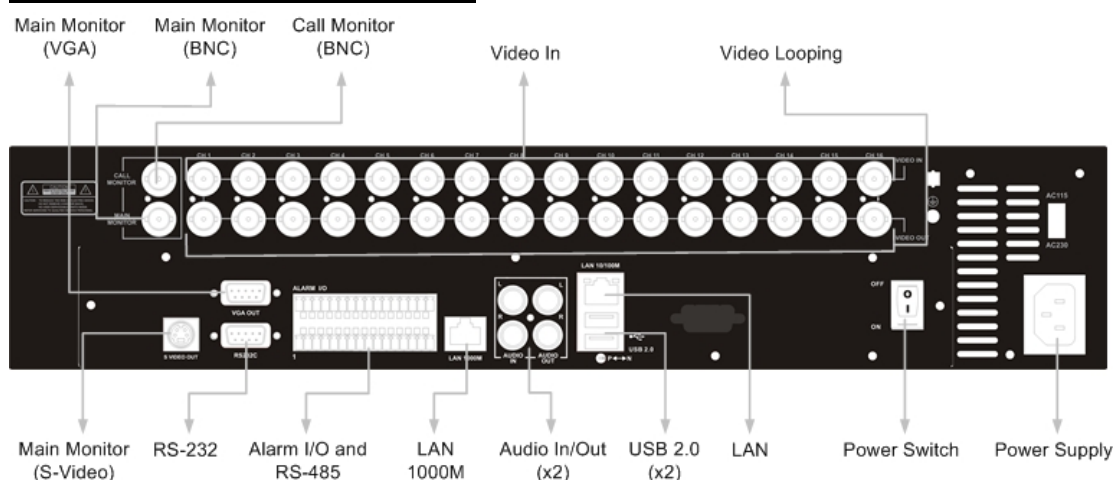
**Rear panel of DVR-16TS/16-TT:****Main Monitor (S-Video/ BNC/ VGA)**

S-Video, BNC and VGA output connectors are available for connecting to a main monitor. The main monitor displays live image and playback recorded video in full-screen or multiple window format.

**RS-232C**

The unit provides a RS-232C communication port for sending and receiving signals.

**Alarm I/O & RS485 Port**

The unit provides an Alarm I/O and RS485 port that offers user the flexibility required to connect the unit to another device.

Refer to [Appendix F: Alarm I/O Pin Definition](#) for detailed pin information on the Alarm I/O for the **DVR-4TN/8TN/16TN/16TS/16TT**.

**IEEE1394 (for DVR-4TN/8Tn/16TN only)**

**DVR-4TN/ DVR-8TN/ DVR-16TN** series unit is equipped with two IEEE1394 (FireWire®) ports for extended connections.

**LAN 1000M (for DVR-16TS/16-TT only)**

This port is for **DVR-16TS/16-TT** to connect to a NAS device.



### **Audio In / Out**

The **DVR-4TN/8TN/16TN/16TS/16TT** series unit provides two channels of audio recording and playback. The Audio In RCA connector is offered for connecting an audio source device (e.g. external amplified microphone) to the unit. The Audio Out RCA connector is available for connecting an audio output device (e.g. amplified speakers) to the unit.

### **USB 2.0 (x3)**

There are two USB2.0 ports on the rear panel and one on the front panel to allow users to connect external USB devices to the unit, such as a ThumbDrive®.

The **DVR-4TN/8TN/16TN/16TS/16TT** allows the user to preset the OSD settings using a USB mouse.

### **LAN (RJ-45)**

The **DVR-4TN/8TN/16TN/16TS/16TT** series is capable of networking. The LAN port allows the **DVR-4TN/8TN/16TN/16TS/16TT** series to access the network/Internet through an Ethernet connection.

### **Power Supply**

The **DVR-4TN/8TN/16TN/16TS/16TT** series includes an AC power connection jack. Please use the power supply that ships with the unit.

**WARNING:** Use of a different power supply may cause overloading.



**NOTE:** Use of other power supply may cause overloading.

### **Power Switch**

Used to power up and shut down the unit.

### **Call Monitor (BNC)**

The call monitor is used to display full screen video of all installed cameras in sequence. The BNC call monitor connector allows the user to connect an optional call monitor to the **DVR-4TN/8TN/16TN/16TS/16TT** series unit.

### **Video Input**

A group of BNC connectors are available for video input streams from installed cameras. The number of connectors is equal to the number of channels; the **DVR-4TN/8TN/16TN/16TS/16TT** units have 4/ 8/ 16 BNC connectors on the rear panel, respectively.

### **Camera Looping**

Groups of BNC connectors are positioned on the rear panel for looping out video input.

## **3. General System Setup**

The **DVR-4TN/8TN/16TN/16TS/16TT** series DVR allows the user to easily access some general operations through the front panel. The following subsections introduce general operation of the unit.

The regularly displayed OSD information and its positions are shown in the following figure. The channel title is displayed on the top-left side of the window, either in full screen mode or in multiple channel mode. The current operating mode, including Call mode, Dome-Control mode, Playback mode. Freeze mode and Sequence mode, is displayed on the bottom-left side of the screen. The date/ time information is displayed on the bottom-right side.

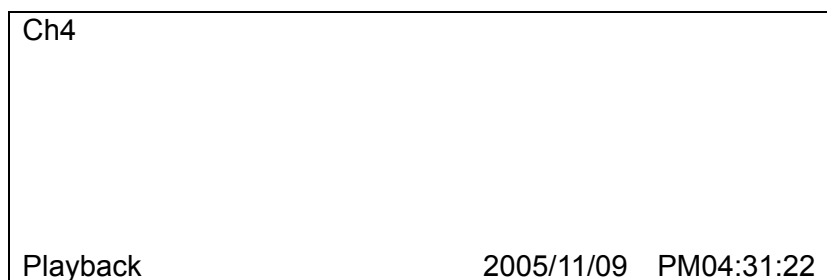

### **3.1 Front Panel Introduction**

The unit's front panel controls enable the user to control the unit and preset programmable functions.

### 3.1.1 LED Definition

The **DVR-4TN/8TN/16TN/16TS/16TT** series LEDs on the front panel are described as follows.

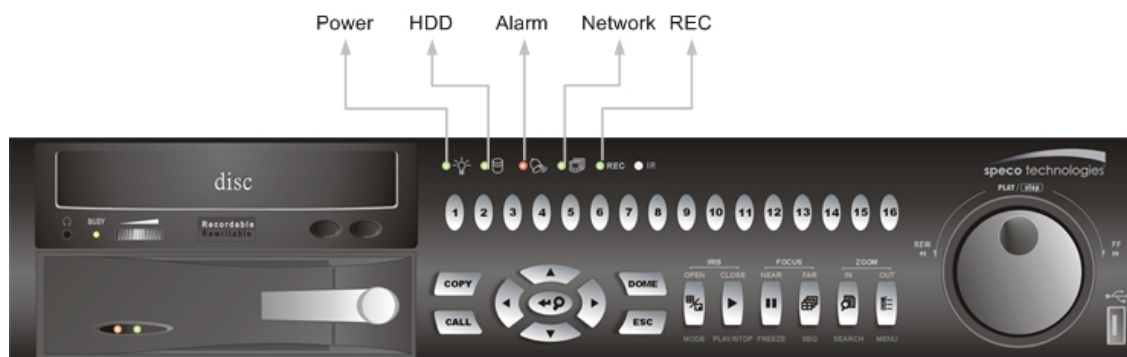

#### **Power LED (Green)**

The LED should be lit when the power is connected.

#### **HDD LED (Yellow)**

The LED will be lit while the HDD is processing data to or from the connected HDD(s).

#### **Alarm LED (Red)**

The LED should be lit when an alarm is triggered.

#### **Network LED (Green)**

The LED should be lit when the **DVR-4TN/8TN/16TN/16TS/16TT** series unit is connected to a network and blink when any data is being transferred.

#### **REC LED (Green)**

The LED should blink while the **DVR-4TN/8TN/16TN/16TS/16TT** series unit is recording.

### 3.1.2 Functional Keys

The **DVR-4TN/8TN/16TN/16TS/16TT** series unit function keys on the front panel are described below for normal operation.

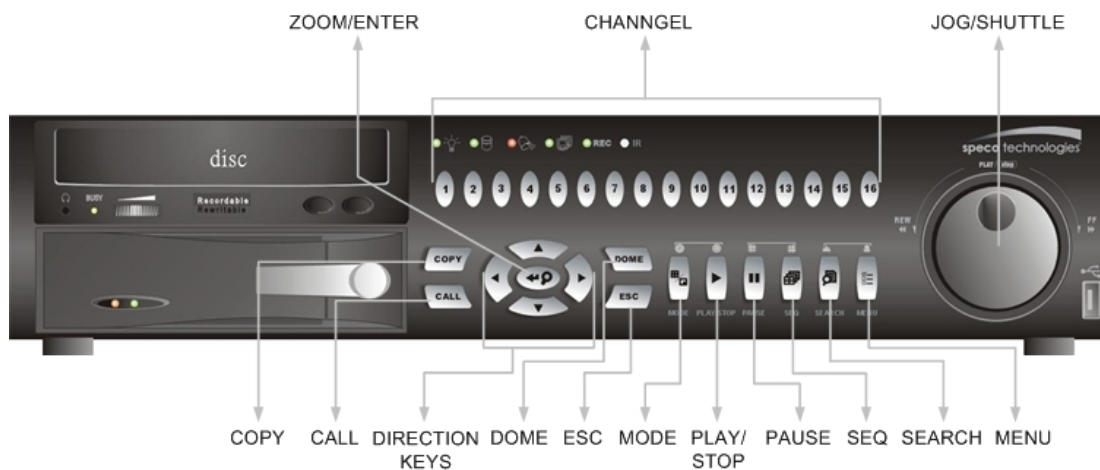

#### **COPY**

Used to quick export video to an external device, including USB CD-RW and ThumbDrive®, etc. For more detailed operation instructions refer to Section 4.7.1 To Export Video..

#### **CALL**

Press to enter call monitor control mode; press ESC to exit.

#### **Direction Keys**

- In Zoom mode, these keys function as Direction keys.
- In the OSD setup menu, the Direction keys are used to move the cursor to previous or next fields. To change the value in the selected field, press UP / DOWN keys.

#### **HOME**

Press this key to enter dome control mode. Please refer to Section 4.6 Dome Control for more details about controlling operation.

#### **ESC**

Press to cancel or exit from certain mode or OSD menu without changing the settings made previously.

## **MODE**

Press repeatedly to select desired main monitor display format. There are three view modes available: full screen, 4-window (2x2) and 16-window (4x4). Refer to Section 4.1.1 Viewing Modes for more detailed information.

## **PLAY/STOP**

Press this key to switch between live image and playback video.



**NOTE:** Video taken within the latest 5 ~ 10 minutes cannot be played back because the video is still saved in the buffer.

## **FREEZE**

- Press FREEZE while viewing live image, the live video will be frozen, but the date / time information shown on the monitor will continue updating. Press FREEZE again to return to live mode.
- Press FREEZE while playing recorded video, the playback video will be paused. Press LEFT / RIGHT to move the recorded video reverse / forward by a single step. Press FREEZE again to continue playing video.

## **SEQ (Sequence)**

Press to start automatic sequencing of the video coming in from the installed cameras.

## **SEARCH**

In both Playback and Live mode, the user can press SEARCH to call up the Search menu for searching and playing back recorded video by date and time or events.

## **MENU**

Press this key to call up the OSD setup menu.

## **ZOOM/ENTER**

- In OSD menu or selection interface, press this key to make the selection or save settings.
- In live full screen view mode, press to view a 2x zoom image; press key again to return.

## **CHANNEL**

- When in both Live and Playback modes, press the CHANNEL key to view the corresponding video in full screen. The number of the CHANNEL keys corresponds to the number of cameras supported by the unit.
- When in dome control mode, the key named "1" is used to access the Set/Go preset menu; the key named "2" is used to hide or display the dome setting parameters.

## **JOG/SHUTTLE**

The jog/shuttle knob, shown in the figure below, is a combination of a shuttle ring with an embedded jog disk, which is used to provide wide latitude in playback control. Note that the jog/shuttle knob is active only when the DVR unit is in Playback mode.

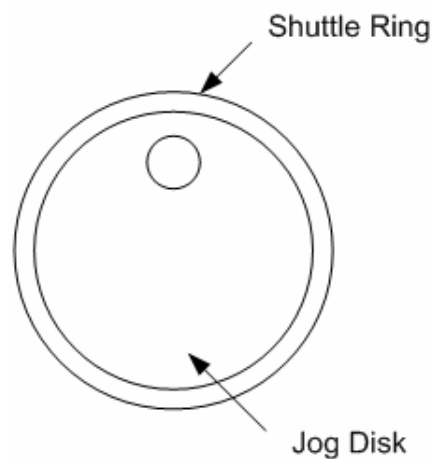

- While playing back video, you can use the shuttle ring to select different speeds of forward and backward playing. Rotating the shuttle ring counterclockwise causes the unit to playback in fast forward/ backward playing speed. According to the angle you rotate the shuttle ring, you can choose the playing speed from 1x, 2x, 4x, 8x, 16x, and 32x, in both forward and reverse directions, shown in the figure below:

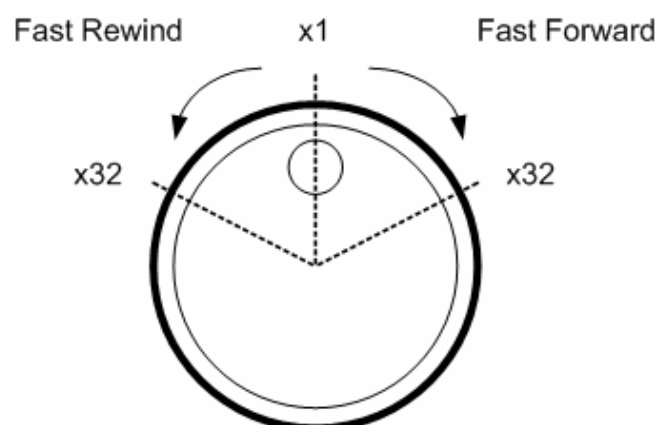

- Inside the shuttle ring is the jog disk, shown in the illustration below, it can turn completely in either direction. Once you freeze the video, you can use the jog disk to go to single-step play back. Clockwise rotation causes forward one-step playback; and counterclockwise rotation causes backward one-step playback.

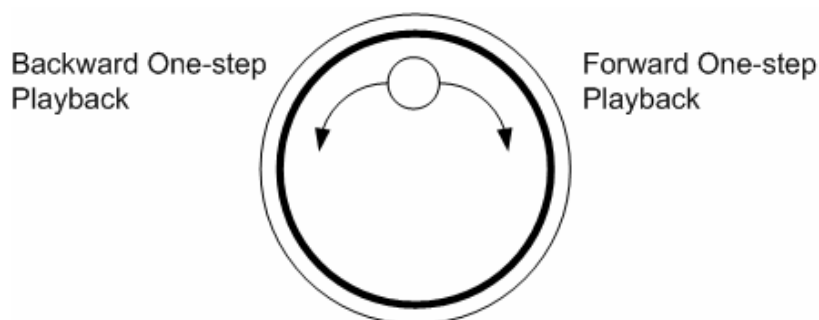

## 3.2 Install HDD to the Unit

There is an empty cartridge positioned on the front panel where the user can install a swappable HDD. There are two possible situations when you install a HDD into your DVR.

- If you install a new HDD, the DVR will format it and add it into your database automatically.
- If you install a used HDD that does not have the DVR format, the DVR will show, "1 disk(s) with wrong data format! Please format then add to the database manually". Then please follow the steps described below:
  - Enter the menu with the administrator privilege and access the <Database Setup> section
  - Access the <Internal (or external) Disks>
  - When you see the available disk/s, select <format> to format it
  - After formatting is OK, select <Add> to add them into your database.

### 3.3 Power Up / Down the Unit

If you must shut down the **DVR-4TN/8TN/16TN/16TS/16TT** series unit for any reason, use the proper shut down and power up procedures to avoid damage to your DVR unit..

#### To Power Up the Unit

First check the type of power source available is compatible before plugging in your DVR and turn on the unit using the power switch on the rear panel.

The color bar and system checking information will be shown on the monitor and disappear when the unit has been completely powered up.

#### To Restart / Shutdown the Unit

Press MENU and input the administrator password to access the OSD Main menu. Select <Shutdown> in Main Menu and press ENTER to enter the Shutdown menu, which displays as follows.

Shutdown	
1. Power Off	Execute
2. Reboot	Execute

#### **<Power Off>**

Select this item to shut down the unit. Do not disconnect the power during shut down until the message "You can safely turn off DVR now!" displays.

#### **<Reboot>**

Select this item to reboot the unit. The color bar and system checking information are displayed on the monitor until the unit is completely restarted.



## 3.4 Entering OSD Setup Menu

The OSD Main menu contains a list of items that are used to configure the **DVR-4TN/ DVR-8TN/ DVR-16TN** series. To enter the Main menu, correct Administrator or User password is required.

Three sets passwords are offered for different Administrators and Users--if there is more than one.

To enter OSD Main menu, press MENU and then enter either Administrator or User password. The Password Verification screen will then display as follows.

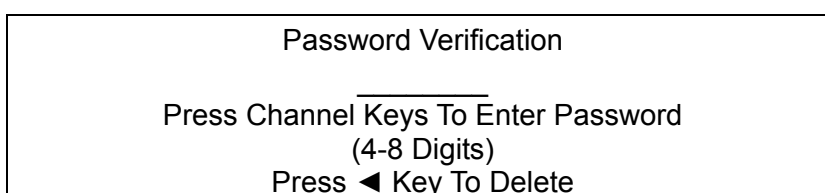

**NOTE:** If entering wrong password for 3 times, the system will be locked out, and you will not be able to enter OSD menu within 2 minutes.

The default passwords are shown in the following table. The same passwords are used for entering the remote viewing software **SpecoRemote™**.

Administrator Passwords	User Passwords
1234	4321

It is strongly recommended that you change the passwords to prevent unauthorized access to the unit.

After entering the correct password, the Main menu is displayed.

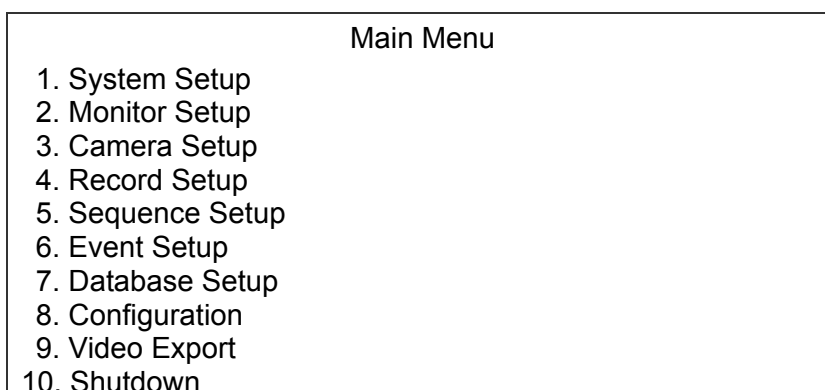

Move the cursor up / down over the OSD items using the Direction keys and press ENTER to enter the selected sub-menu.

## 3.5 System Date / Time Setting

The user can set the current date, time and other OSD parameters in the Date/Time menu. The administrator's privileges are required for entering the submenu. In the OSD Main menu, select <System Setup> and press ENTER, then select <Date/Time> to access the Date/Time menu; the menu displays as follows.

Date/Time	
1. Date	2005/02/21
2. Time	PM10:39:26
3. Date/Time Display	1 Row
4. Date Display Mode	Y/M/D
5. Time Display Mode	24 HR
6. Date/Time Order	Date First
7. Daylight Saving Time	OFF
8. DST Start	Apr, 1st Sun, 02:00
9. DST End	Apr, Last Sun, 02:00
10. DST Bias	60 Min

### 3.5.1 Set Date / Time

#### Set Date / Time

Select <Date> / <Time> and press ENTER to adjust the settings. LEFT / RIGHT keys are used to move the cursor to previous or next field, ENTER is for selecting, and UP / DOWN are used to change the value in the selected field.



**NOTE:** The reset date / time setting applies for recording new video, the date and time of previously recorded video will not be changed.



**NOTE:** To avoid record database corruption, after changing the date / time setting, it is recommended to clear the database.

#### Date / Time Display

Users are allowed to choose to set the date / time OSD displays in 1 or 2 rows. Use the UP / DOWN keys to change the setting. The default is to display the date / time OSD in one row.

**Date Display Mode**

This function allows user to set the OSD display type of the date / time. There are three options to select from: <Y/M/D>, <M/D/Y> or <D/M/Y>. “Y” represents “Year”, “M” represents “Month” and “D” represents “Day”.

Move to the desired item and press ENTER, the option starts blinking. Use UP / DOWN keys to change the setting. The default setting is <Y/M/D> in both NTSC / PAL formats.

**Time Display Mode**

The user can choose to set the time format to <12 hour> or <24 hour>. Use the UP / DOWN keys to change the format. The default setting is <24 hour>.

**Date / Time Order**

This item is used to set the order of the date / time display to <Date First> or <Time First>. Use UP / DOWN keys to change the setting.

## 3.5.2 Daylight Saving Time

**Daylight Saving Time**

This item is for those people who live in certain regions to observe Daylight Saving Time. Select <ON> to enable, or <OFF> to disable the function.

If the function is disabled, the DST Start / End time and DST Bias will be grayed out and cannot be accessed.



**NOTE:** If this function is enabled, the date/time information will be shown on the screen with a DST icon when playing back recorded video or searching video in the event list. “S” indicates summer time and “W” indicates wintertime.

**DST Start / End**

This is used to program the daylight saving duration. Use Direction keys to move the cursor to the next or previous field, use UP / DOWN to change the settings in the selected field.

**DST Bias**

This allows the user to set the amount of time to move forward from the standard time for daylight saving time. The available options are <30>, <60>, <90> and <120> minutes.

## 3.6 Record Schedule / Quality Setting

The Record Setup menu allows the user to set recording quality, recording schedules and other recording parameters. This menu will not be able to access if you enter the OSD Setup Menu with User's password. In the Main menu, move the cursor to <Record Setup> and press ENTER; the following menu is displayed.

Record Setup	
1. Record Mode	720x240@60PPS
2. Schedule Setup	
3. Preset Config	Standard
4. Per Camera Config	
5. ezRecord Setup	
6. Data Lifetime	0 Days
7. Pre-Alarm Recording	15 Sec
8. Circular Recording	ON
9. Audio Recording	ON
10. Purge Data	

### 3.6.1 Record Mode

The Record Mode is for selecting resolution and recording rate. The relative record settings, such as preset configuration, will follow the record mode setting. In normal circumstance, we recommend you to select <720 x 240@60PPS> in NTSC format; or <720x288@50PPS> in PAL format.

Move the cursor to <Record Mode> and press ENTER, then select a Record mode using the UP / DOWN keys.



**NOTE:** After changing the Record Mode setting, this warning message "This will FORMAT ALL HARDDISKS and LOAD THE FACTORY DEFAULT CONFIG!" will appear on the screen. Press ENTER to confirm the selection. The unit will then start to format the hard disks and load the factory default settings, or press ESC to abort.

**We strongly recommend that you back up your programmed configuration before making any changes to Record Mode settings.**

## 3.6.2 Schedule Setup

The Schedule Setup is used to set the day, night, or weekend recording schedule. Select <Schedule Setup> from the Record Setup menu and press ENTER; the following menu is displayed.

Schedule Setup	
1. Day Time Start	06:00
2. Day Time End	18:00
3. Night Time Start	18:00
4. Night Time End	06:00
5. Weekend Schedule	YES
6. Weekend Start	Fri PM18:00
7. Weekend End	Mon AM 06:00

- Make appropriate changes for the start time of the Day Time and Night Time schedule using the Direction keys.
- Press ENTER to confirm the settings or ESC to cancel.
- If you want to record over the weekend, choose <YES> to enable the Weekend Schedule in advance and then set the Weekend Start/End time.
- Press ESC to back to previous page.

## 3.6.3 Preset Record Configuration

The <Preset Config> is used to preset recording quality and frame rate for normal record and event record. In normal circumstances, we strongly suggest you set the item to <Standard>, the default. Below tables show the PPS and picture size under <Standard> in Half-D1 mode. Please refer to Section [5.4.3 Preset Record Configuration](#) for more detailed information.

### DVR-4TN/8TN/16TN

Half-D1 mode (NTSC: 720x240@60PPS; PAL: 720x288@50PPS)				
	Normal PPS	Normal Quality	Event PPS	Event Quality
4CH	NTSC:15 PAL:12.5	12 KB	NTSC:30 PAL:25	20 KB
8CH	NTSC:7.5 PAL:6.25			
16CH	NTSC:3.75 PAL:3.12	15 KB		25 KB

**DVR-4TS**

<b>Half-D1 mode (NTSC: 720x240@120PPS; PAL: 720x288@100PPS)</b>				
	<b>Normal PPS</b>	<b>Normal Quality</b>	<b>Event PPS</b>	<b>Event Quality</b>
<b>16CH</b>	NTSC:7.5 PAL:6.25	12 KB	NTSC:30 PAL:25	20 KB

**DVR-4TT**

<b>Half-D1 mode (NTSC: 720x240@240PPS; PAL: 720x288@200PPS)</b>				
	<b>Normal PPS</b>	<b>Normal Quality</b>	<b>Event PPS</b>	<b>Event Quality</b>
<b>16CH</b>	NTSC:15 PAL:12.5	6 KB	NTSC:30 PAL:25	10 KB

### 3.6.4 Per Camera Configuration

This function is used to set the Day / Night / Weekend PPS (Picture per Second) and Quality for each channel. The Preset Configuration must be set to <OFF> for accessing these schedules. The menu displays as follows: (Record Mode: 720x240@60PPS in NTSC / 720x288@50PPS in PAL).

Per Camera Config			
Camera Select	<b>Day</b>	<b>Night</b>	<b>CH1 Weekend</b>
Normal PPS	7.5	7.5	7.5
Normal Qlty	Best	Best	Best
Event Max PPS	30	30	30
Event Qlty	Best	Best	Best
Event Act	Both	Both	Both

- First, select a Camera to set its record configuration. The image and record settings from the selected camera will be displayed on the screen.
- Move the cursor using the Direction keys and press ENTER to select an item.
- Change the value using UP / DOWN keys.
- Press ENTER to confirm the settings or ESC to abort.
- Press ESC to return to Record Setup menu.

Please note that the total normal pps for all channels cannot exceed 60 NTSC (720x240@60PPS) / 50 PAL (720x288@50PPS). To increase one channel's pps, you may have to reduce other's first. Event pps is not restricted to this rule, since a smart event schedule will correct the total pps automatically..

### 3.6.5 To Record Event Video Only

If you want your DVR unit to start recording only under the alarm is triggered, follow the steps:

- Enter the OSD setup menu with correct password.
- In the OSD setup menu, select <Record Setup> menu. Move the cursor to the item <Preset Config>, and select <Event only>.

Refer to Section [5.4.3 Preset Record Configuration](#) for more detailed information.

## 4. Basic Operation

The **DVR-4TN/8TN/16TN/16TS/16TT** series allows the user to easily access some general operations through the front panel. The following sections introduce the general operation of the unit.

### 4.1 Viewing Live / Playback Video

The general functions in live and playback mode are described in the sections that follow.

#### 4.1.1 Viewing Modes

The **DVR-4TN/8TN/16TN/16TS/16TT** series supplies the user several ways of viewing both live and recorded video. The following descriptions describe the view formats that are available.

##### Viewing in Full Screen

Press any CHANNEL key directly to view the corresponding camera image in full view format.

##### Viewing in Multi-window

Various multi-window view formats are available for selection. To switch between these viewing formats, press MODE repeatedly.

The available view formats are illustrated in the following figure.

. Note that 3x3 and 4x4 viewing modes are for **DVR-16TN** model only.

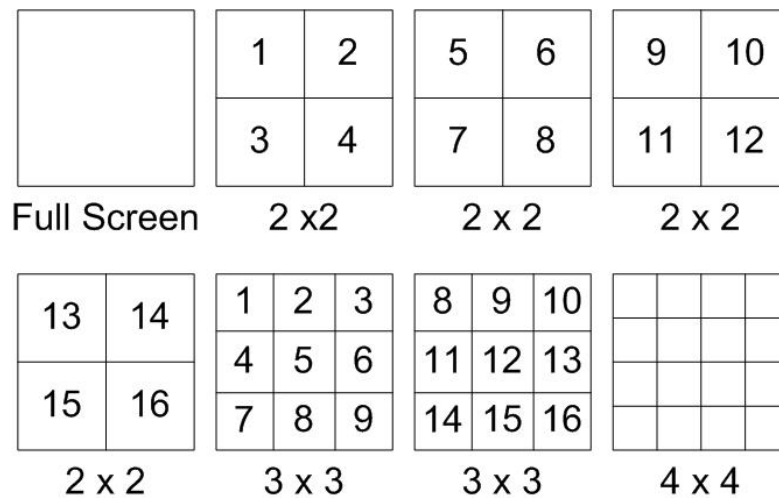

## 4.1.2 Digital Zoom

Users are able to view a 2x full screen in live mode. To view the 2x full screen, follow these steps:

- Press the CHANNEL key to view the corresponding camera in full screen.
- Press ZOOM to enter a 2x full screen zoom mode of the selected camera.
- If you need to view a specific area of the 2x zoomed screen, use Direction keys to pan / tilt the zoomed area around the original image.
- Either press ZOOM again or ESC to leave the zoom mode.

## 4.1.3 Viewing Live Cameras

Users are allowed to view live cameras in several view modes, including full-screen, 2x2, 3x3 and 4x4. General operation under live mode is described as follows.

### To Freeze Live Image

Press FREEZE while viewing a live image, the image then pauses, but the date / time information does not, and the system clock continues running..

Press FREEZE to pause the live image; press FREEZE again to resume the live camera view.



## 4.1.4 Viewing Recorded Video

To view recorded video, the user can press the PLAY/STOP key directly. When the PLAY/STOP key is pressed, the unit starts to continue playing back the recorded video from the suspended point of record. If the PLAY/STOP key is being used for the first time, the unit will playback from the very beginning of the record. Alternatively, a user can select records from the Search menu to play specific video. Refer to section [4.3 Searching Recorded Video](#) for more information.

The Forward or Reverse speed indicator will be shown on the bottom-left of the screen when in the playback mode.

General operation for playback mode is described as follows.

### **Key Usage in Playback**

Key usage changes slightly in playback mode as follows.

#### **<LEFT>** (Reverse Playback)

This key is used to reverse recorded video while the unit is playing back.

Press the key repeatedly to increase the speed of reverse playback by 1x, 2x, 4x, 8x, 16x, or 32x.

#### **<RIGHT>** (Forward Playback)

This key is used to play recorded video on fast forward. Press the key repeatedly to increase the speed of forward playback by 1x, 2x, 4x, 8x, 16x, or 32x.

#### **<FREEZE>**

Press FREEZE to pause the playback video. When the recorded video is paused, press LEFT / RIGHT to resume playback video as single step reverse / forward, respectively. Press FREEZE again to continue playing video.

#### **<PLAY/STOP>**

Press to start playing back video, to exit current mode, or stop playing back video and go back to live mode.

### **Pause Playback and Single Step Forward**

To pause and resume recorded video, follow these steps.

- Press one of the CHANNEL keys to display the corresponding camera in full screen.
- Press PAUSE to pause the current playback image.
- Press LEFT/ RIGHT Direction keys to move the video as single step reverse / forward. Press and hold LEFT/RIGHT keys to reverse / forward the video single step continuously.
- Press PAUSE again to resume the playback operation.

### **Viewing Live Image in Playback Mode**

Press the MODE key repeatedly in playback mode, the 16-window viewing mode contains both live and playback image views. This view mode is illustrated below.

1	2	3	4
5	6	7	8
1	2	3	4
5	6	7	8

Live Image

Playback

The eight windows on the top side of the screen play back the Live video from channel 1 to channel 8 respectively. The other windows allow the user to view Playback images from channel 1 to channel 8.

## **4.1.5 Dual Main Output (For DVR-16TT Only)**

For **DVR-16TT** users, they can use the Call Monitor as the second Main Monitor, and access lots of functions, such as setup OSD menu, and viewing in different mode, through the second Main Monitor. To perform this function, you have to reset a jumper positioned on the Turbo Module inside the unit.

To use this function, the VGA and BNC connectors, positioned on the rear panel, have to be connected with monitors, respectively. The VGA monitor is treated as the Main Monitor, and BNC monitor the second Main Monitor.

Press CALL key for 3 seconds, the BNC Monitor will be given the same function as the VGA Monitor, except Playback and Search function. You can use the BNC Monitor to take over the **DVR-16TT** unit at the same time, as if the two monitors are connected to two individual **DVR-16TT** units.

When using this function, a small figure (  ) appears in the mid-button side of the two monitors—the yellow one represents the monitor is now accessed.



**NOTE:** When the VGA monitor is now under Dome Control Mode' or the OSD setup mode, or hasn't exit the OSD menu, the BNC monitor cannot access the OSD setup menu.

## 4.2 Sequence Setup

This section introduce you how to view in sequence mode with both Main Monitor and Call Monitor, if connected. Sequence function can avoid manually backtracking and give more flexibility while surveillance.

### 4.2.1 Sequence on Main Monitor

The automatic sequence function can be used in any view mode. Select certain view format and press SEQ to toggle the automatic sequential sequence, press ESC to stop sequencing. The figure below displays the 4-camera sequencing view modes.

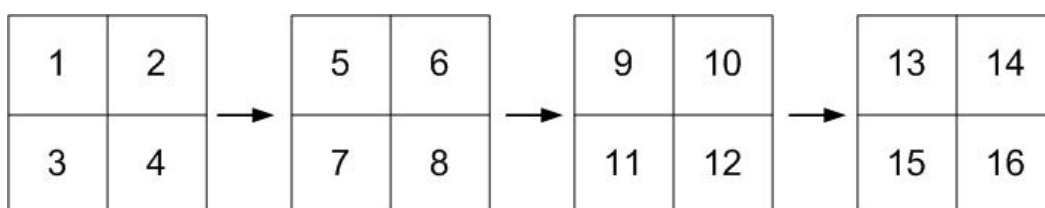

### 4.2.2 Call Monitor Control

Users can use the **DVR-4TN/8TN/16TN/16TS/16TT** series unit front panel to control a call monitor display without having to access the Main menu. Two viewing modes can be displayed on call monitor: Sequence display and Single camera display. To program the call monitor sequence, see section [5.5 Sequence Setup](#).

Follow the steps below to control the call monitor.

- Press the CALL key on the front panel to enter call monitor control mode, the message "Call Mode" will then be shown on the bottom-left of the screen.

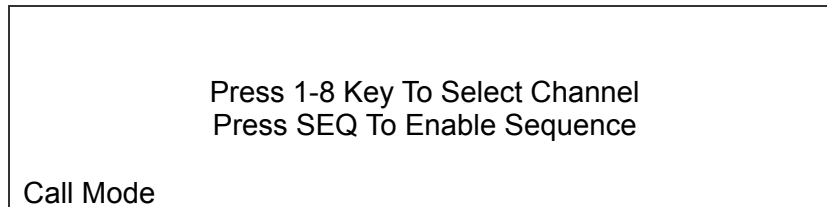

- Press CHANNEL key to display the associated camera on the call monitor.
- Alternatively, press SEQ repeatedly to display the sequence of cameras previously programmed in Call Monitor Schedule menu.
- Press ESC to return to the front panel to the Main monitor control mode.

### 4.3 Searching Recorded Video

The **DVR-4TN/8TN/16TN/16TS/16TT** series is capable of searching and playing back recorded video by date and time or events. By entering the specific date and time of the desired video, the unit will then search for the matched video and play it on the monitor. Alternatively, a user can search event video by selecting the channel as well.

In live or playback mode, press SEARCH to enter the Search menu, which is shown as follows.

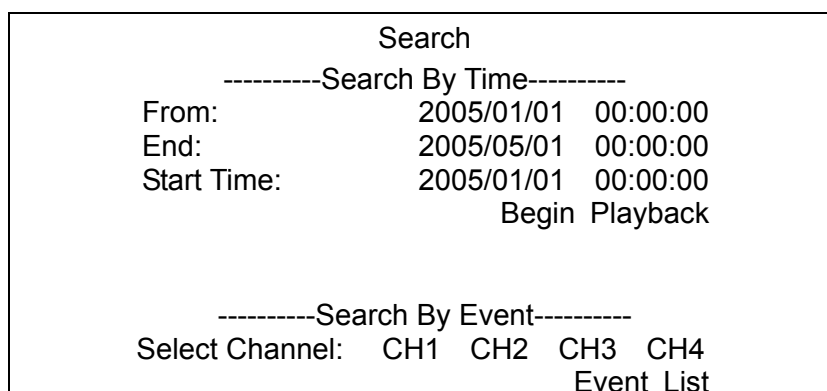

### 4.3.1 Searching by Time

Follow these steps to search video by date and time.

- Press SEARCH key to enter the Search menu; the From Time and End Time of the available video is listed on top of the screen. The value is unchangeable.
- Use Direction keys to move the cursor for setting the Start Time; adjusting the date and time values by UP / DOWN keys.
- Press ENTER to confirm the settings or ESC to abort.
- Move the cursor to <Begin Playback> and press ENTER to start playing back the selected video.
- Either press PLAY/STOP again or ESC to return to live video.



**NOTE:** If there is no available recorded video that matches your specified time and date, the unit starts playback from the next available video.



**NOTE:** The date/time information will be shown on the screen with a DST icon if the Daylight Saving Time function is enabled. "S" indicates summer time and "W" indicates wintertime.

### 4.3.2 Searching by Event

"Event List" allows you to search for desired video by event. The Event List is displayed below:

Event List			
Date	Time	Ch.	Type
2005/03/17	11:26:50	2	Motion
2005/03/17	09:53:03	5	Alarm
2005/03/16	16:14:42	3	Alarm
2005/03/15	03:45:31	1	Motion
2005/03/12	22:27:56	1	Alarm
2005/03/12	10:09:29	7	Motion
2005/03/11	12:18:20	6	Motion
2005/03/10	05:16:00	4	Alarm
2005/03/08	17:11:37	2	Motion
2005/03/08	16:29:10	8	Motion
2005/03/08	03:22:17	2	Alarm

The list displays the first 9999 events by date, time, triggered camera and alarm type. As some events are deleted, others are displayed. The latest recorded event video will be listed on the top.

Follow these steps to search event video through the Event List:

- Press SEARCH to enter the Search menu.
- To search event video that has been recorded on a specific camera, use LEFT / RIGHT to move the cursor and press ENTER to select or de-select a channel.
- Move the cursor to <Event List> and press ENTER to list the event video from the selected channels. The Event List displays.
- To exit the event list, press ESC.

Follow these steps to playback video from the Event List.

- Press and hold UP / DOWN to scroll through the Event List.
- Press ENTER to play back the selected event record.
- Press PLAY/STOP to return to live mode.

## 4.4 Video Export

The following sections will guide you how to export video through the OSD Setup menu and through the hot keys positioned on the front panel, respectively.

### 4.4.1 Export from OSD Setup Menu

The Video Export menu enables the administrator to export recorded video with a digital signature to a USB ThumbDrive<sup>®</sup>, a CD-RW or to DVD+RW drive. Administrator's password is required to export video.

The exported video will be identified by the exporting date and time, and classified by event type. Each recorded video will be exported into four files if exported with digital signature, including \*.gpg, \*.avi (\*.drv), \*.sig and readme.txt.

Make sure an external storage device is available and connected to the appropriate port for video export.

From the Main menu, select <Video Export> and press ENTER. The menu is displayed below.

Video Export			
1. Select Device			
2. Select Ch:	CH1	CH2	CH3 CH4
3. From	2005/03/19	AM	07:50:05
4. To	2005/03/28	PM	03:09:18
5. Select Events			
6. Data Type			Normal
7. Digital Signature			NO
9. Erase Disc			NO
10. Begin Export			NO

#### 4.4.1.1 Select the External Device

The available external devices for exporting video will be listed by name and free size in Select Device menu. The Select Device menu displays as follows:

Select Device		
Device Name	Available	Sel
xxx-xxx-x-x-xx	256 MB	NO
xx-xxx-xx-xxxx	1.5 GB	NO

The **DVR-4TN/8TN/16TN/16TS/16TT** series only supports EXT3 file system. If you connect an external HDD to the unit, make sure the format of the HDD is EXT3. If not, please format this HDD to EXT3 first.

##### <Device Name>

This item shows the name of the available device.

##### <Available>

This item shows the free space of the available device.

##### <Select>

Set the item to <YES> to start the export or <NO> to cancel.

## 4.4.1.2 Select Video for Exporting

After selecting video clips, set the item <Begin Export> to <YES> and press ENTER to start exporting. Following are the menu items for selecting video.

### Select Channel

Select the channel that the administrator wants to export. Move the cursor to the desired channel using LEFT / RIGHT keys, select or de-select a channel by pressing ENTER.

### From / To Time

These items are used to set the time in which data export begins and ends. Move the cursor using Direction keys, and press ENTER to select the date / time items; adjust the selected date and time value by UP / DOWN keys.



**NOTE:** The exported data between the Start Time and End Time includes both normal and event video.

### Select Events

Select the item to display the event list for exporting event video. Move the cursor to scroll through the event list and press ENTER to select the event you want to export.

### Data Type

This item is used to select export video type. The options are <Normal> (export normal video only), <Event> (export event video only) and <Both> (export both normal and event video).



**NOTE:** If you want to export event video only, then set the “From” and “To” items at the same date and time. Otherwise, not only the event video but also the normal video included between the “From” date/ time and “To” date/time will be exported.

The \*.drv file can only be played back with **SpecoRemote™** and **SpecoPlayer™** and multiple camera video can be played from one file. Note that if multiple channels are exported, each channel is exported to a separate file.



### 4.4.1.3 Digital Signature

The user can export a video clip with or without a digital signature. Set the item to <YES> to export with the signature file, or <NO> to export without the signature file.

Each recorded video with a digital signature will be exported automatically into four files, including \*.gpg, \*.avi, \*.sig and readme.txt. The \*.gpg file name is the same as the last eight MAC (Media Access Control) address digits of the unit.

Make sure that you have an external storage device, such as a USB Hard Drive or USB ThumbDrive<sup>®</sup>, available and connected to the appropriate port for export.

For more information about verifying a digital signature, see [Appendix E: Verifying Digital Signature](#).

### 4.4.1.4 Erase Disc

This function is used to remove information found on a CD-RW or DVD+RW disk prior to exporting new information to the drive. Select <YES> and press ENTER to start deleting data.

## 4.4.2 Quick Video Export through Front Panel

The unit provides you a quick way to export video files to the built-in CD-RW or an external device, such as a USB thumb Drive, and save the video to \*.drv file.

If you want to export video to an external device, make sure the external storage unit has been connected to the DVR unit and the port has been set appropriately for video export.



**NOTE:** Once an external device has been connected to the DVR unit, the device has priority over the built-in CD-RW; which means that the desired video will be exported to the external device instead of the built-in CD-RW.

Export may take you about 10 minutes to 1 hour depending on the file size of the video.

### 4.4.2.1 ezBurn Introduction

Built with the ezBurn technology, ezBurn function provides users the easier way to export desired video with CD-RW built in or to an external device connected, such as a USB ThumbDrive®.

TWO keys (SEARCH and COPY) and THREE touches are all you need for completing the export. The whole exporting process will be done through the front panel, but no need to enter the OSD setup menu.



The ezBurn export process is illustrated on the next page:

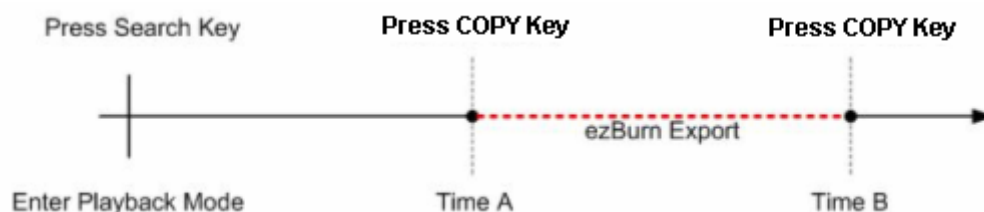

The whole process is described step by step in the following sections.

### 4.4.2.2 To Export Normal Video

To Export normal video to an external device, follow these steps:

- Press SEARCH and play desired normal video by entering date and time. Note: if you are viewing in multiple channel mode, please make sure there is no window displaying in Live mode. Otherwise, the export will not work.
- After entering playback mode, play the video and press COPY on the point that you want to set the start point of the export. The playback continues.

- Press COPY again on the point that you want to set the end point of the export. Now, the “ezBurn” window displays as shown below. The information shown on the window is for read only.

```

ezBurn confirmation
Selected Device: Built-in-CD-RW
All data on the disc will be erased.
Exported Required Size = 11 MB
Real Export Range:
From: 2005/11/07 AM10:41:13
To: 2005/11/07 AM10:41:21
Enter: YES ESC: NO

```

- Press ENTER to start the export; or, press ESC to abort
- If there is not any exportable external device connected to the DVR unit, then a warning message will be shown on the screen, as illustrated below:

```

No exportable device detected.
Please install the target device/media
to the DVR.
Enter: Retry ESC: Exit

```

### 4.4.2.3 To Export Event Video

To export event video, follow these steps:

- Press SEARCH and play desired event video. To play event video, refer to Section 4.3 Searching Recorded Video.
- After entering the playback mode, press COPY. The “ezBurn” window displays as shown below . The information displayed is for “read only.”.

```

ezBurn confirmation
Selected Device: Built-in-CD-RW
All data on the disc will be erased.
Exported Required Size = 11 MB
Export Event Info:
Data          Time          Ch          Type
205/11/07    AM10:42:35    13          Motion
Enter: YES   ESC: NO

```

- If there is not any exportable external device connected to the DVR unit, a warning message will be shown on the screen

- Press ENTER to start to export the event video to the connected external device; or, press ESC to abort.



**NOTE:** The inserted CD will be ejected when its capacity is 99% full.

## 4.5 Deleting Recorded Video

The user can delete recorded video in the Purge Data menu. The administrator password is required to access the function. Select <Record Setup> from Main menu, once in the Record Setup menu, move the cursor to <Purge Data> and press ENTER; the Purge Data menu is displayed.

Purge Data	
1. Purge All Data	NO
2. Purge All Event Data	NO
3. Purge Event Before	2000/01/01
4. Start to Purge	NO

The first three items are used to select the data that you want to purge. After selecting the data you want to delete, set the fourth item <Start to Purge> to <YES> and press ENTER to start the deleting process. The menu items are described below.

### **Purge All Data**

Select this item to delete all normal recorded video from the database.

### **Purge All Event Data**

Select this item to delete all event video from the database.

### **Purge Event Before**

This item is used to delete event video that was recorded before a specific date.

## 4.6 Dome Control

The **DVR-4TN/8TN/16TN/16TS/16TT** series unit allows the user to control a dome camera at the front panel.

In Live mode, the user can press the CHANNEL key to display the appropriate dome camera in full view. To enter Dome Control mode, press the DOME key and press channel key 2 to display the hint screen. To exit the Dome Control mode and go back to live mode, press ESC or DOME. To configure the dome control settings, see the following sections.

### 4.6.1 Dome Connection

Follow the steps below to install a dome camera.

- See section [2.4 Rear Panel Connections](#) for RS-485 port pin definition.
- Using a RS-485 cable, connect the R+, R- terminals from the dome camera to the D+, D- terminals on the RS-485 port respectively. Refer to the following illustration.

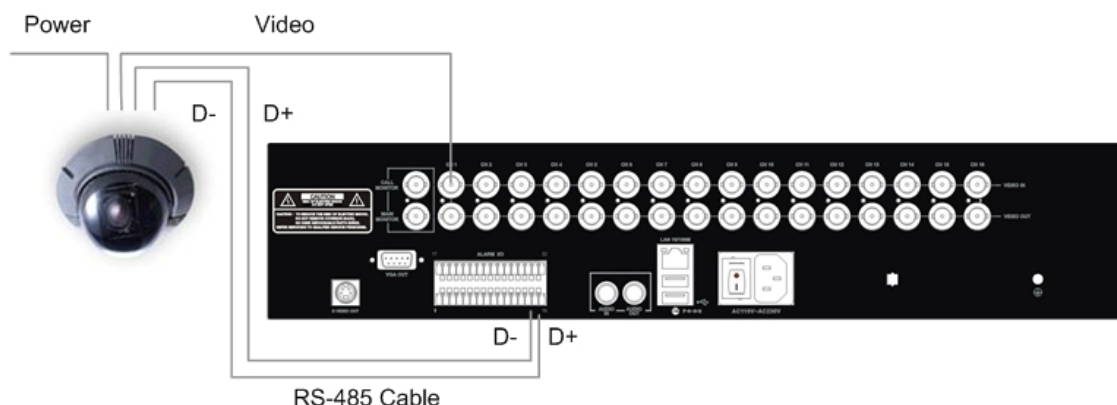

## 4.6.2 Dome Protocol Setup

The Dome Protocol menu item lists the dome protocols available for communicating with dome cameras connected to the **DVR-4TN/8TN/16TN/16TS/16TT** series unit. From the Main menu, select <Camera Setup> and press ENTER. The following menu is displayed.

Camera Setup	
1. Camera Select	CH1
2. Dome Protocol	None
3. Dome ID	0
4. Camera Title	
5. Covert	NO
6. Termination	NO
7. Brightness	0
8. Contrast	0
9. Saturation	0
10. Hue	0
11. Audio Association	Both

To configure dome protocol, first select a camera then set the communications protocol associated with that dome camera using the Direction keys and press ENTER. The available protocols include <Speco>, <Pelco D>, <Pelco P>, <AD422>, <Fastrax 2> and <None> (default).



**NOTE:** The settings become effective after saving the changes and exiting from the menu.

## 4.6.3 RS485 Setup

The **DVR-4TN/8TN/16TN/16TS/16TT** series unit controls the domes via RS-485 communication protocol. The RS-485 parameters in the **DVR-4TN/8TN/16TN/16TS/16TT** series unit must be set to the same parameters as the protocol used in the RS-422 setup for the dome.

Users are allowed to change the RS-485 settings of the **DVR-4TN/8TN/16TN/16TS/16TT** series unit. Select <System Setup> in the Main menu, then select <RS485 Setup> from the System Setup menu and press ENTER. The following menu is displayed.

RS485 Setup	
1 Unit ID	224
2 Baud Rate	9600
3 Bits	8
4 Stop	1
5 Parity	None

The ID number must match the ID address set by the dome. The Unit ID is within the range of 1 to 255. The default ID is 224. Note that no two devices on the same bus should be given the same ID address, or a conflict may occur.

The default **DVR-4TN/ DVR-8TN/ DVR-16TN** series RS-485 settings are 9600 Baud, 8 Data Bits, 1 Stop Bit and No Parity.

**NOTE:** The settings become effective after saving the changes and exiting from the menu.

#### 4.6.4 Dome Controlling Key

The function keys used in Dome Control are illustrated below.

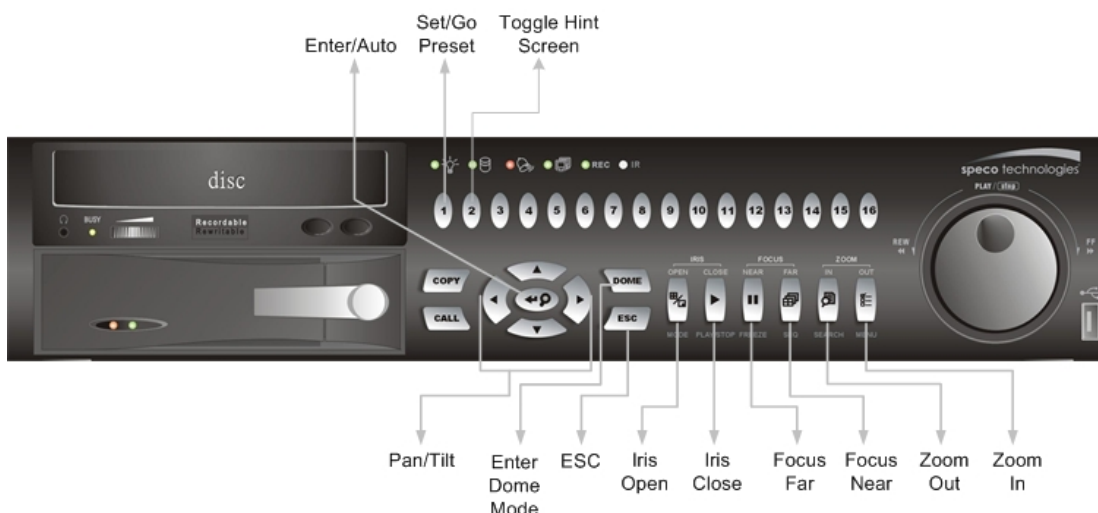

##### Set / Go Preset

This key is used to enter the Dome Preset menu to enable the set up of a specific position as a preset and to go to the predetermined preset positions for viewing.

**Toggle Hint Screen**

This function is used to avoid viewing the dome parameter information while controlling the dome camera. Press this key to hide the screen. Press it again to redisplay the screen.

**Iris Open**

Use this function to open the Iris on the dome camera.

**Focus Near**

Use this function to focus the dome camera near.

**Zoom In**

Use this function to zoom the dome camera in. This enables the user to move closer to the viewing area.

**ESC**

Use this function to leave dome control mode and return to live and full screen viewing mode.

**Auto / Enter**

- In OSD Menu mode, this key is used to make selection.
- In dome control mode, this key is used to activate automatic focus and iris function.

**Iris Close**

Use this function to close the Iris on the dome camera.

**Focus Far**

Use this function to focus the selected dome camera far.

**Zoom Out**

Use this function to zoom the dome camera out. This enables the user to move away from the viewing area

**Pan / Tilt**

Use this function to pan and tilt dome camera.



## 4.6.5 Setting Preset Points

The **DVR-4TN/8TN/16TN/16TS/16TT** series unit allows user to set preset positions; the amount of preset points allowed depends on the dome manufacturer.

Follow these steps to set preset points..

- Press a Channel key to view the corresponding camera in full screen.
- Then press DOME to enter dome control mode.
- Use Direction keys to position the dome camera to desired position.
- Press 2 to view the dome control Hint Screen; press 2 again to toggle the Hint Screen.

Hint Screen	
DOME / ESC:	Exit
MODE / PLAY:	Iris Open / Close
SEQ / FREEZE:	Focus Near / Far
MENU / SEARCH:	Zoom In / Out
ENTER:	Auto Focus / Iris
◀▲▼▶:	Pan / Tilt
CH1:	Set / Go Preset
CH2:	Hint Screen On / Off
Dome Control	

- Press 1 to access the Set/Go Preset function. The Dome Preset menu is then displayed.

Dome Preset		
Index	Set Preset	Go Preset
1	NO	NO
2	NO	NO
3	NO	NO
4	NO	NO
5	NO	NO
6	NO	NO
7	NO	NO
8	NO	NO
9	NO	NO

- Use UP / DOWN keys to select the desired preset number from the menu.
- Change the <Set Preset> of the selected preset number to <YES>, and press ENTER to save the position. Now the preset is set and ready to call.

## 4.6.6 Calling Preset Points

Follow these steps to call preset points.

- Press a Channel key to view the corresponding camera in full screen.
- Then press DOME to enter dome control mode.
- Press 2 to view the dome control Hint Screen; press 2 again to toggle the Hint Screen.
- Press 1 to access the Set/Go Preset function.

Dome Preset		
Index	Set Preset	Go Preset
1	NO	NO
2	NO	NO
3	NO	NO
4	NO	NO
5	NO	NO
6	NO	NO
7	NO	NO
8	NO	NO
9	NO	NO

- Use UP / DOWN keys to select the desired preset number from the menu.
- Change the <Go Preset> of the selected preset number to <YES>, and press ENTER to call the preset point.
- Now the selected dome camera rotates to the preset position automatically.

## 5. Advanced System Configuration

The detailed functions and settings of the **DVR-4TN/8TN/16TN/16TS/16TT** series can be set by using the hierarchical OSD menu. This chapter describes the menu items and options in the OSD menu.

To enter the Main menu, press MENU and then enter Administrator or User password. The default passwords are shown in the following table. The same default passwords are used for entering the remote viewing software **SpecoRemote™**.

Administrator Password	User Password
1234	4321

It is strongly recommended to change the passwords to prevent unauthorized access to the unit.

After entering the correct password, the Main menu is displayed.

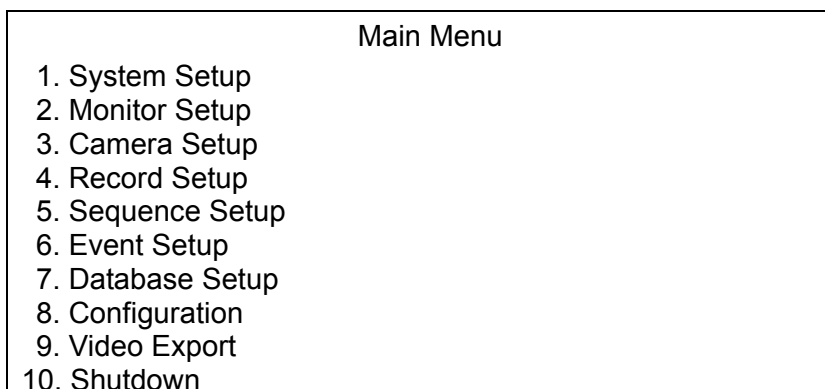

## Key Usage in OSD Menu

### **<Direction Keys>**

In the OSD menu, Direction keys are used to move the cursor to previous or next fields. UP / DOWN are used to change the value in the selected field.

### **<ENTER>**

In OSD menu or selection interface, press the key to make selection or save settings.

### **<ESC>**

Press to cancel or exit from certain OSD menu without saving any changes.

## Key Usage in Virtual Keyboard

A virtual keyboard shows when edit the settings, such as camera title, e-mail address, etc. The virtual keyboard displays as follows.

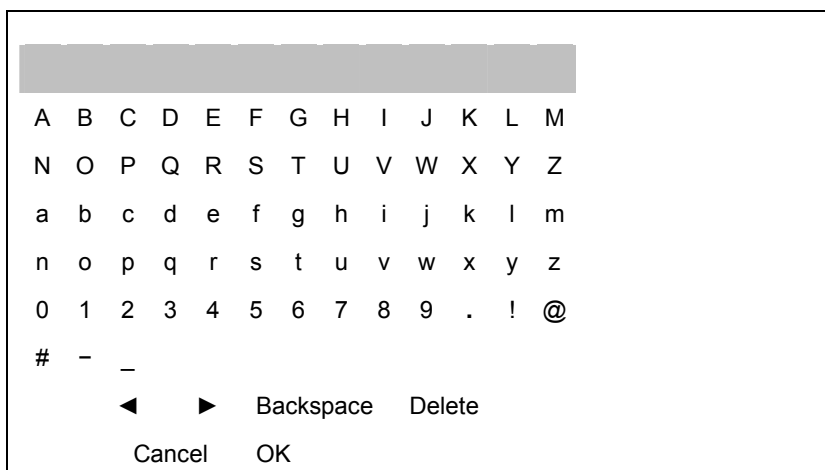

**<To input characters>**

Move the cursor by pressing Direction keys and press ENTER to select characters.

**<To move the cursor in title entry>**

Press MODE and LEFT / RIGHT simultaneously to move the cursor to left / right in the title entry.

**<To delete previous character>**

Select <Backspace> and press ENTER, or press MODE and UP simultaneously.

**<To delete current character>**

Select <Delete> and press ENTER, or press MODE and DOWN simultaneously.

**<To exit the virtual keyboard>**

Select <OK> and press ENTER to save the settings and exit, or press ESC to exit without saving changes

## 5.1 System Setup

Select <System Setup> from the Main Menu and press ENTER to enter the System Setup menu.

System Setup	
1. Version	
2. Language	English
3. Date/Time	
4. Unit Name	DVR
5. Password	
6. Network Setup	
7. RS485 Setup	
8. Audio Output	Live/Playback
9. Key Beep	YES

The items found in the System Setup menu are described in the following sections.

## 5.1.1 Version

The Version menu allows the user to view system information such as hardware and software versions. From the System Setup menu, select <Version> and press ENTER. The following menu is displayed.

Version	
Model Name	xxxxxxx
Hardware	V1.0
Software	xxxx-xxxx-xxxx-xxxx
Software Upgrade via Local Device	
Software Upgrade via Internet	

The items in this menu are described in the following subsections.

### 5.1.1.1 Model Name & Version

The first three items tell the model name and identify the hardware and software version for this unit.

### 5.1.1.2 Software Upgrade via Local Device

This item is used for updating the **DVR-4TN/ DVR-8TN/ DVR-16TN** series software by local device. The menu is displayed as follows.

Software Upgrade via Local Device	
Upgrade Version	Select
xxxx-xxxx-xxxx-xxxx	NO

Connect a USB drive that contains the upgrade software to the unit; the upgrade files that are available will then be listed in the menu. To update the system, select a file and use UP / DOWN keys to choose <YES>. Press ENTER to confirm the selection and start the upgrade process. The **DVR-4TN/8TN/16TN/16TS/16TT** series unit uploads the software, updates the system files, and reboots automatically.

The upgrade process may take several minutes to complete. After rebooting the unit, please check the software version again.



**NOTE:** If you want to upgrade your unit with a USB ThumbDrive® contains the newest software, make sure the software you want to use to update the unit should be fold into a folder named “upd-200s”, otherwise, the unit cannot recognize it.



**NOTE:** Power interruption cannot occur during the software upgrade process. Ensure that no power interruption can happen until the unit is completely rebooted.



**NOTE:** Do not remove the external USB ThumbDrive®/CD-ROM before the unit has completely shut down (hard drive and fan are off). Removing the external USB ThumbDrive®/CD-ROM before shut down can cause the system to update improperly.

### 5.1.1.3 Software Upgrade via Internet

This item is used to upgrade the unit's software via the internet. Select one of the listed software versions and choose <YES>. The **DVR-4TN/8TN/16TN/16TS/16TT** series uploads the software, updates the system files and reboots automatically.

## 5.1.2 Language

The Language item allows the user to select the language for the OSD menu and screen messages. Language selection takes effect immediately when the selection is done. Press UP / DOWN to select from languages listed and press ENTER to confirm.

## 5.1.3 Date / Time

The user can set the current date, time and other OSD parameters in this menu. The Administrator's privileges are required for entering the submenu. In the System Setup menu, select <Date/Time> and press ENTER; the Date/Time menu displays as follows.

Date/Time	
1. Date	2005/02/21
2. Time	10:39:26
3. Date/Time Display	1 Row
4. Date Display Mode	Y/M/D
5. Time Display Mode	24 HR
6. Date/Time Order	Date First
7. Daylight Saving Time	ON
8. DST Start	Apr, 1 st Sun, 02:00
9. DST End	Apr, Last Sun, 02:00
10. DST Bias	60 Min



**NOTE:** The reset date / time setting applies only to future recorded video, the date and time of previously recorded video will not be changed.



**NOTE:** After the Date/Time setting is changed, clearing the database is recommended for avoiding record database corruption.

### 5.1.3.1 Date / Time Setting

Select <Date> or <Time> and press ENTER to adjust the settings. LEFT / RIGHT keys are used to move the cursor to previous or next field, ENTER is for selecting, and UP / DOWN are used to change the value in the selected field.

### 5.1.3.2 Date / Time Display

Users are allowed to choose to set the Date / Time OSD displays in 1 or 2 rows. Use the UP / DOWN keys to change the setting. The default is to display the date / time OSD in one row.

### 5.1.3.3 Date Display Mode

This function allows the user to set the OSD display type for the date / time. There are three options to select from: <Y/M/D>, <M/D/Y> or <D/M/Y>. “Y” represents “Year”, “M” represents “Month” and “D” represents “Day”.

Use UP / DOWN keys to change the setting. The default setting is <Y/M/D> in both NTSC / PAL formats.

### 5.1.3.4 Time Display Mode

The user can choose to set the time format to <12 hour> or <24 hour>. Use the UP / DOWN keys to change the format. The default setting is <24 hour>.

### 5.1.3.5 Date/Time Order

This item is used to set the order of Date/Time display to <Date First> or <Time First>. Select this item and press ENTER, then use UP / DOWN keys to change the setting.

### 5.1.3.6 Daylight Saving Time

This item is for people who live in certain regions to observe Daylight Saving Time. Select <ON> to enable, or <OFF> to disable the function.

If the function is disabled, the DST Start / End time and DST Bias will be grayed out and cannot be accessed. If this function is enabled, the date/time information will be shown on the screen with a DST icon when playing back recorded video or searching video in the event list. “S” indicates summer time and “W” indicates wintertime.

### 5.1.3.7 DST Start / End

These items are used to set the daylight saving duration. Use LEFT / RIGHT to move the cursor to the next or previous field, UP / DOWN to change the settings.



### 5.1.3.8 DST Bias

This item allows the user to set the amount of time to move forward from the standard time for daylight saving time. Available options are <30>, <60>, <90> and <120> minutes.

### 5.1.4 Unit Name

Users are allowed to assign a name, up to 11 characters, to the **DVR-4TN/ DVR-8TN/ DVR-16TN** series unit.

Follow the steps below to edit the unit name.

- Select <Unit Name> from System Setup menu and press ENTER. A virtual keyboard displays.

Unit Name

A	B	C	D	E	F	G	H	I	J	K	L	M
N	O	P	Q	R	S	T	U	V	W	X	Y	Z
a	b	c	d	e	f	g	h	i	j	k	l	m
n	o	p	q	r	s	t	u	v	w	x	y	z
0	1	2	3	4	5	6	7	8	9	.	!	@
#	-	_										

◀
▶
Backspace
Delete

Cancel
OK

- Use Direction keys to move the cursor to the desired character.
- Press ENTER to add the character to the entry field (up to 11 characters).
- When done, move the cursor to <OK> and press ENTER to save the settings and exit.

## 5.1.5 Password

The Password menu allows administrator to change the password settings for accessing the unit. Select <Password> in the System Setup menu and press ENTER; the menu displays as follows. Three account/password are offered for setting.

Password	
1. Admin1 Password	
2. User1 Password	
3. Admin2 Password	
4. User2 Password	
5. Admin3 Password	
6. User3 Password	
7. Enable Password	No
8. Load Factory Password	None

### 5.1.5.1 Admin / User Password(s)

Only who entering with the administrator password is allowed to change the user and administrator passwords (to any 4~8 digit number). Use the UP / DOWN Direction keys to enter the desired account and press ENTER, the following menu is displayed.

Admin Password
_____
Press Channel Keys To Enter Password (4-8 Digits) Press ◀ To Delete

Use CHANNEL keys to input the new password and confirm the new password. After setting the new password, press ENTER to save the settings and exit.

### 5.1.5.2 Enable Password

This item is used to determine if a password is required for accessing the OSD menu. Select <YES> to demand entering password when accessing the OSD menu; if not, select <NO>.

### 5.1.5.3 Load Factory Password

This item allows the administrator to reload the factory password incase the administrator cannot remember the password. There are three options to select from: <Admin> (reload the Admin password only), <User> (reload the User password only), and <All> (reload the Admin and User passwords). The factory password is 1234 for administrator and 4321 for user.

### 5.1.6 Network Setup

The Network Setup menu allows the administrator to configure the network by specifying the network related settings, such as IP address and Netmask, etc.

See your network administrator and/or network service provider for more specific information.

Some settings under the Network Setup menu, such as IP and PPPoE Account, need to be configured through the virtual keyboard. The function key usage pattern is slightly modified, please refer to Section 3.4.2 <Key Usage in Virtual Keyboard>.

From the System Setup menu, select <Network Setup> and press ENTER. The following menu displays.

Network Setup	
1. LAN Select	LAN
2. LAN Setup	
3. Dial-in Setup	
4. Dial-out Setup	
5. Trigger Port	
6. Email Address	100
7. SMTP Setup	
8. DDNS Setup	

Items in this menu are described in the following sections.

### 5.1.6.1 LAN Select

PPPoE stands for Point-to-Point Protocol over Ethernet, which is a specification for connecting the users by Ethernet to the Internet through a common broadband medium.

This item allows you to select your service type between <LAN>, <PPPoE> or <None>; if you are using an intranet for communication, please select <LAN>, if you are using a broadband medium, such as DSL Line or cable modem, please select <PPPoE>.

If <None> is selected, then there is no need to set further LAN setting, therefore, the second item <LAN Setup> will not be accessible.

### 5.1.6.2 LAN Setup

The network related settings in the LAN Setup menu should be associated with the network service type. If you select <LAN> for <LAN Select>, then 6<sup>th</sup> to 8<sup>th</sup> item will not be available.

Select <LAN Setup> in Network Setup menu and press ENTER for setting the parameters; the menu displays as follows.

LAN Setup		
1. DHCP		OFF
2. IP	192.168.1.150	
3. Netmask	255.255.255.0	
4. Gateway	192.168.1.1	
5. DNS	0.0.0.0	
6. PPPoE Account		
7. PPPoE Password		
8. PPPoE Max Idle	35min	
9. Connect At Booting	YES	
10. Network Restart	NO	

### - DHCP

This item allows the user to obtain a dynamic IP address from a DHCP (Dynamic Host Configuration Protocol) server while the unit boots up. When using DHCP, the settings are dynamic and they will change every time you power up and power off the unit, depending on your network's setup.

If the DHCP is enabled (ON), a dynamic IP will be assigned to the **DVR-4TN/8TN/16TN/16TS/16TT** series unit. In this case, the user does not need to configure a static IP or the Ethernet settings including IP address, Netmask, Gateway, and DNS settings will be “read only”. The default setting is <ON>.

If you are using permanent addressing, set DHCP to <OFF> for setting the IP Address, Netmask, Gateway, and DNS. See your network system administrator or IT personnel for appropriate values for these setting.

## - **IP**

This item is used to configure the IP (Internet Protocol) address of the unit. The IP address is the identifier for your computer or device on a TCP/IP LAN or WAN. Please note that to set a static IP address, DHCP must be set to <OFF>.

## - **Netmask**

A netmask is a 32-bit mask used to divide an IP address into subnets and specify the networks available hosts. Its value is defined by your network administrator. It takes the form as **\*\*\*.\*\*\*.\*\*\*.\*\*\***, for example, 255.255.255.255.

This item allows the user to enter the value of the Netmask for the unit. Please note that to configure the item, DHCP must be set to <OFF>.

## - **Gateway**

A Gateway is a node on a network that serves as an entrance to another network.

Users are allowed to specify the IP address of the gateway or router associated with this unit. To configure this item, DHCP must be set to <OFF>.

## - DNS

DNS is the abbreviation for “Domain Name System”, which is an Internet service that translates domain names into IP addresses because domain names are easier to remember.

This item allows the user to specify the IP address of the Domain Name System associated with the unit. To configure this item, DHCP must be set to <OFF>.

If the network server is unavailable when using DHCP, the unit searches for the network server and boots up more slowly. This network search continues until it times out.

## - PPPoE Account

This item allows the user to setup the PPPoE login username.



**NOTE:** For accessing the PPPoE settings, select <PPPoE> as the Network Type in Network Setup menu.

To setup the login username, follow the steps below:

- Select <PPPoE Account> from the LAN Setup menu and press ENTER. A virtual keyboard displays.

PPPoE Account

A	B	C	D	E	F	G	H	I	J	K	L	M
N	O	P	Q	R	S	T	U	V	W	X	Y	Z
a	b	c	d	e	f	g	h	i	j	k	l	m
n	o	p	q	r	s	t	u	v	w	x	y	z
0	1	2	3	4	5	6	7	8	9	.	!	@
#	-	_										

Backspace
Delete

Cancel
OK

- Use Direction keys to move the cursor to the desired character.
- Press ENTER to add the character to the username entry field.

- When done, move the cursor to <OK> and press ENTER to save the settings and exit.

## - **PPPoE Password**

This item allows the user to setup the PPPoE password. Follow these steps to setup the login password.

- Select <PPPoE Password> from LAN Setup menu and press ENTER. A virtual keyboard displays.
- Use Direction keys to select character.
- Press ENTER to add the selected character to the password entry field.
- When done, move the cursor to <OK> and press ENTER to save the settings and exit.

## - **PPPoE Max Idle**

This item indicates the time that the modem connection remains active if there is no acknowledgement from the remote PC. You can select the idle time from 0 to 600 minutes. The default is 35 minutes.

## - **Connect At Booting**

The unit can connect to the Internet automatically when powered up. Select <YES> to connect at booting, otherwise select <NO>.

## - **Network Restart**

**Network restart is required after changing network settings.** Select <YES> to restart the network connection.

### **5.1.6.3 Dial-in Setup**

The Dial-in function enables the user to establish dial-up modem communication to and from the **DVR-4TN/8TN/16TN/16TS/16TT** series unit for remote software use. The user is allowed to connect only one modem to a **DVR-4TN/8TN/16TN/16TS/16TT** series unit.

For more information on dial-up setting on PC, see [Appendix D: Dial-up Connections via Modem](#).



**NOTE:** The Dial-in Service is not available if there is no modem connected to the unit.

In Network Setup menu, select <Dial-in Setup> and press ENTER to enter the Dial-in menu. The menu displays as follows.

Dial-in Setup			
1. Dial-in Service			OFF
2. Dial-in Account			User
3. Dial-in Password			XXXX
4. Server IP	192.	168.	0. 1
5. Client IP	192.	168.	0. 2
6. Dial-in Idle Time			0 Min
7. Dial-in Max Time			0 Min

## - Dial-in Service

If the **DVR-4TN/8TN/16TN/16TS/16TT** series unit does not connect to the Internet, the user can communicate to the unit from a remote PC through a modem as well. Select <ON> to enable the Dial-in function, or <OFF> to disable.

## - Dial-in Account

This item enables user to protect access to the unit by establishing or changing a dial-in user name for modem connection.

To setup the Dial-in Account, follow these steps.

- Select <Dial-in Account> from Dial-in Setup menu and press ENTER. A virtual keyboard displays.

Dial-in Account												
[Redacted]												
A	B	C	D	E	F	G	H	I	J	K	L	M
N	O	P	Q	R	S	T	U	V	W	X	Y	Z
a	b	c	d	e	f	g	h	i	j	k	l	m
n	o	p	q	r	s	t	u	v	w	x	y	z
0	1	2	3	4	5	6	7	8	9	.	!	@
#	-	_										
			◀	▶	Backspace	Delete						
			Cancel	OK								



- Use Direction keys to move the cursor to the desired character.
- Press ENTER to add the selected character to the username entry field.
- When done, move the cursor to <OK> and press ENTER to save the settings and exit.



**NOTE:** The Server IP and the Client IP must not be identified as the same IP address; but they have to be set in the same domain.

For example: Server IP: 192.168.0.1

Client IP: 192.168.0.2

## - Dial-in Password

This item allows the user to setup the Dial-in password. Follow these steps to setup the login password.

- Select <Dial-in password> from Dial-in Setup menu and press ENTER. A virtual keyboard displays.
- Use Direction keys to select character.
- Press ENTER to add the selected character to the password entry field.
- When done, move the cursor to <OK> and press ENTER to save the settings and exit.

## - Server IP

This item is for setting the IP address that identifies the **DVR-4TN/8TN/16TN/16TS/16TT** series unit over a modem connection. To set the server IP, follow these steps:

- Select <Server IP>.
- Using LEFT/ RIGHT to move the cursor over the IP, and stop where you want to make the change.
- Press ENTER, and then use UP/ DOWN to change the value.
- When done, press ENTER again to exit.
- Repeat the procedure until the IP is completely set.

## - Client IP

This item determines the remote PC's IP address for connecting with the **DVR-4TN/8TN/16TN/16TS/16TT** series unit. To set the Client IP, follow these steps:

- Select <Client IP>.
- Using LEFT/ RIGHT to move the cursor over the IP, and stop where you want to make the change.
- Press ENTER, then use UP/ DOWN to change the value.
- When done, press ENTER again to exit.
- Repeat the procedure until the IP is set completely.

## - Dial-in Idle Time

This item indicates the longest amount of time that the modem connection remains active if there is no acknowledgement from the remote pc. The value can be set from 0 min to 600 min.

## - Dial-in Max Time

The item indicates the longest amount of time that the connection via modem remains active. The value can be set from 0 min to 600 min.

### 5.1.6.4 Dial-out Setup

The Dial-out function enables the user to establish dial-up modem communication to and from the **DVR-4TN/8TN/16TN/16TS/16TT** series unit for remote notification use. The user can connect one modem to the **DVR-4TN/8TN/16TN/16TS/16TT** series unit. For more information for dial-up setting on PC, see [Appendix D: Dial-up Connections via Modem](#).



**NOTE:** The Dial-out Service is not available if there is no modem connected to the unit.

In the Network Setup menu, select <Dial-out Setup> and press ENTER to enter the Dial-out menu. The menu displays as follows.

Dial-out Setup			
1. Dial-out DHCP			OFF
2. Dial-out IP	0.	0.	0
3. Dial-out Netmask	0.	0.	0
4. Dial-out Gateway	0.	0.	0
5. Dial-out DNS	0.	0.	0
6. Phone Number			
7. Dial-out Account			
8. Dial-out Password			
9. Dial-out Idle Time			0 Min
10. Dial-out Max Time			0 Min
11. Connect			No

## - Dial-out DHCP

This item allows the user to obtain a dynamic IP address from a DHCP (Dynamic Host Configuration Protocol) server over a modem connection. If the item is enabled (ON), a dynamic IP will be assigned to the **DVR-4TN/8TN/16TN/16TS/16TT** series unit. In this case, the user does not need to configure a static IP and the following settings will be “read only.”

Select <ON> to enable the DHCP function, or <OFF> to set the dial-out IP address, Netmask, Gateway and DNS manually. The default setting is <ON>.

## - Dial-out IP

This item is for setting a static IP address that identifies the **DVR-4TN/ DVR-8TN/ DVR-16TN** series unit over a modem connection. Set the <Dial-out DHCP> to <OFF> for accessing this item.

Move the cursor over <Dial-out IP> and press ENTER, then press UP / DOWN keys to change the values in the selected field.

## - **Dial-out Netmask**

This item is for setting the Netmask that identifies the **DVR-4TN/8TN/16TN/16TS/16TT** series unit over a modem connection. To configure the item, DHCP must be set to <OFF>.

Move the cursor over <Dial-out Netmask> and press ENTER, and then press UP / DOWN keys to change the values in the selected field.

## - **Dial-out Gateway**

Users are allowed to specify the IP address of the gateway or router associated with this unit. To configure this item, DHCP must be set to <OFF>.

Move the cursor over <Dial-out Gateway> and press ENTER, and then press UP / DOWN keys to change the values in the selected field.

## - **Dial-out DNS**

This item allows the user to specify the IP address of the Domain Name System (DNS) associated with the unit. To configure this item, DHCP must be set to <OFF>.

Move the cursor over <Dial-out DNS> and press ENTER, and then press UP / DOWN keys to change the values in the selected field.

## - **Phone Number**

This item is used to set the dial-out phone number. Follow these steps to setup the phone number.

- Select <Phone Number> from Dial-out Setup menu and press ENTER. A virtual keyboard displays.
- Use Direction keys to move the cursor for selecting a number.
- Press ENTER to add the selected number to the phone number entry field.
- When done, press ENTER to save the settings and exit.

## - Dial-out Account

This item enables the user to set the Dial-out user name, which is needed for dialing out to Internet Service Provider server. Contact your network service provider for more specific information.

To setup the Dial-out Account, follow these steps.

- Select <Dial-out Account> from the Dial-out Setup menu and press ENTER. A virtual keyboard displays.

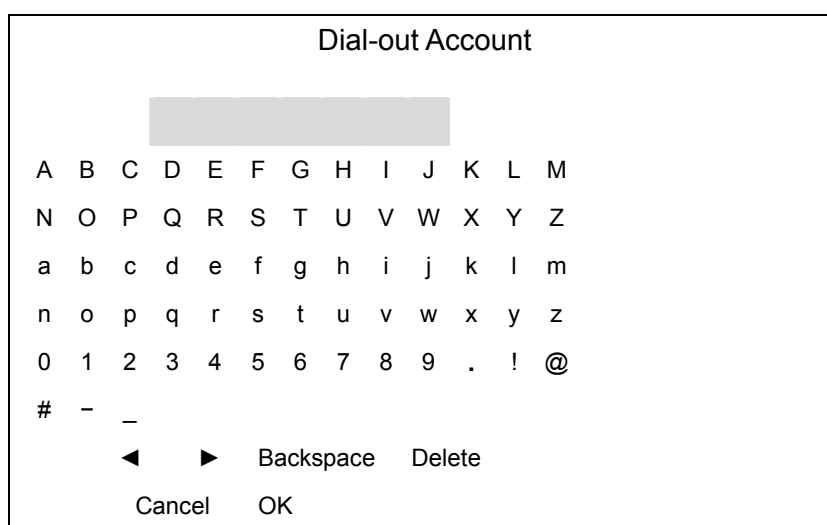

- Use the Direction keys to move the cursor to the desired character.
- Press ENTER to add the selected character to the username entry field.
- When done, move the cursor to <OK> and press ENTER to save the settings and exit..

## - Dial-out Password

This item allows user to setup the Dial-out password. Follow these steps to setup the login password.

- Select <Dial-out password> from Dial-out Setup menu and press ENTER. A virtual keyboard displays.
- Use Direction keys to move the cursor for selecting a character.
- Press ENTER to add the selected character to the password entry field.
- When done, move the cursor to <OK> and press ENTER to save the settings and exit.

## - **Dial-out Idle Time**

This item indicates the longest amount of time that the modem connection remains active if there is no acknowledgement from the remote pc. The value can be set from 1 min to 600 min. If selecting <0>, the modem connection keeps active continuously.

## - **Dial-out Max Time**

This item indicates the longest amount of time that the connection via modem remains active. The value can be set from 1 min to 600 min, or <0> to keep the connection indefinitely.

## - **Connect**

When the Dial-out related settings are configured, set this item to <YES> to starting dial-out or select <NO> to disconnect.

### **5.1.6.5 Trigger Port**

To avoid the possibility of the default service port (port 100)being blocked, this item enables the user to change port 100 into another port.

To change the trigger port, move the cursor over <Trigger Port> and press ENTER, then adjust the setting by UP / DOWN keys.

### **5.1.6.6 Email Address**

This item is used to edit the e-mail address where alarm event information will be sent. Follow these steps to setup the e-mail address.

- Select <Email Address> from Network Setup menu and press ENTER. A virtual keyboard displays.
- Use Direction keys to move the cursor for selecting character.
- Press ENTER to add the selected character to the password entry field.
- When done, move the cursor to <OK> and press ENTER to save the settings and exit.

### 5.1.6.7 SMTP Setup

Simple Mail Transfer Protocol (SMTP) is a protocol for sending e-mail messages between servers. SMTP is a relatively simple, text-based protocol, where one or more recipients of a message are specified and the message text is transferred.

Select < SMTP Setup> from Network Setup menu and press ENTER; the menu displays as follows.

SMTP Setup	
1. Email via SMTP	No
2. SMTP Server	
3. SMTP Port	25
4. SMTP Account	
5. SMTP Password	

#### - Email via SMTP

This item enables the user to determine if the unit sends e-mail via SMTP. Select <YES> to send e-mail via SMTP using direction keys; if not, select <NO>.

## - SMTP Server

This item enables the user to set the SMTP server. Contact your network service provider for more specific information.

Follow these steps to setup the SMTP Server.

- Select <SMTP Server> from SMTP Setup menu and press ENTER. A virtual keyboard displays.

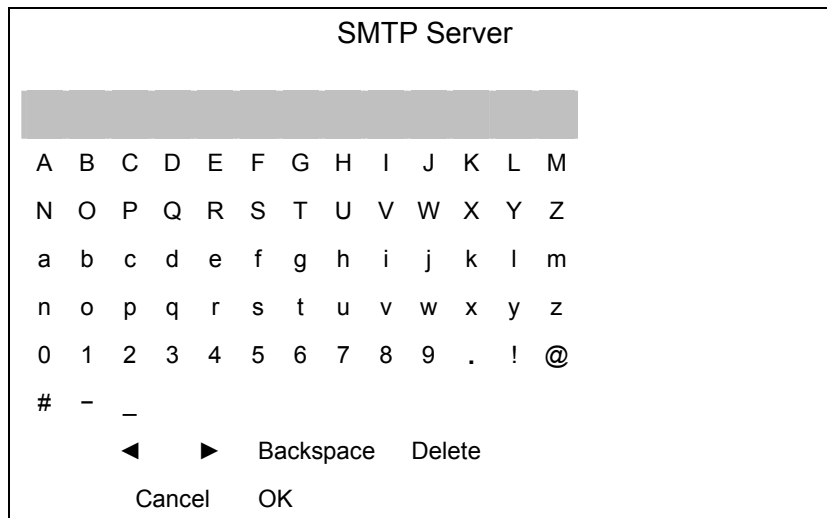

- Use Direction keys to move the cursor to the desired character.
- Press ENTER to add the selected character to the username entry field.
- When done, move the cursor to <OK> and press ENTER to save the settings and exit.

## - SMTP Port

This item is used to change the SMTP port to another port, if necessary. SMTP is usually assigned to operate over Internet port 25.

To change the SMTP port, move the cursor to <SMTP Port> in SMTP Setup menu and press ENTER. Use UP / DOWN keys to change the values in the selected field.



## - SMTP Account

This item allows user to setup the SMTP username. Follow these steps to setup the login password.

- Select <SMTP Account> from SMTP Setup menu and press ENTER. A virtual keyboard displays.
- Use Direction keys to move the cursor for selecting character.
- Press ENTER to add the selected character to the SMTP Account entry field.
- When done, move the cursor to <OK> and press ENTER to save the settings and exit.

## - SMTP Password

This item allows the user to setup the SMTP password. Follow these steps to setup the password.

- Select <SMTP password> from SMTP Setup menu and press ENTER. A virtual keyboard displays.
- Use Direction keys to move the cursor for selecting a character.
- Press ENTER to add the selected character to the password entry field.
- When done, move the cursor to <OK> and press ENTER to save the settings and exit.

### 5.1.6.8 DDNS Setup

Dynamic Domain Name System (DDNS) allows a DNS name to be constantly synchronized with a dynamic IP address. In other words, it allows those using a dynamic IP address to be associated with a static domain name so others can connect to it by name.

Once the setting is completed, the DDNS address will be:

<http://yourhostname.ddns.iview-ddns.com>

Fore example, if the chosen Host name is "SPECO", then the address will be:

<http://speco.ddns.iview-ddns.com>

Select <DDNS Setup> from Network Setup and press ENTER. The menu displays as below figure.

DDNS Setup	
1. Enable DDNS	NO
2. Host Name	
3. DDNS Port	80
4. Submit/Update	NO

## - Enable DDNS

This item is used to enable or disable the Dynamic Domain Name Service. Select <YES> to enable the service, or <NO> to disable.

## - Host Name

This item allows the user to setup a domain name, which is used when entering the **DVR-4TN/8TN/16TN/16TS/16TT** series unit through the Internet on your remote PC.

To setup the Host Name of the unit, follow the steps.

- Select <Host Name> from DDNS Setup menu and press ENTER. A virtual keyboard displays as shown.

Host Name												
[Greyed out input field]												
A	B	C	D	E	F	G	H	I	J	K	L	M
N	O	P	Q	R	S	T	U	V	W	X	Y	Z
a	b	c	d	e	f	g	h	i	j	k	l	m
n	o	p	q	r	s	t	u	v	w	x	y	z
0	1	2	3	4	5	6	7	8	9	.	!	@
#	-	_										
◀ ▶ Backspace Delete												
Cancel OK												

- Use Direction keys to select a character.
- Press ENTER to add the selected character to the Host Name entry field.
- When done, move the cursor to <OK> and press ENTER to save the settings and exit.



**NOTE:** No any two **DVR-4TN/ DVR-8TN/ DVR-16TN** series units should be set the same Host Name.

## - **DDNS Port**

This item allows the user to setup the port for DDNS. Press UP / DOWN Direction keys to change the port.

## - **Submit/Update**

When done, move the cursor to this item and press ENTER to submit the settings.



**NOTE:** If there are two **DVR-4TN/ DVR-8TN/ DVR-16TN** series units set with the same domain name, the later setting will not be submit successfully.

## 5.1.7 **RS485 Setup**

This menu allows the user to setup the parameters of the unit's RS-485 communications port. From the Main menu, select <RS485 Setup> and press ENTER. The following menu is displayed.

RS485 Setup	
1. Unit ID	224
2. Baud Rate	9600
3. Bits	8
4. Stop	1
5. Parity	None

### 5.1.7.1 **Unit ID**

This item is used to change the RS-485 ID address of the unit. The ID is with the range of <1> to <255>. The default is <224>.

### 5.1.7.2 **Baud Rate**

The Baud rate options for association with the protocol are <2400>, <4800>, <9600>, <19200>, <38400> and <57600>. The default is <9600> baud.

### 5.1.7.3 Bits

The user can specify the bits in a word that are associated with this protocol. The available options are <6>, <7> and <8> bits. The default is <8> bits.

### 5.1.7.4 Stop

The user can specify the stop bit associated with this protocol. Options are <1> and <2> stop bits. The default is <1> stop bit.

### 5.1.7.5 Parity

This item is used to specify the parity associated with this protocol. Options are <ODD>, <EVEN>, and <NONE>. The default is <NONE>.

## 5.1.8 Audio Output

The item is used to set the audio output mode. The available options are as listed as follows.

#### <Live/Playback>

Select this item to play the recording sounds of live image in live mode, and sounds of recorded video in playback mode respectively.

#### <Always Live>

Select this item to play live sounds in both live mode and playback mode.

#### <OFF>

Select this item to disable the audio output function.

## 5.1.9 Key Beep

This item is used to enable or disable the key tone. Select <YES> to enable the key tone, or <NO> to disable.

## 5.2 Monitor Setup

The Monitor Setup menu allows user to set the quality of the displayed image. Select <Monitor Setup> from the Main menu and press ENTER. The following menu is displayed.

Monitor Setup	
1. Show Camera Title	YES
2. Monitor Brightness	0
3. Monitor Contrast	0
4. Monitor Chrominance	0
5. Screen Center Adjust	
6. Show Color Bar	Execute
7. VGA Resolution	800x600

The following sections describe the items found in the Monitor Setup menu.

### 5.2.1 Show Camera Title

This item allows the user to choose whether to display the camera title on the screen or not. The default is <YES>, which displays the camera titles with the video.

### 5.2.2 Monitor Brightness

This function allows the user to adjust the brightness of the image displayed on the monitor. Move the cursor to the item then press ENTER, and use UP / DOWN keys to adjust the numeric value. The range of brightness values is <-32> to <31>. The default setting is <0>.

### 5.2.3 Monitor Contrast

This item is used to adjust the color contrast of image. The range of contrast values is <-32> to <31>; the default setting is <0>.

### 5.2.4 Monitor Chrominance

Move the cursor over this item and press ENTER for adjusting the chrominance of the image displayed on the monitor. Use UP / DOWN keys to adjust the numeric value. The range of chrominance values is <-32> to <31>; the default setting is <0>.

## 5.2.5 Screen Center Adjust

This item is used to adjust the screen center of the main monitor display area. Follow these steps to set the center point.

- Select <Screen Center Adjust> from the Monitor Setup menu and press ENTER. The adjusting screen displays as follows.

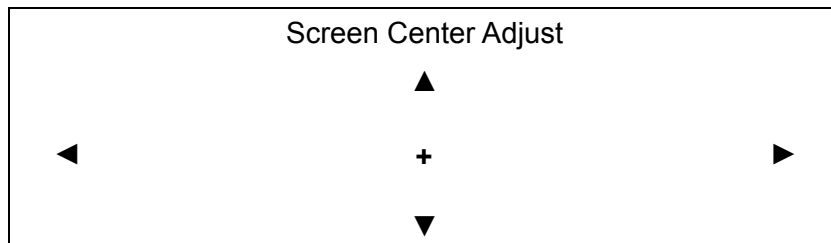

- Position the screen center position using the Direction keys.
- Press ENTER to exit when finished.

## 5.2.6 Show Color Bar

Choose this item to display a color bar pattern on the screen. The color bar helps to adjust the monitor hue, saturation, text color, and display options. Press ESC to exit the color bar pattern and return to the OSD menu.

## 5.2.7 VGA Resolution

This item allows the user to select appropriate VGA resolution for the VGA monitor connected to the unit. The options are <800x600> (default), <1024x768> and <1280x 1024>.



**NOTE:** If the selected VGA resolution is too high for the monitor, the message "No Signal" will be shown on screen. Then please press ESC on the front panel to restore the original setting.

## 5.3 Camera Setup

The items in the Camera Setup menu enable the user to set camera parameters, including camera title, dome protocol and ID for each connected camera. The menu is shown below..

Camera Setup	
1. Camera Select	CH1
2. Dome Protocol	None
3. Dome ID	0
4. Camera Title	CH1
5. Covert	No
6. Termination	Yes
7. Brightness	0
8. Contrast	0
9. Saturation	0
10. Hue	0
11. Audio Association	Both

Items in this menu are described in the following subsections.

### 5.3.1 Camera Select

This item is used to select a camera for setting parameters. The settings can then be set for the related camera, such as dome protocol and camera title.

Move the cursor to <Camera Select> and press ENTER, then select a channel using UP / DOWN keys.

### 5.3.2 Dome Protocol

Select the communications protocol associated with your dome camera using the ENTER and Direction keys. The available protocol includes <DynaColor>, <Pelco D>, <Pelco P>, <AD422>, <Fastrax 2> and <None> (default).

### 5.3.3 Dome ID

This item is used to assign an ID number to the selected dome camera. Note that ID number must match the ID address set by the dome.

### 5.3.4 Camera Title

This item allows the user to change the title of each camera connected to the unit. By default, the titles of cameras are numbered from 1 through 16 respectively. The title is displayed on screen after the title changes are set.

Follow these steps to enter a new title for a camera.

- In the Camera setup Menu, move the cursor to Camera Title and press ENTER. A virtual keyboard with alphanumeric characters is displayed.

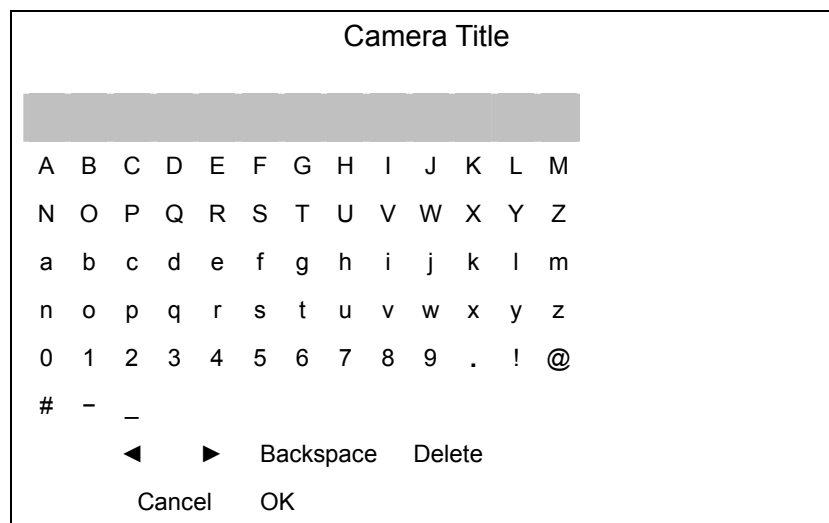

- Use Direction keys to position the cursor in the title entry field above the virtual keyboard.
- Use Direction keys to move the cursor through the lists of characters to the one you need. Press ENTER to select a character. Continue until the name is established. Each title can contain up to 11 characters in it.
- After the title entry is finished, move the cursor to <OK> and press ENTER; otherwise, either press ESC, or move the cursor to <Cancel> and press ENTER to abort.

### 5.3.5 Covert

This function allows the user to choose a specific camera to be covert while the unit is continuing to record video. Choosing <YES> means to covert the selected camera; and <NO> the selected camera remains non-covert. The default setting is <NO>.



To set a camera to be covert, follow these steps:

- Select the channel that you want to be covert from the <Channel Select> item.
- After selecting the channel, move the cursor to <Covert> item and select <YES>.

### 5.3.6 Termination

This item is used to enable / disable the 75-termination resistor inside the unit .that adjusts the image quality of each camera. <YES>= termination resistor enabled (default), <NO> = termination resistor disabled.



**NOTE:** If the camera loop-out connectors have not been used, the termination resistor should be enabled for appropriate signal termination.

### 5.3.7 Brightness

Move the cursor to this item and press ENTER to adjust the brightness of the camera. Use UP / DOWN keys to adjust the numeric value. The range of brightness values is <-128> to <127>. The default setting is <0>.

### 5.3.8 Contrast

Move the cursor to this item and press ENTER to adjust the contrast of the camera. Use UP / DOWN keys to adjust the value.

### 5.3.9 Saturation

Move the cursor to this item and press ENTER to adjust the color saturation of the camera using UP / DOWN keys. This value will be ignored on monochrome monitors. The range of saturation values is <-128> to <127>. The default setting is <0>.

### 5.3.10 Hue

Move the cursor to this item and press ENTER to adjust the hue of the camera. Use UP / DOWN keys to adjust the value.

### 5.3.11 Audio Association

This item is used to establish the connection between the selected camera and the two audio-in channels. Move the cursor to <Audio Association> in the Camera Setup menu and press ENTER, then select <Both>, <Left Only>, <Right Only> or <None> by UP / DOWN keys to set up the connection.

## 5.4 Record Setup

The following three factors will effect the total record time of the **DVR-4TN/8TN/16TN/16TS/16TT** series unit:

- HDD capacity
- Recording rate (Picture per Second)
- Image quality settings

The greater the recording rate and the higher the quality setting, the shorter the recording time. Most of the related factors can be set here in this submenu.

The Record Setup menu allows user to set recording quality, recording schedules, and other recording parameters. Administrator's password is required to access Record Setup menu. In the Main menu, move the cursor to <Record Setup> and press ENTER. The following menu is displayed.

Record Setup	
1. Record Mode	720x240@60PPS
2. Schedule Setup	
3. Preset Config	Standard
4. Per Camera Config	
5. ezRecord Setup	
6. Data Lifetime	0 Days
7. Pre-Alarm Recording	15 Sec
8. Circular Recording	ON
9. Audio Recording	ON
10. Purge Data	

## 5.4.1 Record Mode

This item is for you to preset the resolution and recording rate of normal record and event record. The relative record settings, such as uration, will follow the record mode setting. The offered options are <720x480@30PPS>, <720 x 240@60PPS> and <360 x 240@120PPS> in NTSC (<720 x 576@25PPS>, <720x288@50PPS>, <360x288@100PPS>in PAL).

Move the cursor to this item and press ENTER, then select a Record mode using UP / DOWN keys.



**NOTE:** After changing the Record Mode setting, the warning message “This will FORMAT ALL HARD DISKS and LOAD THE FACTORY DEFAULT CONFIG!” will be shown on the screen. Press ENTER to confirm the selection, then the unit will start to format the hard disks and load the factory default settings, or press ESC to abort.

We strongly recommend backing up your programmed configuration before making any changes on Record Mode settings.

## 5.4.2 Schedule Setup

This submenu is used to set the day and night time, or weekend recording schedule.

The Night and Day schedules are used to define daytime and nighttime; the Weekend schedule is tailored for weekends and holidays.

Select <Schedule Setup> from the Record Setup menu and press ENTER; the following menu is displayed.

Schedule Setup	
1. Day Time Start	06:00
2. Day Time End	18:00
3. Night Time Start	18:00
4. Night Time End	06:00
5. Weekend Schedule	YES
6. Weekend Start	Fri 18:00
7. Weekend End	Mon 06:00

### 5.4.2.1 Day / Night Time Start / End

The Day/Night Start Time determines the duration of day/ night recording time. Time is indicated in 1-minute increments. The time display format in this menu is based on the setting of Time Display Mode.

### 5.4.2.2 Weekend Schedule

The Weekend Schedule determines whether a weekend schedule is in effect. Choose <YES> to take effect the related weekend settings.

### 5.4.2.3 Weekend Start / End

The Weekend Start Time indicates the specific day and time that a weekend begins, for example, FRI 18:00. The Weekend End Time indicates the specific time and day that a weekend ends, for example, MON 06:00. Time is indicated in 1-minute increments.

Note that the value you have set indicates when the regular Day and Night scheduling ends, and Weekend recording begins.

## 5.4.3 Preset Record Configuration

The <Preset Config> is used to select the preset recording quality and frame rate. Different default recording quality levels are offered for the user to choose: <Best Quality>, <Standard>, <Extended Record>, <Event Only>, <ezRecord> and <OFF>.

According to various Record modes, the preset configuration options for normal and event status are described in terms of relative recording rate (Picture per Second; PPS) and recording size for each channel in the table below.

These preset conditions override any other quality and rate settings. The default Preset Configuration setting is <Standard>.

You can refer to [Appendix B: Record Configuration](#) for detailed information.

## 5.4.4 Per Camera Configuration

This submenu is used to set the Day / Night / Weekend PPS (Picture per Second) and recording quality for each channel. The <Preset Configuration> must be set to <OFF> for accessing these schedules.

The menu is displayed below is in Record mode: 720x240@30PPS in NTSC / 720x288@25PPS in PAL).

Per Camera Config			
Camera Select	Day	Night	CH1 Weekend
Normal PPS	7.5	7.5	7.5
Normal Qlty	Mid	Mid	Mid
Event Max PPS	30	30	30
Event Qlty	Best	Best	Best
Event Act	Both	Both	Both

### 5.4.4.1 Camera Select

This item is used to select a desired channel for setting the associated parameters. Move the cursor to <Camera Select> and press ENTER, then select a channel using UP / DOWN keys. Press ENTER again to confirm the setting.

### 5.4.4.2 Normal PPS

Normal PPS (Picture per Second) is used to set the recording rate for normal status.

Please note that the total normal pps for all channels is limited under the maximum PPS for each Record mode. To increase one channel's pps, you may have to reduce other's first. Event pps is not restricted to this rule, since a smart event scheduler will handle the total pps automatically.

### 5.4.4.3 Normal Qlty

This item is used to set the picture size for normal status recording. The available options are listed as follow: <Low>, <Fair>, <Mid>, <High> and <Best>.

#### 5.4.4.4 Event Max PPS

Event Max PPS is used to set the event recording rate for Event status. Normally, the Event PPS is set to be equal to or greater than Normal PPS; the setting depends on your application. If the Event PPS is set to <0>, the **DVR-4TN/8TN/16TN/16TS/16TT** series unit stops recording event video during alarms.

#### 5.4.4.5 Event Qlty

This item is used to set the picture size for event status recording. Refer to Section [5.4.4.3 for the available options](#).

#### 5.4.4.6 Event Active

Users are allowed to choose which alarm type needs to be recorded. The available options are <Alarm> (alarm events), <Motion> (motion detection events), <Both> (alarm event + motion detection), and <None> (no events active). The default setting is <Both>, which includes Alarm and Motion event recording.

### 5.4.5 ezRecord Setup

This item aims to avoid the complicated record settings and to make the setup much easier. Note that this item can be reached only when you select <ezRecord> as the option for <Preset Config>. For more information, please refer to the [Appendix J: ezRecord Diagram Sample](#).

Select <ezRecord Setup> from <Record Setup> and press ENTER, the sub-menu appears as shown below:

ezRecord Setup	
How Many Days To Record	1 Days
Daytime Record	Yes
Night Record	Yes
Weekend Record	Yes
Overall Recording Condition	Best

Follow these steps for ezRecord Setup:

- Select <How Many Days To Record> and press ENTER, then press UP/DOWN to choose the option you want. The maximum days allowed depends on the size of your HDD, in the other words, the larger the HDD installed, the more days the unit can record.
- Move to <Daytime Record> and press ENTER. This item is for you to select whether you want the DVR to record during daytime. If yes, using UP/DOWN to select <Yes> as option; or, select <No> for not recording during daytime.
- Repeat the same procedures through the 3rd and 4th items, respectively. Note that <Weekend Record> will be not accessible if you select <NO> for the item <Weekend Schedule> in <Schedule Setup>.
- The Quality will be automatically accounted for, according to upper items you have set, and shown on the screen. This item is for “read-only.” Five options, including <Best>, <High>, <Mid>, <Fair> and <Low>, can be viewed in this item. We strongly recommend to keep the quality higher than “Middle”.



**NOTE:** The current number of connected cameras will affect the recording quality which will be automatically calculated through the <ezRecord Setup>. Therefore, once you disconnect cameras or connect more cameras to the unit, you should reset the <ezRecord Setup>.

## 5.4.6 Data Lifetime

Data Lifetime indicates the time that a recording is saved and remains in the HDD, between the creation and deletion of a record. Only those video files recorded during Data Lifetime will be displayed on the screen and can be played back; those video files recorded outside the duration time will be hidden.

Press ENTER to select this item in Record Setup menu, and then use UP / DOWN keys to set the data lifetime. The value ranges from <1> to <365> days, or select <0> to disable the function.



**NOTE:** If you want to play back the video, which is outside the data duration of lifetime, please extend the duration till the recording data/time of the video is included.

## 5.4.7 Pre-Alarm Recording

This item is used to set the duration time of pre-alarm recording video. The pre-alarm recording function aims to give the user the opportunity to view a more complete event video. The user can see the video recorded after the alarm is triggered, **and** the video recorded ahead the alarm.

When an event is triggered while normal recording is in effect, the unit will start copying the pre-alarm and the post-alarm video to the event video. The pre-alarm duration can be set from 0~30 seconds. The default setting is 15 seconds.

The quality of the pre-alarm video is the same as the quality setting for normal record video; and the quality of the post-alarm video is the same as the quality setting for event record video.

## 5.4.8 Circular Recording

The user can choose to record video in circular mode or in linear mode. If you choose to record in circular mode, then the unit begins to overwrite the oldest recorded video and stores new video over the HDD spaces. If you choose to record in linear mode instead, the unit stops recording when the HDD is full.

From the Record Setup menu, move the cursor to <Circular Recording> and press ENTER, then select <ON> / <OFF> using UP / DOWN keys.

## 5.4.9 Audio Recording

This item allows the user to enable / disable the Audio recording function of the unit. When set to <ON>, audio input is recorded and saved with the video. When set to <OFF>, audio is ignored. The default setting is <ON>.



## 5.4.10 Purge Data

This item is used to delete the Normal or Event recording video. In Record Setup menu, move the cursor to <Purge Data> and press ENTER; the Purge Data menu is displayed.

Purge Data		
1. Purge All Data		NO
2. Purge All Event Data		NO
3. Purge Event Before	2000/01/01	
4. Start to Purge		NO

### 5.4.10.1 Purge All Data

This item is used to delete all video from database(s). Using UP / DOWN buttons to select <YES> and start the deleting by setting the <Start to Purge> to <YES>.

### 5.4.10.2 Purge All Event Data

This item is used to delete all event video from database(s). Using UP / DOWN keys to select <YES> and start the deleting by setting the <Start to Purge> to <YES>.

### 5.4.10.3 Purge Event Before

This item is used to delete event video before a specific date. Use LEFT / RIGHT keys to move the cursor to next or previous field, ENTER to select the item and UP / DOWN to adjust the value.

### 5.4.10.4 Start to Purge

After selecting the video you want to delete, or setting the date for deletion, set this item to <YES> to start the deleting process or choose <NO> to cancel.

## 5.5 Sequence Setup

The Sequence Setup menu allows the user to set the camera sequence schedule and dwell time for main and call monitor. Select <Sequence Setup> in Main menu and press ENTER; the menu displays as follows.

Sequence Setup	
1. Main Monitor Dwell	5 Sec
2. Main Monitor Schedule	
3. Call Monitor Dwell	5 Sec
4. Call Monitor Schedule	

Items in the Sequence Setup menu are described in the following subsections.

### 5.5.1 Main / Call Monitor Dwell

The Main / Call Monitor can be set to display full screen video for all installed cameras in sequence. This item is used to set the Main / Call Monitor dwell time, which is the amount of time elapsed between switching images. The dwell time has an available range of 1 to 120 seconds. The default value is 5 seconds.

### 5.5.2 Main / Call Monitor Schedule

This item is used to set the Main / Call Monitor camera sequence in full screen format. Move the cursor to <Main Monitor Schedule> and press ENTER; the menu is displayed as follows.

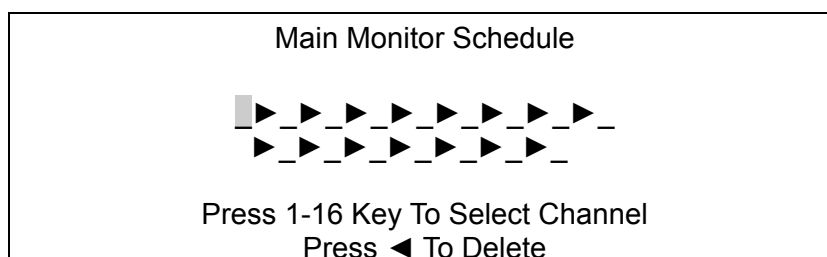

Follow these steps to set a sequence:

- Press LEFT direction key to delete the original setting.
- Press the desired Channel keys to assign a camera to that location in the sequence.
- Continue the steps until the sequence is completed.

A sequence can have up to 16 entries. The user can select fewer than 16 entries for a camera sequence and leave the remaining entries blank. The sequence can include a specific camera or cameras multiple times.

## 5.6 Event Setup

This menu allows the user to determine **DVR-4TN/8TN/16TN/16TS/16TT** series behavior in response to an alarm event. In the Main menu, move the cursor to <Event Setup> and press ENTER. The following menu is displayed.

Event Setup	
1. Internal Buzzer	ON
2. Event Icon	ON
3. Email Notice	OFF
4. Event Full Screen	
5. Event Duration	
6. Per Channel Config	

Items in the Event Setup menu are described in the following subsections.

### 5.6.1 Internal Buzzer

This item allows user to enable / disable the **DVR-4TN/ DVR-8TN/ DVR-16TN** series internal buzzer. If set to <ON>, the buzzer is activated in response to an alarm. If set to <OFF>, the buzzer is not activated. The default setting is <ON>.

### 5.6.2 Event Icon

This item enables (ON) / disables (OFF) the display of an Event Icon on the main monitor when an alarm event occurs. The default setting is <ON> (enable).

The event types are represented by a character respectively; the descriptions are listed in the table below.

Event type	Description
<b>A</b>	Alarm in event
<b>M</b>	Motion detection event
<b>L</b>	Video loss event

### 5.6.3 Email Notice

The item enables (ON) / disables (OFF) the Email notification of an event. When an alarm event is triggered and <Email Notice> is enabled, an e-mail concerning the alarm event will be sent. The default setting is <OFF>.



**NOTE:** In order to send an event notification e-mail successfully, ensure that the unit connects to the Internet.

### 5.6.4 Event Full Screen

This function allows the unit to display the alarm channel in full screen size when an alarm is triggered.

Select <None> to enable this function; select <Main> to display the alarm channel on Main Monitor when an alarm is triggered; select <Call> to display the alarm channel on Call Monitor; and select <Both> to display the alarm channel on both Main Monitor and Call Monitor.

### 5.6.5 Event Duration

This item determines the duration of the buzzer and Alarm Out relay function after an alarm is triggered. The available event duration range is from 5 second to 999 seconds. The default setting is 5 seconds.

### 5.6.6 Per Channel Config

This menu is used to set the Video Loss Detect, Motion Detect and Alarm In / Out function for each channel. The menu is displayed as below.

Per Channel Config	
1. Channel Select	CH1
2. Video Loss Detect	OFF
3. Motion Detect	OFF
4. Detection Config	
5. Alarm In	OFF
6. Alarm Out	None

### 5.6.6.1 Channel Select

This item is used to select a desired channel for setting the parameters. Move the cursor to <Channel Select> and press ENTER, then select a channel using UP / DOWN keys. Press ENTER again to confirm the setting.

### 5.6.6.2 Video Loss Detect

This item allows the user to enable / disable Video Loss as an alarm event. Select <ON> to enable Video Loss alarm events, <OFF> to disable. The default setting is <OFF>.

### 5.6.6.3 Motion Detect

Use to enable or disable the motion detection function of the **DVR-4TN/8TN/16TN/16TS/16TT** series unit. By default, the value is <OFF>.

If the motion detection function is enabled, it is required to define the motion detection parameters such as detection area and sensitivity settings.

### 5.6.6.4 Detection Config

If motion detection function is enabled, it is required to define the motion detection parameters such as detection area and sensitivity settings. Select a channel for setting the parameters, move the cursor to <Detection Config>, and press ENTER. The Detection Configuration menu displays as follows.

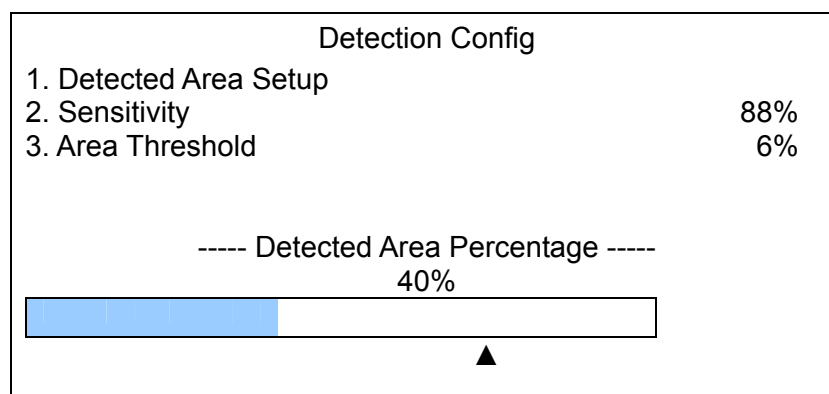

## - Detected Area Setup

The Detect Area is displayed as follows after selecting this item. The detection area consists of 273 (21×13) detection grids in NTSC video format or 336 (21×16) grids in PAL format.

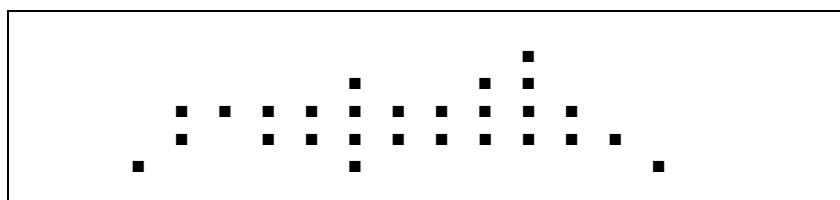

Use the Direction keys to move the cursor and press ENTER to enable or disable a grid. Press MODE to select all of the grids for detection; press MODE again to de-select all of the grids.

## - Sensitivity

This item is used to set the sensitivity of detection grids for the camera. A greater value indicates more sensitive motion detection. A motion alarm will be triggered, once the amount of motion detected exceeds the Threshold value

Move the cursor to <Sensitivity> and press ENTER, and then use UP / DOWN keys to adjust the value. The value is indicated in 4% increment.

## - Area Threshold

<Area Threshold> means the motion alarm triggered level; if the percentage of triggered grids to total detection area is greater than the set value, the motion alarm will be triggered.

For example, if 10 grids are selected and the < Area Threshold > value is 70%, the motion alarm will be triggered when 7 grids are motion detected.

Move the cursor to < Area Threshold > and press ENTER, then use UP / DOWN keys to adjust the value. The value is indicated in 4% increments.

## - Detected Area Percentage

This part shows the percentage and variation of the detected volume.

### 5.6.6.5 Alarm In

This item allows the user to enable / disable alarm input detection. According to your application, select <N/O> (Normal Open) or <N/C> (Normal Close) to enable the alarm input detection or select <OFF> to disable detection. The default setting is <OFF>.

NOTE: If you set this item to <N/C> but did not install any device to the unit, the alarm will be triggered and the Event Icon will be displayed continually until this item is changed to <N/O>, <OFF> or, install a device to the unit.

### 5.6.6.6 Alarm Out

This item allows the user to assign an alarm on a certain channel to activate the relays. These signals can be used to drive a light or siren to caution an alarm event.

Select from the options: <A Only> indicates "Alarm Out A", <B Only> indicates "Alarm Out B", <A+B> indicates "A and B Alarm Out" and <None> indicates "No Alarm Out". The default setting is <None>.

## 5.7 Database Setup

The menu displays information regarding internal and external disks. In the Main menu, move the cursor to <Database Setup> and press ENTER. The following menu is displayed.

Database Setup	
1. Total Size	xxx GB
2. Free Size	xxx GB
3. Avail. REC Time	3Days 7Hrs
4. Internal Disks	
5. External Disks	
6. NAS Device	



**NOTE:** If the hard disk detected has failed, the message "HDD fail" will display.

### 5.7.1 Total / Free Size of HDD

The Total Size of HDD shows the total capacity of the HDD that has been added into database. The Free Size of HDD indicates the free space left for recording onto the HDD in database. The information is "read-only."

### 5.7.2 Avail. REC Time

The Avail REC Time indicates the available duration for recording. If the unit is set to record in circular mode, the item will show "Circular". The information is read-only.

### 5.7.3 Internal / External Disks

Select <Internal Disks> or <External Disks> to see information about the storage devices connected to the unit. The submenu is displayed as below.

Internal Disks			
Name	Active	Action	
xxx xxxxxxxx-xxxxxx	YES	None	

The information about any built-in HDD and external storage devices will be listed by model name and status. If no storage device connects to the unit, the message "No Available Items!" will show on screen.



**NOTE:** If the file system of the internal HDD is not compatible for the DVR, the system will format the internal HDD automatically without notice.

#### <Active>

This item indicates if a storage device is added into the database or not. <YES> means the device has been added into database.

#### <Action>

This item allows the user to add a storage device to the database or to remove a device from the database.

The options are <None> (no action), <Add> (add the selected device into database), <Remove> (remove the selected device from database), <Format> (format the selected device).





**NOTE: Before removing external devices from the unit, remember to remove the device from database.**

## 5.8 Configuration

The Configuration menu can be used to restore the default factory settings, import and export configurations.

Select <Configuration> from the Main menu and press ENTER. The following menu is displayed.

Configuration	
1. Load Factory Default	NO
2. Import Config	
3. Export Config	

Items in this menu are described in the following subsections.

### 5.8.1 Load Factory Default

This item is used to load the factory default setting; select <YES> to recall the factory default setup configuration from the “read-only” memory, or <NO> to cancel.

### 5.8.2 Import Configuration

This item allows the user to load a unit configuration that was saved on an external drive. To import a configuration that was previously exported, make sure the device that saved the configuration is connected to the unit. Select <Import Config> from the Configuration menu and press ENTER. The following menu is displayed.

Import Config	
Config Name	Select
XXXX-XXXX	NO
XXX-XX	NO

Press UP / DOWN to select one of the available listed configuration files, and choose <YES> to start to import.



**NOTE:** If the imported configuration has a different record mode from the unit's, the warning message "This config has different record mode. This will FORMAT ALL HARDDISKS." will show.



**NOTE:** Remove the ThumbDrive® used for importing configuration after the unit restarts, or it will be formatted as well.

### 5.8.3 Export Configuration

The Administrator is allowed to save a unit configuration by exporting it to an external drive, such as a USB Flash Drive. Before exporting the configuration, make sure the device in which the configuration will be saved is attached to the unit properly. Select <Export Config> from the Configuration menu and press ENTER. The following menu is displayed.

Export Config	
1. Copy Destination	
2. Config Name	
3. Begin Export	NO

Items in this menu are described in the following sections.

#### 5.8.3.1 Copy Destination

Select this item to list available destinations (external memory devices) to which the configuration can be exported. Press UP / DOWN to set a destination. **Please note that saving a different configuration to the same copy destination with the same file name will overwrite the previous configuration file without warning.**



**NOTE:** Users are not allowed to select any CD-R/W or DVD+RW as a copy destination, including built-in CD-R/W and DVD+RW.

#### 5.8.3.2 Configuration Name

This item allows the user to assign the exported configuration file a name. Use the virtual keyboard to enter the configuration file name.

Note that the file name can contain up to 15 characters, with no spaces.

### 5.8.3.3 Begin Export

Select <YES> to begin exporting the configuration file, or <NO> to abort the export.



**NOTE:** We strongly recommend users to export configurations before upgrading your system, and back it up routinely, just in case an unexpected situation occurs.

## 5.9 Video Export

The Video Export menu enables the administrator to export recorded video with a digital signature to a USB Thumb drive, a CD-RW or to DVD+RW drive. Make sure an external storage device is available and connected to the appropriate port for video export. The Administrator's password is required to export video.

If the <Pre-Alarm Recording> function is enabled, the event video will be exported into two files, including pre-alarm video and video recorded after the alarm is triggered.

Each recorded video will be exported automatically into four files when exporting with a digital signature, including \*.gpg, \*.avi (\*.drv), \*.sig and readme.txt. To export a 1GB file with a digital signature, it may take you about 30 minutes.

From the Main menu, select <Video Export> and press ENTER. The following menu is displayed.



**NOTE:** The inserted CD will be ejected when its capacity is 99% full.

Video Export			
1. Select Device			
2. Select Ch:	CH1	CH2	CH3 CH4
3. From	2005/03/19	AM	07:50:05
4. To	2005/03/28	PM	03:09:18
5. Select Events			
6. Data Type			Normal
7. Digital Signature			NO
8. Erase Disc			NO
9. Begin Export			NO

Items in the menu will be described in the following section.

## 5.9.1 Select Device

The external devices that are available for exporting video will be listed by name and free space size in Select Device menu. The Select Device menu displays as follows.

Select Device		
Device Name	Available	Sel
XXX-XXX-X-X-XX	256 MB	NO
XX-XXX-XX-XXXX	1.5 GB	NO

The **DVR-4TN/8TN/16TN/16TS/16TT** series units only support EXT3 file system. If you connect an external HDD to the unit, ensure that the format of HDD is EXT3.

### <Device Name>

This item shows the name of the available device.

### <Available>

This item shows how much free space is available on the device.

### <Sel>

Set this item to <YES> to set it as an exporting destination; or <NO> to cancel.



**NOTE:** This last menu item <Erase Disk> will be grayed out when selected device is not a CD/ DVD recorder or not select yet.

## 5.9.2 Select Channel

The item is used to select channels for export. Move the cursor to the desired channel using LEFT / RIGHT keys, then select or de-select a channel by pressing ENTER.

### 5.9.3 From / To Time

The items are used to set the time which data export begins and ends. Move the cursor using Direction keys, and press ENTER to select the date / time items; adjust the selected date and time value by UP / DOWN keys.



**NOTE:** When the Start / End Time are set, remember to select the exporting Data Type.

### 5.9.4 Select Events

Select this item to display the available event video list for exporting. Move the cursor to scroll down the event list and press ENTER to select the event you want to export.

### 5.9.5 Data Type

The item is used to select export video type. The options are <Normal> (export normal video only), <Event> (export event video only) and <Both> (export both normal and event video).



**NOTE:** If you want to export selected event video using the item <Select Event>, you have to set <From> and <To> for the same day and time; otherwise, not only the selected event video will be exported to the selected destination, but also any other event video recorded during the period between <From> and <To>.



**NOTE:** You will not be allowed to access the <Select Events> if the Data Type is set to <Normal>.

## 5.9.6 Digital Signature

The Digital Signature function enables the user to export a video clip with the unit's unique signature key. It aims to authenticate a video clip exported from the unit and prove it has not been modified. The user can export a video clip with or without a digital signature file (\*.sig). Set the item to <YES> to export with the signature file, or <NO> to export without the signature file.

Make sure that you have an external storage device, such as a USB Hard Drive or USB ThumbDrive®, available and connected to the appropriate port for export.

For more information on verifying digital signature, see [Appendix E: Verifying Digital Signature](#).

## 5.9.7 Erase Disc

This function is used to remove information found on a CD-RW or DVD+RW disk prior to exporting new information to the drive. Select <YES> and press ENTER to start deleting data.



**NOTE:** This menu item will be grayed out when selected device is not a CD/ DVD recorder or not select yet.

## 5.9.8 Begin Export

Select <YES> and press ENTER to start exporting.

## 5.10 Shutdown

This item is used to shut down or reboot the unit. If you must shut down the **DVR-4TN/8TN/16TN/16TS/16TT** series unit for any reason, please use the proper shut down and power up procedures to avoid damage to your unit.

Select <Shutdown> in Main menu and press ENTER to access the Shutdown menu, which displays as follows.

Shutdown	
1. Power Off	Execute
2. Reboot	Execute

**Power Off**

Select this item to shut down the unit. **Do not remove the power** during shut down until the message "You can safely turn off DVR now!" displays.

**Reboot**

Select this item to reboot the unit. The color bar and system checking information are displayed on the monitor until the unit is completely restarted.

## Appendix A: Technical Specifications

All specifications are subject to change without notice.

Function		4CH	8CH	16CH	
Video	Operation System	Embedded ( Linux )			
	Video Standard	NTSC/PAL switch selectable			
	Video Operation	Triplex+( Live, Record, Playback , Remote, and Internet access )			
	Resolution – Live Video	NTSC: 720 x 480 pixels PAL: 720 x 576 pixels			
	Input	BNC x 4,1.0Vp-p/75 ohm	BNC x 8,1.0Vp-p/75 ohm	BNC x 16,1.0Vp-p/75 ohm	
	Outputs	Main Monitor	BNC x 1, S-Video x 1, 1.0Vp-p/75 ohm		
		Call monitor	BNC x 1, 1.0Vp-p/75 ohm		
		Loop	BNC x 4,1.0Vp-p/75 ohm	BNC x 8,1.0Vp-p/75 ohm	BNC x 16,1.0Vp-p/75 ohm
	VGA Output	800 x 600, 1024 x 768, 1280 x 1024 pixels @ 60Hz			
	Picture Refresh Rate	NTSC: 480 PPS(16CH) PAL: 400 PPS(16CH)			
Digital Zoom	2 x 2				
Camera Installation	Plug & Play				
Audio	Input	RCA x 2, Line-In			
	Output	RCA x 2, Line-Out			
	Recording Mode	Always Real Time Record, Synchronized w/ Video			
	Compression Method	ADPCM, G.726			
	File Size	8KB/Sec			
	Operation	Remote + VCR mode			
	Playback	Only for Video Original Speed			
Recording	Compression Method	MPEG-4 Advanced Simple Profile			
	Recording Mode	Schedule, Alarm, Motion Detection			
	Pre-Alarm	0~30 sec			
	Resolution & Rate	NTSC	720x480: 30 pps		
			720x240: 60 pps		
			360x240: 120 pps		
		PAL	720x576: 25 pps		
			720x288: 50 pps		
360x288: 100 pps					
Recording Quality	8 levels presets, adjustable				
Image Size	2K to 20K Byte/picture				
Storage Mode	Linear/Circular				
Playback	Playback	Play, Stop, Pause, Rewind, Forward, Search			
	Playback Speed Adjustment	Yes 1X, 2X...32X			
	Retrieve	Date/Time, Event			
	Data Life Time	Yes(Programmable)			
Storage	Build-in Storage	X2 ATA 133 / UDMA 133 IDE, HDD/CD-RW/DVD+RW			
	Built-in HDD	Up to 3 built-in HDDs			
	External Storage	X2 IEEE 1394 ports			
	Export	X3 USB2.0 ports, support ThumbDrive®, CD-RW, or DVD+RW			
Alarm	Alarm Input	X4, Terminal Block	X8, Terminal Block	X16, Terminal Block	
	Alarm Detection	N.C./N.O., Programmable			
	Auditory Alert	Built-in Buzzer			
	Motion Detection	21 X 13(NTSC), 21 X 16(PAL) Grid Array, Sensitivity, Trig Level Adjustable			
	Video Loss Detection	Programmable			
	Alarm Relay Output	X2, Terminal Block, 1.0A/24V (Programmable)			
Communication	Network Connectivity	Ethernet RJ-45 connector, 10/100Mbps, supports DHCP/PPPoE/DDNS			
	Remote Control Software	SpecoRemote™			
	Access Control	2 Level Password			



	Remote Operation	Monitoring, Playback, Recording, System Setup, Dome Camera Control
	RS232C	D-sub 9 pin female
	RS485	Terminal Block
	Dome Control Protocol	DynaColor, Pelco P, Pelco D, AD422

## Appendix B: Record Configuration

1. The following three tables are offered for users who use DVR-4TN/ 8TN/ 16TN unit.

Record Mode: Full-D1 mode (NTSC: 720x480@30PPS) (PAL: 720x576@25PPS)						
Preset Item	Normal PPS		Normal Size	Event PPS	Event Size	Event Active
Best Quality	4ch	NTSC:7.5 PAL:6.25	28 KB	NTSC:30 PAL:25	28 KB	Both (Alarm + Motion)
	8ch	NTSC:3.75 PAL:3.12				
	16ch	1~8ch NTSC:2.75 PAL:2.12	30 KB		30 KB	
		9~16ch NTSC:1 PAL:1				
Standard	4ch	NTSC:7.5 PAL:6.25	16 KB	NTSC:30 PAL:25	28 KB	Both
	8ch	NTSC:3.75 PAL:3.12				
	16ch	1~8ch NTSC:2.75 PAL:2.12	18 KB		30 KB	
		9~16ch NTSC:1 PAL:1				
Extended Record	4ch	NTSC:7.5 PAL:6.25	4 KB	NTSC:30 PAL:25	28 KB	Both
	8ch	NTSC:3.75 PAL:3.12				
	16ch	1~8ch NTSC:2.75 PAL:2.12	6 KB		30 KB	
		9~16ch NTSC:1 PAL:1				
Event Only	0 NTSC 0 PAL	–	NTSC:30 PAL:25	30 KB	Both	
128Kbps DSL	NTSC:1 PAL:1	2 KB	NTSC:1 PAL:1	2 KB	Both	
256Kbps DSL	NTSC:4 PAL:4	2 KB	NTSC:4 PAL:4	2 KB	Both	
512Kbps DSL	NTSC:4 PAL:4	3 KB	NTSC:4 PAL:4	3 KB	Both	
OFF	User selected	User selected	User selected	User selected	User selected	

Record Mode: Half-D1 mode (NTSC: 720x240@60PPS) (PAL: 720x288@50PPS)						
Preset Item	Normal PPS		Normal Size	Event PPS	Event Size	Event Active
Best Quality	4ch	NTSC:15 PAL:12.5	20 KB	30 NTSC 25 PAL	20 KB	Both (Alarm + Motion)
	8ch	NTSC:7.5 PAL:6.25				
	16ch	NTSC:3.75 PAL:3.12	25 KB		25 KB	
Standard	4ch	NTSC:15 PAL:12.5	12 KB	30 NTSC 25 PAL	20 KB	Both
	8ch	NTSC:7.5 PAL:6.25				
	16ch	NTSC:3.75 PAL:3.12	15 KB		25 KB	
Extended Record	4ch	NTSC:15 PAL:12.5	4 KB	NTSC: 30 PAL: 25	20 KB	Both
	8ch	NTSC:7.5 PAL:6.25				
	16ch	NTSC:3.75 PAL:3.12	5 KB		25 KB	
Event Only	NTSC: 0 PAL: 0		–	NTSC: 30 PAL: 25	25 KB	Both
128Kbps DSL	NTSC: 1 PAL: 1		2 KB	NTSC: 1 PAL: 1	2 KB	Both
256Kbps DSL	NTSC: 4 PAL: 4		2 KB	NTSC: 4 PAL: 4	2 KB	Both
512Kbps DSL	NTSC: 4 PAL: 4		3 KB	NTSC: 4 PAL: 4	3 KB	Both
OFF	User selected		User selected	User selected	User selected	User selected

Record Mode: CIF mode (NTSC: 360x240@120PPS) (PAL: 360x288@100PPS)						
Preset Item	Normal PPS		Normal Size	Event PPS	Event Size	Event Active
Best Quality	4ch	NTSC:30 PAL:25	10 KB	NTSC: 30 PAL: 25	10 KB	Both (Alarm + Motion)
	8ch	NTSC:15 PAL:12.5				
	16ch	NTSC:7.5 PAL:6.25	15 KB		15 KB	
Standard	4ch	NTSC:30 PAL:25	6 KB	NTSC: 30 PAL: 25	10 KB	Both
	8ch	NTSC:15 PAL:12.5				
	16ch	NTSC:7.5 PAL:6.25	9 KB		15 KB	
Extended Record	4ch	NTSC:30 PAL:25	2 KB	NTSC: 30 PAL: 25	10 KB	Both
	8ch	NTSC:15 PAL:12.5				
	16ch	NTSC:7.5 PAL:6.25	3 KB		15 KB	
Event Only	NTSC: 0 PAL: 0		–	NTSC: 30 PAL: 25	15 KB	Both
128Kbps DSL	NTSC: 1 PAL: 1		2 KB	NTSC: 1 PAL: 1	2 KB	Both
256Kbps DSL	NTSC: 4 PAL: 4		2 KB	NTSC: 4 PAL: 4	2 KB	Both
512Kbps DSL	NTSC: 4 PAL: 4		3 KB	NTSC: 4 PAL: 4	3 KB	Both
OFF	User selected		User selected	User selected	User selected	User selected

2. The following three tables are offered for users who use DVR-16TS unit.

Record Mode: Full-D1 mode (NTSC: 720x480@60PPS) (PAL: 720x576@50PPS)						
Preset Item	Normal PPS		Normal Size	Event PPS	Event Size	Event Active
Best Quality	16ch	NTSC:3.75 PAL:3.12	28 K	NTSC:30 PAL:25	28 K	Both (Alarm + Motion)
Standard	16ch	NTSC:3.75 PAL:3.12	16 K	NTSC:30 PAL:25	28 K	Both
Extended Record	16ch	NTSC:3.75 PAL:3.12	4 K	NTSC:30 PAL:25	28 K	Both
Event Only	0 NTSC 0 PAL		–	30 NTSC: 25 PAL:	28 KB	Both
128Kbps DSL	1 NTSC 1 PAL		2 KB	1 NTSC: 1 PAL:	2 KB	Both
256Kbps DSL	4 NTSC 4 PAL		2 KB	4 NTSC: 4 PAL:	2 KB	Both
512Kbps DSL	4 NTSC 4 PAL		3 KB	4 NTSC: 4 PAL:	3 KB	Both
OFF	User selected		User selected	User selected	User selected	User selected

Record Mode: Half-D1 mode (NTSC: 720x240@120PPS) (PAL: 720x288@100PPS)						
Preset Item	Normal PPS		Normal Size	Event PPS	Event Size	Event Active
Best Quality	16ch	NTSC:7.5 PAL:6.25	20 KB	NTSC:30 PAL:25	20 KB	Both (Alarm + Motion)
Standard	16ch	NTSC:7.5 PAL:6.25	12 KB	NTSC:30 PAL:25	20 KB	Both
Extended Record	16ch	NTSC:7.5 PAL:6.25	4 KB	NTSC:30 PAL:25	20 KB	Both
Event Only	NTSC: 0 PAL: 0		–	30 NTSC: 25 PA:	20 KB	Both
128Kbps DSL	NTSC: 1 PAL: 1		2 KB	1 NTSC: 1 PAL:	2 KB	Both
256Kbps DSL	NTSC: 4 PAL: 4		2 KB	4 NTSC: 4 PAL:	2 KB	Both
512Kbps DSL	NTSC: 4 PAL: 4		3 KB	4 NTSC: 4 PAL:	3 KB	Both
OFF	User selected		User selected	User selected	User selected	User selected

Record Mode: CIF mode (NTSC: 360x240@240PPS) (PAL: 360x288@200PPS)						
Preset Item	Normal PPS		Normal Size	Event PPS	Event Size	Event Active
Best Quality	16ch	NTSC:15 PAL:12.5	10 KB	NTSC: 30 PAL: 25	10 KB	Both (Alarm + Motion)
Standard	16ch	NTSC:15 PAL:12.5	6 KB	NTSC: 30 PAL: 25	10 KB	Both
Extended Record	16ch	NTSC:15 PAL:12.5	2 KB	NTSC: 30 PAL: 25	10 KB	Both
Event Only	NTSC: 0 PAL: 0		–	NTSC: 30 PAL: 25	10 KB	Both
128Kbps DSL	NTSC: 1 PAL: 1		2 KB	NTSC: 1 PAL: 1	2 KB	Both
256Kbps DSL	NTSC: 4 PAL: 4		2 KB	NTSC: 4 PAL: 4	2 KB	Both
512Kbps DSL	NTSC: 4 PAL: 4		3 KB	NTSC: 4 PAL: 4	3 KB	Both
OFF	User selected		User selected	User selected	User selected	User selected

### 3. The following three tables are offered for users who use DVR-16TT unit.

Record Mode: Full-D1 mode (NTSC: 720x480@120PPS) (PAL: 720x576@100PPS)						
Preset Item	Normal PPS		Normal Size	Event PPS	Event Size	Event Active
Best Quality	16ch	NTSC:7.5 PAL:6.25	19 KB	NTSC:30 PAL:25	19 KB	Both (Alarm + Motion)
Standard	16ch	NTSC:7.5 PAL:6.25	11 KB	NTSC:30 PAL:25	19 KB	Both
Extended Record	16ch	NTSC:7.5 PAL:6.25	3 KB	NTSC:30 PAL:25	19 KB	Both
Event Only		NTSC:0 PAL:0	–	NTSC:30 PAL:25	19 KB	Both
128Kbps DSL		NTSC:1 PAL:1	2 KB	NTSC:1 PAL:1	2 KB	Both
256Kbps DSL		NTSC:4 PAL:4	2 KB	NTSC:4 PAL:4	2 KB	Both
512Kbps DSL		NTSC:4 PAL:4	3 KB	NTSC:4 PAL:4	3 KB	Both
OFF		User selected	User selected	User selected	User selected	User selected

Record Mode: Half-D1 mode (NTSC: 720x240@240PPS) (PAL: 720x288@200PPS)						
Preset Item	Normal PPS		Normal Size	Event PPS	Event Size	Event Active
Best Quality	16ch	NTSC:15 PAL:12.5	10 KB	NTSC:30 PAL:25	10 KB	Both (Alarm + Motion)
Standard	16ch	NTSC:15 PAL:12.5	6 KB	NTSC:30 PAL:25	10 KB	Both
Extended Record	16ch	NTSC:15 PAL:12.5	2 KB	NTSC:30 PAL:25	10 KB	Both
Event Only		NTSC:0 PAL:0	–	NTSC:30 PAL:25	10 KB	Both
128Kbps DSL		NTSC:1 PAL:1	2 KB	NTSC:1 PAL:1	2 KB	Both
256Kbps DSL		NTSC:4 PAL:4	2 KB	NTSC:4 PAL:4	2 KB	Both
512Kbps DSL		NTSC:4 PAL:4	3 KB	NTSC:4 PAL:4	3 KB	Both
OFF		User selected	User selected	User selected	User selected	User selected

Record Mode: CIF mode (NTSC: 360x240@480PPS) (PAL: 360x288@400PPS)						
Preset Item	Normal PPS		Normal Size	Event PPS	Event Size	Event Active
Best Quality	16ch	NTSC:30 PAL:25	5 KB	NTSC:30 PAL:25	5 KB	Both (Alarm + Motion)
Standard	16ch	NTSC:30 PAL:25	3 KB	NTSC:30 PAL:25	5 KB	Both
Extended Record	16ch	NTSC:30 PAL:25	1 KB	NTSC:30 PAL:25	5 KB	Both
Event Only		NTSC:0 PAL:0	–	NTSC:30 PAL:25	14 KB	Both
128Kbps DSL		NTSC:1 PAL:1	2 KB	NTSC:1 PAL:1	2 KB	Both
256Kbps DSL		NTSC:4 PAL:4	2 KB	NTSC:4 PAL:4	2 KB	Both
512Kbps DSL		NTSC:4 PAL:4	3 KB	NTSC:4 PAL:4	3 KB	Both
OFF		User selected	User selected	User selected	User selected	User selected

## Appendix C: Record Duration

The record duration relates to recording rate, image quality and HDD capacity. Refer to the following table.



**NOTE:** Record duration times are based on actual tests and represent average file sizes. Performance may vary depending on specific installations and use. Audio recording requires 8 KB per second (or 0.7 GB per day) for data storage.

Please refer to our recording time calculator on the Speco website for other possible calculations. <http://www.Specotech.com> → Support → Tools

### Number of Days of Recording 720 x 480 @ 30PPS (without Audio)

Recording Rate		Recording Quality Mode									
Total Images Per Second NTSC	Total Images Per Second PAL	Low		Fair		Mid		High		Best	
		NTSC (8 KB)	PAL (8 KB)	NTSC (11 KB)	PAL (11 KB)	NTSC (14 KB)	PAL (14 KB)	NTSC (17 KB)	PAL (17 KB)	NTSC (20 KB)	PAL (20 KB)
<b>160 GB Internal Storage</b>											
30	25	7.5	9.0	5.5	6.6	4.3	5.2	3.6	4.3	3.0	3.7
15	12.5	15.0	18.0	11.0	13.2	8.7	10.4	7.2	8.6	6.1	7.3
7.5	6.25	29.9	35.9	21.9	26.3	17.3	20.8	14.3	17.2	12.2	14.6
<b>300 GB Internal Storage</b>											
30	25	14.0	16.8	10.3	12.3	8.1	9.7	6.7	8.1	5.7	6.9
15	12.5	28.1	33.7	20.6	24.7	16.2	19.5	13.4	16.1	11.4	13.7
7.5	6.25	56.1	67.3	41.2	49.4	32.5	39.0	26.8	32.2	22.9	27.4
<b>600 GB Internal Storage</b>											
30	25	28.1	33.7	20.6	24.7	16.2	19.5	13.4	16.1	11.4	13.7
15	12.5	56.1	67.3	41.2	49.4	32.5	39.0	26.8	32.2	22.9	27.4
7.5	6.25	112.2	134.7	82.3	98.8	65.0	78.0	53.7	64.4	45.7	54.9

**Number of Days of Recording 720 X 240 @ 60PPS (without Audio)**

Recording Rate		Recording Picture Quality Mode									
Total Images Per Second NTSC	Total Images Per Second PAL	Low		Fair		Mid		High		Best	
		NTSC (5 KB)	PAL (5 KB)	NTSC (8 KB)	PAL (8 KB)	NTSC (11 KB)	PAL (11 KB)	NTSC (14 KB)	PAL (14 KB)	NTSC (17 KB)	PAL (17 KB)
<b>160 GB Internal Storage</b>											
60	50	5.9	7.1	3.7	4.5	2.7	3.3	2.2	2.6	1.8	2.1
30	25	11.8	14.1	7.5	9.0	5.5	6.6	4.3	5.2	3.6	4.3
15	12.5	23.5	28.2	15.0	18.0	11.0	13.2	8.7	10.4	7.2	8.6
7.5	6.25	47.0	56.4	29.9	35.9	21.9	26.3	17.3	20.8	14.3	17.2
<b>300 GB Internal Storage</b>											
60	50	11.0	13.2	7.0	8.4	5.1	6.2	4.1	4.9	3.4	4.0
30	25	22.0	26.5	14.0	16.8	10.3	12.3	8.1	9.7	6.7	8.1
15	12.5	44.1	52.9	28.1	33.7	20.6	24.7	16.2	19.5	13.4	16.1
7.5	6.25	88.2	105.8	56.1	67.3	41.2	49.4	32.5	39.0	26.8	32.2
<b>600 GB Internal Storage</b>											
60	50	22.0	26.5	14.0	16.8	10.3	12.3	8.1	9.7	6.7	8.1
30	25	44.1	52.9	28.1	33.7	20.6	24.7	16.2	19.5	13.4	16.1
15	12.5	88.2	105.8	56.1	67.3	41.2	49.4	32.5	39.0	26.8	32.2
7.5	6.25	176.4	211.6	112.2	134.7	82.3	98.8	65.0	78.0	53.7	64.4

**Number of Days of Recording 360 X 240 @ 120PPS (without Audio)**

Recording Rate		Recording Picture Quality Mode									
Total Images Per Second NTSC	Total Images Per Second PAL	Low		Fair		Mid		High		Best	
		NTSC (2 KB)	PAL (2 KB)	NTSC (5 KB)	PAL (5 KB)	NTSC (8 KB)	PAL (8 KB)	NTSC (11 KB)	PAL (11 KB)	NTSC (14 KB)	PAL (14 KB)
<b>160 GB Internal Storage</b>											
120	100	7.18	8.62	2.87	3.45	1.8	2.15	1.31	1.57	1.03	1.23
60	50	13.7	16.5	5.9	7.1	3.7	4.5	2.7	3.3	2.2	2.6
30	25	27.4	32.9	11.8	14.1	7.5	9.0	5.5	6.6	4.3	5.2
15	12.5	54.9	65.8	23.5	28.2	15.0	18.0	11.0	13.2	8.7	10.4
7.5	6.25	109.7	131.7	47.0	56.4	29.9	35.9	21.9	26.3	17.3	20.8
<b>300 GB Internal Storage</b>											
120	100	13.8	16.5	5.5	6.6	3.4	4.1	2.5	3.0	2.0	2.4
60	50	25.7	30.9	11.0	13.2	7.0	8.4	5.1	6.2	4.1	4.9
30	25	51.4	61.7	22.0	26.5	14.0	16.8	10.3	12.3	8.1	9.7
15	12.5	102.9	123.5	44.1	52.9	28.1	33.7	20.6	24.7	16.2	19.5
7.5	6.25	205.8	246.9	88.2	105.8	56.1	67.3	41.2	49.4	32.5	39.0

600 GB Internal Storage											
120	100	27.9	33.5	11.2	13.4	7.0	8.4	5.1	6.1	4.0	4.8
60	50	51.4	61.7	22.0	26.5	14.0	16.8	10.3	12.3	8.1	9.7
30	25	102.9	123.5	44.1	52.9	28.1	33.7	20.6	24.7	16.2	19.5
15	12.5	205.8	246.9	88.2	105.8	56.1	67.3	41.2	49.4	32.5	39.0
7.5	6.25	411.5	493.8	176.4	211.6	112.2	134.7	82.3	98.8	65.0	78.0



## Appendix D: Dial-up Connections via Modem

A dial-up modem connection allows the user to use the remote software and receive alarm notice without a direct Internet connection. Following are the steps for establishing the connection between a **DVR-4TN/8TN/16TN/16TS/16TT** series unit and a PC.

### Establishing Dial-in Connection

The Dial-in function enables the user to establish dial-up modem communication to and from the **DVR-4TN/8TN/16TN/16TS/16TT** series unit for the remote software use. Follow the description to set up your DVR and PC.

#### DVR Configuration:

- Connect a USB modem to the USB socket and connect a working phone line to the modem.
- Press MENU and input the Administrator password to access the OSD Main menu. Select <Network Setup> and then <Dial-in Setup> to set up the Dial-In settings, including Dial-in Account and password, etc.
- For more information on dial-in settings, see section [5.1.6.3 Dial-in Setup](#).

#### PC Configuration:

- Click <Start>, <My Network Places>, <View Network Connections> and then select <Create New Connection>. The New Connection Wizard is displayed. Click <Next> to continue.



- Set up the network connection type. Select <Connect to the Internet> and click <Next> to continue.

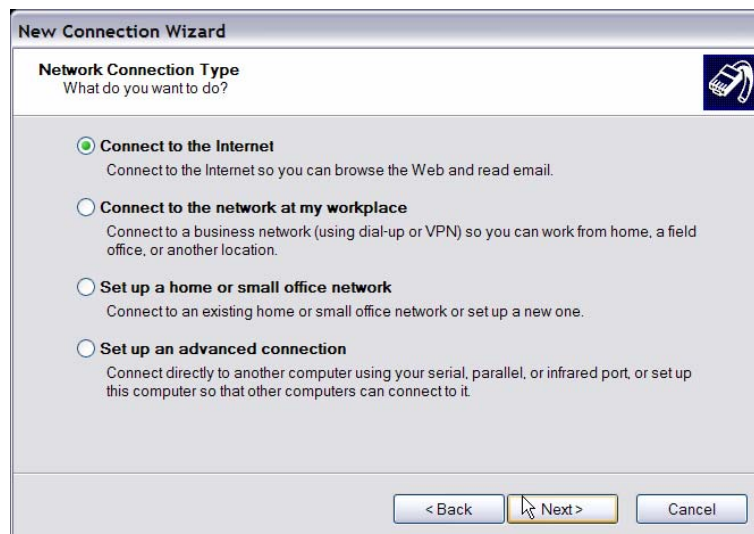

- Select <Set up my connection manually> and click <Next> to continue.



- Select <Connect using a dial-up modem> to connect to the Internet through a phone line and a modem. Click <Next> to continue.

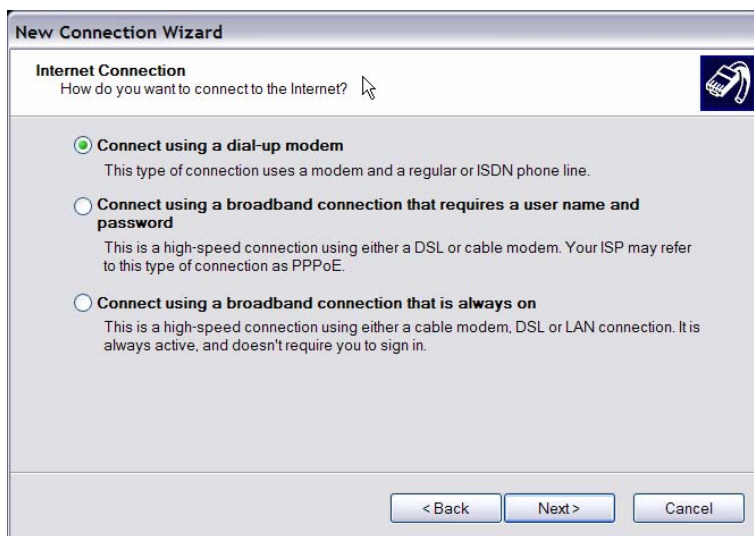

- Type the name of the connection you are creating.



- Enter the phone number of the modem that is connected to the unit.

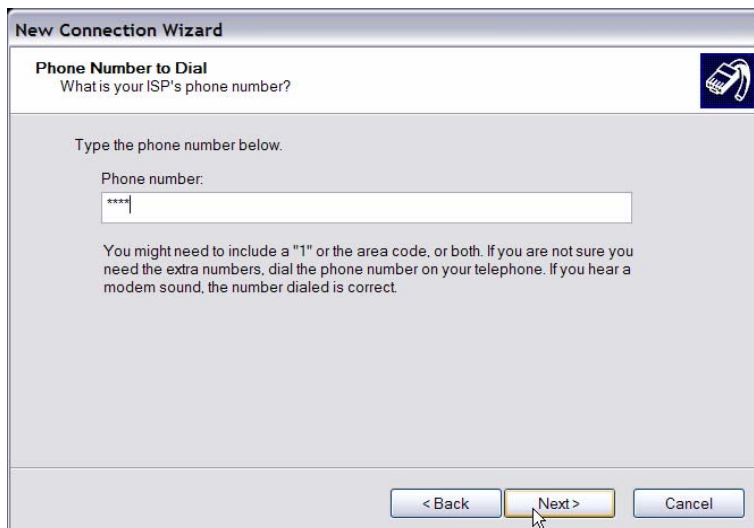

- Enter the Username and Password that is set up in the Dial-in Setup menu.



**New Connection Wizard**

**Internet Account Information**  
You will need an account name and password to sign in to your Internet account.

Type an ISP account name and password, then write down this information and store it in a safe place. (If you have forgotten an existing account name or password, contact your ISP.)

User name:

Password:

Confirm password:

Use this account name and password when anyone connects to the Internet from this computer

Make this the default Internet connection

< Back   Next >   Cancel

- Click <Finish> to complete the dial-in connection.



**New Connection Wizard**

**Completing the New Connection Wizard**

You have successfully completed the steps needed to create the following connection:

**DVR Dial-In**

- Share with all users of this computer

The connection will be saved in the Network Connections folder.

Add a shortcut to this connection to my desktop

To create the connection and close this wizard, click Finish.

< Back   Finish   Cancel

- Now the dial-in connection is established.

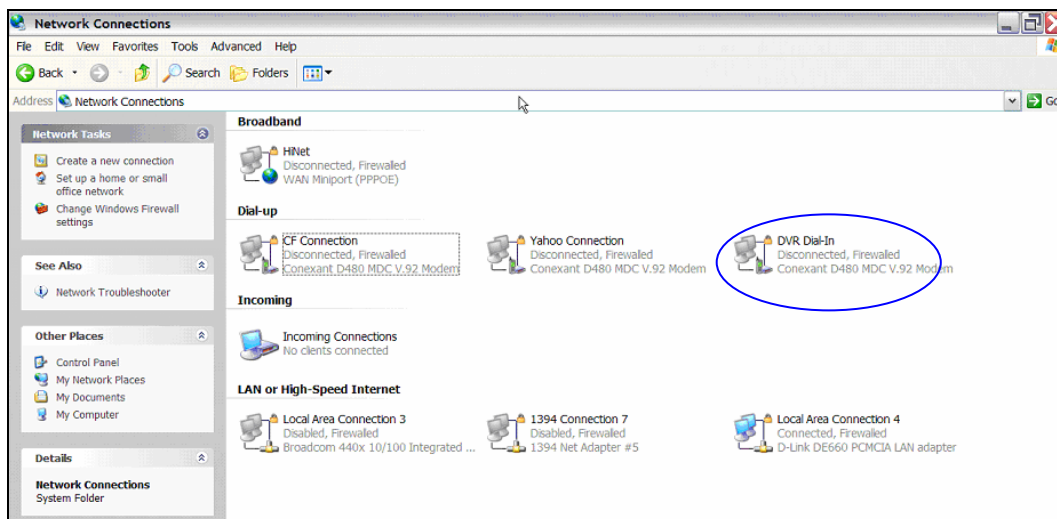

## Establishing Dial-out Connection

The Dial-out function enables the user to establish dial-up modem communication to and from the **DVR-4TN/8TN/16TN/16TS/16TT** series unit for remote notification use. Follow the instructions that follow to set up your DVR and PC.

### DVR Configuration:

- Connect a USB modem to the USB port and connect a working phone line to the modem.
- Press MENU and input the Administrator password to access the OSD Main menu. Select <Network Setup> and then <Dial-out Setup> to set up the Dial-out settings.
- Select the <Email Address> in the Network Setup menu to edit an e-mail address for alarm notification.
- Select <Event Setup> in the Main menu and set the Email Notice function to <ON> (enabled).
- Exit the OSD menu and save the configuration.
- For more information on dial-out settings, see section [5.1.6.4 Dial-out Setup](#).

**PC Configuration:**

- Click <Start>, <My Network Places>, <View Network Connections> and then select <Create New Connection>. The New Connection Wizard is displayed. Click <Next> to continue.

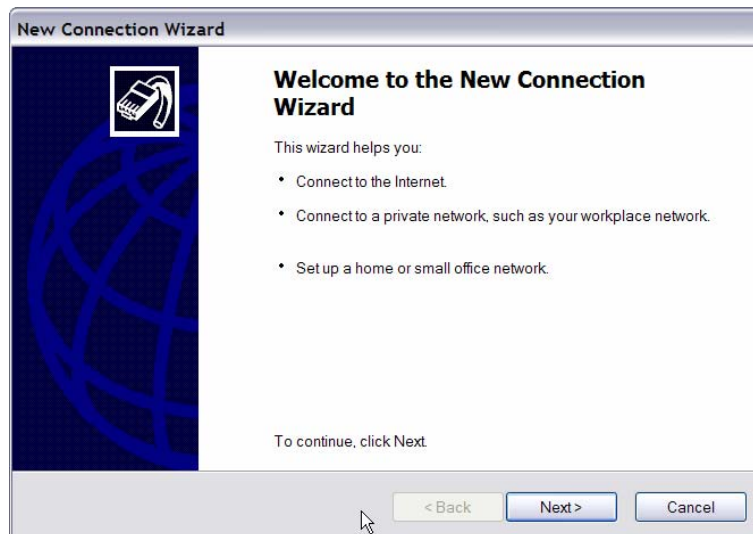

- Set up the network connection type. Select <Set up an advanced connection> and then <Accept incoming connections>. Click <Next> to continue.

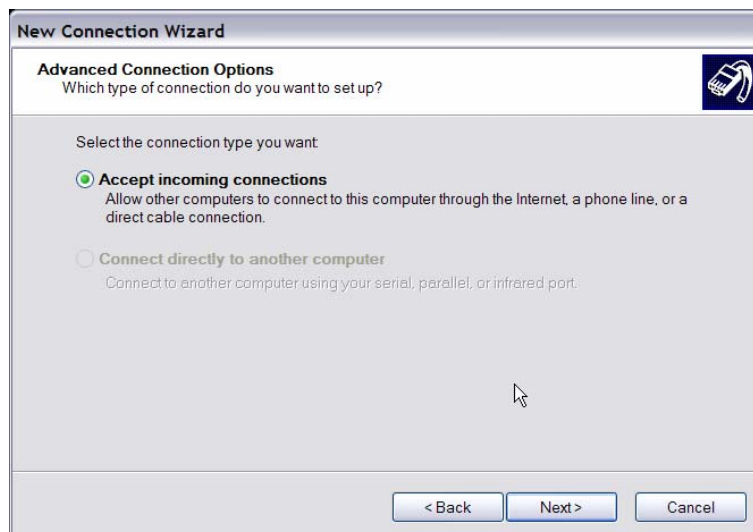

- Choose the modem device that will be used by the PC and click <Next>.

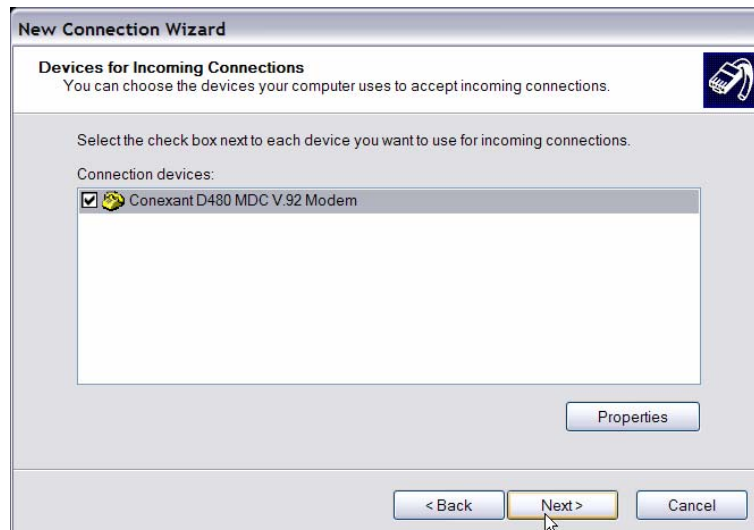

- In Incoming VPN Connection menu, choose <Do Not allow virtual private connections> and click on <Next>.



- In User Permission menu, select the users that will be using this connection. If needed, add a new user with the same user password that is set up in the Dial-out Setup menu in local DVR. When done, click <Next> to continue.



- In Networking Software menu, select <TCP/IP> and click on <Properties>.

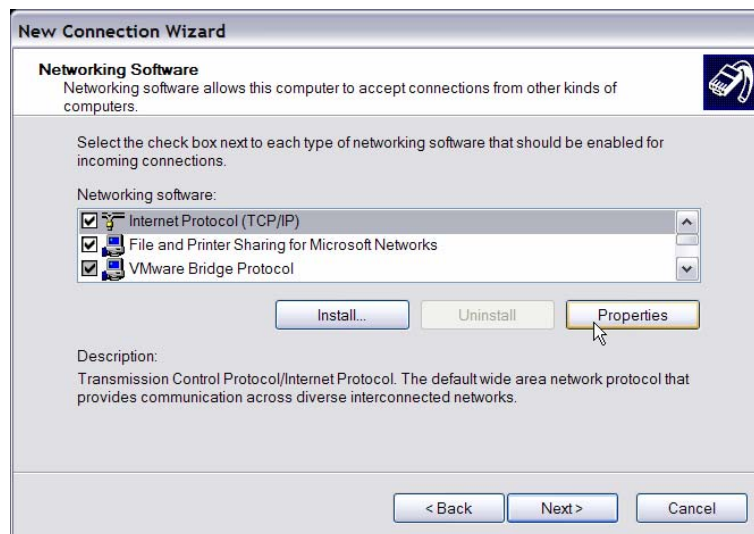



- In TCP/IP address assignment, if the PC has DHCP server, then choose <Assign TCP/IP addresses automatically using DHCP>, or choose <Specify TCP/IP addresses> and enter the range of IP addresses that you wish to use. Once done, click <OK> to confirm then back to Networking Software menu. Click on <Next> to continue.

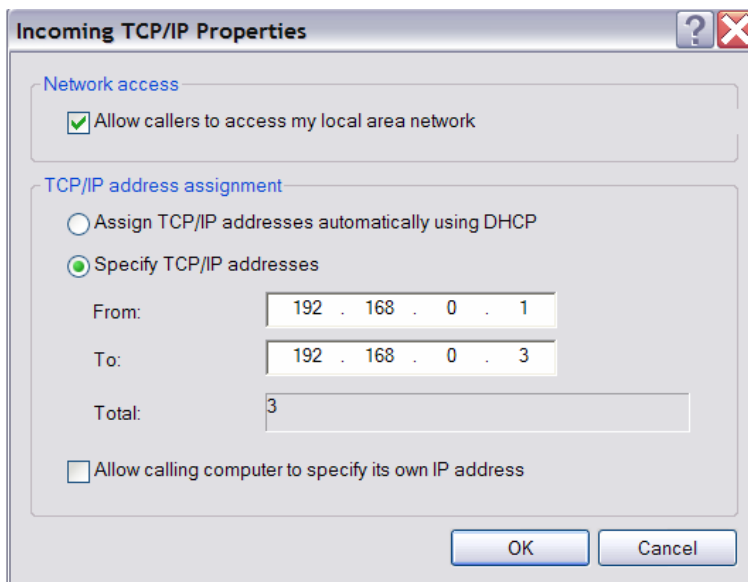

- Click <Finish> to complete the process.



- The Incoming connection is established.

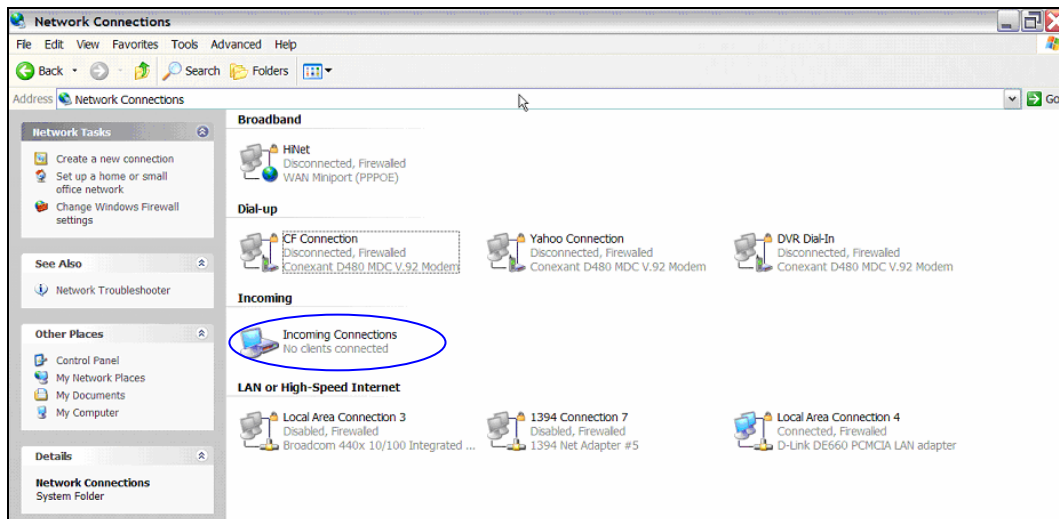

## Appendix E: Verifying Digital Signature

The digital signature aims to authenticate a video file exported from the unit. Follow the instructions to export video with a digital signature and to verify the digital signature.

### To export recorded video with digital signature:

To export recorded video with a digital signature to a USB hard drive or CD-RW drive / DVD+RW drive, follow these steps.

- In <Video Export> menu, select copy device, data type, expected channel and start/end time, or event video clips.
- Set the <Digital Signature> function to <YES>.
- Start the exporting process by setting <Begin Export> to <YES>.

Video Export			
1. Select Device			
2. Select Ch:		CH1	CH2 CH3 CH4
3. Start Time		2005/03/19	AM 07:50:05
4. End Time		2005/03/28	PM 03:09:18
5. Select Events			
6. Data Type			Normal
7. Digital Signature			NO
8. Erase Disc			NO
9. Begin Export			NO

Each recorded video will be exported into four files with different filenames, including \*.gpg, \*.drv, \*.sig and readme.txt.

### To verify the exported recorded video:

Following are the procedures for digital signature verification.

- Start your **SpecoRemote™** and click <Play> on the main window tool bar.
- Click <Verify> tab to display the Verify window.

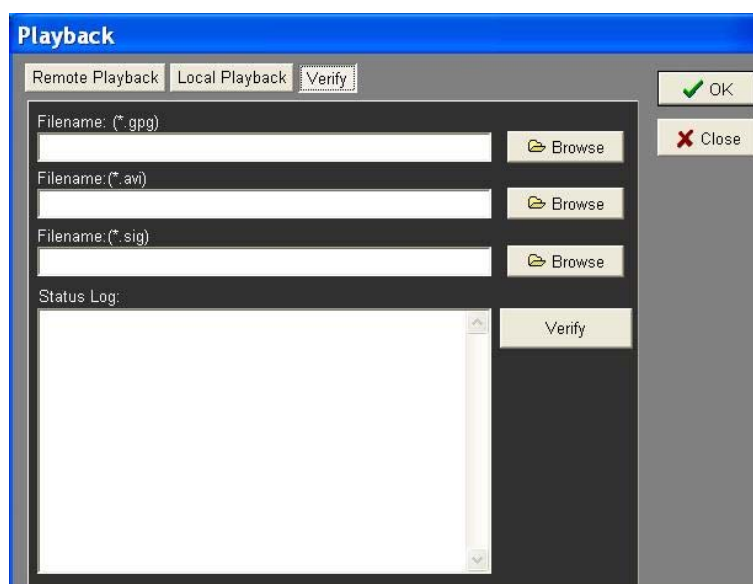

- Click <Browse> to select the \*.gpg, \*.drv, \*.sig files respectively, which belong to the exported video you want to authenticate.



- Click <Verify> to start verifying the digital signature.

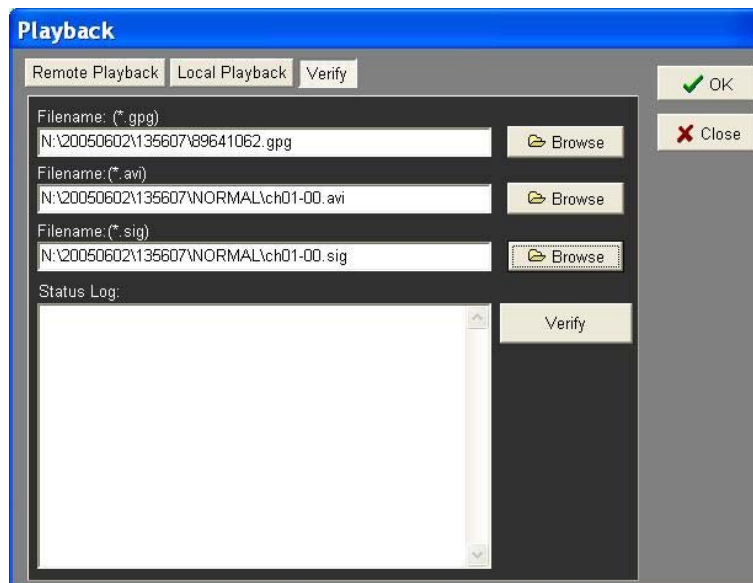

- The result of verification shows in the <Status Log> field. It returns a GOOD or BAD signature result. A GOOD signature indicates the exported clip has not been altered.

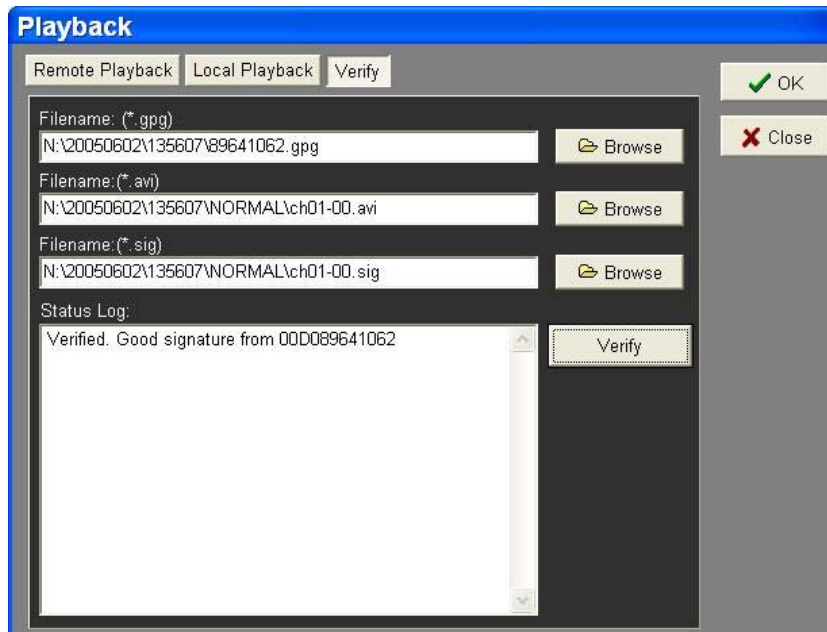

&lt;GOOD&gt; Signature

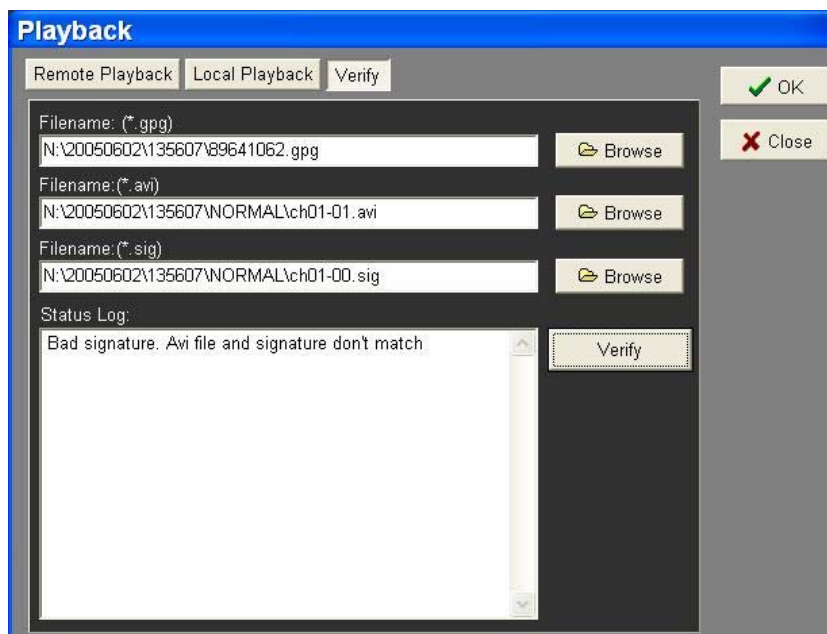

&lt;BAD&gt; Signature

## Appendix F: Alarm I/O Pin Definition

The tables below list the pin definitions of alarm I/O located on the rear panel of the DVR-4TN/8TN/16TN/16TS/16TT series unit.

### DVR-4TN Alarm I/O



Pin	Definition	Pin	Definition	Pin	Definition
1	RS485 D+	8	Normal Close 2	15	Reserved
2	RS485 D-	9	Common Node 2	16	Reserved
3	Ground	10	Normal Open 2	17	Reserved
4	Normal Close 1	11	Alarm In 1	18	Reserved
5	Common Node 1	12	Alarm In 2	19	Reserved
6	Normal Open 1	13	Alarm In 3	20	Reserved
7	Ground	14	Alarm In 4	21	-

### DVR-8TN Alarm I/O

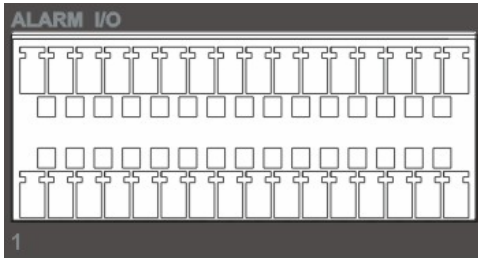

Pin	Definition	Pin	Definition	Pin	Definition
1	RS485 D+	8	Normal Close 2	15	Alarm In 5
2	RS485 D-	9	Common Node 2	16	Alarm In 6
3	Ground	10	Normal Open 2	17	Alarm In 7
4	Normal Close 1	11	Alarm In 1	18	Alarm In 8
5	Common Node 1	12	Alarm In 2	19	Reserved
6	Normal Open 1	13	Alarm In 3	20	Reserved
7	Ground	14	Alarm In 4	21	-

**DVR-16TN/16TS/16TT Alarm I/O**

Pin	Definition	Pin	Definition	Pin	Definition
1	RS485 D+	12	N/A	23	Alarm In 7
2	RS485 D-	13	N/A	24	Alarm In 8
3	Ground	14	N/A	25	Alarm In 9
4	Normal Close 1	15	Ground	26	Alarm In 10
5	Common Node 1	16	Ground	27	Alarm In 11
6	Normal Open 1	17	Alarm In 1	28	Alarm In 12
7	Ground	18	Alarm In 2	29	Alarm In 13
8	Normal Close 2	19	Alarm In 3	30	Alarm In 14
9	Common Node 2	20	Alarm In 4	31	Alarm In 15
10	Normal Open 2	21	Alarm In 5	32	Alarm In 16
11	Ground	22	Alarm In 6	33	-

## Appendix G: Hard Disk Installation

The following steps describe how to install HDD(s) to your **DVR-4TN/8TN/16TN/16TS/16TT** unit.

**Step 1: Disconnect power from the unit. Remove the 8 screws that hold the top cover in place(3 on each side, 2 in the rear).Remove the top cover by sliding it to the rear.**



**Figure 1: External appearance of DVR-4TN/8TN/16TN/16TS/16TT**



**Figure 2: Internal construction of DVR-4TN/8TN/16TN/16TS/16TT**

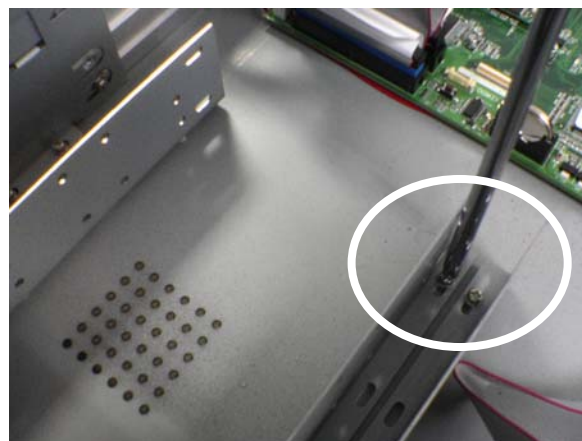

**Figure 3: Remove screws from the bracket**



**Step 2: Assemble the HDD to the bracket**



**Figure 4: The components**



**Figure 5: Attach the HDD to the bracket**

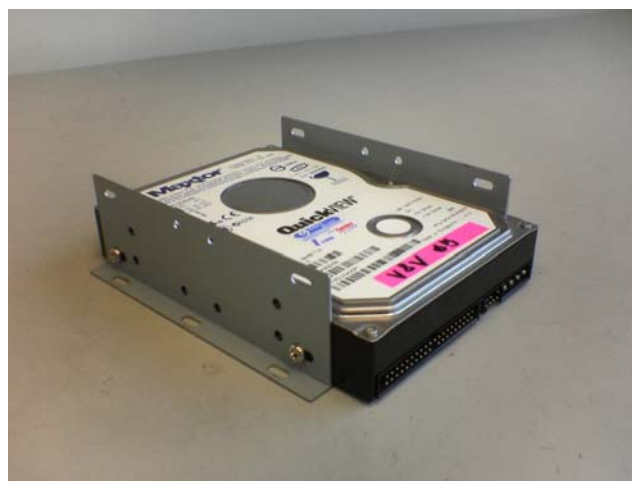

**Figure 6: After assembly**

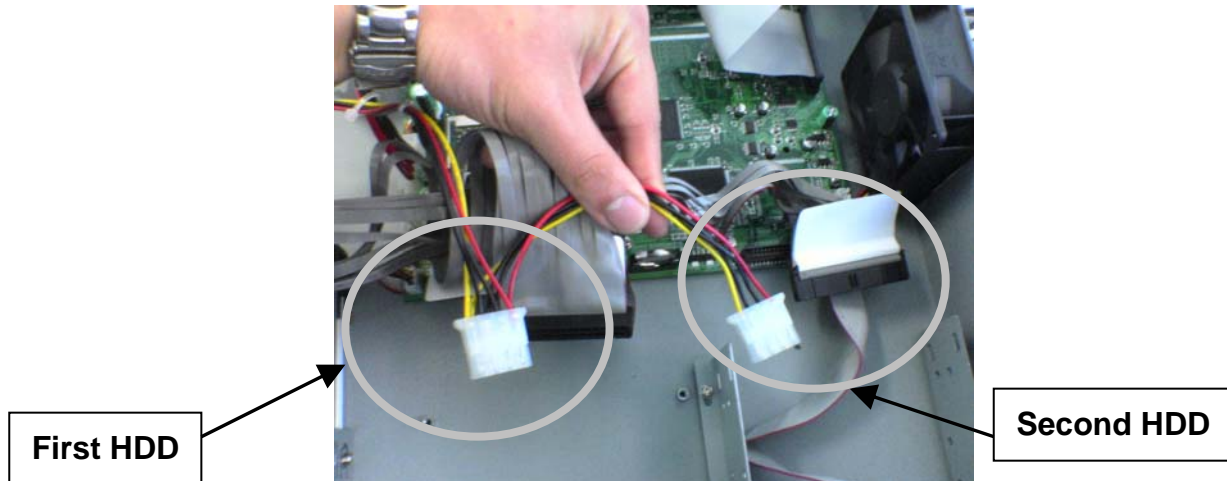
**Step 3: Install the HDD on your unit****Figure 7: Wiring the two sets of HDD's**

If you want to install only one HDD, please adjust the HDD's jumper to "Master"; if you need to install two, then adjust one to "Master" and the other to "Slave".

**Note:** The external HDD should be set to "Master"(default).

**Figure 8: Connect the wire****Figure 9: Attach the bracket to the DVR**



**Figure 10: Close your case**

**Step 4: Confirm if the HDD has been detected.**

After installing your HDD, you can turn on the unit and enter the OSD menu for make sure the HDD has been detected , the OSD path is *Database Setup*  
*→ Internal Disks*

**Below lists the table of recommended HDDs:**

<b>Maxtor</b>	Diamond Max Plus 9	80G/ 160G/ 300G
	Diamond Max Plus 16	80G/ 160G/ 300G
<b>Seagate</b>	Barracuda 7200.7	200G
	Barracuda 7200.8	250G/ 300G/ 400G
	Barracuda 7200.10	720G
<b>Hitachi</b>	Deskstar 7200rpm	60G/ 300G/ 400G/ 500G

## Appendix H: HDD PC Player Tool Introduction

For some specific reasons, users may need to view the stored data in the HDD on Personal Computer; this document guides you how to do that step by step.

### Using EXT2IFS on Your PC

EXT2IFS, an installed File System Driver, allows you to run a Linux System on Windows System. If you are a Windows user, then you need to install EXT2IFS to your PC before you start using SpecoPlayer to see the \*drv file . To get the software EXT2IFS, you can visit <http://uranus.it.swin.edu.au/~jn/linux/ext2ifs.htm> and download EXT2IFS. A detailed description about the software also can be found on the website.

The following steps guide you how to use the EXT2IFS software .

**Step 1.** Download EXT2IFS to your PC through above website address.

**Step 2.** Remove the HDD from your **DVR-4TN/8TN/16TN/16TS/16TT** series and install the removed HDD into your PC. When done, reboot the PC.

**Step 3.** Extract and Launch EXT2IFS Setup Wizard.

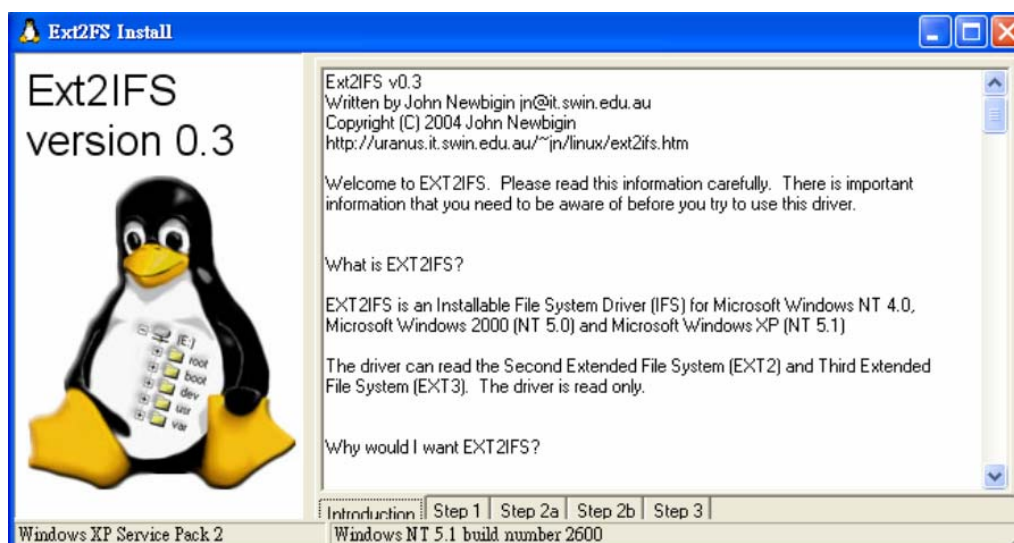

**Step 4.** Click <Step1> sheet, and then choose <Install to System Root> and <Start drive on boot> options. When done, click <Install Drive> button.

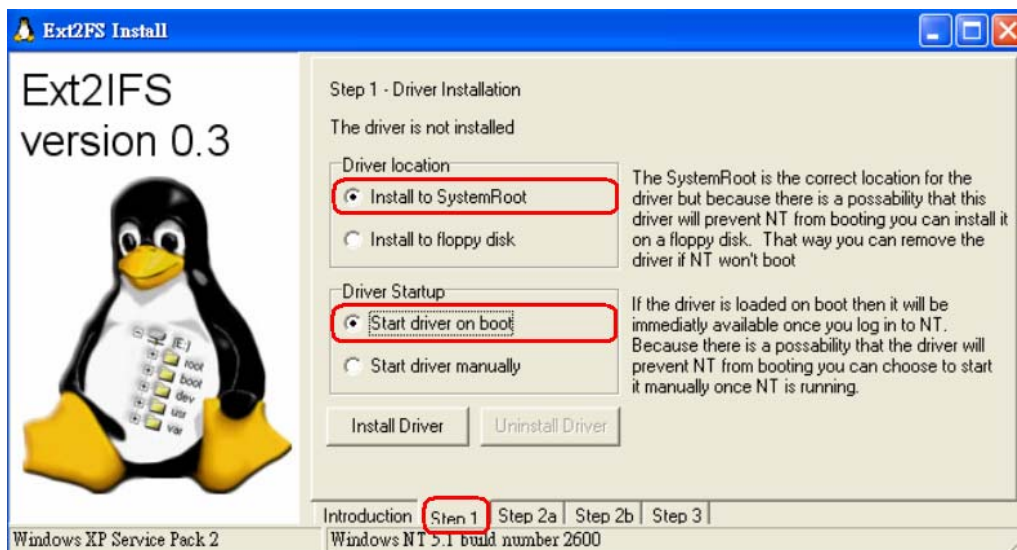

**Step 5.** Click <Step2b> sheet. Click <Drive> to assign each partition a drive.

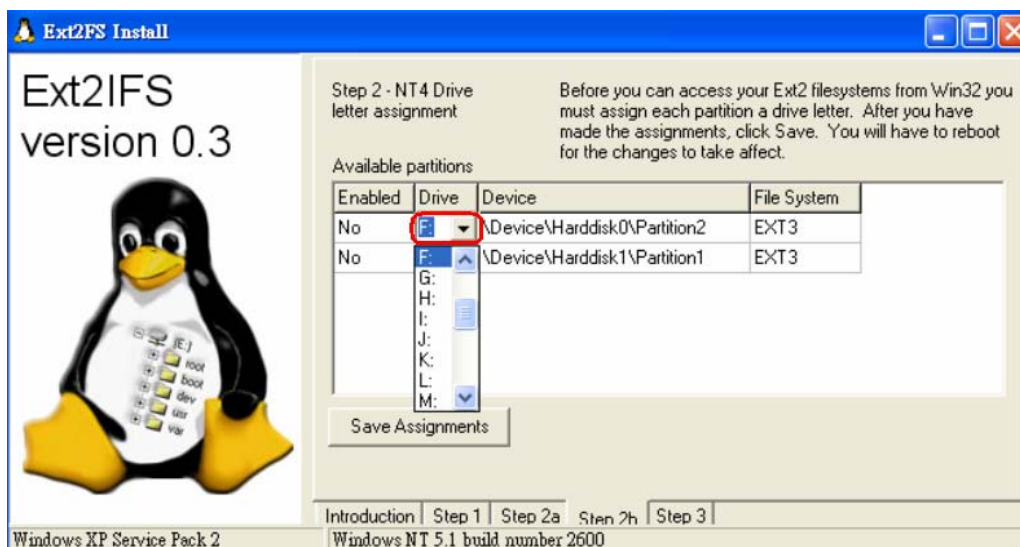

**Step 6.** Click <Step1> sheet, and then choose <Install to System Root> and <Start drive on boot> options. When done, click <Install Drive> button. After the assignments are made, click <Save Assignments> button.

**Step 7.** Click <Step1> sheet, and then choose <Install to System Root> and <Start drive on boot> options. When done, click <Install Drive> button. Click <Step3> sheet. Then click <Start Drive> button.

**Step 8.** Click <Step1> sheet, and then choose <Install to System Root> and <Start drive on boot> options. When done, click <Install Drive> button. After last step is done, reboot the PC for the changes to take effect. The HDD will be added into your PC's database after rebooting.

### Start Playing the \*.drv file

After the HDD being added into your PC's database , you can now use the SpecoPlayer to play the \*.drv file in your HDD. Please referring to the steps below:

**Step 1.** You can find the SpecoPlayer in the CD that ship with the package, start it and push the "PLAY" button on the upside of the frame.

**Step 2.** Click the "Open Device" button (as below picture), then choose the HDD Drive that you just assigned.

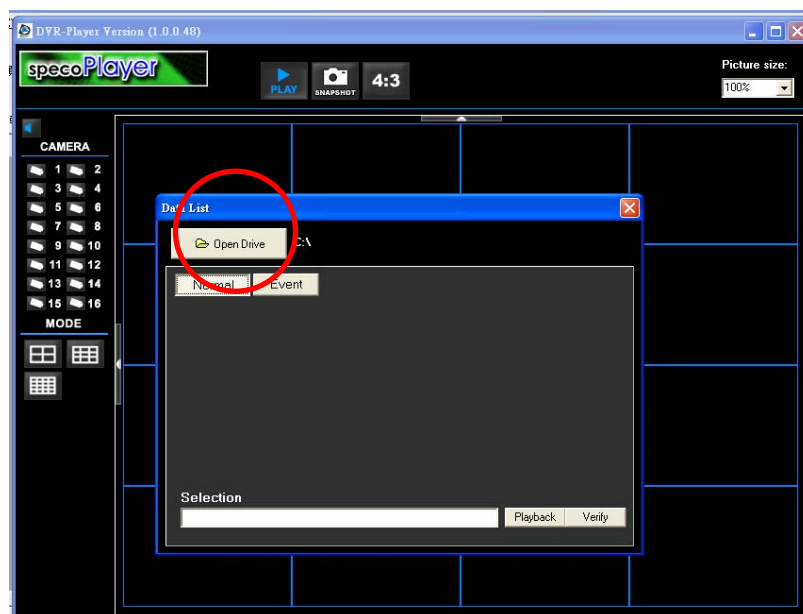

**Figure 1: Select the Drive**

**Step 3.** After choosing the HDD Drive , choose the video file that you want to use.

**Step 4.** Click the “Playback” to play the video directly or “Export” if you want to save the \*.drv file into your PC.

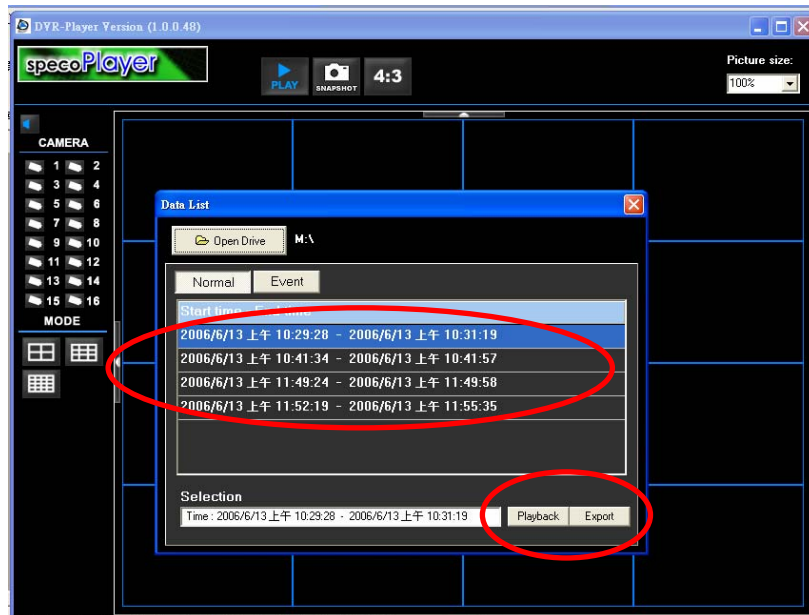

**Figure 2: Select the file you want to use**

## Appendix I: IR Remote

An IR Remote will be attached in the content box and deliver to you with your DVR-4TN/ DVR-8TN/ DVR-16TN. The keys on the IR Remote are listed as below figure:

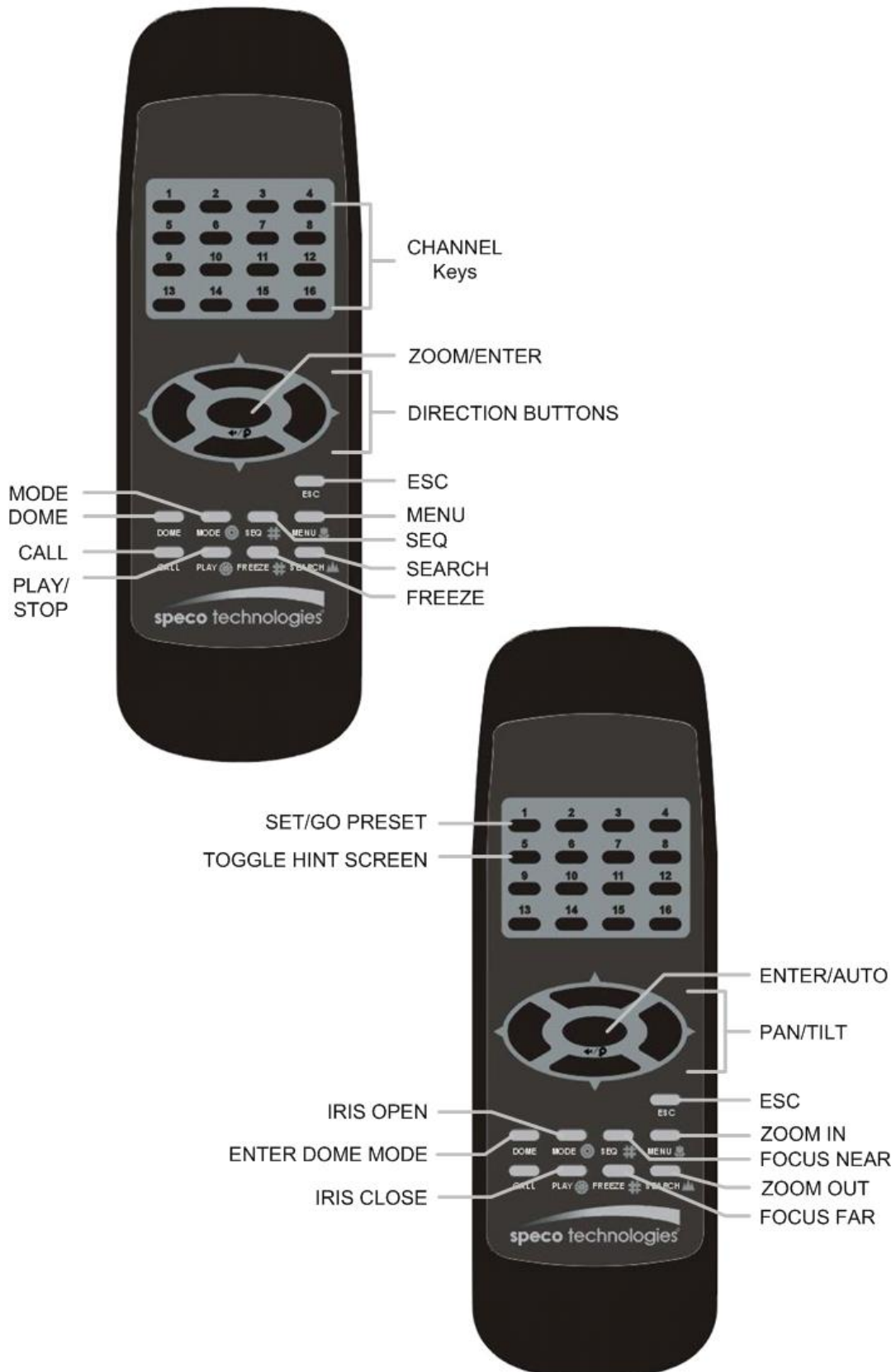



## Appendix J: ezRecord Diagram Sample

### Diagram Sample( Full-D1 )

NTSC:720x480@30PPS

PAL:720x576@25PPS

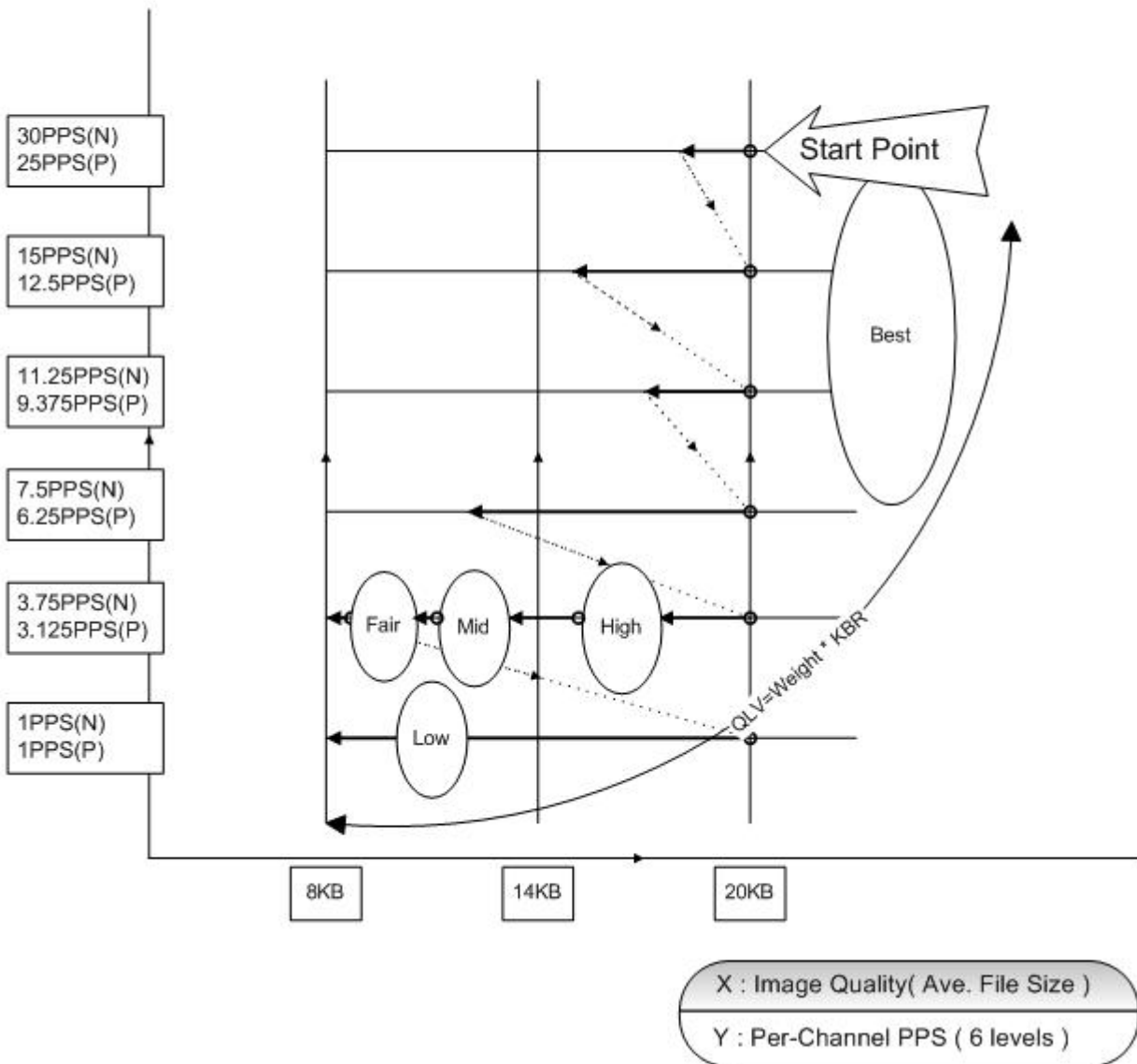

# Diagram Sample( Half-D1 )

NTSC:720x240@60PPS

PAL:720x288@50PPS

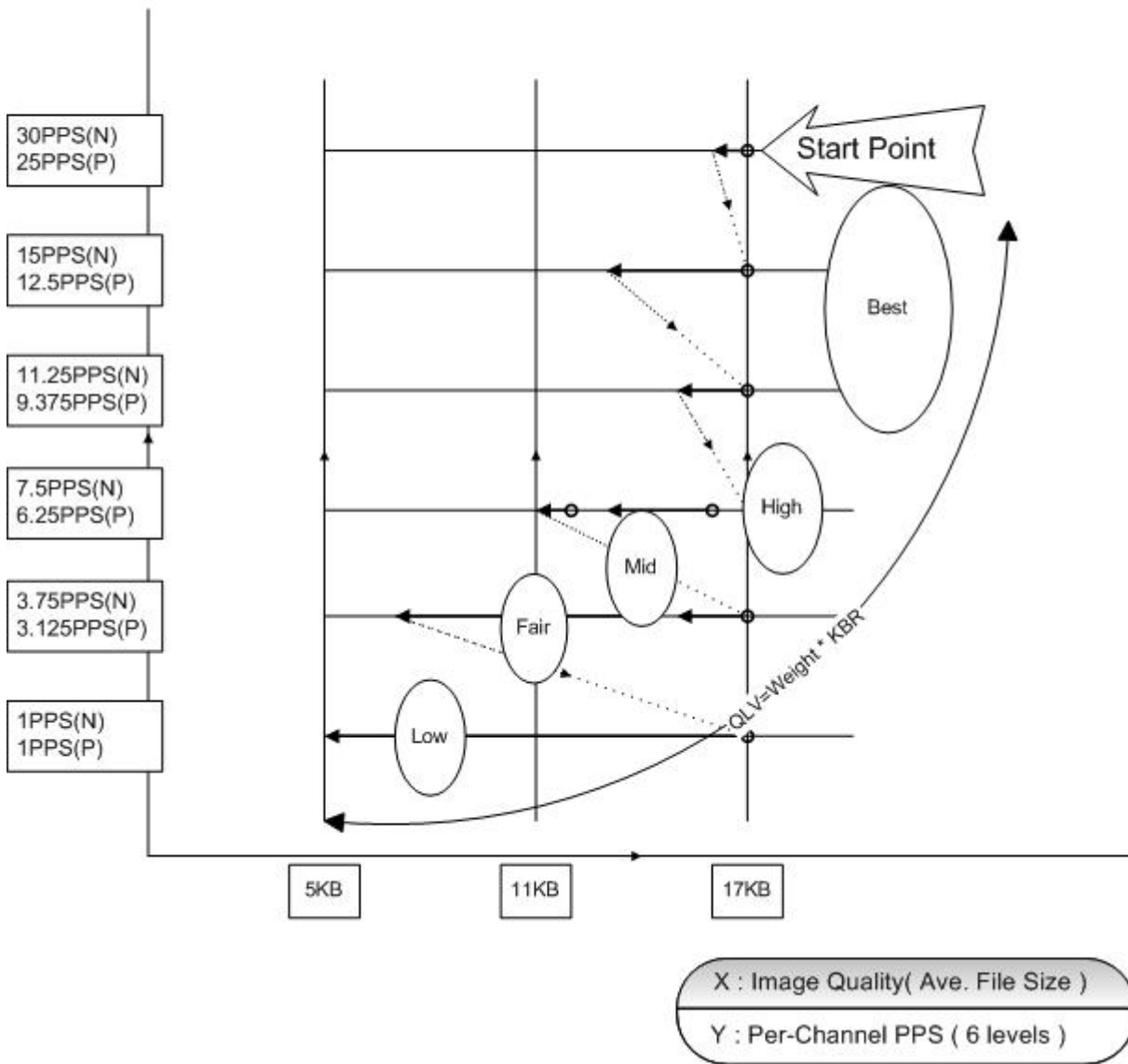

# Diagram Sample( CIF )

NTSC:360x240@120PPS

PAL:360x288@100PPS

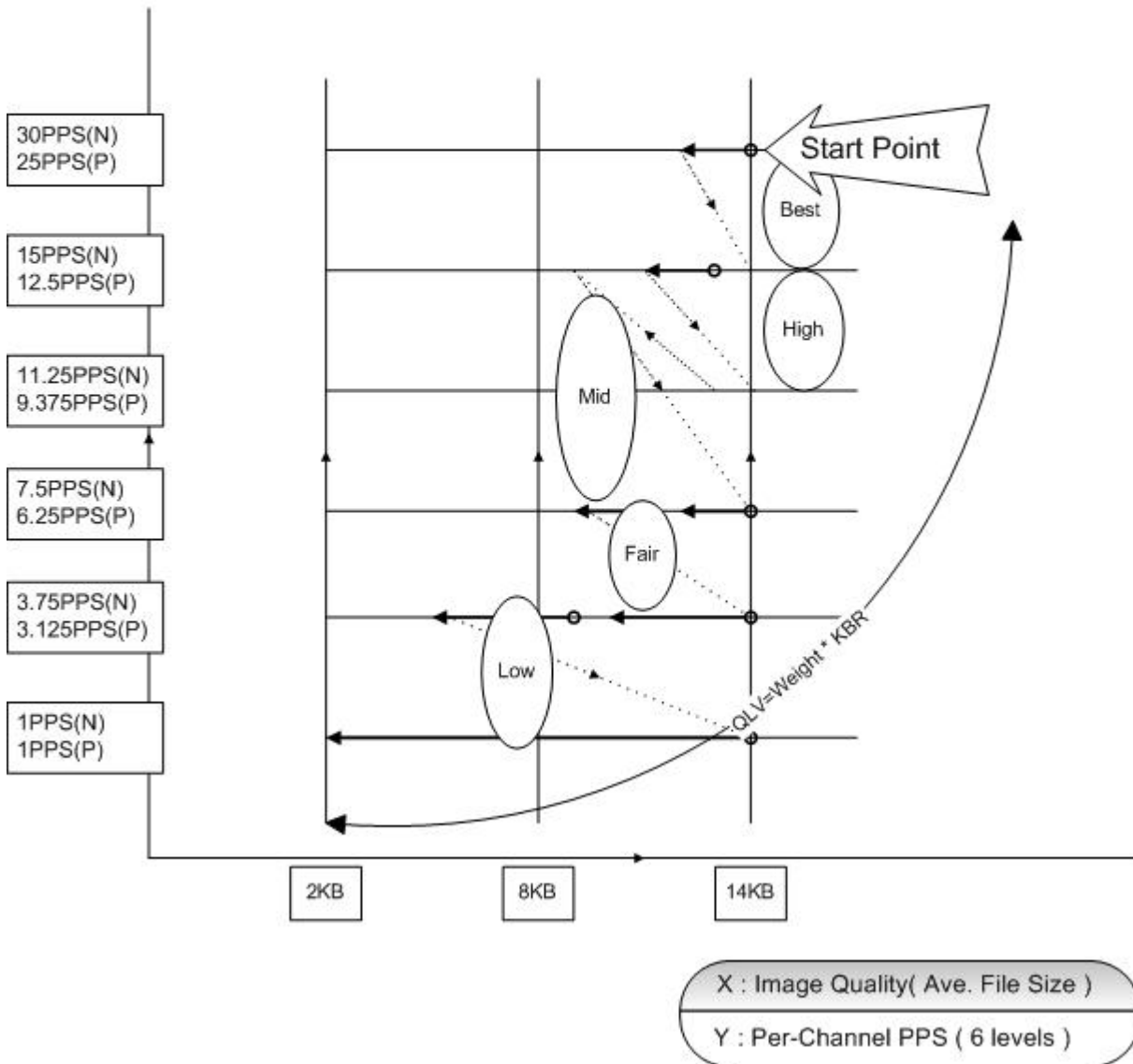

## Free Manuals Download Website

<http://myh66.com>

<http://usermanuals.us>

<http://www.somanuals.com>

<http://www.4manuals.cc>

<http://www.manual-lib.com>

<http://www.404manual.com>

<http://www.luxmanual.com>

<http://aubethermostatmanual.com>

Golf course search by state

<http://golfingnear.com>

Email search by domain

<http://emailbydomain.com>

Auto manuals search

<http://auto.somanuals.com>

TV manuals search

<http://tv.somanuals.com>