

## DCR-SR15E/SR20E/SX15E/ SX20E/SX20EK

### Digital Video Camera Recorder "Handycam" Handbook

Table of contents	8
Getting started	11
Recording/Playback	20
Making good use of your camcorder	35
Saving images with an external device	45
Customizing your camcorder	53
Additional information	70
Quick reference	89



MEMORY STICK™



InfoLITHIUM™ V SERIES



CLASS@



CLASS@

# HANDYCAM®

# Read this first

## Supplied items

The numbers in ( ) are the supplied quantity.

- AC Adaptor (1)
- Power cord (Mains lead) (1)
- A/V connecting cable (1) **A**
- USB cable (1) **B**
- Rechargeable battery pack NP-FV30 (1)
- CD-ROM “Handycam” Application Software (1)
  - “PMB” (software, including “PMB Help”)
  - “Handycam” Handbook (PDF)
- “Operating Guide” (1)

**A**

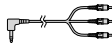

**B**



For DCR-SX20EK only\*

- Memory card (4GB)\*\*

\* Confirm the model name on the packing box.

\*\* When measuring media capacity, 1 GB equals 1 billion bytes, a portion of which is used for system management and/or application files. The capacity that a user can use is approximately 3.83 GB.

- See page 19 for the memory card you can use with this camcorder.

## Using the camcorder

- Do not hold the camcorder by the following parts, and also do not hold the camcorder by the jack covers.

## LCD screen

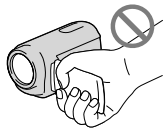

## Battery pack

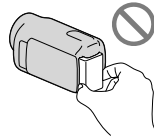

- The camcorder is not dustproofed, dripproofed or waterproofed. See “About handling of your camcorder” (p. 85).

## Menu items, LCD panel, and lens

- A menu item that is grayed out is not available under the current recording or playback conditions.
- The LCD screen is manufactured using extremely high-precision technology, so over 99.99% of the pixels are operational for effective use. However, there may be some tiny black points and/or bright points (white, red, blue, or green in color) that appear constantly on the LCD screen. These points are normal results of the manufacturing process and do not affect the recording in any way.

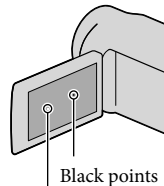

White, red, blue or green points

- Exposing the LCD screen or the lens to direct sunlight for long periods of time may cause malfunctions.
- Do not aim at the sun. Doing so might cause your camcorder to malfunction. Take images of the sun only in low light conditions, such as at dusk.

## About changing the language setting

- The on-screen displays in each local language are used for illustrating the operating procedures. Change the screen language before

using your camcorder if necessary (p. 16).

## Recording

- When you use a memory card with your camcorder for the first time, formatting the memory card with your camcorder (p. 66) is recommended for stable operation.  
All data recorded on the memory card will be deleted when it is formatted, and cannot be recovered. Save important data to your computer, etc., beforehand.
- Before starting to record, test the recording function to make sure that the image and sound are recorded without any problems.
- Compensation for the contents of recordings cannot be provided, even if recording or playback is not possible due to a malfunction of the camcorder, storage media, etc.
- TV color systems differ depending on the country/region. To view your recordings on a TV, you need a PAL system-based TV.
- Television programs, films, video tapes, and other materials may be copyrighted. Unauthorized recording of such materials may be contrary to copyright laws.

## Note on playback

- Images recorded on your camcorder may not play correctly on other devices.  
Conversely, images recorded on other devices may not play correctly on this camcorder.
- Movies recorded on SD memory cards cannot be played on A/V equipment of other manufacturers.

## Save all your recorded image data

- To prevent your image data from being lost, save all your recorded images on external media periodically. It is recommended that you save the image data on a disc such as a DVD-R using your computer. Also, you can save your image data using a VCR or a DVD/HDD recorder, etc. (p. 48).

## Notes on battery pack/AC Adaptor

- Be sure to remove the battery pack or the AC Adaptor after turning off the camcorder.

- Disconnect the AC Adaptor from the camcorder, holding both the camcorder and the DC plug.

## Note on the camcorder/battery pack temperature

- When the temperature of the camcorder or battery pack becomes extremely high or extremely low, you may not be able to record or play back on the camcorder, due to the protection features of the camcorder being activated in such situations. In this case, an indicator appears on the LCD screen (p. 75).

## When the camcorder is connected to a computer or accessories

- Do not try to format the recording media of the camcorder using a computer. If you do so, your camcorder may not operate correctly.
- When connecting your camcorder to another device with a cable, be sure to insert the connector plug in the correct way. Pushing the plug forcibly into the terminal will damage the terminal and may result in a malfunction of your camcorder.

## If you cannot record/play back images, perform [MEDIA FORMAT]

- If you repeat recording/deleting images for a long time, fragmentation of data occurs on the recording media. Images cannot be saved or recorded. In such a case, save your images on some type of external media first, and then perform [MEDIA FORMAT] by selecting **MENU** (MENU) → [Show others] → [MEDIA FORMAT] (under  [MANAGE MEDIA] category) → the desired medium (DCR-SR15E/SR20E) → [YES] → [YES] → **OK**.

## Notes on optional accessories

- We recommend using genuine Sony accessories.
- Availability of such products is subject to country/region.

## About images, illustrations, and screen displays of this manual

- The example images used in this manual for

illustration purposes are captured using a digital still camera, and therefore may appear different from images and screen indicators that actually appear on your camcorder. And, the illustrations of your camcorder and its screen indication are exaggerated or simplified for understandability.

- In this manual, the internal hard disk (DCR-SR15E/SR20E) of your camcorder and memory card are called “recording media.”
- Design and specifications of your camcorder and accessories are subject to change without notice.

### Confirm the model name of your camcorder

- The model name is shown in this manual when there is a difference in specification between models. Confirm the model name on the bottom of your camcorder.
- The main differences in specification of this series are as follows.

	Recording media	Capacity of internal recording media	USB jack
DCR-SR15E	Internal hard disk + memory card	80 GB	Output only
DCR-SR20E			Input/output
DCR-SX15E	Memory card	—	Output only
DCR-SX20E			Input/output

### Notes on use

- Do not do any of the following, otherwise, the recording media may be damaged, recorded images may be impossible to play back or may be lost, or other malfunctions could occur.
  - Eject the memory card when the access lamp (p. 19) is lit or flashing
  - Remove the battery pack or AC Adaptor from

the camcorder, or subject the camcorder to shock or vibration when the POWER lamp (p. 14) or the access lamp (p. 19) are lit or flashing

- When using a shoulder belt (sold separately), do not crash the camcorder against an object.
- Do not use your camcorder in very loud areas (DCR-SR15E/SR20E).

### On the drop sensor (DCR-SR15E/SR20E)

- To protect the internal hard disk from shock by dropping, the camcorder has a drop sensor function (p. 69). When a drop occurs, or under a non-gravity condition, the block noise made when this function is activated by the camcorder may also be recorded. If the drop sensor catches a drop repeatedly, recording/playback may be stopped.

### Note on using the camcorder at high altitudes (DCR-SR15E/SR20E)

- Do not turn on the camcorder in a low-pressure area, where the altitude is more than 5,000 meters (16,000 feet). Doing so may damage the internal hard disk drive of your camcorder.

# Operation flow

## Getting started (p. 11)

Prepare the power source and recording media.

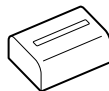

## Recording movies and photos (p. 20)

Recording movies → p. 21

💡 Changing the recording mode (p. 25)

💡 Expected recording time (MEDIA INFO, p. 66)

Shooting photos → p. 23



## Playing movies and photos

Playback on the camcorder → p. 27

Playing images on a TV → p. 33

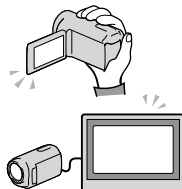

## Saving images

Saving movies and photos with a computer

Saving movies and photos in external media → p. 45

Saving images with a DVD writer/recorder → p. 48

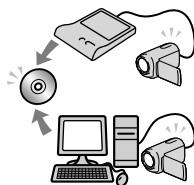

## Deleting movies and photos (p. 35)

If you delete the image data that has been saved on your computer or a disc, you can record new images on the free media space again.

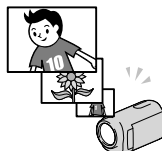

# Advice for successful recording

## ■ To get good results in recording



### ★ Stabilizing your camcorder

When you hold the camcorder, keep your upper body upright, and hold your arms close to your body.

The SteadyShot function is effective against camera-shake, however, it is essential that you not move the camcorder.

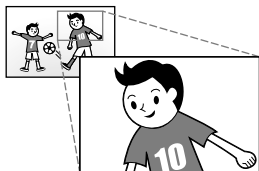

### ★ Zooming smoothly

Zoom in and out slowly and smoothly. And, use zooming sparingly. Excessive zooming will make movies that may make the viewer feel tired when viewing them.



### ★ Evoking a feeling of spaciousness

Use the panning technique. Stabilize yourself, move your camcorder horizontally as you turn your upper body slowly. Stay still at the end of panning for a while to make the scene look stable.



### ★ Accentuating movies with narration

Consider the sound to be recorded with your movies. Narrate the subject, or talk to the subject during shooting.

Aim for a balanced volume of voices, since the recording person is closer to the microphone than the recorded person.



### ★ Using accessories

Make good use of camcorder accessories.

For example, using a tripod, you can make a time-lapse recording or record subjects in dim light, such as scenes of fireworks, or night views. By always carrying spare batteries, you can continue recording without worrying about battery power shortages.

## ■ Useful recording techniques

### Flowers in close-up

PORTRAIT (58)

TELE MACRO (60)



### Recording in a dimly-lit room

VIDEO LIGHT (26)



### Capturing fireworks, or a sunset in all its splendor

FIREWORKS (58)

SUNRISE&SUNSET (58)



### Checking your golf swing

SPORTS (58)



# Table of contents

Read this first .....	2
Notes on use .....	4
Operation flow .....	5
Advice for successful recording .....	6









## ■ Getting started

Step 1: Charging the battery pack .....	11
Step 2: Turning the power on, and setting the date and time .....	14
Using the Multi-selector .....	16
Changing the language setting .....	16
Step 3: Preparing the recording media .....	17
Selecting the recording media for movies (DCR-SR15E/SR20E) .....	17
Selecting the recording media for photos (DCR-SR15E/SR20E) .....	18
Inserting a memory card .....	18

## ■ Recording/Playback

Recording .....	20
Recording movies .....	21
Shooting photos .....	23
Useful functions for recording movies and photos .....	25
Zooming .....	25
Selecting the recording mode .....	25
Using the VIDEO LIGHT .....	26
Adjusting the exposure for backlit subjects .....	26
Recording in mirror mode .....	26
Playback on the camcorder .....	27
Useful functions for playing movies and photos .....	30
Searching for desired images by date (Date Index) .....	30
Searching for desired scene by pinpoint (Film Roll Index) .....	30
Searching for desired scene by face (Face Index) .....	31
Playing back a series of photos (Slide show) .....	32
Playing images on a TV .....	33



<b>■ Making good use of your camcorder</b>	
Deleting movies and photos .....	35
Protecting recorded movies and photos (Protect) .....	37
Dividing a movie .....	38
Capturing a photo from a movie (DCR-SR15E/SR20E/SX20E) .....	39
Dubbing/copying movies and photos from the internal recording media to memory card (DCR-SR15E/SR20E) .....	40
Dubbing movies .....	40
Copying photos .....	41
Using the Playlist of movies .....	43
Creating the Playlist .....	43
Playing the Playlist .....	43
<b>■ Saving images with an external device</b>	
Saving images in external media (DIRECT COPY) .....	45
Creating a disc with a DVD writer, recorder .....	48
Creating a disc with the dedicated DVD writer, DVDirect Express .....	48
Creating a disc with a DVD writer, etc., other than DVDirect Express .....	50
Creating a disc with a recorder, etc. ....	51
<b>■ Customizing your camcorder</b>	
Using menus .....	53
Operating menus .....	53
Using MY MENU .....	54
Using the  OPTION MENU .....	55
Menu lists .....	56
 MANUAL SETTINGS (Items to adjust for scene condition) .....	58
 SHOOTING SET (Items for customized shooting) .....	61
 PHOTO SETTINGS (Items for recording photos) .....	63
 PLAYBACK (Items for playback) .....	64
 EDIT (Items for editing) .....	65
 OTHERS (Items for other settings) .....	65
 MANAGE MEDIA (Items for recording media) .....	66
 GENERAL SET (Other setup items) .....	67

## ■ Additional information

? Troubleshooting.....	70
Self-diagnosis display/Warning indicators.....	75
Recording time of movies/number of recordable photos .....	79
Expected time of recording and playback with each battery pack.....	79
Expected recording time of movies.....	79
Expected number of recordable photos .....	80
Using your camcorder abroad.....	81
Maintenance and precautions.....	83
About the memory card.....	83
About the “InfoLITHIUM” battery pack .....	84
About handling of your camcorder .....	85

## ■ Quick reference

Screen indicators.....	89
Parts and controls.....	90
Index.....	93

# Step 1: Charging the battery pack

## DCR-SR15E/SR20E

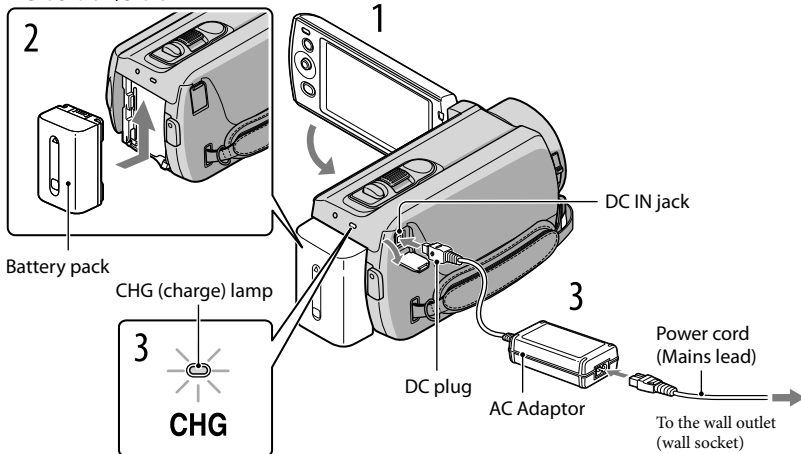

## DCR-SX15E/SX20E

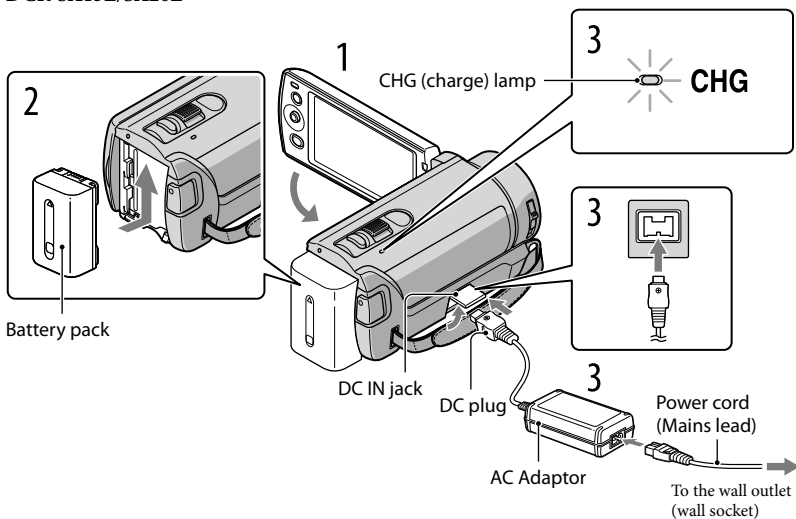

You can charge the "InfoLITHIUM" battery pack (V series) after attaching it to your camcorder.

## Notes

- You cannot attach any “InfoLITHIUM” battery pack other than the V series to your camcorder.

- 1 Turn off your camcorder by closing the LCD screen.
- 2 Attach the battery pack by sliding it in the direction of the arrow until it clicks.
- 3 Connect the AC Adaptor and the power cord (mains lead) to your camcorder and the wall outlet (wall socket).
  - Align the ▲ mark on the DC plug with that on the DC IN jack.The CHG (charge) lamp lights up and charging starts. The CHG (charge) lamp turns off when the battery pack is fully charged.
- 4 When the battery is charged, disconnect the AC Adaptor from the DC IN jack of your camcorder.

## Tips

- See page 79 on recording and playing time.
- When your camcorder is on, you can check the approximate amount of remaining battery power with the remaining battery indicator at the upper left on the LCD screen.

## Charging time

Approximate time (min.) required when you fully charge a fully discharged battery pack.

Battery pack	Charging time
NP-FV30 (supplied)	115
NP-FV50	155
NP-FV70	195
NP-FV100	390

- Times measured with the camcorder at 25 °C (77 °F).  
10 °C to 30 °C (50 °F to 86 °F) is recommended.

## To remove the battery pack

Close the LCD screen. Slide the BATT (battery) release lever (①) and remove the battery pack (②).

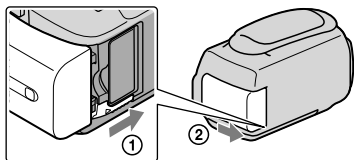

## To use a wall outlet (wall socket) as a power source

Make the same connections as “Step 1: Charging the battery pack.” Even if the battery pack is attached, the battery pack is not discharged.

## Charging the battery pack abroad

You can charge the battery pack in any countries/regions using the AC Adaptor supplied with your camcorder within the AC 100 V - 240 V, 50 Hz/60 Hz range.

### ⚡ Notes

- Do not use an electronic voltage transformer.

## Notes on the battery pack

- When you remove the battery pack or disconnect the AC Adaptor, close the LCD screen and make sure that the POWER lamp (p. 14), the access lamp (p. 19) are turned off.
- The CHG (charge) lamp flashes during charging under the following conditions:
  - The battery pack is not attached correctly.
  - The battery pack is damaged.
  - The temperature of the battery pack is low.  
Remove the battery pack from your camcorder and put it in a warm place.
  - The temperature of the battery pack is high.  
Remove the battery pack from your camcorder and put it in a cool place.
- In the default setting, the power turns off automatically if you leave your camcorder without any operation for about 5 minutes, to save battery power ([A.SHUT OFF], p. 68).

## Notes on the AC Adaptor

- Use the nearby wall outlet (wall socket) when using the AC Adaptor. Disconnect the AC Adaptor from the wall outlet (wall socket) immediately if any malfunction occurs while using your camcorder.
- Do not use the AC Adaptor placed in a narrow space, such as between a wall and furniture.
- Do not short-circuit the DC plug of the AC Adaptor or battery terminal with any metallic objects. This may cause a malfunction.

## Step 2: Turning the power on, and setting the date and time

- 1 Open the LCD screen of your camcorder.

Your camcorder turns on.

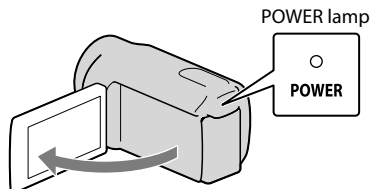

- 2 Select the desired geographical area by selecting / with / of the multi-selector, keep pressing the center of the multi-selector until the desired geographical area is turned on a light.

Multi-selector

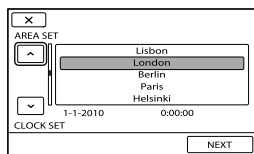
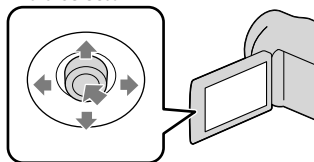

- See page 16 for the detail of the using the multi-selector.
- To set the date and time again, operate the multi-selector to select **MENU** (MENU) → [Show others] → [CLOCK/🗨️LANG] (under [GENERAL SET] category) → [CLOCK SET]. When an item is not on the screen, select / until the item appears.

- 3 Select [NEXT] with of the multi-selector, then press the center of the multi-selector.

- 4 Select setting of [SUMMERTIME] with / of the multi-selector, and press the center of the multi-selector.

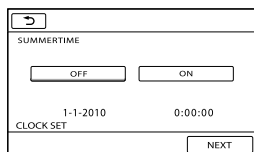

If you set [SUMMERTIME] to [ON], the clock advances 1 hour.

5 Select [NEXT] with ▼ of the multi-selector, then press the center of the multi-selector.

6 Set the date and time by repeating the procedure bellow.

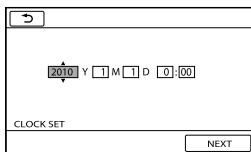

① Highlight the desired item with ◀/▶ of the multi-selector.

② Select the setting value with ▲/▼ of the multi selector, and press the center of the multi-selector.

7 Select [NEXT] → **OK** with ▼ of the multi-selector, then press the center of the multi-selector.

The clock starts.

#### ⚡ Notes

- The date and time do not appear during recording, but they are automatically recorded on the recording media, and can be displayed during playback. To display the date and time, select **MENU** (MENU) → [Show others] → [PLAYBACK SET] (under [PLAYBACK] category) → [DATA CODE] → [DATE/TIME] → **OK** → → **X**.
- You can turn off the operation beeps by selecting **MENU** (MENU) → [Show others] → [SOUND/DISP SET] (under [GENERAL SET] category) → [BEEP] → [OFF] → **OK** → → **X**.

#### To turn off the power

Close the LCD screen. The POWER lamp flashes for a few seconds and the power is turned off.

## Using the Multi-selector

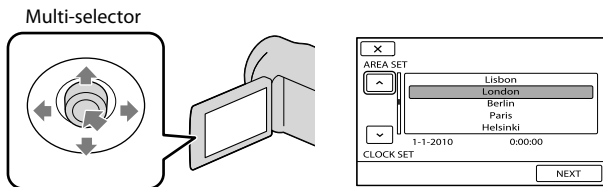

**1** Turn the desired button on a light with ▼/▲/◀/▶ of the multi-selector.

**2** Press the center of the multi-selector to confirm your selection.

## Changing the language setting

You can change the on-screen displays to show messages in a specified language.

Select **MENU** (MENU) → [Show others] → [CLOCK/🗓️/LANG] (under 🖱️ [GENERAL SET] category) → [🗓️/LANGUAGE SET] → a desired language → **OK** → 🔄 → **X**.



## Step 3: Preparing the recording media

The recording media that can be used differs depending on your camcorder. The following icons are displayed on the screen of your camcorder.

DCR-SX15E/SX20E:



Memory card

DCR-SR15E/SR20E:



Internal hard disk



Memory card

\* In the default setting, both movies and photos are recorded on this recording media. You can perform recording, playback and editing operations on the selected medium.

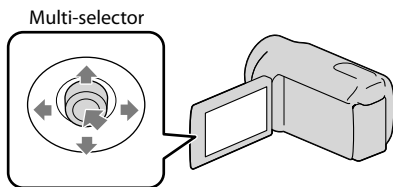

- Select with  $\blacktriangledown/\blacktriangle/\blacktriangleleft/\blacktriangleright$  and press the button in the center of the multi-selector to confirm your selection.

### Tips

- See page 79 for the recordable time of movies.
- See page 80 for the number of recordable photos.

### Selecting the recording media for movies (DCR-SR15E/SR20E)

- 1 Select **MENU** (MENU) → [Show others] → [MEDIA SETTINGS] (under [MANAGE MEDIA] category) → [MOVIE MEDIA SET].

The [MOVIE MEDIA SET] screen appears.

- 2 Select the desired recording media.

- 3 Select [YES] → **OK**.

The recording medium is changed.

## Selecting the recording media for photos (DCR-SR15E/SR20E)

- 1 Select **MENU** (MENU) → [Show others] → [MEDIA SETTINGS] (under  [MANAGE MEDIA] category) → [PHOTO MEDIA SET].

The [PHOTO MEDIA SET] screen appears.

- 2 Select the desired recording media.

- 3 Select [YES] → **OK**.

The recording medium is changed.

### To check the recording media settings

When recording in movie recording mode or photo recording mode, the recording media icon is displayed in the top right corner of the screen.

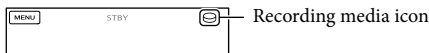

- The icon displayed on the LCD screen varies depending on the camcorder you use.

## Inserting a memory card

### Notes

- Set the recording medium to [MEMORY CARD] to record movies and/or photos on memory card (DCR-SR15E/SR20E).

### Types of memory card that can be used with your camcorder

- Only “Memory Stick PRO Duo” media, “Memory Stick PRO-HG Duo” media, SD memory cards (Class 2 or faster), SDHC memory cards (Class 2 or faster) and SDXC memory cards (Class 2 or faster) can be used with this camcorder. Operation with all memory cards is not assured.
- “Memory Stick PRO Duo” media of up to 32 GB and SD memory cards of up to 64 GB have been tested and proven to operate with your camcorder.
- For recording movies on “Memory Stick PRO Duo” media, it is recommended that you use “Memory Stick PRO Duo” media of 512 MB or larger.
- In this manual, “Memory Stick PRO Duo” media and “Memory Stick PRO-HG Duo” media are called “Memory Stick PRO Duo” media and SD memory cards, SDHC memory cards and SDXC memory cards are called SD memory cards.

### Notes

- MultiMediaCard cannot be used.
- Images recorded on SDXC memory cards cannot be played back or imported on non-exFAT\*-compatible computers, AV components, etc., connected to this camcorder by USB cable. Check that the connected devices are compatible with exFAT beforehand. If you connect a device that is not compatible with exFAT, the screen for initialization may appear. Never execute initialization, otherwise all recorded contents will be lost.

\* exFAT is the file system used in SDXC memory cards.

## Size of memory cards that can be used with your camcorder

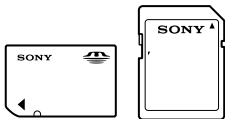

- Only “Memory Stick Duo” media that is about a half the size of the standard “Memory Stick” media, and standard-sized SD memory cards can be used.
- Do not attach a label, etc., to a memory card or memory card adaptor. Doing so may cause a malfunction.

Open the cover, orient the memory card’s notched corner as shown in the illustration, and insert into the memory card slot until it clicks.

- Close the cover after inserting the memory card.

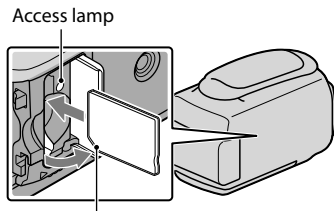

Note direction of notched corner.

The [Create a new Image Database File.] screen may appear if you insert a new memory card. In that case, select [YES]. If you record only photos on the memory card, select [NO].

- Confirm the direction of the memory card. If you forcibly insert the memory card in the wrong direction, the memory card, memory card slot, or image data may be damaged.

### ⚡ Notes

- If [Failed to create a new Image Database File. It may be possible that there is not enough free space.] is displayed, initialize the memory card by selecting **MENU** (MENU) → [Show others] → [MEDIA FORMAT] (under **MANAGE MEDIA** category) → [MEMORY CARD] (DCR-SR15E/SR20E) → [YES] → [YES] → **OK**.

### To eject the memory card

Open the cover and lightly push the memory card in once.

- Do not open the cover during recording.
- When inserting or ejecting the memory card, be careful so that the memory card does not pop out and drop.

# Recording

In the default setting, movies are recorded on the following recording media.

DCR-SX15E/SX20E: Memory card

DCR-SR15E/SR20E: Internal hard disk

 Tips

- See page 17 on changing the recording media (DCR-SR15E/SR20E).

## To open the lens cover

Slide the LENS COVER switch to open.

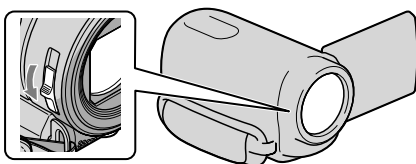

 Tips

- When you finish recording or when you play back images, close the lens cover.

## 1 Fasten the grip belt.

DCR-SR15E/SR20E

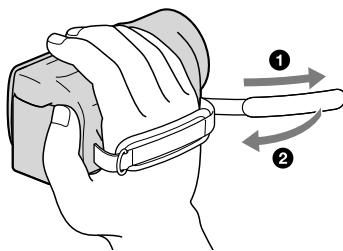

DCR-SX15E/SX20E

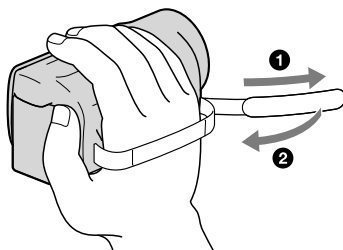

## 2 Open the LCD screen of your camcorder.

Your camcorder turns on.

- You can switch recording modes by pressing MODE. Press MODE until the desired mode icon appears.

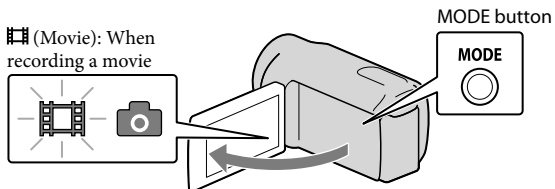

### Recording movies

Press START/STOP to start recording.

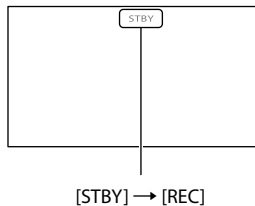
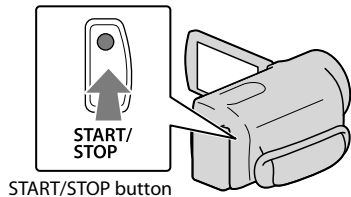

To stop recording, press START/STOP again.

- The icons and indicators on the LCD panel will be displayed for about 3 seconds, then disappear after turning on your camcorder or switching the recording (movie/photo)/playback modes. To display the icons and indicators again, press the multi-selector.

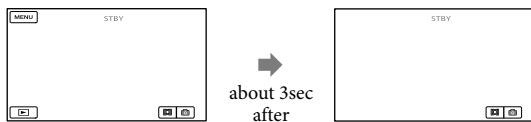

### ⚡ Notes

- If you close the LCD screen while recording movies, the camcorder stops recording.
- The maximum continuous recordable time of movies is about 13 hours.
- When a movie file exceeds 2 GB, the next movie file is created automatically.
- It will take several seconds until you can start recording after you turn on the camcorder. You cannot operate your camcorder during this time.
- The following states will be indicated if data is still being written onto the recording media after recording has finished. During this time, do not apply shock or vibration to the camcorder, or remove the battery or AC Adaptor.
  - Access lamp (p. 19) is lit or flashing
  - The media icon in the upper right of the LCD screen is flashing

### 💡 Tips

- When a face is detected, a white frame appears and the image quality around the face is optimized automatically ([FACE DETECTION], p. 61).
- You can capture photos from recorded movies (DCR-SR15E/SR20E/SX20E) (p. 39).
- See page 79 on the recordable time of movies.
- You can check the recordable time, estimated remaining capacity, etc., by selecting **MENU** (MENU) → [Show others] → [MEDIA INFO] (under [MANAGE MEDIA] category).
- The LCD screen of your camcorder can display recording images across the entire screen (full pixel display). However, this may cause slight trimming of the top, bottom, right and left edges of images when played back on a TV which is not compatible with full pixel display. In this case, set [GUIDEFRAAME] to [ON] (p. 61), and record images using the outer frame displayed on the screen as a guide.
- [STEADYSHOT] is set to [ON] in the default setting.
- To adjust the angle of the LCD panel, first open the LCD panel 90 degrees to the camcorder (①), and then adjust the angle (②).

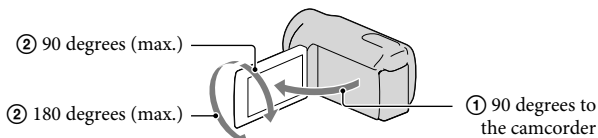

## Data code during recording

The recording date, time and condition are recorded automatically on the recording media. They are not displayed during recording. However, you can check them as [DATA CODE] during playback. To display them, select **MENU** (MENU) → [Show others] → [PLAYBACK SET] (under **▶** [PLAYBACK] category) → a desired setting → **OK** → **↶** → **✕**.

## Shooting photos

In the default setting, photos are recorded on the following recording media.

DCR-SX15E/SX20E: Memory card

DCR-SR15E/SR20E: Internal hard disk

### Tips

- See page 17 on changing the recording media (DCR-SR15E/SR20E).

### 1 Press **MODE** until the (Photo) icon appears.

The LCD screen display switches for photo recording mode, and the screen aspect ratio becomes 4:3.

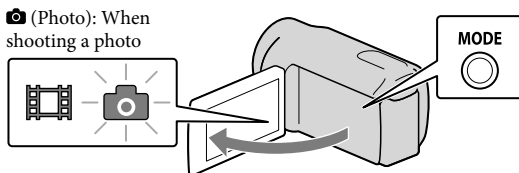

---

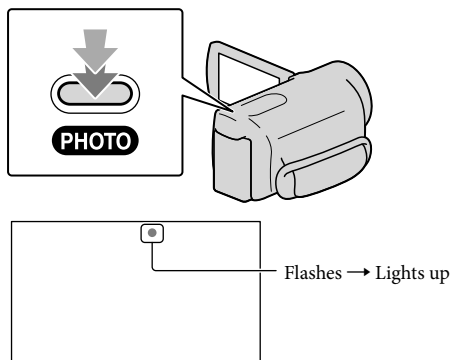

**2** Press PHOTO lightly to adjust the focus, then press it fully.



When  disappears, the photo is recorded.

---

 **Tips**

- See page 80 on the recordable number of photos.
- To change the image size, select **MENU** (MENU) → [Show others] → [ IMAGE SIZE] (under  [PHOTO SETTINGS] category) → a desired setting → **OK** → **X**.



# Useful functions for recording movies and photos

## Zooming

You can magnify images up to 50 times the original size with the power zoom lever.

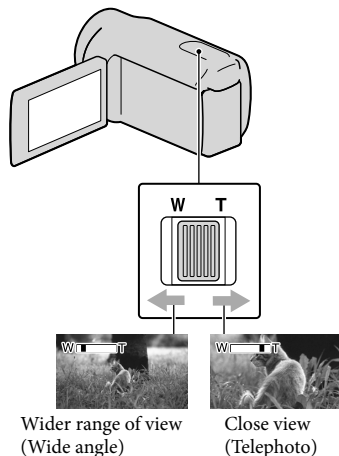

Move the power zoom lever slightly for a slower zoom. Move it further for a faster zoom.

### Notes

- SteadyShot may not reduce image blurring as desired when the power zoom lever is set to the T (Telephoto) side.
- Be sure to keep your finger on the power zoom lever. If you move your finger off the power zoom lever, the operation sound of the power zoom lever may also be recorded.
- The minimum possible distance between camcorder and subject while maintaining sharp focus is about 1 cm (about 13/32 in.) for wide angle and about 150 cm (about 59 1/8 in.) for telephoto.

### Tips

- You can set [DIGITAL ZOOM] (p. 62) if you want to zoom to a greater level.

## Selecting the recording mode

You can select a recording mode to record movies from 3 levels. The recording time of the media may change, depending on the recording mode. In the default setting, [REC MODE] is set to [SP].

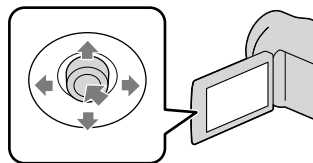

- 1 Select **MENU** (MENU) → [Show others] → [REC MODE] (under [SHOOTING SET] category).

- 2 Select a desired setting.

If you want to record high quality images, select the HQ mode, or if you want to record longer movies, select the LP mode.

- 3 Select **OK** → **X**.

### Notes

- Movies are recorded with MPEG-2 format.
- You can select from the following image qualities. Value such as "9M" is an average bitrate, and "M" means "Mbps."
  - [HQ] (9M (HQ))
  - [SP] (6M (SP)) (the default setting)
  - [LP] (3M (LP))

- If you record in the LP mode, the quality of movies may be degraded, or scenes with quick movements may appear with block noise when you play back the image.

**Tips**

- You can select the [  REC MODE ] for each recording media separately (DCR-SR15E/SR20E).

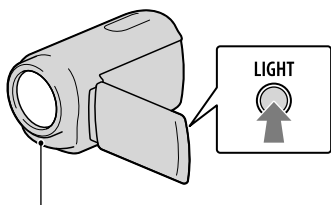

### Using the VIDEO LIGHT

You can use the VIDEO LIGHT according to the recording conditions. It is recommended that you use the VIDEO LIGHT at a distance of about 30 cm to 150 cm (11 7/8 in. to 59 1/8 in.) from the subject.





LED VIDEO LIGHT

Each time you press LIGHT, the indicator changes as follows.

No indicator (Off) →  AUTO (Auto) →  (On) → ...



Press LIGHT repeatedly to cancel the VIDEO LIGHT.

**Notes**

- The VIDEO LIGHT generates strong light. Do not use the VIDEO LIGHT directly in front of the eyes at close range.
- The length of time you can use the battery pack is shorter when you use the VIDEO LIGHT.
- When you record movies with the VIDEO LIGHT set to  AUTO, the video light may turn on and off. In this case, press LIGHT repeatedly to select .

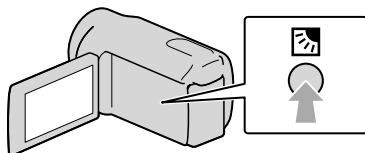
### Adjusting the exposure for backlit subjects



To adjust the exposure for backlit subjects, press  (backlight) to display . To cancel the back light function, press  (backlight) again.

### Recording in mirror mode

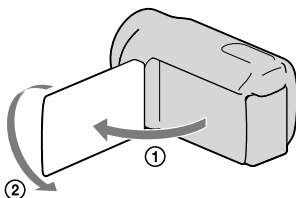

Open the LCD panel 90 degrees to the camcorder (①), then rotate it 180 degrees to the lens side (②).

**Tips**

- A mirror-image of the subject appears on the LCD screen, but the image will be normal when recorded.

# Playback on the camcorder

In the default setting, movies and photos that are recorded on the following recording media are played.

DCR-SX15E/SX20E: Memory card

DCR-SR15E/SR20E: Internal hard disk

## Tips

- See page 17 on changing the recording media (DCR-SR15E/SR20E).



1 Open the LCD screen of your camcorder.

Your camcorder turns on.

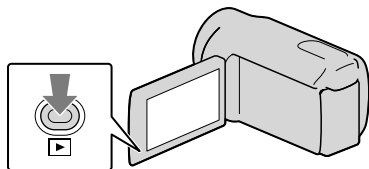
2 Press  (VIEW IMAGES).





The VISUAL INDEX screen appears after some seconds.

3 Select the  (Movie) (1) → a desired movie (2) to play back a movie.  
Select the  (Photo) (1) → a desired photo (2) to view a photo.

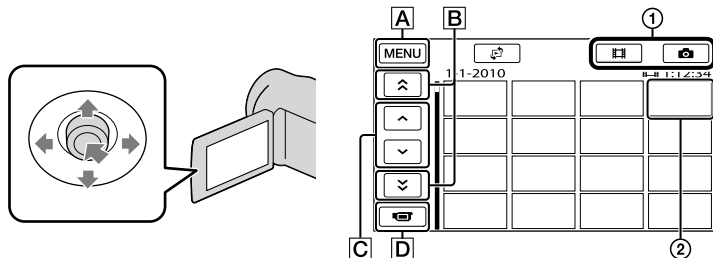
Movies are displayed and sorted by recording date.



**A** To MENU screen

**B**  /  : Displays movies recorded on the previous/next date.

**C**  /  : Displays the previous/next movie.

**D** Returns to the recording screen.

- **▶** appears with the movie or photo that was most recently played or recorded. If you select the movie or photo with **▶**, you can continue playback from the previous time. (**▶** appears on the photo recorded on a memory card.)

## Playing movies

Your camcorder starts playing the selected movie.

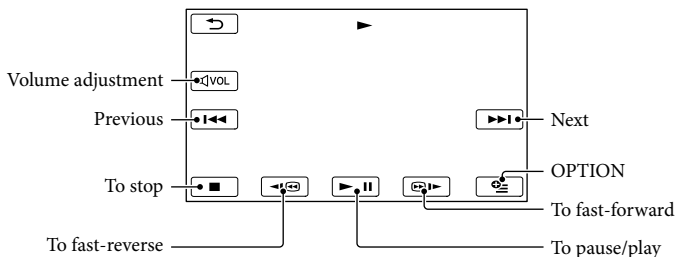

### Tips

- When playback from the selected movie reaches the last movie, the screen returns to the VISUAL INDEX screen.
- Select **◀|** / **|▶** during pause to play back movies slowly.
- As you repeat selecting **◀|** / **|▶** during playback, movies are played as fast as about 5 times → about 10 times → about 30 times → about 60 times.
- You can display the VISUAL INDEX by selecting **MENU** (MENU) → [Show others] → [VISUAL INDEX] (under **▶** [PLAYBACK] category).
- The recording date, time, and shooting conditions are recorded automatically during recording. This information is not displayed during recording, but you can display it during playback by selecting **MENU** (MENU) → [Show others] → [PLAYBACK SET] (under **▶** [PLAYBACK] category) → [DATA CODE] → a desired setting → **OK** → **↶** → **✕**.

## To adjust the sound volume of movies

While playing back movies, select **VOL** → adjust with **◀|** / **|▶** → **↶**.

- You can also adjust the sound volume by using **-** / **+** in the OPTION MENU.

## Viewing photos

Your camcorder displays the selected photo.

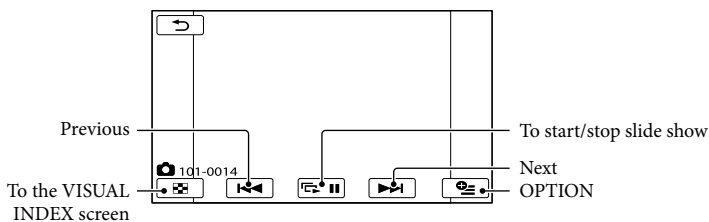

### Tips

- When viewing photos recorded on a memory card, **101** (playback folder) appears on the screen.

# Useful functions for playing movies and photos

## Searching for desired images by date (Date Index)

You can search for desired images by date efficiently.

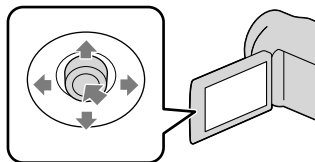

### Notes

- You cannot use the Date Index function for photos on the memory card.

1 Press **VIEW IMAGES**.

The VISUAL INDEX screen appears.

2 Select **DATE INDEX**.

Returns to the VISUAL INDEX screen

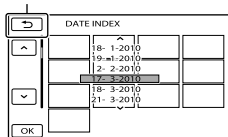

3 Select **UP**/**DOWN** to select the date of the desired image, then select **OK**.

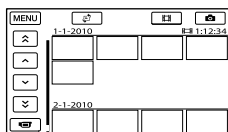

The images of the selected date are displayed on the VISUAL INDEX screen.

### Tips

- You can also display Date Index by selecting **MENU** (MENU) → [Show others] → [VIEW IMAGES] (under **PLAYBACK** category) → [DATE INDEX].
- On the [Film Roll Index]/[Face Index] screen, you can display the Date Index by selecting the date in the upper right corner of the screen.

## Searching for desired scene by pinpoint (Film Roll Index)

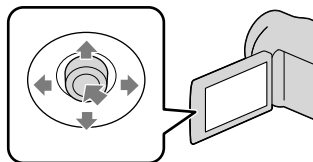

Movies can be divided by a set time and the first scene of each division is displayed on the INDEX screen. You can start playing back a movie from the selected thumbnail.



1 Press **VIEW IMAGES**.

The VISUAL INDEX screen appears.

---

**2** Select  → [ FILM ROLL].

Returns to the VISUAL INDEX screen

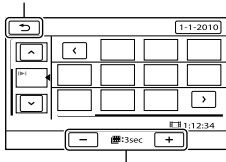



Sets the interval at which to create thumbnails of scenes in a movie.

---



**3** Select / to select the desired movie.

---

**4** Select / to search for the desired scene, then select the scene you want to play back.

Playback starts from the selected scene.

 **Tips**

- You can also display the Film Roll Index by selecting **MENU** (MENU) → [Show others] → [VIEW IMAGES] (under  [PLAYBACK] category) → [ FILM ROLL].

**Searching for desired scene by face (Face Index)**

The face images detected during movie recording are displayed on the INDEX screen.

You can play back the movie from the selected face image.

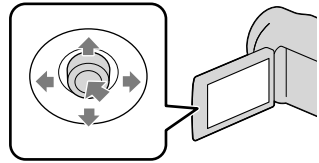



---

**1** Press  (VIEW IMAGES).

The VISUAL INDEX screen appears.

---

**2** Select  → [ FACE].

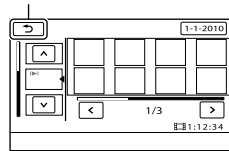

Returns to the VISUAL INDEX screen



---

**3** Select / to select the desired movie.

---

**4** Select / to search for the desired face image, then select the desired face image to view the scene.

Playback starts from the beginning of the scene with the selected face image.



---

 **Notes**

- Faces may not be detected depending on recording conditions.  
Example: People wearing glasses or hats, or who do not face towards the camera.

- Make sure that you set [FACE DETECTION] to [ON] (p. 61) (the default setting) prior to recording, to search movies on the Face Index.

#### Tips

- You can also display the Face Index by selecting **MENU** (MENU) → [Show others] → [VIEW IMAGES] (under  [PLAYBACK] category) → []FACE].

## Playing back a series of photos (Slide show)

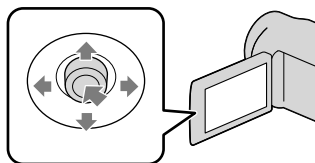

Select  on the photo playback screen.

The slide show begins from the selected photo.

---



### To stop the slide show

Select .

### To restart the slide show

Select  again.

#### Tips

- You can set continuous slide show playback by selecting  (OPTION) →  tab → [SLIDE SHOW SET] while playing photos. The default setting is [ON] (continuous playback).



# Playing images on a TV

Connect your camcorder to the input jack of a TV or VCR using the A/V connecting cable (supplied). Connect your camcorder to the wall outlet (wall socket) using the supplied AC Adaptor for this operation (p. 13). Refer also to the instruction manuals supplied with the devices to be connected.

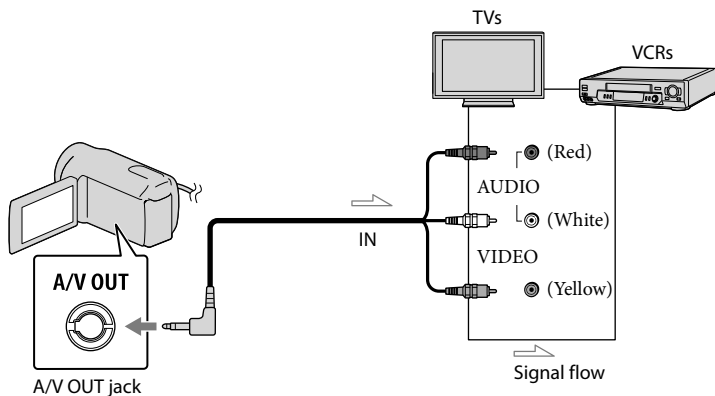

- 1** Set the input selector of the TV to the input your camcorder will be connected to.

For details, refer to the instruction manuals supplied with the TV.

- 2** Connect your camcorder to a TV with the A/V connecting cable (supplied).  
Connect your camcorder to the input jack of the TV.

- 3** Play back movies and photos on your camcorder (p. 27).

To set the aspect ratio according to the connected TV (16:9/4:3)

Select **MENU** (MENU) → [Show others] → [OUTPUT SETTINGS] (under [GENERAL SET] category) → [TV TYPE] → [16:9] or [4:3] → **OK** → → **X**.

When connecting to your TV via a VCR

Connect your camcorder to the LINE IN input on the VCR using the A/V connecting cable. Set the input selector on the VCR to LINE (VIDEO 1, VIDEO 2, etc.).

When your TV is monaural (When your TV has only one audio input jack)

Connect the yellow plug of the A/V connecting cable to the video input jack and connect the white (left channel) or red (right channel) plug to the audio input jack of your TV or VCR.

If your TV/VCR has a 21-pin adaptor (EUROCONNECTOR)

Use a 21-pin adaptor (sold separately) to view playback pictures.

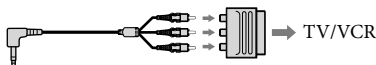

#### Notes

- When you set [TV TYPE] to [4:3], the image quality may deteriorate. Also, when the recorded image's aspect ratio switches between 16:9 (wide) and 4:3, the image may jitter.
- On some 4:3 TVs, the photos recorded in 4:3 aspect ratio may not be displayed full screen. This is not a malfunction.



- When you play back an image recorded in 16:9 (wide) aspect ratio on a 4:3 TV not compatible with the 16:9 (wide) signal, set [TV TYPE] to [4:3].

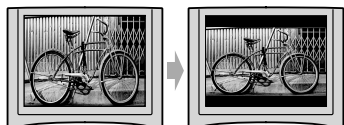

#### Tips

- To check information (counter, etc.) on the screen of the monitor, select **MENU** (MENU) → [Show others] → [OUTPUT SETTINGS] (under [GENERAL SET] category) → [DISP OUTPUT] → [V-OUT/PANEL] → **OK** → **↶** → **✕**.

## Deleting movies and photos

You can free media space by deleting movies and photos from recording media.

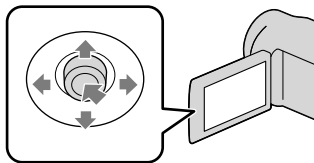

### Notes

- You cannot restore images once they are deleted. Save important movies and photos in advance.
- Do not remove the battery pack or the AC Adaptor from your camcorder while deleting the images. It may damage the recording media.
- Do not eject memory card while deleting images from the memory card.
- You cannot delete protected movies and photos. Undo the protection of the movies and photos to delete them, before you try to delete them (p. 37).
- If the deleted movie is included in the Playlist (p. 43), the movie added to the Playlist is deleted also from the Playlist.

### Tips

- You can delete an image on the playback screen from OPTION MENU.
- To delete all images recorded in the recording media, and recover all the recordable space of the media, format the media (p. 66).
- Reduced-size images which enable you to view many images at the same time on an index screen are called “thumbnails.”

1 Select **MENU** (MENU) → [Show others] → [DELETE] (under [EDIT] category).

2 To delete movies, select [DELETE] → [DELETE].

- To delete photos, select [DELETE] → [DELETE].

3 Select and display the ✓ mark on the movies or photos to be deleted.

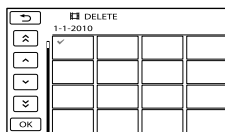

- Press LIGHT (p. 26) when a thumbnail is selected to confirm the image. Select to return to the previous screen.

4 Select **OK** → [YES] → **OK** → **X**.

To delete all movies/photos at one time





In step 2, select [DELETE] → [DELETE ALL] → [YES] → [YES] → **OK** → **X**.

- To delete all photos at one time, select [DELETE] → [DELETE ALL] → [YES] → [YES] → **OK** → **X**.





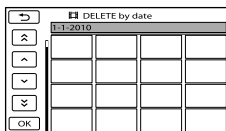

To delete all the movies/photos recorded on the same day at one time

### Notes

- You cannot delete photos on memory card by recording date.

- ① In step 2, select [  DELETE ] → [  DELETE by date ].
- To delete all photos on the same day at one time, select [  DELETE ] → [  DELETE by date ].



- ② Select  /  to select the recording date of the desired movies/photos, then select  .
- Press LIGHT (p. 26) when thumbnail is selected to confirm the image. Select  to return to the previous screen.
- ③ Select [ YES ] →  →  .

# Protecting recorded movies and photos (Protect)

Protect movies and photos to avoid deleting them by mistake.

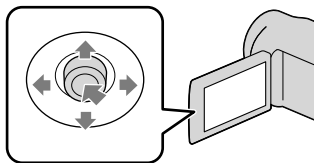

## Tips

- You can protect movies and photos on the playback screen from **OPTION MENU**.

1 Select **MENU** (MENU) → [Show others] → [PROTECT] (under [EDIT] category).

2 To protect movies, select [PROTECT] → [PROTECT].

- To protect photos, select [PROTECT] → [PROTECT].

3 Select the movies and photos to be protected.

is displayed on the selected images.

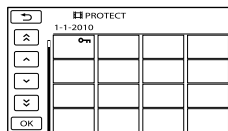

- Press LIGHT (p. 26) when thumbnail is selected to confirm the image. Select to return to the previous screen.

4 Select **OK** → [YES] → **OK** → **X**.

To undo the protection of movies and photos

Select the movie or photo marked with in step 3.

disappears.

To protect all the movies and photos recorded on the same day at one time

## Note

- You cannot select [PRT. by date] for the recorded data on the memory card.

① In step 2, select [PROTECT] → [PRT. by date].

- To protect all photos on the same day at one time, select [PROTECT] → [PRT. by date].

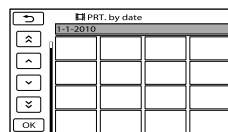

② Select / to select the recording date of the desired movies/photos, then select **OK**.

- Press LIGHT (p. 26) when thumbnail is selected to confirm the image. Select to return to the previous screen.

③ Select [PROTECT] → **OK** → **X**.

To undo the protection of movies and photos recorded on the same day at one time

In step ② above, select the recording date of the desired movies/photos, then select **OK** → [UNPROTECT] → **OK** → **X**.

# Dividing a movie

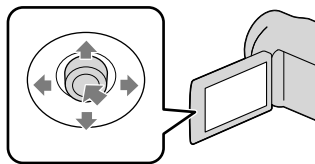

1 Select **MENU** (MENU) → [Show others] → [DIVIDE] (under [EDIT] category).

2 Select the movie to be divided.  
The selected movie starts playback.

3 Select **▶||** at the point where you want to divide the movie into scenes.

The movie pauses. Play and pause toggles as you press **▶||**.

Adjusts the dividing point with more precision after you selected the dividing point with **▶||**.

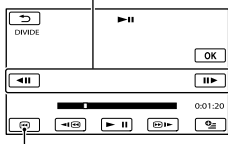

Returns to the beginning of the selected movie

4 Select **OK** → [YES] → **OK**.

## Notes

- You cannot restore movies once they are divided.
- You cannot divide the protected movie. Remove the protection to divide (p. 37).
- Do not remove the battery pack or the AC Adaptor from your camcorder while dividing the movie. It may damage the recording media. Also, do not eject the memory card while dividing movies on the memory card.
- A slight difference may occur from the point where you select **▶||** and the actual dividing point, as your camcorder selects the dividing point based on about half-second increments.
- If you divide the original movie, the movie added to the Playlist will also be divided.
- Only simple editing is available on the camcorder. Use the supplied software "PMB" for more advanced editing.

## Tips

- You can divide a movie on the playback screen from **OPTION MENU**.

# Capturing a photo from a movie (DCR-SR15E/SR20E/SX20E)

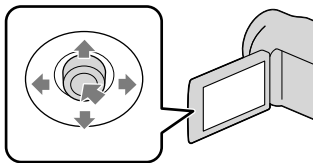

- 1 Select **MENU** (MENU) → [Show others] → [PHOTO CAPTURE] (under **[EDIT]** category).  
The [PHOTO CAPTURE] screen appears.

- 2 Select the movie to be captured.  
The selected movie starts playback.

- 3 Select **[▶ II]** at the point where you want to capture.  
The movie pauses. Play and pause toggles as you select **[▶ II]**.

Adjust the capturing point with more precision after you selected the point with **[▶ II]**.

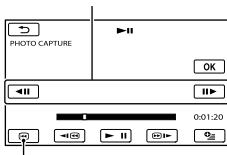

Returns to the beginning of the selected movie

- 4 Select **[OK]**.

When capturing is finished, the screen returns to pause.

- The captured photo is saved on the recording media selected in [PHOTO MEDIA SET] (DCR-SR15E/SR20E) (p. 18).
- To continue capturing, select **[▶ II]**, then repeat steps from step 3.
- To capture a photo from another movie, select **[↶]**, then repeat steps from step 2.

- 5 Select **[↶]** → **[X]**.

## ⚙ Notes

- The image size is fixed depending on the aspect ratio of the movie:
  - [0.2M] in 16:9 (wide)
  - [VGA(0.3M)] in 4:3
- The recording medium where you want to save photos should have enough free space.
- The recording date and time of captured photos is the same as the recording date and time of the movies.
- If the movie you are capturing from has no data code, the recording date and time of the photo will be the date and time you captured from the movie.
- You cannot capture a photo from a movie recorded on memory card (DCR-SR15E).

# Dubbing/copying movies and photos from the internal recording media to memory card (DCR-SR15E/SR20E)

## Dubbing movies

You can dub movies recorded on the internal recording media of your camcorder to memory card.

Insert memory card into your camcorder before the operation.

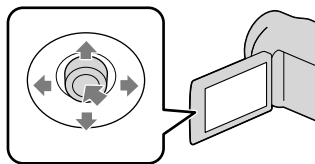

### Notes

- When you record a movie on the memory card for the first time, create the image database file by selecting **MENU** (MENU) → [Show others] → [REPAIR IMG.DB F.] (under [MANAGE MEDIA] category) → [MEMORY CARD].
- Connect your camcorder to the wall outlet (wall socket) using the supplied AC Adaptor to prevent your camcorder from running out of power during dubbing.

### Tips

- The original movie will not be deleted after dubbing.
- All included images in a Playlist will be dubbed.
- The images recorded by this camcorder and stored onto the recording media are called "original."

- 1 Select **MENU** (MENU) → [Show others] → [MOVIE DUB] (under [EDIT] category).

The [MOVIE DUB] screen appears.

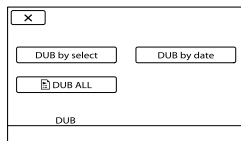

- 2 Select the type of dubbing.

[DUB by select]: To select movies and dub

[DUB by date]: To dub all movies of a specified date

[ DUB ALL]: To dub the Playlist

When you select the Playlist as the source of dubbing, follow the on-screen instructions to dub the Playlist.

- 3 Select the movie to be dubbed.

[DUB by select]: Select the movie to be dubbed, and mark it with . You can select multiple movies.

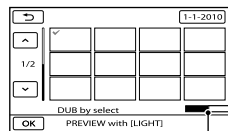

Remaining capacity of the memory card

- Press **LIGHT** (p. 26) when thumbnail is selected to confirm the image. Select to return to the previous screen.



[DUB by date]: Select the recording date of the movie to be dubbed, then select **OK**. You cannot select multiple dates.

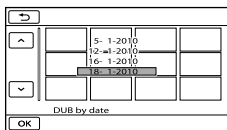

- 4 Select **OK** → [YES] → **OK**  
→ **X**.

#### Tips

- To check the dubbed movies after dubbing is finished, select [MEMORY CARD] on [MOVIE MEDIA SET] and play them back (p. 17).

## Copying photos

You can copy photos from the internal recording media of the camcorder to memory card.

Insert a memory card into your camcorder before the operation.

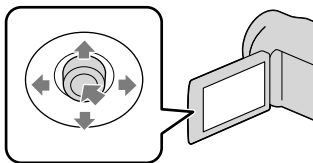

#### Notes

- Connect your camcorder to the wall outlet (wall socket) using the supplied AC Adaptor to prevent your camcorder from running out of power during copying.

- 1 Select **MENU** (MENU) → [Show others] → [PHOTO COPY] (under **EDIT** category).

The [PHOTO COPY] screen appears.

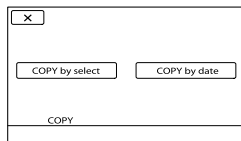

- 2 Select the type of copying.

[COPY by select]: To copy selected photos

[COPY by date]: To copy all photos of a specified date

- 3 Select the photo to be copied.

[COPY by select]: Select the photo to be copied, and mark with **✓**. You can select multiple photos.

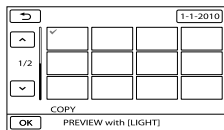

- Press LIGHT (p. 26) when thumbnail is selected to confirm the image. Select **↶** to return to the previous screen.

[COPY by date]: Select the recording date of the photo to be copied, then select **OK**. You cannot select multiple dates.

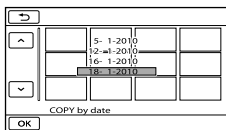

---

4 Select **OK** → [YES] → **OK**  
→ **X**.

---

#### Tips

- To check the copied photos after copying is finished, select [MEMORY CARD] on [PHOTO MEDIA SET] and play them back (p. 18).

# Using the Playlist of movies

The Playlist is a list showing thumbnails of the movies that you have selected.

The original movies are not changed even if you edit or erase the movies added to the Playlist.

## Creating the Playlist

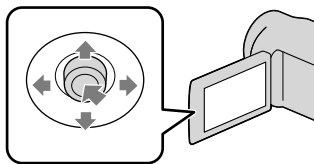

- 1 Select **MENU** (MENU) → [Show others] → [PLAYLIST EDIT] (under **[EDIT]** category).

- 2 Select **[ADD]**.

- 3 Select the movie to be added to the Playlist.

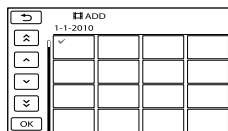

The selected movie is marked with ✓.

- Press **LIGHT** (p. 26) when thumbnail is selected to confirm the image. Select **[RETURN]** to return to the previous screen.

- 4 Select **OK** → [YES] → **OK** → **X**.

To add all the movies recorded on the same day at one time

- ① In step 2, select **[ADD by date]**.

The recording dates of movies are displayed on the screen.

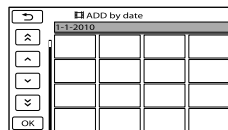

- ② Select **[UP]** / **[DOWN]** to select the recording date of the desired movie, then select **OK**.

- Select the image on the LCD screen to confirm the image. Select **[RETURN]** to return to the previous screen.

- ③ Select [YES] → **OK** → **X**.

- ④ Notes

- Do not remove the battery pack or the AC Adaptor from your camcorder while adding movies to the Playlist. It may damage the recording media. Also, do not eject the memory card while editing movies on the memory card.
- You cannot add photos to the Playlist.

- ⑤ Tips

- You can add a maximum of 99 movies to the Playlist.
- You can add a movie on the Playlist by selecting **[OPTION]**.

## Playing the Playlist

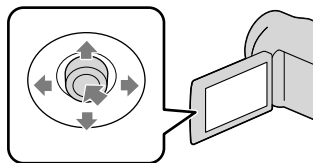

- 1 Select **MENU** (MENU) → [Show others] → [PLAYLIST] (under **[PLAYBACK]** category).

Movies added to the Playlist appear.

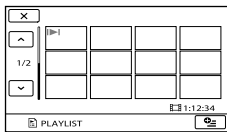

## 2 Select the movie you want to play back.

The Playlist is played back from the selected movie to the end, then the screen returns to the Playlist screen.

To erase unnecessary movies from the Playlist

① Select **MENU** (MENU) → [Show others] → [PLAYLIST EDIT] (under [EDIT] category).

② Select [ ERASE].

To erase all the movies from the Playlist, select [ ERASE ALL] → [YES] → [YES] → **OK** → **X**.

③ Select the movie to be erased from the list.

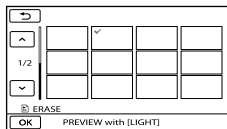

The selected movie is marked with .

• Press LIGHT (p. 26) when thumbnail is selected to confirm the image. Select to return to the previous screen.

④ Select **OK** → [YES] → **OK** → **X**.

### Tips

• Even if you erase a movie from a Playlist, the original movie is not deleted.

To change the order within the Playlist

① Select **MENU** (MENU) → [Show others] → [PLAYLIST EDIT] (under [EDIT] category).

② Select [ MOVE].

③ Select the movie to be moved.

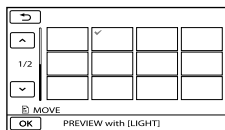

The selected movie is marked with .

• Select the image on the LCD screen to confirm the image. Select to return to the previous screen.

④ Select **OK**.

⑤ Select the destination with / .

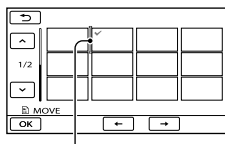

Destination bar

⑥ Select **OK** → [YES] → **OK** → **X**.

### Tips

• When you select multiple movies, the movies are moved following the order appearing in the Playlist.

## Saving images in external media (DIRECT COPY)

You can save movies and photos on external media (USB storage device), such as an external hard disk drive. You can also play back images on the camcorder or another playback device.

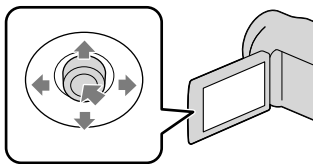

### Notes

- For this operation, you need the USB Adaptor Cable VMC-UAM1 (sold separately).
- The USB Adaptor Cable VMC-UAM1 may not be available in some countries/regions.
- You cannot use the following devices as an external media.
  - media with a capacity exceeding 2 TB
  - ordinary disc drive such as CD or DVD drive
  - media connected via USB hub
  - media with built-in USB hub
  - card reader
- You may not be able to use external media with a code function.
- FAT file system is available for your camcorder. If the external media was formatted to NTFS file system, etc., format the external media on your camcorder before use. The format screen appears when the external media is connected to your camcorder. The format screen may appear even in the case of media utilizing the FAT file system.
- Operation is not assured with every connectable device.
- Connect your camcorder to the wall outlet (wall socket) using the supplied AC adaptor (p. 13).
- Refer to the instruction manual supplied with the external media.
- Refer to the Sony support page for your country/region for details on external media that can be used.

### Tips

- You can also import images recorded on external media using the supplied software “PMB.”

- 1 Connect the AC Adaptor and the power cord (mains lead) to the DC IN jack of your camcorder and the wall outlet (wall socket).
- 2 If the external media has the AC power cable, connect it to the wall outlet (wall socket).
- 3 Connect the USB Adaptor Cable to the external media.
- 4 Connect the USB Adaptor Cable to the  $\Psi$  (USB) jack of your camcorder.

When the [Create a new Image Database File.] screen appears, select [YES].

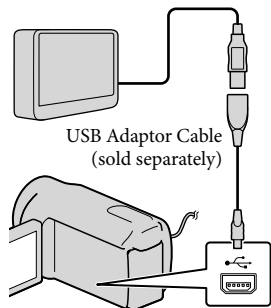

## 5 Select [Copy.] on the camcorder screen.

DCR-SR15E/SR20E:

Movies and photos in the internal recording media of the camcorder that have not yet been saved on to external media can be saved.

DCR-SX15E/SX20E:

Movies and photos that have not yet been saved on to external media can be saved.

- This screen will appear only when there are newly recorded images.

## 6 After the operation is completed, select **OK** on the camcorder screen.

### ⚡ Notes

- The number of scenes you can save on the external media are as follows.  
Movies: 9,999 movies  
Photos: 9,999 frames × 899 folders  
The number of scenes may be smaller depending on the type of images recorded.

### When connecting an external media

The images saved in the external media are displayed on the LCD screen. The movie display and photo display buttons on the VISUAL INDEX screen change as illustrated below.

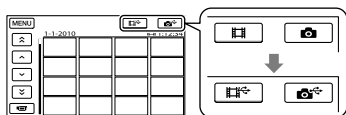

You can make menu settings of the external media such as deleting images. Select

**MENU** (MENU) → [Show others] on the VISUAL INDEX screen.

### To save desired movies and photos

You can also save images recorded on memory cards.

### ⚡ Notes

- You cannot search or copy photos recorded on memory card by recording date.

① Select [Play without copying.] in step 5 above.

The VISUAL INDEX screen of the external media is displayed.

② Select **MENU** (MENU) → [Show others] → [MOVIE DUB] (when selecting movies)/[PHOTO COPY] (when selecting photos).

③ Follow the on-screen instructions to select the recording media (DCR-SR15E/SR20E) and image selection methods.

④ When you selected [DUB by select], select the image to be saved.

✓ appears.

- When you selected [DUB by date], select the date of the images to be dubbed with **▲** / **▼**, then select **OK** and go to step ⑤.

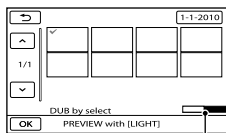

### Remaining external media capacity

- Press LIGHT (p. 26) when thumbnail is selected to confirm the image. Select **↶** to return to the previous screen.
- By selecting date, you can search for images by date.

⑤ Select **OK** → [YES] → **OK** on the camcorder screen.

## To play back images in the external media on the camcorder

- ① Select [Play without copying.] in step 5 above.

The VISUAL INDEX screen of the external media is displayed.

- ② Play back the image (p. 27).
  - You can also view images on a TV connected to your camcorder (p. 33).

### ⚡ Notes

- The Date Index of photos cannot be displayed.
- If your camcorder does not recognize the external media, try the following operations.
  - Reconnect the USB Adaptor Cable to your camcorder
  - If the external media has the AC power cable, connect it to the wall outlet (wall socket)

## To finish the external media connection

- ① Select  on the VISUAL INDEX screen of the external media.
- ② Disconnect the USB Adaptor Cable.

# Creating a disc with a DVD writer, recorder

## Creating a disc with the dedicated DVD writer, DVDirect Express

You can create a disc or play back the images on a created disc by using the dedicated DVD writer, DVDirect Express (sold separately).

Refer also to the instruction manual supplied with the DVD writer.

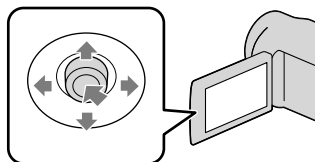

### Notes

- Connect your camcorder to the wall outlet (wall socket) using the supplied AC Adaptor for this operation (p. 13).
- Only unused discs of the following types can be used:
  - 12cm DVD-R
  - 12cm DVD+R
- The device does not support two-layered discs.
- DVDirect Express is referred to as “DVD writer” in this section.

- 1 Connect the AC Adaptor and the power cord (mains lead) to the DC IN jack of your camcorder and the wall outlet (wall socket) (p. 13).

- 2 Turn on your camcorder, and connect the DVD writer to the  $\Psi$  (USB) jack of your camcorder with the USB cable of the DVD writer.

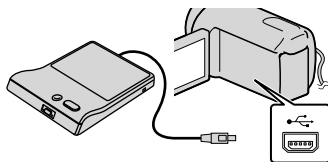

- 3 Insert an unused disc into the DVD writer, and close the disc tray.

The [DISC BURN] screen appears on the screen.

- 4 Press  $\odot$  (DISC BURN) on the DVD writer.

Movies recorded on internal recording media and not yet saved on any other discs will be recorded to the disc (DCR-SR15E/SR20E).

Movies not yet saved on any other discs will be recorded to the disc (DCR-SX15E/SX20E).

- 5 Repeat steps 3 and 4 when the total memory size of movies to be burnt exceeds that of the disc.

- 6 Select **OK**  $\rightarrow$  [END]  $\rightarrow$  [EJECT DISC] on the screen.

Remove the disc after the operation is completed.



- 
- 7 Select **OK** on the screen, then disconnect the USB cable.
- 

### To customize a disc with DISC BURN OPTION

Perform this operation in the following cases:

- When dubbing a desired image
- When creating multiple copies of the same disc
- When dubbing images in the memory card (DCR-SR15E/SR20E)

- 1 Select [DISC BURN OPTION] on the screen in step 4.
- 2 Select the recording media containing the movie(s) you want to save (DCR-SR15E/SR20E).
- 3 Select the movie you want to burn on the disc.  
✓ appears.

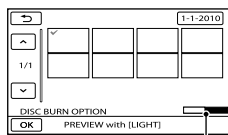

#### Remaining Disc capacity

- Press LIGHT (p. 26) when thumbnail is selected to confirm the image. Select **←** to return to the previous screen.
  - By selecting date, you can search for images by date.
- 4 Select **OK** → [YES] on the screen.
    - To create another disc of the same contents, insert a new disc and select [CREATE SAME DISC].
  - 5 After the operation is completed, select [EXIT] → [END] on the screen.
  - 6 Disconnect the USB cable from your camcorder.

### To play back a disc on the DVD writer

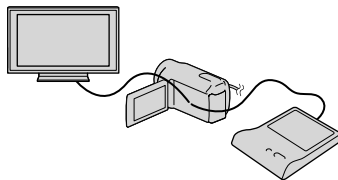

- 1 Connect the AC Adaptor and the power cord (mains lead) to the DC IN jack of your camcorder and the wall outlet (wall socket) (p. 13).
  - 2 Turn on your camcorder, and connect the DVD writer to the  $\Psi$  (USB) jack of your camcorder with the USB cable of the DVD writer.
    - You can play back movies on the TV screen by connecting the camcorder to a TV (p. 33).
  - 3 Insert a created disc into the DVD writer.

The movies on the disc appear as VISUAL INDEX on the screen.
  - 4 Press the play button on the DVD writer.
    - You can also operate by the screen.
  - 5 Select [END] → [EJECT DISC] on the screen and remove the disc after the operation is completed.
  - 6 Select **OK** and disconnect the USB cable.
- ⚡ Notes
- Do not do any of the following when creating a disc.
    - Turn off the camcorder
    - Disconnect the USB cable or the AC adaptor
    - Subject the camcorder to mechanical shock or vibration
    - Eject the memory card from the camcorder
  - Play the created disc to make sure dubbing was performed correctly before deleting the movies on your camcorder.

- If [Failed.] or [DISC BURN failed.] appears on the screen, insert another disc into the DVD writer and perform the DISC BURN operation again.

#### Tips

- If the total memory size of movies to be burnt by the DISC BURN operation exceeds that of the disc, disc creation stops when the limit is reached. The last movie on the disc may be cut off.
- Disc creation time to dub movies to the limit of the disc is about 20 minutes to 60 minutes. It may take more time depending on the recording mode or the number of scenes.
- If you cannot play back created discs on any DVD player, connect the camcorder to the DVD writer, and then play back.

### Creating a disc with a DVD writer, etc., other than DVDirect Express

You can save movies on a disc by connecting your camcorder to disc creation devices, such as a Sony DVD writer other than DVDirect Express, with the USB cable. Refer also to the instruction manuals supplied with the devices to be connected.

#### Notes

- Sony DVD writer may not be available in some countries/regions.
- Connect your camcorder to the wall outlet (wall socket) using the supplied AC Adaptor for this operation (p. 13).

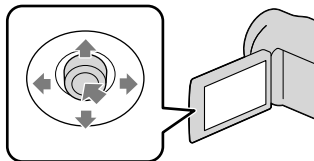

- 1 Connect the AC Adaptor and the power cord (mains lead) to the DC IN jack of your camcorder and the wall outlet (wall socket) (p. 13).

- 2 Turn on your camcorder, and connect a DVD writer, etc. to the  (USB) jack of your camcorder with the USB cable (supplied).

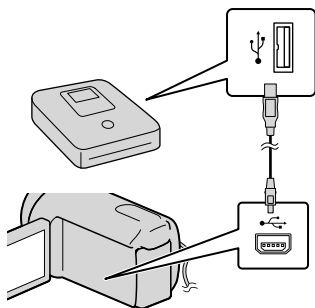

The [USB SELECT] screen appears on the camcorder screen.

- If the [USB SELECT] screen does not appear, select **MENU** (MENU) → [Show others] → [USB CONNECT] (under  [OTHERS] category).

- 3 Select the recording media that contains the images on the camcorder screen.

[ USB CONNECT]: Internal hard disk

[ USB CONNECT]: Memory card

- The displayed recording media differ depending on the model.

---

**4** Record movies on the connected device.

- For details, refer to the instruction manuals supplied with the device to be connected.

---

**5** After the operation is completed, select [END] → [YES] on the camcorder screen.

---

**6** Disconnect the USB cable.

---

**Creating a disc with a recorder, etc.**

You can dub images played back on your camcorder on a disc or video cassette, by connecting your camcorder to a disc recorder, a Sony DVD writer, etc., other than DVDirect Express, with the A/V connecting cable (supplied). Refer also to the instruction manuals supplied with the devices to be connected.

**Notes**

- Connect your camcorder to the wall outlet (wall socket) using the supplied AC Adaptor for this operation (p. 13).
- Sony DVD writer may not be available in some countries/regions.

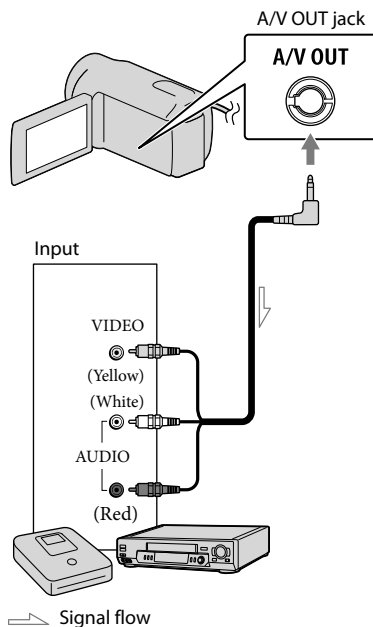

Signal flow

---

**1** Insert the recording media in the recording device.

- If your recording device has an input selector, set it to the input mode.

---

**2** Connect your camcorder to the recording device (a disc recorder, etc.) with the A/V connecting cable (supplied).

- Connect your camcorder to the input jacks of the recording device.

---

### 3 Start playback on your camcorder, and record it on the recording device.









- Refer to the instruction manuals supplied with your recording device for details.

---

### 4 When dubbing is finished, stop the recording device, and then your camcorder.

---

#### ⚡ Notes

- Since dubbing is performed via analog data transfer, the image quality may deteriorate.
- To hide the screen indicators (such as a counter, etc.) on the screen of the monitor device connected, select **MENU** (MENU) → [Show others] → [OUTPUT SETTINGS] (under  [GENERAL SET] category) → [DISP OUTPUT] → [LCD PANEL] (the default setting) → **OK** →  → **X**.
- To record the date/time or camera settings data, select **MENU** (MENU) → [Show others] → [PLAYBACK SET] (under  [PLAYBACK] category) → [DATA CODE] → a desired setting → **OK** →  → **X**. In addition, select **MENU** (MENU) → [Show others] → [OUTPUT SETTINGS] (under  [GENERAL SET] category) → [DISP OUTPUT] → [V-OUT/PANEL] → **OK** →  → **X**.
- When the screen size of display devices (TV, etc.) is 4:3, select **MENU** (MENU) → [Show others] → [OUTPUT SETTINGS] (under  [GENERAL SET] category) → [TV TYPE] → [4:3] → **OK** →  → **X**.
- When you connect a monaural device, connect the yellow plug of the A/V connecting cable to the video input jack, and the white (left channel) or the red (right channel) plug to the audio input jack on the device.

## Using menus

Using the menus, you can perform useful functions and change various settings. If you make good use of menu operations, you can enjoy using your camcorder.

The camcorder has various menu items under each of eight menu categories.

**M** **MANUAL SETTINGS** (Items to adjust for scene condition) → p. 58

**SHOOTING SET** (Items for customized shooting) → p. 61

**PHOTO SETTINGS** (Items for recording photos) → p. 63

**PLAYBACK** (Items for playback) → p. 64

**EDIT** (Items for editing) → p. 65

**OTHERS** (Items for other settings) → p. 65

**MANAGE MEDIA** (Items for recording media) → p. 66

**GENERAL SET** (Other setup items) → p. 67

### Operating menus

Multi-selector

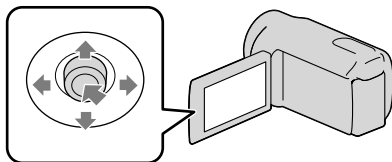

- Select with  $\blacktriangledown/\blacktriangle/\blacktriangleleft/\blacktriangleright$  and press the center of the multi-selector to confirm your selection.
- An orange frame appears on the selected item.

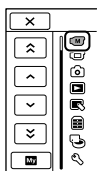
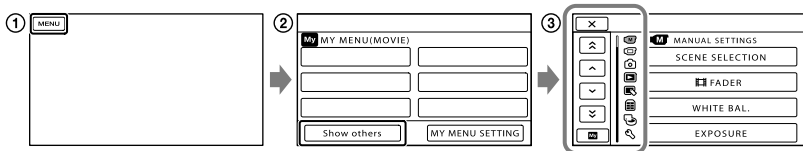

**X** : To finish setting the menu.

**↕** / **↔** : The menu list moves from category to category.

**↑** / **↓** : The menu list moves through 4 items at once.

**My** : To return to the MY MENU.

- ① Select **MENU**.
- ② Select [Show others] on the MY MENU screen.
  - See the next page for details on MY MENU.
- ③ Select the menu item to be changed.
- ④ After changing the setting, select **OK**.  
To finish setting the menu, select **X**.  
To return to the previous menu screen, select **→**.
  - **OK** may not be displayed depending on the menu item.

#### ⚡ Notes

- You may not be able to set some menu items, depending on the recording or playback conditions.
- Grayed out menu items or settings are not available.

#### 💡 Tips

- Depending on the menu items being changed, your camcorder switches between playback mode and recording mode (movie/photo).

## Using MY MENU

You can use the menu items more easily by registering the menu items you use most often on MY MENU. You can register 6 menu items on each MY MENU of the MOVIE, PHOTO, and PLAYBACK.

Example: deleting [FOCUS] and registering [FADER]

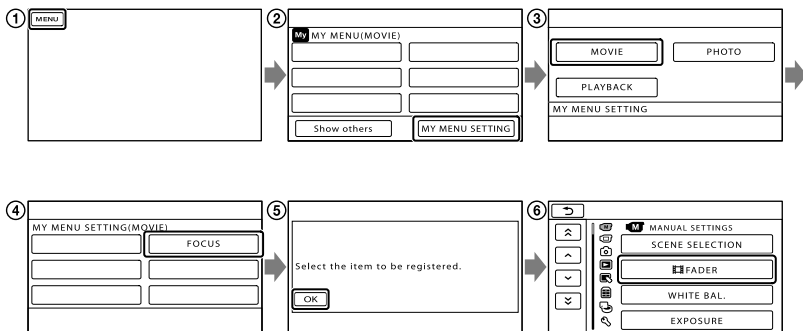



- ① Select **MENU**.
- ② Select [MY MENU SETTING].
- ③ Select [MOVIE].
- ④ Select [FOCUS].
- ⑤ Select **OK**.
- ⑥ Select [FADER] (under **M** [MANUAL SETTINGS] category).
- ⑦ When MY MENU is displayed, select **X**.

Repeat the same steps above to register menu items on MY MENU, and enjoy using your “Handycam.”



#### Tips

- When an external storage device is connected, the exclusive MY MENU appears.

## Using the OPTION MENU

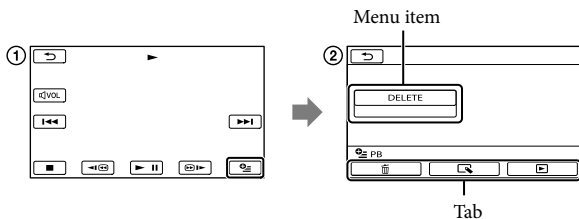
The OPTION MENU appears just like the pop-up window that appears when you right-click the mouse on a computer. When  is displayed at bottom-right of the screen, you can use the OPTION MENU. You select , and the menu items you can change in the context appear.



- ① Select  (OPTION).
- ② Select the desired tab → the item to change the setting.
- ③ After completing the setting, select .

#### Notes

- Grayed out menu items or settings are not available.
- When the item you want is not on the screen, select another tab. (There may be no tab.)
- The tabs and items that appear on the screen depend on the recording/playback status of your camcorder at the time.

# Menu lists



## (MANUAL SETTINGS) category

SCENE SELECTION	58
 FADER	58
WHITE BAL.	59
EXPOSURE	60
FOCUS	60
TELE MACRO	60



## (SHOOTING SET) category

 REC MODE	25
GUIDEFRAAME	61
 STEADYSHOT	61
AUTO SLW SHUTTR	61
FACE DETECTION	61
AUDIO REC SET	
BLT-IN ZOOM MIC	62
MICREF LEVEL	62
OTHER REC SET	
 DIGITAL ZOOM	62
 WIDE SELECT	62





## (PHOTO SETTINGS) category

 SELF-TIMER	63
 IMAGE SIZE	63
FILE NO.	63

## (PLAYBACK) category

VISUAL INDEX	27
VIEW IMAGES	
DATE INDEX	30
 FILM ROLL	30
 FACE	31
PLAYLIST	43
PLAYBACK SET	
DATA CODE	64

## (EDIT) category

DELETE	
 DELETE	35
 DELETE	35
PROTECT	
 PROTECT	37
 PROTECT	37

 DIVIDE	38
--	----

PHOTO CAPTURE*1 *2	39
--------------------	----

MOVIE DUB*1	
-------------	--

DUB by select	40
---------------	----

DUB by date	40
-------------	----

 DUB ALL	40
---	----

PHOTO COPY*1	
--------------	--

COPY by select	41
----------------	----

COPY by date	41
--------------	----

PLAYLIST EDIT	
---------------	--

 ADD	43
---	----

 ADD by date	43
---	----

 ERASE	44
---	----

 ERASE ALL	44
---	----

 MOVE	44
--	----

## (OTHERS) category

USB CONNECT	
-------------	--

 USB CONNECT*1	50
---	----

 USB CONNECT	50
---	----

DISC BURN	Operating Guide
-----------	-----------------

BATTERY INFO	65
--------------	----

## (MANAGE MEDIA) category

MEDIA SETTINGS*1	
------------------	--

MOVIE MEDIA SET	17
-----------------	----

PHOTO MEDIA SET	18
-----------------	----

MEDIA INFO	66
------------	----

MEDIA FORMAT	
--------------	--

HDD*1	66
-------	----

MEMORY CARD	66
-------------	----

REPAIR IMG.DB F.	
------------------	--

HDD*1	73, 76
-------	--------

MEMORY CARD	73, 76
-------------	--------

## (GENERAL SET) category

SOUND/DISP SET	
----------------	--

VOLUME	28, 67
--------	--------



BEEP	67
------	----

LCD BRIGHT	67
------------	----

LCD BL LEVEL	67
--------------	----

LCD COLOR	68
-----------	----



DISPLAY SET	68
OUTPUT SETTINGS	
TV TYPE	33
DISP OUTPUT	68
CLOCK/  LANG	
CLOCK SET	14
AREA SET	68
SUMMERTIME	68
 LANGUAGE SET	68
POWER SETTINGS	
A.SHUT OFF	68
OTHER SETTINGS	
DEMO MODE	69
DROP SENSOR*1	69

\*1 DCR-SR15E/SR20E

\*2 DCR-SX20E

# M MANUAL SETTINGS

## (Items to adjust for scene condition)

See “Using menus” (p. 53) on the operation. The default settings are marked with ▶.

### SCENE SELECTION



You can record images effectively in various situations.

#### ▶ AUTO

Records images in average image quality without the [SCENE SELECTION] function.

#### TWILIGHT\* (☾)

Maintains the darkening atmosphere of the distant surroundings in twilight scenes.



#### CANDLE (🕯)

Maintains the dim atmosphere of a candlelit scene.



#### SUNRISE&SUNSET\* (☀️)

Reproduces the atmosphere of scenes such as sunsets or sunrises.



#### FIREWORKS\* (💣)

Takes spectacular shots of fireworks.



#### LANDSCAPE\* (🏞)

Shoots distant subjects clearly. This setting also prevents your camcorder from focusing on glass or metal mesh in windows between the camcorder and the subject.



#### PORTRAIT (Soft portrait)



Brings out the subject such as people or flowers while creating a soft background.



#### SPOTLIGHT\*\* (🎤)

Prevents people's faces from appearing excessively white when subjects are lit by strong light.



#### SPORTS\*\* (⚽)

Select to minimize shake when shooting fast moving subjects.



#### BEACH\*\* (🏖)

Takes the vivid blue of the ocean or a lake.



#### SNOW\*\* (❄️)

Takes bright pictures of a white landscape.



\* Adjusted to focus on subjects farther away only.

\*\* Adjusted not to focus on subjects a short distance away.

#### 🔔 Notes

- If you set [SCENE SELECTION], [WHITE BAL.] setting is canceled.

### FADER



You can record a transition with the following effects adding to the interval between scenes.

Select the desired effect in [STBY] (to fading in) or [REC] (to fading out) mode.

#### ▶ OFF

Does not use an effect.

## WHITE FADER

Fades in/out with the white effect.



## BLACK FADER

Fades in/out with the black effect.



To cancel the fader before starting the operation, select [OFF].

### Tips

- When you press START/STOP, the setting is cleared.
- A movie recorded using [BLACK FADER] may be difficult to see in the VISUAL INDEX screen.

## WHITE BAL. (White balance)



You can adjust the color balance to the brightness of the recording environment.



### AUTO

The white balance is adjusted automatically.

### OUTDOOR (☀)

The white balance is appropriately adjusted for the following recording conditions:

- Outdoors
- Night views, neon signs and fireworks
- Sunrise or sunset
- Under daylight fluorescent lamps

### INDOOR (☾)

The white balance is appropriately adjusted for the following recording conditions:

- Indoors
- At party scenes or studios where the lighting conditions change quickly
- Under video lamps in a studio, or under sodium lamps or incandescent-like color lamps

### ONE PUSH (📄)

The white balance will be adjusted according to the ambient light.

- ① Select [ONE PUSH].
- ② Frame a white object such as a piece of paper, to fill the screen under the same lighting conditions as you will shoot the subject.
- ③ Select [📄].  
📄 flashes quickly. When the white balance has been adjusted and stored in the memory, the indicator stops flashing.

### Notes

- Set [WHITE BAL.] to [AUTO] or adjust the color in [ONE PUSH] under white or cool white fluorescent lamps.
- When you select [ONE PUSH], keep framing white objects while 📄 is flashing quickly.
- 📄 flashes slowly if [ONE PUSH] could not be set.
- When [ONE PUSH] was selected, if 📄 keeps flashing after selecting **OK**, set [WHITE BAL.] to [AUTO].
- If you set [WHITE BAL.], [SCENE SELECTION] is set to [AUTO].

### Tips

- If you have changed the battery pack while [AUTO] was selected, or taken your camcorder outdoors after inside use (or vice versa), aim your camcorder at a nearby white object for about 10 seconds for better color balance adjustment.
- When the white balance has been set with [ONE PUSH], if the lighting conditions changed by bringing your camcorder outdoors

from inside the house, or vice versa, you need to redo the [ONE PUSH] procedure to readjust the white balance.

## EXPOSURE



You can fix the brightness of a picture manually. Adjust the brightness when the subject is too bright or too dark.

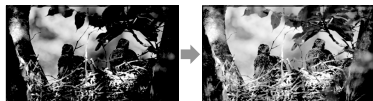

Select **-** / **+** to adjust the brightness. To adjust the exposure automatically, select [AUTO].

## FOCUS



You can adjust the focus manually. You can select this function also when you want to focus on a certain subject intentionally.



Select **☹** (nearby subject) / **☹** (distant subject) to adjust the focus.

To adjust the focus automatically, select [AUTO].

### ⚙ Notes

- When you set [FOCUS] to [MANUAL], **☹** appears.
- The minimum possible distance between camcorder and subject while maintaining sharp focus is about 1 cm (about 13/32 in.) for wide angle and about 150 cm (about 59 1/8 in.) for telephoto.

### 💡 Tips

- **☹** appears when the focus cannot be adjusted any closer, and **▲** appears when the focus

cannot be adjusted farther away.

- It is easier to focus on the subject by moving the power zoom lever towards T (telephoto) to adjust the focus, then towards W (wide angle) to adjust the zoom for recording. When you want to record a subject at close range, move the power zoom lever to W (wide angle), then adjust the focus.
- The focal distance information (distance at which the subject is focused on; used as a guide if it is dark and focus adjustment is difficult) appears for a few seconds in the following cases.
  - When the focus mode is switched from automatic to manual
  - When you set focus manually

## TELE MACRO



This is useful to shoot small subjects, such as flowers or insects. You can blur out backgrounds and the subject stands out clearer.

### ▶ OFF

Cancels TELE MACRO. (TELE MACRO is also canceled when you move the zoom lever to the W side.)

### ON (T)

The zoom (p. 25) moves to the top of the T (telephoto) side automatically and allows recording subjects at a close distance down to about 38 cm (15 in.).



### ⚙ Notes

- When recording a distant subject, focusing may be difficult and can take some time.
- Adjust the focus manually ([FOCUS], p. 60) when it is hard to focus automatically.

# SHOOTING SET

## (Items for customized shooting)

See “Using menus” (p. 53) on the operation. The default settings are marked with ►.

### REC MODE (Recording mode)

See page 25.

### GUIDEFAME

You can display the frame and check that the subject is horizontal or vertical. The frame is not recorded.

- OFF  
Does not display the guide frame.
- ON  
Displays the guide frame.



#### Tips

- Positioning the subject at the cross point of the guide frame makes a balanced composition.
- The outer frame of [GUIDEFAME] shows the display area of a TV which is not compatible with full pixel display.

### STEADYSHOT

You can compensate for camera shake. Set [STEADYSHOT] to [OFF] (👉) when using a tripod (sold separately), then the image becomes natural.

- ON  
The SteadyShot function is used.
- OFF (👉)  
The SteadyShot function is not used.

### AUTO SLW SHUTTR (Auto Slow Shutter)

When recording in dark places, the shutter speed is automatically reduced to 1/25 second.

- OFF  
The Auto Slow Shutter function is not used.
- ON  
The Auto Slow Shutter function is used.

### FACE DETECTION

Detects the faces of your subjects and adjusts the exposure automatically.

- ON  
Detects faces.
- OFF (👉)  
Does not detect faces.

#### Notes

- Faces may not be detected depending on recording conditions, subject conditions, and the setting of your camcorder.
- [FACE DETECTION] may not function properly depending on recording conditions. Set [FACE DETECTION] to [OFF] in this case.

#### Tips

- For better face detection performance, shoot the subject(s) under the following conditions:
  - Shoot in a sufficiently bright place
  - The subject(s) does not wear glasses, a hat or mask
  - The subject(s) faces directly towards the camera
- The detected faces are recorded in Face Index, however, some faces may not be. Also, there is a limit to the number of faces that can be recorded in Face Index. To play back from the Face Index, see page 31.



### ■ BLT-IN ZOOM MIC (Built-in zoom microphone)

You can record a movie with vivid sound appropriate to the zoom position.

#### ▶ OFF

The microphone does not record sound following zooming in or out.

#### ON (📶)

The microphone records sound following zooming in or out.

### ■ MICREF LEVEL (Microphone reference level)

You can select the microphone level for recording sound.

#### ▶ NORMAL

Records various ambient sounds, converting them into the appropriate level.

#### LOW (🔻)

Records ambient sound faithfully. Select [LOW] when you want to record an exciting and powerful sound in a concert hall, etc. (This setting is not suitable for recording conversations.)



### ■ DIGITAL ZOOM

You can select the maximum zoom level up to 50× in case you want to zoom to a level greater than following optical zoom during recording. Note that the image quality decreases when you use the digital zoom.



The right side of the bar shows the digital zooming factor. The zooming zone appears when you select the zooming level.

#### ▶ OFF

Up to 50× zoom is performed optically.

#### 1800×

Up to 50× zoom is performed optically, and after that, up to 1800× zoom is performed digitally.

### ■ WIDE SELECT

You can select the horizontal to vertical ratio according to the TV connected. Refer also to the instruction manuals supplied with your TV.

#### ▶ 16:9 WIDE

Records movies to the full screen on a 16:9 (wide) TV screen.

#### 4:3 (4:3)

Records movies to the full screen on a 4:3 TV screen.

### 🔔 Notes

- Set [TV TYPE] correctly according to the TV connected for playback (p. 68).

# PHOTO SETTINGS

(Items for recording photos)

See “Using menus” (p. 53) on the operation.  
The default settings are marked with ►.

## SELF-TIMER

Press PHOTO to start the count down. A photo is recorded after about 10 seconds.

### ► OFF

Cancels the self-timer.

### ON (🕒)

Starts the self-timer recording. To cancel the recording, select [RESET].

## IMAGE SIZE

You can select a photo size to be shot.

### ► VGA(0.3M) (📺)

Records photos in the 4:3 aspect ratio (640 × 480).

### 📺 0.2M (📺)

Records photos in the 16:9 (wide) aspect ratio (640 × 360).

### 🔔 Notes

- See page 80 for the number of recordable photos.

## FILE NO. (File number)

You can select the way to assign file number of photos.

### ► SERIES

Assigns file numbers of photos in sequence. The file number becomes larger each time you record a photo. Even if the memory card is replaced with another one, the file number is assigned in sequence.

### RESET

Assigns file numbers in sequence, following the largest file number existing on the recording medium.

When the memory card is replaced with another one, the file number is assigned for each memory card.

# PLAYBACK

## (Items for playback)

See “Using menus” (p. 53) on the operation.



See page 27.



### DATE INDEX

See page 30.

### FILM ROLL

See page 30.

### FACE

See page 31.



See page 43.



### DATA CODE

During playback, your camcorder displays the information (Date/time, Camera data) recorded automatically at the time of recording.

#### OFF

Data code is not displayed.

#### DATE/TIME

Displays the date and time.

#### CAMERA DATA

Displays camera setting data.

### DATE/TIME

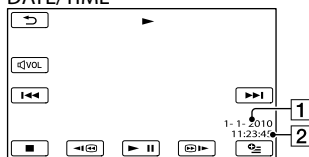

1 Date

2 Time

### CAMERA DATA

#### Movie

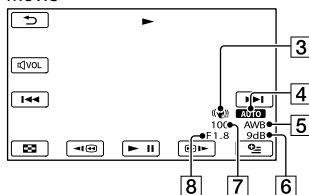

#### Photo

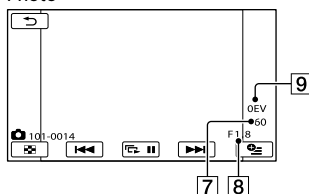

3 SteadyShot off

4 Brightness

5 White balance

6 Gain

7 Shutter speed

8 Aperture value

9 Exposure

#### Tips

- The data code is displayed on the TV screen if you connect your camcorder to a TV.
- Depending on the recording media condition, bars [---:---] appear.



## EDIT

(Items for editing)

See “Using menus” (p. 53) on the operation.

DELETE 

See page 35.

PROTECT 

See page 37.

 DIVIDE 

See page 38.

PHOTO CAPTURE (DCR-SR15E/  
SR20E/SX20E) 

See page 39.

MOVIE DUB (DCR-SR15E/  
SR20E) 

See page 40.

PHOTO COPY (DCR-SR15E/  
SR20E) 

See page 41.

PLAYLIST EDIT 

See page 43.

## OTHERS

(Items for other settings)

See “Using menus” (p. 53) on the operation.  
The default settings are marked with ►.

USB CONNECT 

See page 48.

BATTERY INFO 

You can check the estimated remaining capacity of the battery.

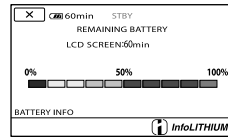

To close the battery information screen  
Select .

# MANAGE MEDIA

## (Items for recording media)

See “Using menus” (p. 53) on the operation.

### MEDIA SETTINGS (DCR-SR15E/ SR20E)

See page 17.

### MEDIA INFO

You can check the remaining recordable time for each recording mode of the recording media for movies and the approximate free and used media space of the recording media.

### To turn off the display

Select **✕**.

#### Notes

- Since there is a management file area, the used space is not displayed as 0 % even if you perform [MEDIA FORMAT] (p. 66).

#### Tips

- Only the information of the medium selected on [MOVIE MEDIA SET] (p. 17) is displayed. Change the medium setting if necessary (DCR-SR15E/SR20E).

### MEDIA FORMAT

Formatting deletes all the movies and photos to recover recordable free space.

Select [YES] → [YES] → **OK**.

DCR-SR15E/SR20E:

Select the recording media to be formatted.

#### Notes

- Connect your camcorder to the wall outlet (wall socket) using AC Adaptor supplied for this operation (p. 13).
- To avoid the loss of important images, you should save them before formatting the recording media.
- Protected movies and photos will also be deleted.

- While [Executing...] is displayed, do not close the LCD screen, operate the buttons on the camcorder, disconnect the AC Adaptor, or eject the memory card from your camcorder (The access lamp is lit or flashing while formatting memory card.).

### To prevent data on the internal recording media from being recovered (DCR-SR15E/SR20E)

[EMPTY] allows you to write unintelligible data onto the internal recording media of the camcorder. In this way it may become more difficult to recover any original data. When you dispose of or transfer the camcorder, it is recommended that you perform [EMPTY].

When the internal recording media is selected on the [MEDIA FORMAT] screen, select [EMPTY].

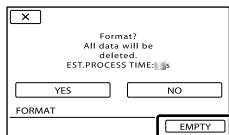

#### Notes

- Connect the AC Adaptor to the wall outlet (wall socket). You cannot perform [EMPTY] unless you connect the AC Adaptor to the wall outlet (wall socket).
- To avoid the loss of important images, they should be saved on a computer or other devices before performing [EMPTY].
- Disconnect all cables except the AC Adaptor. Do not disconnect the AC Adaptor during the operation.
- While deleting data, do not apply any vibrations or shocks to your camcorder.
- Confirm the actual time required to delete data on the LCD screen.
- If you stop performing [EMPTY] while [Executing...] appears, be sure to complete the operation by performing [MEDIA FORMAT]

or [EMPTY] when you use the camcorder next time.

REPAIR IMG.DB F.



See page 73, 76.



## GENERAL SET

### (Other setup items)

See “Using menus” (p. 53) on the operation. The default settings are marked with ►.

#### SOUND/DISP SET

##### ■ VOLUME

You can adjust the volume of playback sound by selecting  / .

##### ■ BEEP



###### ► ON

A melody sounds when you start/stop recording, or press the center of the multi-selector to confirm.

###### OFF

Cancels the melody.

##### ■ LCD BRIGHT

You can adjust the brightness of the LCD screen by selecting  / .

##### Tips

- This adjustment does not affect the recorded images in any way.

##### ■ LCD BL LEVEL (LCD backlight level)

You can select the brightness of the LCD screen's backlight.

###### ► NORMAL

Standard brightness.

###### BRIGHT

Brightens the LCD screen.

##### Notes



- When you connect your camcorder to the wall outlet (wall socket) using the supplied AC Adaptor, [BRIGHT] is automatically selected for the setting.
- When you select [BRIGHT], battery life is slightly reduced during recording.
- If you open the LCD panel 180 degrees to face

the screen outside and close the LCD panel to the camcorder body, the setting becomes [NORMAL] automatically.

 Tips

- This adjustment does not affect the recorded images in any way.

■ LCD COLOR

You can adjust the color of the LCD screen by selecting  / .

 Tips

- This adjustment does not affect the recorded images in any way.

■ DISPLAY SET

You can set the duration of displaying the icons or indicators on the LCD screen.

▶ AUTO

Displays for about 3 seconds.

ON

Always displays.

OUTPUT SETTINGS 

■ TV TYPE

See page 33.

■ DISP OUTPUT (Display output)

You can set where the screen displays are to be output.

▶ LCD PANEL

Shows displays such as the time code on the LCD screen.

V-OUT/PANEL

Shows displays such as the time code on the LCD screen, and on the TV screen.

CLOCK/ LANG 

■ CLOCK SET

See page 14.

■ AREA SET

You can adjust a time difference without stopping the clock. Set your local area when using your camcorder in other time zones. Refer to the world time difference on page 82.

■ SUMMERTIME

You can change this setting without stopping the clock. Set to [ON] to move the time forward 1 hour.

▶ OFF

Does not set the summertime.

ON

Sets the summertime.

■  LANGUAGE SET

You can select the language to be used on the LCD screen.

 Tips

- Your camcorder offers [ENG[SIMP]] (simplified English) for when you cannot find your native tongue among the options.

POWER SETTINGS 

■ A.SHUT OFF (Auto shut off)

You can set your camcorder to turn off automatically when you do not operate your camcorder for more than about 5 minutes.

▶ 5min

The camcorder turns off automatically.

## NEVER

The camcorder does not turn off automatically.

### 🔌 Notes

- When you connect your camcorder to a wall outlet (wall socket), [A.SHUT OFF] is automatically set to [NEVER].

## OTHER SETTINGS

### ■ DEMO MODE

When your camcorder is connected to a wall outlet (wall socket), a demonstration movie appear about 10 minutes after the  (Movie) icon appears by pressing MODE.



#### ▶ ON

The demonstration appears.

#### OFF

The demonstration does not appear.

### 👉 Tips

- When you set this item to [ON] and select , the demonstration starts playing.
- The demonstration will be suspended:
  - When you press START/STOP
  - When you operate the multi-selector during the demonstration (The demonstration starts again after about 10 minutes)
  - When you press MODE
  - When you press  (VIEW IMAGES)

### ■ DROP SENSOR (DCR-SR15E/SR20E)

Your camcorder detects that it is dropping, and protects the internal hard disk.

#### ▶ ON

Activates the drop sensor. When it is detected that the camcorder is dropping, you may not be able to record or play back images correctly, to protect the internal hard disk. When dropping is detected,  appears.

#### OFF ()

Deactivates the drop sensor.

### 🔌 Notes

- Set the drop sensor to [ON] when you use the camcorder. Otherwise, if you drop the camcorder, you may damage the internal hard disk.
- In a non-gravity situation, the drop sensor activates. When you record images during an activity such as roller-coasting or skydiving, you can set [DROP SENSOR] to [OFF] so as not to activate the drop sensor.

## ? Troubleshooting

If you run into any problems using your camcorder, follow the steps below.

① Check the list (p. 70 to 78), and inspect your camcorder.

② Disconnect the power source, attach the power source again after about 1 minute, and turn the camcorder on.

③ Press RESET (p. 90, 91) using a pointed object, and turn the camcorder on.  
If you press RESET, all settings, including the clock setting, are reset.

④ Contact your Sony dealer or local authorized Sony service facility.

- Your camcorder may be required to initialize or change the current internal recording media of your camcorder, depending on the problem. In the event of this, the data stored on the internal recording media will be deleted. Be sure to save the data on the internal recording media on other media (backup) before sending your camcorder for repair. We will not compensate you for any loss of internal recording media data.
- During repair, we may check a minimum amount of data stored on the internal recording media in order to investigate the problem. However, your Sony dealer will neither copy nor retain your data.
- Overall operations ..... p. 70
- Batteries/power sources ..... p. 71
- LCD screen ..... p. 71
- Memory card ..... p. 72
- Recording ..... p. 72
- Playback ..... p. 73
- Playing back images stored on memory card on other devices ..... p. 74
- Editing movies/photos on your camcorder p. 74
- Dubbing/Connecting to other devices ..... p. 74

- Connecting to a Computer ..... p. 74
- Examples of functions that cannot be used simultaneously ..... p. 75

### Overall operations

The power does not turn on.

- Attach a charged battery pack to the camcorder (p. 11).
- The plug of the AC Adaptor has been disconnected from the wall outlet (wall socket). Connect it to the wall outlet (wall socket) (p. 11).

The camcorder does not operate even when the power is set to on.

- It takes a few seconds for your camcorder to be ready to shoot after the power is turned on. This is not a malfunction.
- Disconnect the AC Adaptor from the wall outlet (wall socket) or remove the battery pack, then reconnect it after about 1 minute. If the functions still do not work, press RESET (p. 90, 91) using a pointed object. (If you press RESET, all settings, including the clock setting, are reset.)
- The temperature of your camcorder is extremely high. Turn off your camcorder and leave it for a while in a cool place.
- The temperature of your camcorder is extremely low. Leave your camcorder with the power of your camcorder on. Turn off your camcorder and take it to a warm place. Leave the camcorder there for a while, then turn on your camcorder.

The menu settings have changed automatically.

- The following menu items return to the default settings in more than 12 hours after you close the LCD screen.
  - [SCENE SELECTION]
  - [WHITE BAL.]
  - [EXPOSURE]

- [FOCUS]
  - [BLT-IN ZOOM MIC]
  - [MICREF LEVEL]
  - [DROP SENSOR] (DCR-SR15E/SR20E)
  - Backlight
- The following menu items return to the default settings when you switch between movie recording and photo recording and playback modes.
- [FADER]
  - [TELE MACRO]
  - [SELF-TIMER]

---

#### Your camcorder gets warm.

- Your camcorder may become warm during operation. This is not a malfunction.

---

### Batteries/power sources

---

#### The power abruptly turns off.

- Use the AC Adaptor.
- In the default setting, when about 5 minutes have elapsed while you do not operate your camcorder, the camcorder is automatically turned off (A.SHUT OFF). Change the setting of [A.SHUT OFF] (p. 68), or turn on the power again.
- Charge the battery pack (p. 11).

---

#### The CHG (charge) lamp does not light while the battery pack is being charged.

- Close the LCD screen (p. 11).
- Attach the battery pack to the camcorder correctly (p. 11).
- Connect the power cord (mains lead) to the wall outlet (wall socket) properly.
- The battery charge is completed (p. 11).

---

#### The CHG (charge) lamp flashes while the battery pack is being charged.

- If the temperature of the battery pack is too high or too low, you may not be able to charge it (p. 84).
- Attach the battery pack to the camcorder

correctly (p. 11). If the problem persists, disconnect the AC Adaptor from the wall outlet (wall socket) and contact your Sony dealer. The battery pack may be damaged.

---

#### The remaining battery time indicator does not indicate the correct time.

- The ambient temperature is too high or too low. This is not a malfunction.
- The battery pack has not been charged enough. Fully charge the battery again. If the problem persists, replace the battery pack with a new one (p. 85).
- The indicated time may not be correct depending on the environment of use.

---

#### The battery pack is quickly discharged.

- The ambient temperature is too high or low. This is not a malfunction.
- The battery pack has not been charged enough. Fully charge the battery again. If the problem persists, replace the battery pack with a new one (p. 85).

---

### LCD screen

---

#### Menu items are grayed out.

- You cannot select grayed items in the current recording/playback situation.
- There are some functions you cannot activate simultaneously (p. 75).

---

#### Dots in lines appear on the LCD screen.

- This is not a malfunction. These dots are not recorded.

---

#### The icons on the LCD screen quickly disappear.

- Set [DISPLAY SET] to [ON] (p. 68).

## Memory card

Operations using the memory card cannot be performed.

- If you use the memory card formatted on a computer, format it again on your camcorder (p. 66).

Images stored on the memory card cannot be deleted.

- The maximum number of images that you can delete on the index screen at one time is 100.
- You cannot delete the protected images.



The data file name is not indicated correctly or flashes.

- The file is damaged.
- The file format is not supported by your camcorder (p. 83).

## Recording

Refer also to “Memory card” (p. 72).

Pressing START/STOP or PHOTO does not record images.

- The playback screen is displayed. Press MODE to display the  (Movie) or  (Photo) icons.
- Your camcorder is recording the image you have just shot on the recording media. You cannot make new recording during this period.
- The recording media is full. Delete unnecessary images (p. 35).
- Total number of movie scenes or photos exceeds the recordable capacity of your camcorder (p. 79, 80). Delete unnecessary images (p. 35).
- While [DROP SENSOR] is activated (p. 69), you may not record images (DCR-SR15E /SR20E).
- The temperature of your camcorder is extremely high. Turn off your camcorder and

leave it for a while in a cool place.

- The temperature of your camcorder is extremely low. Turn off your camcorder and take it to a warm place. Leave the camcorder there for a while, then turn on the camcorder.

The access lamp remains lit or flashing even if recording was stopped.

- Your camcorder is recording the scene you have just shot on the memory card.

The imaging field looks different.

- The imaging field may look different depending on the condition of your camcorder. This is not a malfunction.

The actual recording time for movies is less than the expected recording time of the recording media.

- Depending on the recording conditions, the time available for recording may be shorter, for example when recording a fast moving object, etc. (p. 79).

The camcorder stops operating.

- The temperature of your camcorder is extremely high. Turn off your camcorder and leave it for a while in a cool place.
- The temperature of your camcorder is extremely low. Turn off your camcorder and take it to a warm place. Leave the camcorder there for a while, then turn on the camcorder.
- If you keep applying vibration on the camcorder, recording may stop.

There is a time difference between the point when START/STOP is pressed and the point that the recording movie is started or stopped actually.

- On your camcorder, there may be a slight time difference between the point where you press START/STOP and the actual point that recording movie starts/stops. This is not a malfunction.



---

### The auto focus does not function.

- Set [FOCUS] to [AUTO] (p. 60).
- The recording conditions are not suitable for auto focus. Adjust the focus manually (p. 60).

---

### SteadyShot does not function.

- Set [ STEADYSHOT] to [ON] (p. 61).
- Even if [ STEADYSHOT] is set to [ON], your camcorder may not be able to compensate for excessive vibrations.

---

### A vertical band appears when recording candlelight or electric light in the dark.

- This occurs when the contrast between the subject and the background is too high. This is not a malfunction.

---

### A vertical white line may appear on an image taken in bright light.

- This phenomenon is called the smear effect. This is not a malfunction.

---

### Black bands appear when you record a TV screen or computer screen.

- Set [ STEADYSHOT] to [OFF] (p. 61).

---

### Undesirable flicker occurs.

- This occurs when recording images under a fluorescent lamp, sodium lamp, or mercury lamp. This is not a malfunction.

---

### [LCD BL LEVEL] cannot be adjusted.

- You cannot adjust [LCD BL LEVEL] when:
  - The LCD panel is closed on your camcorder with the LCD screen facing out.
  - The power is supplied from the AC Adaptor.

---

### Magnification changes when the recording mode is switched.

- You cannot use digital zoom when your camcorder is in the photo recording mode.

---

## Playback

---

### Images cannot be played back.

- Select the type of recording media you want to play back (p. 17) (DCR-SR15E/SR20E).
- Images recorded on other devices may not be played back. This is not a malfunction.

---

### Photos cannot be played back.

- Photos cannot be played back if you have modified files or folders, or have edited the data on a computer. (The file name flashes in that case.) This is not a malfunction.

---

### is indicated on an image on the VISUAL INDEX screen.

- This may appear on an image recorded on other devices, edited on a computer, etc.
- You removed the AC Adaptor or the battery pack while the recording media icon at the top right corner of the screen flashes, or before the access lamp is turned off after recording. This may damage your image data and is displayed.

---

### is indicated on an image on the VISUAL INDEX screen.

- The image data base file may be damaged. Check the data base file by selecting **MENU** (MENU) → [Show others] → [REPAIR IMG.DB F.] (under [MANAGE MEDIA] category) → the recording medium (DCR-SR15E/SR20E). If it still appears, delete the image with (p. 35).

---

### No sound or only a quiet sound is heard during playback.

- Turn up the volume (p. 28).
- When you record sound with [MICREF LEVEL] (p. 62) set to [LOW], the recorded sound may be difficult to hear.

## Playing back images stored on memory card on other devices

Images cannot be played back or the memory card is not recognized.

- The device may not support memory card.

## Editing movies/photos on your camcorder

Unable to edit.

- Unable to edit because of the condition of the image.

Movies cannot be added in the Playlist.

- There is no free space in the recording media.
- You can add no more than 99 movies to a Playlist. Erase unnecessary movies from the Playlist (p. 44).
- You cannot add photos in the Playlist.

A movie cannot be divided.

- A movie that is too short cannot be divided.
- A protected movie cannot be divided.

A photo cannot be captured from a movie.

- The recording media where you want to save photos is full.

## Dubbing/Connecting to other devices

The aspect ratio of the playback is not correct when connecting your camcorder to the TV.

- Set [TV TYPE] according to your TV (p. 68).

The top, bottom, right, and left edges of images are trimmed slightly on a connected TV.

- The LCD screen of your camcorder can display recording images across the entire screen (full pixel display). However, this may cause slight trimming of the top, bottom, right, and left edges of images when played back on a TV which is not compatible with full pixel display.
- It is recommended you record images using the outer frame of [GUIDEFAME] (p. 61) as a guide.

Images are not dubbed correctly.

- The A/V connecting cable is not connected properly. Make sure to connect the cable to the input jack of another device (p. 48).

## Connecting to a Computer

"PMB" cannot be installed.

- Check the computer environment or installation procedure required to install "PMB."

"PMB" does not work correctly.

- Quit "PMB" and restart your computer.

The camcorder is not recognized by the computer.

- Disconnect devices from the USB jack of the computer other than the keyboard, mouse, and your camcorder.
- Disconnect the USB cable from the computer and your camcorder, and restart the computer, then connect the computer and your camcorder again in the correct order.

## Examples of functions that cannot be used simultaneously

The following list shows examples of unworkable combinations of functions and menu items.

Cannot use	Because of following settings
Backlight	[MANUAL] in [EXPOSURE], [FIREWORKS]
[FACE DETECTION]	[ DIGITAL ZOOM], [EXPOSURE], [TWILIGHT], [CANDLE], [SUNRISE&SUNSET], [FIREWORKS], [LANDSCAPE], [SPOTLIGHT], [BEACH], [SNOW]
[SCENE SELECTION]	[ FADER], [TELE MACRO]

## Self-diagnosis display/Warning indicators

If indicators appear on the LCD screen, check the following.

If the problem persists even after you have tried to fix a couple of times, contact your Sony dealer or local authorized Sony service facility. In this case, when you contact them, give them all the numbers of the error code beginning with C or E.

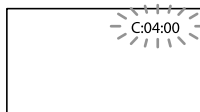

C:(or E:) □□:□□ (Self-diagnosis display)

C:04:□□

- The battery pack is not an "InfoLITHIUM" battery pack (V series). Use an "InfoLITHIUM" battery pack (V series). (p. 84).

- Connect the DC plug of the AC Adaptor to the DC IN jack of your camcorder securely (p. 11).

C:06:□□

- The battery pack temperature is high. Change the battery pack or place it in a cool place.

C:13:□□ / C:32:□□

- Remove the power source. Reconnect it and operate your camcorder again.

E:□□:□□

- Follow the steps from ② to ④ on page 70.

(Warning on the internal hard disk of the camcorder)

Fast flashing

- The internal hard disk of the camcorder is full.
- An error may have occurred with the internal hard disk of the camcorder.

(Battery level warning)

Slow flashing

- The battery pack is nearly used up.
- Depending on the operating environment or battery conditions, may flash, even if there are about 20 minutes remaining.

(Warning indicator pertaining to battery pack temperature)

- The battery pack temperature is high. Change the battery pack or place it in a cool place.

(High temperature warning)

Slow flashing

- The temperature of your camcorder is getting higher. Turn off your camcorder and leave it for a while in a cool place.

Fast flashing

- The temperature of your camcorder is extremely high. Turn off your camcorder and leave it for a while in a cool place.

---

### (Low temperature warning)

#### Fast flashing

- The temperature of your camcorder is extremely low. Make the camcorder warm.

---

### (Warning indicator pertaining to memory card)

#### Slow flashing

- Free spaces for recording images are running out. For the type of memory card you can use with your camcorder, see page 19.
- No memory card is inserted (p. 18).

#### Fast flashing

- There are not enough free spaces for recording images. After storing the images on other media (p. 45), delete unnecessary images, or format the memory card (p. 66).
- The image data base file may be damaged. Check the data base file by selecting **MENU** (MENU) → [Show others] → [REPAIR IMG.DB F.] (under  [MANAGE MEDIA] category) → the recording medium (DCR-SR15E/SR20E).
- The memory card is damaged.

---

### (Warning indicators pertaining to memory card formatting)

- The memory card is damaged.
- The memory card is not formatted correctly (p. 66).

---

### (Warning indicator pertaining to incompatible memory card)

- Incompatible memory card is inserted (p. 19).

---

### (Warning indicator pertaining to the write-protect of the memory card)

- Access to the memory card was restricted on another device.

---

### (Warning indicator pertaining to camera-shake warning)

- The camcorder is unsteady, so camera-shake easily occurs. Hold the camcorder steady with both hands and record the image. However, note that the camera-shake warning indicator does not disappear.

---

### (Warning indicator pertaining to drop sensor)

- The drop sensor function (p. 69) is activated, and has detected that the camcorder has been dropped. Therefore, the camcorder is taking steps to protect the internal hard disk. Recording/playback may be disabled as a result.
- The drop sensor function does not guarantee the protection of the internal hard disk under all possible situations. Use the camcorder under stable conditions.

---

### Tips

- You may hear a melody when some warning indicators appear on the screen.

## Description of warning messages

If messages appear on the screen, follow the instructions.

### Recording media

---

#### HDD format error.

- The internal recording media of the camcorder is set differently from the default format. Performing [MEDIA FORMAT] (p. 66) may enable you to use your camcorder. This will delete all data in the internal recording media.

---

### Data error.

- An error occurred during reading or writing the internal recording media of the camcorder.
- This may occur when you keep applying shock on the camcorder.
- Movies recorded on other devices may not be played back.

---

### The Image Database File is damaged. Do you want to create a new file?

- The management file is damaged. When you select [YES], a new management file is created. The old recorded images on the media cannot be played back (Image files are not damaged). If you execute [REPAIR IMG.DB F.] after creating new information, playing back the old recorded images may become possible. If it does not work, copy the image using the supplied software "PMB".

---

### Inconsistencies found in Image Database File. Do you want to repair the Image Database File?

#### The Image Database File is damaged. Do you want to repair the Image Database File?

- The management file is damaged, and you cannot record movies or photos. Select [YES] to repair.
- You can record photos on a memory card.

---

### Buffer overflow

- A memory card on which recording and deleting has been repeated or formatted on other devices is used. Format the memory card on your camcorder after backing up the data to the hard disk of a computer, etc. (p. 66).
- Write performance of the memory card you are using is insufficient for the movie recording speed of your camcorder. Use a memory card recommended for your camcorder (p. 18).

- You cannot record because the drop sensor senses a drop of the camcorder repeatedly. If you are at risk of dropping the camcorder constantly, set [DROP SENSOR] to [OFF], and you may be able to record the image again (p. 69).

---

### Recovering data.

- Your camcorder tries to recover data automatically if the data writing was not performed properly.

---

### Cannot recover data.

- Writing data onto the media of the camcorder has failed. Attempts were made to recover the data, but they were unsuccessful.

---

### Reinsert the memory card.

- Reinsert the memory card a few times. If even then the indicator flashes, the memory card could be damaged. Try with another memory card.

---

### This memory card is not formatted correctly.

- Format the memory card (p. 66). Note that if you format the memory card, all the recorded movies and photos are deleted.

---

### Still picture folder is full. Cannot record still pictures.

- You cannot create folders exceeding 999MSDCF. You cannot create or delete created folders using your camcorder.
- Format the memory card (p. 66), or delete folders using your computer.

---

### This memory card may not be able to record or play movies.

- Use a memory card recommended for your camcorder (p. 19).

---

This memory card may not be able to record or play images correctly.

- Use a memory card recommended for your camcorder (p. 19).

---

Do not eject the memory card during writing. Data may be damaged.

- Reinsert the memory card, and follow the instructions on the LCD screen.

---

## Other

---

No further selection is possible.

- You can add no more than 99 movies to a Playlist.
- You can select only 100 images at one time for:
  - Deleting movies/photos
  - Protecting movies/photos, or releasing the protection
  - Dubbing movies
  - Copying photos

---

Data protected.

- You tried to delete protected data. Release the protection of the data.

# Recording time of movies/number of recordable photos

## Expected time of recording and playback with each battery pack

### Recording time

Approximate time available when you use a fully charged battery pack.

#### DCR-SR15E/SR20E

Battery pack	(unit: minute)	
	Continuous recording time	Typical recording time
NP-FV30 (supplied)	95	45
NP-FV50	180	85
NP-FV70	375	180
NP-FV100	745	355

#### DCR-SX15E/SX20E

Battery pack	(unit: minute)	
	Continuous recording time	Typical recording time
NP-FV30 (supplied)	105	50
NP-FV50	200	95
NP-FV70	415	195
NP-FV100	830	395

- Each recording time is measured when the [REC MODE] is set to SP.
- Typical recording time shows the time when you repeat recording start/stop, switching the movie or photo mode, and zooming.
- Times measured when using the camcorder at 25 °C (77 °F). 10 °C to 30 °C (50 °F to 86 °F) is recommended.
- The recording and playback time will be shorter when you use your camcorder in low temperatures.
- The recording and playback time will be shorter depending on the conditions under which you use your camcorder.

### Playing time

Approximate time available when you use a fully charged battery pack.

#### DCR-SR15E/SR20E

Battery pack	(unit: minute)
NP-FV30 (supplied)	125
NP-FV50	240
NP-FV70	490
NP-FV100	980

#### DCR-SX15E/SX20E

Battery pack	(unit: minute)
NP-FV30 (supplied)	145
NP-FV50	280
NP-FV70	565
NP-FV100	1120

## Expected recording time of movies

### Internal hard disk

#### DCR-SR15E/SR20E

Recording mode	(unit: minute)
[HQ]	1220
[SP]	1750
[LP]	3660

### Tips

- You can record movies of a maximum of 9,999 scenes.
- The maximum continuous recording time of movies is approximately 13 hours.
- Your camcorder uses the VBR (Variable Bit Rate) format to automatically adjust image quality to suit the recording scene. This

technology causes fluctuations in the recording time of the media. Movies containing quickly moving and complex images are recorded at a higher bit-rate, and this reduces the overall recording time.

## Memory card

	(unit: minute)		
	HQ	SP	LP
512MB	6 (5)	9 (5)	20 (10)
1GB	10 (10)	20 (10)	40 (25)
2GB	25 (25)	40 (25)	85 (55)
4GB	55 (50)	80 (50)	175 (110)
8GB	115 (105)	170 (105)	355 (230)
16GB	235 (210)	340 (210)	715 (465)
32GB	475 (425)	685 (425)	1435 (930)

### Notes

- The recordable time may vary depending on the recording and subject conditions, [RECORD MODE] (p. 61).
- The number in ( ) is the minimum recordable time.

## Expected number of recordable photos

### Internal recording media (DCR-SR15E/SR20E)

You can record the maximum 9,999 photos.

## Memory card

	VGA(0.3M) VGA
512MB	2800
1GB	5700
2GB	11500
4GB	23000
8GB	47000
16GB	95000
32GB	185000

- The indicated number of recordable photos on a memory card is based on the maximum image size of your camcorder. The actual number of recordable photos is displayed on the LCD screen during recording (p. 89).
- The maximum number of recordable photos on a memory card may vary depending on the recording conditions.

### Tips

- You can also use memory card with a capacity of under 512 MB for recording photos.
- The following list shows the average bit-rate, the recording pixels, and the aspect ratio of each movie recording mode.
  - HQ: Approx. 9Mbps 720 pixels × 576 pixels/16:9, 4:3
  - SP: Approx. 6Mbps 720 pixels × 576 pixels/16:9, 4:3
  - LP: Approx. 3Mbps 720 pixels × 576 pixels/16:9, 4:3
- The photo recording pixels and the aspect ratio.
  - Photo recording mode:
    - 640 dots × 480 dots/4:3
    - 640 dots × 360 dots/16:9
  - Capturing a photo from a movie:
    - 640 dots × 360 dots/16:9
    - 640 dots × 480 dots/4:3



# Using your camcorder abroad

## Power supply

You can use your camcorder in any countries/regions using the AC Adaptor supplied with your camcorder within the AC 100 V to 240 V, 50 Hz/60 Hz range.

## On TV color systems

Your camcorder is a PAL-system-based camcorder. If you want to view the playback image on a TV, it must be a PAL-system-based TV with an AUDIO/VIDEO input jack.

System	Used in
PAL	Australia, Austria, Belgium, China, Czech Republic, Denmark, Finland, Germany, Holland, Hong Kong, Hungary, Italy, Kuwait, Malaysia, New Zealand, Norway, Poland, Portugal, Singapore, Slovak Republic, Spain, Sweden, Switzerland, Thailand, United Kingdom, etc.
PAL-M	Brazil
PAL-N	Argentina, Paraguay, Uruguay
NTSC	Bahama Islands, Bolivia, Canada, Central America, Chile, Colombia, Ecuador, Guyana, Jamaica, Japan, Korea, Mexico, Peru, Surinam, Taiwan, the Philippines, the USA, Venezuela, etc.
SECAM	Bulgaria, France, Guiana, Iran, Iraq, Monaco, Russia, Ukraine, etc.

## Setting to the local time

You can easily set the clock to the local time by setting a time difference when using your camcorder abroad. Select **MENU** (MENU) → [Show others] → [CLOCK/🗺️LANG] (under 🗺️ [GENERAL SET] category) → [AREA SET] and [SUMMERTIME] (p. 68).

## World time difference

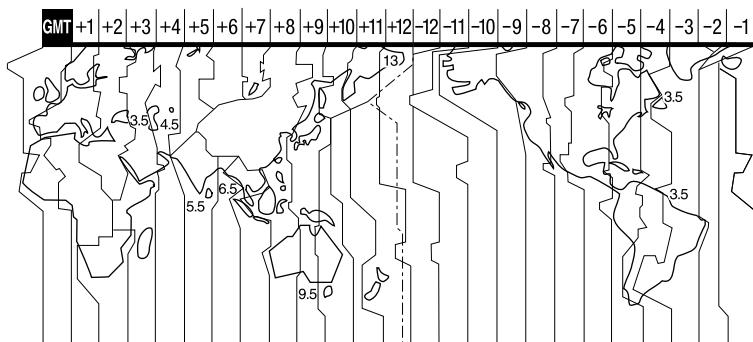

Time-zone differences	Area setting
GMT	Lisbon, London
+01:00	Berlin, Paris
+02:00	Helsinki, Cairo, Istanbul
+03:00	Moscow, Nairobi
+03:30	Tehran
+04:00	Abu Dhabi, Baku
+04:30	Kabul
+05:00	Karachi, Islamabad
+05:30	Calcutta, New Delhi
+06:00	Almaty, Dhaka
+06:30	Yangon
+07:00	Bangkok, Jakarta
+08:00	Hong Kong, Singapore, Beijing
+09:00	Seoul, Tokyo
+09:30	Adelaide, Darwin
+10:00	Melbourne, Sydney
+11:00	Solomon Is

Time-zone differences	Area setting
+12:00	Fiji, Wellington, Eniwetok, Kwajalein
-11:00	Samoa
-10:00	Hawaii
-09:00	Alaska
-08:00	Los Angeles, Tijuana
-07:00	Denver, Arizona
-06:00	Chicago, Mexico City
-05:00	New York, Bogota
-04:00	Santiago
-03:30	St.John's
-03:00	Brasilia, Montevideo
-02:00	Fernando de Noronha
-01:00	Azores, Cape Verde Is.

# Maintenance and precautions

## About the memory card

- Memory card formatted by a computer (Windows OS/Mac OS) does not have guaranteed compatibility with your camcorder.
- Data read/write speed may vary depending on the combination of the memory card and memory card compliant product you use.
- Damaged or lost data may occur in the following cases (the data will not be compensated for):
  - If you eject the memory card, or turn off your camcorder while your camcorder is reading or writing image files on the memory card (while the access lamp is lit or flashing)
  - If you use the memory card near magnets or magnetic fields
- It is recommended that you make a back-up of important data on the hard disk of a computer.
- Do not attach a label or the like on memory card or memory card adaptor.
- Do not touch, or allow metallic objects to come into contact with the terminals.
- Do not bend, drop or apply strong force to the memory card.
- Do not disassemble or modify the memory card.
- Do not let the memory card get wet.
- Keep the memory card out of the reach of small children. There is danger that a child might swallow it.
- Do not insert anything other than a memory card of the compatible size into the memory card slot, as doing so may cause a malfunction.
- Do not use or keep the memory card in the following locations:
  - Places subject to extremely high temperature, such as a car parked outside in the summer
  - Places under direct sunlight
  - Places with extremely high humidity or subject to corrosive gases

## On the memory card adaptor

- When using memory card with memory card compliant device inserting memory card into memory card adaptor, make sure the memory card is inserted facing in the correct

direction. Note that improper use may cause a malfunction.

## On image data compatibility

- Image data files recorded on memory card by your camcorder conform to the “Design rule for Camera File system” universal standard established by the JEITA (Japan Electronics and Information Technology Industries Association).
- On your camcorder, you cannot play back photos recorded on other devices (DCR-TRV900E or DSC-D700/D770) that do not conform to the universal standard. (These models are not sold in some regions.)
- If you cannot use memory card that have been used with another device, format it with your camcorder (p. 66). Note that formatting erases all information on the memory card.
- You may not be able to play back images with your camcorder:
  - When playing back image data modified on your computer
  - When playing back image data recorded with other devices

## About the “Memory Stick” media

Types of “Memory Stick” media	Recording/Playback
“Memory Stick Duo” media (with MagicGate)	—
“Memory Stick PRO Duo” media	○
“Memory Stick PRO-HG Duo” media	○*

- \* This product does not support 8-bit parallel data transfer but it supports 4-bit parallel data transfer the same as with “Memory Stick PRO Duo” media.
- This product cannot record or play data that uses “MagicGate” technology. “MagicGate” is a copyright protection technology that records and transfers the contents in an encrypted format. This product is compatible with “Memory Stick Micro” media (“M2”). “M2” is the abbreviation for the “Memory Stick Micro” media.

## Notes on using the “Memory Stick Micro” media

- To use “Memory Stick Micro” media with your camcorder, you need a Duo-sized M2 adaptor. Insert the “Memory Stick Micro” media into the Duo-sized M2 adaptor, and then insert the adaptor into the “Memory Stick Duo” media slot.  
If you insert a “Memory Stick Micro” media into your camcorder without using the Duo-sized M2 adaptor, you might not be able to remove it from your camcorder.
- Do not leave the “Memory Stick Micro” media within the reach of small children. They might accidentally swallow it.

### About the “InfoLITHIUM” battery pack

Your camcorder operates only with an “InfoLITHIUM” V series battery packs. “InfoLITHIUM” V series battery packs have the  mark.

### What is an “InfoLITHIUM” battery pack?

- An “InfoLITHIUM” battery pack is a lithium-ion battery pack that has functions for communicating information related to operating conditions between your camcorder and an AC Adaptor/charger (sold separately).
- The “InfoLITHIUM” battery pack calculates the power consumption according to the operating conditions of your camcorder, and displays the remaining battery time in minutes.

### To charge the battery pack

- Be sure to charge the battery pack before you start using your camcorder.
- We recommend charging the battery pack in an ambient temperature of between 10 °C to 30 °C (50 °F to 86 °F) until the CHG (charge) lamp turns off. If you charge the battery pack outside of this temperature range, you may not be able to charge it efficiently.

### To use the battery pack effectively

- Battery pack performance decreases when the ambient temperature is 10 °C (50 °F) or below, and the length of time you can use the battery pack becomes shorter. In that case, do one of the following to use the battery pack for a longer time.
  - Put the battery pack in a pocket to warm it up, and install it on your camcorder right before you start taking shots.
  - Use a large capacity battery pack: NP-FV70/ NP-FV100 (sold separately).
- Frequent use of the LCD screen or a frequent playback, fast forward or reverse operation wears out the battery pack faster. We recommend using a large capacity battery pack: NP-FV70/NP-FV100 (sold separately).
- Be sure to close the LCD screen when not recording or playing back on your camcorder. The battery pack is also consumed when your camcorder is in recording standby or playback pause.
- Have spare battery packs ready for 2 times or 3 times the expected recording time, and make trial recordings before making the actual recording.
- Do not expose the battery pack to water. The battery pack is not water resistant.

### About the remaining battery time indicator

- When the power goes off even though the remaining battery time indicator indicates that the battery pack has enough power to operate, charge the battery pack fully again. Remaining battery time will be indicated correctly. Note, however, that the battery indication will not be restored if it is used in high temperatures for a long time, or if left in a fully charged state, or when the battery pack is frequently used. Use the remaining battery time indication as a rough guide only.
- The  mark that indicates low battery flashes even if there are still 20 minutes of battery time remaining, depending on the operating conditions or ambient temperature.

## About storage of the battery pack

- If the battery pack is not used for a long time, fully charge the battery pack and use it up on your camcorder once a year to maintain proper function. To store the battery pack, remove it from your camcorder and put it in a dry, cool place.
- To discharge the battery pack on your camcorder completely, select **MENU** (MENU) → [Show others] → [POWER SETTINGS] (under  [GENERAL SET] category) → [A.SHUT OFF] → [NEVER], and leave your camcorder in recording standby until the power goes off (p. 68).

## About battery life

- Battery capacity decreases over time and through repeated use. If decreased usage time between charges becomes significant, it is probably time to replace it with a new one.
- Each battery's life is governed by storage, operating and environmental conditions.

## About handling of your camcorder

### On use and care

- Do not use or store the camcorder and accessories in the following locations:
  - Anywhere extremely hot, cold or humid. Never leave them exposed to temperatures above 60 °C (140 °F), such as under direct sunlight, near heaters or in a car parked in the sun. They may malfunction or become deformed.
  - Near strong magnetic fields or mechanical vibration. The camcorder may malfunction.
  - Near strong radio waves or radiation. The camcorder may not be able to record properly.
  - Near AM receivers and video equipment. Noise may occur.
  - On a sandy beach or anywhere dusty. If sand or dust gets in your camcorder, it may malfunction. Sometimes this malfunction cannot be repaired.
  - Near windows or outdoors, where the LCD screen, or the lens may be exposed to direct

- sunlight. This damages the LCD screen.
- Operate your camcorder on DC 6.8 V/7.2 V (battery pack) or DC 8.4 V (AC Adaptor).
- For DC or AC operation, use the accessories recommended in these operating instructions.
- Do not let your camcorder get wet, for example, from rain or sea water. If your camcorder gets wet, it may malfunction. Sometimes this malfunction cannot be repaired.
- If any solid object or liquid gets inside the casing, unplug your camcorder and have it checked by a Sony dealer before operating it any further.
- Avoid rough handling, disassembling, modifying, physical shock, or impact such as hammering, dropping or stepping on the product. Be particularly careful of the lens.
- Keep the LCD screen closed when you are not using your camcorder.
- Do not wrap your camcorder with a towel, for example, and operate it. Doing so might cause heat to build up inside.
- When disconnecting the power cord (mains lead), pull it by the plug and not the cord.
- Do not damage the power cord (mains lead) such as by placing anything heavy on it.
- Do not use a deformed or damaged battery pack.
- Keep metal contacts clean.
- If the battery electrolytic liquid has leaked:
  - Consult your local authorized Sony service facility.
  - Wash off any liquid that may have contacted your skin.
  - If any liquid gets in your eyes, wash with plenty of water and consult a doctor.

### When not using your camcorder for a long time

- To keep your camcorder in optimum state for a long time, turn it on and let it run by recording and playing back images about once a month.
- Use up the battery pack completely before storing it.

### Moisture condensation

If your camcorder is brought directly from a cold

place to a warm place, moisture may condense inside your camcorder. This may cause a malfunction to your camcorder.

- If moisture condensation has occurred  
Leave your camcorder for about 1 hour without turning it on.
- Note on moisture condensation  
Moisture may condense when you bring your camcorder from a cold place into a warm place (or vice versa) or when you use your camcorder in a humid place as follows:
  - You bring your camcorder from a ski slope into a place warmed up by a heating device.
  - You bring your camcorder from an air conditioned car or room into a hot place outside.
  - You use your camcorder after a squall or a shower.
  - You use your camcorder in a hot and humid place.
- How to prevent moisture condensation  
When you bring your camcorder from a cold place into a warm place, put your camcorder in a plastic bag and seal it tightly. Remove the bag when the air temperature inside the plastic bag has reached the surrounding temperature (after about 1 hour).

## LCD screen

- Do not exert excessive pressure on the LCD screen, as it may cause uneven color and other damage.
- If your camcorder is used in a cold place, a residual image may appear on the LCD screen. This is not a malfunction.
- While using your camcorder, the back of the LCD screen may heat up. This is not a malfunction.

## To clean the LCD screen

- If fingerprints or dust make the LCD screen dirty, it is recommended that you use a soft cloth to clean it.
- When you use the LCD Cleaning Kit (sold separately), do not apply the cleaning liquid directly to the LCD screen. Use cleaning paper moistened with the liquid.

## On handling the casing

- If the casing is soiled, clean the camcorder body with a soft cloth lightly moistened with water, and then wipe the casing with a dry soft cloth.
- Avoid the following to avoid damage to the finish:
  - Using chemicals such as thinner, benzine, alcohol, chemical cloths, repellent, insecticide and sunscreen
  - Handling the camcorder with above substances on your hands
  - Leaving the casing in contact with rubber or vinyl objects for a long period of time

## About care and storage of the lens

- Wipe the surface of the lens clean with a soft cloth in the following instances:
  - When there are fingerprints on the lens surface
  - In hot or humid locations
  - When the lens is exposed to salty air such as at the seaside
- Store in a well-ventilated location subject to little dirt or dust.
- To prevent mold, periodically clean the lens as described above.

## On charging the pre-installed rechargeable battery



Your camcorder has a pre-installed rechargeable battery to retain the date, time, and other settings even when the LCD screen is closed. The pre-installed rechargeable battery is always charged while your camcorder is connected to the wall outlet (wall socket) via the AC Adaptor or while the battery pack is attached. The rechargeable battery will be fully discharged in about 3 months if you do not use your camcorder at all. Use your camcorder after charging the pre-installed rechargeable battery.

However, even if the pre-installed rechargeable battery is not charged, the camcorder operation will not be affected as long as you are not recording the date.

## How to charge the pre-installed rechargeable battery

Connect your camcorder to a wall outlet (wall socket) using the supplied AC Adaptor, and leave it with the LCD screen closed for more than 24 hours.

## Note on disposal/transfer (DCR-SR15E/SR20E)

Even if you perform [  DELETE ALL ], [  DELETE ALL ] or [ MEDIA FORMAT ] (p. 66) or formatting the media of the camcorder, you may not delete data from the media completely. When you transfer the camcorder, it is recommended that you perform [ EMPTY ] (p. 66) to prevent the recovery of your data. Also, when you dispose of the camcorder, it is recommended that you destroy the actual body of the camcorder.

## Note on disposal/transfer of the memory card

Even if you delete data in the memory card or format the memory card on your camcorder or a computer, you may not delete data from the memory card completely. When you give the memory card to somebody, it is recommended that you delete data completely using data deletion software on a computer. Also, when you dispose of the memory card, it is recommended that you destroy the actual body of the memory card.

## On trademarks

- “Handycam” and **HANDYCAM** are registered trademarks of Sony Corporation.
- “Memory Stick,”  “Memory Stick Duo,” **“MEMORY STICK DUO,”** “Memory Stick PRO Duo,” **“MEMORY STICK PRO DUO,”** “Memory Stick PRO-HG Duo,” **“MEMORY STICK PRO-HG DUO,”** “Memory Stick Micro,” “MagicGate,” **“MAGICGATE,”** “MagicGate Memory Stick” and “MagicGate Memory Stick Duo” are trademarks or registered trademarks of Sony Corporation.
- “InfoLITHIUM” is a trademark of Sony Corporation.
- “DVDirect” is a trademark of Sony Corporation.
- Dolby and the double-D symbol are trademarks of Dolby Laboratories.
- Microsoft, Windows, Windows Vista, and DirectX are either registered trademarks or trademarks of Microsoft Corporation in the United States and/or other countries.
- Macintosh and Mac OS are registered trademarks of Apple Inc. in the U.S. and other countries.
- Intel, Intel Core, and Pentium are trademarks or registered trademarks of Intel Corporation or its subsidiaries in the United States and other countries.
- Adobe, the Adobe logo, and Adobe Acrobat are either registered trademarks or trademarks of Adobe Systems Incorporated in the United States and/or other countries.
- SDXC and SDHC logo are trademarks of SD-3C, LLC.
- MultiMediaCard is a trademark of MultiMediaCard Association.

All other product names mentioned herein may be the trademarks or registered trademarks of their respective companies. Furthermore, <sup>TM</sup> and © are not mentioned in each case in this Handbook.

## Notes on the License

ANY USE OF THIS PRODUCT OTHER THAN CONSUMER PERSONAL USE IN ANY MANNER THAT COMPLIES WITH THE MPEG-2 STANDARD FOR ENCODING VIDEO INFORMATION FOR PACKAGED MEDIA IS EXPRESSLY PROHIBITED WITHOUT A LICENSE UNDER APPLICABLE PATENTS IN THE MPEG-2 PATENT PORTFOLIO, WHICH LICENSE IS AVAILABLE FROM MPEG LA, L.L.C., 250 STEELE STREET, SUITE 300, DENVER, COLORADO 80206.

## On GNU GPL/LGPL applied software

The software that is eligible for the following GNU General Public License (hereinafter referred to as "GPL") or GNU Lesser General Public License (hereinafter referred to as "LGPL") are included in the camcorder.

This informs you that you have a right to have access to, modify, and redistribute source code for these software programs under the conditions of the supplied GPL/LGPL.

Source code is provided on the web. Use the following URL to download it. When downloading the source code, select DCR-SX43 as the model for your camcorder.

<http://www.sony.net/Products/Linux/>

We would prefer you do not contact us about the contents of source code.

Read "license2.pdf" in the "License" folder on the CD-ROM. You will find licenses (in English) of "GPL," and "LGPL" software.

To view the PDF, Adobe Reader is needed. If it is not installed on your computer, you can download it from the Adobe Systems web page: <http://www.adobe.com/>



## Screen indicators

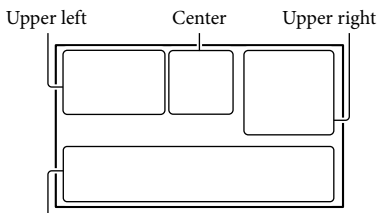

Bottom

Upper left

Indicator	Meaning
	MENU button (53)
	Self-timer recording (63)
	MICREF LEVEL low (62)
	WIDE SELECT (62)
	BLT-IN ZOOM MIC (62)
	Remaining battery
	Recording folder of memory card
	VIDEO LIGHT (26)
	Return button (53)

Center

Indicator	Meaning
	Recording status (21)
	Photo size (63)
	Slide show set (32)
	Warning (75)
	Playback mode (28)

Upper right

Indicator	Meaning
	Recording mode (HQ/SP/LP) (25)
	Recording/playback/editing media (17)
	Counter (hour:minute:second)

Indicator	Meaning
	Estimated recording remaining time
	FADER (58)
	Drop sensor off (69)
	Drop sensor activated (69)
	Approximate number of recordable photos and recording media (80)
	Playback folder of memory card (29)
	Current playing movie or photo/Number of total recorded movies or photos (79)

Bottom

Indicator	Meaning
	[FACE DETECTION] set to [OFF] (61)
	Manual focus (60)
	SCENE SELECTION (58)
	White balance (59)
	SteadyShot off (61)
	EXPOSURE (60)
	TELE MACRO (60)
	Backlight (26)
	OPTION button (55)
	VIEW IMAGES button (27)
	Slide show button (32)
	Data file name (29)
	Protected image (37)
	Index button (29)
	Movie mode/photo mode (21, 23)

- Indicators and their positions are approximate and may differ from what you actually see.
- Some indicators may not appear, depending on your camcorder model.

# Parts and controls

Figures in ( ) are reference pages.

## DCR-SR15E/SR20E

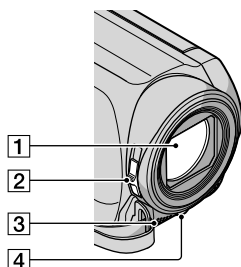

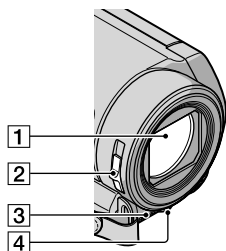

- 1 Lens
- 2 LENS COVER switch
- 3 Built-in microphone
- 4 LED VIDEO LIGHT (26)

## DCR-SX15E/SX20E



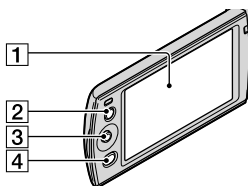

- 1 Lens
- 2 LENS COVER switch
- 3 Built-in microphone
- 4 LED VIDEO LIGHT (26)

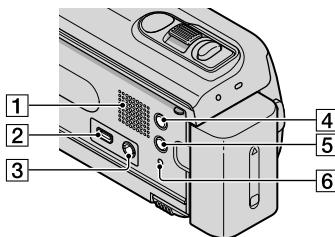

- 1 LCD screen (26, 53)  
If you rotate the LCD panel 180 degrees, you can close the LCD panel with the LCD screen facing out. This is convenient during playback operations.
- 2 LIGHT button (26)  
Press to light up the LIGHT.
- 3 Multi-selector (16)
- 4  (VIEW IMAGES) button (27)

## DCR-SR15E/SR20E



- 1 Speaker
- 2  (USB) jack (48)  
DCR-SR15E: output only
- 3 A/V OUT jack (33)
- 4 MODE button (21)
- 5  (Backlight) button (26)
- 6 RESET button  
Press RESET using a pointed object.  
Press RESET to initialize all the settings including the clock setting.

## DCR-SX15E/SX20E

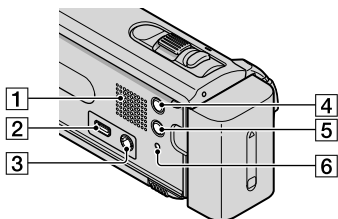

1 Speaker

2  $\Psi$  (USB) jack (48)

DCR-SX15E: output only

3 A/V OUT jack (33)

4 MODE button (21)

5  (Backlight) button (26)

6 RESET button

Press RESET using a pointed object.

Press RESET to initialize all the settings including the clock setting.

## DCR-SR15E/SR20E

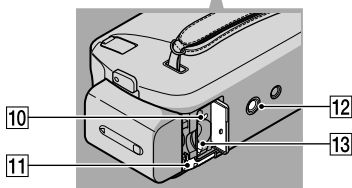
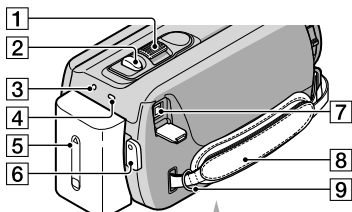

1 Power zoom lever (25)

2 PHOTO button (24)

3 POWER lamp

4 CHG (charge) lamp (11)

5 Battery pack (11)

6 START/STOP button (21)

7 DC IN jack (11)

8 Grip belt (20)

9 Hook for a shoulder belt

10 Access lamp (memory card) (18)

While the lamp is lit or flashing, the camcorder is reading or writing data.

11 BATT (battery) release lever (13)

12 Tripod receptacle

Attach a tripod (sold separately) to the tripod receptacle using a tripod screw (sold separately: the length of the screw must be less than 5.5 mm (7/32 in.)).

13 Memory card slot (18)

## DCR-SX15E/SX20E

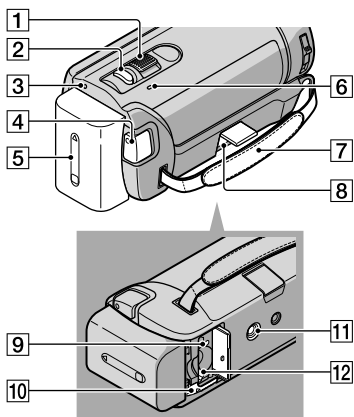

**1** Power zoom lever (25)

**2** PHOTO button (24)

**3** POWER lamp

**4** START/STOP button (21)

**5** Battery pack (11)

**6** CHG (charge) lamp (11)

**7** Grip belt (20)

**8** DC IN jack (11)

**9** Access lamp (memory card) (18)

While the lamp is lit or flashing, the camcorder is reading or writing data.

**10** BATT (battery) release lever (13)

**11** Tripod receptacle

Attach a tripod (sold separately) to the tripod receptacle using a tripod screw (sold separately: the length of the screw must be less than 5.5 mm (7/32 in.)).

**12** Memory card slot (18)

# Index

- Symbols**
- 16:9 ..... 33
  - 4:3 ..... 33
- A**
- A.SHUT OFF ..... 68
  - A/V connecting cable ..... 33, 51
  - Abroad ..... 81
  - Altitude ..... 4
  - AREA SET ..... 68
  - AUDIO REC SET ..... 62
  - AUTO SLW SHUTTR ..... 61
- B**
- Backlight ..... 26
  - BATTERY INFO ..... 65
  - Battery pack ..... 11
  - BEACH ..... 58
  - BEEP ..... 67
  - BLACK FADER ..... 59
  - BLT-IN ZOOM MIC ..... 62
- C**
- CAMERA DATA ..... 64
  - CANDLE ..... 58
  - Capturing a photo from a movie ..... 39
  - Charging the battery pack ..... 11
  - Charging the battery pack abroad ..... 13, 81
  - CLOCK/LANG ..... 68
  - CLOCK SET ..... 14
  - Copy ..... 41
  - Creating a disc ..... 48
- D**
- DATA CODE ..... 15, 64
  - DATE/TIME ..... 15, 64
  - Date Index ..... 30
  - DELETE ..... 35
  - DEMO MODE ..... 69
  - DIGITAL ZOOM ..... 62
  - Disc recorder ..... 51
  - DISPLAY SET ..... 68
  - DISP OUTPUT ..... 68
- DIVIDE** ..... 38
- DROP SENSOR** ..... 69
- Dubbing** ..... 40
- DVDDirect Express** ..... 48
- DVD writer** ..... 48, 50
- E**
- EMPTY ..... 66
  - EXPOSURE ..... 60
  - External media ..... 45
- F**
- FACE DETECTION ..... 61, 75
  - Face Index ..... 31
  - FADER ..... 58
  - FILE NO. .... 63
  - Film Roll Index ..... 30
  - FIREWORKS ..... 58
  - FOCUS ..... 60
  - Format ..... 66
  - Fully charged ..... 11
- G**
- GENERAL SET ..... 67
  - GUIDEFRAAME ..... 61
- H**
- HQ ..... 25
- I**
- IMAGE SIZE ..... 63
  - INDOOR ..... 59
  - “InfoLITHIUM” battery pack ..... 84
  - Internal hard disk ..... 17
- L**
- LANDSCAPE ..... 58
  - LANGUAGE SET ..... 16, 68
  - LCD BL LEVEL ..... 67
  - LCD BRIGHT ..... 67
  - LCD COLOR ..... 68
  - LP ..... 25
- M**
- Maintenance ..... 83
  - MANAGE MEDIA ..... 66
- MANUAL SETTINGS** ..... 58
- MEDIA FORMAT** ..... 66
- MEDIA INFO** ..... 66
- MEDIA SETTINGS** ..... 17
- Memory card** ..... 18
- “Memory Stick” media ..... 19, 83
- “Memory Stick PRO-HG Duo” media ..... 19, 83
- “Memory Stick PRO Duo” media ..... 18, 83
- Menus ..... 53, 56
- MICREF LEVEL** ..... 62
- Mirror mode** ..... 26
- Moisture condensation** ..... 85
- MOVIE DUB** ..... 40
- MOVIE MEDIA SET** ..... 17
- Movies** ..... 21, 27
- MY MENU** ..... 53
- MY MENU SETTING** ..... 53
- O**
- ONE PUSH ..... 59
  - Operation beeps ..... 15
  - Operation flow ..... 5
  - OPTION MENU ..... 55
  - Original ..... 40
  - OTHER REC SET ..... 62
  - OTHERS ..... 65
  - OTHER SETTINGS ..... 69
  - OUTDOOR ..... 59
  - OUTPUT SETTINGS ..... 68
- P**
- PAL ..... 81
  - PHOTO CAPTURE ..... 39
  - PHOTO COPY ..... 41
  - PHOTO MEDIA SET ..... 18
  - Photos ..... 23, 27
  - PHOTO SETTINGS ..... 63
  - PLAYBACK ..... 64
  - Playback ..... 27
  - PLAYBACK SET ..... 64
  - Playlist ..... 43
  - PLAYLIST EDIT ..... 65
  - PORTRAIT ..... 58

Power on.....	14
POWER SETTINGS.....	68
Precautions.....	83
PROTECT.....	37

## R

REC MODE.....	25
Recording.....	21
Recording media.....	17
Recording time of movies/ number of recordable photos.....	79
Repair.....	70
REPAIR IMG.DB F.....	77
RESET.....	91

## S

Saving images in external media .....	45
SCENE SELECTION.....	58, 75
Screen indicators.....	89
Self-diagnosis display/Warning indicators.....	75
SELF-TIMER.....	63
Setting the date and time.....	14
SHOOTING SET.....	61
Slide show.....	32
SLIDE SHOW SET.....	32
SNOW.....	58
SOUND/DISP SET.....	67
SP.....	25
SPORTS.....	58
SPOTLIGHT.....	58
STEADYSHOT.....	61
SUMMERTIME.....	68
SUNRISE&SUNSET.....	58
Supplied items.....	2

## T

TELE MACRO.....	60
Telephoto.....	25
Thumbnail.....	35
Tripod.....	92
Troubleshooting.....	70
Turning the power on.....	14
TV.....	33

TV color systems.....	81
TV TYPE.....	33
TWILIGHT.....	58

## U

USB cable.....	48, 50
USB CONNECT.....	48, 50

## V

VBR.....	79
VIDEO LIGHT.....	26
VIEW IMAGES.....	27, 30
VISUAL INDEX.....	27
Volume.....	28, 67

## W

Wall outlet (wall socket).....	11
Warning messages.....	76
WHITE BAL.....	59
WHITE FADER.....	59
Wide angle.....	25
WIDE SELECT.....	62

## Z

Zoom.....	25
-----------	----

Additional information on this product and answers to frequently asked questions can be found at our Customer Support Website.

<http://www.sony.net/>

Download from [Www.Somanuals.com](http://www.Somanuals.com). All Manuals Search And Download.

## Free Manuals Download Website

<http://myh66.com>

<http://usermanuals.us>

<http://www.somanuals.com>

<http://www.4manuals.cc>

<http://www.manual-lib.com>

<http://www.404manual.com>

<http://www.luxmanual.com>

<http://aubethermostatmanual.com>

Golf course search by state

<http://golfingnear.com>

Email search by domain

<http://emailbydomain.com>

Auto manuals search

<http://auto.somanuals.com>

TV manuals search

<http://tv.somanuals.com>