

Form 19884

(442)

Printed in U. S. A.

LIST OF PARTS



FOR FAMILY SHOPS

MACHINE No. 99-24

THE SINGER MANUFACTURING COMPANY

INDEX

	Page
Accessory.....	16
Attachment Set.....	16
Bias Gauge.....	17
Bobbin Winder.....	17
Braider.....	17
Controllers (Foot).....	15
Controllers (Knee).....	14
Feed Cover Plates.....	17
Finger Guard.....	18
Hemmers (Foot).....	18
Machine No. 99-24.....	7
Needle Threader (Universal).....	18
Numerical List of Parts.....	21
Quilter.....	19
Ruffler Shirring Plate (Universal).....	19
Presser Feet.....	18
Presser Foot with Graduated Adjustable Guides.....	18
Series BY14 Motors.....	11
Series BY15 Motors.....	13
Special Attachments.....	20
Spotlight.....	15
Spotlight Lamp.....	16
Stiletto.....	19
Under Braider.....	19

INSTRUCTIONS FOR ORDERING

In ordering from this list, use ONLY the part NUMBER in the FIRST column.

The number stamped on a Sewing Machine Part is in every case the number of the single part only.

Every combination of parts sent out as such has its specific number, which, although not stamped on the parts, must be used when ordering the combination.

Each number always indicates the SAME PART in whatever list it appears, or for whatever machine.

The letters after some of the numbers indicate the style of finish only, as follows:

- A-Hardened, Polished, Nickel Plated and Buffed
- A.A-Buffed and Chromium Plated
- A.B-Hardened, Polished, Buffed and Chromium Plated
- A.C-Brown Baking Enamel Finish
- A.D-Gray Baking Enamel Finish
- A.E-Hardened, Bright Rumbled and Nickel Plated
- A.F-Hardened, Bright Rumbled, Nickel Plated, Bright Rumbled and Chromium Plated
- A.G-Alumilite, Plain
- A.H-Alumilite, Dyed
- A.J-Polished, Nickel Plated and Chromium Plated
- A.K-Hardened, Polished, Nickel Plated and Chromium Plated
- A.L-Heat Treated for Toughness
 - B-Polished, Nickel Plated and Buffed
 - C-Hardened Only
- C.R-Hardened and Merlized
 - D-Polished Only
 - E-Soft, Not Polished
 - F-Hardened and Polished
- F.J-Hardened, Polished and Nickel Plated
 - G-Bright Rumbled and Nickel Plated
- H-Blued
- J-Nickel Plated Only
- K-Hardened and Nickel Plated
- L-Brass Plated
- M-Oxidized
- N-Japanned, Dull
- P-Japanned, Bright
- P.P-Wrinkle Finish
 - R-Merlized
 - S-Cadmium Plated
 - T-Copper Plated
- T.A-Hardened, Polished, Copper and Nickel Plated and Buffed
- T.B-Copper and Nickel Plated and Polished
- T.J-Copper and Nickel Plated Only
- T.K-Hardened, Copper and Nickel Plated
- T.L-Copper and Brass Plated
- T.M-Copper Plated and Oxidized

INSTRUCTIONS FOR ORDERING - Continued

- U-Zinc Plated
- V-Silver Plated
- W-Polished and Nickel Plated
- X-Black Oxide, for Iron and Steel
- X.C-Hardened and Black Oxide, for Iron or Steel
- Y-Black Nickel Plated Only
- Z-Chromium Plated
- Z.A-Hardened, Polished, Nickel Plated, Buffed and Chromium Plated
- Z.B-Polished, Nickel Plated, Buffed and Chromium Plated
- Z.C-Hardened and Chromium Plated
- Z.D-Polished and Chromium Plated
- Z.G-Bright Rumbled, Nickel Plated, Bright Rumbled and Chromium Plated
- Z.J-Nickel and Chromium Plated
- Z.T-Copper and Chromium Plated

These letters MUST BE USED when they appear in the list; and AFTER the number as in the list.

In this series:

- 1 to 1500, 50001 to 51500 and 140001 to 142000 are Screw Numbers
- 1501 to 1800 and 51501 to 51800 are Nut Numbers
- 1801 to 2000 and 51801 to 52000 are Roller Numbers
- 2001 to 50000 and 52001 to 140000 and 142001 to 190000 are Sewing Machine Parts, 190001 and upward are numbers of Electrical Parts.

The figures in the second column refer only to the plates, illustrating the parts, and are NOT TO BE USED in ordering.

Parts marked with an asterisk (*) are furnished only when repairs are made at factory.

LIST OF PARTS COMPLETE
FOR

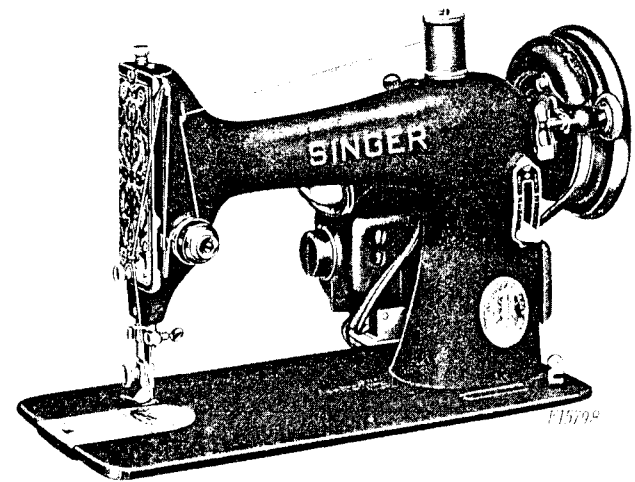

MACHINE No. 99-24

FOR FAMILY USE. LOCK STITCH. DROP FEED
MACHINE. ELECTRIC DRIVE ON PORTABLE SET NO. 195
OR NO. 201.

Genuine Singer Needles should be used
in Singer Machines.
These Needles and their Containers
are marked with the
Company's Trade Mark "SIMANCO." 1

Needles in Containers marked
"For Singer Machines"
are not Singer made needles. 2

No.	Plate	Name
*33680	-----	Arm with 448K, 15404, 32503 and two 15405.....
2002	22693	Arm Dowel Pin (2).....
33602R	22692	" Rock Shaft with 905E.....
33661	-----	" " " 33602R with 1216C and 1520R.....
905E	22692	Arm Rock Shaft Adjusting Screw.....
50046C	22692	" " " Screw Center (lower)..
33666	-----	50046C with 1512R.....
1512R	22692	Arm Rock Shaft Screw Center (lower) Nut.....
50047C	22692	Arm Rock Shaft Screw Center (upper)..
138E	22693	Arm Screw (3).....
33603	22692	Arm Shaft.....
33662	-----	Arm Shaft 33603 with 32503 and 33615.
32503	22692	" " Bushing.....
448K	22692	" " " Set Screw.....
2007	22692	" Spool Pin.....
8879	22692	" " Washer (cloth).....
32672	22692	Balance Wheel, 3 1/4 in. pulley.....
*33681	-----	Bed.....

No.	Plate	Name
226J	22694	Oscillating Hook Slide Friction Spring Screw.....
33619E	22695	Presser Bar (hollow).....
33620AE	22695	" " Lifter.....
33621	22695	" " Hinge Pin.....
33667E	22695	" " Lifting Bracket with 50052E.....
33669	-----	Presser Bar Lifting Bracket 33667E with 33676.....
33677	-----	Presser Bar Lifting Bracket 33669 with 240E, 33674 and 33675.....
50052E	22695	Presser Bar Lifting Bracket Clamping Screw.....
33623	22695	Presser Bar Spring.....
33672	-----	" " 33623 with 33624..
32666	22695	" Foot.....
51224W	22695	" Thumb Screw.....
50054W	22695	Pressure Regulating Thumb Screw.....
33624	22695	" " Ex-tension Pin.....
33676	22695	Slack Thread Regulator.....
33682	22692	Stitch Indicator Plate.....
140202S	22692	" " Screw (2).....
2102	22694	Tension Disc (2).....
125310	22694	" Indicator.....
125311	22694	" Flange.....
51608J	22694	" Regulating Thumb Nut.....
125312	22694	" Releasing Disc.....
33659	22695	" Lever.....
33671	22695	" " Hinge Pin....
33660	22695	" " Spring.....
125313	22694	" Pin.....
140357J	22694	" Screw Stud.....
50305C	22694	" Set Screw.....
125314	22694	" Spring.....
33683	22694	Tension (graduated) complete, Nos. 32759, 33684, 51608J, 125310 to 125314, 140357J and two 2102.....
28075C	22695	Thread Cutter and Holder.....
33632	22695	" Guard (front of arm).....
237K	22695	" " Set Screw
8422	22694	" (head of arm).....
33634	22695	" Take-up Crank.....
1036AL	22692	" Set Screw.....
33635	22695	" Lever.....
33636	-----	Thread Take-up Lever complete, Nos. 33635, 33637 and 33638.....
33679	-----	Thread Take-up Lever 33636 with 33634, 33678, 50056C and 50057C.....
50056C	22695	Thread Take-up Lever Cap Screw.....
33637	22695	" Hinge Stud.....
33638	22695	" " Link.....
50057C	22695	" " Hinge Screw
33684	22694	" Spring.....
32759	22694	" " Regulator with 50305C.....
453AL	22694	Thread Take-up Spring Regulator Set Screw.....
32602	22694	Throat Plate for 32600.....
691A	22694	" Screw (2).....
33674	22695	Timing Gauge, for Setting the height of the Needle Bar and timing the Oscillating Hook.....
240E	22695	Timing Gauge Screw.....
33675	22695	" Washer.....
*15404	-----	Trade Mark.....
15405	-----	" Rivet (2).....

SERIES BY14 MOTORS

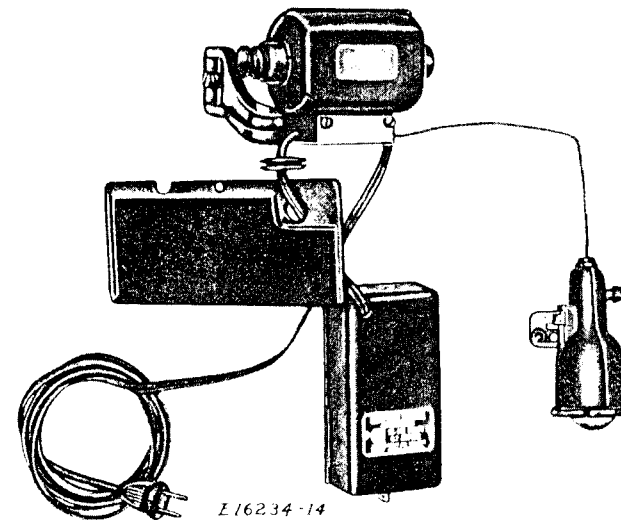

FOR PORTABLE CASE SET NO. 201

CHART FOR SERIES BY14 MOTORS

Volts	Cycles	Amperes	Motor Catalog No.
32	D.C.	1.4	BY14-3
50	D.C. and 25 to 75 Cycles A.C.	1.1	BY14-5
95-100	D.C. and 25 to 75 Cycles A.C.	0.6	BY14-6
100-110	D.C. and 25 to 75 Cycles A.C.	0.6	BY14-7
115-125	D.C. and 25 to 75 Cycles A.C.	0.5	BY14-8
100-110	80 to 100 Cycles A.C.	0.7	BY14-87

MOTOR PARTS

No.	Plate	Name
195249	-----	Armature complete for BY14-3 Motor...
		Armature complete for BY14-5 Motor...
		Armature complete for BY14-6 Motor...
195151	22696	Armature complete for BY14-7 Motor...
		Armature complete for BY14-8 Motor...
		Armature complete for BY14-87 Motor...
195153	22696	Armature Shaft Bearing (commutator end).....

CONTROLLERS (Knee)

FOR SERIES BY14 MOTORS FOR PORTABLE CASE

SET NO. 201

No.	Plate	Name
195165	-----	Controller (moulded) complete, for 32 to 55 volts, A.C. or D.C. Motor, Nos. 194426, 194491, 195176, 195177 and two 140102R.....
195166	9691	Controller (moulded) complete, for 95 to 145 volts, A.C. or D.C. Motor, Nos. 194492, 195175 to 195177 and two 140102R.....
194322	9691	Controller Base.....
194491	-----	Controller Base 194322 with 23258, 192211, 193908, 194422, 194479, 194774, 194775 and two each 140100R, 140103R, 194421, 194514 and 931090, for 195165.....
194492	-----	Controller Base 194322 with 23258, 192140, 193908, 194422, 194479, 194774, 194775 and two each 140100R, 140103R, 194421, 194514 and 931090, for 195166.....
50557R	9691	Controller Base Screw (3).....
194603	9691	" " Washer (3).....
194323	-----	" " Cover.....
195175	9691	" " 194323 with 991163 and two 964317, for 195166.....
194426	-----	Controller Cover 194323 with 899287 and two 964317, for 195165.....
140102R	9691	Controller Cover Screw (2).....
195177	9691	Controller Lead complete.....
193908	9691	" " Clamp.....
194479	9691	" " Insulation.....
195176	9691	" " Insulation.....
192211	-----	" " Resistance Unit for 32 to 55 volts.....
192140	9691	Controller Resistance Unit for 95 to 145 volts.....
194774	9691	Controller Resistance Unit Adjusting Nut.....
194775	9691	Controller Resistance Unit Adjusting Nut Lock Spring.....
194416	9691	Controller Resistance Unit Bell Crank
194324	9691	Controller Resistance Unit Bell Crank Connecting Link.....
140101C	9691	Controller Resistance Unit Bell Crank Connecting Link Hinge Screw.....
1607J	9691	Controller Resistance Unit Bell Crank Connecting Link Hinge Screw Nut..
51340C	9691	Controller Resistance Unit Bell Crank Hinge Screw.....
1607J	9691	Controller Resistance Unit Bell Crank Hinge Screw Nut.....
194421	9691	Controller Resistance Unit Bell Crank Spring (2).....
194402	9691	Controller Resistance Unit Bell Crank Spring Bracket.....
194422	-----	Controller Resistance Unit Bell Crank Spring Bracket 194402 with 51340C, 140101C, 194324, 194416, 194773 and two 1607J.....

No.	Plate	Name
140100R	9691	Controller Resistance Unit Bell Crank Spring Bracket Screw (2).....
194514	-----	Controller Resistance Unit Bell Crank Spring Bracket Screw Insulating Disc (2).....
194439	22700	Controller Resistance Unit Driver complete, Nos. 974F, 1700J, 192923, 194445 and two wood screws 5/8 in. No. 8 R.H.....
192923	22700	Controller Resistance Unit Driver Bell Crank.....
974F	22700	Controller Resistance Unit Driver Bell Crank Hinge Screw.....
1700J	22700	Controller Resistance Unit Driver Bell Crank Hinge Screw Nut.....
194445	22700	Controller Resistance Unit Driver Crank Connecting Link.....
50557R	22700	Controller Resistance Unit Driver Screw (2).....
194603	22700	Controller Resistance Unit Driver Screw Washer (2).....
140103R	9691	Controller Resistance Unit Screw (2).
931090	9691	Controller Resistance Unit Screw Washer (asbestos) (2).....
23258	9691	Controller Resistance Unit Screw Washer (steel).....
193384	9691	Controller Resistance Unit Short Circuiting Contact (2).....
51327J	9691	Controller Resistance Unit Short Circuiting Contact Screw (2).....
194773	9691	Controller Resistance Unit Yoke.....
192972	22700	Knee Lever.....
*991163	-----	Name Plate for 195166.....
*899287	-----	" " 195165.....
964317	-----	" " Drive Screw (2).....

CONTROLLERS (Foot)

FOR SERIES BY15 MOTORS

FOR PORTABLE CASE SET NO. 195

No.	Plate	Name
195181	-----	Controller (foot) complete, for 32 to 55 volts, A.C. or D.C. Motor....
195182	9354	Controller (foot) complete, for 95 to 145 volts, A.C. or D.C. Motor....
195184	9354	Controller Lead.....
194717	22696	" " Strain Relief.....

SPOTLIGHT

SPOTLIGHT NO. 195233

FOR SERIES BY14 AND BY15 MOTORS

No.	Plate	Name
195127	22697	Spotlight Body (lower half).....

SPOTLIGHT

No.	Plate	Name
195128	22697	Spotlight Body (upper half).....
195129	22697	" " Snap Ring (large).....
195130	22697	" " " (small).....
195224	22697	" Bracket.....
51463CR	22697	" " Screw.....
195148	22697	" Lamp.....
Note: When ordering No. 195148, state voltage required.		
195132	22697	Spotlight Lamp Socket.....
195136	22697	" Lead.....
195135	-----	Spotlight Lead with Lamp Socket complete, Nos. 195132, 195136 and 195141.....
195133	22697	Spotlight Lens (clear glass).....
195134	22697	" Tension Spring.....
195142	22697	" Switch Key.....
195143	22697	" " Snap Ring.....
195137	22697	" " Rotating Contact.....
195138	22697	" " " " Cam
195139	22697	" " " " Insulator.....
195140	22697	Spotlight Switch Spring Contact (lamp side).....
195141	22697	Spotlight Switch Spring Contact (lead side).....
195233	22697	Spotlight (clear glass Lens) complete, Nos. 177R, 51463CR, 195127 to 195130, 195133 to 195135, 195137 to 195140, 195142, 195143, 195148, 195224 and 701513.....
177R	22697	Spotlight Screw.....
701513	22697	" Retaining Washer.....

SPOTLIGHT LAMP

No.	Plate	Name
195148	22697	Spotlight Lamp.....
Note: When ordering No. 195148, state voltage required.....		

ACCESSORY

No.	Plate	Name
120862	9695	Oil Can, contents 1 1/3 fluid oz. (filled with household oil).....

ATTACHMENT SET

No.	Plate	Name
121461	9696	Binder Folder.....
121463	9696	" Foot.....
51104B	9696	" Screw.....
120565	9696	" Washer.....
121464	9696	Binder complete, Nos. 51104B, 120565, 121461 and 121463.....
32522	9696	Bobbin (four).....
36865	9696	Edge Stitcher.....
35931	9696	Hemmer (adjustable).....

ATTACHMENT SET

No.	Plate	Name
120842	9696	Hemmer (foot) 5/64 in. hem.....
-----	-----	Needle (six).....
121441	9696	Presser Foot (double toe) for gathering.....
25537	9696	Screw Driver (machine).....
120378	9696	" (shuttle tension).....
8879	9696	Spool Pin Washer (cloth).....
121898	-----	Attachment Set, Nos. 8879, 25537, 35931, 36865, 120378, 120842, 121441, 121464, four 32522 and six needles.....
120598	9696	Ruffler for one, six and twelve stitch ruffling.....
121899	9696	Attachment Set complete, Nos. 120598 and 121898.....

BIAS GAUGE

No.	Plate	Name
25525	9695	Bias Gauge.....

BOBBIN WINDER

(SEMI-AUTOMATIC)

No.	Plate	Name
15376	22699	Adjusting Arm.....
50058B	22699	" Screw.....
32673	22699	Bracket (belt cover).....
180B	22699	" Screw.....
32768	22699	Frame with Pulley and Spindle.....
50059B	22699	" Hinge Screw.....
15286	22699	" Spring.....
15287	22699	Friction Ring (rubber).....
32625	22699	Stop Latch.....
50230B	22699	" Hinge Screw.....
15291	22699	" Spring.....
32769	22699	Bobbin Winder (semi-automatic) complete, Nos. 15286, 15287, 15291, 15376, 32625, 32673, 32768, 50058B, 50059B and 50230B.....
32700	22699	Thread Guide.....
208J	22699	" Screw.....

BRAIDER

No.	Plate	Name
25510	22699	Braider.....
289B	22699	" Thumb Screw.....

FEED COVER PLATES

No.	Plate	Name
32622	9695	Feed Cover Plate (flat top) for art work.....
32589	9695	Feed Cover Plate (oval top) for art work.....

FINGER GUARD

No.	Plate	Name
121725	22699	Finger Guard.....

HEMMERS (Foot)

No.	Plate	Name
25904	23854	Hemmer (foot) 1/16 in. hem.....
36333	23854	" " 1/16 in. hem, for chiffon and silk.....
25911	23854	Hemmer (foot) 3/32 in. hem.....
25895	23854	" " 1/8 in. hem.....
35884	22699	" " 3/16 in. hem.....
25893	22699	" " 1/4 in. hem.....
36469	23854	" " 1/32 in. hem, for chiffon and silk (slotted for lace)..

NEEDLE THREADER (Universal)

No.	Plate	Name
121632	9695	Needle Threader (universal).....
121631	9695	" " Hook.....
140157J	9695	" " " Screw.....

PRESSER FOOT WITH GRADUATED
ADJUSTABLE GUIDES

No.	Plate	Name
121717	9695	Presser Foot with 36696.....
35002	9695	" " Extension.....
35003	9695	" " Graduated Adjustable Guide (long, left).....
35004	9695	Presser Foot Graduated Adjustable Guide (long, right).....
35005	9695	Presser Foot Graduated Adjustable Guide (short, right).....
35006	9695	Presser Foot Graduated Adjustable Guide (short, right) flush.....
35135	9695	Presser Foot Graduated Adjustable Guide Clamp.....
35206	9695	Presser Foot Graduated Adjustable Guide Clamp Lever.....
337J	9695	Presser Foot Graduated Adjustable Guide Clamp Screw.....
36696	9695	Presser Foot Graduated Adjustable Guide Clamp Steady Pin.....
121718	9695	Presser Foot with Extension and Graduated Adjustable Guides complete, Nos. 337J, 35002 to 35006, 35135, 35206 and 121717.....

PRESSER FEET

No.	Plate	Name
15429	22698	Presser Foot (left toe) for stitching on edge and inserting cord.....

PRESSER FEET

No.	Plate	Name
125035	22698	Presser Foot (right toe) for stitching on edge and inserting cord...
121875	22698	Presser Foot for 121877.....
140347W	22698	" " Adjusting Thumb Screw for 121877.....
121876	22698	Presser Foot Body for 121877.....
121877	22698	Presser Foot (adjustable for sewing either on the right or left side of the needle) complete, for cording and slide fastener, Nos. 121875, 121876 and 140347W.....
28831	23854	Presser Foot for darning.....
121614	22698	" " with 51282J and 121615, for blind stitch braiding, for soutache braid.....
121615	22698	Presser Foot Braid Guide.....
Note: When ordering No. 121614 or 121615, send sample of braid for which it is required.		
51282J	22698	Presser Foot Braid Guide Screw.....
36058	22698	" " with 665B and 36059, for blind stitch cording, to turn small curves.....
36059	22698	Presser Foot Cord Guide.....
Note: When ordering No. 36058 or 36059, send sample of cord for which it is required.		
665B	22698	Presser Foot Cord Guide Screw.....
36067	-----	" " for braiding, for art work, for braid 1/16 in. to 3/16 in. wide.....
Note: When ordering No. 36067, state the size or send a sample of braid for which it is required.		
25978	22698	Presser Foot (single toe) for gathering.....

QUILTER

No.	Plate	Name
35932	22699	Quilter.....

RUFFLER SHIRRING PLATE (Universal)

No.	Plate	Name
121170	22698	Ruffler Shirring Plate (universal) with 51395W.....
51395W	22698	Ruffler Shirring Plate Thumb Screw...

STILETTO

No.	Plate	Name
25539	22698	Stiletto.....

UNDER BRAIDER

No.	Plate	Name
121547	9695	Under Braider.....
25637	9695	" " Foot.....

SPECIAL ATTACHMENTS

FOR COMPONENT PARTS OF THESE ATTACHMENTS,
REFER TO FORM I9385, LIST OF PARTS FOR SINGER
FASHION AIDS.

No.	Plate	Name
121795	-----	Buttonhole Attachment complete.....
121094	-----	Darning Foot (spring) complete.....
26538	-----	Embroidery Attachment complete for one thread.....
35505	-----	Embroidery Attachment complete for two threads.....
121387	-----	Hemstitching and Picotting Attachment complete.....
121634	-----	Needle Threader and Seam Ripper com- plete.....
121255	-----	Singercraft Fagoter complete.....
121079	-----	Singercraft Guide complete.....
35985	-----	Tubular Trimming Attachment complete.
121706	-----	Zigzag Attachment (adjustable) com- plete.....

Genuine Singer Needles should be used
in Singer Machines.
These Needles and their Containers
are marked with the
Company's Trade Mark "SIMANCO." 1

Needles in Containers marked
"For Singer Machines"
are not Singer made needles. 2

NUMERICAL LIST OF PARTS

NUMERICAL LIST OF PARTS

No.	Plate	Name
44C	22693	Oscillating Hook Pitman Screw Stud (left).....
138E	22693	Arm Screw (3).....
175R	22693	Oscillating Hook Pitman Adjusting Screw for 33618R (2).....
177R	22697	Spotlight Screw for 195233.....
180B	22699	Bobbin Winder Bracket Screw.....
191C	22694	Feed Dog Screw.....
203J	22694	Face Plate Screw.....
208J	22699	Bobbin Winder Thread Guide Screw.....
216C	22692	Oscillating Hook Pitman Screw Stud (right) Cap Screw.....
226J	22694	Oscillating Hook Slide Friction Spring Screw.....
237K	22695	Thread Guard (front of arm) Set Screw
240E	22695	Timing Gauge Screw for 33677.....
248K	22692	Clamp Stop Motion Clamp Stop Screw for 32619.....
256W	22692	Clamp Stop Motion Clamp Screw for 32619 and 32639.....
289B	22699	Braider Thumb Screw.....
307C	22693	Feed Rock Shaft Screw Center for 56814 (2).....
315C	22693	Feed Bar Screw Center for 15445 (2)..
337J	9695	Presser Foot Graduated Adjustable Guide Clamp Screw for 121718.....
448K	22692	Arm Shaft Bushing Set Screw for 33680
453AL	22694	Thread Take-up Spring Regulator Set Screw.....
552C	22695	Needle Clamp Thumb Screw for 2054....
662F	23854	Oscillating Hook Bobbin Case Cushion Spring Screw for 32660.....
665B	22698	Presser Foot Cord Guide Screw for 36058.....
691A	22694	Throat Plate Screw (2).....
905E	22692	Arm Rock Shaft Adjusting Screw for 33602R.....
974F	22700	Controller Resistance Unit Driver Bell Crank Hinge Screw for 194439
1036AL	22692	Thread Take-up Crank Set Screw for 33615.....
1085E	22692	Feed Forked Connection Roller Screw Stud for 1832.....
1132C	23854	Oscillating Hook Connecting Link Hinge Screw.....
1134AL	22692	Needle Bar Crank Position Screw for 33615.....
1148AL	22692	Clamp Stop Motion Flanged Bushing Set Screw for 32619.....
1172F	23854	Oscillating Hook Bobbin Case Tension Regulating Screw for 32590.....
1173J	23854	Oscillating Hook Bobbin Case Tension Spring Screw for 32590.....
1216C	22692	Oscillating Hook Pitman Screw Stud (right) for 33661.....
1301C	22693	Feed Raising Bar Hinge Screw.....
1353AL	22695	Needle Bar Connecting Stud Set Screw for 33673.....
1381C	22692	Feed Forked Connection Hinge Screw (eccentric).....

NUMERICAL LIST OF PARTS

No.	Plate	Name
1485R	23854	Oscillating Hook Crank Clamping Screw for 32594R.....
1512R	22692	Arm Rock Shaft Screw Center (lower) Nut for 33666.....
1513R	22693	Feed Rock Shaft Screw Center Nut for 56814 (2).....
1519R	22693	Feed Bar Screw Center Nut for 15445 (2).....
1520R	22692	Feed Forked Connection Hinge Screw Nut.....
1520R	22692	Oscillating Hook Pitman Screw Stud (right) Nut for 33661.....
1607J	9691	Controller Resistance Unit Bell Crank Connecting Link Hinge Screw Nut for 194422.....
1607J	9691	Controller Resistance Unit Bell Crank Hinge Screw Nut for 194422.....
1700J	22700	Controller Resistance Unit Driver Bell Crank Hinge Screw Nut for 194439.....
1832	22692	Feed Forked Connection Roller with 1085E, for 33664.....
1944	22693	Feed Bar Roller and Stud for 32507R..
1944	22693	Feed Raising Bar Roller and Stud for 32510R.....
2002	22693	Arm Dowel Pin (2).....
2007	22692	Arm Spool Pin.....
2020	22692	Clamp Stop Motion Clamp Washer for 32619.....
2054	22695	Needle Clamp with 552C.....
2102	22694	Tension Disc for 33683 (2).....
8217	22692	Feed Regulator Friction Washer.....
9422	22694	Thread Guard (head of arm).....
8879	22692	Arm Spool Pin Washer (cloth).....
8879	9696	Spool Pin Washer (cloth) for 121898..
15286	22699	Bobbin Winder Frame Spring for 32769..
15287	22699	Bobbin Winder Friction Ring (rubber) for 32769.....
15291	22699	Bobbin Winder Stop Latch Spring for 32769.....
15376	22699	Bobbin Winder Adjusting Arm for 32769
*15404	-----	Trade Mark for 33680.....
15405	-----	" " Rivet for 33680 (2).....
15429	22698	Presser Foot (left toe) for stitching on edge and inserting cord.....
15445	-----	Feed Bar Screw Center 315C with 1519R (2).....
23258	9691	Controller Resistance Unit Screw Washer (steel) for 194491 and 194492.....
25510	22699	Braider.....
25525	9695	Bias Gauge.....
25537	9696	Screw Driver (machine) for 121898....
25539	22698	Stiletto.....
25637	9695	Under Braider Foot.....
25893	22699	Hemmer (foot) 1/4 in. hem.....
25895	23854	Hemmer (foot) 1/8 in. hem.....
25904	23854	Hemmer (foot) 1/16 in. hem.....
25911	23854	Hemmer (foot) 3/32 in. hem.....
25978	22698	Presser Foot (single toe) for gathering.....
26075C	22695	Thread Cutter and Holder.....
26538	-----	Embroidery Attachment complete for one thread.....

NUMERICAL LIST OF PARTS

No.	Plate	Name
28831	23854	Presser Foot for darning.....
32503	22692	Arm Shaft Bushing for 33662 and 33680
32507R	22693	Feed Bar with 1944.....
32510R	22693	Feed Raising Bar with 1944.....
32519	22695	Needle Stop Pin for 33655E.....
32520	23854	Oscillating Hook for 32626.....
32522	9696	Bobbin for 121898 (4).....
32522	23854	Oscillating Hook Bobbin.....
32528	23854	Oscillating Hook Bobbin Ejector Spring for 32660.....
32529R	23854	Oscillating Hook Connecting Link....
32567	23854	Oscillating Hook Bobbin Case Tension Spring for 32590.....
32569	22694	Oscillating Hook Slide.....
32570	22694	Oscillating Hook Slide Friction Spring.....
32589	9695	Feed Cover Plate (oval top) for art work.....
32590	23854	Oscillating Hook Bobbin Case with 1172F, 1173J and 32567, for 32626
32594R	23854	Oscillating Hook Crank with 1485R....
32598	23854	Oscillating Hook Bobbin Case Position Bracket Oil Pad (felt) for 32660..
32599	23854	Oscillating Hook Bobbin Case Position Bracket Oil Pad Holder for 32660..
32600	22694	Feed Dog, 12 teeth (16 teeth to the inch) for 32602.....
32602	22694	Throat Plate for 32600.....
32618E	22692	Clamp Stop Motion Flanged Bushing for 32619 and 32639.....
32619	-----	Clamp Stop Motion complete, Nos. 248K, 256W, 1148AL, 2020 and 32618E....
32622	9695	Feed Cover Plate (flat top) for art work.....
32625	22699	Bobbin Winder Stop Latch for 32769...
32626	-----	Oscillating Hook 32520 with 32590....
32639	-----	Clamp Stop Motion Flanged Bushing 32618E with 256W.....
32656R	22693	Oscillating Hook Bell Crank for 32657
32657	-----	Oscillating Hook Bell Crank 32656R with 50561C.....
32659	23854	Oscillating Hook Bobbin Case Position Bracket for 32660.....
32660	23854	Oscillating Hook Bobbin Case Position Bracket complete, Nos. 662F, 32528, 32598, 32599, 32659, 32661 to 32664, 50579D and 50580E.....
32661	23854	Oscillating Hook Bobbin Case Cushion Spring for 32660.....
32662	23854	Oscillating Hook Bobbin Case Position Bracket Hinge Stud for 32660....
32663	23854	Oscillating Hook Bobbin Case Position Bracket Latch for 32660.....
32664	23854	Oscillating Hook Bobbin Ejector for 32660.....
32666	22695	Presser Foot.....
32672	22692	Balance Wheel, 3 1/4 in. pulley.....
32673	22699	Bobbin Winder Bracket (belt cover) for 32769.....
32688	22692	Feed Regulator.....
32700	22699	Bobbin Winder Thread Guide.....
32759	22694	Thread Take-up Spring Regulator with 50305C for 33683.....
32768	22699	Bobbin Winder Frame with Pulley and Spindle for 32769.....

NUMERICAL LIST OF PARTS

No.	Plate	Name
32769	22699	Bobbin Winder (semi-automatic) complete, Nos. 15286, 15287, 15291, 15376, 32625, 32673, 32768, 50056B, 50059B and 50230B.....
33602R	22692	Arm Rock Shaft with 905E, for 33661..
33603	22692	Arm Shaft for 33662.....
33609R	22692	Feed Forked Connection for 33664.....
33611R	22693	Feed Rock Shaft.....
33613	22695	Needle Bar Connecting Link for 33678,
33615	22692	Needle Bar Crank with 1036AL and 1134AL, for 33662.....
33618R	22693	Oscillating Hook Pitman with two 175R
33619E	22695	Presser Bar (hollow).....
33620AE	22695	Presser Bar Lifter.....
33621	22695	Presser Bar Lifter Hinge Pin.....
33623	22695	Presser Bar Spring for 33672.....
33624	22695	Pressure Regulating Thumb Screw Extension Pin for 33672.....
33632	22695	Thread Guard (front of arm).....
33634	22695	Thread Take-up Crank for 33679.....
33635	22695	Thread Take-up Lever for 33636.....
33636	-----	Thread Take-up Lever complete, for 33679, Nos. 33635, 33637 and 33638.....
33637	22695	Thread Take-up Lever Hinge Stud for 33636.....
33638	22695	Thread Take-up Lever Link for 33636..
33654	22694	Face Plate 33663G with 125423.....
33655E	22695	Needle Bar with 32519.....
33657R	22695	Needle Bar Hole Plug.....
33659	22695	Tension Releasing Lever.....
33660	22695	Tension Releasing Lever Spring.....
33661	-----	Arm Rock Shaft 33602R with 1216C and 1520R.....
33662	-----	Arm Shaft 33603 with 32503 and 33615,
33663G	22694	Face Plate for 33654.....
33664	-----	Feed Forked Connection 33609R with 1832.....
33666	-----	Arm Rock Shaft Screw Center (lower) 50046C with 1512R.....
33667E	22695	Presser Bar Lifting Bracket with 50052E, for 33669.....
33669	-----	Presser Bar Lifting Bracket 33667E with 33676 for 33677.....
33671	22695	Tension Releasing Lever Hinge Pin.....
33672	-----	Presser Bar Spring 33623 with 33624..
33673	22695	Needle Bar Connecting Stud with 1353AL, for 33678.....
33674	22695	Timing Gauge, for setting the height of the Needle Bar and timing the Oscillating Hook for 33677.....
33675	22695	Timing Gauge Screw Washer for 33677..
33676	22695	Slack Thread Regulator for 33669.....
33677	-----	Presser Bar Lifting Bracket 33669 with 240E, 33674 and 33675.....
33678	-----	Needle Bar Connecting Link 33613 with 33673, for 33679.....
33679	-----	Thread Take-up Lever 33636 with 33634 33678, 50056C and 50057C.....
*33680	-----	Arm with 448K, 15404, 32503 and two 15405.....
*33681	-----	Bed.....
33682	22692	Stitch Indicator Plate.....

NUMERICAL LIST OF PARTS

No.	Plate	Name
33683	22694	Tension (graduated) complete, Nos. 32759, 33684, 51608J, 125310 to 125314, 140357J and two 2102.....
33684	22694	Thread Take-up Spring for 33683.....
35002	9695	Presser Foot Extension for 121718....
35003	9695	Presser Foot Graduated Adjustable Guide (long, left) for 121718....
35004	9695	Presser Foot Graduated Adjustable Guide (long, right) for 121718....
35005	9695	Presser Foot Graduated Adjustable Guide (short, right) for 121718..
35006	9695	Presser Foot Graduated Adjustable Guide (short, right) flush for 121718.....
35135	9695	Presser Foot Graduated Adjustable Guide Clamp for 121718.....
35206	9695	Presser Foot Graduated Adjustable Guide Clamp Lever for 121718.....
35505	-----	Embroidery Attachment complete, for two threads.....
35884	22699	Hemmer (foot) 3/16 in. hem.....
35931	9696	Hemmer (adjustable) for 121898.....
35932	22699	Quilter.....
35985	-----	Tubular Trimming Attachment complete.
36058	22698	Presser Foot with 665B and 36059, for blind stitch cording to turn small curves.....
36059	22698	Presser Foot Cord Guide for 36058....
		Note: When ordering No. 36058 or 36059 send sample of cord for which it is required.
36067	-----	Presser Foot for braiding, for art work, for braid 1/16 in. to 3/16 in. wide.....
		Note: When ordering No. 36067 state the size or send a sample of braid for which it is required.
36333	23854	Hemmer (foot) 1/16 in. hem, for chiffon and silk.....
36469	23854	Hemmer (foot) 1/32 in. hem, for chiffon and silk (slotted for lace)..
36696	9695	Presser Foot Graduated Adjustable Guide Clamp Steady Pin for 121717
36865	9696	Edge Stitcher for 121898.....
50046C	22692	Arm Rock Shaft Screw Center (lower) for 33666.....
50047C	22692	Arm Rock Shaft Screw Center (upper)..
50052E	22695	Presser Bar Lifting Bracket Clamping Screw for 33667E.....
50054W	22695	Pressure Regulating Thumb Screw.....
50056C	22695	Thread Take-up Lever Cap Screw for 33679.....
50057C	22695	Thread Take-up Lever Link Hinge Screw for 33679.....
50058B	22699	Bobbin Winder Adjusting Arm Screw for 32769.....
50059B	22699	Bobbin Winder Frame Hinge Screw for 32769.....
50230B	22699	Bobbin Winder Stop Latch Hinge Screw for 32769.....
50305C	22694	Tension Screw Stud Set Screw for 32759.....
50557R	9691	Controller Base Screw for use with Portable Case Set No. 201 (3)....
50557R	22700	Controller Resistance Unit Driver Screw for use with Portable Case Set No. 201 (2).....

No.	Plate	Name
50561C	22693	Oscillating Hook Bell Crank Hinge Screw for 32657.....
50579D	23854	Oscillating Hook Bobbin Case Position Bracket Latch Screw for 32660....
50580E	23854	Oscillating Hook Bobbin Ejector Hinge Screw Stud for 32660.....
50611J	23854	Oscillating Hook Bobbin Case Position Bracket Hinge Stud Set Screw.....
50684W	22694	Face Plate Thumb Screw.....
51045AL	22693	Machine Hinge Connection Set Screw (2).....
51104B	9696	Binder Screw for 121464.....
51207AL	22696	Pulley Position Screw.....
51224W	22695	Presser Foot Thumb Screw.....
51282J	22698	Presser Foot Braid Guide Screw for 121614.....
51295E	22692	Feed Regulator Hinge Screw.....
51327J	9691	Controller Resistance Unit Short Circuiting Contact Screw (2).....
51340C	9691	Controller Resistance Unit Bell Crank Hinge Screw for 194422.....
51395W	22698	Ruffler Shirring Plate Thumb Screw for 121170.....
51463CR	22697	Spotlight Bracket Screw for 195233...
51608J	22694	Tension Regulating Thumb Nut for 33683.....
56814	-----	Feed Rock Shaft Screw Center 307C with 1513R (2).....
120378	9696	Screw Driver (shuttle tension) for 121898.....
120565	9696	Binder Screw Washer for 121464.....
120598	9696	Ruffler for one, six and twelve stitch ruffling for 121899.....
120842	9696	Hemmer (foot) 5/64 in. hem for 121898
120862	9695	Oil Can, contents 1 1/3 fluid oz. (filled with household oil) Accessory.....
121079	-----	Singercraft Guide complete.....
121094	-----	Darning Foot (spring) complete.....
121170	22698	Ruffler Shirring Plate (universal) with 51395W.....
121255	-----	Singercraft Fagoter complete.....
121387	-----	Hemstitching and Picoting Attachment complete.....
121441	9696	Presser Foot (double toe) for gathering for 121898.....
121461	9696	Binder Folder for 121464.....
121463	9696	Binder Foot for 121464.....
121464	9696	Binder complete for 121898, Nos. 51104B, 120565, 121461 and 121463
121547	9695	Under Braider.....
121614	22698	Presser Foot with 51282J and 121615, for blind stitch braiding, for soutache braid.....
121615	22698	Presser Foot Braid Guide for 121614..
Note:		When ordering No. 121614 or 121615 send sample of braid for which it is required.
121631	9695	Needle Threader Hook.....
121632	9695	Needle Threader (universal).....
121634	-----	Needle Threader and Seam Ripper complete.....
121706	-----	Zigzag Attachment (adjustable) complete.....
121717	9695	Presser Foot with 36696, for 121718..

No.	Plate	Name
121718	9695	Presser Foot with Extension and Graduated Adjustable Guides complete, Nos. 337J, 35002 to 35006, 35135, 35206 and 121717.....
121725	22699	Finger Guard.....
121795	-----	Buttonhole Attachment complete.....
121875	22698	Presser Foot for 121877.....
121876	22698	Presser Foot Body for 121877.....
121877	22698	Presser Foot (adjustable for sewing either on the right or left side of the needle) complete, for cording and slide fastener, Nos. 121875, 121876 and 140347W.....
121898	-----	Attachment Set for 121899, Nos. 8879, 25537, 35931, 36865, 120378, 120842, 121441, 121464, four 32522 and six needles.....
121899	9696	Attachment Set complete, Nos. 120598 and 121898.....
125035	22698	Presser Foot (right toe) for stitching on edge and inserting cord... Tension Indicator for 33683.....
125310	22694	Flange for 33683...
125311	22694	" Releasing Disc for 33683.....
125312	22694	" " Pin for 33683.....
125313	22694	" Spring for 33683.....
125314	22694	Face Plate Thread Guard for 125423...
125422G	22694	Face Plate Thread Guard 125422G with 125424, for 33654.....
125423	-----	Face Plate Thread Guard Rivet for 125423.....
125424	22694	Controller Resistance Unit Bell Crank Spring Bracket Screw for 194491 and 194492 (2).....
140100R	9691	Controller Resistance Unit Bell Crank Connecting Link Hinge Screw for 194422.....
140101C	9691	Controller Resistance Unit Bell Crank Connecting Link Hinge Screw for 194422.....
140102R	9691	Controller Cover Screw for 195165 and 195166 (2).....
140103R	9691	Controller Resistance Unit Screw for 194491 and 194492 (2).....
140157J	9695	Needle Threader Hook Screw.....
140202S	22692	Stitch Indicator Plate Screw (2).....
140329CR	22696	Motor Screw.....
140347W	22698	Presser Foot Adjusting Thumb Screw for 121877.....
140354R	22696	Motor Bracket and Terminal Box Cover Screw (2).....
140357J	22694	Tension Screw Stud for 33683.....
190058	22696	Motor Screw Retaining Washer.....
190059	22696	Commutator complete.....
190083	22696	Brush Spring (2).....
190563	22696	Field Coil Retainer (2).....
190613	22696	Motor Lubricant (tube).....
190782	22696	Brush (carbon) (2).....
191097	22696	Armature Shaft Thrust Washer (pulley end) 1/64" fibre.....
191098	22696	Armature Shaft Thrust Washer (pulley end) peerless paper.....
192140	9691	Controller Resistance Unit for 95 to 145 volts for 194492.....
192211	-----	Controller Resistance Unit for 32 to 55 volts for 194491.....
192923	22700	Controller Resistance Unit Driver Bell Crank for 194439.....

No.	Plate	Name
192972	22700	Knee Lever for use with Portable Case Set No. 201.....
193231	22696	Pulley (moulded).....
193236	22696	Fan.....
193384	9691	Controller Resistance Unit Short Circuiting Contact (2).....
193771	-----	Field Coil Insulation.....
193908	9691	Controller Lead Clamp for 194491 and 194492.....
194322	9691	Controller Base for 194491 and 194492
194323	-----	Cover for 194426 and 195175.....
194324	9691	Controller Resistance Unit Bell Crank Connecting Link for 194422.....
194402	9691	Controller Resistance Unit Bell Crank Spring Bracket for 194422.....
194416	9691	Controller Resistance Unit Bell Crank for 194422.....
194421	9691	Controller Resistance Unit Bell Crank Spring for 194491 and 194492 (2).....
194422	-----	Controller Resistance Unit Bell Crank Spring Bracket 194402 with 51340C, 140101C, 194324, 194416, 194773 and two 1607J, for 194491 and 194492.....
194426	-----	Controller Cover 194323 with 89287 and two 964317, for 195165.....
194439	22700	Controller Resistance Unit Driver complete, for use with Portable Case Set No. 201, Nos. 974F, 1700J, 192923, 194445 and two wood screw screws 5/8 in. No. 8 R.H.....
194445	22700	Controller Resistance Unit Driver Crank Connecting Link for 194439.....
194479	9691	Controller Lead Clamp Insulation for 194491 and 194492.....
194491	-----	Controller Base 194322 with 23258, 192211, 193908, 194422, 194479, 194774, 194775 and two each 140100R, 140103R, 194421, 194514 and 931090, for 195165.....
194492	-----	Controller Base 194322 with 23258, 192140, 193908, 194422, 194479, 194774, 194775 and two each 140100R, 140103R, 194421, 194514 and 931090, for 195165.....
194514	-----	Controller Resistance Unit Bell Crank Spring Bracket Screw Insulating Disc for 194491 and 194492 (2).....
194603	9691	Controller Base Screw Washer (3).....
194603	22700	Controller Resistance Unit Driver Screw Washer (2).....
194716	22696	Lead Cord (8 ft. long) complete, from Terminal Box to Socket.....
194717	22696	Controller Lead Strain Relief.....
194717	22696	Lead Strain Relief (3).....
194773	9691	Controller Resistance Unit Yoke for 194422.....
194774	9691	Controller Resistance Unit Adjusting Nut for 194491 and 194492.....
194775	9691	Controller Resistance Unit Adjusting Nut Lock Spring for 194491 and 194492.....
195127	22697	Spotlight Body (lower half) for 195233.....

No.	Plate	Name
195128	22697	Spotlight Body (upper half) for 195233.....
195129	22697	Spotlight Body Snap Ring (large) for 195233.....
195130	22697	Spotlight Body Snap Ring (small) for 195233.....
195132	22697	Spotlight Lamp Socket for 195135.....
195133	22697	Spotlight Lens (clear glass) for 195233.....
195134	22697	Spotlight Lens Tension Spring for 195233.....
195135	-----	Spotlight Lead with Lamp Socket complete, for 195233, Nos. 195132, 195136 and 195141.....
195136	22697	Spotlight Lead for 195135.....
195137	22697	Spotlight Switch Rotating Contact for 195233.....
195138	22697	Spotlight Switch Rotating Contact Cam for 195233.....
195139	22697	Spotlight Switch Rotating Contact Cam Insulator for 195233.....
195140	22697	Spotlight Switch Spring Contact (lamp side) for 195233.....
195141	22697	Spotlight Switch Spring Contact (lead side) for 195135.....
195142	22697	Spotlight Switch Key for 195233.....
195143	22697	Spotlight Switch Key Snap Ring for 195233.....
195148	22697	Spotlight Lamp for 195233.....
		Note: When ordering No. 195148, state voltage required.
195151	22696	Armature complete, for BY14-7 and BY15-7 Motors.....
195152	22696	Armature Shaft Bearing (pulley end).....
195153	22696	Armature Shaft Bearing (commutator end).....
195154	22696	Field Core complete.....
195155	22698	Brush Cap (moulded) (2).....
195156	22696	Motor Housing (right side).....
195158	22696	Motor Housing Snap Ring (2).....
195160	22696	Field Coils complete, for BY14-7 and BY15-7 Motors.....
195164	22696	Motor Screw Washer.....
195165	-----	Controller (moulded) complete, for 32 to 55 Volts A.C. or D.C. Motor, for Series BY14 Motors for Portable Case Set No. 201, Nos. 194426, 194491, 195176, 195177 and two 140102R.....
195166	9691	Controller (moulded) complete for 95 to 145 volts, A.C. or D.C. Motor, for Series BY14 Motors, for Portable Case Set No. 201, Nos. 194492, 195175 to 195177 and two 140102R.....
195175	9691	Controller Cover 194323 with 991163 and two 964317, for 195165.....
195176	9691	Controller Lead Insulation for 195165 and 195166.....
195177	9691	Controller Lead complete, for 195165 and 195166.....
195181	-----	Controller (foot) complete, for 32 to 55 volts A.C. or D.C. Motor, for Series BY15 Motors, for Portable Case Set No. 195.....

NUMERICAL LIST OF PARTS

No.	Plate	Name
195182	9354	Controller (foot) complete, for 95 to 145 volts A.C. or D.C. Motor, for Series BY15 Motors, for Portable Case Set No. 195.....
195184	9354	Controller Lead for use with 195181 and 195182.....
195204	22696	Brush Cap Tension Spring (2).....
195205	22696	Brush Cap Tension Spring Insulating Washer (2).....
195224	22697	Spotlight Bracket for 195233.....
195233	22697	Spotlight (clear glass lens) complete, for Series BY14 and BY15 Motors, Nos. 177R, 51463CR, 195127 to 195130, 195133 to 195135, 195137 to 195140, 195142, 195143, 195148, 195224 and 701513.....
195235	22696	Motor Housing (left side) for BY14-7 Motor.....
195236	-----	Motor Housing (left side) for BY15-7 Motor.....
195249	-----	Armature complete, for BY14-3 and BY15-3 Motors.....
195250	-----	Field Coils complete, for BY14-3 and BY15-3 Motors.....
195268	22696	Motor Bracket and Terminal Box Cover.
198651	22696	Belt (moulded).....
701400	22696	Armature Shaft Thrust Washer (commutator end) 1/32" fibre.....
701513	22697	Spotlight Screw Retaining Washer for 195233.....
876363	22696	Lead Connector (large) (2).....
*899287	-----	Name Plate for 195165.....
931090	9691	Controller Resistance Unit Screw Washer (asbestos) for 194491 and 194492 (2).....
964317	-----	Name Plate Drive Screw for 194426 and 195175 (2).....
965105	22696	Lead Connector (small).....
*991163	-----	Name Plate for 195166.....

ILLUSTRATIONS OF PARTS

195182

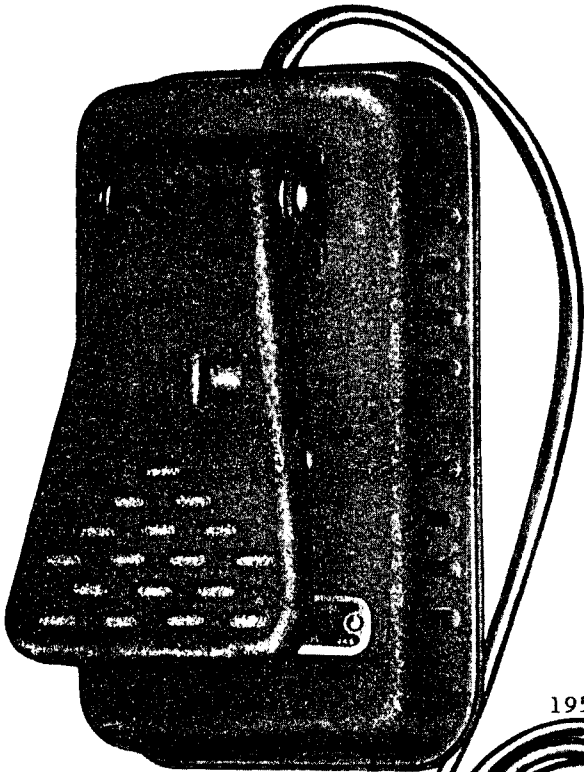

195184

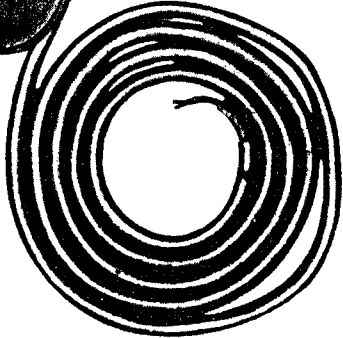

9691 - 1/2

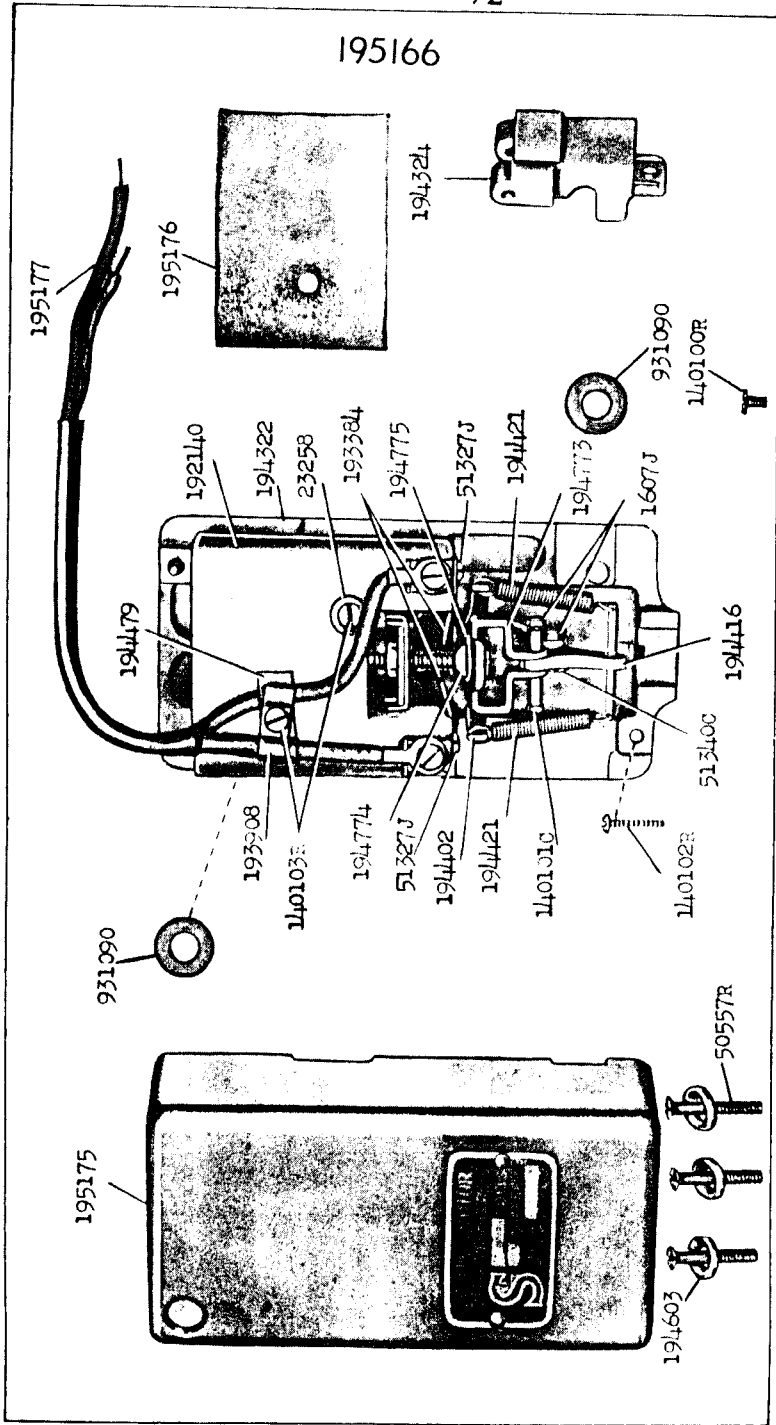

9695 - 2/3

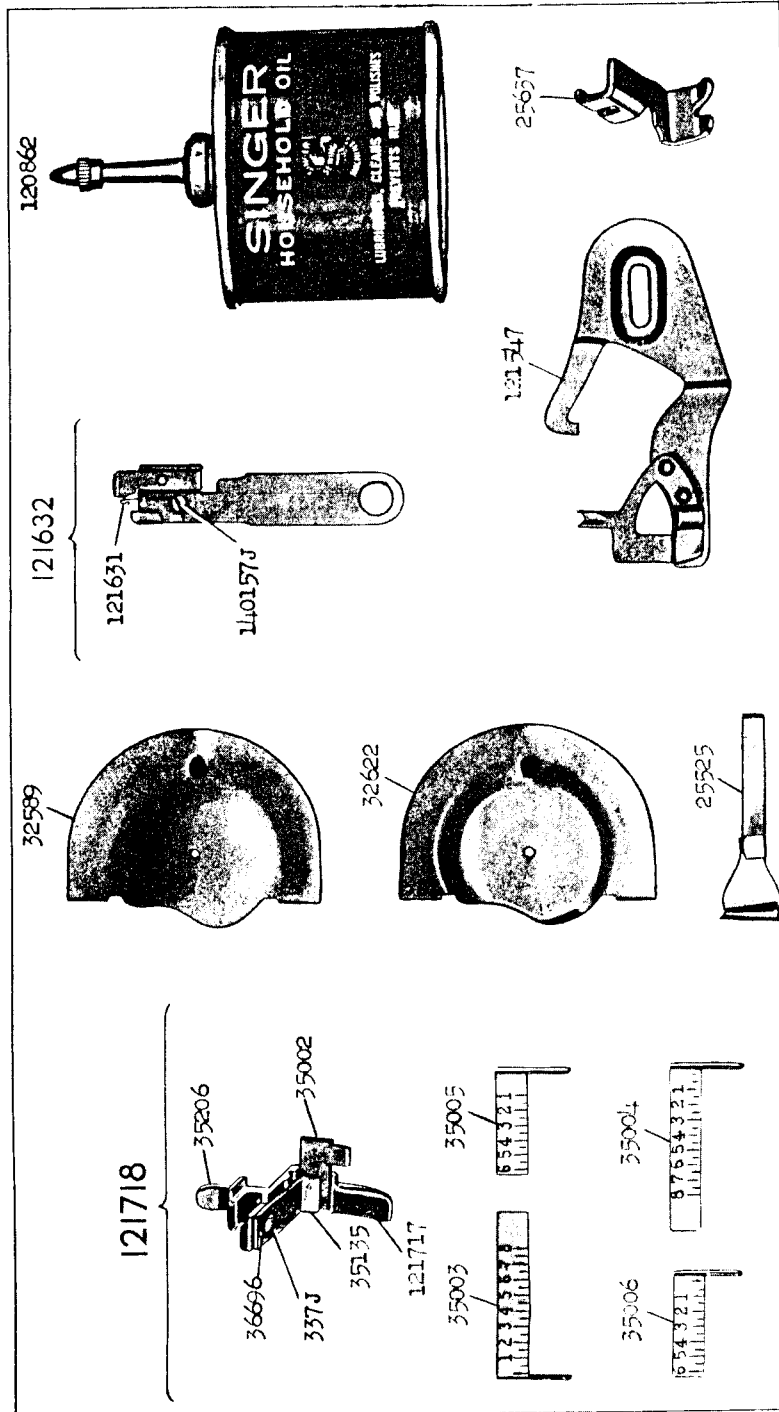

9696 - 1/2

121899

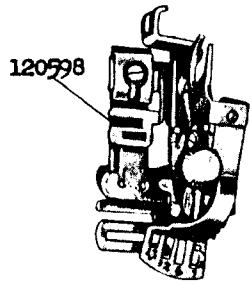

120998

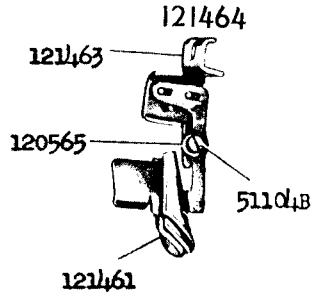

121463

120565

121464

51104B

121461

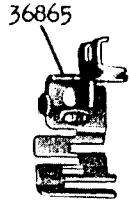

36865

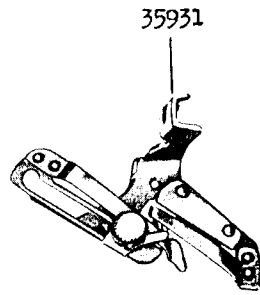

35931



120842

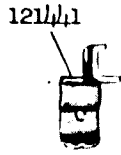

121441

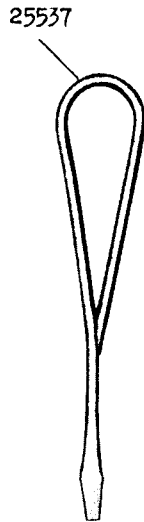

25537



8879



120378

32522



22692 - 1/3

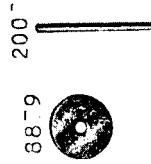

200



8879

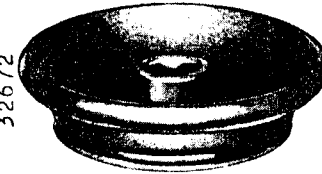

32672

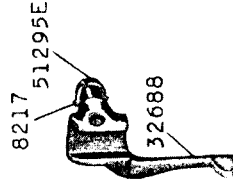

8217

51295E

32688

140202S

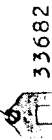

33682

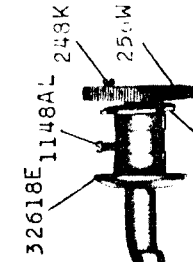

32618E

1148AL

243K

250W

2020

1832

1085E

33609R

1381C

1520R

1216C

216C

1520R

50046C

1512R

33602R

905E

1085E

33609R

1381C

1520R

1216C

216C

1520R

50046C

1512R

33602R

50047C

33603

32618E

1148AL

243K

250W

2020

1832

1085E

33609R

1381C

1520R

1216C

1520R

50046C

1512R

33602R

905E

1085E

33609R

1381C

1520R

1216C

216C

1520R

50046C

1512R

33602R

905E

1085E

33609R

1381C

1520R

1216C

216C

1520R

50046C

1512R

33602R

905E

1085E

33609R

1381C

1520R

1216C

216C

1520R

50046C

1512R

33602R

905E

1085E

33609R

1381C

1520R

1216C

216C

1520R

50046C

1512R

33602R

905E

1085E

33609R

1381C

1520R

22693 - 1/2

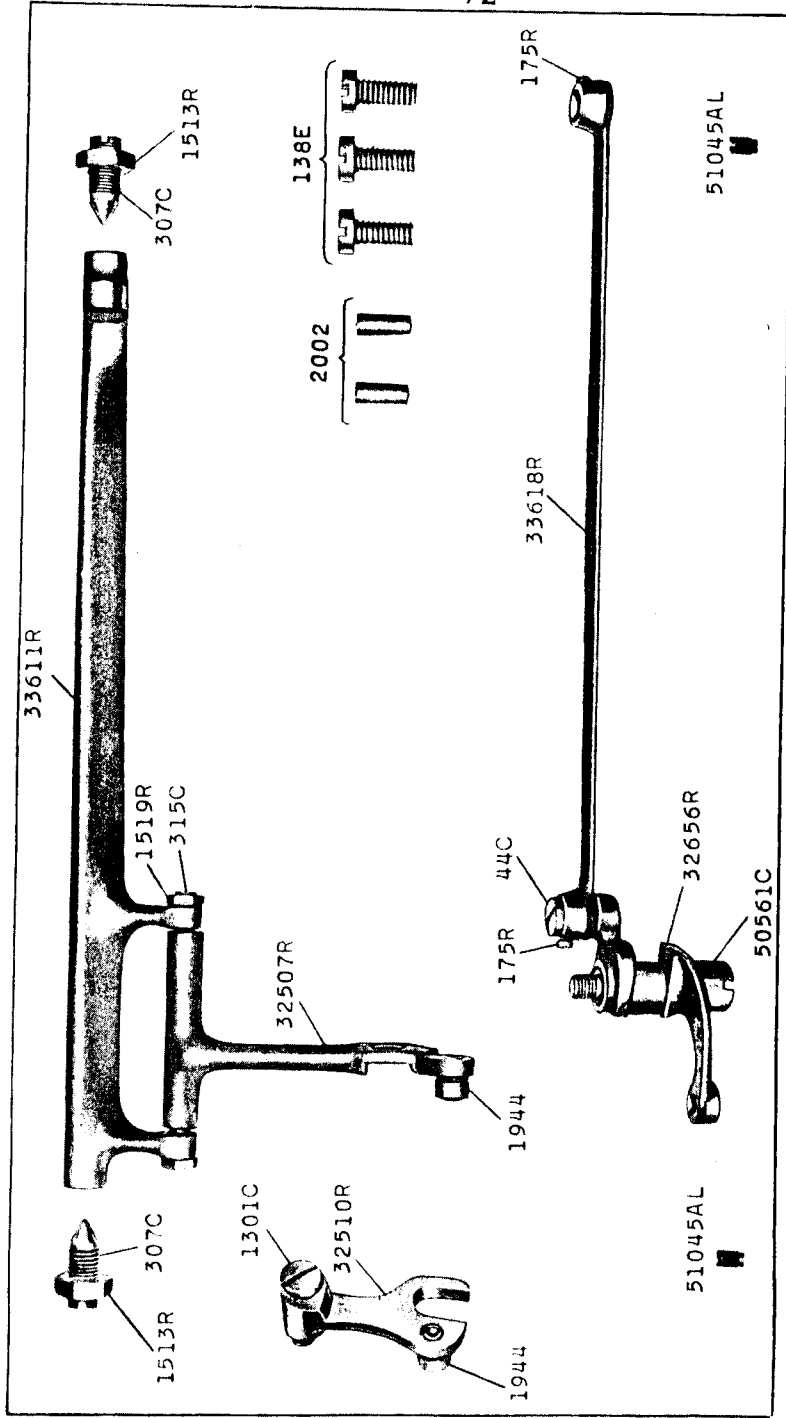

22694 - 2/3

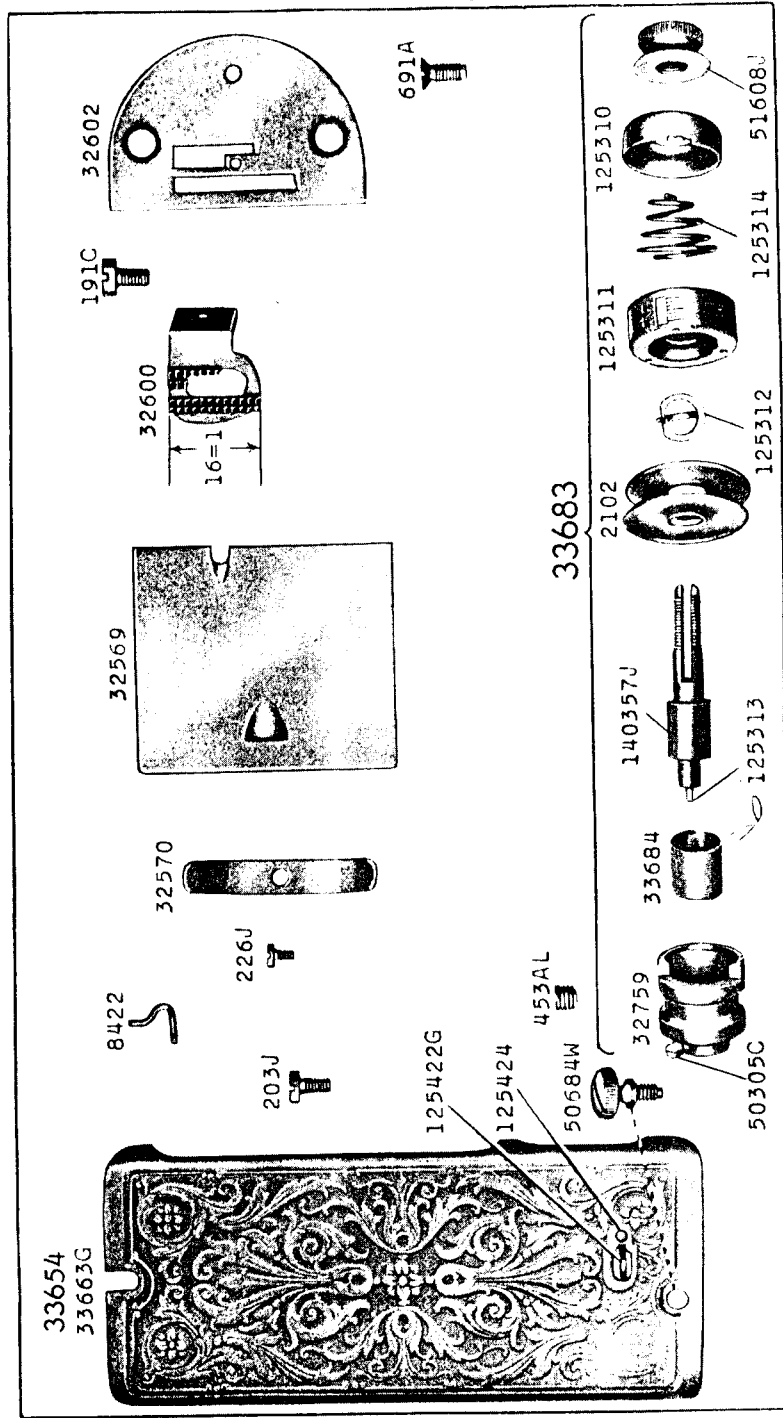

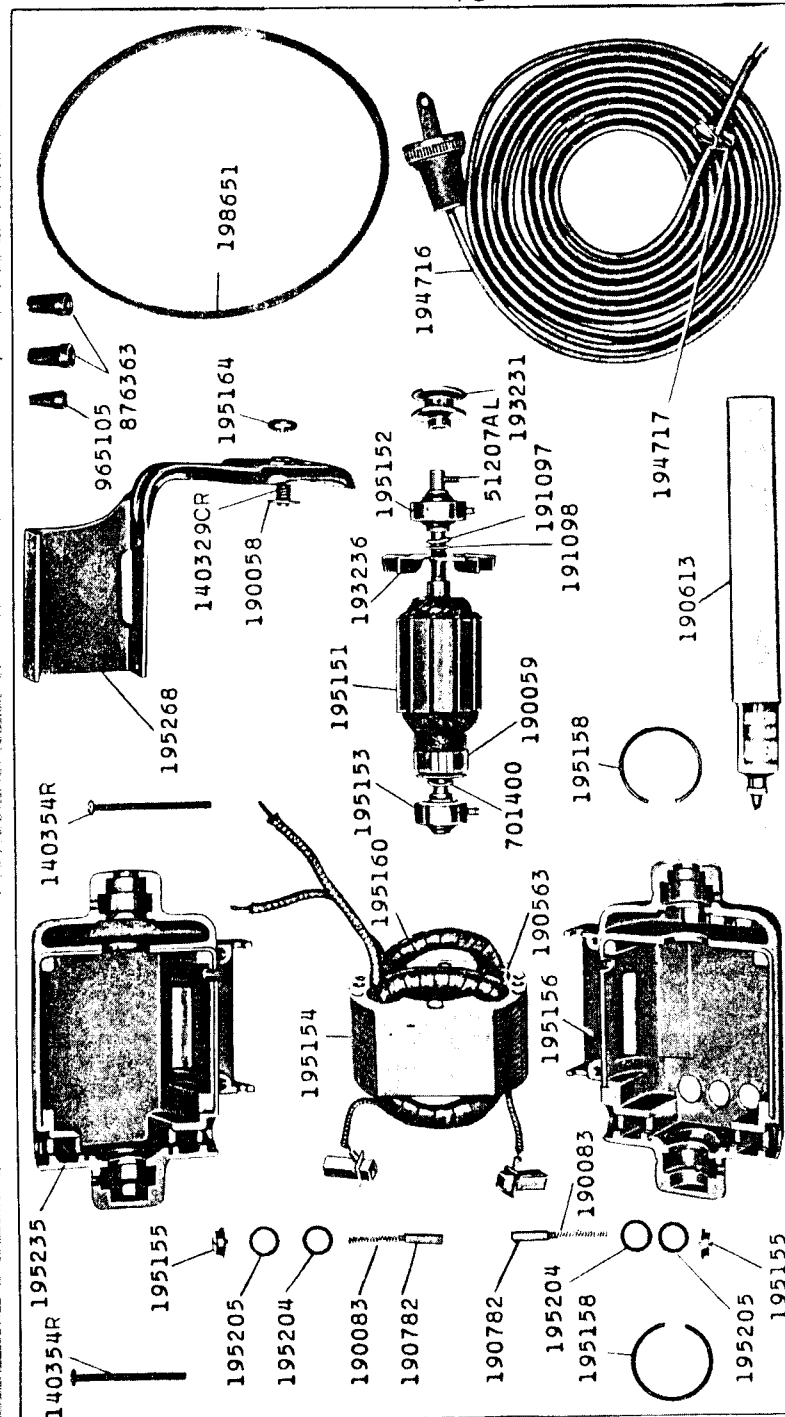
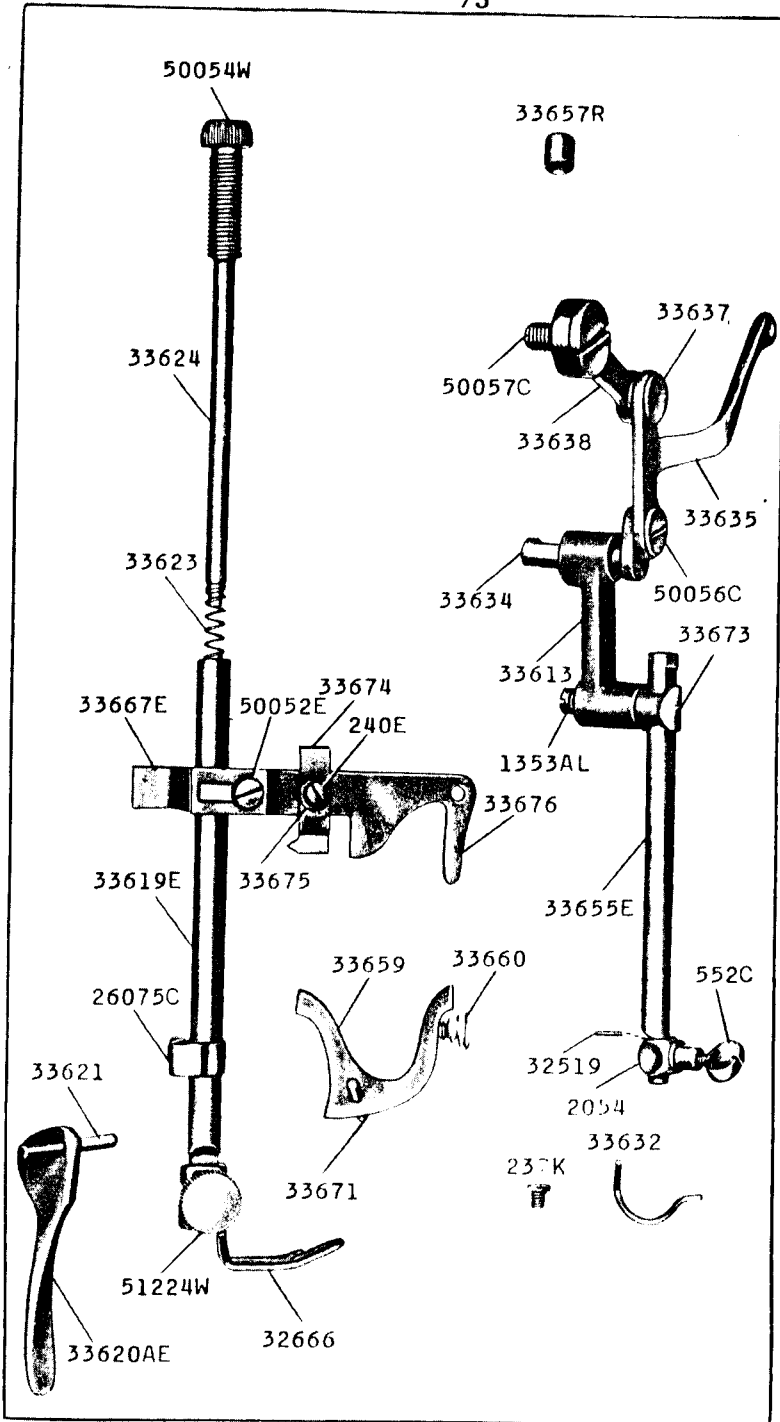

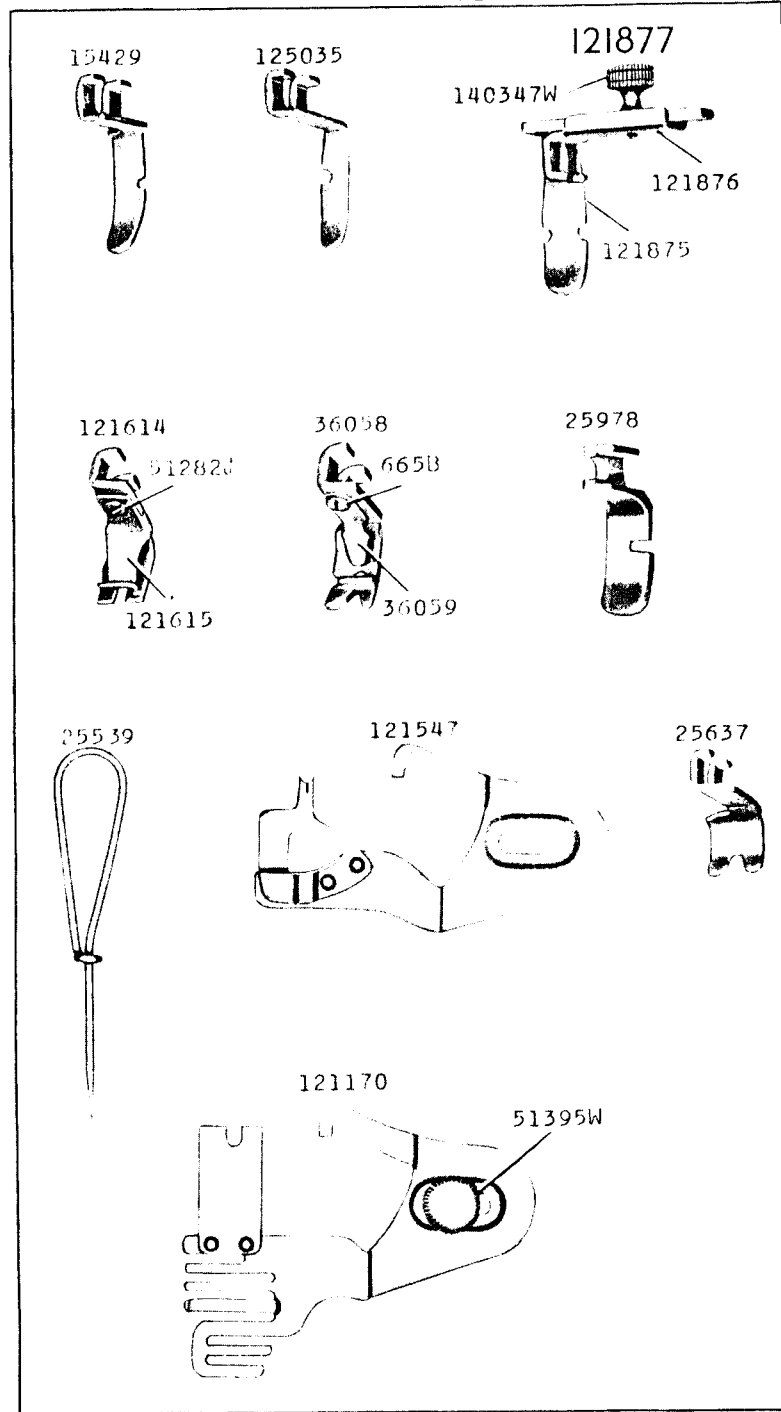
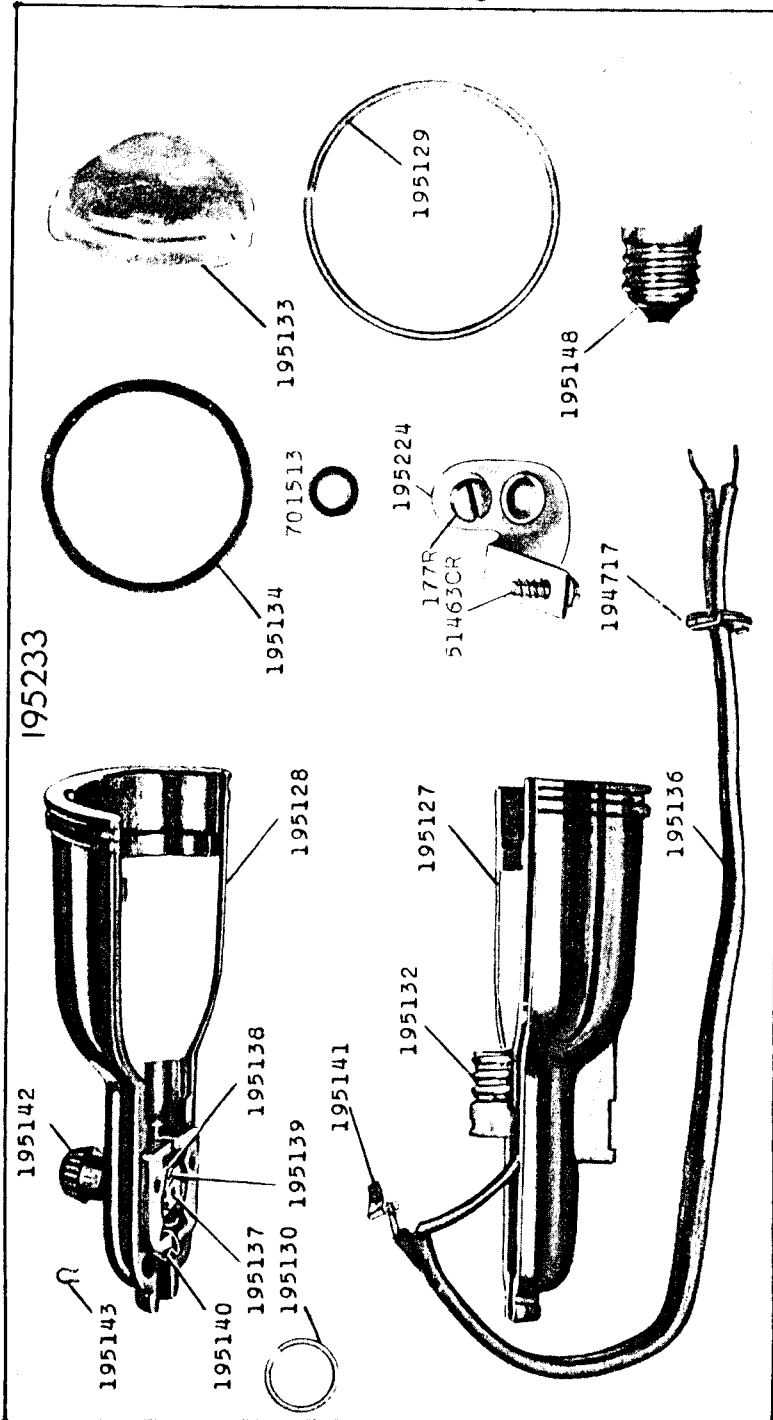

22699 - 2/3

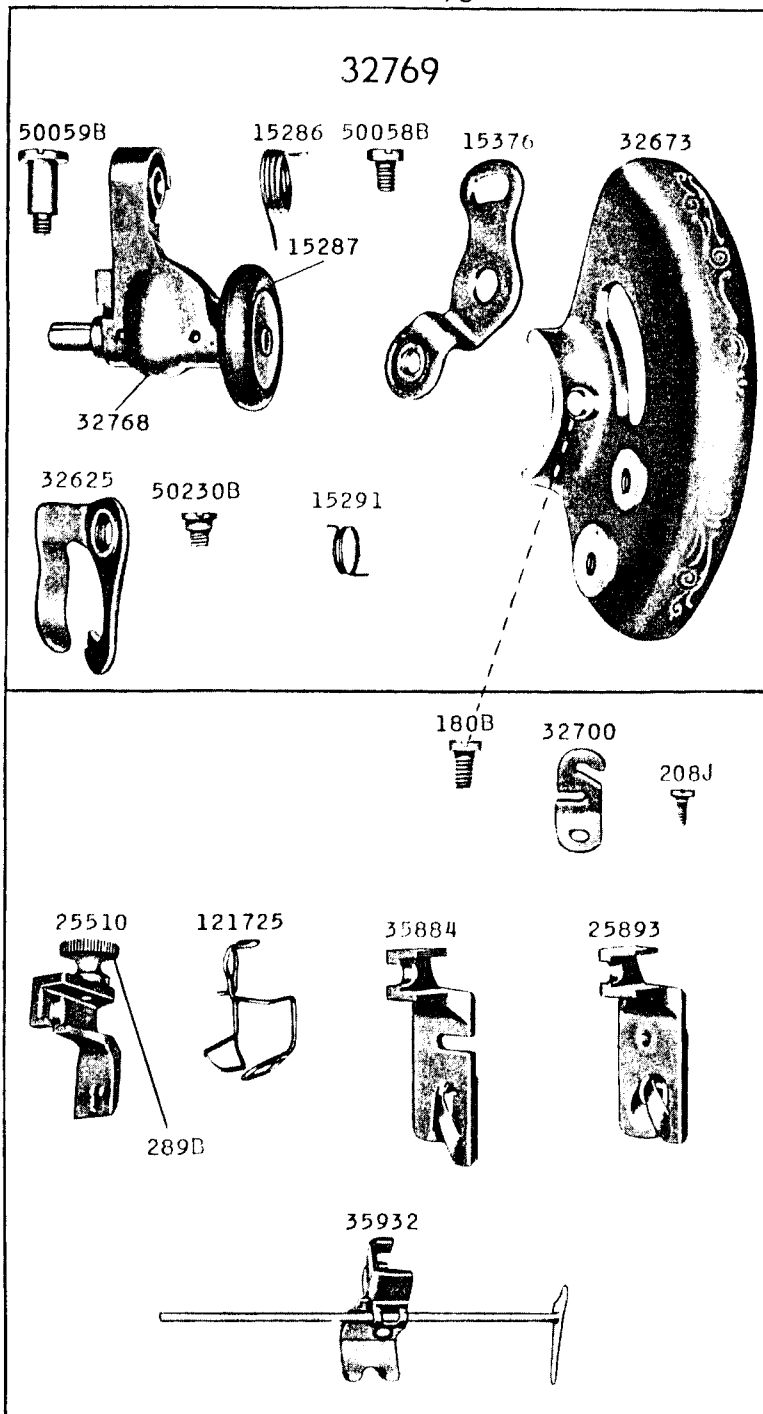

22700 - 1/3

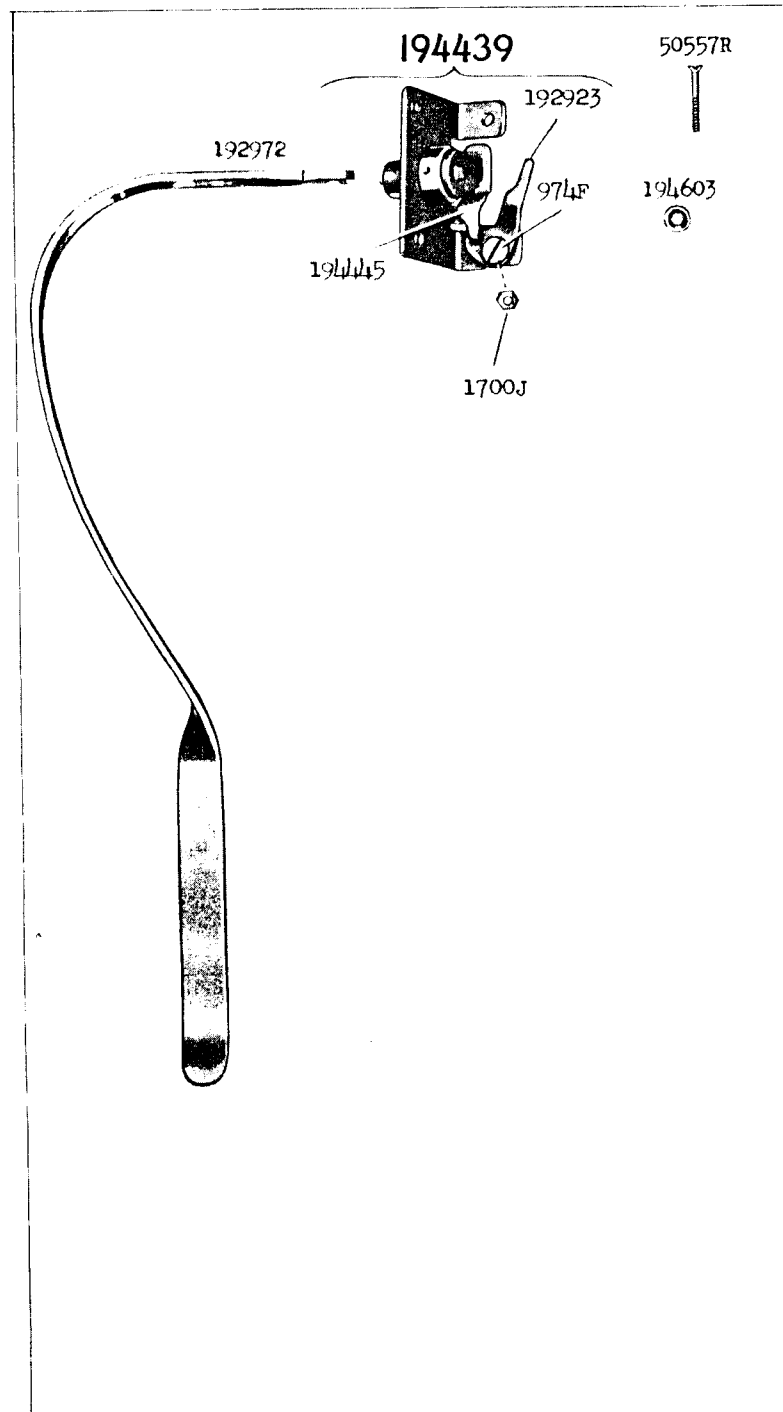

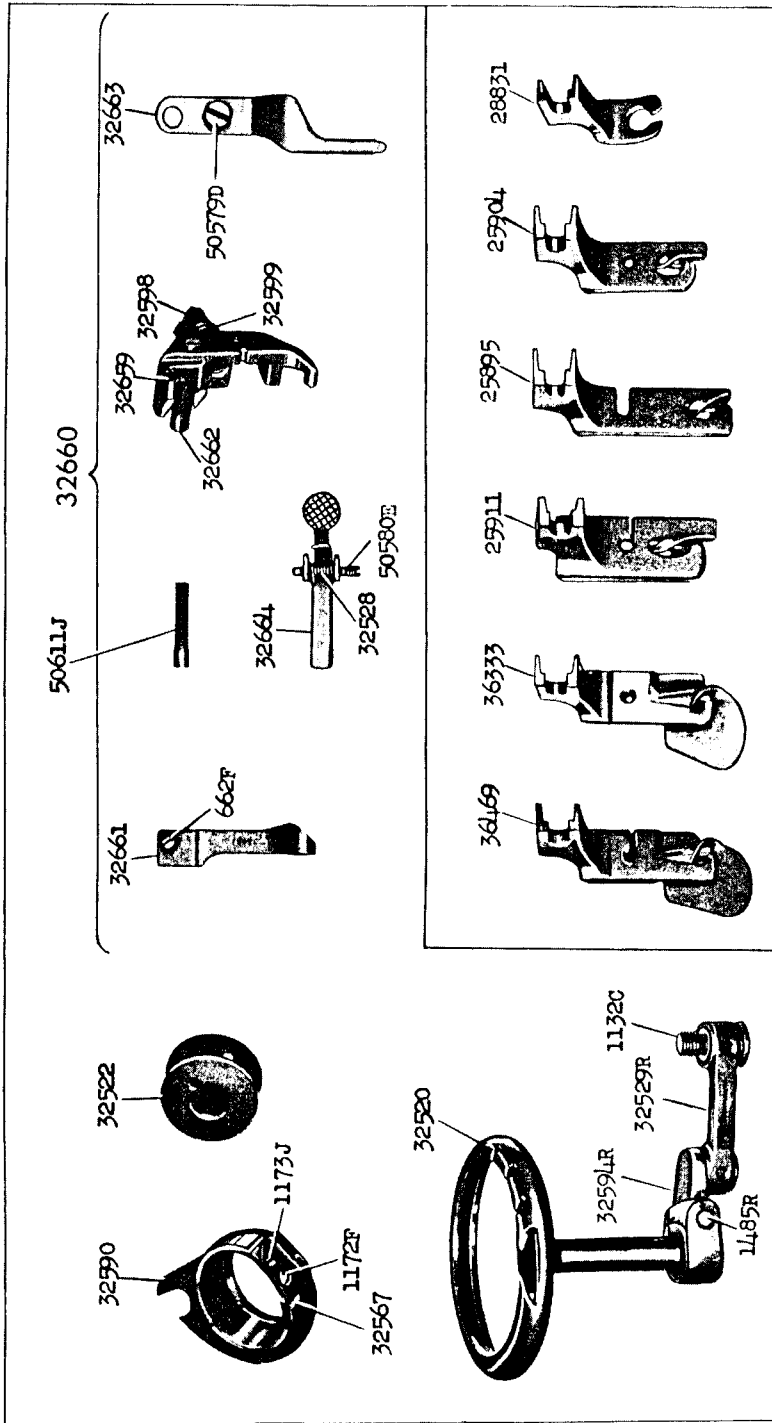

Genuine Singer Needles should be used
in Singer Machines.
These Needles and their Containers
are marked with the
Company's Trade Mark "SIMANCO." 1

Needles in Containers marked
"For Singer Machines"
are not Singer made needles. 2

Free Manuals Download Website

<http://myh66.com>

<http://usermanuals.us>

<http://www.somanuals.com>

<http://www.4manuals.cc>

<http://www.manual-lib.com>

<http://www.404manual.com>

<http://www.luxmanual.com>

<http://aubethermostatmanual.com>

Golf course search by state

<http://golfingnear.com>

Email search by domain

<http://emailbydomain.com>

Auto manuals search

<http://auto.somanuals.com>

TV manuals search

<http://tv.somanuals.com>