

# INSTRUCTION MANUAL AND ACCESSORIES

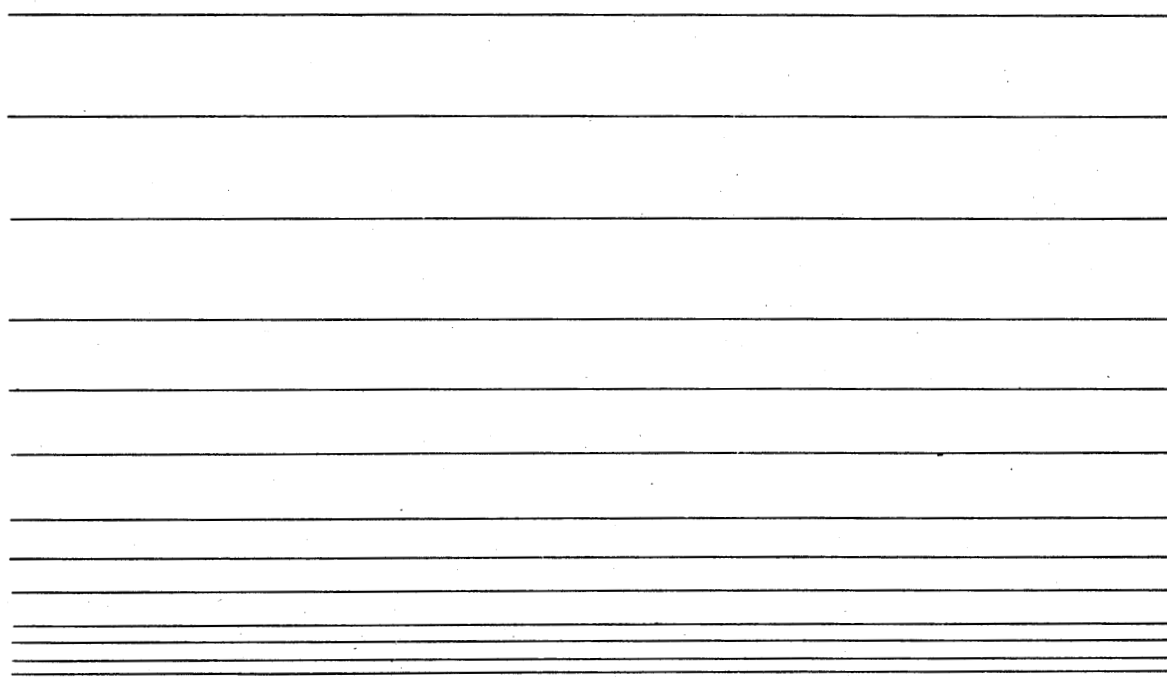

Full zig-zag sewing machine

free-arm  
**Model 1022**  
or  
Flat-bed  
**Model 1021**

# SINGER



The machine is intended for household use

# IMPORTANT SAFETY INSTRUCTIONS

When using an electrical appliance, basic safety precautions should always be followed, including the following:

Read all instructions before using the sewing machine.

## DANGER

To reduce the risk of electric shock:

1. An appliance should never be left unattended when plugged in. Always unplug this appliance from the electric outlet immediately after using and before cleaning.
2. Always unplug before relamping. Replace bulb with same type rated max. 15 Watts.

## WARNING

To reduce the risk of burns, fire, electric shock, or injury to persons:

1. Do not allow to be used as a toy. Close attention is necessary when this appliance is used by or near children.
2. Use this appliance only for its intended use as described in this manual. Use only attachments recommended by the manufacturer as contained in this manual.
3. Never operate this appliance if it has a damaged cord or plug, if it is not working properly, if it has been dropped or damaged, or dropped into water. Return the appliance to the nearest authorized dealer or service center for examination, repair, electrical or mechanical adjustment.
4. Never operate the appliance with any air openings blocked. Keep ventilation openings of the sewing machine and foot controller free from the accumulation of lint, dust, and loose cloth.
5. Never drop or insert any object into any opening.
6. Do not use outdoors.
7. Do not operate where aerosol (spray) products are being used or where oxygen is being administered.

8. To disconnect, turn all controls to the off ("0") position, then remove plug from outlet.
9. Do not unplug by pulling on cord. To unplug, grasp the plug, not the cord.
10. Keep fingers away from all moving parts. Special care is required around the sewing machine needle.
11. Always use the proper needle plate. The wrong plate can cause the needle to break.
12. Do not use bent needles.
13. Do not pull or push fabric while stitching. It may deflect the needle causing it to break.
14. Switch the sewing machine off ("0") when making any adjustments in the needle area, such as threading needle, changing needle, threading bobbin, or changing presser foot, and the like.
15. Always unplug sewing machine from the electrical outlet when removing covers, lubricating, or when making any other user servicing adjustments mentioned in the instruction manual.
16. Machine has be stored in dry and clean rooms to protect against rust.

**SAVE THIS INSTRUCTION**

## CONTENTS

	Page
<b>Getting to Know Your Sewing Machine</b> .....	2
Principal Parts — And What They Do .....	2
Accessories — And When To Use Them .....	6
<b>Getting Ready to Sew</b> .....	9
Preliminary Steps .....	9
Choosing Needle and Thread .....	10
Threading Your Sewing Machine .....	11
<b>Straight Stitching</b> .....	16
Adjusting Selectors .....	17
Sewing a Seam .....	19
<b>Zick-Zack Stitching</b> .....	22
Satin Stitching .....	24
<b>Twin-Needle Stitching</b> .....	25
Preparation .....	25
Threading the Needle .....	26
<b>Buttons and Buttonholes</b> .....	27
Buttons .....	27
Buttonholes .....	28
<b>Sewing the Professional Way</b> .....	31
Lingerie, Seam finishes .....	31
Hints on Sewing Special Fabrics .....	32
Construction Details .....	34
Applique, Attaching elastic .....	36
Free Arm Sewing .....	37
Keeping Up Appearances .....	41
<b>Caring for Your Machine</b> .....	44
Cleaning the Machine .....	44
Removing Bobbin Case, Face Plate and Bulb .....	45
Performance Checklist .....	46

# principal parts

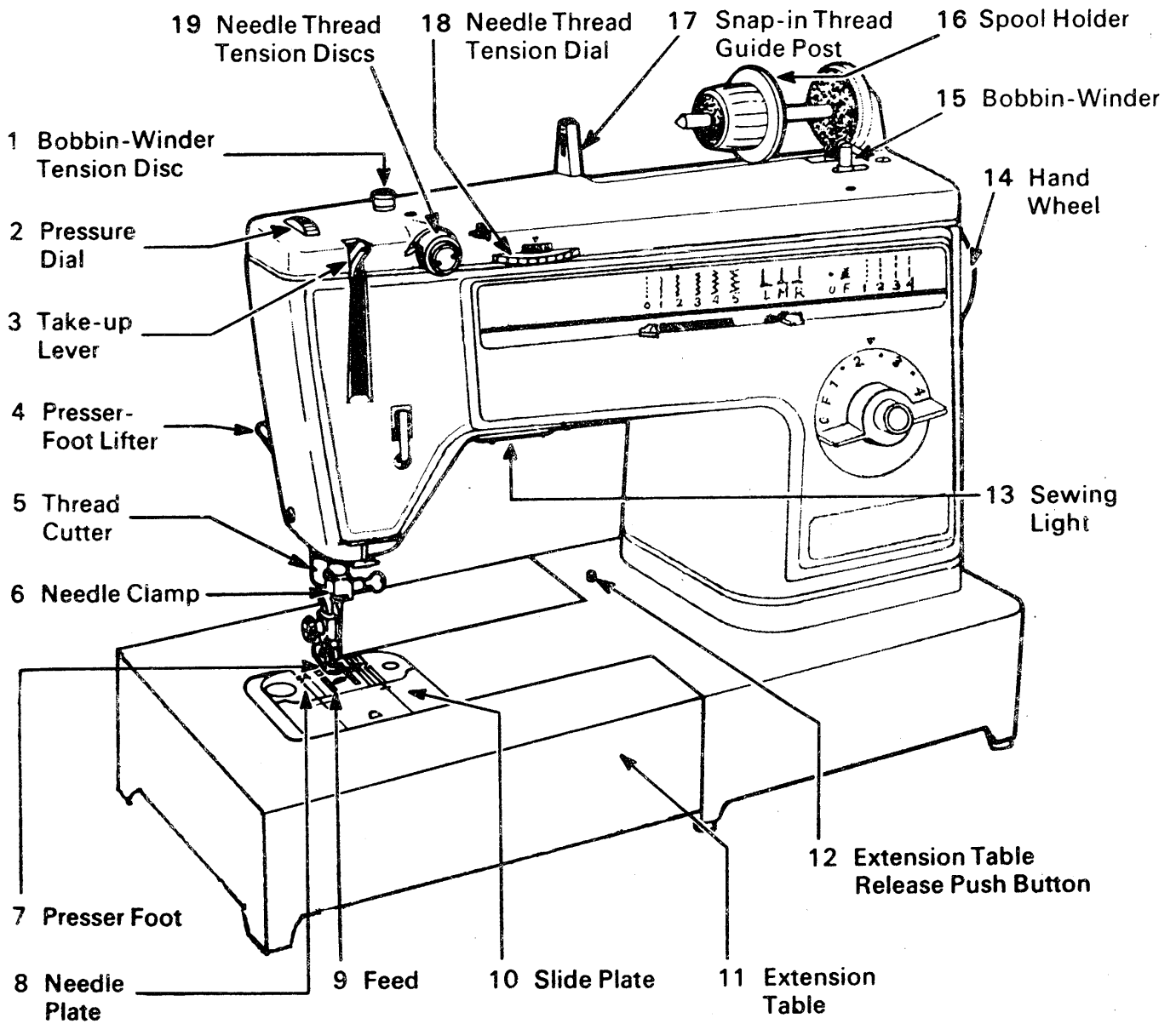

## *and what they do*

1. **Bobbin-Winder Tension Disc** regulates thread tension for bobbin winding.
2. **Pressure Dial** regulates presser-foot pressure on fabric. It has an all-purpose setting plus settings for extra-light and extra-heavy pressure, and for darning.
3. **Take-up Lever** controls flow of needle thread.
4. **Presser-Foot Lifter**, at back of machine, allows you to raise and lower presser foot. High-lift position allows easy placement of bulky fabrics.
5. **Thread Cutter** is built into presser bar for safety and convenience.
6. **Needle Clamp** holds single and twin needles and is designed to eliminate the possibility of inserting needle backwards.
7. **Presser Foot** holds fabric against feed. The foot snaps off for quick removal.
8. **Needle Plate** lifts out for easy removal. Guidelines on right *and* left sides extend to slide plate to help you keep seams straight.
9. **Feed** moves fabric under the presser foot.
10. **Slide Plate** opens for easy removal and replacement of the bobbin, and raises and lowers the pin that holds the needle plate in position.
11. **Extension Table** lets you convert the machine for either flat or tubular bed sewing.
12. **Extension Table Release Push Button** unlocks the extension table.
13. **Sewing Light** illuminates the sewing area.
14. **Hand Wheel** positions take-up lever and needle. Always turn it toward you.
15. **Bobbin-Winder** lets you fill the bobbin with thread quickly and easily.
16. **Spool Holder with Horizontal Pin** holds thread spools of various sizes.
17. **Snap-in Thread Guide Post** provides smooth flow of thread from spool holder to tension discs.
18. **Needle-Thread Tension Dial** lets you select the appropriate tension for your stitch, thread, and fabric. The numbers eliminate guesswork in duplicating settings.
19. **Needle-Thread Tension Discs**, controlled by the tension dial, regulate the amount of tension on your needle thread.

PRINCIPAL PARTS (Continued)

20. **Stitch Width Selector** controls the width of zig-zag stitching and positions needle for straight stitching. Use | setting for straight stitching.
21. **Needle-Position Selector** places needle in either left, center or right stitching position. Use center position for straight stitching.
22. **Stitch Control Dial** allows for a variety of stitch lengths, including 0-1 for zig-zag satin stitching.
23. **Reverse-Stitch Push Button** lets you reverse stitching direction.

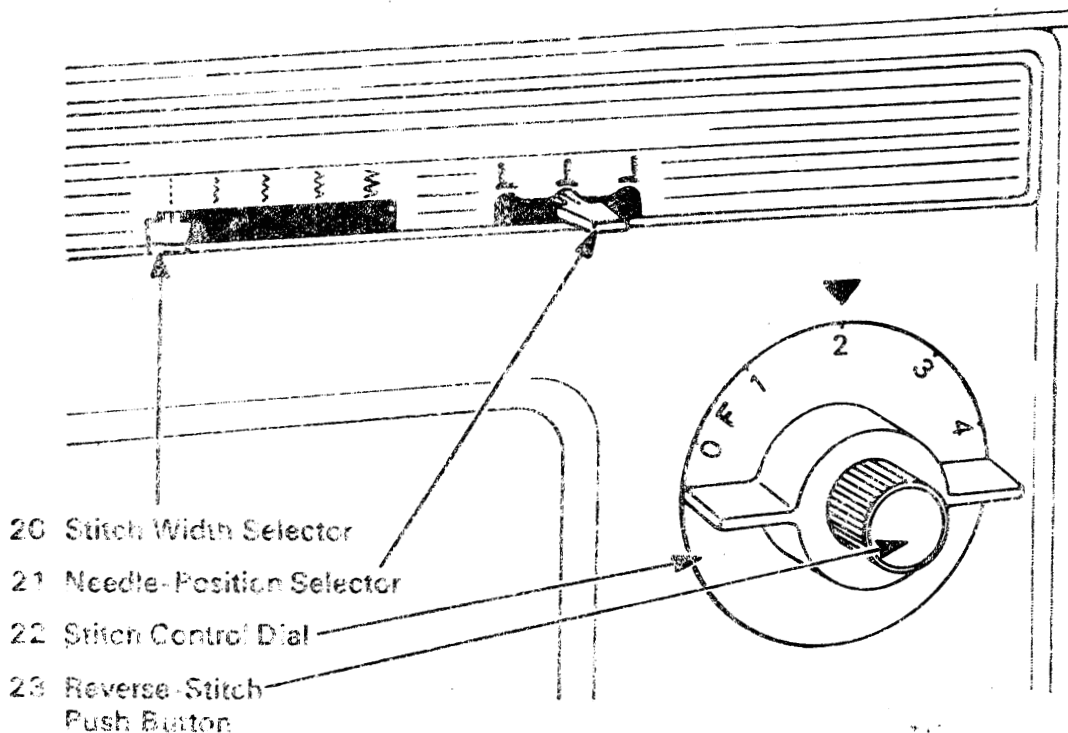



**24. Hand Wheel Disc** automatically disengages clutch for easy bobbin winding.

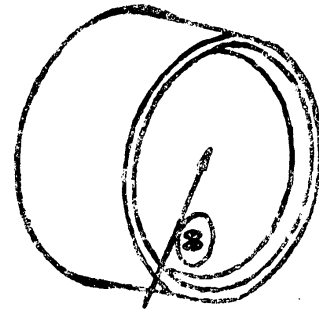

Hand Wheel Disc

**25. Transparent Bobbin** shows thread supply ... is easily removed for bobbin winding.

25 Transparent Bobbin

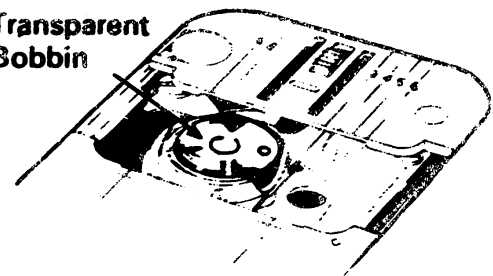

**26. Power and Light Switch** turns on the power and the sewing light simultaneously.

26 Power and Light Switch

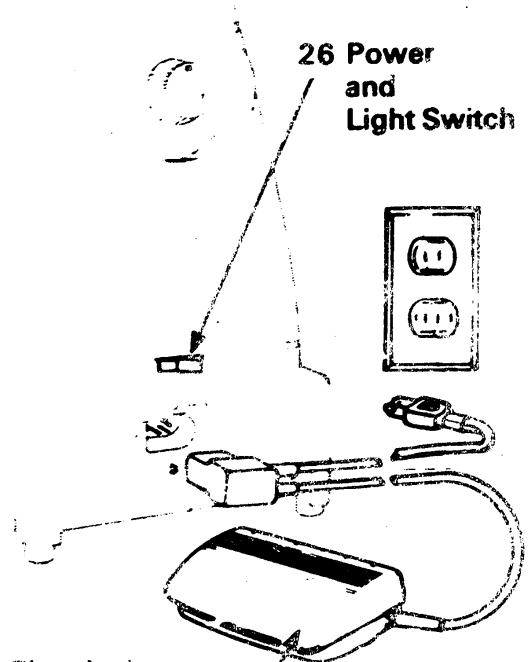

**27. Electrical Connections and Speed Controller** are designed for convenience and safety.

27 Electrical Connections and Speed Controller

*See instructions for connecting and operating machine and controller on page 9.*

# accessories . . . and when to use them



**General Purpose  
Foot**

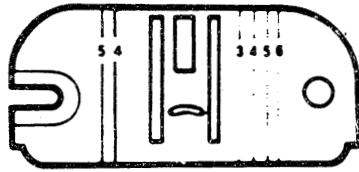

**General Purpose  
Needle Plate**

## **GENERAL PURPOSE FOOT AND NEEDLE PLATE**

The general purpose foot and the general purpose needle plate are in place on the machine. Use them for all utility sewing, with either straight or zig-zag stitching.



**Zipper Foot**

## **ZIPPER FOOT**

The zipper foot is used to place stitching close to a raised edge. It can be fitted to the presser-foot shank for use on either right or left side of the needle.

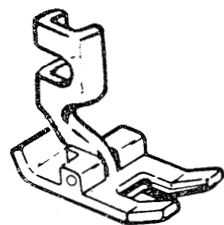

**Special Purpose Foot**

## **SPECIAL PURPOSE FOOT**

The special purpose foot is used for all kinds of decorative zig-zag stitching. Use this foot for:

- Zig-zag satin stitching
- Appliqué
- Buttonholes
- Twin-needle stitching

## FEED-COVER PLATE

The feed-cover plate which allows free fabric movement is used for darning (page 43), embroidery and button sewing (page 27). By covering the feed with the feed-cover plate the fabric is not moveable.

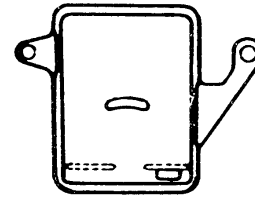

**Feed-Cover Plate**

## CHANGING NEEDLE PLATE

- Raise presser foot. (You do not need to remove the foot.)
- Turn hand wheel toward you until needle is in its highest position.
- Open slide plate with downward finger pressure.
- Place thumb under needle plate and draw plate to the right to remove.
- Insert new needle plate under locking pin and over positioning pin.
- Close slide plate.

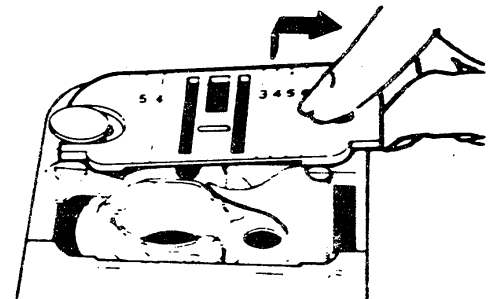
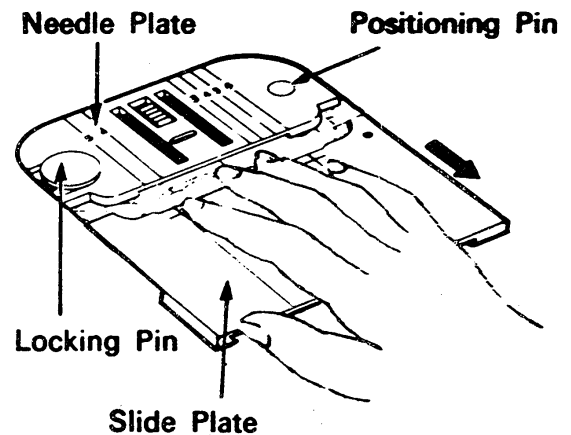

**Changing Needle Plate**

## CHANGING PRESSER FEET

The presser feet that are supplied with your machine snap on and off a common shank. To change the foot:

- Raise presser-foot lifter and turn hand wheel toward you to raise needle to its highest position.
- Press toe of presser foot upward (as far as it will go) and then snap down to remove the foot.
- Center the new presser foot under the shank and lower the presser-foot lifter so that shank fits over the presser-foot pin.
- Press down on presser-foot screw until foot snaps into place.

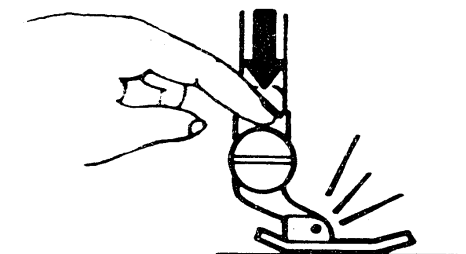
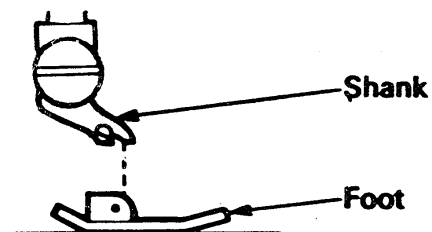

**Changing Presser Foot**

**Transparent Bobbin**

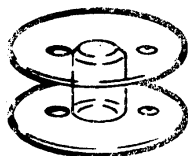

**Regular Needle**



**Ball-point (Yellow Band) Needle**



**Twin Needle**

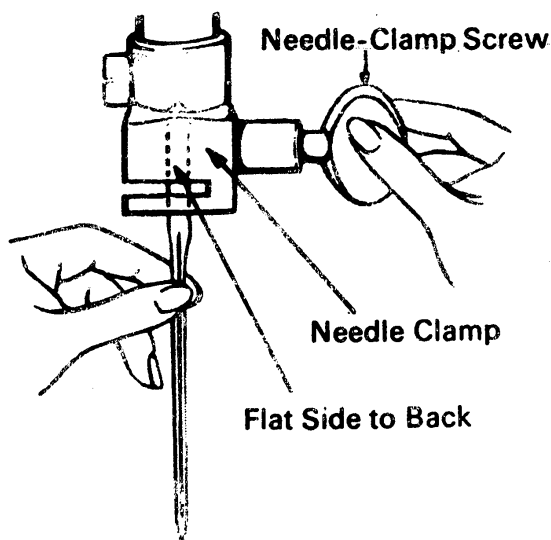

**Changing the Needle**

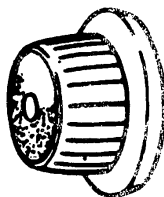

**Small and Large Spool Holders**

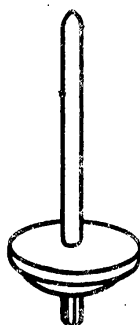

**Detachable Spool Pin**

## BOBBINS

Transparent, drop-in bobbin, shows thread supply at a glance.

## NEEDLES

- Type 705 H needles for all-purpose sewing
- Type 705 HS ball-point (yellow band) needles, for sewing knits and stretch fabrics.
- Type 705 H twin needle for decorative twin-needle stitching.

## ATTACHING FEED-COVER PLATE

1. Raise presser foot. (You do not need to remove the foot).
2. Turn hand wheel toward you until is at its highest position.
3. Slide feed-cover plate under the presser foot, until securing pins are located directly over holes in needle plate. Then snap down.

## CHANGING THE NEEDLE

The needle clamp is designed so that the needle can only be inserted with the flat side of the needle to the back. To change the needle:

1. Raise needle bar to its highest position, loosen needle-clamp screw, and remove needle.
2. Insert new needle in clamp, with the flat side of the needle to the back; push it up as far as it will go.
3. Tighten needle-clamp screw.

## SPOOL HOLDERS

The spool holders hold spools of various sizes in position on the horizontal spool pin. Because spool does not turn, thread unwinds smoothly.

## DETACHABLE SPOOL PIN

The secondary detachable spool pin is used for twin-needle sewing.

## preliminary steps

### CONNECTING THE MACHINE

Before plugging in your machine, be sure that the voltage and number of cycles indicated on the plate under the hand wheel conform to your electrical power supply.

Push the machine plug into the receptacle at the right end of the machine bed. Then connect the power-line plug to your electrical outlet.

### OPERATING MACHINE AND CONTROLLER

To turn on both machine and sewing light, press power and light switch to ON position. To turn off machine and light, press switch at „0” to OFF position.

**WARNING:** Turn off the power and light switch before changing needles, presser feet, and needle plates and when leaving the machine unattended. This eliminates the possibility of starting the machine by accidentally pushing the speed controller.

To start the machine, press the speed controller. The harder you press, the faster the machine will sew.

To stop the machine from sewing, remove pressure from speed controller.

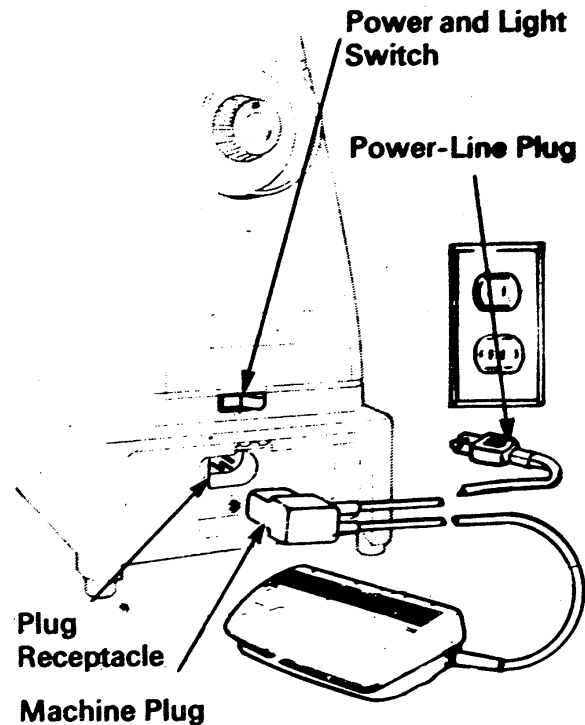

Electrical Connections

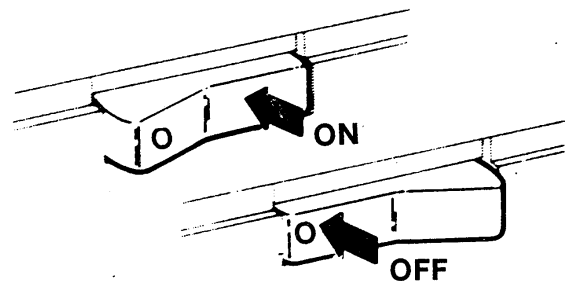

Power and Light Switch

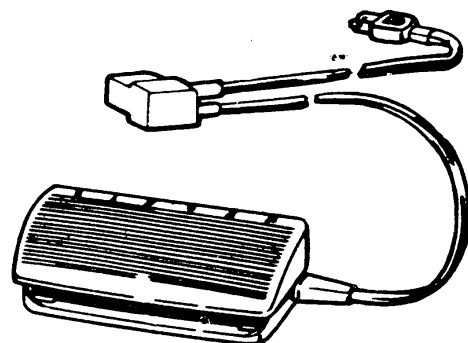

Speed Controller

# choosing needle and thread

The needle and thread you choose will depend upon the fabric being stitched. The table below is a practical guide to needle and thread selection. Refer to it before starting a sewing project. Be sure to use the same size and type of thread in both needle and bobbin.

## FABRIC, THREAD AND NEEDLE TABLE

FABRIC	THREAD	NEEDLES	
		Type	Size
<b>DELICATE</b> —tulle, chiffon, fine lace, organza	Fine polyester, nylon, and cotton thread	705 H	70
<b>LIGHTWEIGHT</b> —batiste, organdy, jersey, voile, taffeta, crepe, chiffon, velvet, plastic film	50 mercerized cotton "A" silk Polyester thread Cotton-wrapped polyester	705 H	80
<b>MEDIUM WEIGHT</b> —gingham, percale, piqué, linen, chintz, faille, satin, fine corduroy, velvet, suitings, deep-pile fabrics, vinyl	50 mercerized cotton 60 cotton "A" silk Polyester thread Cotton-wrapped polyester	705 H	90
<b>MEDIUM HEAVY</b> —gabardine, tweed, sailcloth, denim, coatings, drapery fabrics, vinyl, deep-pile fabrics	Heavy-duty mercerized cotton 40 to 60 cotton Polyester thread	705 H	100
<b>HEAVY</b> —overcoatings, denim, upholstery fabrics, canvas	Heavy-duty mercerized cotton 24 to 40 cotton Polyester thread	705 H	110
<b>ALL WEIGHTS</b> —decorative straight stitch topstitching in woven fabrics	"D" silk† (Buttonhole twist)	705 H	100 or 110
<b>KNIT, WOVEN, STRETCH and ELASTIC FABRICS</b> —polyester doubleknit, spandex, nylon, tricot, ciré tricot, jersey, panne velvet	"A" nylon 50 mercerized cotton "A" silk Cotton-wrapped polyester	705 HS Ball-Point (Yellow Band)	90
<b>LEATHER</b> —suede, kidskin, capeskin, lambskin, lined leathers	50 mercerized cotton Polyester thread "A" silk Cotton-wrapped polyester	705 H	80 90 100
<b>LIGHT and MEDIUM WEIGHTS</b> —decorative twin-needle stitching in woven fabrics	50 mercerized cotton	705 H (twin)	90

† Use with 50 mercerized cotton or "A" silk in bobbin.

# threading your sewing machine

Like all sewing machines that produce what is called a "lockstitch", your sewing machine sews with two threads. The upper thread comes from the spool and is threaded through the eye of the needle. The lower thread comes from bobbin, the small transparent spool that you wind using the machine. It is best to wind the bobbin before the needle.

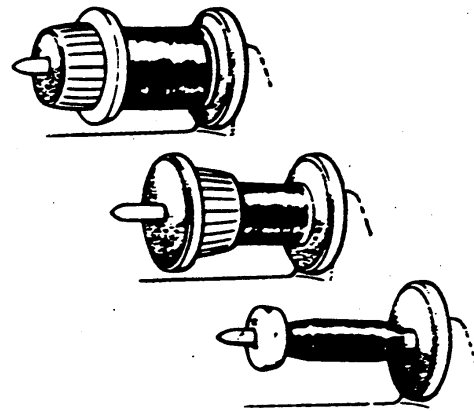

**Spool Holders**

## THE SPOOL HOLDER

- Remove spool holder from spindle by sliding it to the left.
- Place spool of thread on horizontal spool pin. If spool being used has a retaining slit, this should be placed against the spool cushion on the right.
- Select correct spool holder according to type and diameter of the end of the spool being used. The diameter of the end of the spool holder should always be larger than that of the spool itself.
- Press spool holder *firmly* against spool.

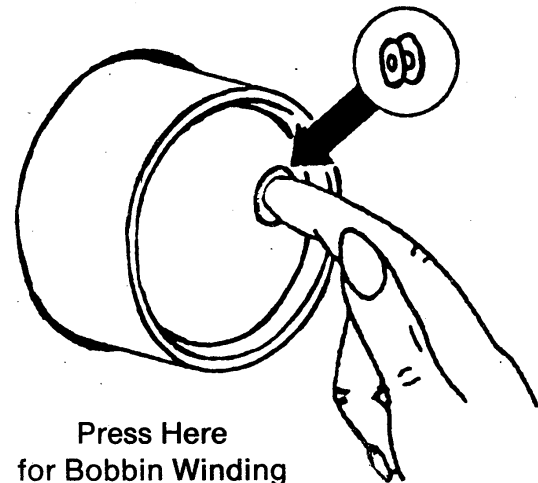

Press Here  
for Bobbin Winding

## THE BOBBIN THREAD

### Winding the Bobbin

- Raise the presser foot and turn the hand wheel toward you until needle is at its highest position.
- To disengage clutch, place your thumb directly on bobbin symbol located inside hand wheel disc and press down.
- Open slide plate to make bobbin accessible.
- Lift out bobbin and close slide plate to make sure needle plate is secure while winding.

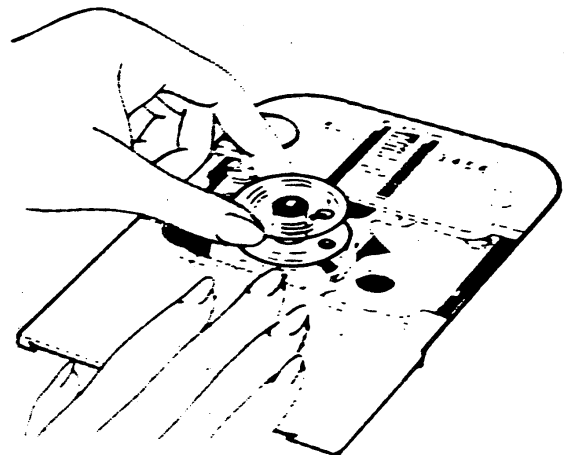

**Removing Bobbin**

## THE BOBBIN THREAD (Continued)

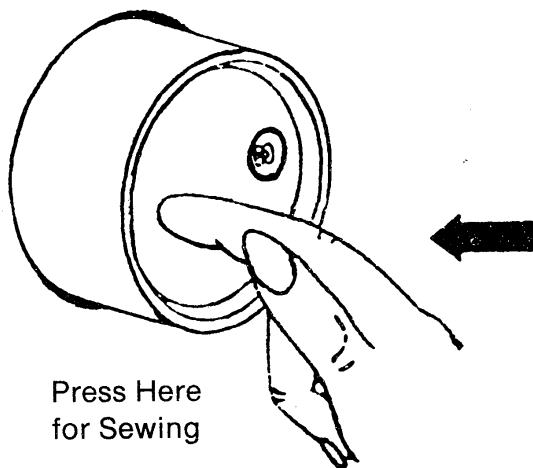
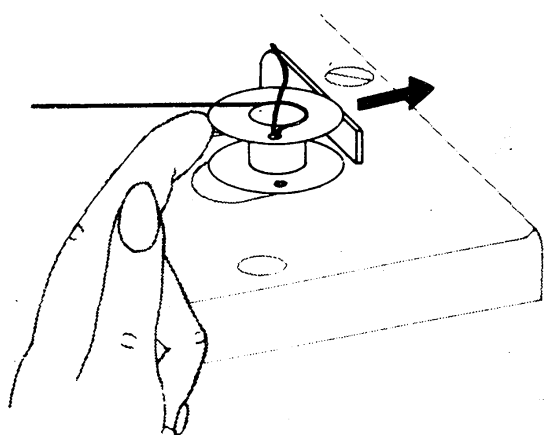
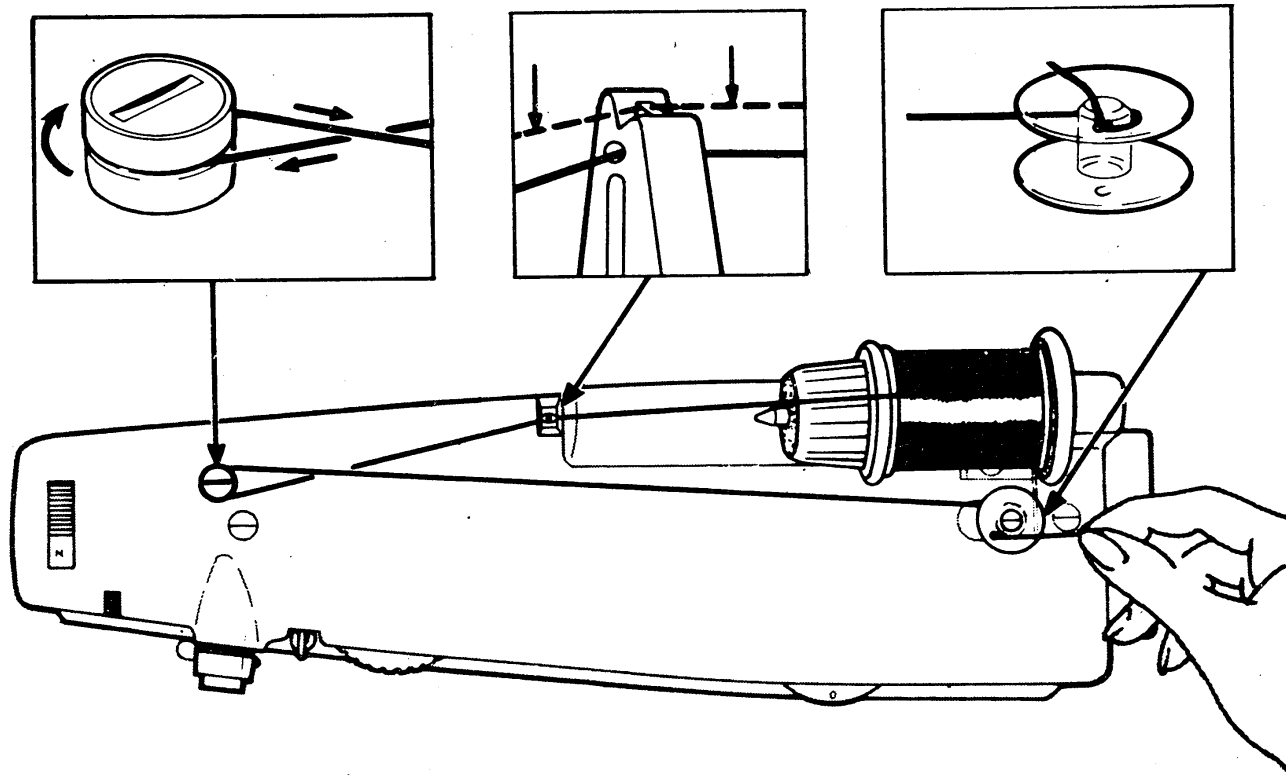

Press Here  
for Sewing

- Place spool of thread on spool pin. Snap thread in the thread guide post then lead thread around bobbin winder tension disc, as illustrated above.
- Pass thread, from the inside, through hole in bobbin and place bobbin on spindle.
- Push bobbin and spindle to the right to engage the bobbin winder. Hold thread end as shown and start the machine, winding at moderate speed.
- Cut off thread end after a few coils have been wound on the bobbin.
- When required amount of thread has been wound (winding will stop when bobbin is full), stop machine. Cut connecting thread.
- Push bobbin and spindle toward the left to disengage bobbin winder. Remove bobbin.
- Release hand wheel disc for sewing.



## THREADING THE BOBBIN CASE

1. Open slide plate. Hold bobbin so that thread unwinds in direction shown, and put bobbin in bobbin case.

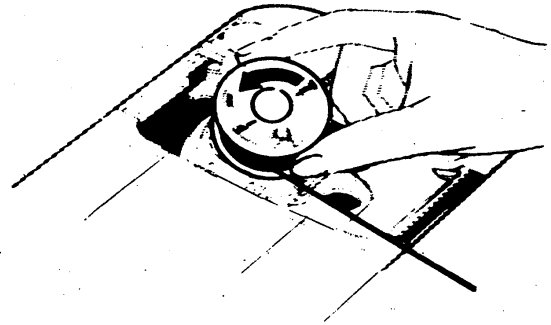

2. Pull thread into notch, draw it under tension spring and back into slot.

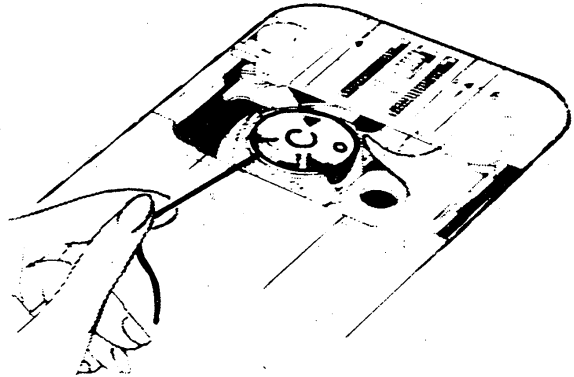

3. Draw about three inches of thread diagonally across the bobbin.

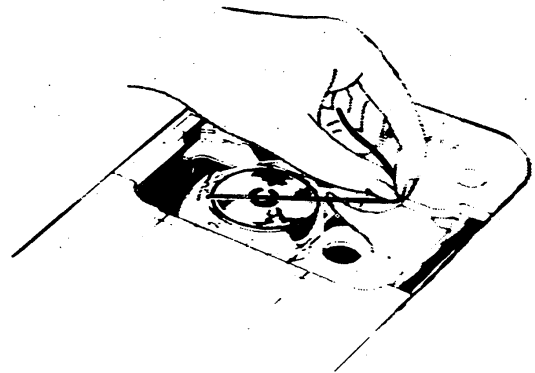

4. Close slide plate allowing thread to enter slot between the needle plate and the slide plate.

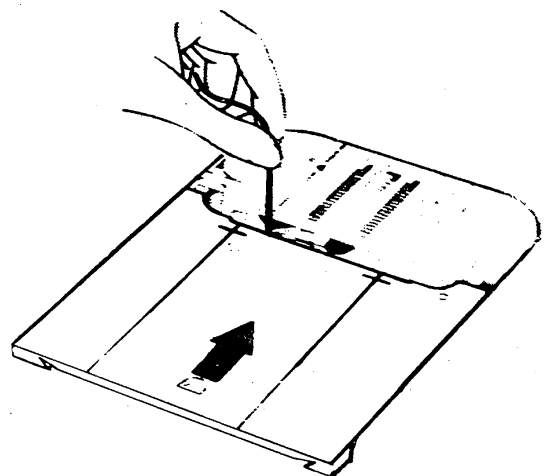

## THE NEEDLE THREAD

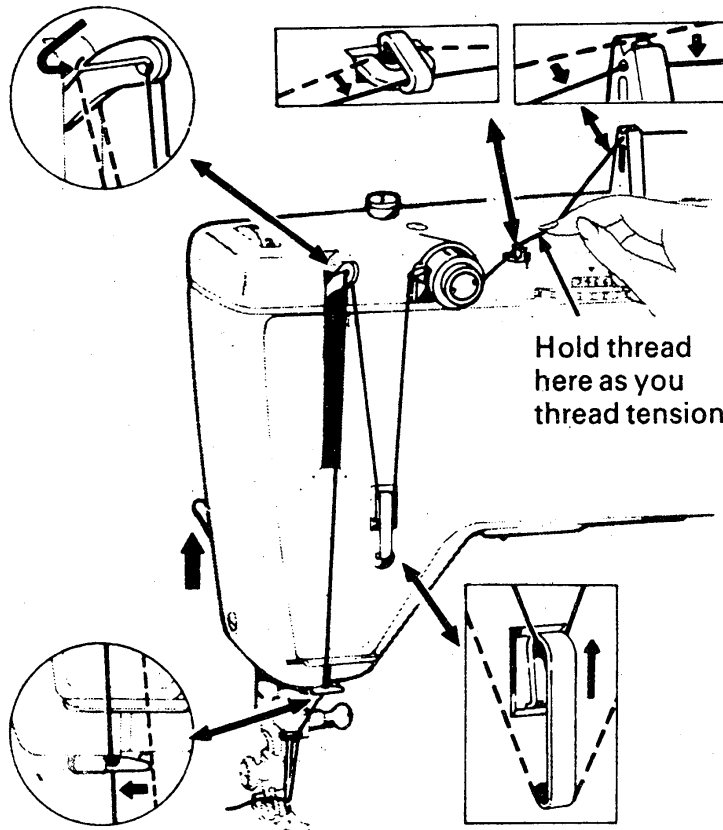

Lead thread  
*under* right  
guide, up, and  
into tension  
discs

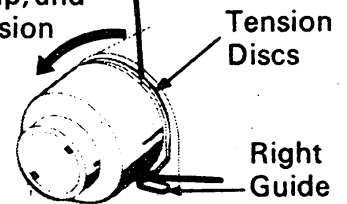

Lead thread over  
spring and *under*  
left guide

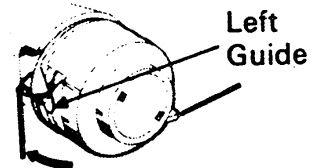
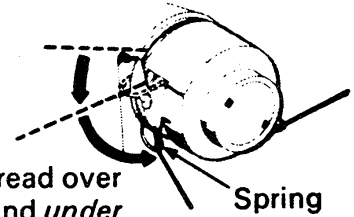

Allow spring to return to its  
normal up position and con-  
tinue threading the machine

Hold thread  
here as you  
thread tension

### Threading the Needle

1. Turn hand wheel to raise take-up lever to its highest position, *and raise presser foot to release the tension discs.*
2. Place spool of thread on spool holder and lead thread through all points as shown, making sure to:
  - Hold thread as illustrated while guiding thread into tension discs.
  - Thread tension discs as illustrated.
  - Thread take-up lever from back to front, guiding thread down over top of lever and then up into eyelet.
  - Thread needle from front to back, drawing about 10 cm of thread through eye of needle.

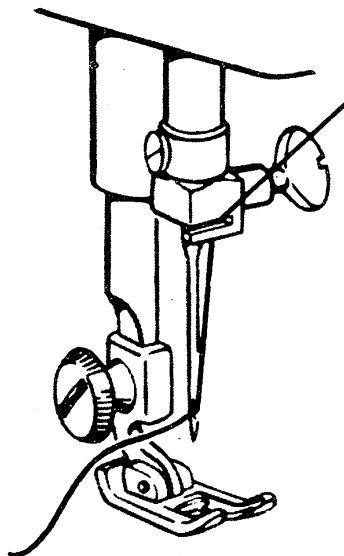

## RAISING THE BOBBIN THREAD

Now that you have wound the bobbin and threaded the needle, you will need to raise the bobbin thread through the needle hole in the needle plate.

1. Hold needle thread lightly with left hand and turn hand wheel slowly toward you so that needle enters hole in needle plate.

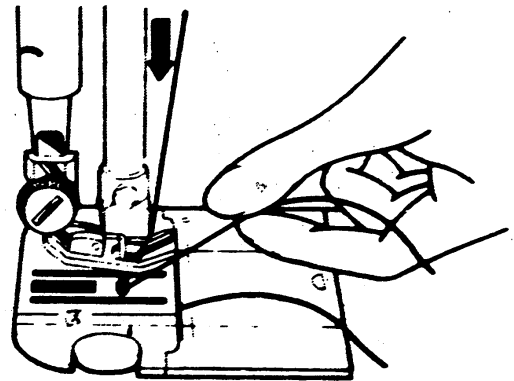

2. Continue turning hand wheel and holding needle thread until needle rises. Tighten your hold on the needle thread and bring up bobbin thread in a loop.

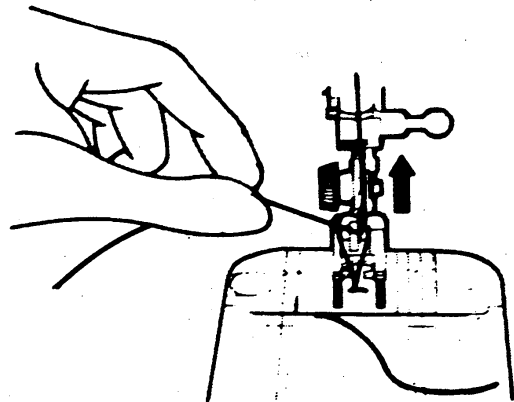

3. Open the loop with your fingers.

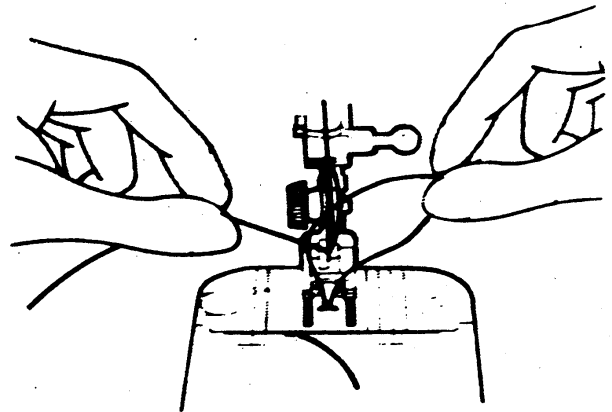

4. Place both needle and bobbin threads under presser foot, and draw to back of machine.

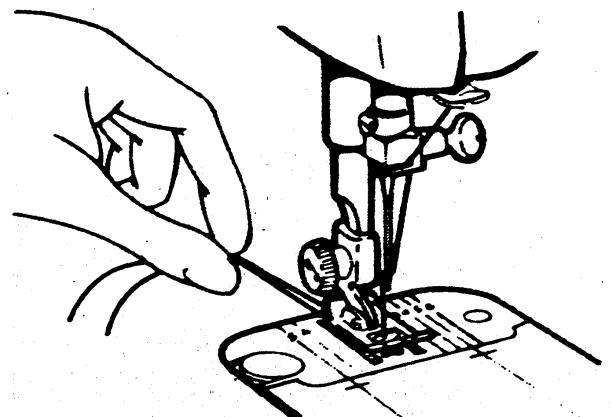

... You are now ready to sew

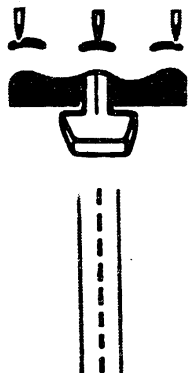

**Needle Position**

Before you move the selectors to set your sewing machine for straight stitching, turn the hand wheel toward you until the needle is above the needle plate.

## SETTING THE MACHINE

- Move needle position selector to (center).
- Set stitch width selector on :

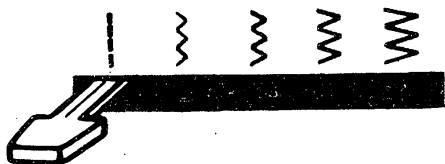

**Stitch Width**

## STARTING TO SEW

- Place needle and bobbin threads under presser foot and draw to back of machine.
- Position the needle in the fabric where desired for stitching start.
- Lower the presser foot and start the machine.

To sew perfectly on a wide variety of fabrics, adjust stitch length, pressure and thread tension as instructed on the following pages.

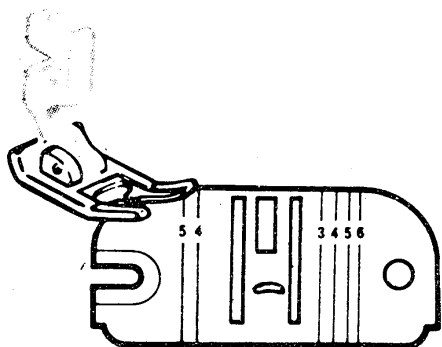

**Accessories**

# adjusting selectors for your fabric

## ADJUSTING STITCH LENGTH

The stitch length dial regulates the length of stitches. The numbers on the dial express stitch length in mm; the higher the number the longer the stitch. Generally, shorter stitches are best for lightweight fabric; longer ones for heavy fabric. The 0—1 area is used for the adjustment of zigzag satin stitching.

### Setting the Selector

- Turn dial so that the stitch length desired is positioned under the ▼ symbol on the control panel.
- To *shorten* the stitch length, turn the dial clockwise to a lower number.
- To *lengthen* the stitch, turn the dial counterclockwise to a higher number.

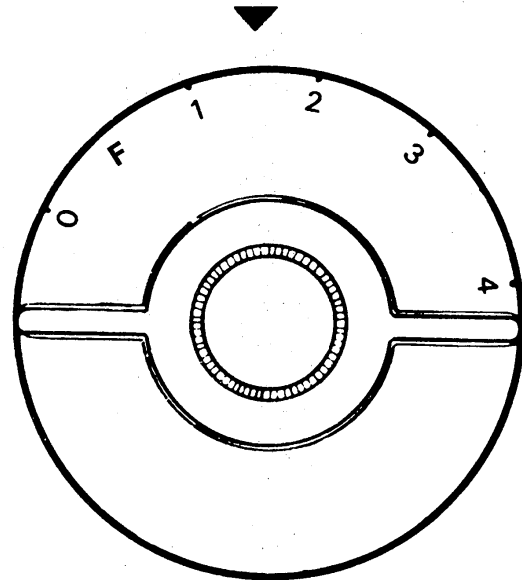

**For reverse stitching**, press the reverse-stitch push button (located in the center of the dial) in as far as it will go and hold in place (the button can be pushed in while the machine is sewing). Release pressure on the push button to return to forward stitching.

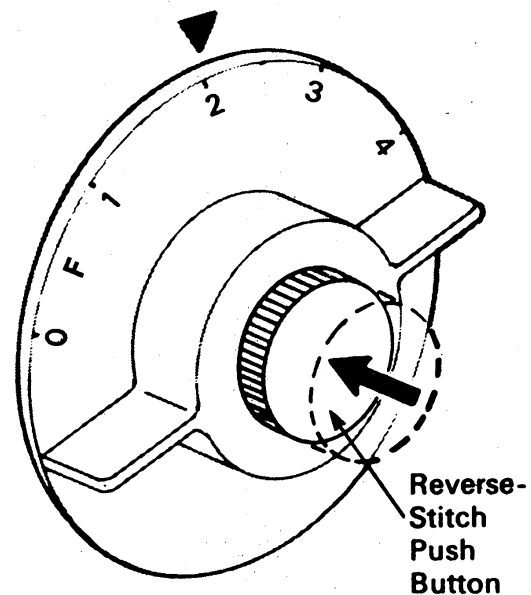

### Reverse Stitching

(For detailed instructions on adjusting the stitch length for zig-zag satin stitching, see page 24.)

## STRAIGHT STITCHING (Continued)

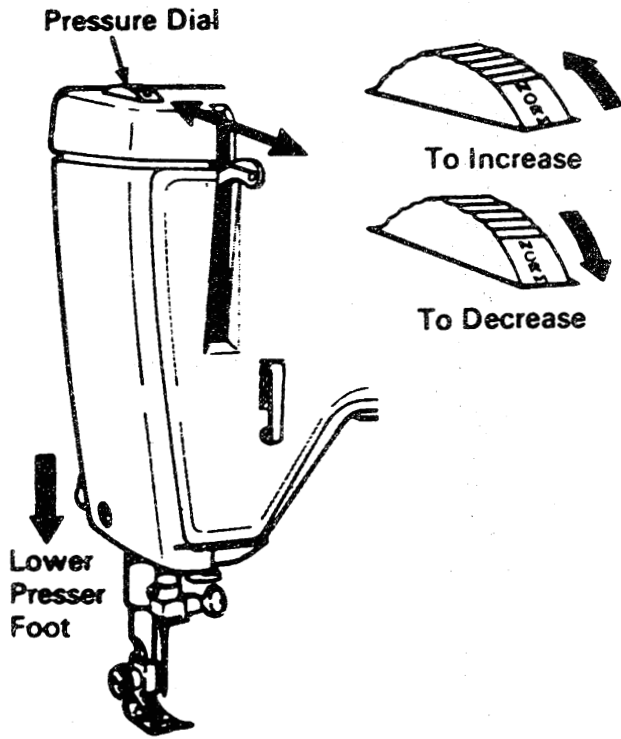

**Adjusting Pressure Dial**

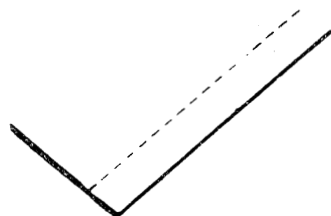
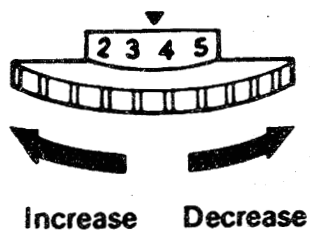
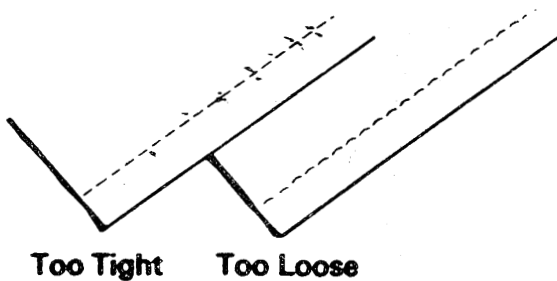

**Adjusting Thread Tension**

## ADJUSTING PRESSURE

Numbered settings on pressure dial will assist you in obtaining correct pressure for fabric you are using. NORM (normal) setting is an all purpose setting for sewing a wide variety of fabrics of different weights and textures. Settings above and below NORM setting are also provided. When you need extra control, regulate the setting to heavier or lighter pressure to suit fabric being sewn.

When darning without an embroidery hoop, set dial at lowest setting, #. See page 42 for instructions.

*Lower presser foot before setting pressure.*

- To *increase* pressure, turn dial from NORM (normal) toward MAX (maximum).
- To *decrease* pressure, turn dial from NORM (normal) toward #.
- For darning, set dial on #.

## REGULATING THREAD TENSION

Correct tension is important because too much or too little will weaken your seams or cause your fabric to pucker. Make a test sample with fabric and thread you plan to use and examine it. A perfect stitch will have needle and bobbin threads locked between two layers of fabric with no loops on top or bottom and no puckers.

The tension dial regulates the degree of tension on your needle thread. Set it according to the type of thread and fabric you use. The numbers on the dial eliminate guesswork in duplicating settings.

If the stitches in your test sample look loose, increase needle-thread tension. If the fabric puckers, decrease tension.

- To *increase* tension, turn dial to higher number.
- To *decrease* tension, turn dial to lower number.

# sewing a seam

## PIN BASTING

Pin basting is a time-saver and can be used when you sew easy-to-handle fabric. Use fine pins and place them:

- On top of the fabric (never on the underside in contact with the feed).
- At right angles to the stitching line.
- Just nipping into the fabric at the stitching line (never extending under both sides of the presser foot).

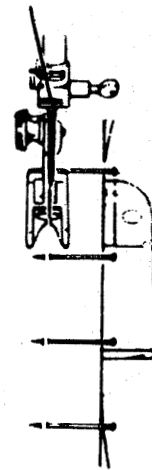

## STARTING A SEAM

1. Set stitch length dial for desired length.
2. With presser foot up, align fabric with appropriate seam guideline on needle plate (as described on the following page). Position needle in fabric about 1.2 cm from the back edge.
3. Lower presser foot. Backstitch to the edge of the fabric for reinforcement by pushing in the reverse-stitch push button located in the center of the stitch length dial. Hold the button until the stitches reach the edge of the fabric and then release for forward stitching.

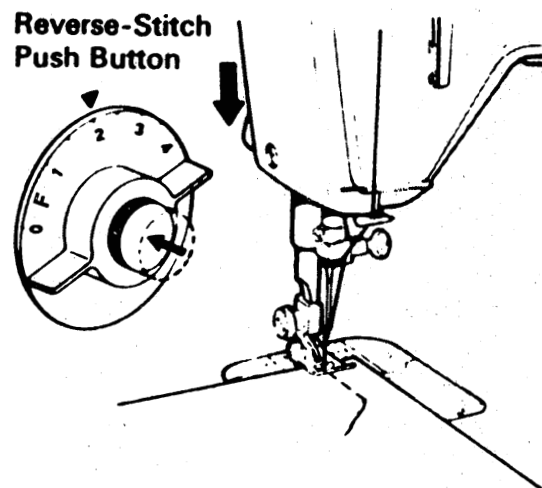
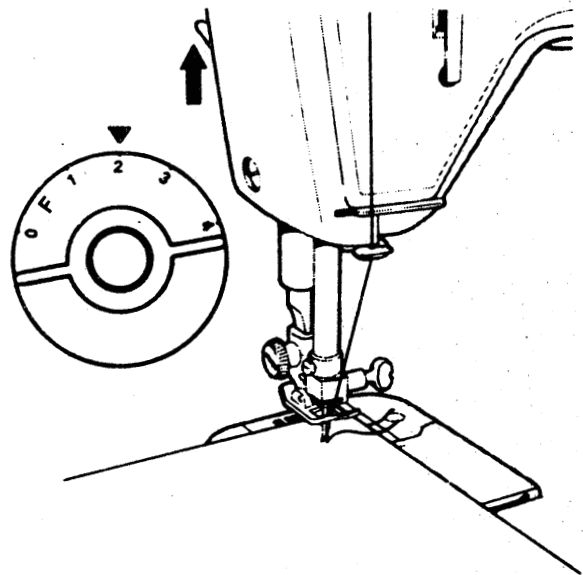

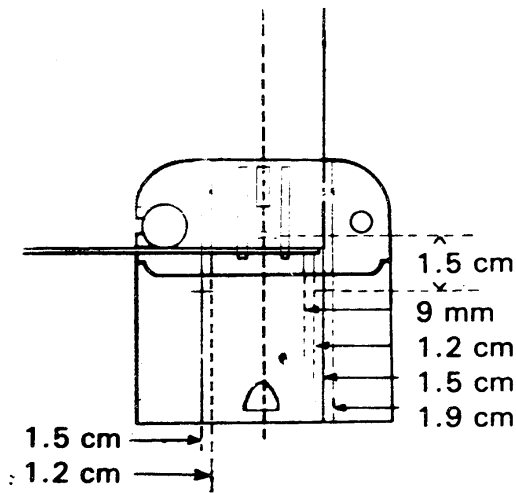

**Using Guidelines**

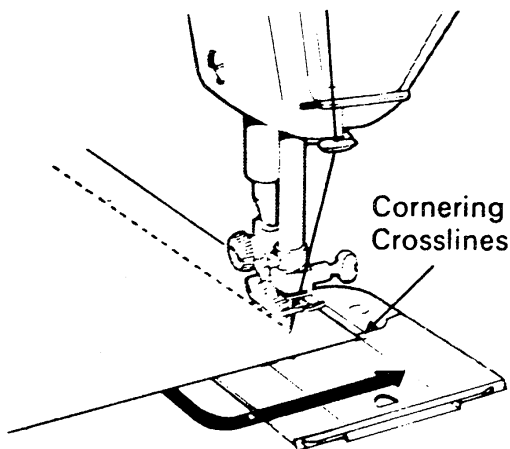

**Fabric at Crosslines**

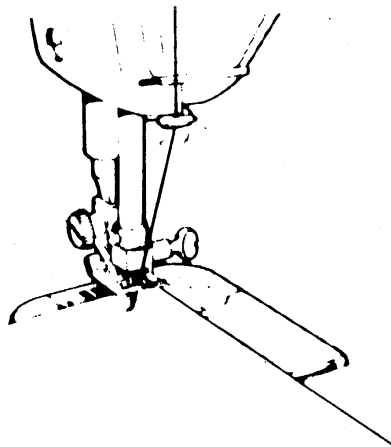

**Fabric after Turning  
Pivoting at Corner**

## KEEPING THE SEAM STRAIGHT

As you stitch, use one of the numbered lines on the needle plate as a guide for keeping the seams straight. Numbers indicate distances in eighths of a cm from the needle. If you want a 1.5 cm seam, for example, keep the righthand edge of your fabric on the number 5 guideline.

## TURNING SQUARE CORNERS

To turn a square corner 1.5 cm from the fabric edge, you need not measure or mark the seam. Simply use the crosslines on the slide plate.

- Line up your fabric with right or left guideline 5 on the needle plate. Stitch seam, slowing speed as you approach corner.
- Stop stitching, with the needle down, when the bottom edge of the fabric reaches the cornering crosslines on the slide plate.
- Raise presser foot and turn fabric on needle, bringing bottom edge of fabric in line with guideline 5.
- Lower the presser foot and stitch in new direction.



## GUIDING AND SUPPORTING THE FABRIC

Most fabrics need only to be *guided* in front of the presser foot. Some fabrics, however, require *support* while being stitched. Filmy sheers, panne velvet, and tricots, for example, need to be held taut in front and back of the presser foot while being sewn.

**WARNING:** Do not pull the fabric while you are stitching as this may deflect the needle causing it to break.

### REINFORCING END OF SEAM

1. Stitch to the fabric edge.
2. Push in reverse-stitch push button and backstitch 1.5 cm to reinforce the end of the seam.
3. Raise presser foot and remove fabric by drawing it to the back and left.
4. Cut threads on thread cutter at rear of presser bar.

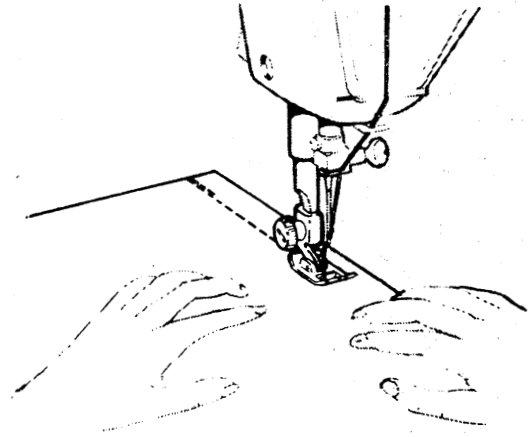

Guiding Fabric

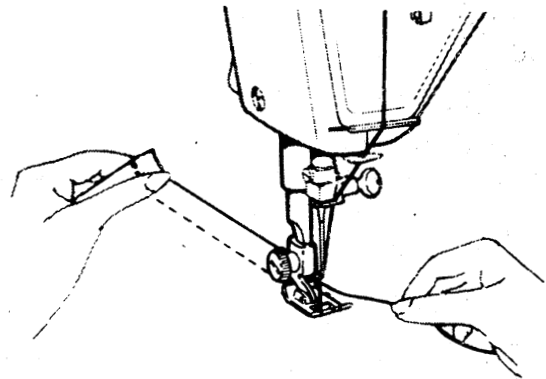

Supporting Fabric

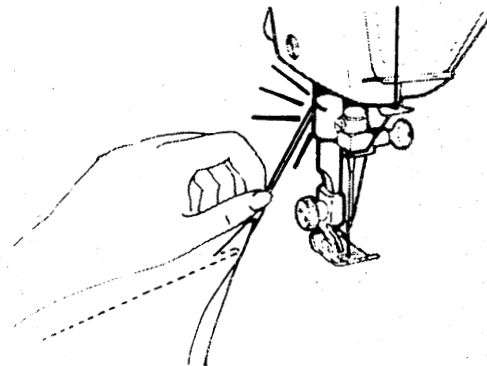
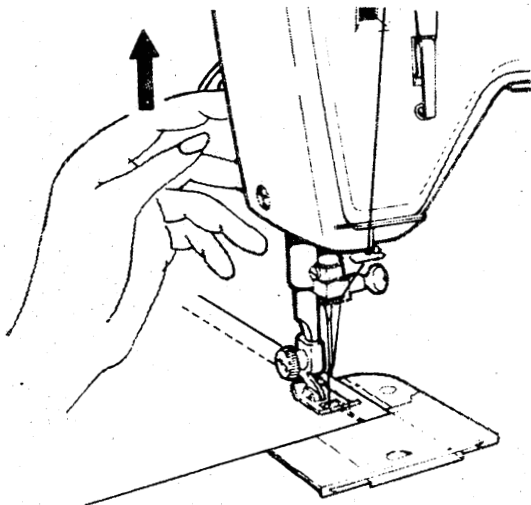

Ending a Seam

*Before moving stitch width and needle position selectors make sure needle is above fabric.*

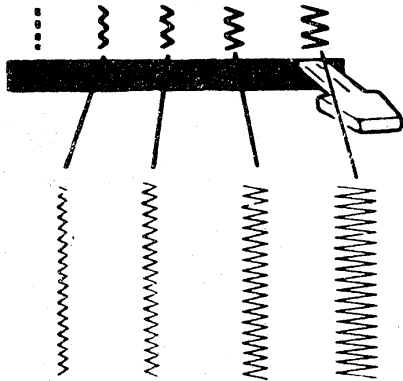

**Adjusting Stitch Width**

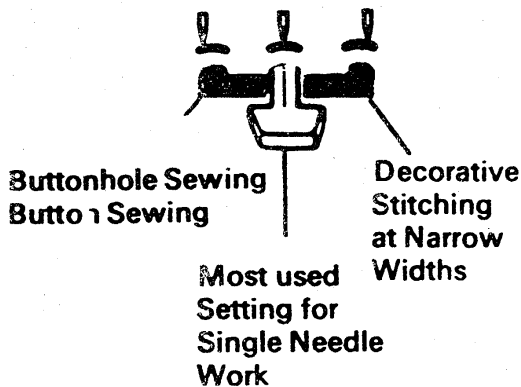



**Adjusting Stitch Placement**

### ADJUSTING WIDTH OF DESIGN

To produce a zig-zag stitch pattern, move the stitch width selector from straight stitch setting  to any zig-zag setting to the right. Stitch width is increased as the selector is moved to the right.

### ADJUSTING STITCH PLACEMENT

Most of your basic zig-zag stitching will be done in center () needle position. Left () and right () settings are used for special stitch placement, as in buttonhole sewing and button sewing.

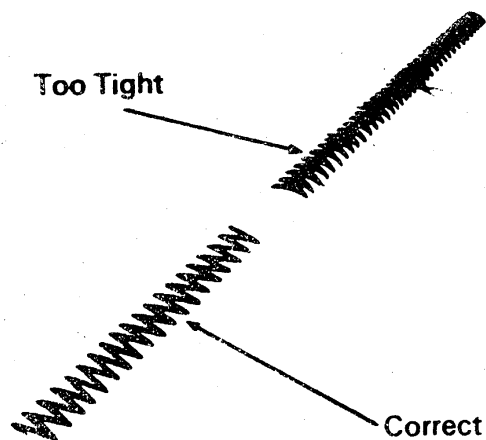
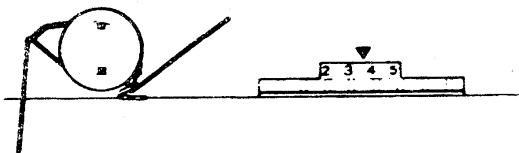

**Adjusting Needle-Thread Tension**

### ADJUSTING NEEDLE-THREAD TENSION

Zig-zag stitching requires less needle-thread tension than straight stitching. Make a test sample with the fabric and thread you plan to use so that you can adjust the tension properly. The stitches should lie flat against the fabric without causing the fabric to pucker.

If the stitches are not flat and the fabric is puckered, reduce needle-thread tension by turning the dial to a lower number.

## ADJUSTING STITCH LENGTH

Any stitch length setting from 1 to 4 will give you an open zig-zag stitch. The higher the number, the more open, or farther apart, your stitches will be. The stitch area, between 0 and 1 on the dial, is used for adjusting zig-zag satin stitching (see next page for specific instructions).

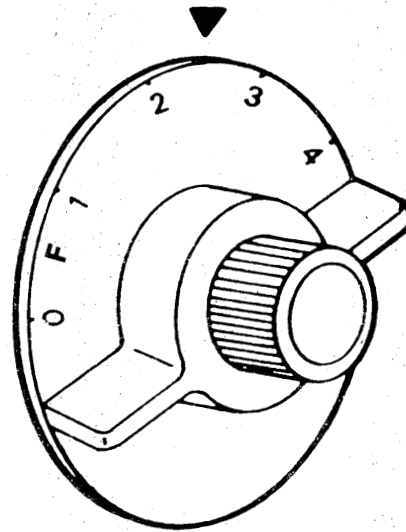

**Stitch Length Dial**

## ADJUSTING PRESSURE AND CHOOSING ACCESSORIES

Turn to page 18 under "Straight Stitching" for instructions on adjusting pressure.

For information on choosing accessories, refer to pages 6 and 7 and to detailed instructions for sewing with zig-zag stitch patterns included in the section called "Sewing the Professional Way" that starts on page 31.

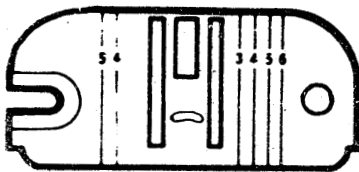

**General Purpose  
Needle Plate**



**General Purpose  
Foot**

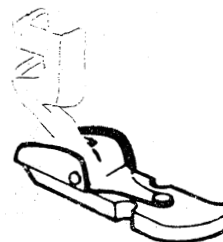

**Zipper Foot**

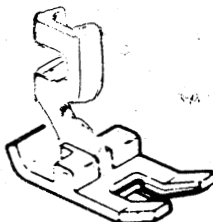

**Special Purpose  
Foot**

# satin stitching

Satin stitching—a series of closely spaced zig-zag stitches that form a smooth, satin-like surface—is useful for both practical and decorative work.

When you wish to produce a satin stitch for appliqué or bar tacks, for example, make a test sample first so that you can adjust the stitch length and thread tension properly. Soft fabrics may require a backing to ensure firm satin stitching.

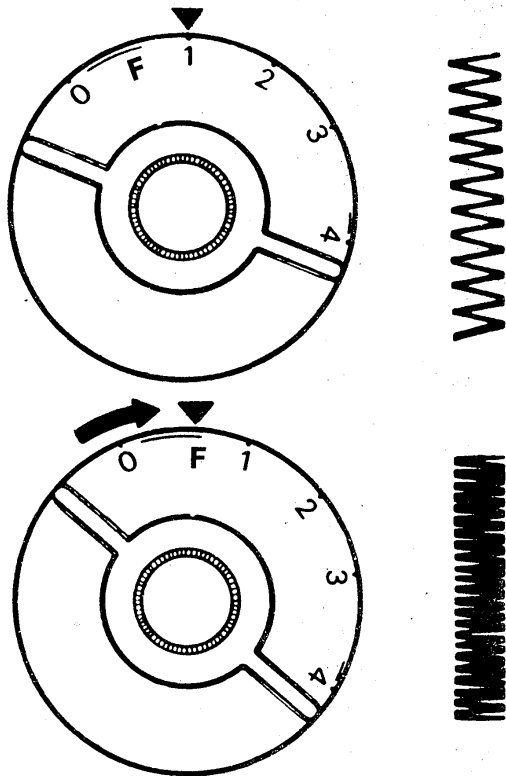

**Adjusting Stitch Length**

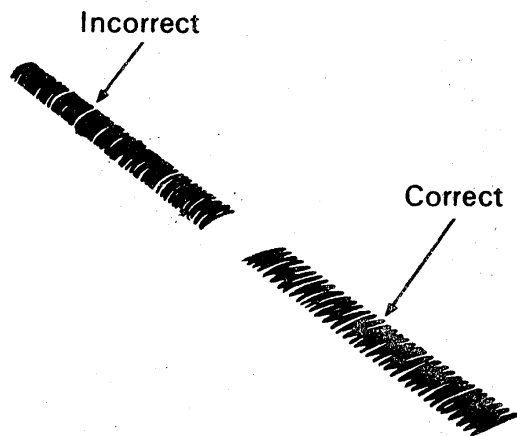
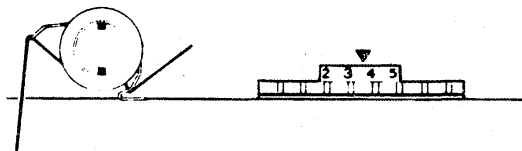

**Adjusting Thread Tension**

## ACCESSORIES AND SELECTOR SETTINGS

- Needle Position:
- Stitch Width: to
- Stitch Length: 0-1
- General Purpose Needle Plate
- Special Purpose Foot
- Pressure: NORM

## Adjusting Stitch Length

1. Turn stitch length selector dial to 1 (the beginning of 0-1 area).
2. Run machine at a slow speed.
3. Gradually turn the stitch length dial clockwise until stitches are closely spaced and form a smooth surface.



## Adjusting Thread Tension

Satin stitching requires less tension than straight stitching or open zig-zag stitching. Furthermore, the wider the stitch, the lighter the tension on the thread must be. Notice the stitching on your sample. If the fabric is puckered, lower the needle-thread tension by turning the tension dial to a lower number.

By using a twin needle, you can produce two parallel, closely spaced, decorative lines of stitching simultaneously. You can use either one or two colors of thread and you can choose either a straight-stitch or zig-zag stitch.

## SETTING THE MACHINE

### Straight Stitching

- Needle Position:  only
- Stitch Width: 
- Stitch Length: Optional
- General Purpose Needle Plate
- General Purpose Foot

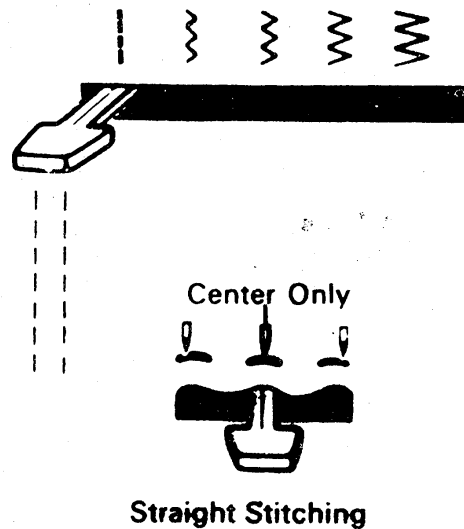

### Zig-Zag Stitching

- Needle Position:  only
- Stitch Width: See illustrations at right
- Stitch Length: Optional
- General Purpose Needle Plate
- General Purpose Foot (Open Stitching)
- Special Purpose Foot (Satin Stitching)

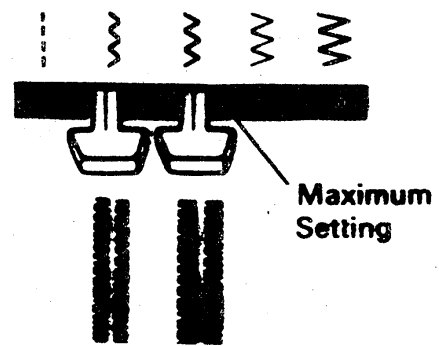

Center (  ) needle position setting must be used. Stitch width must not exceed settings illustrated at right.

Use twin needle, Type 705 H (size 90).

### INSERTING THE TWIN NEEDLE

Before inserting the twin needle, make sure you are using the general-purpose needle plate and that the needle position dial is set at , and the stitch width does not exceed the settings shown on page 25.

To insert the twin needle, simply raise needle to its highest point and loosen the needle-clamp screw. Remove the single needle and insert the twin needle in its place. Tighten needle-clamp screw securely.

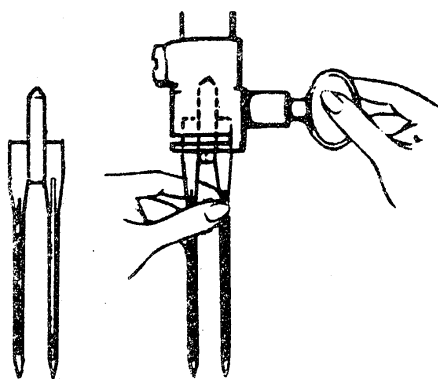



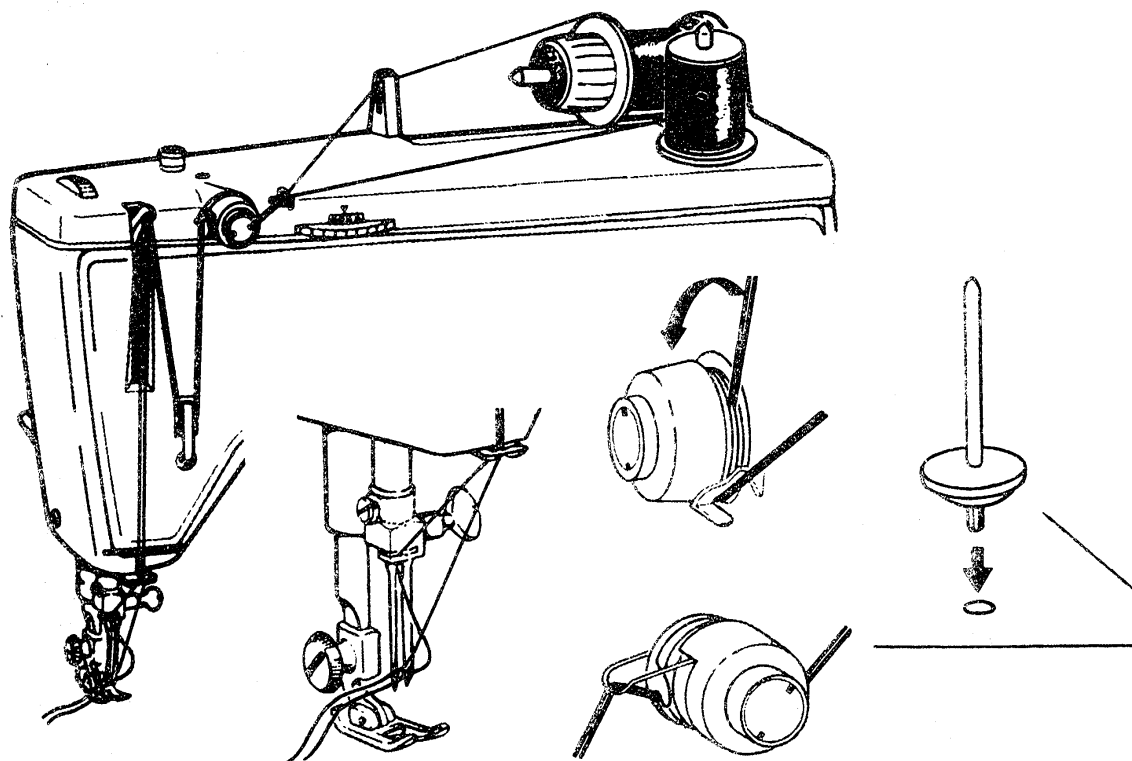

### *threading for twin-needle stitching*





For best results, use No. 50 mercerized or synthetic thread. Thread the machine as for single-needle stitching, except pass thread between center and back tension discs, and through right eye of needle. Attach secondary spool pin in hole on top cover. Pass thread from second spool through guide (by-passing the snap-in thread guide post) as illustrated, then between center and front tension discs. Thread through remaining points, making certain to omit the thread guide above the needle and pass thread through left eye of needle.



# buttons

- Needle Position:  (left)
- General Purpose Presser Foot
- Feed Cover Plate

Flat buttons can be sewn on quickly and easily using the plain zig-zag stitch. The space between the holes in the button determines stitch width settings. For buttons with standard hole spacing, use settings  and  as shown. For buttons with unusual hole spacing, use setting  and increase or decrease the width () as necessary.

1. Attach feed-cover needle plate (see page 7).
2. Set stitch width at  and needle position at  (left). Position button under foot and lower needle into center of left hole by turning hand wheel toward you. Lower foot. Turn hand wheel toward you until needle rises out of button and is just above the foot.
3. Set stitch width at medium-wide zig-zag () setting. Check stitch width by turning hand wheel slowly toward you; the needle should enter the right hole of the button. Take six or more zig-zag stitches to attach button. End on left side.
4. To fasten stitching, return to stitch width  and take three or four stitches. Remove feed-cover plate from the general-purpose needle plate when work is completed.

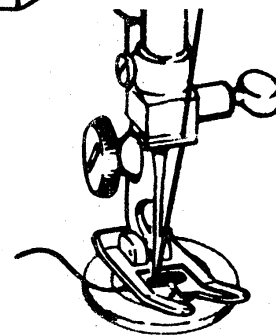
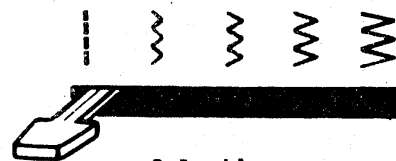
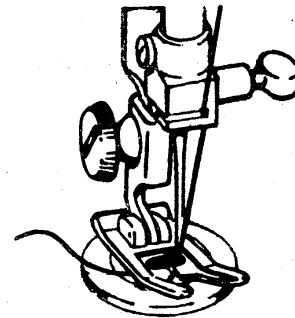
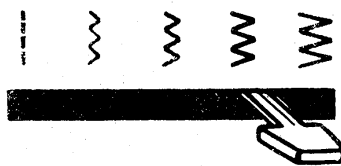
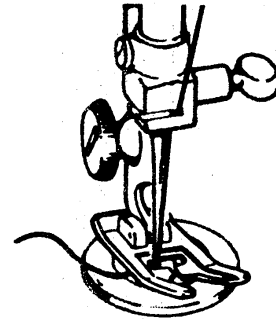
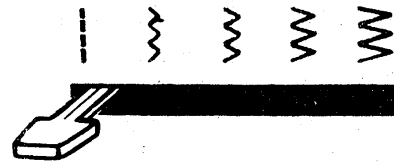

# buttonholes

## Horizontal Placement on Crosswise Grain

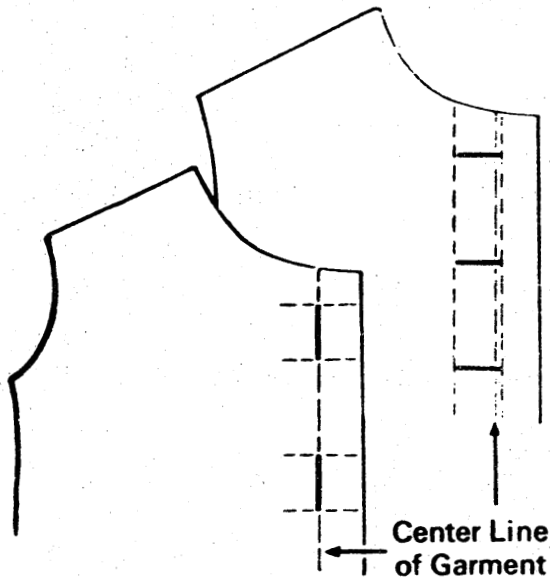

## Vertical Placement on Lengthwise Grain

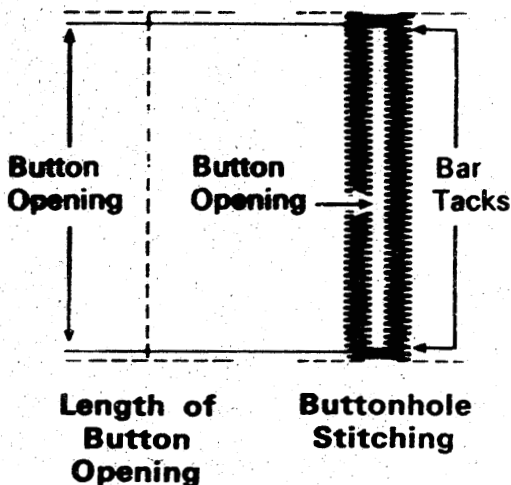
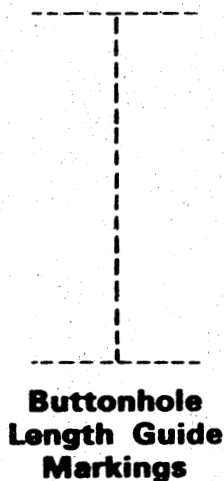

## BUTTONHOLE POSITION

Accurate guidelines are essential to keep buttonholes a uniform distance from the faced edge of the garment, evenly spaced, and on the grain of the fabric. For center closures, place guidelines as follows:

1. Mark the center line of the garment as indicated on your pattern. This guideline can be hand basted and should follow a lengthwise fabric thread.
2. Mark a position guideline for each buttonhole.

- *Horizontal* buttonholes are placed to extend 3 mm beyond the center-line basting of the garment. Horizontal guidelines for the buttonholes should follow a crosswise thread of the fabric, and, if basted, be longer than the finished length of the buttonhole. Determine the length of the buttonhole (as described below) and mark ends of each buttonhole vertically.
- *Vertical* buttonholes are placed so that the center-line basting of the garment is in the center of the buttonholes. Determine buttonhole length and mark ends of each buttonhole horizontally across the center line and use the center-line basting as a buttonhole guide when stitching.

## BUTTONHOLE LENGTH

First, decide how long the button opening must be. Then, add 2 mm to the measurement for *each* bar tack (the closing stitches at each end of the buttonhole). To find the length of the button opening, cut a slit in a scrap of fabric the diameter of the button you intend to use. Increase length of opening until button slips through easily.



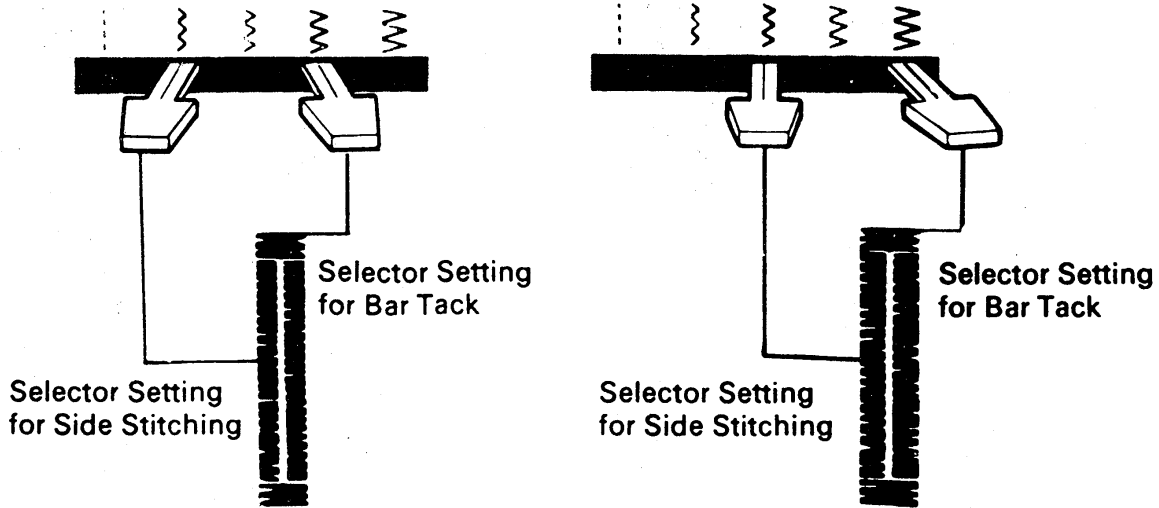

## STITCH WIDTH

Two stitch width settings are required for making buttonholes: one for side stitching and one for the bar tack. Two possible combinations are illustrated.



### Procedure

Set stitch length in 0-1 area of stitch length dial. Attach special purpose foot. Set the pattern selector at , needle position selector at , and stitch width selector at the width desired for the side stitching. Place work under needle, aligning center marking of buttonhole with center slot in the special purpose foot.

### Side Stitching

Position needle in fabric at point A. Lower foot and stitch to end of marking. Leave needle in fabric at point B. Raise foot and pivot work on needle. Lower foot. Take one stitch without changing width setting, bringing work to point C.

### Bar Tack

Adjust stitch width selector for bar tacks and take at least six stitches. Stop at point D.

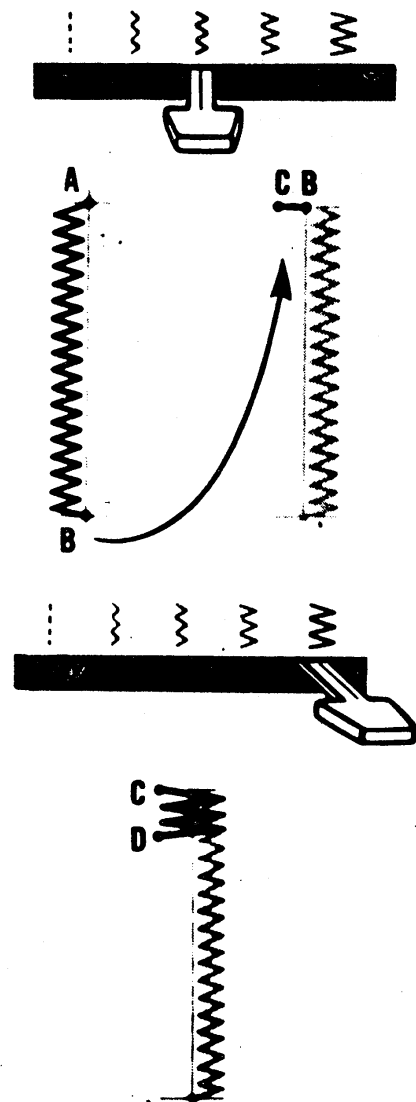

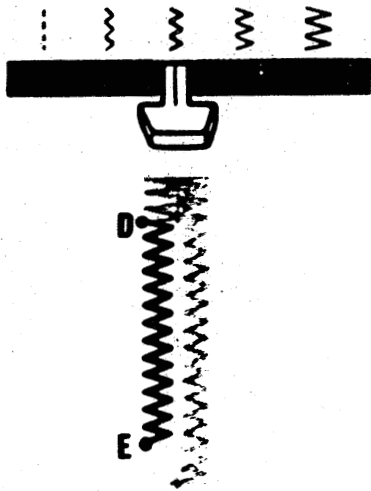

### Side Stitching

Readjust stitch width selector for side stitching. Complete work to point E. Leave needle in fabric.

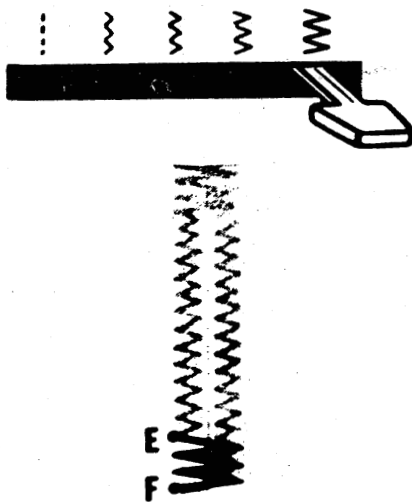

### Final Bar Tack

Adjust stitch width selector for bar tacks, and take at least six stitches ending at point F.

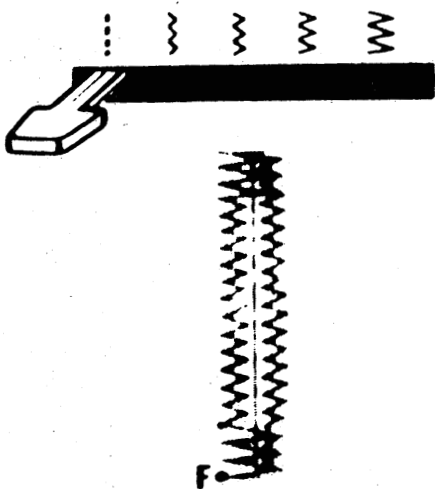

### Fastening Stitch

To secure stitching, move selector to  $\vdots$  and take three stitches. Remove work, draw threads to underside, fasten, and trim. Cut opening for button with sharp scissors.

## LINGERIE SEAMS

To make seams in lingerie durable and flexible, use a combination of straight and zig-zag stitching.

### Method 1

For 1.5 cm bias seam in woven fabric:



- Straight-stitch the seam (with stitch width at  $\frac{1}{2}$ ) on wrong side of fabric.
- Press both seam allowances in the same direction. Then, from the right side, top-stitch with narrow zig-zag stitching, letting needle alternately enter seam line and seam thickness.

### Method 2

For narrow seams in nylon tricot:

- Cut fabric for 1.5 cm seam allowance.
- Straight-stitch seam line on wrong side of fabric. Then place a line of medium-wide, open zig-zag stitching close to the straight stitching.

## SEAM FINISHES

- Needle Position: 
- Stitch Width:  or  (maximum)
- Stitch Length: 1, 2 to 3 mm depending on choice of stitch and fabric
- General Purpose Needle Plate and Foot

Seam edges support the garment and should be given a durable finish if the fabric is likely to ravel. There are two methods of finishing seams in such fabrics: trimming seam edge or overedging. Make a test sample first to determine which method best suits your fabric.

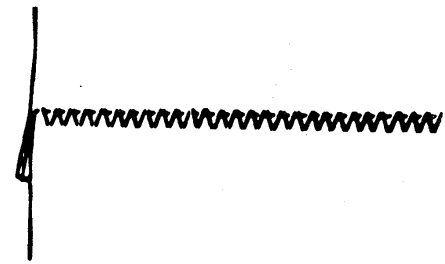

For a 1.5 cm Seam

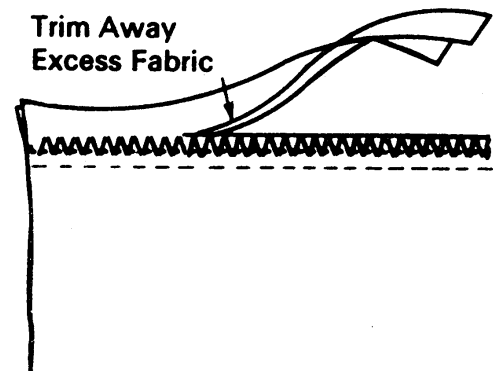

For a Narrow Seam

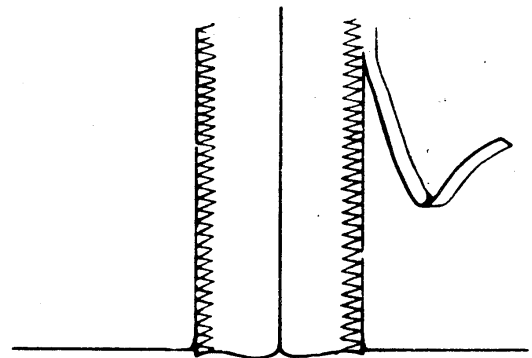

Trimming Seam Edges after Stitching

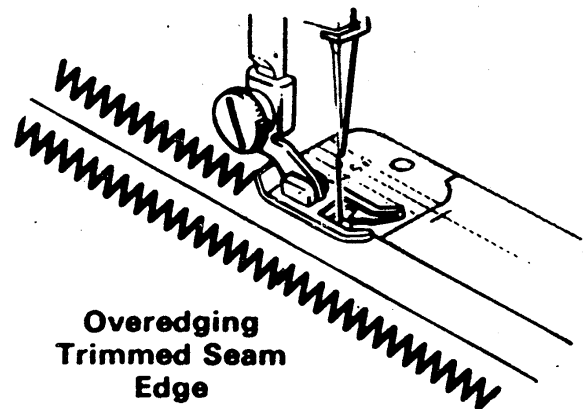

# hints on sewing special fabrics

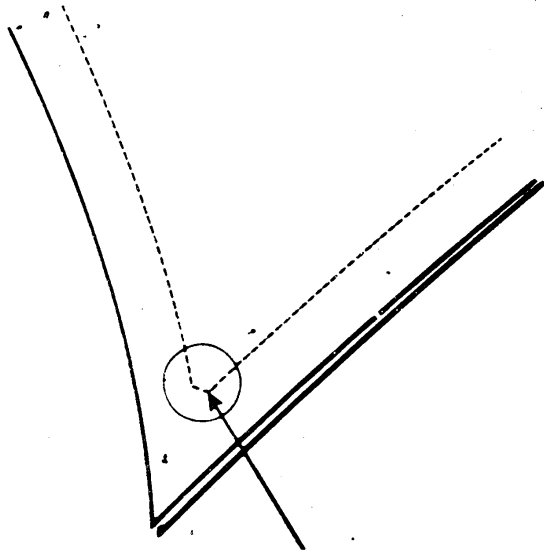

**Diagonal Stitching  
Across the Point**

## LEATHER-LOOK VINYL

- Use masking tape or zipper adhesive tape instead of pins or basting to hold seams, zippers and hems in place for stitching.
- Stitch with a long stitch (1 to 3 mm). A short stitch may cut the fabric.
- Sew with a steady, even pace and stitch accurately. Seams cannot be ripped out without leaving needle marks in the fabric.
- The shiny side of some vinyls tends to stick to metal surfaces. Use a strip of tissue paper between the fabric and metal machine surfaces to prevent this.
- Topstitching holds seams and garment edges smooth and flat and adds a decorative note.
- Reinforce button and buttonhole areas with interfacing. Bound buttonholes are the best choice for vinyls with knit backing.
- For sharp points on collars and lapels, take one or two stitches diagonally *across* the point to allow enough space to smoothly enclose the seam edge.

## CIRÉ (Wet-Look Taffeta and Tricot)

- Use masking tape or zipper adhesive tape instead of pins or basting to hold seams, zippers, and hems in place for stitching.
- Stitch accurately; seams cannot be ripped out because needle marks remain in the fabric.
- Sew seams under light tension by holding fabric slightly taut at front and back of needle.
- Stitch ciré taffeta with a fairly long stitch 2,5 to 3 mm and use an enclosed edge finish for seams and hems.
- Stitch ciré knits with a medium length-stitch 2 mm and use a fine ball-point needle.
- Machine-worked buttonholes (as well as bound buttonholes) can be made in ciré fabric. Always use an interfacing and make sure the close zig-zag stitches do not cut the fabric.

## DEEP-PILE FABRICS (Fake Fur)

- Pin, rather than baste, seams. Place pins at close intervals at right angles to the seam line. Pins with colored heads are easy to see and remove.
- Sew in direction of nap.
- Stitch with a fairly long machine stitch (2,5 to 3 mm) and use polyester/cotton thread in a size 90 or 100 Type 705 H needle.
- As seam is stitched, smooth pile away from seam allowance with a darning needle or upholstery pin.
- After stitching seams with a 1.5 cm seam allowance, use small hand scissors to shear pile from entire seam allowance to reduce bulk.
- Stitch 6 mm pre-shrunk tape into neckline and shoulder seams for stability and reinforcement or stitch with the straight stretch stitch.
- Leather and leather-look fabrics complement fur fabrics; use them for bound buttonholes and easy button loops.
- Coat hems are less bulky if they are narrow and finished with a 8 cm fabric facing or grosgrain ribbon.
- Slash through the center fold of darts and finger-press open, or stitch with a narrow zig-zag stitch and trim away excess fabric after stitching.

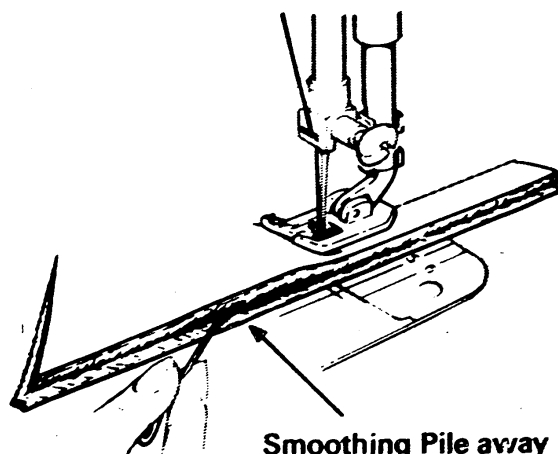

Smoothing Pile away from Seam Allowance

### Deep-Pile Fabrics

## VELVET AND VELVETEEN†

- Use a light-pressure dial setting to prevent crushing pile.
- Mark and baste with silk thread.
- Use a Type 705 H, size 80 needle, and a fine thread for seaming. "A" silk or nylon thread is recommended for velvet.
- Always stitch in the direction of the nap.
- For unpuckered seams, pin or hand baste together and then stitch under light tension (see page 18). Extra-long, straight seams may be machine basted with a long, wide zig-zag stitch.
- To sew panne velvet, use a ball-point needle and a shorter-than-normal stitch length (1.5 to 2 mm).



# construction details

## ZIPPERS

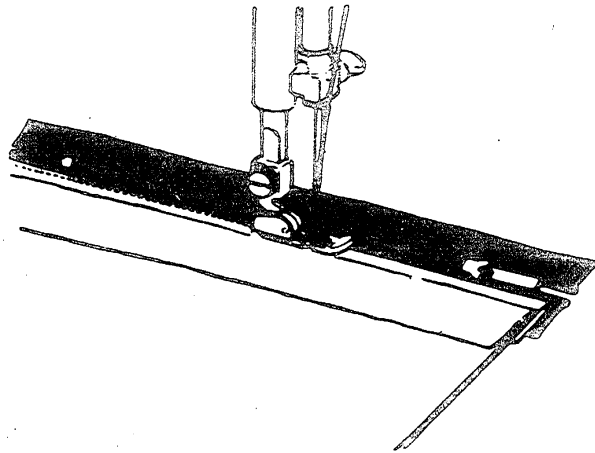
At the notions counter in your Sewing Center, you will find many different kinds of zippers, one of which will be just right for whatever you want to sew. The zipper package will contain easy-to-follow instructions for inserting the zipper. And, with the zipper foot, you will find it easy to form an even line of stitching close to the zipper.



Zipper Insertion

- Needle Position: 
- Stitch Width: 
- General Purpose Needle Plate
- Zipper Foot 

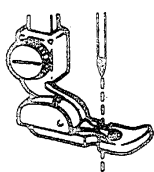
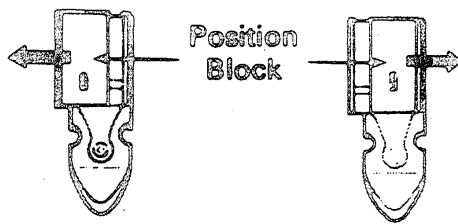

Zipper Foot  
to Left of Needle

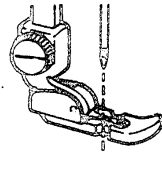

Zipper Foot  
to Right of Needle

### Attaching the Zipper Foot

When the zipper is to the *right* of the needle:

- Move position block on zipper foot to left, to allow shank to enter right side of foot, so that needle will enter right notch in foot.

When the zipper is to the *left* of the needle:

- Move position block on zipper foot to right, to allow shank to enter left side of foot, so that needle will enter left notch in foot.

(The zipper foot is snapped onto shank as instructed on page 7.)

## CORDED SEAMS

The corded seam is a professional treatment for slipcovers, children's clothes, blouses, and lingerie. To make a corded seam, make the welting first (or buy it ready-made at a notions counter), then stitch it into the seam. For both steps, use the zipper foot to place the stitching close to the cord.

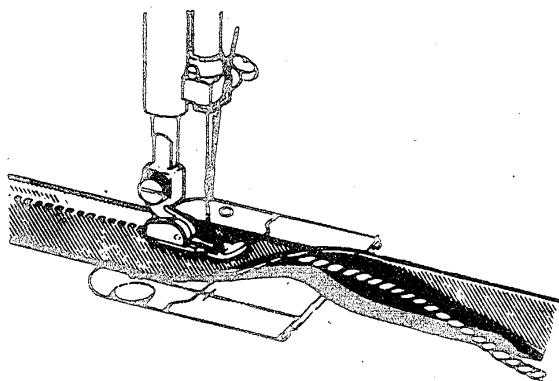

Making Welting for a  
Corded Seam

## TOPSTITCHING

A practical, simple way to accent the lines of a dress or coat is to place one or more rows of stitching along collars, lapels, facing edges, pockets, seams, etc. For a tailored look, use lines of regular straight stitching; sew them with button-hole twist for added emphasis. For decorative interest, use a zig-zag stitch.

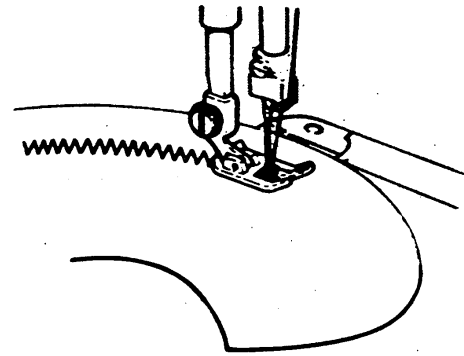

**Topstitching  
with Zig-Zag Stitch**

## Steps in Making a Dart in Interfacing

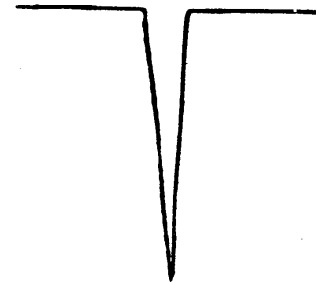

**Step 1**

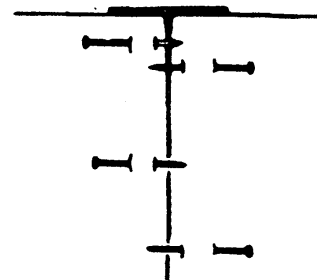

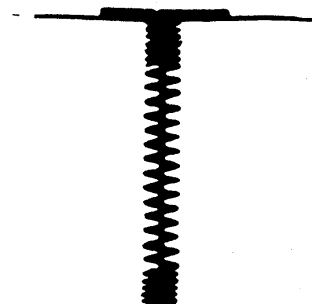

**Step 2**



**Step 3**

## DARTS IN INTERFACING

- Needle Position: 
- Stitch Width:  (maximum)
- Stitch Length: 1 mm or to suit fabric
- General Purpose Needle Plate and Foot

With zig-zag stitching, interfacings can be shaped without bulk.

1. Cut out the dart allowance on the stitching line.
2. Bring raw edges together and pin or baste in place over a muslin stay.
3. Stitch, backstitching at both ends of dart for reinforcement.

## APPLIQUÉ

Appliqué adds beauty and interest to clothing and household linens. You can create your own design, trace a simple outline from a coloring book, or use a motif cut from a printed fabric. Fabrics of like or different texture combine equally well.

A closely spaced zig-zag stitch is most commonly used in appliqué work. Although you may vary stitch width to accommodate fabric weave or texture, never allow the stitch to be too wide.

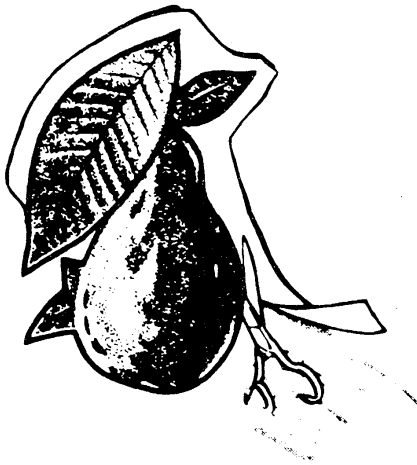

### Preparation

- Baste appliqué design to fabric.
- Outline design with straight stitching (use a short stitch).
- Remove basting and press.
- Attach special purpose foot.

### Appliquing

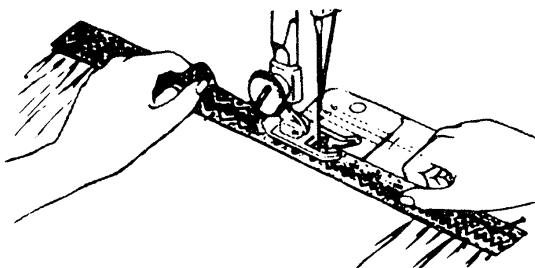

1. Set machine for desired stitch width. Adjust stitch length in the 0-1 area of the stitch length dial.
2. Outline the entire design with appliqué stitching.
3. Cut away the fabric on the outer edges of the stitching with embroidery scissors.



**Attaching Elastic with Plain Zig-Zag**

## ATTACHING ELASTIC

Elastic will remain stretchable when it is attached with the plain zig-zag stitch. The flexible joining produced by this stitch allows elastic banding to be stitched under, over, or between fabric layers, making it particularly useful in the construction of lingerie and swimsuits.

- Needle Position: 
- Stitch Width:  (maximum)
- Stitch Length: About 1.25 mm
- General Purpose Needle Plate and Foot



# free arm sewing

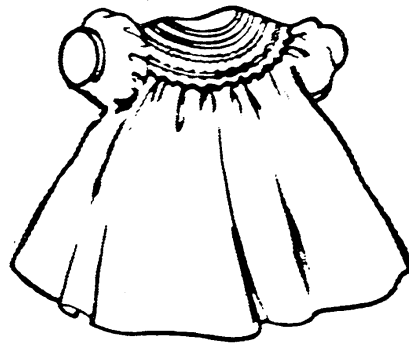
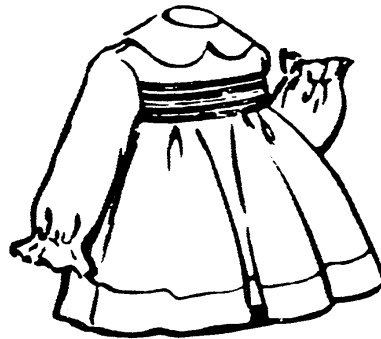
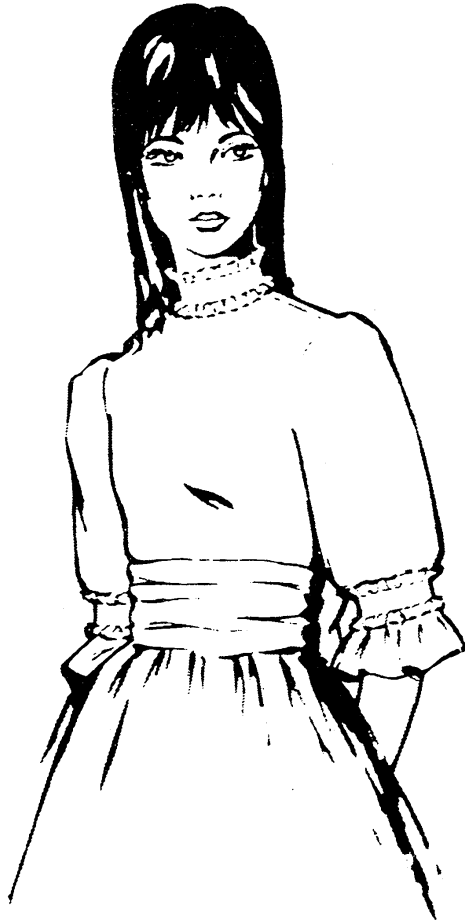

Free arm sewing simplifies fabric handling when you sew circular and hard-to-reach garment areas. A few of the sewing jobs for which you will find it particularly useful are illustrated. To prepare your machine for free arm sewing, press the extension table release push-button and remove the extension table.

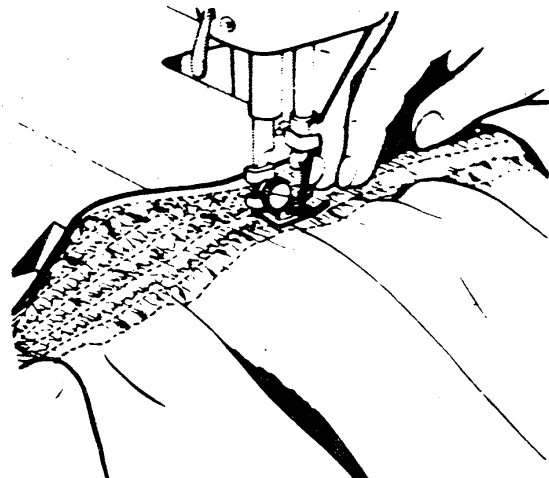

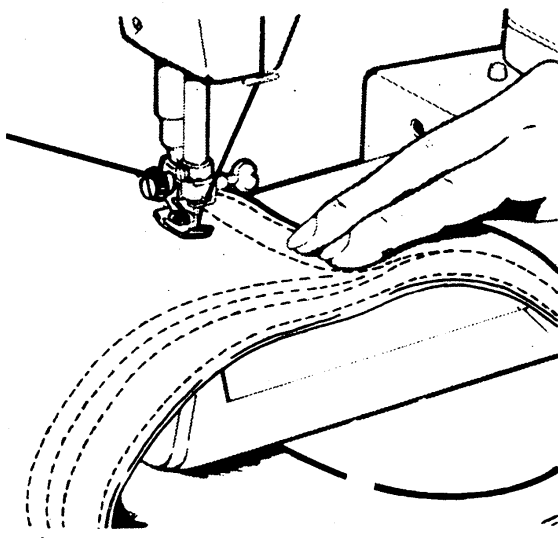
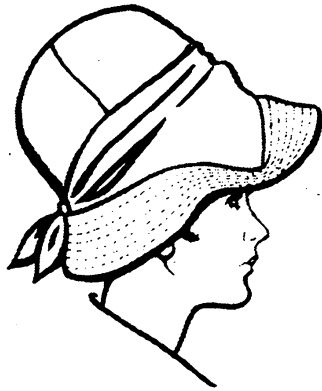

## HATS, BAGS AND DOLLS' CLOTHES

Use the free arm of your machine when you make hats, bags and dolls' clothes. You will find it a real advantage for seaming small circular areas, and in the placement of decorative top stitching.



## CUFFS

Attaching a cuff to a gathered sleeve or accenting it with decorative top stitching is greatly simplified when you use the free arm. The fabric flows smoothly around the bed giving you full visibility and control of the seam line.

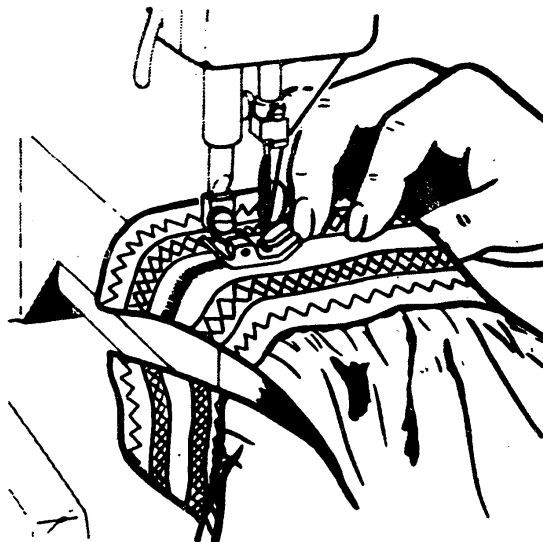

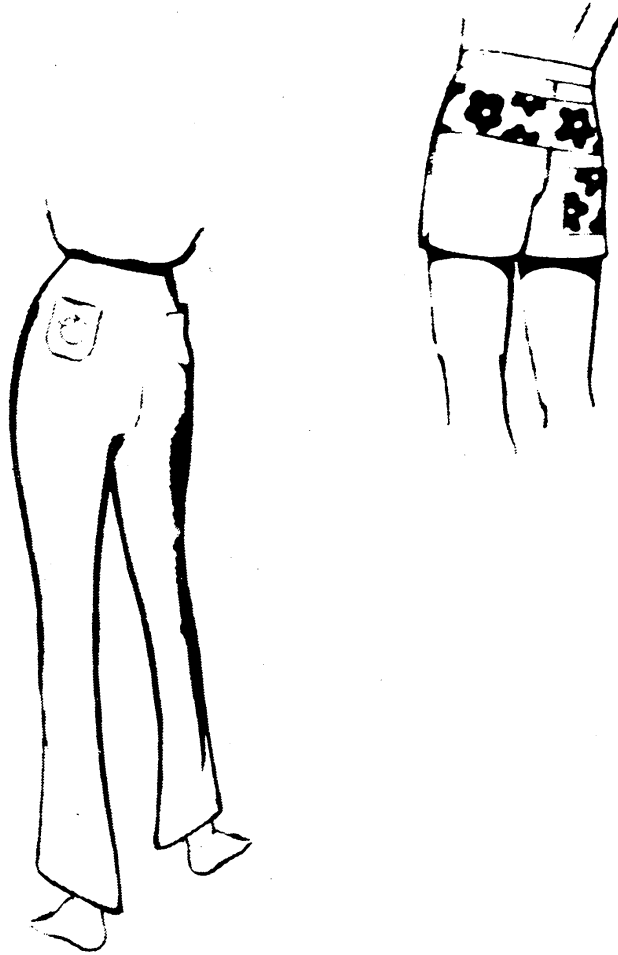

### **BADGES, EMBLEMS AND INSIGNIA**

Badges, emblems and insignia of all sizes and shapes can be quickly attached to shirts and uniforms when the free arm is used. Slip the sleeve or other hard-to-reach area over the free arm and secure emblem with zig-zag sewing.

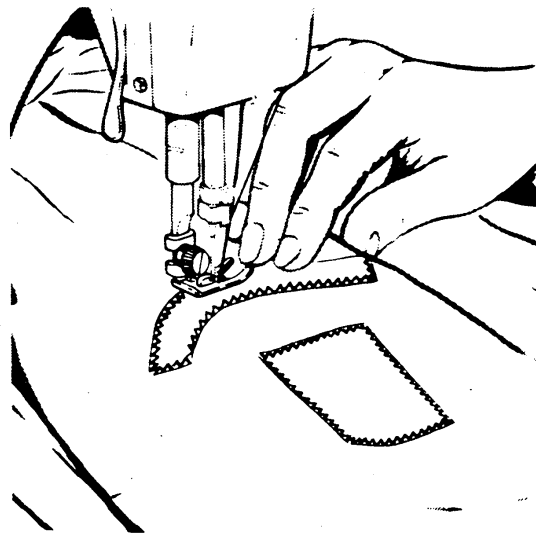



# keeping up appearances

## MENDING

The zig-zag stitch is just as useful for mending as it for creative sewing. It forms a flexible bond for repairing tears or sewing stretch garments.

### Mending a Tear

- Needle Position: 
- Stitch Width:  or  (maximum)
- Stitch Length: About 1 mm
- General Purpose Needle Plate and Foot

1. Trim ragged edges.
2. Place underlay on the wrong side of tear for reinforcement. (It is best not to baste or pin the underlay since you will be bringing the edges of tear together in the next step.)
3. Stitch on the right side, bringing the edges of the tear together.
4. Shorten stitch length at ends and corners to give extra strength.
5. Trim underlay.

### Bar Tacks

Bar tacks, to reinforce points of strain, are made with the zig-zag stitch at satin stitch length. Use them at pocket corners, to attach garters, secure shoulder straps, belt loops and zipper openings.

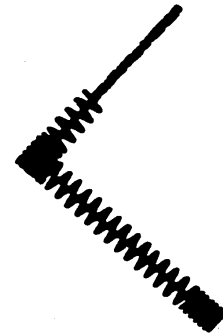

**Tear Mended with Zig-Zag Stitch**

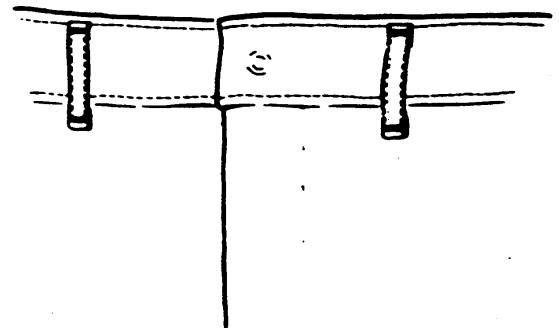

**Bar-Tacked Belt Loops**

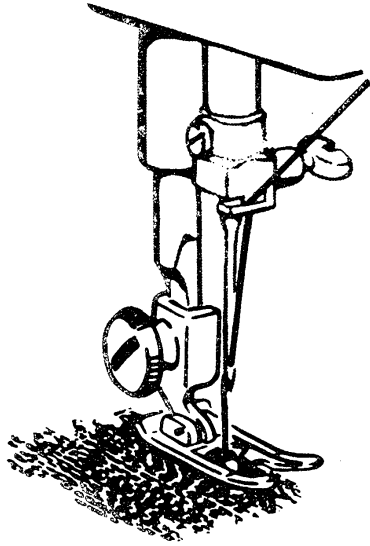

**Darning Without Embroidery Hoop**

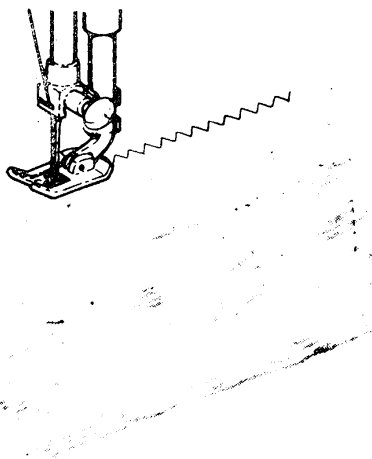



**Stretch Garment Repair**

## DARNING



Worn or torn spots on children's clothes, knits, and household linens can be darned effortlessly and quickly with little practice. You may choose to darn either with or without an embroidery hoop. When greater control is needed, an embroidery hoop is usually best.

### Darning without Embroidery Hoop

- Needle Position: 
- Stitch Width: 
- Stitch Length: 2 mm
- General-Purpose Needle Plate and Foot
- Pressure: 



1. If the area to be darned is open, baste an underlay in place.
2. Place area to be darned under presser foot; lower presser foot and start stitching, alternately drawing fabric toward you and pulling it *gently* away from you.
3. Continue this forward and backward motion as you fill the area with parallel lines of stitching. For additional strength, cover area with crosswise lines of stitching.

### Repairing Stretch Garments

- Needle Position: 
- Stitch Width:  to 
- Stitch Length: 1 or to suit fabric
- General Purpose Needle Plate and Foot

Seams and hems in stretch and elasticized garments retain their elasticity when stitched with the zig-zag stitch. This stitch is particularly effective when used in top-stitch applications (as shown) or to over-edge. Make a test sample to check selector settings.

## Darning with Embroidery Hoop\*

- Needle Position: 
- Stitch Width: 
- Stitch Length: In 0-1 Area
- Feed Cover Plate
- No Presser Foot
- Presser Bar: Lowered

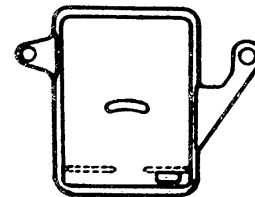

**Feed-Cover Plate**

### Preparation

Remove presser foot with shank (by removing the screw which fastens the shank to the presser bar). Attach feed-cover needle plate. Instruction for attaching the feed-cover plate is given on page 8.

1. Trim ragged edges from area to be darned.
2. Center worn section in embroidery hoop.
3. Position work under needle over feed-cover plate and *lower presser bar to engage tension*.
4. Hold needle thread loosely with left hand, turn hand wheel over and draw bobbin thread up through fabric. Hold both thread ends and lower needle into fabric.
5. Outline area to be darned with running stitches for reinforcement.
6. Stitch across opening, moving hoop under needle at a slight angle from lower left to upper right. Keep lines of stitching closely spaced and even in length.
7. When opening is filled, cover area with crosswise lines of stitching.

This method of controlling fabric movement with an embroidery hoop may be used to do embroidering and monogramming.

\*Embroidery Hoop not included with machine accessories.

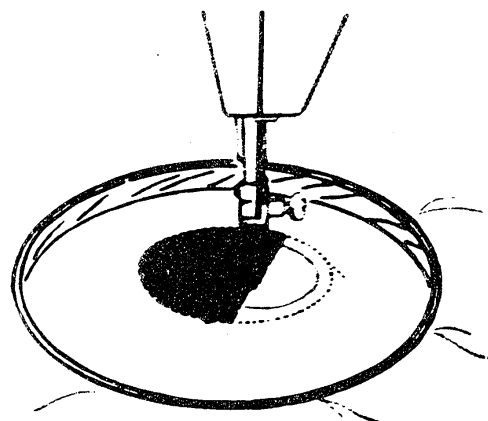
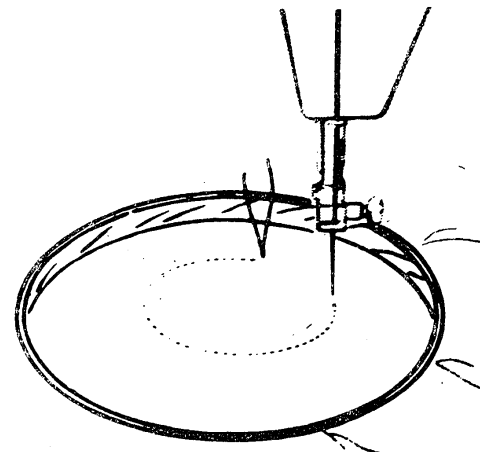

**Darning With Embroidery Hoop**

## cleaning the machine

Your machine will serve you perfectly for many years if you take a few moments of your time to keep it clean. How often you will need to clean the machine will depend on how often you use it.

**WARNING:** Before cleaning your machine, disconnect power-line plug from electrical supply.

Clean between  
tension discs

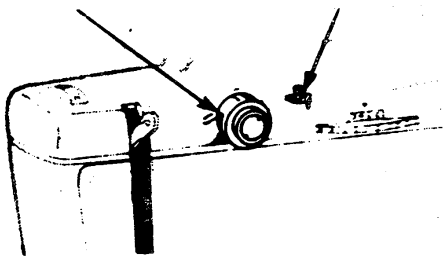

Clean

Remove lint from exposed parts.

With a soft cloth, clean:

- Tension discs, take-up lever, and thread guides.
- Presser bar and needle bar.
- Bobbin case. (If there is an excessive amount of lint in the area, remove the bobbin case for cleaning. See page 45 for instructions.)
- Machine surface. (If necessary, dampen the cloth and use a mild soap.)

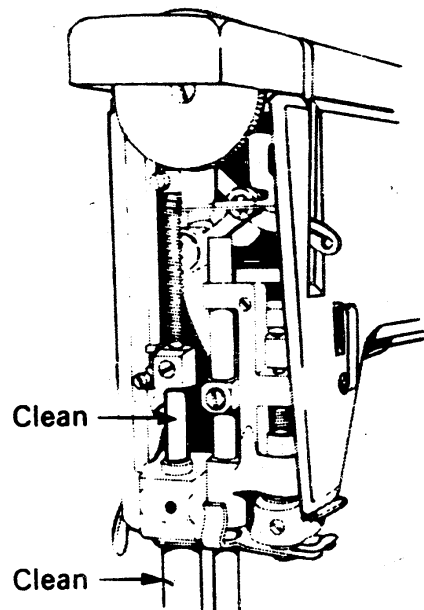

Clean

Clean

Remove face plate as instructed on page 45 and clean area behind it with a lint brush.\*

Remove needle plate as instructed on page 7 and, using a brush, clean the rotating hook area under the needle plate and slide plate.

**NOTE:** Your machine requires oiling at only one point under normal conditions.

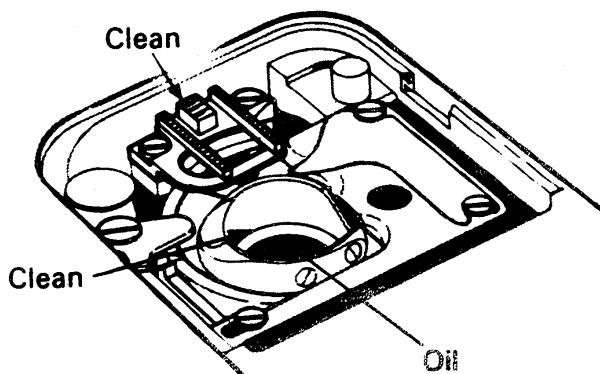

Clean

Clean

Oil

\* Brush not included with machine accessories.



# removing bobbin case, face plate and bulb

**DANGER:** Before removing bobbin case, face plate and light bulb disconnect power-line plug from electrical supply.

## REMOVING AND REPLACING BOBBIN CASE

- Raise the presser foot.
- Turn hand wheel toward you until needle is above the presser foot.
- Remove needle plate as instructed on page 7.
- Remove bobbin.

To remove bobbin case, turn bobbin case holder to back as far as it will go. Lift out bobbin case.

To replace bobbin case, guide the forked end under the feed and then draw the bobbin case under the position plate as illustrated. Turn holder all the way forward to lock bobbin case in position. After locking bobbin case in position, check that bobbin case is not jammed, but has slight rotational movement.

- Replace needle plate.
- Fully close slide plate.

## REMOVING FACE PLATE

- Loosen and remove screw and remove face plate by sliding it downward.

## REPLACING FACE PLATE

- Slide face plate up so that rim is engaged under edge of top cover.
- Align screw hole at lower edge of plate with screw hole in machine and replace and tighten screw.

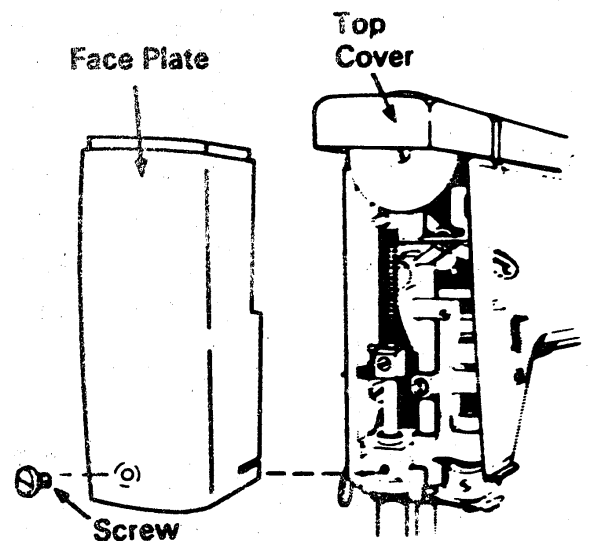
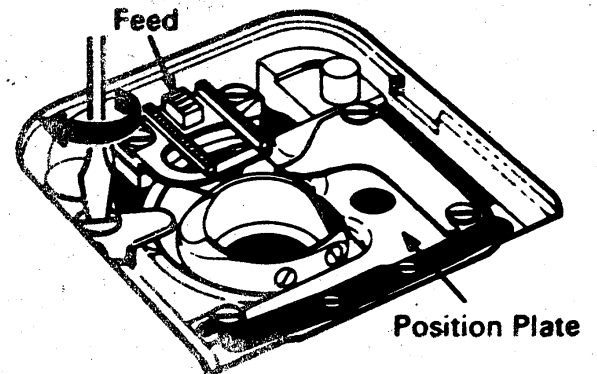
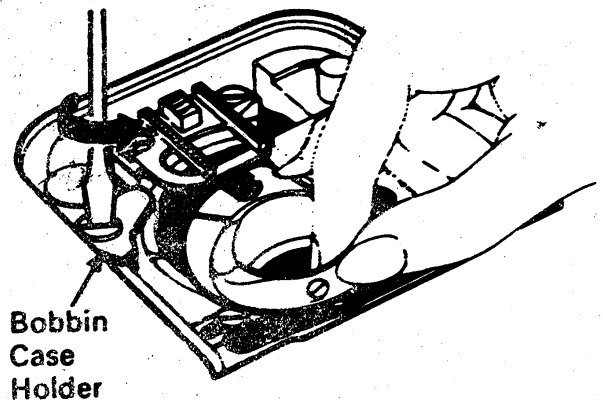
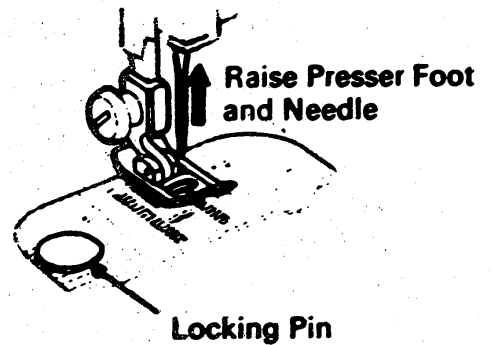

*This machine is designed to use a 15 watt maximum light bulb.*

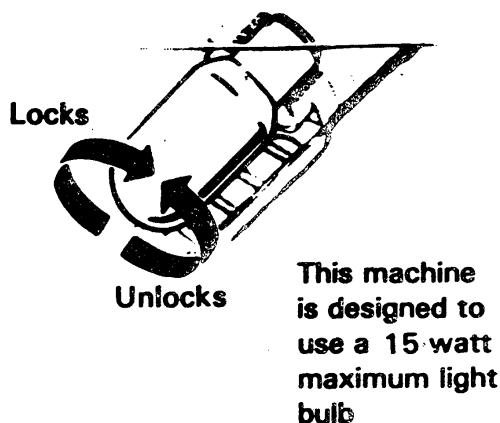

### CHANGING THE LIGHT BULB

Disconnect power-line plug from electrical supply.

#### Removing the Bulb

With thumb and forefinger lower the light bracket. Do not attempt to unscrew bulb. Press it up into socket and at same time turn bulb over in direction shown to unlock bulb pin.

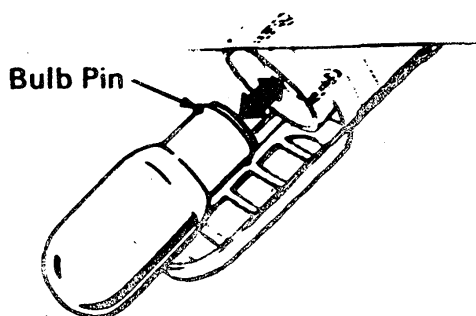

#### Replacing the Bulb

Press new bulb into socket with bulb pin entering slot of socket, and turn it over in direction shown to lock bulb in position. Release bracket, and entire assembly will snap back into recess.

### Changing the Light Bulb

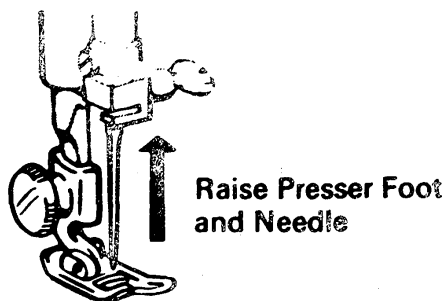

### REPLACING THE SLIDE PLATE

You will not have any occasion to remove the slide plate. However, if it should accidentally become disengaged from the machine, it is easily replaced.

- Raise presser foot and needle.
- Place slide plate in slideway with the front edge close to, but not covering, the retaining spring (as shown in illustration).
- With a screwdriver, lift each end of the spring into each of the side grooves on the underside of the slide plate.
- Draw the plate gently toward you and fully engage the spring.
- Close slide plate.

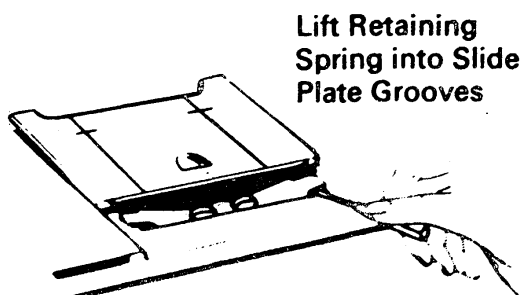

### Replacing the Slide Plate

# *performance checklist*

Should sewing difficulty be encountered, review the sections of this instruction book that explain the sewing operation you are performing. If the problem still exists, the following hints will help you correct it.

## **If the machine does not sew; make sure . . .**

- Machine is connected to electrical supply.
- Power and light switch is on.
- Hand wheel disc is in sewing position. (See page 12.)

## **If needle bar moves but stitch is not formed, make sure . . .**

- Needle is straight and sharp.
- Needle size is correct for the thread you are using. (See page 10.)
- Machine is correctly threaded.
- Bobbin contains thread.
- Bobbin and bobbin case are correctly inserted in machine.
- Bobbin case area is free of lint and loose thread ends.

## **If fabric does not move, make sure . . .**

- Presser foot is down and that pressure dial is adjusted for the weight and texture of your fabric.
- Stitch length selector is correctly set.
- Feed-cover plate has been removed from the general purpose needle plate.
- All lint is removed from around the feed.

## **To avoid breaking of needles, make sure . . .**

- Needle is not bent and that it is correct for machine, and proper size for the thread you are using.
- Needle is fully inserted in needle clamp.
- Twin needle does not strike needle plate when doing twin-needle stitching. (See page 25.)
- Presser-foot shank is securely fastened to presser bar.
- Needle plate is correctly seated and slide plate is fully closed.
- Fabric being guided or supported behind the needle is not being pulled too hard or too fast.

## PERFORMANCE CHECKLIST (Continued)

### **If stitching is irregular, or needle thread breaks, make sure . . .**

- Machine is correctly threaded.
- Thread is even and free from knots.
- Needle is straight and sharp, and correct size for thread.
- Needle-thread tension is not too tight.
- Bobbin case is correctly threaded and properly inserted.
- Threads are correctly placed under presser foot when you start to sew.
- Bobbin case area is free of lint and loose thread ends.
- Bobbin or bobbin case is not damaged.

### **Also remember to . . .**

- Turn hand wheel toward you to position needle and take-up lever.
- Raise needle above fabric before making adjustments to stitch width and needle position.
- Start and finish sewing with take-up lever in its highest position.
- Adjust stitch length, pressure, and thread tension to suit your fabric.
- Test stitch on a fabric sample before starting a sewing job.
- Lower presser foot before setting pressure dial.
- Tighten hand wheel knob and disengage bobbin winder after winding a bobbin.
- Remove feed-cover needle plate after button sewing and after darning with an embroidery hoop.
- Clean your machine periodically.

## **CAUTION**

**Do not attempt to adjust the motor drive belt.  
Refer to your nearest Service Centre  
should any adjustment be required.**

The machine is intended for household use.

Voltage rating ..... 120 Volts

Rated frequency ..... 60 Hz (Hertz, cycle per second)

Light bulb power (1 amp) ..... max 12 Watts

Appliances class II — machine does not require earthing

## **CAUTION**

Read all instructions before using the sewing machine.

## **DANGER**

An appliance should never be left unattended when plugged in. Always unplug this appliance from the electric outlet immediately after using and before cleaning.

## **WARNINGS**

1. Never operate the appliance with the air openings blocked. Keep the air openings free of lint, hair, loose clothes and the like.
2. Keep fingers away from all moving parts. Special care is required around the sewing machine needle.
3. Do not use bent needles.
4. Always use the proper needle plate. The wrong plate can cause the needle to break.
5. Do not pull or push fabric while stitching. It may deflect the needle causing it to break.
6. Switch the sewing machine off „0” when making any adjustments in the needle area, such as threading needle, changing needle, threading bobbin, or changing presser foot, and the like.
7. Always unplug sewing machine from the electrical outlet when removing covers, lubricating, or when making any other user servicing adjustments mentioned the instruction manual.
8. Operate sewing machine only when mounted in sewing machine table, case, and the like.
9. Always unplug before relamping. Replace bulb with same type rated max 15 Watts.
10. Sewing machine has a **DOUBLE ELECTRICAL INSULATION**. Replacement parts for a double insulated product must be identical to those parts in the product.



# NEW SEWING MACHINE WARRANTIES MECHANICAL MODELS

(applies to machines other than the Touch-Tronic\* and Creative Touch\* Fashion Machine Models)

## LIMITED 10 YEAR WARRANTY SEWING MACHINE HEAD

If any manufacturing defect appears in the sewing machine head or any of its parts other than those listed below within 10 years of purchase, we will repair it free of charge.

---

## LIMITED 2 YEAR WARRANTY MOTORS, LIGHT ASSEMBLY, WIRING, SWITCHES AND SPEED CONTROLS

If any manufacturing defect appears in these parts within 2 years of purchase, we will repair it free of charge.

---

## LIMITED 90 DAY WARRANTY ADJUSTMENTS, BELTS, RINGS, BULBS and ATTACHMENTS

Within 90 days of purchase we will provide, free of charge, required adjustments. During the same period we will also replace, free of charge, defective belts, bobbin winder rubber rings, light bulbs, or attachments, if any.

---

## GENERAL

THESE WARRANTIES MAY ONLY BE USED BY THE ORIGINAL CONSUMER OWNER OF THE SEWING MACHINE; THEY ARE NOT TRANSFERABLE TO ANY SUBSEQUENT OWNERS. SERVICE UNDER THESE WARRANTIES MAY ONLY BE OBTAINED WITHIN THE 48 CONTIGUOUS STATES, ALASKA AND HAWAII.

Service under the above warranties may be obtained by returning the sewing machine with this warranty document and proof of purchase to your place of purchase or authorized service center as listed on the back of this sheet. Please consult your phone book for the location nearest you. If you have any questions regarding these warranties, you may write to:

SINGER SEWING COMPANY  
200 METROPLEX DRIVE  
EDISON, NJ 08817

This sewing machine is warranted only in normal household (non-commercial) use. These warranties do not cover failures caused by abuse, lack of maintenance in accordance with SINGER care and cleaning instructions, misuse, or events beyond our control. These warranties give you specific legal rights, and you may also have other rights which vary from state to state.

ANY IMPLIED WARRANTY, INCLUDING WITHOUT LIMITATION THE WARRANTIES OF MERCHANTABILITY OR FITNESS FOR A PARTICULAR PURPOSE. APPLICABLE TO THIS SEWING MACHINE IS LIMITED IN DURATION TO THE DURATION OF THIS WRITTEN WARRANTY. SINGER SHALL NOT BE LIABLE FOR CONSEQUENTIAL ECONOMIC DAMAGES RESULTING FROM BREACH OF THIS WARRANTY OR ANY IMPLIED WARRANTY. Some states do not allow limitations on how long an implied warranty will last or the exclusion or limitation of incidental or consequential damages, so the above limitations or exclusions may not apply to you.

The Singer Company does not authorize any person to create for it any obligation or liability in connection with the above machines and parts beyond those set forth herein.

THE SINGER COMPANY DISCLAIMS LIABILITY UNDER THIS WARRANTY FOR ANY DAMAGE OR DEFECT RESULTING FROM THE USE OF OTHER THAN SINGER PARTS AND APPROVED SERVICE IN THE REPAIR OF YOUR MACHINE.

To keep your machine operating properly, we recommend that you take instructions on use provided for new machine owners, follow the operating instructions and periodically have your machine serviced and tuned by a sewing machine specialist knowledgeable about Singer\* Sewing Machines.

\*A Trademark of THE SINGER COMPANY



# National Product Service Centers, Inc.

Mailing Address: P.O. Box 110, Englishtown, N.J. 07726  
Street Address: 200 Craig Road, Freehold, N. J. 07728

Tel: 201-409-6007  
Fax: 201-409-6954

## ARIZONA

2340 West Grand Avenue  
Phoenix, AZ 85009  
(602) 252-1340

## CALIFORNIA

14399 Paramount Blvd.  
Paramount, CA 90723  
(213) 531-6352

4737 Auburn Blvd.  
Sacramento, CA 95841  
(916) 334-0322

740 El Camino Real  
San Carlos, CA 94070  
(415) 592-8065

4354 Twain Avenue  
San Diego, CA 92120  
(619) 280-9387

## COLORADO

7865 W. 16th. Avenue  
Lakewood, CO 80215  
(303) 232-0283

## FLORIDA

3454 Beach Blvd.  
Jacksonville, FL 32207  
(904) 396-1578

7875 Gateway Mall  
St. Pettersburg, FL 33702  
(813) 577-6263

## GEORGIA

3501 Memorial Drive  
Decatur, GA 30032  
(404) 289-3510

## ILLINOIS

2316 East Rand Road  
Arlington Heights, IL 60004  
(708) 253-3325

## INDIANA

Devington Plaza  
6000 East 46th  
Indianapolis, IN 46226  
(317) 546-3400

## IOWA

419 Brady Street  
Davenport, IA 52801  
(319) 322-8092

## MARYLAND

8560 Laureldale Drive  
Laurel, MD 20724  
(301) 792-4530

## MICHIGAN

785 East Big Beaver  
Troy, MI 48084  
(313) 528-1670

## MINNESOTA

1031 E. Moore Lake Dr. N.E.  
Fridley, MN 55432  
(612) 571-7113

## MISSOURI

Ashari Plaza  
7177 N. Lindbergh Blvd.  
Hazelwood, MO 63042  
(314) 895-1119

5158 Ararat Dr.  
Kansas City, MO 64129  
(816) 861-6161

## NEW JERSEY

1029 Chestnut St.  
Roselle, NJ 07203  
(201) 272-8555

## NEW YORK

1216 Burnet Ave.  
Syracuse, NY 13203-3212  
(315) 474-0202

## OHIO

Silverton Center  
6928 Montgomery Rd.  
Silverton, OH 45236  
(513) 793-7977

1929 E. Aurora Rd.  
Twinsburg, OH 44087-1920  
(216) 425-2240

## OKLAHOMA

9449 E. 31st. St.  
Tulsa, OK 74145  
(918) 622-9277

## OREGON

2613 S.E. 122nd. Avenue  
Portland, OR 97236  
(503) 760-4780

## PENNSYLVANIA

329 Basin St.  
Bristol, PA 19007  
(215) 788-9200

2063-A Route 286  
Pittsburg, PA 15239  
(412) 733-1114

## RHODE ISLAND

38 East Ave.  
Pawtucket, RI 02860  
(401) 724-5347

## SOUTH CAROLINA

505 W. Palmetto St.  
Florence, SC 29501  
(803) 662-0901

## TENNESSEE

3664 Cherry Road  
Memphis, TN 38118  
(901) 365-6614

## TEXAS

Royal Hines Bus. Park  
11171 Harry Hines Blvd.  
Suite 116  
Dallas, TX 75229  
(214) 241-4222

6003-B Bellaire Blvd.  
Houston, TX 77081  
(713) 664-1478

## UTAH

55 East Center St.  
Midvale, Utah 84047  
(801) 566-2031

## VIRGINIA

1529 Azalea Garden Rd.  
Norfolk, VA 23502  
(804) 855-3946

## WASHINGTON

1519 130th Ave. N.E.  
Bellevue, WA 98005  
(206) 462-1274

E. 1503 Francis  
Spokane, WA 99207  
(509) 483-9435

## WEST VIRGINIA

5006 MacCorkle Ave. S.E.  
Charleston, WV 25304  
(304) 925-8288

## WISCONSIN

8203 W. Silver Springs Dr.  
Milwaukee, WI 53218  
(414) 438-1889

## TONY NASRALLA

(213) 630-1358  
Fax: (213) 630-1304  
Paramount, CA 90723

## GLENN DOLAN

(313) 528-1670  
Fax  
Troy, MI 48084

# SINGER

Nationwide Network of Product Service Centers



## Free Manuals Download Website

<http://myh66.com>

<http://usermanuals.us>

<http://www.somanuals.com>

<http://www.4manuals.cc>

<http://www.manual-lib.com>

<http://www.404manual.com>

<http://www.luxmanual.com>

<http://aubethermostatmanual.com>

Golf course search by state

<http://golfingnear.com>

Email search by domain

<http://emailbydomain.com>

Auto manuals search

<http://auto.somanuals.com>

TV manuals search

<http://tv.somanuals.com>