

MODEL R-140D (B)/(W)/(K)/(G)

OPERATION MANUAL and COOKING GUIDE

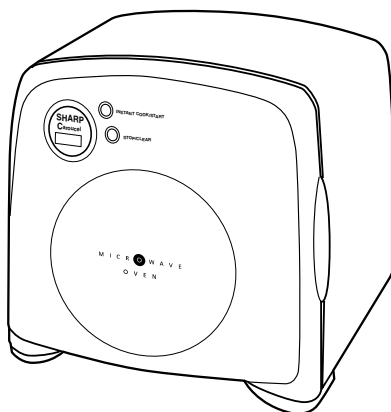

Thank you for buying a Sharp Microwave Oven. Please keep this operation manual handy, as it describes all the features of your oven and will enable you to cook many varieties of foods.

The manual is divided into two sections:

1. OPERATION

This section describes your oven and teaches you how to use all the features.

2. COOKING GUIDES

This section is at the back of the manual, it contains the more commonly used information such as how to prepare food, which cooking utensil to use, standing time.

It also contains recipes for automatic cooking and manual cooking.

Please take some time to read your operation manual carefully, paying particular attention to the warnings and special notes, the automatic cooking menus programmed into your new oven have been carefully developed to give optimum results when the step by step instructions are followed.

When selecting another home appliance, please again consider our full range of Sharp products.

CONTENTS Pages

Warranty	1
Warning	2
Special Notes	3
Installation Instructions	4
Oven Diagram	4
Operation of Touch Control Panel	5
Control Panel Display	5
Touch Control Panel Layout	5
Before Operating	6
Getting Started	6
Clock Setting	6
Stop/Clear	6
To Cancel a Programme	6
Manual Operations	7
Microwave Time Cooking	7
Instant Cook	7
Increasing Time	8
Automatic Operations	9
Notes for Automatic Operations	9
Dinner Plate	9
Auto Cook	10
Defrost	11
Other Convenient Features	12
Timer	12
Child Lock	12
Alarm	12
Care and Cleaning	13
Service Call Check	13
Specifications	13
Cooking Guides	① ~ ⑧

SHARP

WARRANTY

Consumer Electronic Products

Congratulations on Your Purchase!

This Sharp product is warranted against faults in materials and manufacture for a period of twelve (12)* months from the date of original purchase.

If service is required during the warranty period, please contact your nearest Sharp Approved Service Centre. These repairs would be carried out at no charge to the owner, subject to the conditions specified herein.

The owner is responsible for any transportation and insurance costs if the product has to be returned for repair.

This warranty does not extend to accessories or defects or injuries caused by or resulting from causes not attributable to faulty parts or the manufacture of the product, including but not limited to, defect or injury caused by or resulting from misuse, abuse, neglect, accidental damage, improper voltage, liquid spillage, vermin infestation, software, or any alterations made to the product which are not authorised by Sharp.

Please retain your sales documentation, as this should be produced to validate a warranty claim.

This warranty is in addition to and in no way limits, varies or excludes any express and implied rights and remedies under any relevant legislation in the country of sale.

IMPORTANT

DO NOT RETURN THIS PAGE TO SHARP

For your reference, please enter the particulars of your purchase below and retain, with your purchase documentation.

Model No. _____
Serial No. _____
Date of Purchase _____
Retailer _____

FOR LOCATION ENQUIRIES WITHIN

AUSTRALIA

REGARDING YOUR
LOCAL

SHARP APPROVED SERVICE CENTRE

CALL THE

SHARP SERVICE REFERRAL CENTRE

TOLL FREE 1 300 135 022

DURING NORMAL BUSINESS HOURS

(Eastern Standard Time)

or contact our web site

www.sharp.net.au

FOR PRODUCTS PURCHASED IN

NEW ZEALAND

CONTACT YOUR SELLING DEALER/RETAILER
OR CALL

SHARP CUSTOMER SERVICES

TELEPHONE: 09 - 634 2059

FACSIMILE: 09 - 636 0959

SHARP CORPORATION OF NEW ZEALAND LIMITED
Cnr. Mahunga Drive & Hastie Ave
Mangere AUCKLAND

SHARP CORPORATION OF AUSTRALIA PTY. LIMITED
ABN 40 003 039 405
1 Huntingwood Drive Blacktown NSW 2148

IMPORTANT NOTICE: This warranty applies only to products sold in Australia & New Zealand.

WARNING

Read all instructions before using the appliance.

To reduce the risk of fire in the oven cavity:

- a. Do not overcook food.
- b. Remove wire twist-ties from paper or plastic bags before placing bag in the oven.
- c. Do not heat oil or fat for deep frying. The temperature of the oil cannot be controlled.
- d. Look at the oven from time to time when food is heated in disposable containers made of plastic, paper or other combustible materials for signs of smoke or burning.
- e. If materials inside the oven should ignite, or smoke is observed, keep oven door closed, turn oven off, and disconnect the power cord, or shut off power at the fuse or circuit breaker panel.

To reduce the risk of explosion and sudden boiling:

- a. Do not place sealed containers in the oven. Babies bottles fitted with a screw cap or teat are considered to be sealed containers.
- b. When boiling liquids in the oven, use a wide-mouthed container and stand about 20 seconds at the end of cooking to avoid delayed eruptive boiling of liquids.

This oven is for home food preparation only and should only be used for heating, cooking and defrosting food and beverage.

It is not suitable for commercial, laboratory use, or heating therapeutic devices eg. Wheat bags.

Never operate the oven whilst any object is caught or jammed between the door and the oven.

Do not try to adjust or repair the oven yourself because of hazard. The oven must be adjusted or repaired by a qualified service technician trained by SHARP.

Do not operate the oven if it is not working correctly or damaged until it has been repaired by a qualified service technician trained by SHARP. It is particularly important that the oven door closes properly and that there is no damage to:

(1) Door (warped), (2) Hinges and Latches (broken or loosened), (3) Door Seals, Sealing Surfaces and oven cavity (buckled or deformed), (4) Burn marks on the door seal faces.

Do not bump, or catch utensils, loose clothes and your accessories on the door safety latches when removing food from the oven.

Never poke an object, particularly a metal object, through a grille or between the door and the oven while the oven operating.

Never tamper with or deactivate the door safety latches.

Always use oven gloves to prevent burns when handling utensils that are in contact with hot food. Enough heat from the food can transfer through utensils to cause skin burns.

Should the power supply cord become damaged, it must be replaced with a special cord supplied by a SERVICE CENTRE APPROVED BY SHARP. And it must be replaced by a qualified service technician trained by SHARP.

If the oven lamp fails please consult your dealer or a qualified service technician trained by SHARP.

Avoid steam burns by directing steam away from the face and hands.

Slowly lift the furthest edge of a dish's cover and microwave plastic wrap and carefully open popcorn and oven cooking bags away from the face.

Make sure that the power supply cord is undamaged, and that it does not run under the oven or over any hot surfaces or sharp edges.

To prevent the turntable from breaking:

- a. Before cleaning the turntable with water, leave the turntable to cool.
- b. Do not place anything hot on a cold turntable.
- c. Do not place anything cold on a hot turntable.

Do not place anything on the outer cabinet.

This appliance must be earthed.

Do not store food or any other items inside the oven.

Make sure the utensil does not touch the interior walls during cooking.

Only allow children to use the oven without supervision when adequate instructions have been given so that the child is able to use the oven in a safe way and understands the hazards of improper use.

This appliance is not intended for use by young children or infirm persons without supervision.

Young children should be supervised to ensure that they do not play with the appliance.

SPECIAL NOTES

	DO	DON'T
Eggs, fruits, vegetables, nuts, seeds, sausages and oysters	<ul style="list-style-type: none"> * Puncture egg yolks and whites and oysters before cooking to prevent "explosion". * Pierce skins of potatoes, apples, squash, hot dogs, sausages and oysters so that steam escapes. 	<ul style="list-style-type: none"> * Cook eggs in shells. This prevents "explosion", which may damage the oven or injure yourself. * Reheat whole eggs. * Overcook oysters. * Dry nuts or seeds in shells.
Popcorn	<ul style="list-style-type: none"> * Use specially bagged popcorn for the microwave oven. * Listen while popping corn for the popping to slow to 1-2 seconds. 	<ul style="list-style-type: none"> * Pop popcorn in regular brown bags or glass bowls. * Exceed maximum time on popcorn package.
Baby food	<ul style="list-style-type: none"> * Transfer baby food to small dish and heat carefully, stirring often. Check for suitable temperature to prevent burns. * Remove the screw cap and teat before warming baby bottles. After warming shake thoroughly. Check for suitable temperature. 	<ul style="list-style-type: none"> * Heat disposable bottles. * Overheat baby bottles. Only heat until warm. * Heat bottles with nipples on. * Heat baby food in original jars.
General	<ul style="list-style-type: none"> * Food with filling should be cut after heating, to release steam and avoid burns. * Stir liquids briskly before and after cooking for even heating. * Use a deep bowl when cooking liquids or cereals to prevent boiling over. * For boiling or cooking liquids see WARNING on page 2. 	<ul style="list-style-type: none"> * Heat or cook in closed glass jars or air tight containers. * Deep fat fry. * Heat or dry wood, herbs, wet papers, clothes or flowers. * Operate the oven without a load (i.e. an absorbing material such as food or water) in the oven cavity.
Canned foods	<ul style="list-style-type: none"> * Remove food from can. 	<ul style="list-style-type: none"> * Heat or cook food while in cans.
Sausage rolls, Pies, Christmas pudding	<ul style="list-style-type: none"> * These foods have high sugar and/or fat contents. * Cook for the recommended time. 	<ul style="list-style-type: none"> * Overcook as they may catch fire.
Meats	<ul style="list-style-type: none"> * Use a microwave proof roasting rack to collect drained juices. 	<ul style="list-style-type: none"> * Place meat directly on the turntable for cooking.
Utensils	<ul style="list-style-type: none"> * Check the utensils are suitable for MICROWAVE cooking before you use them. 	<ul style="list-style-type: none"> * Use metal utensils for MICROWAVE cooking. Metal reflects microwave energy and may cause an electrical discharge known as arcing.
Aluminium foil	<ul style="list-style-type: none"> * Use to shield food to prevent over cooking. * Watch for sparking. Reduce foil or keep clear of cavity walls. 	<ul style="list-style-type: none"> * Use too much. * Shield food close to cavity walls. Sparking can damage the cavity.
Browning dish	<ul style="list-style-type: none"> * Place a suitable insulator such as microwave and heat proof dinner plate between the turntable and the browning dish. 	<ul style="list-style-type: none"> * Exceed the preheating time recommended by the manufacturer. Excessive preheating can cause the glass turntable to shatter and/or damage internal parts of the oven.

INSTALLATION INSTRUCTIONS

1. Remove all packing materials from the oven cavity, (do not remove the waveguide cover, item 8 below), and the feature sticker from the outside of the door, if there is one. Check the unit for any damage, such as a misaligned door, damaged door seals around the door or dents inside the oven cavity or on the door. If there is any damage, please do not operate the oven until it has been checked by a SERVICE CENTRE APPROVED BY SHARP and repaired, if necessary.
2. Accessories provided
 - 1) Turntable tray
 - 2) Roller stay
 - 3) Operation manual and cooking guide
3. Locate the roller stay in the centre of the oven, then fit the turntable on the roller stay. Make sure the turntable is centrally located and locked together. Refer to OVEN DIAGRAM below. Never operate the oven without the roller stay and turntable.
4. The oven should not be installed in an area where heat and steam are generated, for example, next to a conventional oven unit. The oven should be installed so as not to block ventilation openings. Allow at least 10cm on the top, 5cm on the both sides and at the rear of the oven for free air space. This oven is not designed to be built-in to a wall or cabinet.
5. Neither the manufacturer nor the distributors can accept any liability for damage to the machine or personal injury for failure to observe the correct electrical connecting procedure. The A.C. voltage must be single phase • 230-240V, 50Hz.
6. Operate the oven from a general purpose domestic outlet. If a generator is used, do not operate the oven with NON-SINUSOIDAL outputs.

OVEN DIAGRAM

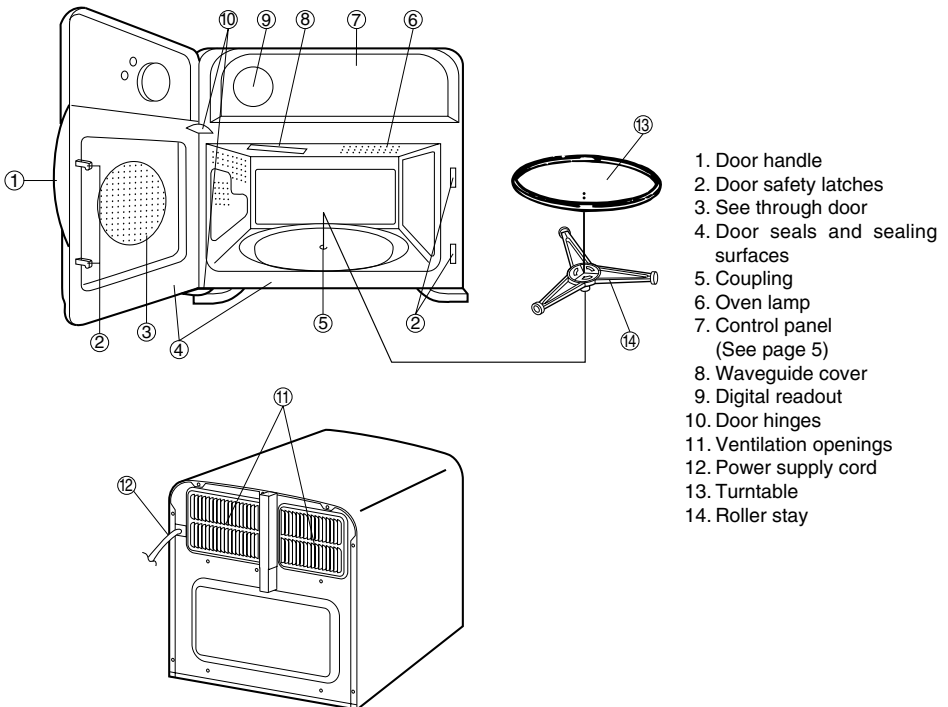

OPERATION OF TOUCH CONTROL PANEL

The operation of the oven is controlled by pressing the appropriate pads arranged on the surface of the control panel.

An entry signal tone should be heard each time you press the control panel to make a correct entry.

In addition the oven will beep for approximately 2 seconds at the end of the cooking cycle, or 4 times when a cooking procedure is required.

Control Panel Display



Touch Control Panel Layout

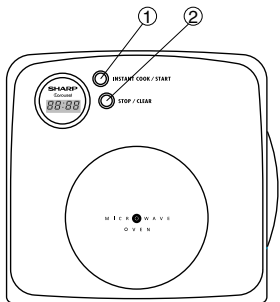

DOOR CLOSED

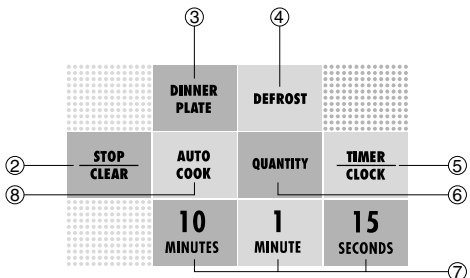



- ① **INSTANT COOK/START PAD**
Press once to cook for 1 minute at 100% or increase by 1 minute multiples each time this pad is pressed during cooking. Press to start oven after setting programmes.
- ② **STOP/CLEAR PAD**
Press to clear during programming. Press once to stop operation of oven during cooking; press twice to cancel cooking programme.
- ③ **DINNER PLATE PAD**
Press to cook one dinner plate.
- ④ **DEFROST PAD**
Press to defrost meat and fish fillets by entering the defrosting time.
- ⑤ **TIMER/CLOCK PAD**
Press to set clock, timer or child lock.
- ⑥ **QUANTITY PAD**
Press to enter the quantity for AUTO COOK menus.
- ⑦ **TIME PADS**
Press to enter cooking/defrosting time or clock time.
- ⑧ **AUTO COOK PAD**
Press to select the Auto cook menu.

NOTE: Open the door to programme the oven.

The **STOP/CLEAR** and the **INSTANT COOK/START** pads can be used even if the door is closed.





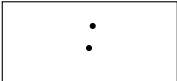





BEFORE OPERATING

Getting Started

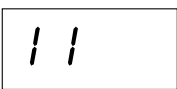
Step	Procedure	Pad Order	Display
1	Ensure the oven door is closed. Plug the oven into a power point and switch on the power.		 Flashing eights
2	Press the STOP/CLEAR pad so that the oven beeps.		 Only the dots will remain.

Clock Setting

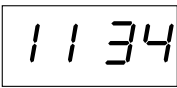
* To enter the present time of day 11:34 (AM or PM).

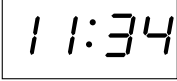
Step	Procedure	Pad Order	Display
1	Open the door and press the TIMER/CLOCK pad.		
2	Enter the correct time of day (hours) by pressing the TIME pads.	 x 1  x 1	
3	Press the TIMER/ CLOCK pad again		
4	Enter the correct time of day (minutes) by pressing the TIME pads.	 x 3  x 4	
5	Press the TIMER/ CLOCK pad again.		

This is a 12 hour clock.

Stop/Clear

Press the STOP/CLEAR pad once to:

1. Stop the oven temporarily during cooking.
2. Clear if you make a mistake during programming.

To Cancel a Programme During Cooking



Press the STOP/CLEAR pad twice.

MANUAL OPERATIONS

Microwave Time Cooking

You can programme up to 99 minutes, 45 seconds. The oven has only 100% (HIGH) power level, for manual cooking.

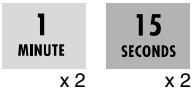
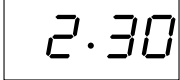
* Suppose you want to time cook for 2 minutes 30 seconds.

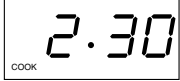
Step	Procedure	Pad Order	Display
1	Open the door and enter desired cooking time.		
2	Close the door and press the INSTANT COOK/START pad.		 The timer begins to count down.

If the door is opened during cooking process, the cooking time in the readout automatically stops. The cooking time starts to count down again when the door is closed and the INSTANT COOK/START pad is pressed.

Instant Cook™

For your convenience Sharp's Instant Cook allows you to easily cook for one minute on 100% power.

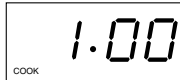



Step	Procedure	Pad Order	Display
1	Press the INSTANT COOK/START pad. Within 3 minutes of closing the door.		 The timer begins to count down.

Press the INSTANT COOK/START pad until desired time is displayed.
Each time the pad is pressed, the cook time is increased by 1 minute.

Increasing Time During a Cooking Programme

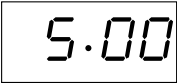
Microwave time can be added during a cooking programme using the INSTANT COOK/START pad.

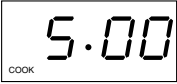
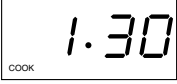
* Suppose you want to increase the cooking time by 2 minutes during 5 minutes cooking.
(at the moment the remaining cooking time is 1 min. 30 sec.)

Step	Procedure	Pad Order	Display
1	Open the door and enter desired cooking time.		
2	Close the door and press the INSTANT COOK/START pad.	 INSTANT COOK / START	 The timer starts to count down. 
3	Press the INSTANT COOK/START pad twice to increase the cooking time by two minutes.	 INSTANT COOK / START x 2	

AUTOMATIC OPERATIONS

Notes for Automatic Operations

1. When using the automatic features, carefully follow the details provided in each MENU GUIDE to achieve the best result.

If the details are not followed carefully, the food may be overcooked or undercooked.

2. Food weighing more or less than the quantity or weight listed in each MENU GUIDE, cook manually.



3. The final cooking result will vary according to the food condition (e.g. initial temperature, shape, quality).
Check the food after cooking and if necessary continue cooking manually.

Dinner Plate

The Dinner Plate allows you to cook or reheat several popular foods.

Follow the details provided in DINNER PLATE MENU GUIDE on page ④ in the cooking guides.

* Suppose you want to cook 1 Dinner Plate.

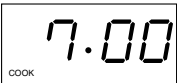
Step	Procedure	Pad Order	Display
1	Open the door and press the DINNER PLATE pad.		
2	Close the door and press the INSTANT COOK/START pad.	 INSTANT COOK / START	 The cooking time will begin counting down. When it reaches zero, the oven will "beep".







Auto Cook

**AUTO
COOK**

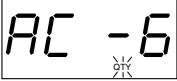
1. Beverage
2. Reheat Pie
3. Reheat Pizza
4. Fresh Vegetables
5. Frozen Vegetables
6. Jacket Potato

AUTO COOK will automatically compute the microwave power and cooking time. Follow the details provided in AUTO COOK MENU GUIDE on page ④ in the cooking guides.

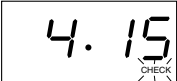
* Suppose you want to cook 3 Jacket Potatoes.

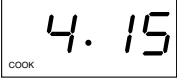
Step	Procedure	Pad Order	Display
1	Open the door and press the ATUO COOK pad until the desired menu number is displayed (for Jacket Potato press 6 times).	 x 6	 QTY will flash on and off.
2	Press the QUANTITY pad to enter quantity (for 3 potatoes press 3 times).	 x 3	
3	Close the door and press the INSTANT COOK/START pad.	 INSTANT COOK / START	 The cooking time will begin counting down. The oven will "beep" 4 times and stop. COOK indicator will go off and CHECK will flash on and off.
4	Open the door. Turn over potatoes. Close the door.		 CHECK will be flashing.
5	Press the INSTANT COOK/START pad.	 INSTANT COOK / START	 The cooking time will begin counting down. When it reaches zero, the oven will "beep".







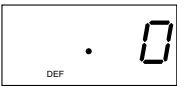

Defrost

DEFROST

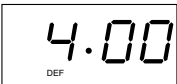
DEFROST will automatically compute the microwave power by entering appropriate defrosting time.

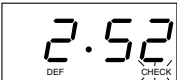
Follow the details provided in DEFROST MENU GUIDE on page 5 in the cooking guides.

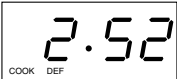
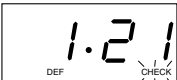
* Suppose you want to defrost 0.5 kg of Chicken Fillets for 4 minutes.

Step	Procedure	Pad Order	Display
1	Open the door and press the DEFROST pad.		
2	Press the TIME pads to enter the defrosting time.		
3	Close the door and press the INSTANT COOK/START pad.		 The defrosting time will begin counting down. The oven will "beep" 4 times and stop. COOK indicator will go off and CHECK will flash on and off.
4	Open the door. Turn meat over and separate into pieces. Close the door.		 CHECK will be flashing.
5	Press the INSTANT COOK/START pad.		 The defrosting time will begin counting down. The oven will "beep" 4 times and stop. COOK indicator will go off and CHECK will flash on and off.
6	Open the door. Turn meat over and separate into pieces. Close the door.		 CHECK will be flashing.
7	Press the INSTANT COOK/START pad.		 The defrosting time will begin counting down. When it reaches zero, the oven will "beep".

NOTE: If the defrosting time that you have entered is short, "CHECK" may not flash, or may flash once only during the defrosting process.



OTHER CONVENIENT FEATURES

Timer

Use this feature as a general purpose timer. Example include:
 timing boiled eggs cooked on the stove top.
 timing the recommended standing time of food.

You can enter any time up to 99 minutes, 45 seconds. If you want to cancel the timer during the count down phase simply press STOP/CLEAR and the display will return to showing time of day.

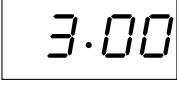
* Suppose you want to set the timer to 3 minutes for boiling an egg on the stove top.

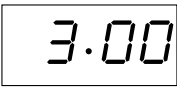
Step	Procedure	Pad Order	Display
1	Open the door and enter desired time.		
Once the egg has come to the boil in the saucepan you can start the timer.			
2	Press the TIMER/CLOCK pad . You can close the door.		 The timer begins to count down. When the timer reaches zero, the oven will "beep".

Child Lock

If the oven is accidentally started with no food/liquid in the cavity, the oven could be damaged.
 To prevent accidents like this, your oven has a "Child Lock" feature that you can set when the oven is not in use.

To set the Child Lock, open the door, press the TIMER/CLOCK pad and 1 MINUTE pad. Then close the door and press the INSTANT COOK/START pad and hold for 3 seconds.  will appear in the display. The Control Panel is now locked, each time a pad is pressed, the display will show "SAFE".

To unlock the control panel, open the door, press the TIMER/CLOCK pad, 1 MINUTE pad and the STOP/CLEAR pad. The time of day is displayed and the oven is ready to use.

Alarm

Your oven has an alarm function. If you leave food in the oven after cooking, the oven will "beep" 3 times and  will flash on and off in the display after 2 minutes.
 If you do not remove the food at that time, the oven will "beep" 3 times after 4 minutes and 6 minutes.

CARE AND CLEANING

CLEAN THE OVEN AT REGULAR INTERVALS

Disconnect the power supply cord before cleaning. And if possible leave the door open to inactivate the oven.

Exterior:

The outside may be cleaned with mild soap warm water, wipe clean with a damp cloth. Avoid the use of harsh abrasive cleaners.

Door:

Wipe the door and window on both sides, the door seals and adjacent parts frequently with a damp cloth to remove any spills or spatters. Do not use abrasive cleaner.

Touch Control Panel:

Care should be taken in cleaning the touch control panel. Wipe the panel with a cloth dampened slightly with water only.

Do not scrub or use any sort of chemical cleaners. Avoid the use of excess water.

Interior walls:

To clean the interior surfaces, wipe with a soft cloth and warm water for hygienic reasons. After use wipe the waveguide cover in the oven with a soft damp cloth to remove any food splashes. Built-up splashes may overheat and begin to smoke or catch fire. Do not remove the waveguide cover. **DO NOT USE A COMMERCIAL OVEN CLEANER, ABRASIVE OR HARSH CLEANERS AND SCOURING PADS ON ANY PART OF YOUR MICROWAVE OVEN. NEVER SPRAY OVEN CLEANERS DIRECTLY ONTO ANY PART OF YOUR OVEN.** Avoid using excess water. After cleaning the oven, ensure any water is removed with a soft cloth.

Turntable/Roller Stay:

Wash with mild soapy water and dry thoroughly.

SERVICE CALL CHECK

Please check the following before calling for service:

1. Does the display light? YES _____ NO _____
2. Place one cup of water (approx. 250 ml) in a glass measure in the oven and close the door securely.
Press the INSTANT COOK/START pad twice.
 - A. Does the oven lamp light? YES _____ NO _____
 - B. Does the cooling fan work? YES _____ NO _____
(Put your hand over the rear ventilation openings.)
 - C. Does the turntable rotate? YES _____ NO _____
(The turntable can rotate clockwise or counterclockwise. This is quite normal.)
 - D. After two minutes, did an audible signal sound and COOK indicator go off? YES _____ NO _____
 - E. Is the water inside the oven hot? YES _____ NO _____

If "NO" is the answer to any of the above questions, please check your wall socket and the fuse in your meter box. If both the wall socket and the fuse are functioning properly, CONTACT YOUR NEAREST SERVICE CENTRE APPROVED BY SHARP.

SPECIFICATIONS

AC Line Voltage	Single phase 230–240V, 50Hz
AC Power Required	970 W
Output Power	600 W* (IEC test procedure)
Microwave Frequency	2450 MHz** (Class B/Group 2)
Outside Dimensions	365mm(W) x 360mm(H) x 357mm(D)
Cavity Dimensions	299mm(W) x 168mm(H) x 302mm(D)
Oven Capacity	15 litre
Cooking Uniformity	Turntable (ø272mm tray) system
Weight	Approx. 12.5 kg

* When tested in accordance with AS/NZS 2895.1.1995

** This is the classification of ISM (Industrial, Scientific and Medical) equipment described in the International Standard CISPR11.

MEMO

SHARP

COOKING GUIDES



CONTENTS COOKING GUIDE







QUICK REFERENCE GUIDE ①	HELPFUL HINTS ②	COOKWARE AND UTENSIL GUIDE ③	DINNER PLATE/ AUTO COOK ④	DEFROST MENU GUIDE ⑤	RECIPES ⑥ – ⑧
-------------------------------	--------------------	------------------------------------	---------------------------------	----------------------------	------------------

SHARP

SHARP CORPORATION OSAKA, JAPAN [Download from WwW.Somanuals.com](http://www.somanuals.com). All Manuals Search And Download.

TINSEA869WRRZ – J13
Printed in Thailand

QUICK REFERENCE GUIDE

FEATURE	QUICK OPERATION GUIDE	
Dinner Plate	To cook 1 Dinner Plate Open the Door → DINNER PLATE → Close the Door →  INSTANT COOK / START	
Auto Cook	To cook 3 Jacket potatoes. Open the Door → AUTO COOK (Menu Number x6) → QUANTITY (Quantity x3) → Close the Door →  INSTANT COOK / START	
Defrost	To defrost 0.5kg of Chicken Fillets for 4 minutes. Open the Door → DEFROST → 1 MINUTE (Defrosting Time x4) → Close the Door →  INSTANT COOK / START	
Instant Cook	Just One Touch  INSTANT COOK / START Within 3 minutes of closing the door.	
Microwave Cooking	To cook for 2 minutes 30 seconds. Open the Door → 1 MINUTE (Cooking Time x2) → 15 SECONDS (Cooking Time x2) → Close the Door →  INSTANT COOK / START	
Timer	To set for 3 minutes. Open the Door → 1 MINUTE (x3) → TIMER CLOCK (You can close the door.)	
Child Lock	To lock. Open the Door → TIMER CLOCK → 1 MINUTE (x1) → Close the Door →  INSTANT COOK / START <small>Press for 3 seconds</small>	To unlock. Open the Door → STOP CLEAR → 1 MINUTE (x1) → STOP CLEAR (You can close the door.)
Clock	To set for 11:45 am Open the Door → TIMER CLOCK → 10 MINUTES (Hour x1) → 1 MINUTE (Minute x1) → TIMER CLOCK → 10 MINUTES (Hour x4) → 1 MINUTE (Minute x5) → TIMER CLOCK (You can close the door.)	

HELPFUL HINTS

1. THE ARRANGEMENT

Arrange foods carefully. Place thickest areas toward outside of dish.



3. COVERING

Cover foods in the microwave if you would normally cover the food in your ordinary oven, or to retain moisture. Cover foods such as Vegetables, Casseroles, or when Reheating.

Use to cover foods:

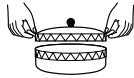

LID



PLASTIC WRAP



PAPER TOWEL

5. SHIELDING

Shield using small pieces of aluminium foil to shield thin areas of meat, fish and poultry or edges of cakes to prevent overcooking.



FISH



CHICKEN

7. STIRRING

Stir foods from the outside to the centre of the dish, once or twice during cooking if possible.

Eg. Casseroles and Sauces.



9. DENSITY

The depth to which microwaves penetrate food varies depending on the food's density. Porous foods like minced beef or mashed potatoes microwave faster than dense ones like steak or whole potatoes.

11. STARTING TEMPERATURE

Frozen or refrigerated foods take longer to heat than food at room temperature. Cooking times in this book are based on normal storage temperatures. Since rooms, refrigerators and freezers differ in temperature, check cooking result at the minimum time.



13. CONDENSATION

Condensation is a normal part of microwave cooking. The humidity and moisture in food will influence the amount of condensation in the oven. Generally, covered foods will not cause as much condensation as uncovered foods. Ensure that the ventilation openings are not blocked.

2. TURNING

Foods such as poultry and joints of meat should be turned over after half the cooking time.

4. PIERCING

Pierce potatoes, eggs, tomatoes or any foods with a skin or membrane to allow steam to escape.



TOMATO



EGG

6. STANDING TIME

Standing time is important. After cooking or defrosting ensure adequate standing time. This allows the food to continue cooking or heating. Refer to cooking guides for each menu or according to manufacturers instructions.

8. SIZE

Small pieces cook faster than large ones. To speed up cooking, cut pieces smaller than 5 cm so microwaves can penetrate to the centre from all sides. For even cooking, make all the pieces the same size.









10. FAT AND BONE

Marbling within meat, or a thin, even layer of fat on a roast, speeds cooking. Large fatty areas or excess drippings in dish attract energy away from meat, and slows cooking. Centre bones do not affect cooking, but bone on the side of meat conducts heat to the areas next to it.

12. QUANTITY

Microwave cooking times are directly related to the amount of food in the oven. Because energy is absorbed by the food itself, one potato or a single piece of chicken cooks rapidly. When the energy is divided among several items, cooking takes more time.

COOKWARE AND UTENSIL GUIDE

Utensil	Use	Advice
GLASSWARE/CERAMIC (HEAT RESISTANT) 	YES	GLASSWARE <ul style="list-style-type: none"> • Ordinary glass is not suitable for cooking but may be used for short periods for heating foods. CERAMIC <ul style="list-style-type: none"> • Most ovenproof china, and ceramics, are suited. • Avoid dishes that are decorated with gold or silver leaf. • Avoid using antique pottery. • If unsure, check with the manufacturer.
METAL COOKWARE 	NO	<ul style="list-style-type: none"> • Metal cookware should be avoided when cooking in the microwave oven. • Microwave energy is reflected by metal.
PLASTIC WRAP/ OVEN BAGS (MICROWAVE SAFE ONLY) 	YES	<ul style="list-style-type: none"> • Plastic wrap can be used to cover food. • Some shrinkage of the wrap may occur, over an extended cooking time. • When removing wrap, lift it in such a way to avoid steam burns. • Do not tie oven bags with metal twist ties, substitute with string. • For cooking food with high fat content, do not bring the wrap in contact with the food as it may melt.
ALUMINIUM FOIL 	FOR SHIELDING	<ul style="list-style-type: none"> • Small amounts may be used to shield certain parts of meat and fish when cooking or defrosting. • Remove food in foil trays, if possible, and place in a microwave safe dish. • If not possible, place the foil tray onto a heat proof plate allowing 2.5 cm room between the walls of the oven.
STRAW AND WOOD 	NO	<ul style="list-style-type: none"> • Excessive over heating of these materials may cause a fire in the microwave oven.
PAPER 	YES	<ul style="list-style-type: none"> • Paper towels and waxed paper are suitable to use to prevent splatters. • These are suitable for use when reheating foods or for short cooking times.
PLASTIC COOKWARE MICROWAVE SAFE 	YES	<ul style="list-style-type: none"> • Ideal for cooking, reheating and defrosting. • Some microwave safe plastic cookware are not suitable for cooking foods with high fat and sugar content.
BROWNING DISH 	YES	<ul style="list-style-type: none"> • Ensure that the preheating time of the dish is not exceeded. • Ensure that a microwave heat proof dinner plate or suitable insulator be placed between the turntable and the browning dish.
THERMOMETERS <ul style="list-style-type: none"> • MICROWAVE SAFE • CONVENTIONAL 	YES NO	





DINNER PLATE/AUTO COOK MENU GUIDE

The final cooking result will vary according to the food condition (e.g. initial temperature, shape, quality). Check the food after cooking and if necessary continue cooking manually.

AUTO COOK NO.	Menu	Quantity (Unit per pressing the QUANTITY pad)	Initial Temperature (approx.)	Procedure	⌚ Standing Time (minutes)									
	DINNER PLATE <table border="1" style="width: 100%; border-collapse: collapse;"> <tr> <td style="width: 33%; text-align: center;">MEAT</td> <td style="width: 33%; text-align: center;">POTATO</td> <td style="width: 33%; text-align: center;">VEGETABLES</td> </tr> <tr> <td style="text-align: center;">175-180g</td> <td style="text-align: center;">125g</td> <td style="text-align: center;">100g</td> </tr> <tr> <td>Beef, Lamb Chicken, T-Bone</td> <td style="text-align: center;">sliced</td> <td>2 varieties eg. sliced Carrot, Zucchini Broccoli</td> </tr> </table>	MEAT	POTATO	VEGETABLES	175-180g	125g	100g	Beef, Lamb Chicken, T-Bone	sliced	2 varieties eg. sliced Carrot, Zucchini Broccoli	1 serve approx. 400 g	+3°C Refrigerated	<ul style="list-style-type: none"> • Cover with plastic wrap. • After cooking, stand covered. 	2
MEAT	POTATO	VEGETABLES												
175-180g	125g	100g												
Beef, Lamb Chicken, T-Bone	sliced	2 varieties eg. sliced Carrot, Zucchini Broccoli												
1	Beverage includes: Tea Coffee Water	1-3 cups (1 cup, 250 ml)	+ 20°C Room temperature	<ul style="list-style-type: none"> • No cover • Place on the outside of turntable. • After reheating, stir. 										
2	Reheat Pie includes: Pies Pasties	1-3 pieces (1 piece, approx. 160-200 g)	+ 3°C Refrigerated	<ul style="list-style-type: none"> • Place on the turntable. • Cover with paper towel. • After cooking, stand. 	1 - 3									
3	Reheat Pizza	1-3 pieces (1 piece, approx. 90 g)	+ 3°C Refrigerated	<ul style="list-style-type: none"> • Place pizza on paper towel on the turntable. 										
4	Fresh Vegetables Carrots } Potato } hard vegetables Beans / Brussels Sprouts } Broccoli / Cauliflower } medium vegetables Zucchini / Spinach / Cabbage } soft vegetables	0.1-0.4 kg (0.1 kg)	+ 3°C Refrigerated	<ul style="list-style-type: none"> • Wash the vegetables. • Arrange the vegetables in a shallow dish in the following way: hard vegetables around the outside, soft vegetables in the centre, medium vegetables in-between. • Cover with glass lid or plastic wrap. • After cooking, stand covered and stir. 	1 - 4									
5	Frozen Vegetables Carrots } Beans / Brussels Sprouts } Broccoli / Cauliflower } hard vegetables Corn } Green Peas } medium vegetables Mixed Vegetables } soft vegetables	0.1-0.4 kg (0.1 kg)	-18°C Frozen	<ul style="list-style-type: none"> • Before cooking, separate vegetables eg. broccoli as much as possible. • Arrange the vegetables in a shallow dish in the following way : hard vegetables around the outside, soft vegetables in the centre, medium vegetables in-between. • Cover with a glass lid or plastic wrap. • After cooking, stand covered and stir. 	1 - 4									
6	Jacket Potato Potato (whole)	1-3 pieces (1 piece, approx. 150 g)	+ 20°C Room temperature	<ul style="list-style-type: none"> • Use washed new potatoes. • Pierce twice with fork on each side. • Place on outside of turntable. • The oven will "beep" and stop, CHECK will flash on and off. Turn over potatoes and press start to continue cooking. • After cooking , stand, covered with aluminium foil. 	3 - 6									

Weight Range : 0.1 - 0.5 kg

DEFROST MENU GUIDE

Menu	Defrosting Time (minutes)	Procedure	⌚ Standing Time (minutes)
Steak Chops 	2 - 6 1/2	<ul style="list-style-type: none"> Shield thin end of chops or steaks with foil. Position the food with thinner parts in the centre in a single layer on the defrost rack. If pieces are stuck together, try to separate as soon as possible. The oven will "beep" and stop, CHECK will flash on and off. Remove defrosted pieces, turn over and shield the warm portions. Press start to continue defrosting. After defrost time, stand covered with aluminium foil. 	1 - 5
Minced Meat / Sausages 	2 - 6 1/2	<ul style="list-style-type: none"> Place frozen minced meat on a defrost rack. Shield the edge with thin foil strips. The oven will "beep" and stop, CHECK will flash on and off. Remove defrosted portions, turn over and shield edges with foil strips. Press start to continue defrosting. After defrost time, stand covered with aluminium foil. 	1 - 5
Fish Fillets 	2 - 6	<ul style="list-style-type: none"> Shield the edge with thin foil strips. Place fish fillets on a defrost rack. The oven will "beep" and stop, CHECK will be flash on and off. Turn over and separate into pieces. Press start to continue defrosting. After defrost time, stand covered with aluminium foil. 	1 - 5
Chicken Fillets 	2 - 4	<ul style="list-style-type: none"> Shield the edge with thin foil strips. Place chicken fillets on a defrost rack. The oven will "beep" and stop, CHECK will be flash on and off. Turn over and separate into pieces. Press start to continue defrosting. After defrost time, stand covered with aluminium foil. 	1 - 5
Chicken Pieces 	3 - 7	<ul style="list-style-type: none"> Shield the exposed bone with foil. Place chicken pieces on a defrost rack. The oven will "beep" and stop, CHECK will flash on and off. Remove defrosted pieces, turn over and shield the warm portions. Press start to continue defrosting. After defrost time, stand covered with aluminium foil. 	1 - 5

NOTE: When freezing minced meat, shape it into flat even sizes.

For fish fillets, chicken fillets, sausages, chicken pieces, steaks and chops, freeze separately in single flat layers and if necessary separate into layers with freezer plastic. This will ensure even defrosting.

It is also a good idea to label the packs with the correct weights.

POTATO BAKE

Serves 2-4

3 large potatoes peeled and sliced

1/4 cup hot water

1 small onion sliced into rings

1/4 cup grated cheese

1/2 cup thickened cream

1. Place sliced potato in a shallow dish and cover with water.
Cook covered for 8 minutes.
2. Drain off water.
3. Arrange sliced potatoes and cover with a layer of onions.
Cover with another potato layer. Pour over cream and sprinkle with cheese.
4. Cook for 15 minutes.
5. Let stand for 2 minutes before serving.

CHINESE BEEF

Serves 4

400g Blade Steak, thinly sliced

1 clove garlic, minced

1 tablespoon sesame oil

1/4 cup beef stock

3 tablespoons oyster sauce

1 onion, chopped

1 carrot, thinly sliced

1/2 red capsicum

100g snow peas

425g can baby corn

1 tablespoon sesame seeds

1. In a 3-litre casserole dish combine beef, garlic and sesame oil.
Cook for 6 minutes, stirring twice during cooking.
2. In a jug combine beef stock, oyster sauce, stir well and pour over beef.
3. Add onion and carrot, and cook for 8 minutes, stirring once during cooking.
4. Add baby corn and capsicum and cook for 5 minutes, stirring once during cooking.
5. Add snow peas and cook for a further 2 minutes.
6. Toast sesame seeds for 2 minutes on high, stirring once during cooking.
7. Sprinkle seeds over Chinese beef and serve hot with rice.

LEMON FISH FILLETS

Serve 1

1 fillet of fish (approximately 200g)

1 tablespoon lemon juice

2 teaspoons butter

2 teaspoons fresh parsley and chives, chopped

1. In a shallow dish arrange fish fillet with thin end tucked under.
2. Pour over lemon juice, sprinkle on herbs and dab with butter.
3. Cook covered for 5 minutes.
4. Stand for 1 minute, before serving with a fresh salad.

QUICK NACHOS

Serves 2

150g Cheese corn chips

250g salsa flavoured dip

420g can red kidney beans, drained

1/2 cup sour cream

1/4 cup grated cheese

2 tablespoons guacamole

1. Place corn chips on the base of a large plate.
2. Combine salsa and kidney beans, and spread over corn chips.
3. Sprinkle with cheese, and cook for 5 minutes or until all cheese has melted.
4. Serve topped with sour cream and guacamole.

MINI SUPREME PIZZA

Serve 1

- 1 mini pizza base or pocket bread
- 1 tablespoon tomato paste
- 1/4 cup ham or cabanossi, chopped
- 1 cup assorted chopped vegetables
e.g. onion, mushroom, capsicum, fresh tomato
- 1/2 cup cheddar or mozzarella cheese, grated

1. Spread base of pizza with tomato paste. Add ham or cabinossi.
2. Top with vegetables, starting with onion and finishing with fresh tomato.
3. Sprinkle with gated cheese.
4. Cook for 3 minutes 30 seconds.
5. Let stand for 1 minutes before slicing.

CHINESE CHICKEN WINGS

Serves 2-3

- 10 chicken wings
- 1/3 cup soy sauce
- 2 tablespoons honey
- 2 tablespoons dry sherry
- 1 clove garlic, crushed
- 2 teaspoons Hoisin Sauce
- 1/2 teaspoon ginger, grated
- 1 teaspoon sesame seeds

1. Mix together soy sauce, honey, dry sherry, garlic, Hoisin sauce and ginger.
2. Pour over chicken wings and let marinate in the fridge for at least an hour, preferably overnight.
3. Arrange chicken wings on a rack with wing tips towards the center, and sprinkle with sesame seeds. Cook for 16 minutes, turning 3 times during cooking.
4. Stand for 2 minutes before serving.

EASY RISOTTO

Serves 2

- 1 onion, diced
- 60g butter
- 3 rashers bacon, diced
- 3 chicken or beef stock cubes
- 2 cups boiling water
- 1 cup long grain rice, washed well
- 1 cup assorted finely chopped vegetables,
e.g. carrots, zucchinis, mushrooms

1. Place onion, butter and bacon in a 3-litre casserole dish. Cook for 5 minutes, stirring once during cooking.
2. Dissolve stock cubes in water, add to onion and bacon. Add all other ingredients. Cover with a lid and cook for 25 minutes. Do not stir during cooking.
3. At the end of this time all the liquid will have been absorbed.
4. Remove lid and leave to stand for 5 minutes. Stir with a fork before serving.

SAVOURY MUSHROOMS

Serves 2

- 6 large mushrooms, or 12 smaller mushrooms
- 3 slices white bread
- 2 rashers bacon, chopped
- 2 shallots, finely chopped
- 1/4 cup tasty cheese, grated
- 1 tablespoon Worcestershire sauce
- 1 tabelspon fresh parsley, chopped

1. Remove stalks from mushrooms.
2. Process bread into breadcrumbs.
3. Cook bacon in a small bowl covered with paper towel for 3 minutes, stirring twice during cooking.
4. Add shallots to bacon and cook for a further minute.
5. Mix breadcrumbs, bacon, shallots, cheese and Worcestershire sauce and parsley until well combined.
6. Spoon mixture into mushrooms. Place mushrooms directly onto the turntable and cook for 5-6 minutes.

FAST CHICKEN PASTA

Serves 4

1 double chicken breast, sliced
1/2 cup chicken stock
150g fresh pasta
6 cups hot tap water
1/2 red capsicum, sliced
1/2 yellow capsicum, sliced
2 sticks celery, chopped
1 tablespoon fresh chives
1 packet picador cheese

1. In a large Pyrex bowl, combine chicken and stock and cover. Cook for 4 minutes, stirring every minute.
2. Drain liquid from chicken and finely dice cooked meat.
3. Cook pasta for 6 minutes.
4. Melt cheese with chicken stock for 2 minutes, stirring once during cooking.
5. Combine all other ingredients and mix well with chicken, pasta and sauce.

SINGAPORE NOODLES

Serves 2-3

1 packet of Vermicelli noodles
1 tablespoon sesame oil
2 tablespoons curry paste
1 onion, chopped
1 teaspoon of both crushed garlic, and crushed ginger
1 tablespoon soy sauce
2 teaspoons Hoisin sauce
1 carrot, finely sliced
1 green shallot, finely sliced
1/2 green capsicum, finely sliced

1. Combine oil, paste, ginger, garlic and onions in a large Pyrex bowl. Cover and cook for 2 minutes.
2. Place noodles in a large bowl of hot water and let stand for 2 minutes. Strain.
3. Add carrot and capsicum to oil mixture and cook for 2 minutes.
4. Add noodles, soy sauce, Hoisin sauce and shallots and cook for a further 5 minutes.
5. Serve immediately, garnished with dried onion flakes.

INSTANT LASAGNE

Serves 4

500g Minced Meat
1 onion, chopped
1 glove garlic, minced
375g bottle Neapolitan sauce
1 tablespoon butter
1 tablespoon fresh parsley, chopped
Salt and Pepper to taste
10 lasagne sheets
1 packet instant cheese sauce
3/4 cup grated tasty cheese

1. Place butter, onion and garlic in a Pyrex bowl. Cook for 2-3 minutes.
2. Stir in meat parsley and salt and pepper. Cook uncovered for 6 minutes, stirring every 2 minutes to separate meat. Drain juice.
3. Stir through jar of Neapolitan sauce.
4. Place lasagne sheets in a large bowl of boiling water and let stand for 2 minutes.
5. Make up instant cheese sauce according to packet instructions.
6. Cover base of 3-litre casserole dish with sheets. Spoon over one-third of meat sauce, followed by one-third of cheese sauce. Repeat this process twice, ending with the cheese sauce.
7. Sprinkle grated cheese over the top and cook for 20 minutes.
8. Allow to stand for 10 minutes before serving.

Free Manuals Download Website

<http://myh66.com>

<http://usermanuals.us>

<http://www.somanuals.com>

<http://www.4manuals.cc>

<http://www.manual-lib.com>

<http://www.404manual.com>

<http://www.luxmanual.com>

<http://aubethermostatmanual.com>

Golf course search by state

<http://golfingnear.com>

Email search by domain

<http://emailbydomain.com>

Auto manuals search

<http://auto.somanuals.com>

TV manuals search

<http://tv.somanuals.com>