

SHARP

MINI COMPONENT SYSTEM

MODEL

CD-DP900E

OPERATION MANUAL

If you require any advice or assistance regarding your Sharp product, please visit our web-site www.sharp.co.uk/support.

Customers without Internet access may telephone 08705 274277 during office hours (or (01) 676 0648 if telephoning from Ireland).

COMPACT
disc
DIGITAL AUDIO

Thank you for purchasing this SHARP product.
To obtain the best performance from this product, please read this manual carefully. It will guide you in operating your SHARP product.

CD-DP900E Mini Component System consisting of CD-DP900E (main unit), CP-DP900H (front speakers), GBOXS0091AWM1 (centre speaker) and GBOXS0092AWM1 (surround speakers).

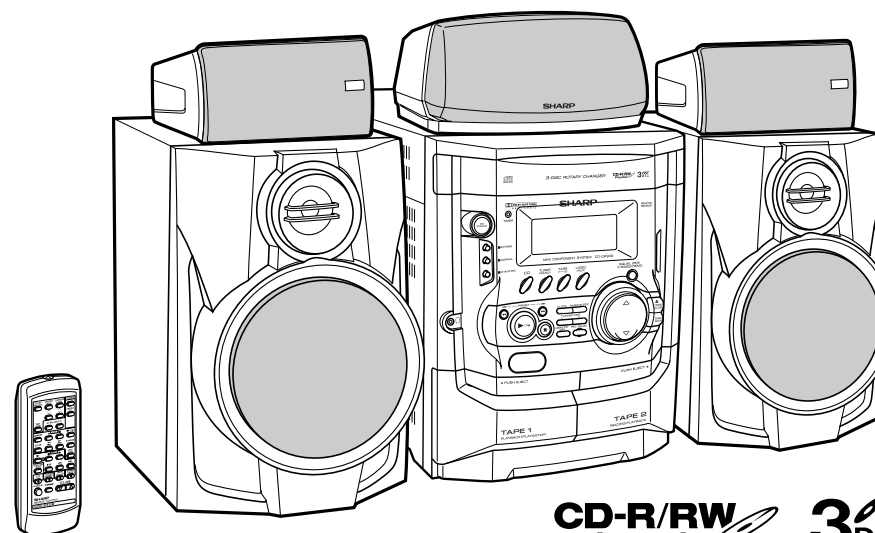

CD-R/RW
Playable  3000
DISC

Special notes

NOTES FOR USERS IN THE U.K. AND IRELAND

The mains lead of this product is fitted with a non-rewireable (moulded) plug incorporating a 3A fuse. Should the fuse need to be replaced, a BSI or ASTA approved BS 1362 fuse marked ♡ or ⬢ and of the same rating as above, which is also indicated on the pin face of the plug must be used.

Always refit the fuse cover after replacing the fuse. Never use the plug without the fuse cover fitted.

In the unlikely event of the socket outlet in your home not being compatible with the plug supplied, cut-off the mains plug and fit an appropriate type.

DANGER:

The fuse from the cut-off plug should be removed and the cut-off plug destroyed immediately and disposed of in a safe manner.

Under no circumstances should the cut-off plug be inserted elsewhere into a 13A socket outlet as a serious electric shock may occur.

To fit an appropriate plug to the mains lead, follow the instructions below:

IMPORTANT:

The wires in the mains lead are coloured in accordance with the following code:

Blue : Neutral

Brown : Live

As the colours of the wires in the mains lead of this product may not correspond with the coloured markings identifying the terminals in your plug, proceed as follows:

- The wire which is coloured blue must be connected to the plug terminal which is marked N or coloured black.
- The wire which is coloured brown must be connected to the plug terminal which is marked L or coloured red.

Ensure that neither the brown nor the blue wire is connected to the earth terminal in your three pin plug.

Before replacing the plug cover, make sure that:

- If the new fitted plug contains a fuse, its value is the same as that removed from the cut-off plug.
- The cord grip is clamped over the sheath of the mains lead and not simply over the lead wires.

IF YOU HAVE ANY DOUBT, CONSULT A QUALIFIED ELECTRICIAN.

SERVICE INFORMATION

In the unlikely event of your equipment requiring repair, please contact the dealer or supplier from whom it was purchased. Where this is not possible, please visit our web-site www.sharp.co.uk/support. Customers without internet access may telephone 08705 274277 during office hours (or (01) 676 0648 if telephoning from Ireland). Please note; all calls will be charged at local rate.

Certain replacement parts and accessories may be obtained from our main parts distributor.

WILLOW VALE ELECTRONICS LTD.

0121 766 5414

In the unlikely event of this equipment requiring repair during the guarantee period, you will need to provide proof of the date of purchase to the repairing company.

Please keep your invoice or receipt, which is supplied at the time of purchase.

Contents

WARNINGS

- When the ON/STAND-BY button is set at STAND-BY position, mains voltage is still present inside the unit. When the ON/STAND-BY button is set at STAND-BY position, the unit may be brought into operation by the timer mode or remote control.
- This unit contains no user serviceable parts. Never remove covers unless qualified to do so. This unit contains dangerous voltages, always remove mains plug from the socket before any service operation and when not in use for a long period.
- To prevent fire or shock hazard, do not expose this appliance to dripping or splashing. No objects filled with liquids, such as vases, should be placed on the apparatus.

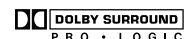

Manufactured under license from Dolby Laboratories.

"Dolby", "Pro Logic", and the double-D symbol are trademarks of Dolby Laboratories.

CAUTION

- This product is classified as a CLASS 1 LASER product.
- Use of controls, adjustments or performance of procedures other than those specified herein may result in hazardous radiation exposure.

As the laser beam used in this compact disc player is harmful to the eyes, do not attempt to disassemble the cabinet. Refer servicing to qualified personnel only.

Laser Diode Properties
Material: GaAlAs
Wavelength: 780 nm
Emission Duration: continuous
Laser Output: max. 0.6 mW

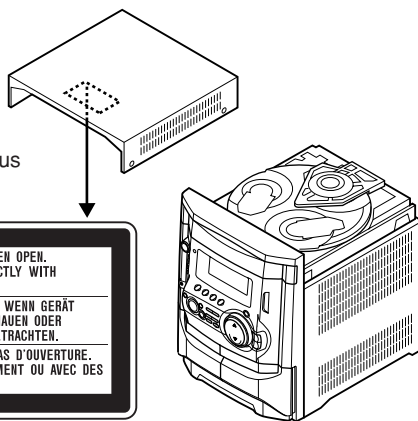

CAUTION-INVISIBLE LASER RADIATION WHEN OPEN.
DO NOT STARE INTO BEAM OR VIEW DIRECTLY WITH
OPTICAL INSTRUMENTS.
WARNUNG-UNSIICHTBARE LASERSTRAHLUNG WENN GERÄT
GEÖFFNET. NICHT IN DIE STRAHLUNG SCHAUEN ODER
DIREKT MIT OPTISCHEN HILFSMITTELN BETRACHTEN.
ATTENTION-RAYON LASER INVISIBLE EN CAS D'OUVERTURE.
NE PAS REGARDER LE FAISCEAU DIRECTEMENT OU AVEC DES
INSTRUMENTS OPTIQUES.

NOTES

- Recording and playback of any material may require consent, which SHARP is unable to give. Please refer particularly to the provisions of the Copyright Act 1956, the Dramatic and Musical Performers Protection Act 1958, the Performers Protection Acts 1963 and 1972 and to any subsequent statutory enactments and orders.
- This equipment complies with the requirements of Directives 89/336/EEC and 73/23/EEC as amended by 93/68/EEC.

General Information

Precautions	4, 5
Accessories	5
Controls and indicators	6 - 9

Preparation for Use

System connections	10 - 13
Remote control	13

Basic Operation

Sound control	14
Setting the clock	15

CD Playback

Listening to a CD (CDs)	16, 17
Repeat play	18
Random play	18
Programmed play	18

Radio

Tuning	19
Memorising a station	20
To recall a memorised station	20
To scan the preset stations	20
To erase entire preset memory	20

Tape Playback

Listening to a cassette tape (TAPE 1 or TAPE 2)	21
---	----

Tape Recording

Recording from a CD (CDs)	22
Recording from the radio	23
Dubbing from tape to tape	23
Erasing recorded tapes	23

Advanced Features

Enjoy the surround sound	24, 25
Timer and sleep operation	26, 27
Enhancing your system	28

References

Troubleshooting chart	28, 29
Maintenance	30
Specifications	30, 31

TERMS OF GUARANTEE	Back cover
--------------------	------------

Precautions

■ General

- Please ensure that the equipment is positioned in a well-ventilated area and ensure that there is at least 10 cm (4") of free space along the sides and back. There must also be a minimum of 20 cm (8") of free space on the top of the unit.

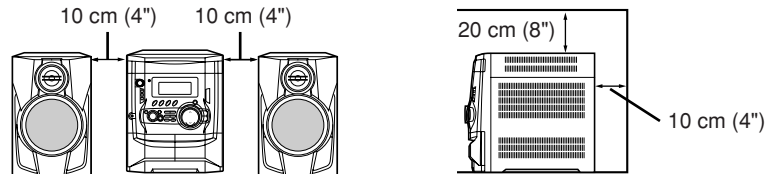

- Use the unit on a firm, level surface free from vibration.

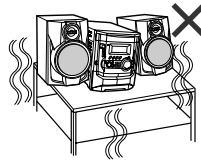

- Keep the unit away from direct sunlight, strong magnetic fields, excessive dust, humidity and electronic/ electrical equipment (home computers, facsimiles, etc.) which generates electrical noise.

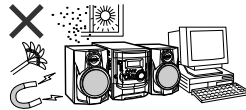

- Do not place anything on top of the unit.
- Do not expose the unit to moisture, to temperatures higher than 60°C (140°F) or to extremely low temperatures.
- If your system does not work properly, disconnect the AC power lead from the wall socket. Plug the AC power lead back in, and then turn on your system.
- In case of an electrical storm, unplug the unit for safety.

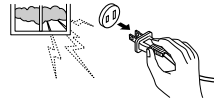

- Hold the AC power plug by the head when removing it from the wall socket, as pulling the lead can damage internal wires.

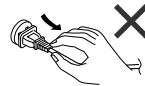

- Do not remove the outer cover, as this may result in electric shock. Refer internal service to your local SHARP service facility.

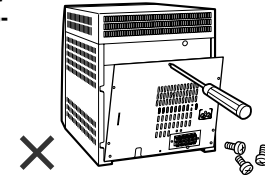

- The ventilation should not be impeded by covering the ventilation openings with items, such as newspapers, tablecloths, curtains, etc.

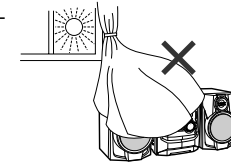

- No naked flame sources, such as lighted candles, should be placed on the apparatus.
- Attention should be drawn to the environmental aspects of battery disposal.
- The apparatus is designed for use in moderate climate.
- This unit should only be used within the range of 5°C - 35°C (41°F - 95°F).

Warning:

The voltage used must be the same as that specified on this unit. Using this product with a higher voltage other than that which is specified is dangerous and may result in a fire or other type of accident causing damage. SHARP will not be held responsible for any damage resulting from use of this unit with a voltage other than that which is specified.

■ Volume control

The sound level at a given volume setting depends on speaker efficiency, location, and various other factors. It is advisable to avoid exposure to high volume levels, to avoid this do not turn the volume on to full at switch on and listen to music at moderate levels.

Accessories

■ Care of compact discs

Compact discs are fairly resistant to damage, however mistracking can occur due to an accumulation of dirt on the disc surface. Follow the guidelines below for maximum enjoyment from your CD collection and player.

- Do not write on either side of the disc, particularly the non-label side from which signals are read. Do not mark this surface.
- Keep your discs away from direct sunlight, heat, and excessive moisture.
- Always hold the CDs by the edges. Fingerprints, dirt, or water on the CDs can cause noise or mistracking. If a CD is dirty or does not play properly, clean it with a soft, dry cloth, wiping straight out from the centre, along the radius.

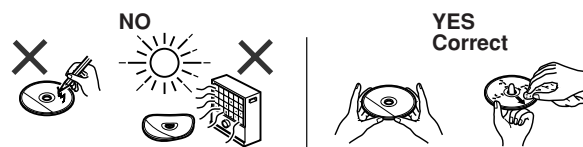

Please confirm that the following accessories are included.

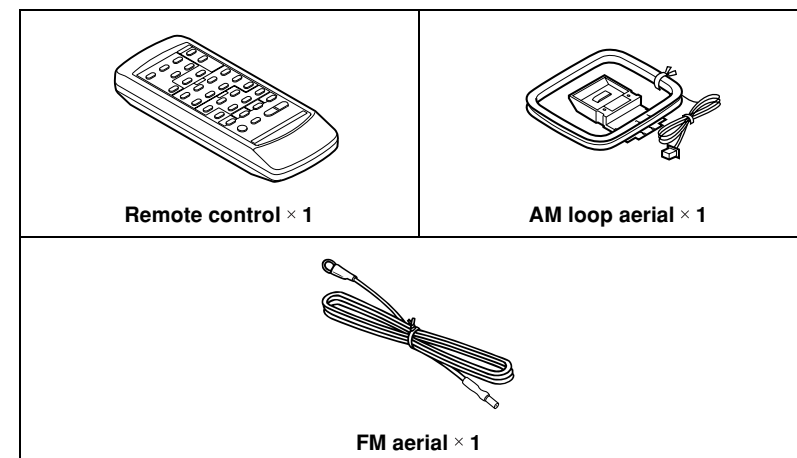

Note:

Only the above accessories are included.

Controls and indicators

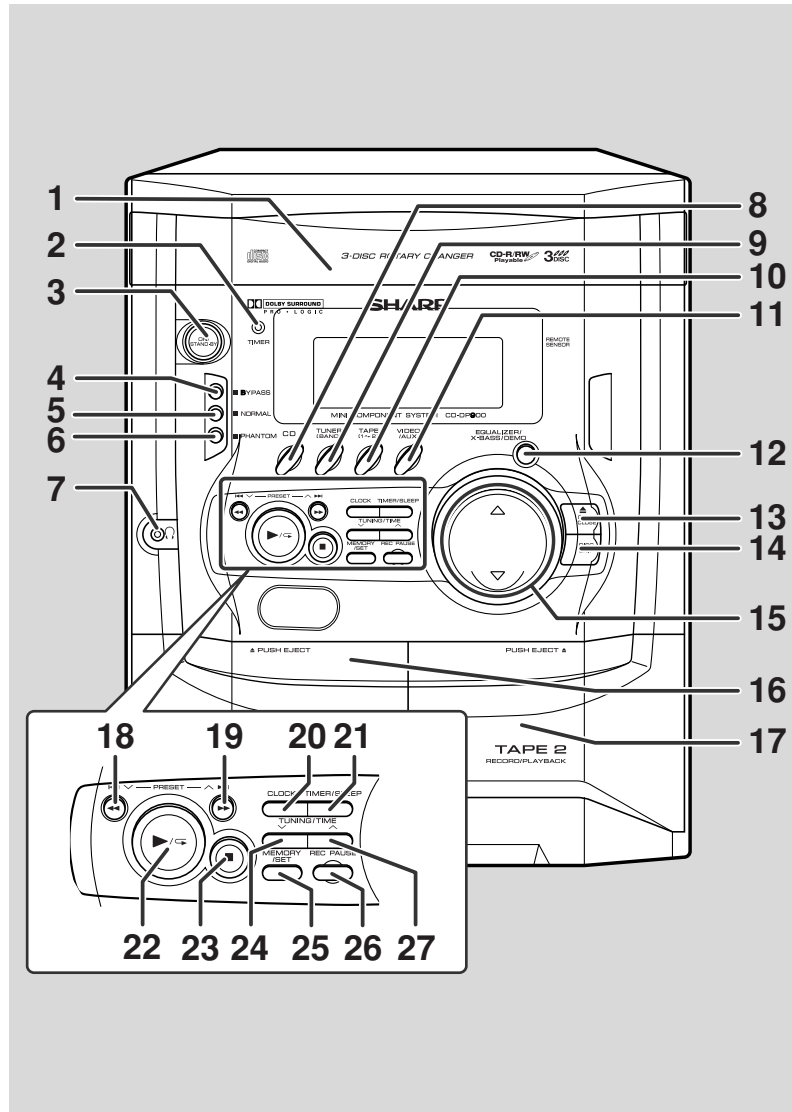

■ Front panel

	Reference page
1. Disc Tray	.16
2. Timer Set Indicator	.27
3. On/Stand-by Button	.13
4. Bypass Button (with Indicator)	.24
5. Normal Button (with Indicator)	.24
6. Phantom Button (with Indicator)	.24
7. Headphone Socket	.12
8. CD Button	.16, 22
9. Tuner (Band) Button	.19
10. Tape (1 ~ 2) Button	.21, 23
11. Video/Auxiliary Button	.26, 28
12. Equaliser Mode Select/Extra Bass/Demo Mode Button	.13, 14
13. Disc Tray Open/Close Button	.16
14. Disc Skip Button	.16
15. Volume Up and Down Buttons	.14
16. Tape 1 Cassette Compartment	.21, 23
17. Tape 2 Cassette Compartment	.21, 23
18. CD Track Down or Fast Reverse, Tape 2 Rewind, Tuner Preset Down Button	.17, 20, 21
19. CD Track Up or Fast Forward, Tape 2 Fast Forward, Tuner Preset Up Button	.17, 20, 21
20. Clock Button	.15, 26
21. Timer/Sleep Button	.26, 27
22. CD Play or Repeat, Tape Play Button	.16, 18, 21
23. CD or Tape Stop Button	.16, 21
24. Tuning and Time Down Button	.15, 19
25. Memory/Set Button	.15, 18, 20
26. Tape 2 Record Pause Button	.22, 23
27. Tuning and Time Up Button	.15, 19

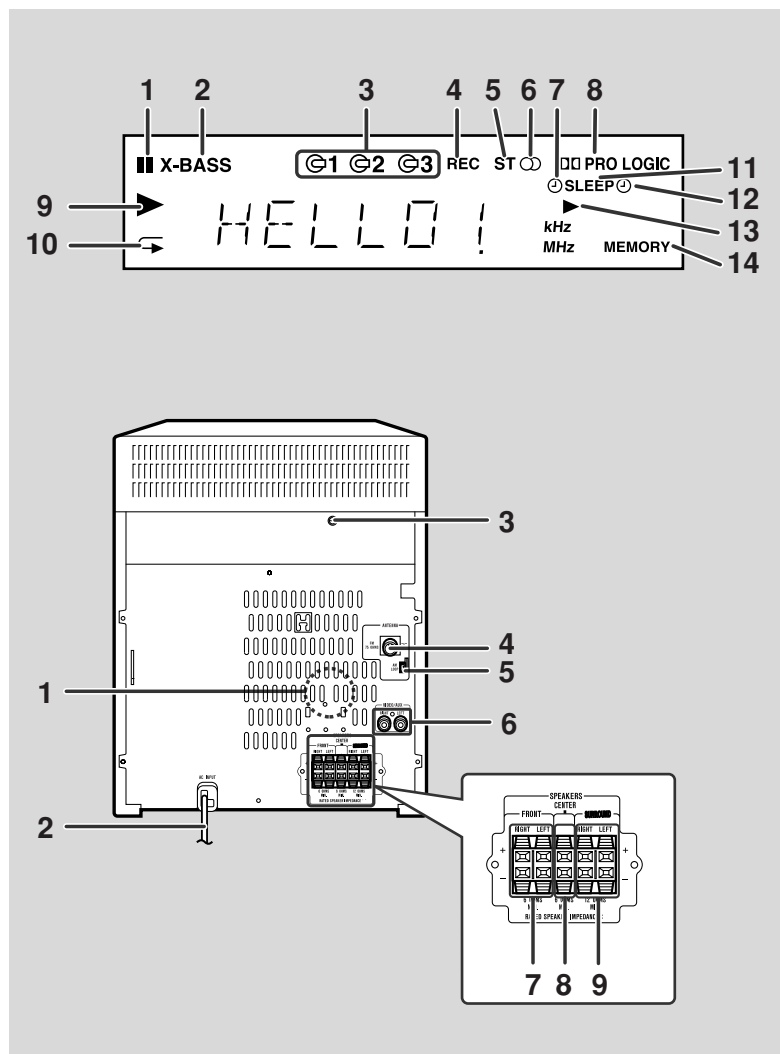

■ Display

1. CD Pause Indicator
2. Extra Bass Indicator
3. Disc Number Indicators
4. Tape 2 Record Indicator
5. FM Stereo Mode Indicator
6. FM Stereo Receiving Indicator
7. Timer Play Indicator
8. Dolby Pro Logic Indicator
9. CD Play Indicator
10. CD Repeat Play Indicator
11. Sleep Indicator
12. Timer Recording Indicator
13. Tape Play Indicator
14. Memory Indicator

■ Rear panel

Reference page

- | | |
|---|--------|
| 1. Cooling Fan | |
| 2. AC Power Lead | 10, 12 |
| 3. Transport Screw | 10, 29 |
| 4. FM 75 Ohms Aerial Socket | 10 |
| 5. AM Loop Aerial Socket | 10 |
| 6. Video/Auxiliary (Audio Signal) Input Sockets | 28 |
| 7. Front Speaker Terminals | 10, 11 |
| 8. Centre Speaker Terminals | 10, 11 |
| 9. Surround Speaker Terminals | 10, 11 |

Note:

This product is equipped with a cooling fan inside, which begins to run at a specified volume level for better heat radiation.

Controls and indicators (continued)

■ Front speaker

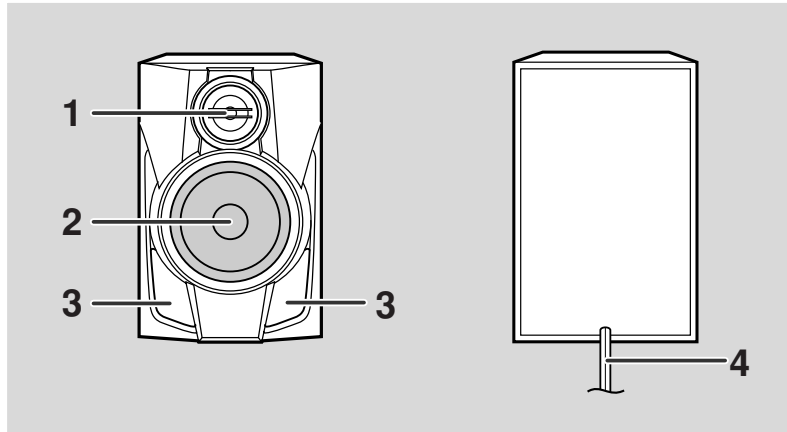

1. Tweeter
2. Woofer
3. Bass Reflex Duct
4. Speaker Wire

■ Centre speaker

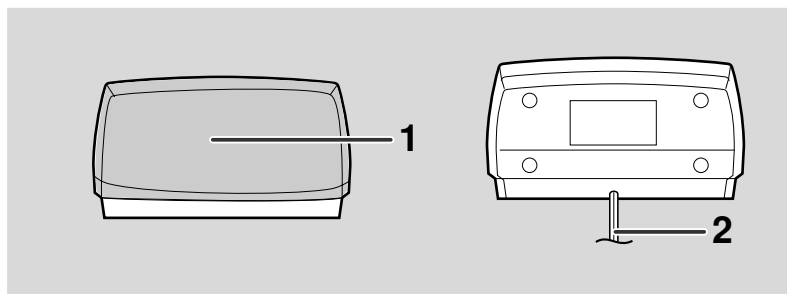

1. Full-Range Speaker
2. Speaker Wire

■ Surround speaker

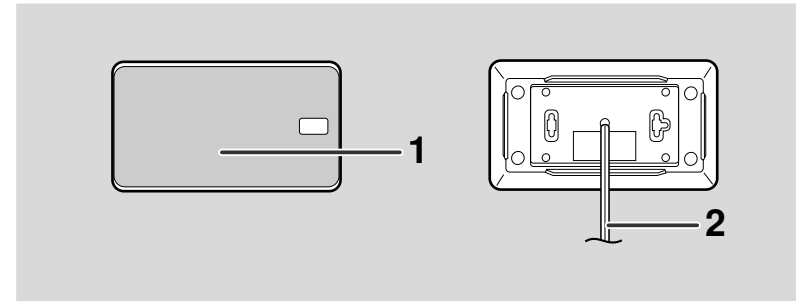

1. Full-Range Speaker
2. Speaker Wire

Note:

- When the surround speakers are hung on the wall, the speaker badge will be turned. In this case, you can adjust the badge to face the proper direction by turning it by hand.

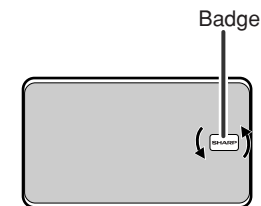

Note:

- The speaker grilles are not removable.

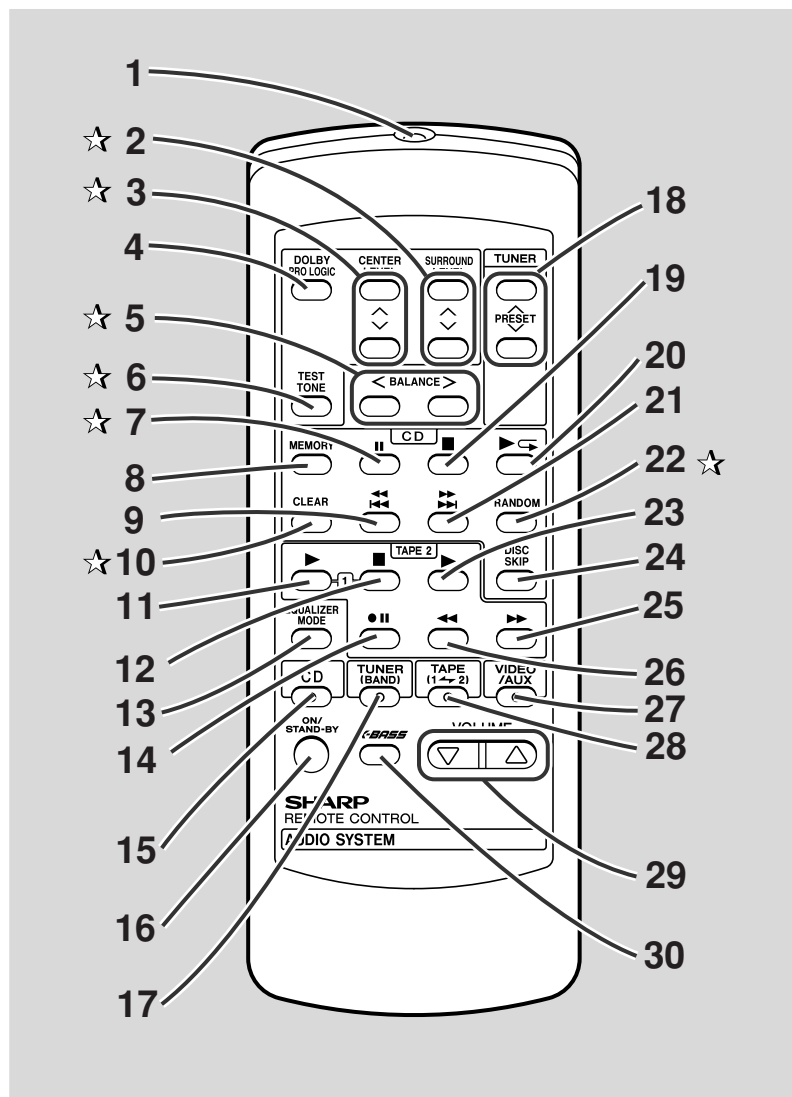

■ Remote control

	Reference page
1. Remote Control Transmitter	13
2. Surround Level Up and Down Buttons	25
3. Centre Level Up and Down Buttons	25
4. Dolby Pro Logic Button	24
5. Balance Control Up and Down Buttons	25
6. Test Tone Button	25
7. CD Pause Button	16
8. CD Memory Button	18
9. CD Track Down or Fast Reverse Button	17
10. CD Clear Button	18
11. Tape 1 Play Button	21
12. Tape 1/Tape 2 Stop Button	21
13. Equaliser Mode Select Button	14
14. Tape 2 Record Pause Button	22, 23
15. CD Button	16, 22
16. On/Stand-by Button	13
17. Tuner (Band) Button	19
18. Tuner Preset Up and Down Buttons	20
19. CD Stop Button	16
20. CD Play or Repeat Button	16, 18
21. CD Track Up or Fast Forward Button	17
22. CD Random Button	18
23. Tape 2 Play Button	21
24. Disc Skip Button	16
25. Tape 2 Fast Forward Button	21
26. Tape 2 Rewind Button	21
27. Video/Auxiliary Button	28
28. Tape (1 - 2) Button	21, 23
29. Volume Up and Down Buttons	14
30. Extra Bass Button	14

Buttons with "☆" mark in the illustration can be operated on the remote control only.
Other buttons can be operated both on the main unit and the remote control.

System connections

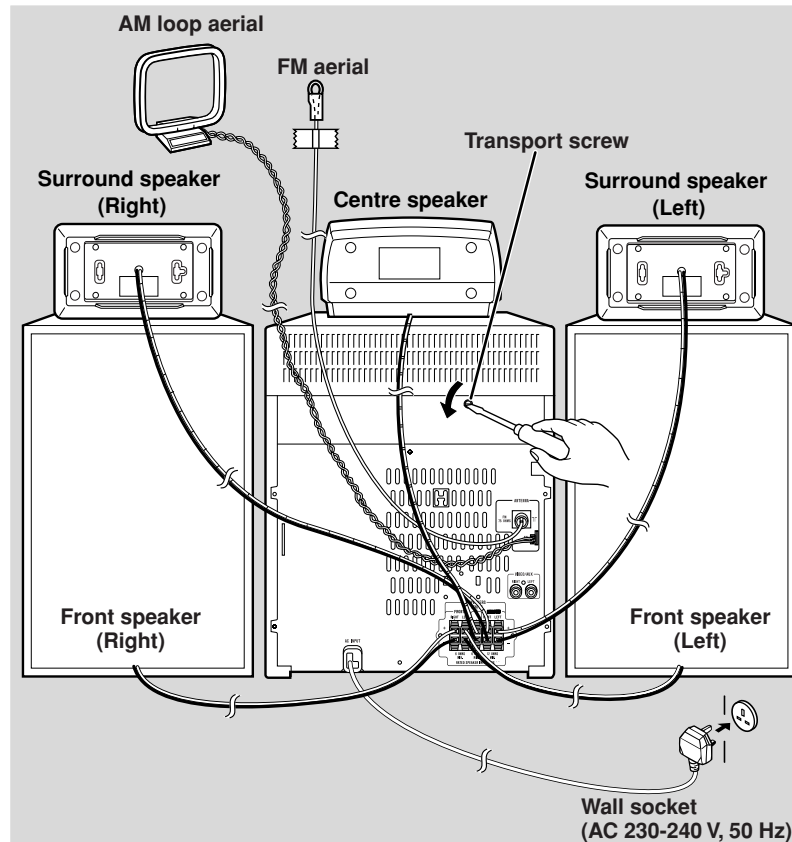

■ Removing the transport screw

Before turning the power on, be sure to remove the transport screw on the back of the unit using a flat head screwdriver or a coin.

Note:

This screw is required when transporting the unit again. Please keep it (see page 29).

■ Aerial connection

Supplied FM aerial:

Connect the FM aerial wire to the FM 75 OHMS socket and position the FM aerial wire in the direction where the strongest signal can be received.

Supplied AM loop aerial:

Connect the AM loop aerial to the AM LOOP socket. Position the AM loop aerial for optimum reception. Place the AM loop aerial on a shelf, etc., or attach it to a stand or a wall with screws (not supplied).

Note:

Placing the aerial on the stereo system or near the AC power lead may cause noise pickup. Place the aerial away from the stereo system for better reception.

Installing the AM loop aerial:

< Assembling >

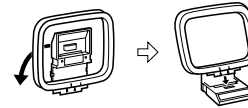

< Attaching to the wall >

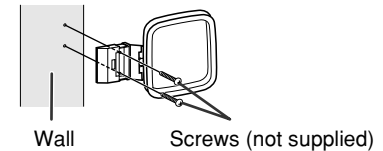

External FM aerial:

Use an external FM aerial if you require better reception. Consult your dealer.

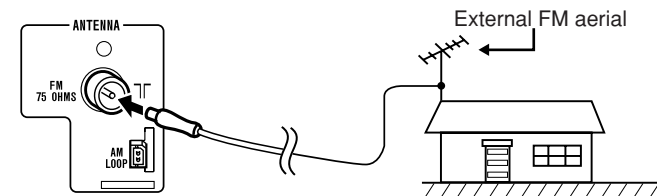

■ Speaker connection

Front speakers

Connect the black wire to the FRONT (-) terminal, and the red wire to the FRONT (+) terminal.

Centre speaker

Connect the black wire to the CENTER (-) terminal, and the orange wire to the CENTER (+) terminal.

Surround speakers

Connect the black wire to the SURROUND (-) terminal, and the grey wire to the SURROUND (+) terminal.

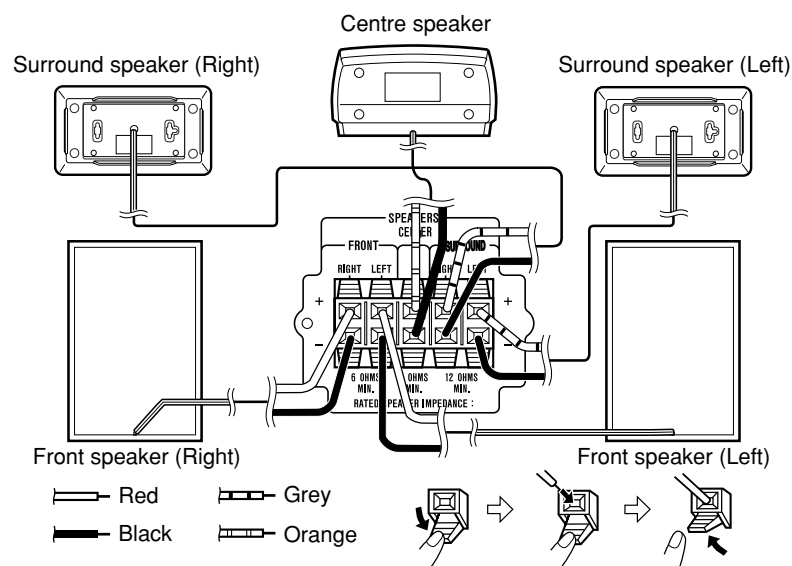

Caution:

- If you use other speakers with impedance lower than that specified, the unit may be damaged. Front speakers: 6 ohms Centre speaker: 6 ohms Surround speakers: 12 ohms
- Do not mistake the right and the left channels. The right speaker is the one on the right side when you face the unit.
- **Do not let the bare speaker wires touch each other.**
- Do not allow any objects to fall into or to be placed in the bass reflex ducts.
- Do not stand or sit on the speakers. You may be injured.

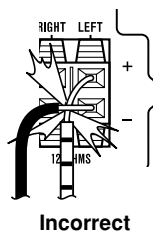

■ Placing the speaker system

To enjoy the surround effect, we recommend that you place each speaker as shown to the below.

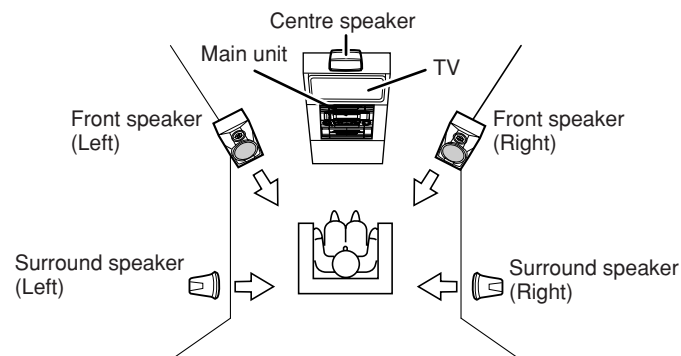

Notes:

- The front speakers and the centre speaker are magnetically shielded. Therefore, they do not affect the display even you use them near the TV. However, some colour variation may occur, depending on the type of TV used.

If colour variation occurs...

Turn off the TV (from the power switch).
After 15 - 30 minutes, turn the TV on again.

If the colour variation is still present...

Move the front speakers further away from the TV.

- If any kind of magnet or an electromagnet is placed too close to the TV and the system, irregular colours may appear on the TV screen.

Installation of the surround speakers:

If possible, mount the surround speakers on the wall. Install them 60 cm - 90 cm (23" - 35") above the height of your ears when you are seated.

Example: when installed on the wall

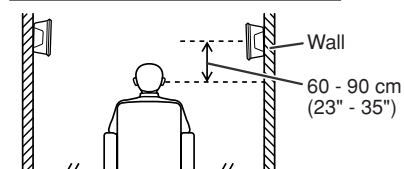

Example: when installed vertically

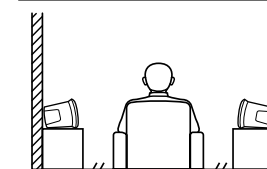

System connections (continued)

■ To mount the surround speakers on the wall

The design of the surround speakers allows them to be hung on the wall. Be sure to use the type and size of screw that is shown to the below.

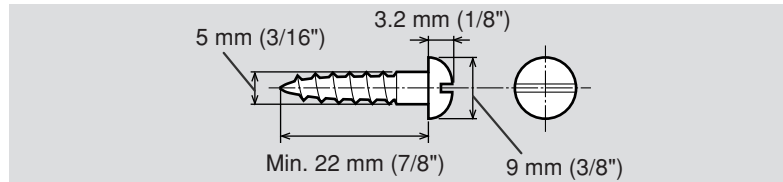

1 Make a hole in the wall using a drill.

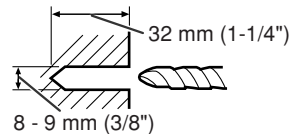

2 Drive a wall mount plug into the hole using a hammer. Drive the wall mount plug in until it is flush with the wall surface.

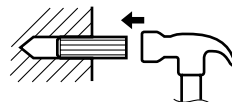

3 Drive one screw into the wall mount plug for each speaker.

Drive the screws, so there is about a 5 mm (3/16") space between the wall and the head of the screw.

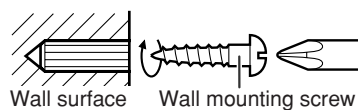

4 Mount the surround speaker on the wall so that the screw head is inserted into the slot on the surround speaker.

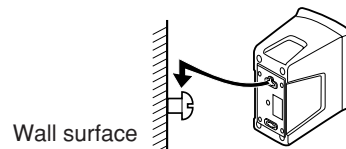

■ Connecting the AC power lead

After checking all the connections have been made correctly, plug the AC power lead of this unit into the wall socket. If you plug in the unit first, the unit will enter the demonstration mode.

Notes:

- The unit will start the tape initialisation when plugged in to the AC socket. During this process, initialising sound will be heard and the unit cannot be turned on. Wait until the process is finished.
- Unplug the AC power lead from the wall socket if the unit will not be in use for a prolonged period of time.

■ Headphones

- Before plugging in or unplugging the headphones, reduce the volume.
- Be sure your headphones have a 3.5 mm (1/8") diameter plug and are between 16 ohms and 50 ohms impedance. The recommended impedance is 32 ohms.
- Plugging in the headphones disconnects the speakers automatically. Adjust the volume using the VOLUME buttons.

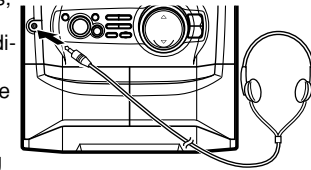

■ Demonstration mode

The first time the unit is plugged in, the unit will enter the demonstration mode. You will see words scroll.

HELLO!

To cancel the demonstration mode:

When the unit is in the power stand-by mode (demonstration mode), press the EQUALIZER/X-BASS/DEMO button. The demonstration mode will be cancelled and the display will disappear.

To return to the demonstration mode:

When the unit is in the power stand-by mode, press the EQUALIZER/X-BASS/DEMO button again.

Note:

When the power is on, the EQUALIZER/X-BASS/DEMO button can be used to select the extra bass mode.

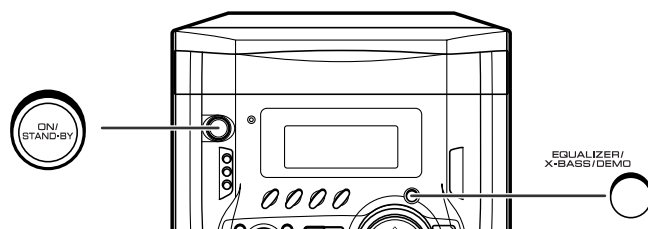

■ To turn the power on

Press the ON/STAND-BY button to turn the power on.

To set the unit to stand-by mode:

Press the ON/STAND-BY button again.

Remote control

■ Battery installation

Use 2 "AA" size batteries (UM/SUM-3, R6, HP-7 or similar). Batteries are not included.

- 1 Remove the battery cover.
- 2 Insert the batteries according to the direction indicated in the battery compartment.
- 3 Replace the cover.

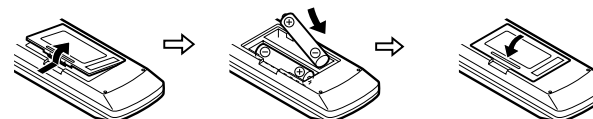

Precautions for battery use:

- Replace all old batteries with new ones at the same time.
- Do not mix old and new batteries.
- Remove the batteries if the unit is not to be used for long periods of time. This will prevent potential damage due to battery leakage.

Caution:

- Do not use rechargeable batteries (nickel-cadmium battery, etc.).
- Installing the batteries incorrectly may cause the unit to malfunction.

Notes concerning use:

- Replace the batteries if the operating distance is reduced or if the operation becomes erratic.
- Periodically clean the transmitter on the remote control and the sensor on the unit with a soft cloth.
- Exposing the sensor on the unit to strong light may interfere with operation. Change the lighting or the direction of the unit.
- Keep the remote control away from moisture, heat, shock, and vibrations.

■ Test of the remote control

Point the remote control directly at the remote sensor on the unit.

The remote control can be used within the range shown:

Press the ON/STAND-BY button. Does the power turn on? Now, you can enjoy the music.

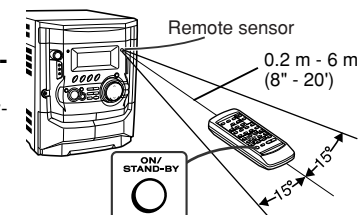

Sound control

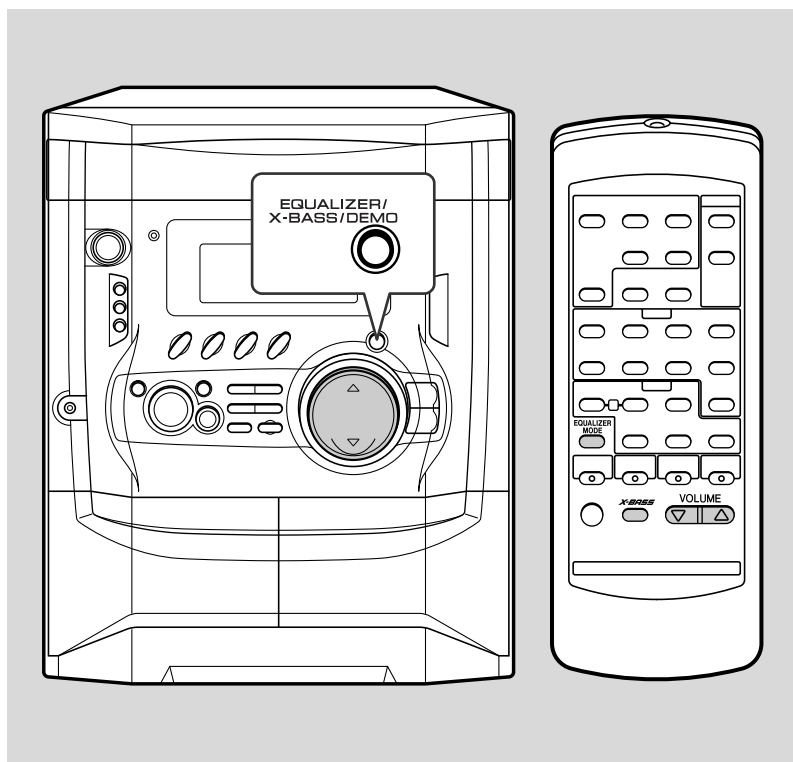

■ Volume control

Press the VOLUME (Δ or ∇) button to increase or decrease the volume.

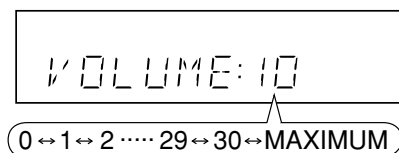

■ Extra bass (X-BASS)/Pre-programmed equaliser

(Main unit operation)

You can select the extra bass and pre-programmed equaliser modes with the same button on the main unit.

Changing the mode:

When the EQUALIZER/X-BASS/DEMO button is pressed, the current mode setting will be displayed. To change to a different mode, press the EQUALIZER/X-BASS/DEMO button repeatedly until the desired sound mode appears.

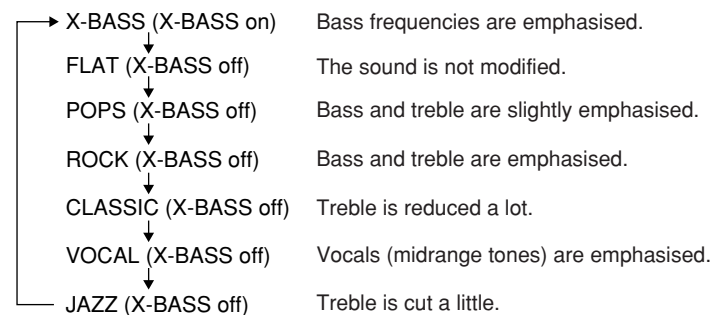

(Remote control operation)

To enter or cancel the extra bass mode:

When the power is first turned on, the unit will enter the extra bass mode which emphasises the bass frequencies, and "X-BASS" will appear. To cancel the extra bass mode, press the X-BASS button.

Selecting a pre-programmed equaliser mode:

When the EQUALIZER MODE button is pressed, the current mode setting will be displayed. To change to a different mode, press the EQUALIZER MODE button repeatedly until the desired sound mode appears.

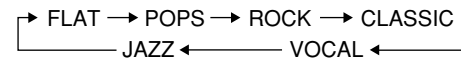

Note:

If the EQUALIZER MODE button on the remote control is pressed in the extra bass mode, it will be cancelled automatically.

Setting the clock

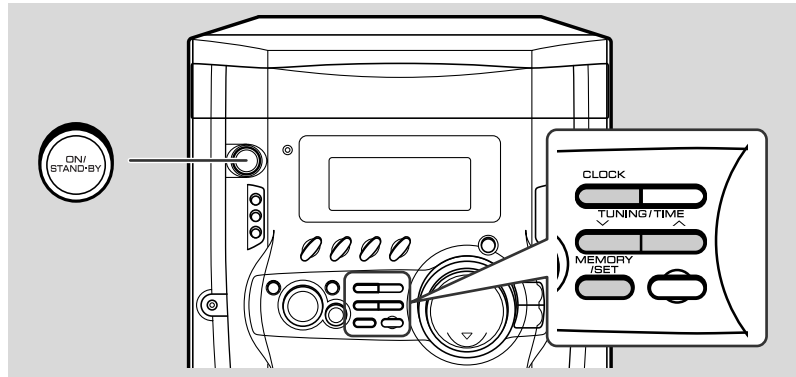

In this example, the clock is set for the 24-hour (0:00) display.

1 Press the ON/STAND-BY button to turn the power on.

2 Press the CLOCK button and within 5 seconds, press the MEMORY/SET button.

3 Press the TUNING/TIME (∨ or ∧) button to select 24-hour or 12-hour display and then press the MEMORY/SET button.

"0:00" → The 24-hour display will appear.
(0:00 - 23:59)

"AM 12:00" → The 12-hour display will appear.
(AM 12:00 - PM 11:59)

"AM 0:00" → The 12-hour display will appear.
(AM 0:00 - PM 11:59)

Note that this can only be set when the unit is first installed or it has been reset.
[Refer to "Clearing all the memory (reset)" on page 29 for details.]

4 Press the TUNING/TIME (∨ or ∧) button to adjust the hour and then press the MEMORY/SET button.



- Press the TUNING/TIME (∨ or ∧) button once to advance the time by 1 hour. Hold it down to advance continuously.
- When the 12-hour display is selected, "AM" will change automatically to "PM".

5 Press the TUNING/TIME (∨ or ∧) button to adjust the minutes and then press the MEMORY/SET button.

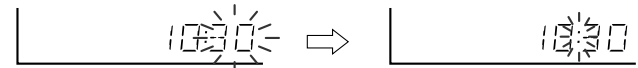

- Press the TUNING/TIME (∨ or ∧) button once to advance the time by 1 minute. Hold it down to change the time in 5-minute intervals.
- The hour will not advance even if minutes advance from "59" to "00".
- The clock begins counting from "0" seconds. (Seconds are not displayed.) The time display will disappear after a few seconds.

To confirm the time display:

Press the CLOCK button.
The time display will appear for about 5 seconds.



Note:

The "CLOCK" or time will flash at the push of the CLOCK button when the AC power supply is restored after a power failure or unplugging the unit.
Readjust the clock as follows.

To readjust the clock:

Perform "Setting the clock" from step 1. If the time display is flashing, step 3 (for selecting the 24-hour or 12-hour display) will be skipped.

To change the 24-hour or 12-hour display:

- 1 Clear all the programmed contents. [Refer to "Clearing all the memory (reset)" on page 29 for details.]
- 2 Perform "Setting the Clock" from step 1.

Listening to a CD (CDs)

This system can also play audio CD-R and CD-RW discs, but cannot record. Some audio CD-R and CD-RW discs may not be playable due to the state of disc or the device that was used for recording.

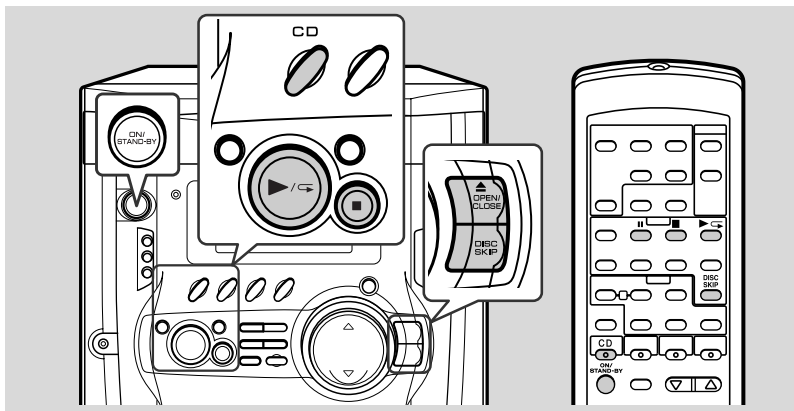

1 Press the ON/STAND-BY button to turn the power on.

2 Press the CD button.

3 Press the Δ OPEN/CLOSE button to open the disc tray.

4 Place the CD(s) on the disc tray, label side up.

When loading a third disc, press the DISC SKIP button to turn the disc tray, then place the CD in the open position.

- CDs can be placed on any open position on the disc tray.
- Be sure to place 8 cm (3") CD(s) in the middle of the disc positions.

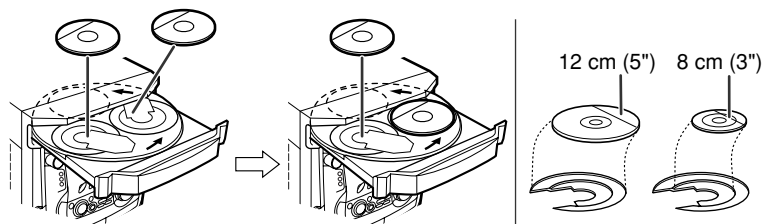

5 Press the Δ OPEN/CLOSE button to close the disc tray.

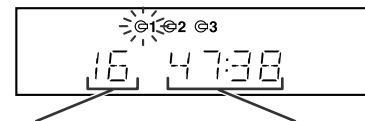

Total number of tracks on the CD whose number is flashing

Total playing time of the CD whose number is flashing

6 To select the CD you want to listen to first, press the DISC SKIP button.

7 Press the $\blacktriangleright/\blacktriangleleft$ ($\blacktriangleright \blacktriangleleft$) button to start playback.

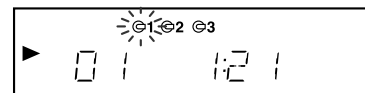

- Playback will begin from track 1 on the disc you have selected to play. After that disc finishes playing, the next disc will automatically start playback.
- When the last track on the third disc has finished playing, the CD player will stop automatically.
- When there is no CD in one of the disc 1 - 3 positions, that position will be skipped and the next CD will be played.

To interrupt playback:

Press the CD \parallel button on the remote control.
To resume playback from the same point, press the $\blacktriangleright \blacktriangleleft$ button.

To stop playback:

Press the \blacksquare (CD \blacksquare) button.

To remove the CDs:

Whilst in the stop mode, press the Δ OPEN/CLOSE button. The disc tray will open. Remove the two discs. Then, press the DISC SKIP button to rotate the disc tray and remove the remaining disc.

After use:

Press the ON/STAND-BY button to enter the power stand-by mode.

■ To locate the beginning of a track

To move to the beginning of the next track:

Press the ►► / ►► button for less than 0.5 seconds during playback.

- You can skip to any track by pressing the ►► / ►► button repeatedly until the desired track number appears.

To restart the track being played:

Press the ◀◀ / ◀◀ button for less than 0.5 seconds during playback.

- You can skip to any track by pressing the ◀◀ / ◀◀ button repeatedly until the desired track number appears.

Notes:

- You can locate the beginning of a track on a single disc only.
- The ◀◀/◀◀ or ►►/►► button on the remote control allows you to locate the beginning of a track.

■ To locate the desired portion

For audible fast forward:

Press and hold down the ►► / ►► button during playback.

For audible fast reverse:

Press and hold down the ◀◀ / ◀◀ button during playback.

Notes:

- Normal playback will resume when the ◀◀ / ◀◀ or ►► / ►► button is released.
- You can locate the desired portion on a single disc only.
- When the end of the last track is reached during fast forward, "END" will appear on the display and CD operation will be paused. When the beginning of the first track is reached during fast reverse, the unit will enter the playback mode.
- The ◀◀ / ◀◀ or ►► / ►► button on the remote control allows you to locate the desired portion.

■ Starting playback with a desired track

You can play a disc starting with the desired track.

1 Whilst in the stop mode, press the DISC SKIP button to select the desired disc.

2 Press the ◀◀ / ◀◀ or ►► / ►► button to select the desired track.

Selected disc number

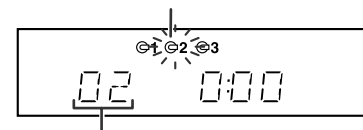

Selected track number

You can also select a track by pressing the ◀◀ / ◀◀ or ►► / ►► button on the remote control.

3 Press the ► / ◀ (► ◀) button to start playback.

Playback of the selected track is started. When the end of last track of the disc selected is reached, the next disc will be automatically started.

Note:

When the DISC SKIP button is pressed during playback, the next disc will begin automatically.

Caution:

- Do not place two CDs in one disc tray.
- Do not play discs with special shapes (heart- or octagon-shaped). It may cause malfunctions.
- Do not push the disc tray whilst it is moving.
- Do not turn the disc tray by hand. This may cause malfunctions.
- If the power fails whilst the tray is open, wait until the power is restored.
- If the disc tray is stopped forcibly, "ER-CD10" will appear on the display for 3 seconds and the unit will not function. If this occurs, press the ON/STAND-BY button to enter the power stand-by mode and then turn the power on again.
- If TV or radio interference occurs during CD operation, move the unit away from the TV or radio.
- If a disc is damaged, dirty, or loaded upside down, the disc will skip.

Listening to a CD (CDs) (continued)

Repeat play

All tracks on up to 3 discs, or a programmed sequence can be continuously repeated.

To repeat all tracks on up to 3 discs:

Press the ► / ◀ (► ◀) button twice.



To repeat a desired track:

Perform steps 1 - 4 in the "Programmed play" section and then press the ► / ◀ (► ◀) button twice.

To cancel repeat play:

Press the ► / ◀ (► ◀) button again.

"◀" will go out.

Random play

The tracks on the disc(s) can be played in random order automatically.

Press the RANDOM button on the remote control to begin random play.

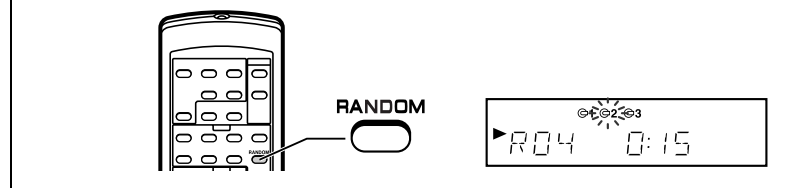

To cancel random play:

Press the ► ◀ button.

Notes:

- If you press the ►► / ►►► button during random play, you can move to the track selected next by the random operation. On the other hand, the ◀◀ / ◀◀◀ button does not allow you to move to the previous track. The beginning of the track being played will be located.
- In random play, the CD player will select and play tracks automatically. (You cannot select the order of the tracks.)

Caution:

After performing repeat or random play, be sure to press the ■ (CD ■) button. Otherwise, the disc(s) will play continuously.

Programmed play

You can choose up to 32 selections for playback in the order you like.

- 1 Whilst in the stop mode, press the **DISC SKIP** button to select the desired disc.

Selected disc number



- 2 Press the ◀◀ / ◀◀ or ►► / ►►► button to select the desired track.

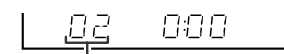

Selected track number

You can also select a track by pressing the ◀◀ / ◀◀ or ►► / ►►► button on the remote control.

- 3 Press the **MEMORY/SET (MEMORY)** button to save the track number.

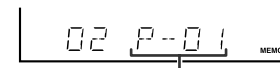
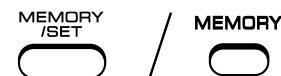

Playback order

When the track is memorised, "MEMORY" will appear.

- 4 Repeat steps 1 - 3 for other tracks. Up to 32 tracks can be programmed.

If you make a mistake, the programmed tracks can be cleared by pressing the CLEAR button.

- 5 Press the ► / ◀ (► ◀) button to start playback.

To clear the programmed selections:

Press the CLEAR button on the remote control whilst the "MEMORY" indicator is lit.

Each time the button is pressed, one track will be cleared, beginning with the last track programmed. When all the tracks are cleared, "MEMORY" will disappear.

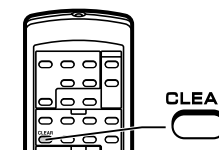

Adding tracks to the programme:

If a programme has been previously stored, the "MEMORY" indicator will be displayed. Then follow steps 1 - 3 to add tracks. The new tracks will be stored after the last track of the original programme.

Notes:

- Opening the disc tray automatically cancels the programmed sequence.
- Even if you press the ON/STAND-BY button to enter the stand-by mode or change the function from CD to another, the programmed selections will not be cleared.
- During programme operation, random play is not possible.

Listening to the radio

CD-DP900E

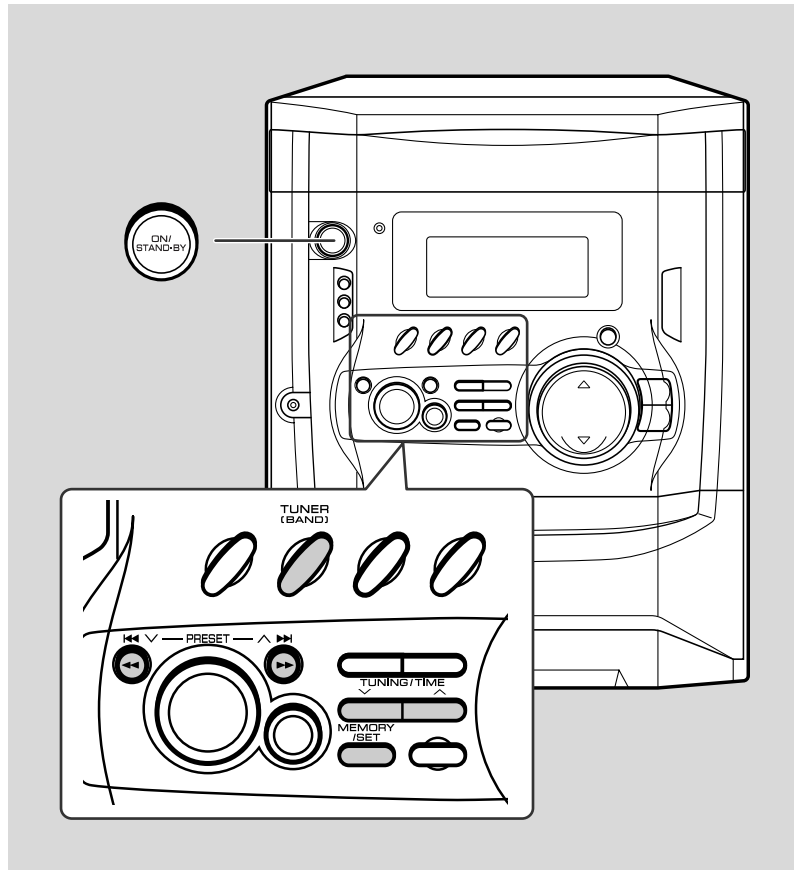

■ Tuning

- 1** Press the ON/STAND-BY button to turn the power on.
- 2** Press the TUNER (BAND) button repeatedly to select the desired frequency band (FM or AM).
- 3** Press the TUNING/TIME (∨ or ∧) button to tune in to the desired station.

Manual tuning:

Press the TUNING/TIME button as many times as required to tune in to the desired station.

Auto tuning:

When the TUNING/TIME button is pressed for more than 0.5 seconds, scanning will start automatically and the tuner will stop at the first receivable broadcast station.

Notes:

- When radio interference occurs, auto scan tuning may stop automatically at that point.
- Auto scan tuning will skip weak signal stations.
- To stop the auto tuning, press the TUNING/TIME button again.

To receive an FM stereo transmission:

Press the TUNER (BAND) button to display the "ST" indicator.

- "∞" will appear when an FM broadcast is in stereo.

FM stereo mode indicator

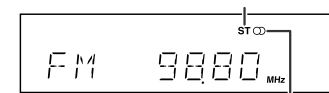

FM stereo receiving indicator

- If the FM reception is weak, press the TUNER (BAND) button to extinguish the "ST" indicator. The reception changes to monaural, and the sound becomes clearer.

After use:

Press the ON/STAND-BY button to enter the power stand-by mode.

Listening to the radio (continued)

■ Memorising a station

You can store 40 AM and FM stations in memory and recall them at the push of a button. (Preset tuning)

1 Perform steps 1 - 3 in "Tuning" on page 19.

2 Press the MEMORY/SET button to enter the preset tuning saving mode.

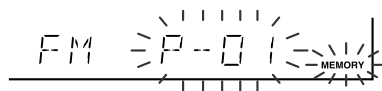

3 Within 30 seconds, press the PRESET (∨ or ∧) button to select the preset channel number.

Store the stations in memory, in order, starting with preset channel 1.

4 Within 30 seconds, press the MEMORY/SET button to store that station in memory.

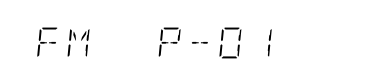

If the "MEMORY" and preset number indicators go out before the station is memorised, repeat the operation from step 2.

5 Repeat steps 1 - 4 to set other stations, or to change a preset station.

When a new station is stored in memory, the station previously memorised will be erased.

Note:

The backup function protects the memorised stations for a few hours should there be a power failure or the AC power lead disconnection.

■ To recall a memorised station

Press the PRESET (∨ or ∧) button for less than 0.5 seconds to select the desired station.

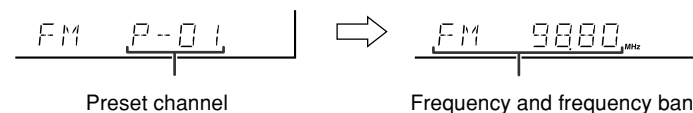

This can be operated by pressing the TUNER PRESET (∨ or ∧) button on the remote control.

■ To scan the preset stations

The stations saved in memory can be scanned automatically. (Preset memory scan)

- Press the PRESET (∨ or ∧) button for more than 0.5 seconds.
 - The preset number will flash and the programmed stations will be tuned in sequentially, for 5 seconds each.
 - This can be operated by pressing the TUNER PRESET (∨ or ∧) button on the remote control.
- Press the PRESET (∨ or ∧) button again when the desired station is located.

■ To erase entire preset memory

- Press the ON/STAND-BY button to enter the stand-by mode.
- Whilst pressing down the TUNER (BAND) button and the EQUALIZER/X-BASS/DEMO button, press the ON/STAND-BY button until "TUNER CL" appears.



Listening to a cassette tape (TAPE 1 or TAPE 2)

CD-DP900E

Before playback:

- For playback, use normal or low-noise tapes for the best sound. (Metal or CrO₂ tapes are not recommended.)
- Do not use C-120 tapes or poor-quality tapes, as they may cause malfunctions.
- Before loading a tape into the cassette compartment, tighten the slack with a pen or a pencil.

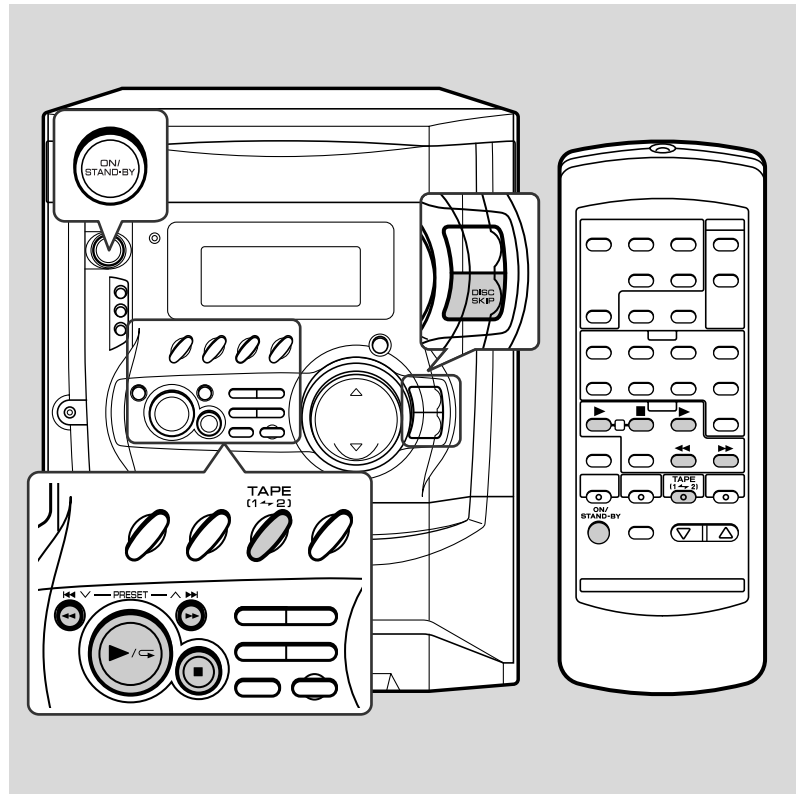
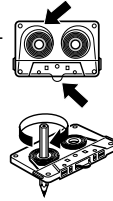

Playback is possible in TAPE 1 compartment as well as in TAPE 2.

- 1 Press the ON/STAND-BY button to turn the power on.**
- 2 Open the cassette door by pushing the area marked "▲ PUSH EJECT".**
- 3 Load a cassette into the TAPE 1 or TAPE 2 cassette compartment with the side to be played facing toward you.**
- 4 Press the TAPE (1 ~ 2) button to select the cassette you want to listen to.**
- 5 Press the ▶/◀ button to start playback.**

When playback is performed using the remote control, press the TAPE 1 or TAPE 2 ▶ button.

To stop playback:

Press the ■ (TAPE ■) button.

Fast forward/rewind: (TAPE 2 only)

- 1 Press the ■ (TAPE ■) button, then press the TAPE (1 ~ 2) button to select TAPE 2.
- 2 To advance the tape, press the ►►/►► (▶▶) button. To rewind it, press the ◀◀/◀◀ (◀◀) button.

Caution:

- To remove the cassette, press the ■ (TAPE ■) button, and then open the compartment.
- Before changing from one tape operation to another, press the ■ (TAPE ■) button.
- If a power failure occurs during tape operation, the tape head will remain engaged with the tape and the cassette door will not open. In this case, wait until the power is restored.

Tape Playback
- Listening to a cassette tape (TAPE 1 or TAPE 2) -

■ Sound control (See page 14.)

21

Recording to a cassette tape

Before recording:

- When recording important selections, make a preliminary test to ensure that the desired material is properly recorded.
- SHARP is not liable for damage or loss of your recording arising from malfunction of this unit.
- The volume and sound controls can be adjusted with no effect on the recorded signal (Variable Sound Monitor).
- **For recording, use only normal tapes. Do not use metal or CrO₂ tapes.**

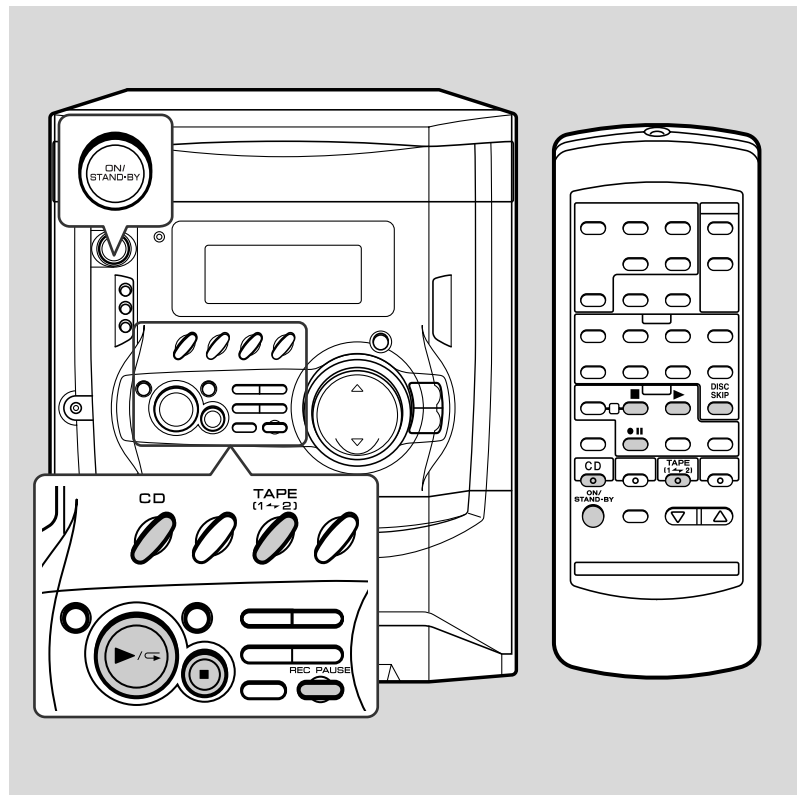

Recording can be operated in the TAPE 2 compartment. The TAPE 1 is for playback only.

■ Recording from a CD (CDs)

You can record 3 CDs continuously.

- 1 Press the ON/STAND-BY button to turn the power on.**
- 2 Load a cassette into the TAPE 2 cassette compartment with the side to be recorded on facing you.**
Wind past the leader of the tape, on which recording cannot be performed.
- 3 Press the CD button and load the desired disc.**
- 4 Press the DISC SKIP button to select the disc to be recorded first.**
- 5 Press the REC PAUSE (●||) button.**

Recording will be paused.
- 6 Press the ► / ◀ (TAPE 2 ►) button to start recording.**
 - CD playback will start approximately 7 seconds after the tape starts.
 - Recording is started from the selected CD. When the playback of the last disc is finished or the end of the tape is reached, the CD and the cassette will stop automatically.

To perform programmed recording:

- 1 Programme discs and tracks. (See page 18.)
- 2 Press the REC PAUSE (●||) button.
- 3 Press the ► / ◀ (TAPE 2 ►) button.

To stop recording:

Press the ■ (CD ■) button.
The CD and tape will stop.

Notes:

- When the end of the tape is reached whilst recording, the CD player will display the track number which was being played at that time, and stop automatically. If you want to restart recording from the beginning of the interrupted track, turn over the tape, press the REC PAUSE (●||) button and then the ► / ◀ (TAPE 2 ►) button. (If tracks have been stored in memory by programming, recording will restart from the first track stored in memory.)
- Whilst recording, ▲ OPEN/CLOSE button is deactivated. It is recommended to perform CD recording after closing the disc tray.

■ Recording from the radio

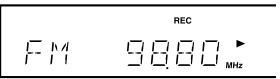
- 1 Tune in to the desired station. (See page 19.)**
- 2 Load a cassette into the TAPE 2 cassette compartment with the side to be recorded on facing you.**
Wind past the leader of the tape, on which recording cannot be performed.
- 3 Press the REC PAUSE (●||) button.**
Recording will be paused.

- 4 Press the ► / ◀ (TAPE 2 ►) button to start recording.**

To interrupt recording:

Press the REC PAUSE (●||) button.

To resume recording, press the ► / ◀ (TAPE 2 ►) button.

To stop recording:

Press the ■ (TAPE ■) button.

Note:

If you hear a whistling noise whilst recording an AM station, move the AM loop aerial.

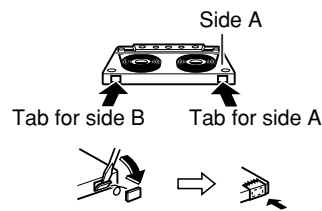

Erase-prevention tab of cassette tapes:

- When recording on a cassette tape, make sure that the erase-prevention tabs are not removed. Cassettes have removable tabs that prevent accidental recording or erasing.
- To protect the recorded sound, remove the tab after recording. Cover the tab hole with adhesive tape to record on the tape without the tab.

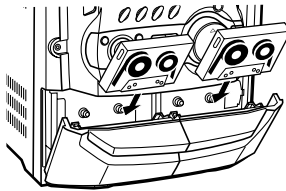
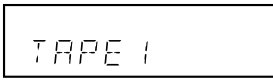

■ Dubbing from tape to tape

You can record from TAPE 1 to TAPE 2.

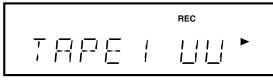
- 1 Press the ON/STAND-BY button to turn the power on.**
- 2 Load a prerecorded cassette into the TAPE 1 cassette compartment. Insert a blank tape into the TAPE 2 cassette compartment.**
It is recommended that the recording tape is the same length as the master tape.

- 3 Press the TAPE (1 ~ 2) button until "TAPE 1" appears on the display.**

- 4 Press the REC PAUSE (●||) button.**
Recording will be paused.

- 5 Press the ► / ◀ (TAPE 2 ►) button to start dubbing.**

To stop dubbing:

Press the ■ (TAPE ■) button.

TAPE 1 and TAPE 2 will simultaneously stop.

■ Erasing recorded tapes

- 1 Load the tape to be erased into the TAPE 2 cassette compartment with the side to be erased facing toward you.
- 2 Press the TAPE (1 ~ 2) button until "TAPE 2" appears on the display.
- 3 Press the REC PAUSE (●||) button.
- 4 Press the ► / ◀ (TAPE 2 ►) button to start erasing.

Note:

Make sure that the TAPE 1 is not in use.

Enjoy the surround sound

■ Dolby Pro Logic Surround (Normal or Phantom) mode

By connecting this unit to other equipment (DVD player, VCR, etc.) with the  **DOLBY SURROUND** trademark and playing it, you can enjoy Dolby Pro Logic Surround sound.

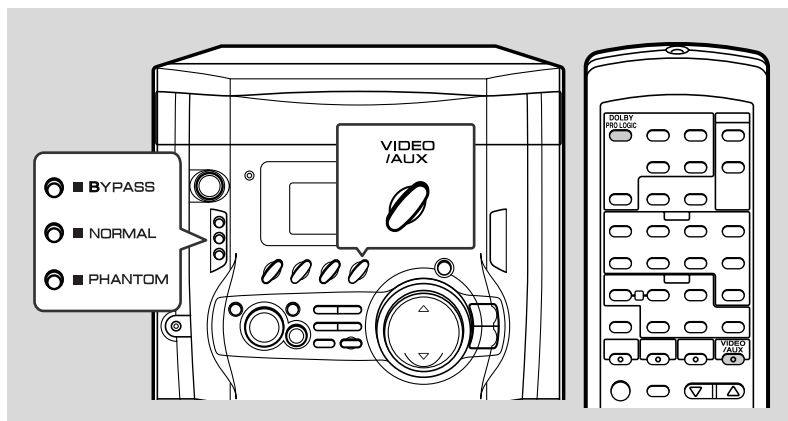

Normal mode:

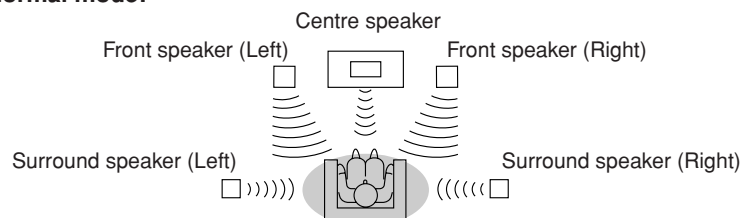

Phantom mode:

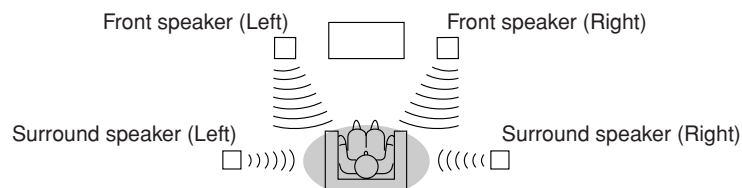

To listen in the normal or phantom mode:

1 Connect the equipment you want to play (see page 28).

2 Press the VIDEO/AUX button.

3 Press the DOLBY PRO LOGIC button on the remote control to select the Dolby Pro Logic Surround mode.

Each time you press the button, the display will change as follows:

NORMAL → PHANTOM → BYPASS

NORMAL: Sound will be output from the front left, front right, centre, and surround speakers.

PHANTOM: Unlike the normal mode, no sound is output from the centre speaker. The centre speaker signal is split equally and added to the sound from the front speakers.

BYPASS: The Dolby Pro Logic Surround mode is cancelled. Sound will only be output from the front speakers.

- You can select the desired surround mode by pressing the NORMAL or PHANTOM button on the main unit.

4 Start playing the sound source.

To cancel the Dolby Pro Logic Surround mode:

Press the DOLBY PRO LOGIC button on the remote control until "BYPASS" appears, or press the BYPASS button on the main unit.

Notes:

- If the EQUALIZER/X-BASS/DEMO(EQUALIZER MODE or X-BASS) button is pressed in the normal or phantom mode, the unit is switched to the bypass mode automatically.
- When in the normal or phantom mode, the sound mode will be set to FLAT.
- You cannot use the Dolby Pro Logic Surround feature with headphones.
- The selected Dolby Pro Logic Surround mode is automatically stored in memory and will be used the next time you activate Dolby Pro Logic. This mode is memorised until a new mode is selected.

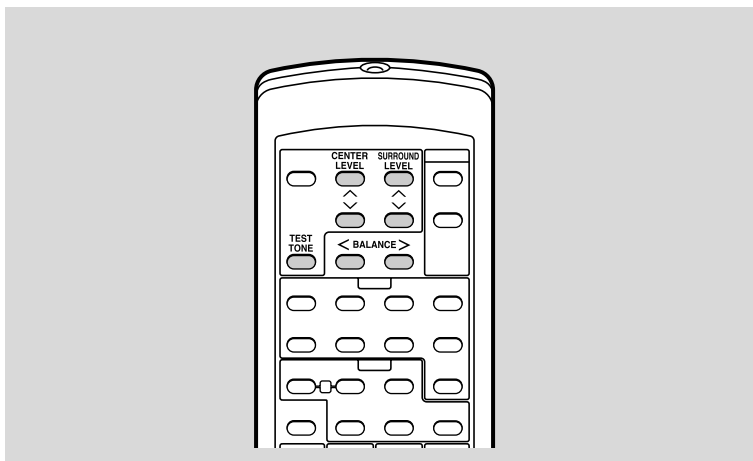

To adjust the speaker volume:

1 When in the normal or phantom mode, press the TEST TONE button.

The test tone will be heard from each speaker, in order, at about 2-second intervals.

In normal mode:

Left (L ch) → Centre (C ch) → Right (R ch) → Surround (S ch)

In phantom mode:

Left (L ch) → Right (R ch) → Surround (S ch)

2 Adjust the speaker volume level whilst the test tone is being output from the centre or surround speakers.

To set the centre speaker volume to the level of the front speakers:

When in the normal mode, press the CENTER LEVEL ^ button to increase the volume and the CENTER LEVEL v button to decrease it.

Cch + 10 ← -10 ⇄ -9 ... 0 ... +9 ⇄ +10

To set the surround speaker volume to the level of the front speakers:

When in the normal or phantom mode, press the SURROUND LEVEL ^ button to increase the volume and the SURROUND LEVEL v button to decrease it.

Sch + 10 ← -10 ⇄ -9 ... 0 ... +9 ⇄ +10

- You can change the volume level within the range of +10dB to -10dB, in 1 dB steps.

3 After adjusting the speaker volume level, press the TEST TONE button.

The test tone will stop.

To balance the front speakers:

Press the BALANCE < button to decrease the right speaker level (the left speaker level will increase), and press the BALANCE > button to decrease the left speaker level (the right speaker level will increase).

LEFT: 1 — 15 RIGHT: 1 — 15

Notes:

- Be sure to adjust the sound at your favorite listening position.
- The volume settings for the centre and surround speakers are stored in memory for future use. However, after a power failure or leaving the unit unplugged for over one day, they will return to initial settings.

Timer and sleep operation

Timer playback:

The unit turns on and plays the desired source (CD, tuner, tape) at the preset time.

Timer recording:

The unit turns on and starts recording from the tuner at the preset time.

Sleep operation:

The radio, compact disc and cassette tape can all be turned off automatically.

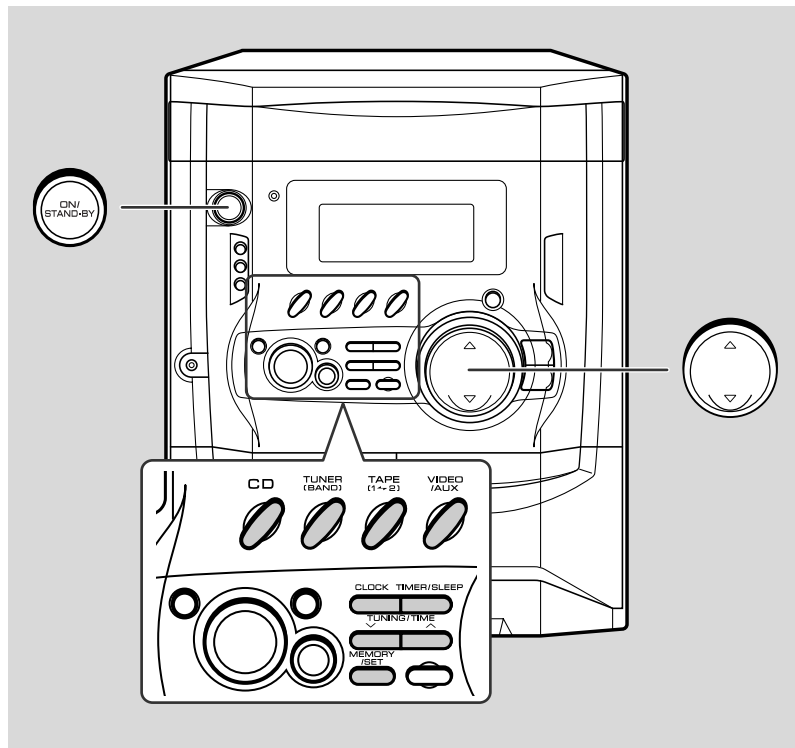

■ Timer playback or timer recording

Before setting timer:

- 1 Press the CLOCK button to check that the clock is on time.



- 2 For timer playback: Load a cassette or discs to be played.
For timer recording: Load a cassette for recording in the TAPE 2 cassette compartment.



- 1 Press the ON/STAND-BY button to turn the power on.

- 2 Press the CD, TUNER (BAND) or TAPE (1 – 2) button to select the desired function.

To select the timer playback source: CD, TUNER (BAND) or TAPE (1 – 2).

To select the timer recording source: TUNER (BAND).

When you selected the TUNER (BAND), tune in to the desired station.

- 3 Adjust the volume using the VOLUME buttons.

Do not turn the volume up too high.

- 4 Press the TIMER/SLEEP button repeatedly to select timer playback or timer recording.

Display the white "☀" for timer playback and the red "☀" for timer recording.

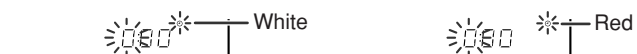

- 5 Press the TUNING/TIME (∨ or ∧) button to specify the hour to start, then press the MEMORY/SET button.



The illustrations show the timer playback setting.

6 Press the TUNING/TIME (∨ or ∧) button to specify the minutes, then press the MEMORY/SET button.



7 The unit will enter the timer stand-by mode automatically.

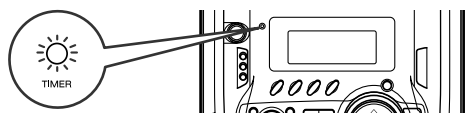

To cancel the timer playback/timer recording:

Press the ON/STAND-BY button to turn the power on.

8 When the preset time is reached, playback or recording will start.

The volume will increase gradually until it reaches the volume you were listening at before your system enters the timer stand-by mode.

9 In timer playback:

If you select CD or TAPE, the unit will enter the stand-by mode after the playback. If you select TUNER, it will enter the stand-by mode one hour after the timer playback starts.

In timer recording:

When the recording tape reaches its end, the timer recording will end, and the unit will enter the stand-by mode.

To reset or change the timer setting:

Perform "Timer playback or timer recording" from the beginning.

Notes:

- Once the time is set, the setting will be retained until a new time is entered.
- When performing timer playback or recording using another unit connected to the VIDEO/AUX sockets, select "VIDEO/AUX" in step 2. At this time, only this unit will be turned on or enter the power stand-by mode automatically. It will enter the power stand-by mode when the end of the recording tape is reached in timer recording or 1 hour after the playback starts in timer playback. However, another unit will not be turned on or off.

■ Sleep operation

1 Play back the desired sound source.

2 Press the TIMER/SLEEP button repeatedly until "SLEEP" is displayed.

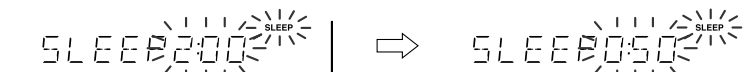

To change the sleep time:

Whilst the sleep time is displayed, press the TUNING/TIME (∨ or ∧) button.

(Maximum: 3 hours - Minimum: 1 minute)

- 3 hours - 5 minutes → 5-minute intervals
- 5 minutes - 1 minute → 1-minute intervals

3 Press the MEMORY/SET button.

4 Your system will enter the power stand-by mode automatically after the preset time has elapsed.

The volume will be turned down 1 minute before the sleep operation finishes.

To cancel the sleep operation:

Press the ON/STAND-BY button whilst the sleep timer is set.

To confirm the remaining sleep time:

Press the TIMER/SLEEP button whilst the sleep timer is set. The remaining sleep time is displayed for about 5 seconds.

Note:

Once the sleep time is set, it will remain unchanged until a new time is entered.

Enhancing your system

The connection lead is not included. Purchase a commercially available lead as shown below.

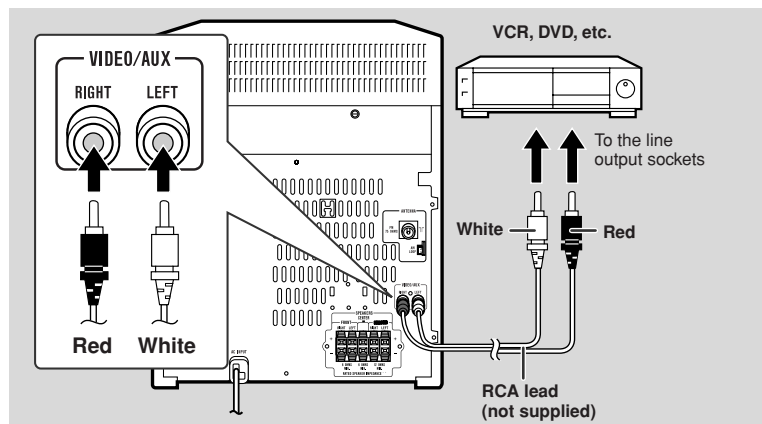

■ Listening to the playback sounds from VCR, DVD, etc.

1 Use a connection lead to connect the VCR, DVD, etc. to the VIDEO/AUX sockets.

When using video equipment, connect the audio output to this unit and the video output to a television.

2 Press the ON/STAND-BY button to turn the power on.

3 Press the VIDEO/AUX button.

4 Play the connected equipment.

Note:

To prevent hum interference, place this unit away from a television.

■ To record on a tape

1 Insert a cassette in the TAPE 2 cassette compartment.

2 Press the VIDEO/AUX button.

3 Press the REC PAUSE (●||) button.

4 Press the ►/◄ (TAPE 2 ►) button.

5 Play the VCR, DVD, etc.

Troubleshooting chart

Many potential problems can be resolved by the owner without calling a service technician.

If something is wrong with this product, check the following before calling your authorised SHARP dealer or service centre.

■ General

Symptom	Possible cause
<ul style="list-style-type: none"> The clock is not on time. 	<ul style="list-style-type: none"> Did a power failure occur? Reset the clock. (Refer to page 15.)
<ul style="list-style-type: none"> When a button is pressed, the unit does not respond. 	<ul style="list-style-type: none"> Set this unit to the power stand-by mode and then turn it back on. If the unit still malfunctions, reset it. (Refer to page 29.)
<ul style="list-style-type: none"> No sound is heard. 	<ul style="list-style-type: none"> Is the volume level set to "0"? Are the headphones connected? Are the speaker wires disconnected?

■ CD player

Symptom	Possible cause
<ul style="list-style-type: none"> Playback does not start. 	<ul style="list-style-type: none"> Is the disc loaded upside down?
<ul style="list-style-type: none"> Playback stops in the middle or is not performed properly. 	<ul style="list-style-type: none"> Does the disc satisfy the standards? Is the disc distorted or scratched?
<ul style="list-style-type: none"> Playback sounds are skipped, or stopped in the middle of a track. 	<ul style="list-style-type: none"> Is the unit located near excessive vibrations? Is the disc very dirty? Has condensation formed inside the unit?

■ Tuner

Symptom	Possible cause
<ul style="list-style-type: none"> Radio makes unusual noise consecutively. 	<ul style="list-style-type: none"> Is the unit placed near the TV or computer? Is the FM aerial or AM loop aerial placed properly? Move the AC power lead or the unit away from the aerial if located near.

■ Cassette deck

Symptom	Possible cause
<ul style="list-style-type: none"> ● Cannot record. 	<ul style="list-style-type: none"> ● Is the erase-prevention tab removed?
<ul style="list-style-type: none"> ● Cannot record tracks with proper sound quality. ● Cannot erase completely. 	<ul style="list-style-type: none"> ● Is it a normal tape? (You cannot record on a metal or CrO₂ tape.)
<ul style="list-style-type: none"> ● Sound skipping. 	<ul style="list-style-type: none"> ● Is there any slack? ● Is the tape stretched?
<ul style="list-style-type: none"> ● Cannot hear treble. ● Sound fluctuation. 	<ul style="list-style-type: none"> ● Are the capstans, pinch rollers, or heads dirty?
<ul style="list-style-type: none"> ● Cannot remove the tape. 	<ul style="list-style-type: none"> ● If a power failure occurs during playback, the heads remain engaged with the tape. Do not open the compartment forcibly. Wait until electricity resumes.

■ Remote control

Symptom	Possible cause
<ul style="list-style-type: none"> ● The remote control does not operate. 	<ul style="list-style-type: none"> ● Is the AC power lead of the unit plugged in? ● Is the battery polarity respected? ● Are the batteries dead? ● Is the distance or angle incorrect? ● Does the remote control sensor receive strong light?

■ Condensation

Sudden temperature changes, storage or operation in an extremely humid environment may cause condensation inside the cabinet (CD pickup, tape heads, etc.) or on the transmitter on the remote control. Condensation can cause the unit to malfunction. If this happens, leave the power on with no disc (or cassette) in the unit until normal playback is possible (about 1 hour). Wipe off any condensation on the transmitter with a soft cloth before operating the unit.

■ If trouble occurs

When this product is subjected to strong external interference (mechanical shock, excessive static electricity, abnormal supply voltage due to lightning, etc.) or if it is operated incorrectly, it may malfunction.

If such a problem occurs, do the following:

- 1 Set the unit to the stand-by mode and turn the power on again.
- 2 If the unit is not restored in the previous operation, unplug and plug in the unit, and then turn the power on.

Note:

If neither operation above restores the unit, clear all the memory by resetting it.

■ Clearing all the memory (reset)

- 1 Press the ON/STAND-BY button to enter the power stand-by mode.
- 2 Whilst pressing down the CLOCK button and the EQUALIZER/X-BASS/DEMO button, press the ON/STAND-BY button until "CLEAR AL" appears.

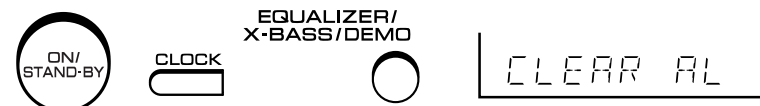

Caution:

This operation will erase all data stored in memory including clock, timer settings, tuner preset, and CD programme.

■ Before transporting the unit

On the back of this unit is equipped with a transport screw in order to prevent damage during transportation.

- 1 Press the ON/STAND-BY button to turn the power on.
- 2 Press the CD button.
- 3 Press the Δ OPEN/CLOSE button to open the disc tray. Remove all CDs inserted in the unit.
- 4 Press the Δ OPEN/CLOSE button to close the disc tray. Make sure that "NO DISC" is displayed.
- 5 Press the ON/STAND-BY button to enter the stand-by mode, and then unplug the AC power lead from the wall socket.
- 6 Insert the transport screw into the back of the unit and tighten it with a flat head screwdriver or a coin.

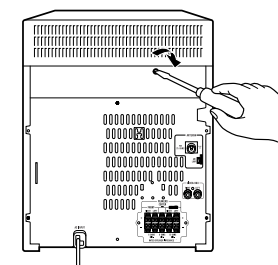

Maintenance

■ Cleaning the tape-handling parts

- Dirty heads, capstans or pinch rollers can cause poor sound and tape jams. Clean these parts with a cotton swab moistened with commercial head/pinch roller cleaner or isopropyl alcohol.
- When cleaning the heads, pinch rollers, etc., unplug the unit which contains high voltages.

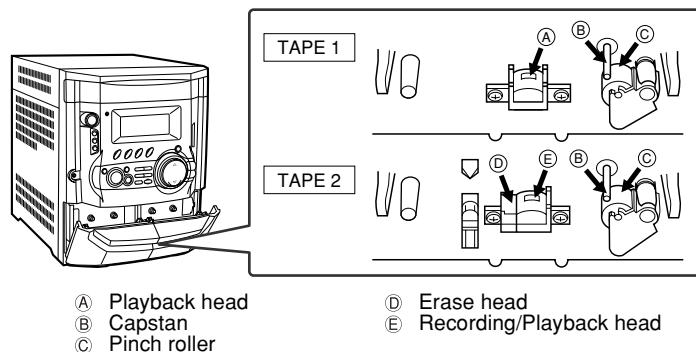

- After long use, the deck's heads and capstans may become magnetised, causing poor sound. Demagnetise these parts once every 30 hours of playing/recording time by using a commercial tape head demagnetiser. Read the demagnetiser's instructions carefully before use.

■ Cleaning the cabinet

Periodically wipe the cabinet with a soft cloth and a diluted soap solution, then with a dry cloth.

Caution:

- Do not use chemicals for cleaning (petrol, paint thinner, etc.). It may damage the cabinet finish.
- Do not apply oil to the inside of the unit. It may cause malfunctions.

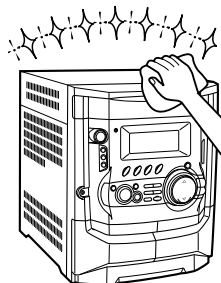

Specifications

As part of our policy of continuous improvement, SHARP reserves the right to make design and specification changes for product improvement without prior notice. The performance specification figures indicated are nominal values of production units. There may be some deviations from these values in individual units.

■ General

Power source	AC 230-240 V, 50 Hz
Power consumption	116 W
Dimensions	Width: 270 mm (10-5/8") Height: 330 mm (13") Depth: 355 mm (13-15/16")
Weight	7.2 kg (15.9 lbs.)

■ Amplifier

Output power	Front speakers: RMS: 80 W (40 W + 40 W) (10 % T.H.D.) RMS: 64 W (32 W + 32 W) (0.9 % T.H.D.) Centre speaker: RMS: 20 W (10 % T.H.D.) RMS: 16 W (0.9 % T.H.D.) Surround speakers: RMS: 20 W (10 W + 10 W) (10 % T.H.D.) RMS: 16 W (8 W + 8 W) (0.9 % T.H.D.)
Output terminals	Front speakers: 6 ohms Centre speaker: 6 ohms Surround speakers: 12 ohms Headphones: 16 - 50 ohms (recommended: 32 ohms)
Input terminals	Video/Auxiliary (audio signal): 500 mV/47 kohms

■ CD player

Type	3-disc multi-play compact disc player
Signal readout	Non-contact, 3-beam semiconductor laser pickup
D/A converter	1-bit D/A converter
Frequency response	20 - 20,000 Hz
Dynamic range	90 dB (1 kHz)

■ Tuner

Frequency range	FM: 87.5 - 108 MHz AM: 522 - 1,620 kHz
------------------------	---

■ Cassette deck

Frequency response	50 - 14,000 Hz (Normal tape)
Signal/noise ratio	55 dB (TAPE 1, playback) 50 dB (TAPE 2, recording/playback)
Wow and flutter	0.3 % (WRMS)

■ Front speaker

Type	2-way type speaker system 5 cm (2") Tweeter 13 cm (5-1/8") Woofer
Maximum input power	80 W
Rated input power	40 W
Impedance	6 ohms
Dimensions	Width: 220 mm (8-11/16") Height: 330 mm (13") Depth: 194 mm (7-5/8")
Weight	2.8 kg (6.2 lbs./each)

■ Centre speaker

Type	10 cm (4") full-range speaker
Maximum input power	40 W
Rated input power	20 W
Impedance	6 ohms
Dimensions	Width: 260 mm (10-1/4") Height: 140 mm (5-1/2") Depth: 169 mm (6-5/8")
Weight	0.9 kg (2.0 lbs.)

■ Surround speaker

Type	10 cm (4") full-range speaker
Maximum input power	20 W
Rated input power	10 W
Impedance	12 ohms
Dimensions	Width: 210 mm (8-1/4") Height: 130 mm (5-1/8") Depth: 154 mm (6-1/16")
Weight	0.7 kg (1.5 lbs./each)



TERMS OF GUARANTEE

Sharp Electronics (UK) Ltd. ("Sharp") guarantees to provide for the repair, or at its option the replacement, of this product subject to the conditions listed below:-

1. This guarantee shall only apply to faults which are due to inferior workmanship or materials. It does not cover faults or damage caused by accident, misuse, fair wear and tear, neglect, tampering with the product, or repair other than by a Service Facility appointed by Sharp.
2. As this product is intended for private domestic use only, the guarantee will not apply if the product is used in the course of a business, trade or profession.
3. To benefit from this guarantee, any fault which occurs must be notified to Sharp, or its appointed Service Facility within one year from the date this product was purchased. Proof of purchase must be provided.
4. The guarantee does not cover carriage costs, jewelled styli, audio tapes, compact discs or batteries.
5. In the unlikely event of this product requiring repair, please contact the supplier from whom it was purchased. Where this is not possible, please contact the Sharp Customer Information Centre on the telephone number given below.
6. No person has any authority to vary the terms or conditions of this guarantee.
7. This guarantee is offered as an additional benefit to your statutory rights, and does not affect these rights in any way.

If you have any difficulty operating this product, or would like information on other Sharp products, please telephone the Sharp Customer Information Centre on the number given below.

Sharp Customer Information Centre - Telephone 08705 274277
(or (01) 676 0648 if telephoning from Ireland)

SHARP

SHARP ELECTRONICS (U.K.) LTD.

Sharp House, Thorp Road, Newton Heath, Manchester, M40 5BE

SHARP CORPORATION

TINSE0456AWZZ
A0201.HK

Free Manuals Download Website

<http://myh66.com>

<http://usermanuals.us>

<http://www.somanuals.com>

<http://www.4manuals.cc>

<http://www.manual-lib.com>

<http://www.404manual.com>

<http://www.luxmanual.com>

<http://aubethermostatmanual.com>

Golf course search by state

<http://golfingnear.com>

Email search by domain

<http://emailbydomain.com>

Auto manuals search

<http://auto.somanuals.com>

TV manuals search

<http://tv.somanuals.com>