

SHARP®



OPERATION MANUAL



MODEL XG-NV5XU

LCD PROJECTOR



Before using the LCD projector, please read this operation manual carefully.

OPERATION MANUAL

ENGLISH

IMPORTANT

For your assistance in reporting the loss or theft of your Color LCD Projector, please record the Serial Number located on the bottom of the projector and retain this information. Before recycling the packaging, please be sure that you have checked the contents of the carton thoroughly against the list of "Supplied Accessories" on page 7.

Model No.: XG-NV5XU

Serial No.:

There are two important reasons for prompt warranty registration of your new SHARP LCD Projector, using the REGISTRATION CARD packed with the projector.

1. WARRANTY

This is to assure that you immediately receive the full benefit of the parts, service and labor warranty applicable to your purchase.





2. CONSUMER PRODUCT SAFETY ACT

To ensure that you will promptly receive any safety notification of inspection, modification, or recall that SHARP may be required to give under the 1972 Consumer Product Safety Act, PLEASE READ CAREFULLY THE IMPORTANT "LIMITED WARRANTY" CLAUSE.

U.S.A. ONLY

WARNING: High brightness light source. Do not stare into the beam of light, or view directly. Be especially careful that children do not stare directly into the beam of light.

WARNING: To reduce the risk of fire or electric shock, do not expose this product to rain or moisture.

	CAUTION RISK OF ELECTRIC SHOCK. DO NOT REMOVE SCREWS EXCEPT SPECIFIED USER SERVICE SCREW.			The lightning flash with arrowhead symbol, within an equilateral triangle, is intended to alert the user to the presence of uninsulated "dangerous voltage" within the product's enclosure that may be of sufficient magnitude to constitute a risk or electric shock to persons.
CAUTION: TO REDUCE THE RISK OF ELECTRIC SHOCK, DO NOT REMOVE COVER. NO USER-SERVICEABLE PARTS EXCEPT LAMP UNIT. REFER SERVICING TO QUALIFIED SERVICE PERSONNEL.				The exclamation point within a triangle is intended to alert the user to the presence of important operating and maintenance (servicing) instructions in the literature accompanying the product.

WARNING: FCC Regulations state that any unauthorized changes or modifications to this equipment not expressly approved by the manufacturer could void the user's authority to operate this equipment.

U.S.A. ONLY

INFORMATION

This equipment has been tested and found to comply with the limits for a Class A digital device, pursuant to Part 15 of the FCC Rules. These limits are designed to provide reasonable protection against harmful interference when the equipment is operated in a commercial environment. This equipment generates, uses, and can radiate radio frequency energy and, if not installed and used in accordance with the operation manual, may cause harmful interference to radio communications. Operation of this equipment in a residential area is likely to cause harmful interference, in which case the user will be required to correct the interference at his own expense.

U.S.A. ONLY

The enclosed computer cable and Macintosh adaptor must be used with the device. The cable and adaptor are provided to ensure that the device complies with FCC Class A verification.

U.S.A. ONLY

Contents

Important Information

Important Safeguards	3
Usage Guidelines	4
Outstanding Features	5
How to Access the PDF Operation Manuals (for Windows and Macintosh)	6
Supplied Accessories	7
For SHARP Assistance (U.S.A. only)	7
Part Names	8
Remote Control/Mouse Receiver Positioning	10
Operating the Wireless Mouse from the "Power" Remote Control	11

Setup & Connections

Setting Up the Projector and Screen	12
Standard Setup (Front Projection)	12
Reversed Image Setup	12
Ceiling-mount Setup	13
Adjusting the Height of the Image	13
Height of Image	13
Using the Adjustment Foot	14
Digital Keystone Correction	14
Connecting the Projector	15
Connecting the Projector to a Computer	15
"Plug and Play" Function	17
Using the Remote Mouse Receiver and RS-232C Port	17
Connecting the Projector to Video Equipment	17

Operation

Basic Operations	18
Connect the Power Cord	18
Turn on the Main Power	18
Turn on the Lamp Power	18
Adjusting Focus	18
Adjusting Zoom	18
Selecting and Checking the Input Mode	19
Adjusting the Volume	19
Turning off the Power	19
Using the GUI (Graphical User Interface) Menu Screens	20
Using IrCOM for Wireless Presentations	22
Selecting the On-screen Display Language ...	23
Selecting the Video Input System Mode (VIDEO mode only)	23
Picture Adjustments	24
Audio Adjustments	25
Computer Image Adjustments	26
Auto Sync Adjustment	27
Auto Sync Display Function	27
Saving and Selecting Adjustment Settings ...	28
Mode Adjustment	28

Useful Features

Digital Image Magnification and Reduction ...	29
Black Screen Function	30
On-screen Display Override Function	30
Fit to Screen Function	31
I/P Conversion (VIDEO mode only)	31
Checking the Input Signal and Lamp Usage Time	32
Setting a Background Image	32
Selecting a Startup Image	33
Freeze Function	33
Reverse/Invert Image Function	34
Using the Presentation Tools	35
Checking the Adjustment Status	36
Automatic Power Shutoff Function	36

Maintenance & Troubleshooting

Air Filter Maintenance	37
Lamp/Maintenance Indicators	38
Replacing the Projection Lamp	39
Using the Kensington Lock	40
Troubleshooting	40

Appendix

Transporting the Projector	41
Connection Pin Assignments	42
RS-232C Port Specifications	42
Input Signals (Recommended Timing)	44
Specifications	45
Dimensions	46
Guide to Effective Presentations	47
Glossary	51
Index	52





Important Safeguards

Electrical energy can perform many useful functions. This product has been engineered and manufactured to ensure your personal safety. But IMPROPER USE CAN RESULT IN POTENTIAL ELECTRICAL SHOCK OR FIRE HAZARD. In order not to defeat the safeguards incorporated into this LCD Projector, observe the following basic rules for its installation, use and servicing. For your own protection and reliable usage of your LCD Projector, please be sure to read these "Important Safeguards" carefully before use.

1. Read Instructions—All the safety and operating instructions should be read before the product is operated.
2. Retain Instructions—The safety and operating instructions should be retained for future reference.
3. Heed Warnings—All warnings on the product and in the operating instructions should be adhered to.
4. Follow Instructions—All operating and use instructions should be followed.
5. Cleaning—Unplug this product from the wall outlet before cleaning. Do not use liquid cleaners or aerosol cleaners. Use a damp cloth for cleaning.
6. Attachments—Do not use attachments not recommended by the product manufacturer as they may cause hazards.
7. Water and Moisture—Do not use this product near water – for example, near a bathtub, wash bowl, kitchen sink, or laundry tub; in a wet basement; or near a swimming pool; and the like.
8. Accessories—Do not place this product on an unstable cart, stand, tripod, bracket, or table. The product may fall, causing serious injury to a child or adult, and serious damage to the product. Use only with a cart, stand, tripod, bracket, or table recommended by the manufacturer, or sold with the product. Any mounting of the product should follow the manufacturer's instructions, and should use a mounting accessory recommended by the manufacturer.
9. A product and cart combination should be moved with care. Quick stops, excessive force, and uneven surfaces may cause the product and cart combination to overturn.



10. Ventilation—Slots and openings in the cabinet are provided for ventilation to ensure reliable operation of the product and to protect it from overheating. The openings should never be covered or blocked by placing the product on a bed, sofa, rug, or other similar surface. This product should not be placed in a built-in installation such as a bookcase or rack unless proper ventilation is provided or the manufacturer's instructions have been adhered to.
11. Power Sources—This product should be operated only from the type of power source indicated on the marking label. If you are not sure of the type of power supply to your home, consult your product dealer or local power company. For products intended to operate from battery power, or other sources, refer to the operating instructions.
12. Grounding or Polarization—This product is equipped with a three-wire grounding-type plug, a plug having a third (grounding) pin. This plug will only fit into a grounding-type power outlet. This is a safety feature. If you are unable to insert the plug into the outlet, contact your electrician to replace your obsolete outlet. Do not defeat the safety purpose of the grounding-type plug.
13. Power-Cord Protection—Power-supply cords should be routed so that they are not likely to be walked on or pinched by items placed upon or against them, paying particular attention to cords at plugs, convenience receptacles, and the point where they exit from the product.
14. Lightning—For added protection for this product during a lightning storm, or when it is left unattended and unused for long periods of time, unplug it from the wall outlet and disconnect the cable system. This will prevent damage to the product due to lightning and power-line surges.
15. Overloading—Do not overload wall outlets, extension cords, or integral convenience receptacles as this can result in a risk of fire or electric shock.
16. Object and Liquid Entry—Never push objects of any kind into this product through openings as they may touch dangerous voltage points or short-out parts that could result in a fire or electric shock. Never spill liquid of any kind on the product.
17. Servicing—Do not attempt to service this product yourself as opening or removing covers may expose you to dangerous voltage or other hazards. Refer all servicing to qualified service personnel.
18. Damage Requiring Service—Unplug this product from the wall outlet and refer servicing to qualified service personnel under the following conditions:
 - a. If the power-supply cord or plug is damaged.
 - b. If liquid has been spilled, or objects have fallen into the product.
 - c. If the product has been exposed to rain or water.
 - d. If the product does not operate normally by following the operating instructions. Adjust only those controls that are covered by the operating instructions, as an improper adjustment of other controls may result in damage and will often require extensive work by a qualified technician to restore the product to normal operation.
 - e. If the product has been dropped or damaged in any way.
 - f. If the product exhibits a distinct change in performance—this indicates a need for service.
19. Replacement Parts—When replacement parts are required, be sure the service technician has used replacement parts specified by the manufacturer or with the same characteristics as the original part. Unauthorized substitutions may result in fire, electric shock, or other hazards.
20. Safety Check—Upon completion of any service or repairs to this product, ask the service technician to perform safety checks to determine that the product is in proper operating condition.
21. Wall or Ceiling Mounting—This product should be mounted to a wall or ceiling only as recommended by the manufacturer.
22. Heat—This product should be situated away from heat sources such as radiators, heat registers, stoves, or other products (including amplifiers) that produce heat.



Usage Guidelines

CAUTION LASER RADIATION. DO NOT STARE INTO BEAM. WAVE LENGTH : 670nm MAX. OUTPUT : 1mW CLASS II LASER PRODUCT	"COMPLIES WITH 21 CFR SUBCHAPTER J"
	SHARP ELECTRONICS CORPORATION SHARP PLAZA, MAHWAH, NEW JERSEY 07430 TEL : 1-800-BE-SHARP (U.S.A. ONLY)
	REMOTE CONTROL MODEL NO. : G548CEESA SOVY (L5V4APCS) MADE IN JAPAN FABRIQUE AU JAPON

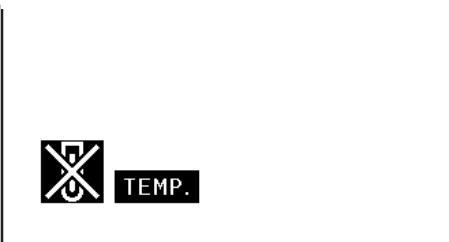
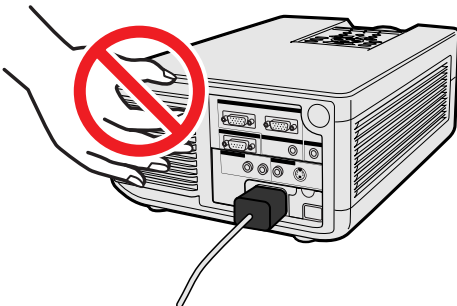
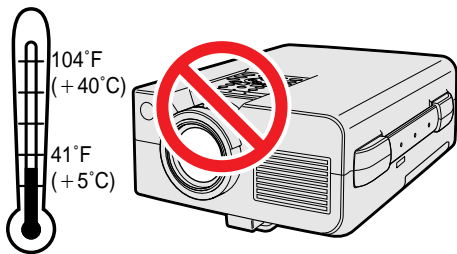
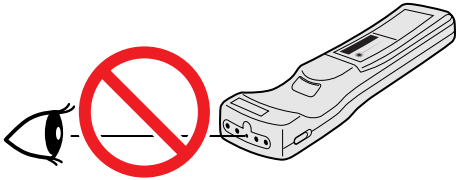
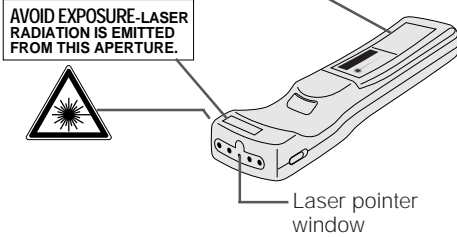

Cautions Concerning the Laser Pointer

The laser pointer on the "Power" remote control emits a laser beam from the laser pointer window. This is a Class II laser which may impair your sight if directed into the eyes. The three marks shown on the left are caution labels for the laser beam.

- Do not look into the laser pointer window or shine the laser beam on yourself or others. (The laser beam used in this product is harmless when directed onto the skin. However, be careful not to project the beam directly into the eyes.)
- Always use the laser pointer at temperatures between 41°F and 104°F (+5°C and +40°C).
- Use of controls or adjustments, or performance of procedures other than those specified herein may result in hazardous radiation exposure.

Cautions Concerning the Setup of the Projector

For minimal servicing and to maintain high image quality, SHARP recommends that this projector be installed in an area free from humidity, dust and cigarette smoke. When the projector is subjected to these environments, the lens and filter must be cleaned more often. Periodically the filter should be replaced and the projector should be cleaned internally. As long as the projector is properly maintained in this manner, use in these environments will not reduce the overall operation life. Please note that all internal cleaning must be performed by an Authorized Sharp Industrial LCD Products Dealer or Service Center.

Notes on Operation

- The exhaust vent, the lamp cage cover and adjacent areas may be extremely hot during projector operation. To prevent injury, do not touch these areas until they have sufficiently cooled.
- Allow at least 4 inches (10 cm) of space between the cooling fan (exhaust vent) and the nearest wall or obstruction.
- If the cooling fan becomes obstructed, a protection device will automatically turn off the projector lamp. This does not indicate a malfunction. Remove the projector power cord from the wall outlet and wait at least 10 minutes. Then turn on the power by plugging the power cord back in. This will return the projector to the normal operating condition.

Temperature Monitor Function

If the projector starts to overheat due to setup problems or a dirty air filter, "TEMP." and "⊠" will flash in the lower-left corner of the picture. If the temperature continues to rise, the lamp will turn off, the TEMPERATURE WARNING indicator on the projector will flash, and after a 90-second cooling-off period the power will shut off. Refer to "Lamp/Maintenance Indicators" on page 38, for details.

NOTE

- The cooling fan regulates the internal temperature, and its performance is automatically controlled. The sound of the fan may change during projector operation due to changes in the fan speed.

Lamp Monitor Function

When the projector is turned on after the lamp has been used for 1,900 hours, "LAMP" and "⊠" will flash in the lower-left corner of the picture to advise you to replace the lamp. See pages 39 and 40 for lamp replacement. If the lamp has been used for 2,000 hours, the projector power will automatically turn off and the projector will enter standby mode. Refer to "Lamp/Maintenance Indicators" on page 38, for details.





Outstanding Features



1. WIRELESS PRESENTATIONS WITH IrCOM

The IrCOM function allows for wireless transmission of digital images via infrared communication, from a PC, handheld PC or digital camera to the projector.

2. ADVANCED COMPATIBILITY WITH HIGH-END WORKSTATIONS AND PCS

Compatible with up to 100 Hz vertical refresh rate, Sync on Green and Composite Sync signals for use with a wide variety of high-end PCs and Workstations.

3. XGA RESOLUTION FOR HIGH RESOLUTION PRESENTATIONS

With XGA (1,024 × 768) resolution, this projector can display very detailed presentation information.

4. INTELLIGENT COMPRESSION AND EXPANSION

By using intelligent resizing technology, this projector can display higher and lower resolution images in detail without compromising quality.

5. UXGA COMPATIBLE

The projector can display compressed UXGA (1,600 × 1,200) images.

6. DIGITAL KEYSTONE CORRECTION

Digitally adjusts an image that is projected at an angle while maintaining image quality and brightness.

7. EASY-TO-USE GRAPHIC USER INTERFACE

A multi-color, icon based menu system allows for simple image adjustments.

8. AUTO SYNC TECHNOLOGY FOR AUTOMATIC IMAGE PERFECTION

Automatically makes any necessary adjustments for perfectly synced computer images.

9. BUILT-IN PRESENTATION TOOLS

A variety of helpful presentation utilities are incorporated to enhance presentations. These include "Stamp" functions, "Break Timer", and "Digital Enlarge".

10. USER-FRIENDLY DESIGN

The two-color design along with an intuitive User Interface makes this projector very easy to set up and adjust.

11. CUSTOMIZABLE STARTUP SCREEN

Allows you to load a custom startup image (i.e. your company logo) to be displayed while the projector is warming up.



How to Access the PDF Operation Manuals (for Windows and Macintosh)



PDF operation manuals in all languages are included in the CD-ROM. To utilize these manuals, you need to install Adobe Acrobat Reader on your PC (Windows or Macintosh). If you have not installed Acrobat Reader yet, you can download it from the Internet (<http://www.adobe.com>) or install it from the CD-ROM.

To Install Acrobat Reader (English version) from the CD-ROM

For Windows:

- ① Insert the CD-ROM in the CD-ROM drive.
- ② Double click on the "My Computer" icon.
- ③ Double click on the "CD-ROM" drive.
- ④ Double click on the "manuals" folder.
- ⑤ Double click on the "acrobat" folder.
- ⑥ Double click on the "windows" folder.
- ⑦ Double click on the installation program and follow the instructions on the screen.

For Macintosh:

- ① Insert the CD-ROM in the CD-ROM drive.
- ② Double click on the "CD-ROM" icon.
- ③ Double click on the "manuals" folder.
- ④ Double click on the "acrobat" folder.
- ⑤ Double click on the "mac" folder.
- ⑥ Double click on the installation program and follow the instructions on the screen.

For other operating systems:

Please download Acrobat Reader from the Internet (<http://www.adobe.com>).

For other languages:

If you prefer using Acrobat Reader for other languages, please download the appropriate version from the Internet. (Please note that you do not have to have Acrobat Reader in your own language. You can read any pdf file using the English version of Acrobat Reader.)

Accessing the PDF Manuals

For Windows:

- ① Insert the CD-ROM in the CD-ROM drive.
- ② Double click on the "My Computer" icon.
- ③ Double click on the "CD-ROM" drive.
- ④ Double click on the "manuals" folder.
- ⑤ Double click on the "nv5" folder to access the projector manuals.
Double click on the "saps" folder to access the Sharp Advanced Presentation Software manual.
- ⑥ Double click on the language (name of the folder) that you want to view.
- ⑦ Double click on the pdf file.

For Macintosh:

- ① Insert the CD-ROM in the CD-ROM drive.
- ② Double click on the "CD-ROM" icon.
- ③ Double click on the "manuals" folder.
- ④ Double click on the "acrobat" folder.
- ⑤ Double click on the "nv5" folder to access the projector manuals.
Double click on the "saps" folder to access the Sharp Advanced Presentation Software manual.
- ⑥ Double click on the language (name of the folder) that you want to view.
- ⑦ Double click on the pdf file.

NOTE







- If the desired pdf file cannot be opened by double clicking the mouse, please start Acrobat Reader first, then specify the desired file using the "File", "Open" menu.

CD-ROM Structure

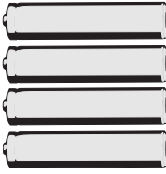
Root	First folder	Second folder/programs	Third folder	PDF files
CD-ROM	manuals	nv5	american	nv5us.pdf
			french	nv5f.pdf
			spanish	nv5sp.pdf
		saps	american	saps1us.pdf
			french	saps1f.pdf
			spanish	saps1sp.pdf
		acrobat	windows	Acrobat Reader (English) installation program
			mac	Acrobat Reader (English) installation program
		saps	saps programs	
	nv5demo			

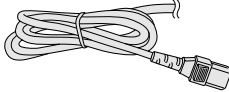
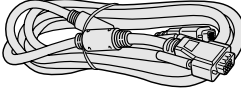
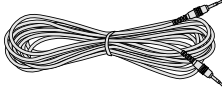
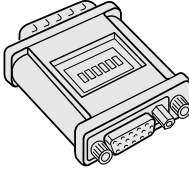
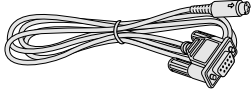
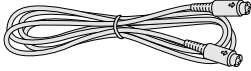
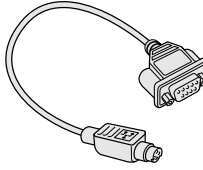
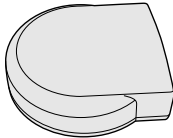
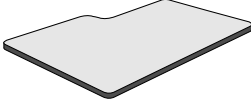
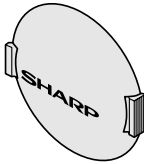

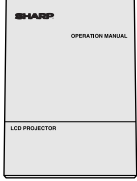
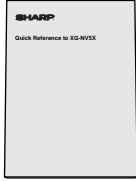
Supplied Accessories

 <p>"Power" remote control RRMCG1470CESA</p>	 <p>Four AA size batteries UBATU0025GEZZ</p>	 <p>Simple presentation remote control RRMCG1480CESA</p>	 <p>Two AAA size batteries UBATU0026GEZZ</p>
 <p>Power cord CACCU5013CE01</p>	 <p>Computer cable OCNW-5108CEZZ</p>	 <p>Computer audio cable OCNW-4870CEZZ</p>	 <p>Macintosh adaptor OPLGJ1512CEZZ</p>
 <p>Mouse control serial cable OCNW-5112CEZZ</p>	 <p>Mouse control cable for IBM PS/2 OCNW-5113CEZZ</p>	 <p>Mouse control cable for Mac OCNW-5114CEZZ</p>	 <p>Remote mouse receiver RUNTK0648CEZZ</p>
 <p>Extra air filter PFILD0076CEZZ</p>	 <p>Lens cap GCOVH1307CESA</p>	 <p>Carrying bag GCASN0001CESA</p>	 <p>CD-ROM UDSKA0001CE01</p>
 <p>LCD projector operation manual TINS-6583CEZZ</p>	 <p>LCD projector quick reference TINS-6598CEZZ</p>	 <p>Sharp Advanced Presentation Software operation manual TINS-6601CEZZ</p>	 <p>Sharp Advanced Presentation Software quick reference TINS-6676CEZZ</p>



For SHARP Assistance (U.S.A. only)

If you encounter any problems during setup or operation of this projector, first refer to the "Troubleshooting" section on page 40. If this operation manual does not answer your question, please call toll free 1-800-BE-SHARP (1-800-237-4277) for further assistance. Or, send us an e-mail at lcdsupport@sharplcd.com. Our World Wide Web address is <http://www.sharp-usa.com/>.



Part Names



Projector

Front View

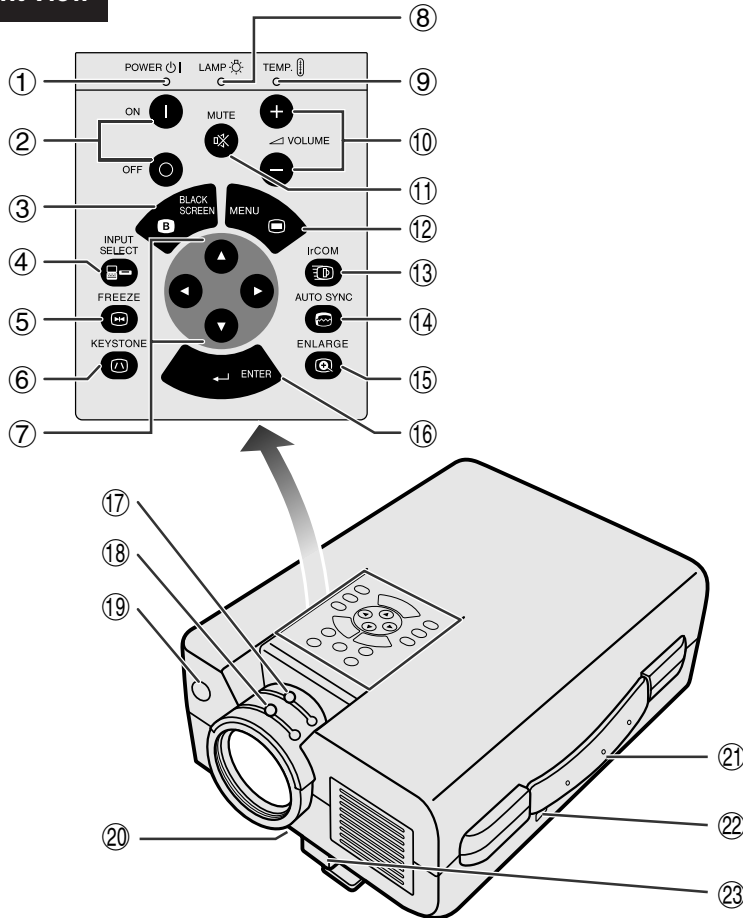

Side and Rear View

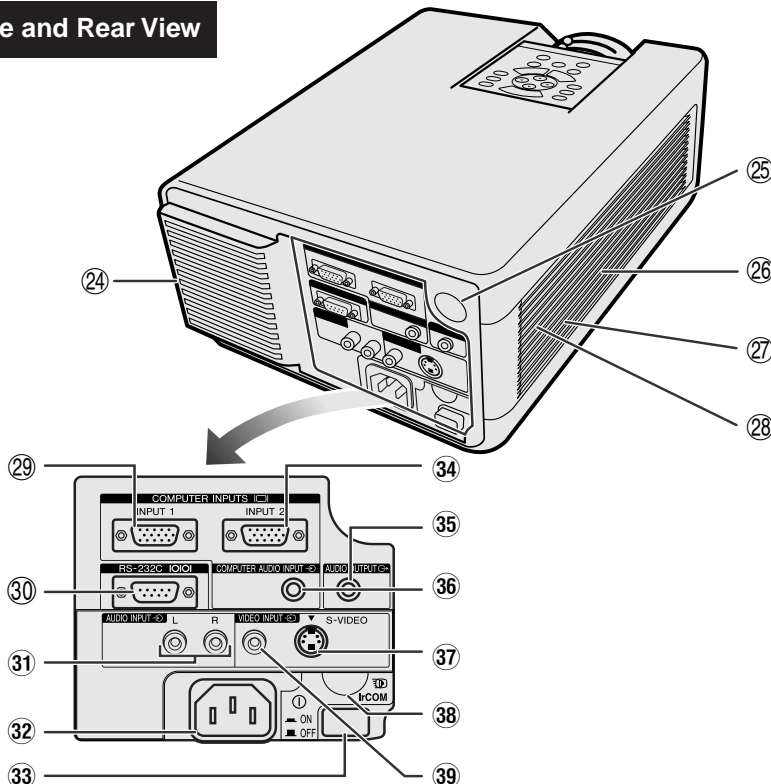

- ① POWER indicator [pp. 18, 19, 38]
- ② POWER buttons (ON/OFF) [pp. 18, 19, 39]
- ③ BLACK SCREEN button [p. 30]
- ④ INPUT SELECT button [pp. 19, 26]
- ⑤ FREEZE button [p. 33]
- ⑥ KEYSTONE button [p. 14]
- ⑦ ADJUSTMENT buttons (▲/▼/◀/▶) [pp. 14, 20–36, 40]
- ⑧ LAMP REPLACEMENT indicator [pp. 18, 19, 38]
- ⑨ TEMPERATURE WARNING indicator [pp. 4, 38]
- ⑩ VOLUME buttons (+/-) [p. 19]
- ⑪ MUTE button [p. 19]
- ⑫ MENU button [pp. 20–36]
- ⑬ IrCOM button [p. 22]
- ⑭ AUTO SYNC button [pp. 26, 27]
- ⑮ ENLARGE button [p. 29]
- ⑯ ENTER button [pp. 14, 20–36, 40]
- ⑰ Zoom knob [p. 18]
- ⑱ Focus knob [p. 18]
- ⑲ Remote control sensor [p. 10]
- ⑳ Air filter [p. 37]/Cooling fan (Intake vent)
- ㉑ Carrying handle [p. 41]
- ㉒ Kensington Security Standard connector [p. 40]
- ㉓ Foot release [p. 14]
- ㉔ Cooling fan (Exhaust vent)
- ㉕ Remote control sensor [p. 10]
- ㉖ Speaker
- ㉗ Cooling fan (Intake vent)
- ㉘ Air filter [p. 37]
- ㉙ COMPUTER INPUT 1 port (HD-15) [pp. 15, 16, 42]
- ㉚ RS-232C port (9-pin D-sub) [pp. 15, 17, 42, 43]
- ㉛ AUDIO INPUT terminals: RCA [p. 17]
- ㉜ AC socket
- ㉝ MAIN POWER switch [pp. 11, 18, 37, 39, 40]
- ㉞ COMPUTER INPUT 2 port (HD-15) [pp. 15, 16, 42]
- ㉟ AUDIO OUTPUT terminal (3.5 mm stereo minijack) [p. 17]
- ㊱ COMPUTER AUDIO INPUT terminal (3.5 mm stereo minijack) [p. 15]
- ㊲ S-VIDEO INPUT terminal: 4-pin mini DIN [p. 17]
- ㊳ IrCOM sensor [p. 22]
- ㊴ VIDEO INPUT terminal: RCA [p.17]



“Power” Remote Control

Front View

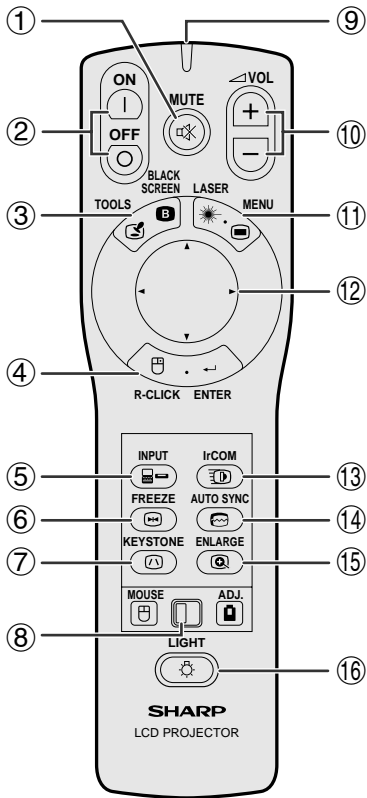

Side View

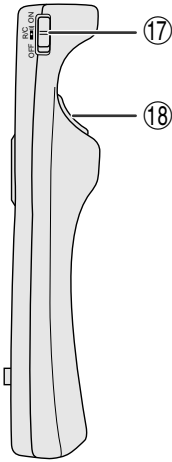

Top View

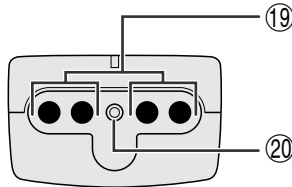

- ① MUTE button [p. 19]
- ② POWER buttons (ON/OFF) [pp. 18, 19, 39]
- ③ BLACK SCREEN/TOOLS button [pp. 30, 35]
- ④ RIGHT-CLICK/ENTER button [pp. 11, 14, 20–36]
- ⑤ INPUT button [pp. 19, 26]
- ⑥ FREEZE button [p. 33]
- ⑦ KEYSTONE button [p. 14]
- ⑧ MOUSE/ADJUSTMENT switch [pp. 11, 14, 20–36, 40]
- ⑨ TRANSMISSION indicator
- ⑩ VOLUME buttons (+/-) [p. 19]
- ⑪ LASER POINTER/MENU button [pp. 11, 20–36]
- ⑫ MOUSE/ADJUSTMENT buttons (▲/▼/◀/▶) [pp. 14, 20–36]
- ⑬ IrCOM button [p. 22]
- ⑭ AUTO SYNC button [pp. 26, 27]
- ⑮ ENLARGE button [p. 29]
- ⑯ BACKLIGHT button [p. 11]
- ⑰ MAIN POWER switch [p. 11]
- ⑱ LEFT-CLICK (BACK) button [pp. 11, 20–36]
- ⑲ Remote control signal transmitter
- ⑳ Laser pointer window [p. 4]
- ㉑ TRANSMISSION indicator
- ㉒ MOUSE button [p. 11]
- ㉓ RIGHT-CLICK button [p. 11]
- ㉔ LEFT-CLICK button [p. 11]

Simple Presentation Remote Control

Front View

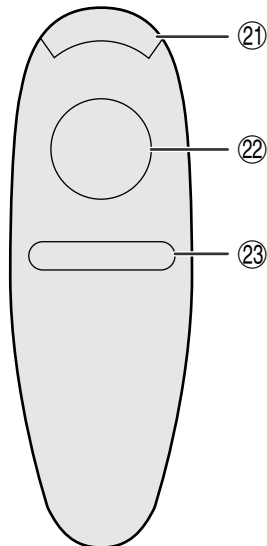

Side View

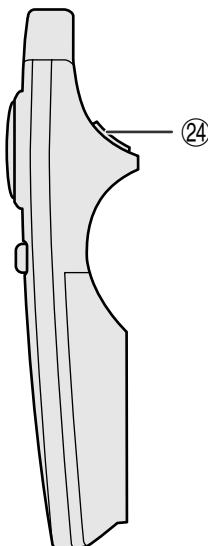

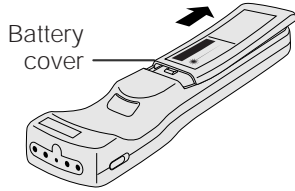
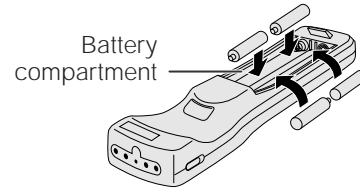
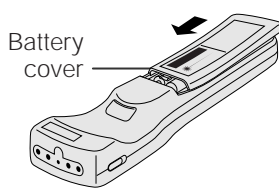
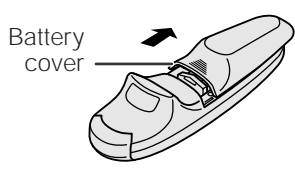
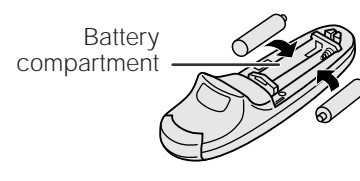
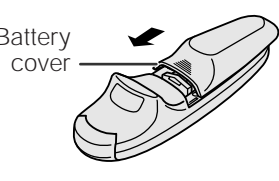

Inserting the batteries

<p>1 Press in and downward on the arrow to remove the battery cover.</p>	<p>2 Insert four AA size batteries for the "Power" remote control and two AAA size batteries for the simple presentation remote control making sure their polarities match the + and - marks inside the battery compartment.</p>	<p>3 Insert the side tabs of the battery cover into their slots and press the cover in until it is properly seated.</p>
		
		



Remote Control/Mouse Receiver Positioning

- The "Power" remote control can be used to control the projector within the ranges shown below.
- The remote mouse receiver can be used with the "Power" remote control or the simple presentation remote control to control the mouse functions of a connected computer within the ranges shown below. (See page 15 for details.)

NOTE

- The signal from the remote controls can be reflected off a screen for easy operation. However, the effective distance of the signal may differ due to the screen material.

Controlling the Projector

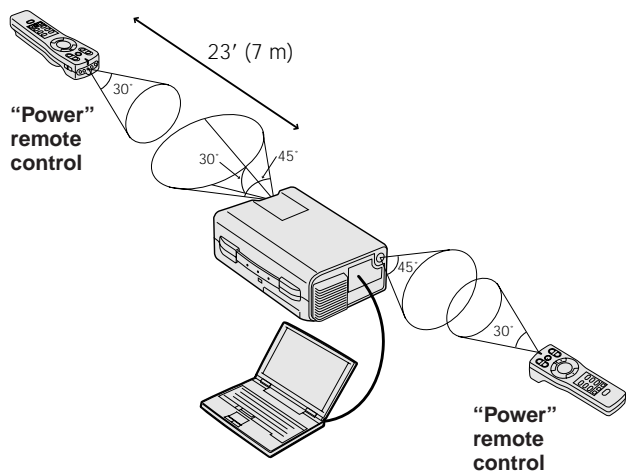

Using the Wireless Mouse

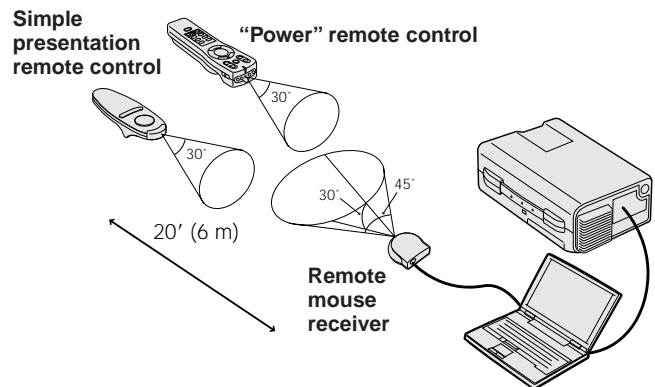



Operating the Wireless Mouse from the "Power" Remote Control

When operating the projector controls or using the laser pointer

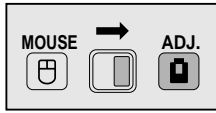

When operating the wireless mouse

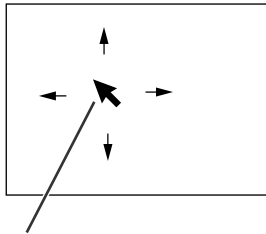
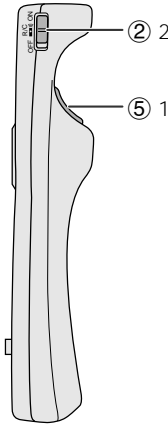
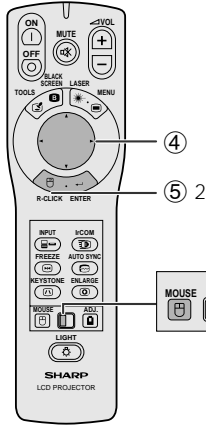
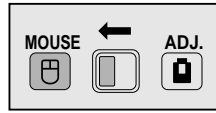

Mouse cursor

Button name	Position of MOUSE/ADJUSTMENT switch	
	MOUSE (M)	ADJ. (A)
LASER POINTER/MENU	LASER POINTER (GREEN)	MENU (RED)
BLACK SCREEN/TOOLS	BLACK SCREEN (GREEN)	TOOLS (RED)
RIGHT-CLICK/ENTER	RIGHT-CLICK (GREEN)	ENTER (RED)
MOUSE/ADJUSTMENT	MOUSE (NOT LIT)	ADJUSTMENT (NOT LIT)
LEFT-CLICK/BACK	LEFT-CLICK (NOT LIT)	BACK (NOT LIT)
POWER ON/OFF	ON (RED)	
VOLUME + / -		
MUTE		
INPUT		
IrCOM		
FREEZE		
AUTO SYNCHRONIZATION		
KEystone		
ENLARGE		

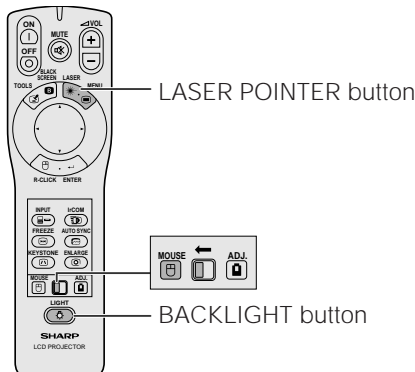

The "Power" remote control has the following three functions:

- Operation of projector controls
- Operation of wireless mouse
- Use of laser pointer

Slide the **MOUSE/ADJUSTMENT** switch to the **MOUSE** or **ADJ.** position for use of the function.

① **Connect the projector to a computer**

See pages 15 and 16 for details.

② **Wireless mouse operation**

1. After connecting the projector and the computer, turn the projector on first. The computer should always be turned on last.
2. Slide the **MAIN POWER** switch on the "Power" remote control to ON.

③ **Selecting the operation mode**

To use the "Power" remote control as a wireless mouse, slide the **MOUSE/ADJUSTMENT** switch to the **MOUSE** position.

NOTE

- To use the "Power" remote control to operate the projector, slide the **MOUSE/ADJUSTMENT** switch to the **ADJ.** position.
- The wireless mouse or RS-232C function may not operate if your computer serial port is not correctly set up. Please refer to the computer's operation manual for details on setting up/installing the correct mouse driver.

④ **Moving the mouse cursor**

Press **▲/▼/◀/▶** on the "Power" remote control to move the mouse cursor around the screen.

NOTE

- The supplied simple presentation remote control can also be used for wireless mouse operation.

⑤ **Using the mouse buttons for two-button mouse systems**

The wireless mouse is configured to be used as a standard two-button mouse (desktop mouse).

1. Use **LEFT-CLICK** on the back of the "Power" remote control as the "Left Click" of a standard desktop mouse.
2. Use **RIGHT-CLICK** on the front of the "Power" remote control as the "Right Click" of a standard desktop mouse.

NOTE

- For one-button mouse systems, use either the **LEFT-CLICK** or **RIGHT-CLICK** button.

Using the laser pointer

Slide the **MOUSE/ADJUSTMENT** switch to the **MOUSE** position, and then press **LASER POINTER** (L) to activate the laser pointer. When the button is released, the light automatically goes off.

NOTE

- For safety reasons, the laser pointer automatically goes off after 1 minute of continuous use. To turn it on again, press **LASER POINTER** (L) one more time.

Using the "Power" remote control in a dark room

The "Power" remote control has a backlight function. When **BACKLIGHT** is pressed, the remote buttons light up. Green light refers to mouse operations, and red light to projector adjustments.

NOTE

- If the **MAIN POWER** switch on the "Power" remote control is left on for more than 10 minutes without operation, the power will automatically turn off. To turn the power back on, press any button on the remote control for more than one second.



Setting Up the Projector and Screen

Position the projector perpendicular to the screen with all feet flat and level to achieve optimal image. Move the projector forward or backward if the edges of the image are distorted.

NOTE

- The projector lens should be centered in the middle of the screen. If the lens center is not perpendicular to the screen, the image will be distorted, making viewing difficult.
- Position the screen so that it is not in direct sunlight or room light. Light falling directly onto the screen washes out colors, making viewing difficult. Close the curtains and dim the lights when setting up the screen in a sunny or bright room.
- A polarizing screen cannot be used with this projector.

Standard Setup (Front Projection)

Place the projector at the required distance from the screen according to the desired picture size (see the table below).

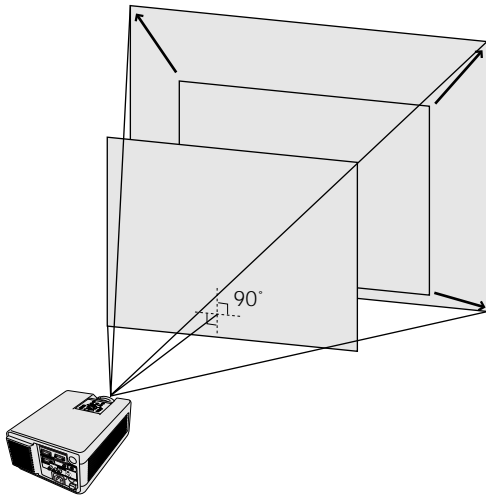

Picture size (diag.)	Projection distance	
	Maximum	Minimum
300" (240" W × 180" H)	59' 2" (18.1 m)	39' 8" (12.1 m)
200" (160" W × 120" H)	39' 4" (12.0 m)	26' 5" (8.1 m)
150" (120" W × 90" H)	29' 5" (9.0 m)	19' 8" (6.0 m)
100" (80" W × 60" H)	19' 6" (6.0 m)	13' 1" (4.0 m)
80" (64" W × 48" H)	15' 6" (4.8 m)	10' 4" (3.2 m)
60" (48" W × 36" H)	11' 7" (3.6 m)	7' 8" (2.4 m)
40" (32" W × 24" H)	7' 7" (2.4 m)	5' 1" (1.6 m)

The formula for picture size and projection distance

$$y_1 = (0.1982x - 0.219) \times 3.28$$

$$y_2 = (0.1333x - 0.21) \times 3.28$$

x: Picture size (diag.) (inches)

y_1 : Maximum projection distance (feet)

y_2 : Minimum projection distance (feet)

NOTE

- There is an error of ± 4 inches (± 10 cm) in the formula above.

Reversed Image Setup

Rear projection

- Place a translucent screen between the projector and the audience.
- Use the projector's menu system to reverse the projected image. (See page 34 for use of this function.)

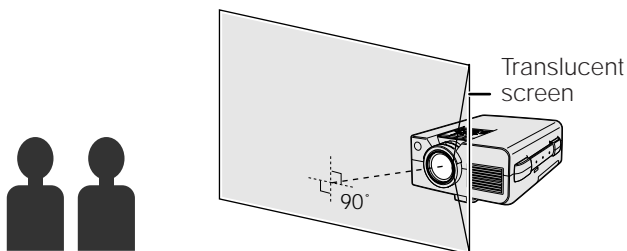

Projection using a mirror

- Place a mirror (normal flat type) in front of the lens.
- Use the projector's menu system to reverse the projected image. (See page 34 for use of this function.)
- The image reflected from the mirror is projected onto the screen.

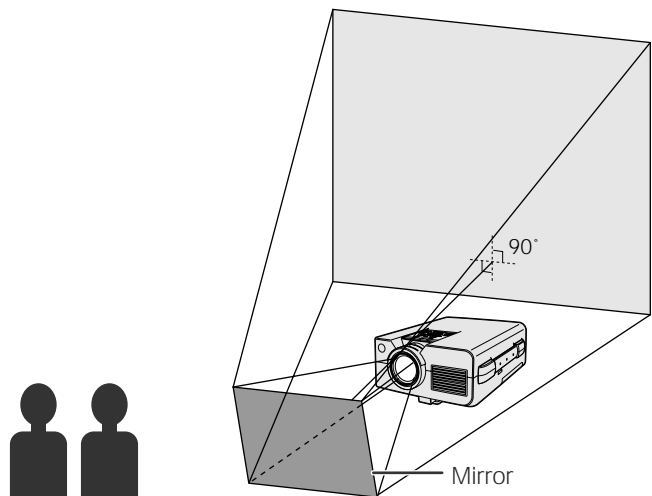

CAUTION

- When using a mirror, be sure to carefully position both the projector and the mirror so the light does not shine into the eyes of the audience.





Setting Up the Projector and Screen



Ceiling-mount Setup

- Use the optional Sharp ceiling-mount bracket for this installation.
- Before mounting the projector, contact your nearest Authorized Sharp Industrial LCD Products dealer or Service Center to obtain the recommended ceiling-mount bracket (sold separately). (AN-XGCM50 ceiling-mount bracket, AN-EP101AP extension tube for AN-XGCM50.)
- When the projector is in the inverted position, use the upper edge of the screen as the base line.
- Use the projector's menu system to select the appropriate projection mode. (See page 34 for use of this function.)

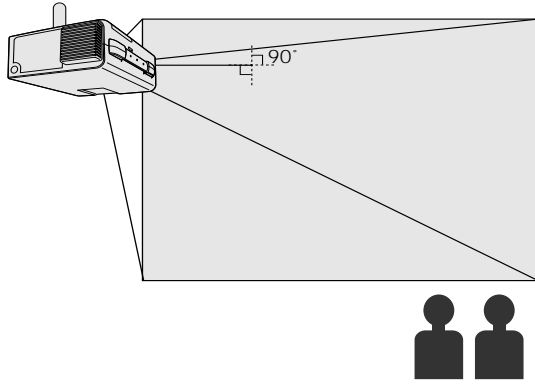

Adjusting the Height of the Image

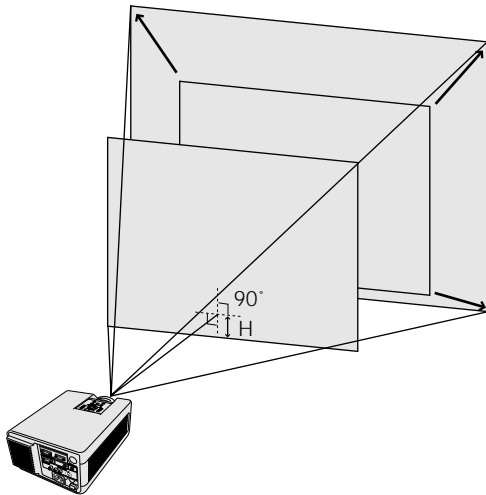

Height of Image

See the table below for exact distances from the lens center to the bottom of the image.

Picture size (diag.)	Distance from the lens center to the bottom of the image (H)
300" (240" W × 180" H)	18" (45.8 cm)
200" (160" W × 120" H)	12" (30.5 cm)
150" (120" W × 90" H)	9" (22.9 cm)
100" (80" W × 60" H)	6" (15.3 cm)
80" (64" W × 48" H)	4 ⁵¹ / ₆₄ " (12.2 cm)
60" (48" W × 36" H)	3 ¹⁹ / ₃₂ " (9.2 cm)
40" (32" W × 24" H)	2 ²⁵ / ₆₄ " (6.1 cm)



Adjusting the Height of the Image



Using the Adjustment Foot

You can adjust the height of the image by raising the projector with the foot release.

- 1 Press the foot release and lift the projector to the desired angle.
- 2 Remove your hand from the foot release. Once the adjustment foot has locked in position, release the projector.

Returning the projector to its original position

While holding the projector, press the foot release and slowly lower the projector to its original position.

NOTE

- The projector is adjustable up to approximately 5° from the standard position.
- When an adjustment is made, the image may become distorted (keystoned), depending on the relative positions of the projector and the screen.

CAUTION

- Do not press the foot release when the adjustment foot is extended without firmly holding the projector.
- Do not hold the lens when lifting or lowering the projector.
- When lowering the projector, be careful not to get your fingers caught in the area between the adjustment foot and the projector.

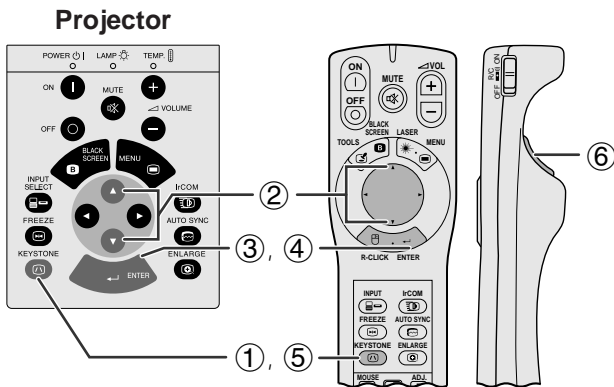

Digital Keystone Correction



When the image is distorted due to the projection angle, the Digital Keystone Correction function allows you to correct it.

(For use with the "Power" remote control, slide the **MOUSE/ADJUSTMENT** switch to the **ADJ.** position.)

- 1 Press **KEYSTONE**.
- 2 Press **▲** to compress the upper part of the image. Press **▼** to compress the lower part of the image.
- 3 Press **ENTER** to display a test pattern.
- 4 Press **ENTER** to clear the test pattern.
- 5 To exit, press **KEYSTONE**.
- 6 To reset, press **LEFT-CLICK**.

Pressing **▲** in Step 2

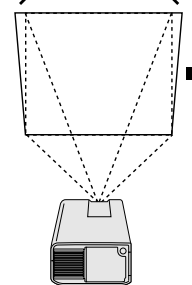

Pressing **▼** in Step 2

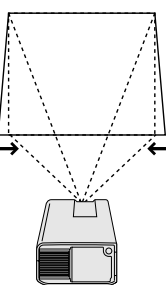

NOTE

- Straight lines or the edges of the displayed image may become jagged.

3 Test Pattern

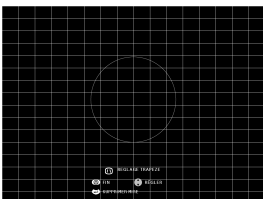

4

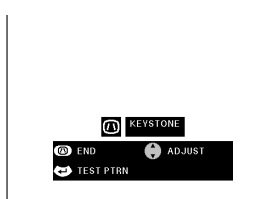



Connecting the Projector

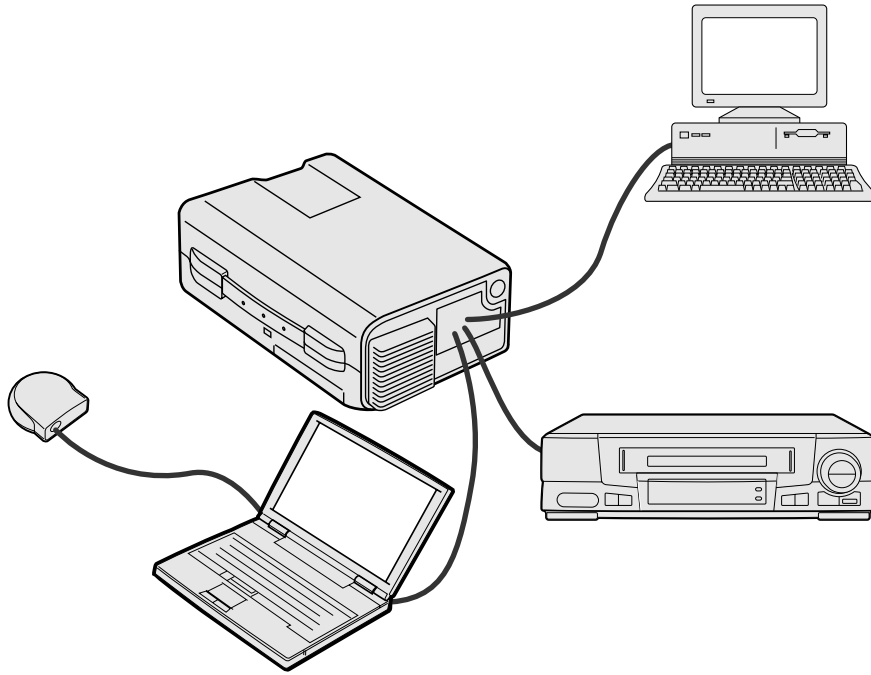

Connecting the Projector to a Computer

You can connect your projector to a computer for projection of full color computer images. See the next page for details on the connections.

CAUTION

- Before connecting, be sure to turn both the projector and the computer off. After making all connections, turn the projector on first. The computer should always be turned on last.

NOTE

- Please read the computer's operation manual carefully.
- Refer to page 44 "Input Signals (Recommended Timing)" for a list of computer signals compatible with the projector. Use with computer signals other than those listed may cause some of the functions not to work.

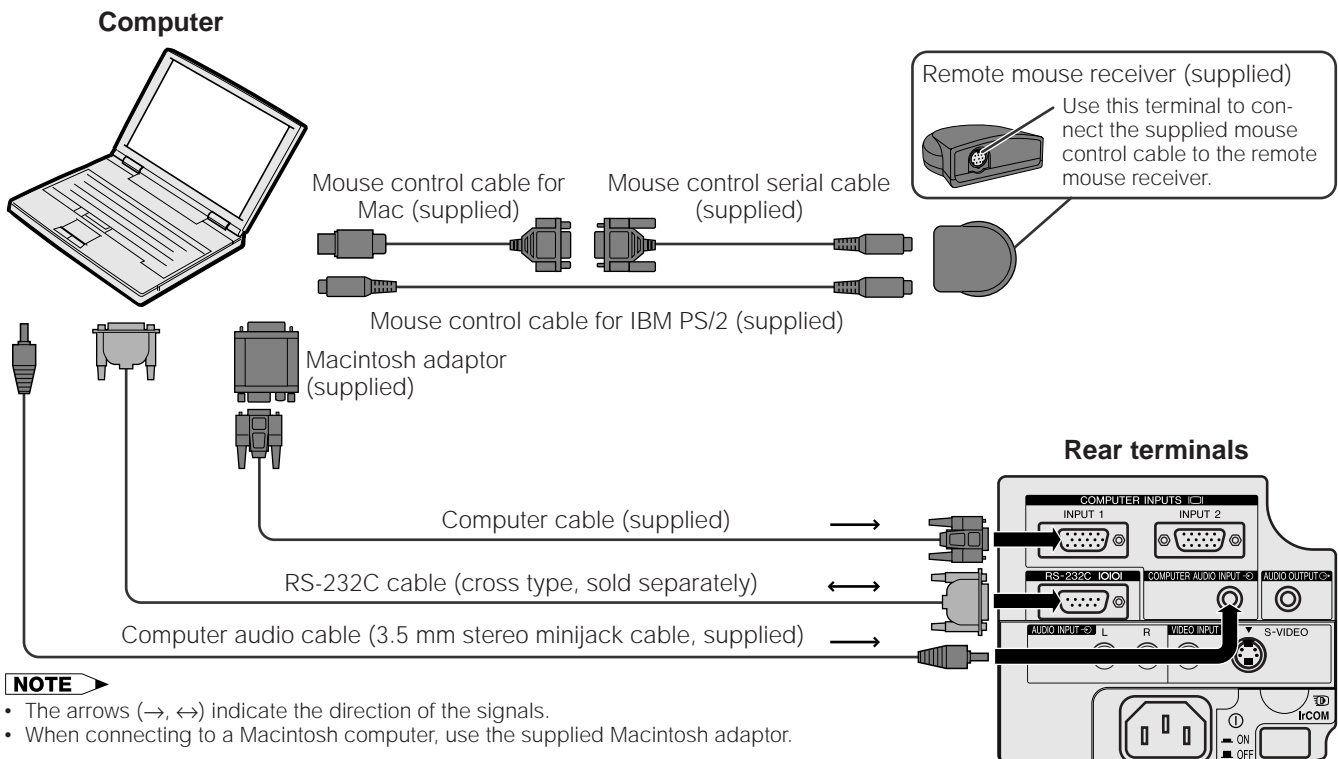



Connecting the Projector

Connect your projector to a computer for projection of full-color computer images.

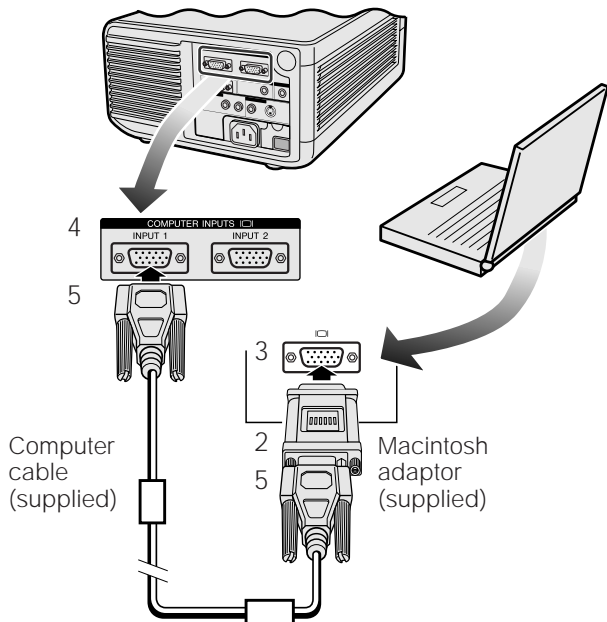
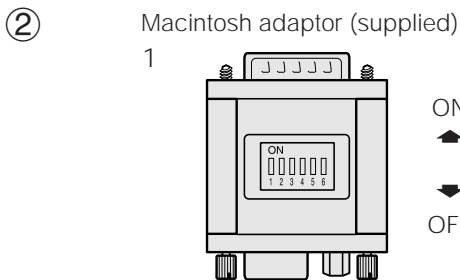
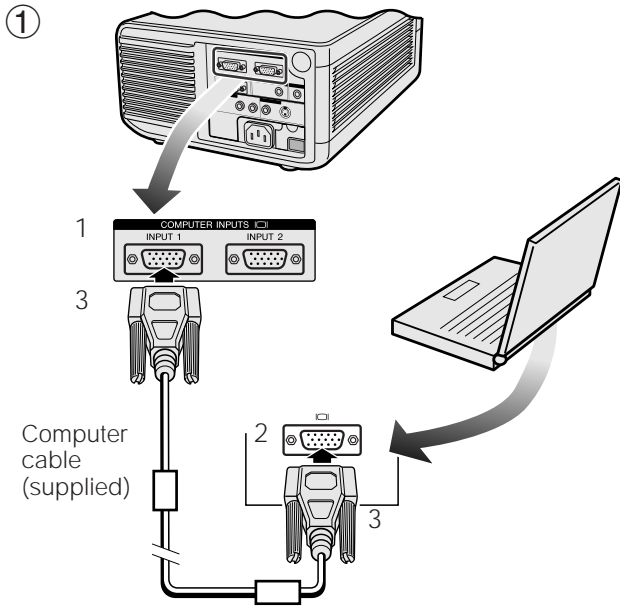

① Connecting an IBM-PC

1. Plug one end of the supplied computer cable into the COMPUTER INPUT port on the projector.
2. Plug the other end into the Monitor output port on the computer.
3. Secure the plugs by tightening the thumb screws.

② Connecting a Macintosh computer

1. Set the proper switches on the supplied Macintosh adaptor to the desired resolution. Some examples are as follows:
 - For 640 × 480 resolution, set switches 1 and 2 to "ON" and 3, 4, 5 and 6 to "OFF".
 - For 832 × 624 resolution, set switches 2 and 4 to "ON" and 1, 3, 5 and 6 to "OFF".
 - For 1,024 × 768 resolution, set switches 2 and 3 to "ON" and 1, 4, 5 and 6 to "OFF".
2. Connect the supplied Macintosh adaptor to the supplied computer cable.
3. Connect the other end of the Macintosh adaptor to the Monitor output port on your Macintosh computer.
4. Plug the other end of the supplied computer cable into the COMPUTER INPUT port on the projector.
5. Secure the plugs by tightening the thumb screws.

NOTE

- Once the adaptor is connected to a computer and the computer is turned on, the display mode cannot be changed even if the switches on the adaptor are reset.
- The supplied Macintosh adaptor is only for use with H-SYNC and V-SYNC output. When connecting a Macintosh computer that only outputs C-SYNC, use a C-SYNC output adaptor (sold separately).

③ Connecting other compatible computers

When connecting the projector to a compatible computer other than an IBM-PC (VGA/SVGA/XGA/SXGA/UXGA) or Macintosh (i.e. Workstation), a separate cable may be needed. Please contact your dealer for more information.

NOTE

- Connecting computers other than the recommended types may result in damage to the projector, the computer, or both.

④ Turning on the power of the projector and the computer

Once the connections are made, first turn on the projector (see page 18), then your computer.





“Plug and Play” Function

This projector is compatible with VESA-standard DDC 1/DDC 2B. The projector and a VESA DDC compatible computer will communicate their setting requirements, allowing for quick and easy setup.

NOTE

- The DDC, Plug and Play function of this projector operates only when used in conjunction with a VESA DDC compatible computer.

Using the Remote Mouse Receiver and RS-232C Port

- The remote mouse receiver can be used with the “Power” remote control or the simple presentation remote control to operate the computer’s mouse. Plug the supplied mouse control cable from the remote mouse receiver to the computer. (See page 16.)
- When the RS-232C port on the projector is connected to a computer with an RS-232C cable (cross type, sold separately), the computer can be used to control the projector and check the status of the projector. See pages 42 and 43 for details.

CAUTION

- Do not connect or remove the mouse control cables or RS-232C cable to or from the computer while it is on. This may damage your computer.

NOTE

- The wireless mouse functions can operate computers compatible with IBM PS/2, serial (RS-232C) or Apple ADB type mouse systems.
- The wireless mouse or RS-232C function may not operate if your computer port is not correctly set up. Please refer to the operation manual of the computer for details on setting up/installing the correct mouse driver.

Connecting the Projector to Video Equipment

You can connect your projector to a VCR, laser disk player or external audio components.

CAUTION

- Always turn off the projector while connecting to video equipment, in order to protect both the projector and the equipment being connected.

NOTE

- By using external audio components, the volume can be amplified for better sound.

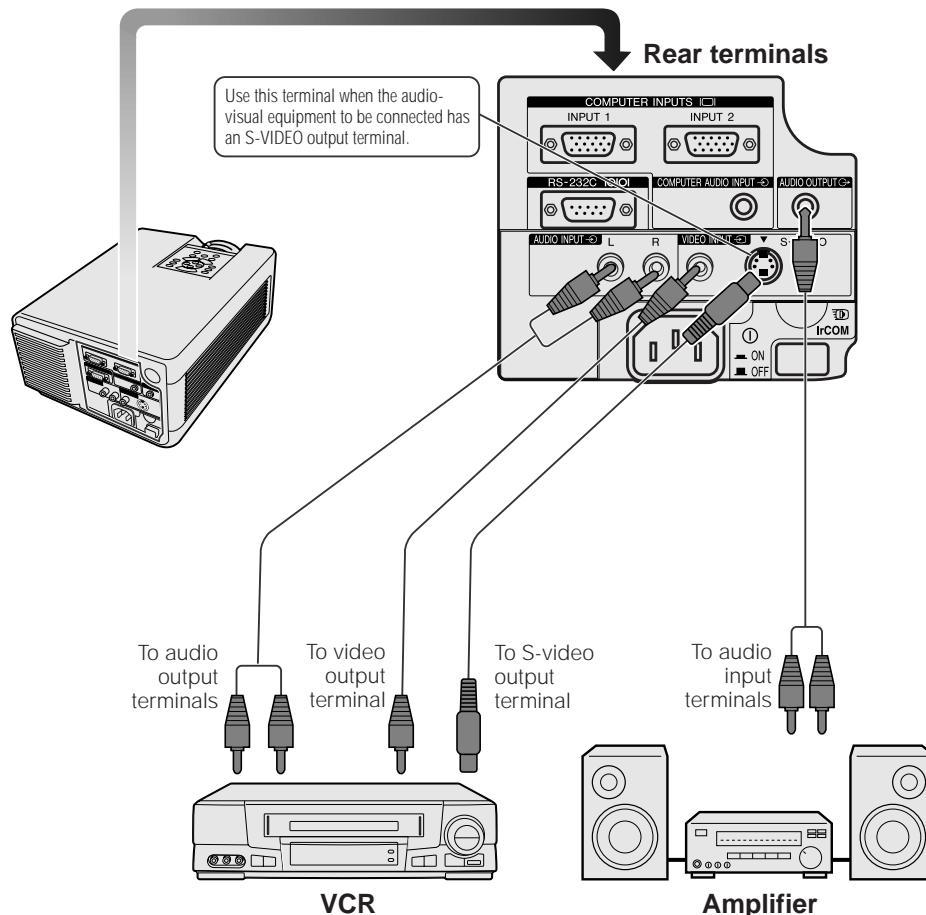



Basic Operations

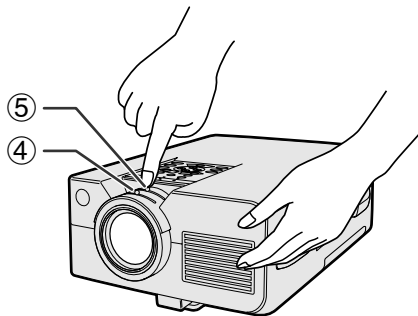
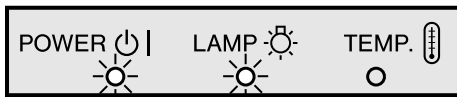
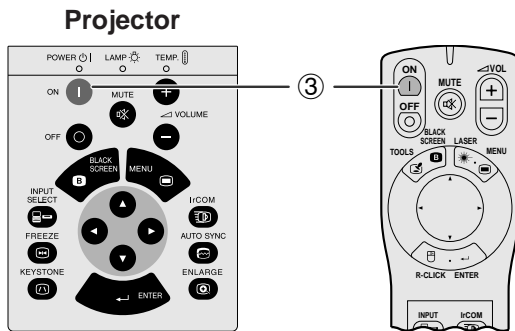
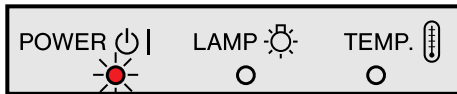
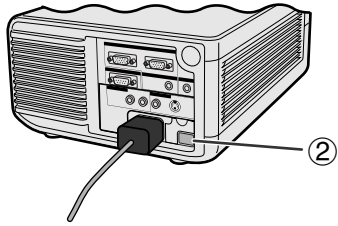
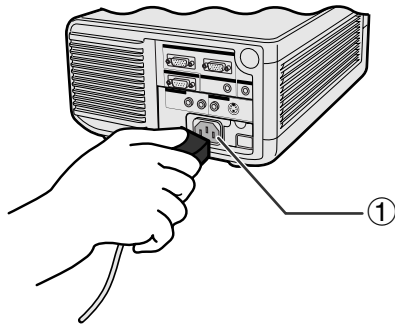

① Connect the Power Cord

Plug the supplied power cord into the AC socket on the back of the projector.

② Turn on the Main Power

Press the **MAIN POWER** switch on the back of the projector. The **POWER** indicator lights up red and the projector enters standby mode.

NOTE

- If the bottom filter cover is not securely installed, the **POWER** indicator flashes.
- When the main power is not on, the "Power" remote control cannot be used.

When the main power is on, the **POWER** indicator lights up red.

③ Turn on the Lamp Power

Press **POWER ON** on the projector or the "Power" remote control.

NOTE

- The flashing green **LAMP REPLACEMENT** indicator shows that the lamp is warming up. Wait until the indicator stops flashing before operating the projector.
- If the power is turned off and then immediately turned on again, it may take a short while before the lamp turns on.
- After the projector is unpacked and turned on for the first time, a slight odor may be emitted from the exhaust vent. This odor will soon disappear with use.

When the power is on, the **LAMP REPLACEMENT** indicator lights indicating the status of the lamp.

Green: Lamp is ready.

Flashing green: Warming up.

Red: Change the lamp.

④ Adjusting Focus

Slide the focus knob until the image on the screen becomes clear.

⑤ Adjusting Zoom

Slide the zoom knob. The image can be adjusted to the desired size within the zoom range.



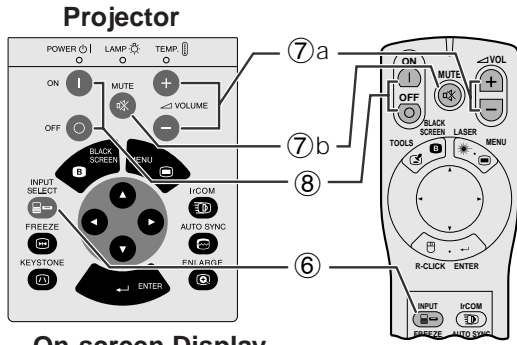

On-screen Display

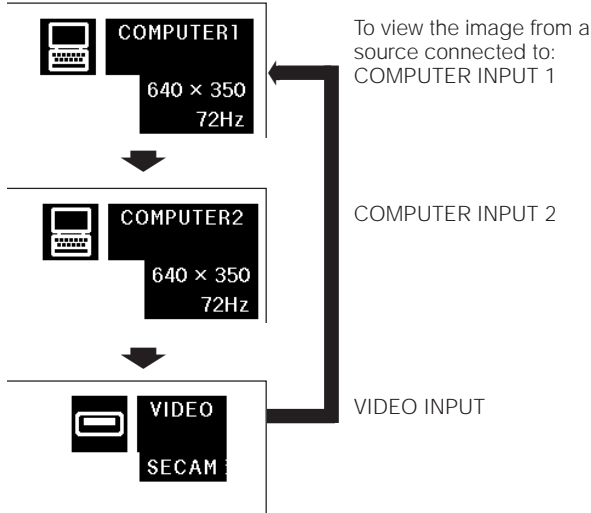

To view the image from a source connected to: COMPUTER INPUT 1

COMPUTER INPUT 2

VIDEO INPUT

⑦ a

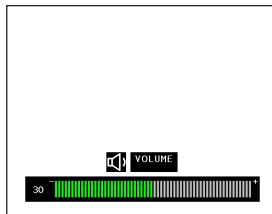

⑦ b

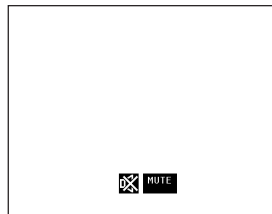

⑧

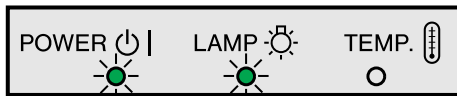
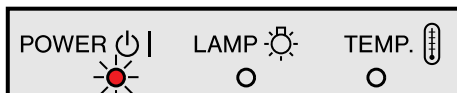
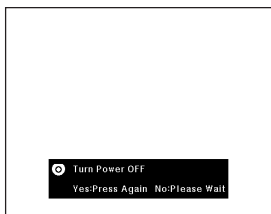

⑥ Selecting and Checking the Input Mode

Press **INPUT SELECT** on the projector or **INPUT** on the "Power" remote control to select the desired input mode. Press it again to change the mode as shown on the left.

NOTE

- When no signal is being received, "No Signal" will be displayed. When a signal that the projector is not preset to receive is being received, "Not Reg." will be displayed.
- The picture size and aspect ratio differ in "Computer", "Pal", "Secam" and "Ntsc" modes.

⑦ Adjusting the Volume

- Press **VOLUME +/VOLUME -** on the projector or the "Power" remote control to adjust the volume.
- Press **MUTE** on the projector or the "Power" remote control to temporarily turn off the sound. Press **MUTE** again to turn the sound back on.

⑧ Turning off the Power

- Press **POWER OFF** on the projector or the "Power" remote control. The screen on the left will appear.
- Press **POWER OFF** again while the screen is displayed.

NOTE

- If you accidentally pressed **POWER OFF** and do not want to turn off the power, wait until the power off screen shown on the left disappears.

When **POWER OFF** is pressed twice, the POWER indicator will light up red and the cooling fan will run for about 90 seconds. The projector will then enter standby mode.

The power can be turned on again by pressing **POWER ON** on the projector or the "Power" remote control. When the power is turned on, the POWER indicator and the LAMP REPLACEMENT indicator light green.

NOTE

- The POWER indicator flashes if the bottom filter cover is not securely installed.



Using the GUI (Graphical User Interface) Menu Screens

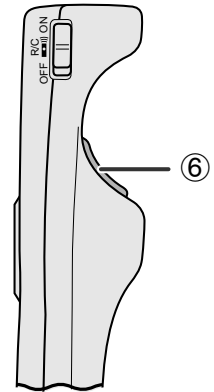
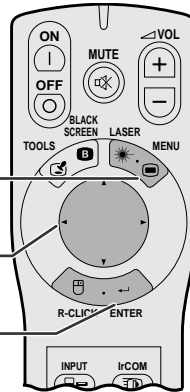
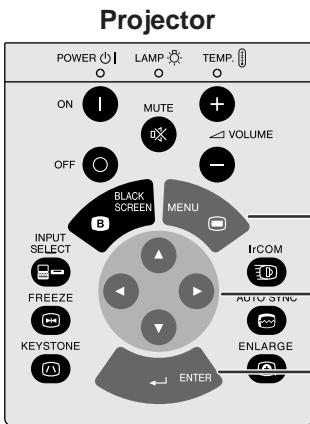
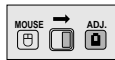

Menu bar in COMPUTER Mode

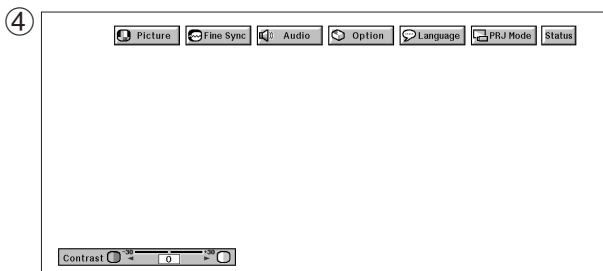
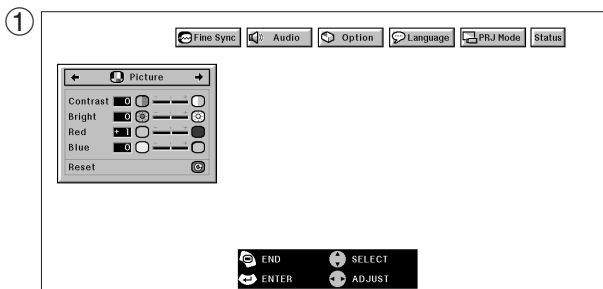

Menu bar in VIDEO Mode

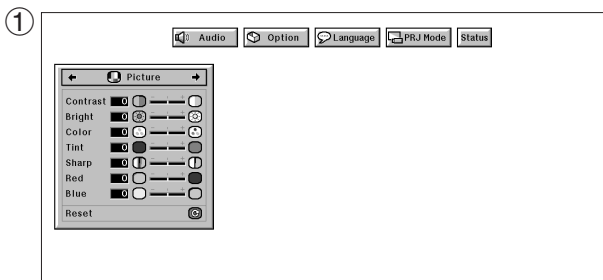

This projector has two sets of menu screens (Computer/Video) that allow you to adjust the image and various projector settings. These menu screens can be operated from the projector or the "Power" remote control with the following buttons.

(For use with the "Power" remote control, slide the **MOUSE/ADJUSTMENT** switch to the ADJ. position.)

- ① Press **MENU** to display the COMPUTER or VIDEO mode menu bar.
- ② Press **◀/▶** to select an adjustment menu on the menu bar.
- ③ Press **▲/▼** to select a specific adjustment item.
- ④ To display only the adjustment item, press **ENTER** after selecting the item. Only the menu bar and the selected adjustment item will appear.
- ⑤ Press **◀/▶** to adjust the item.
- ⑥ Press **LEFT-CLICK** to return to the previous screen.
- ⑦ Press **MENU** to exit from the GUI.

NOTE

- For details on items on the menu screen, see the tree charts on the next page.





Items on the COMPUTER1 or COMPUTER2 Mode Menu Bar

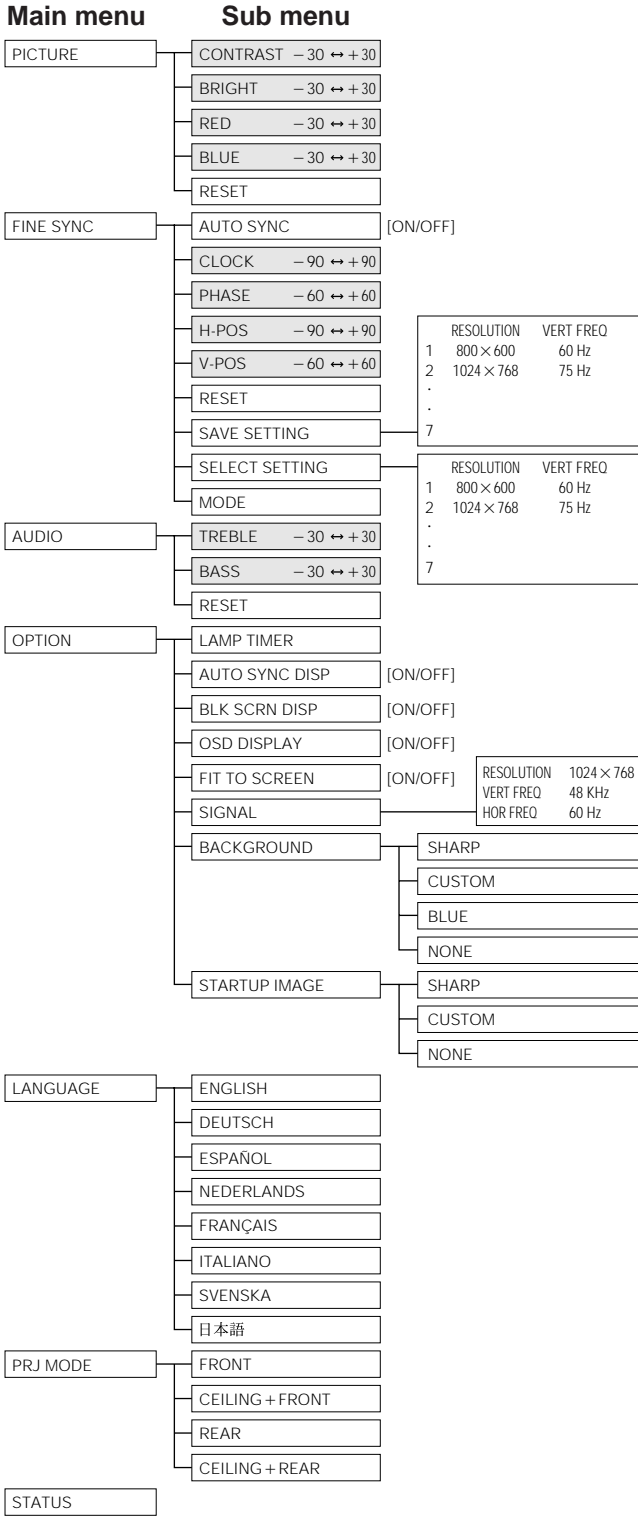

Items on the VIDEO Mode Menu Bar

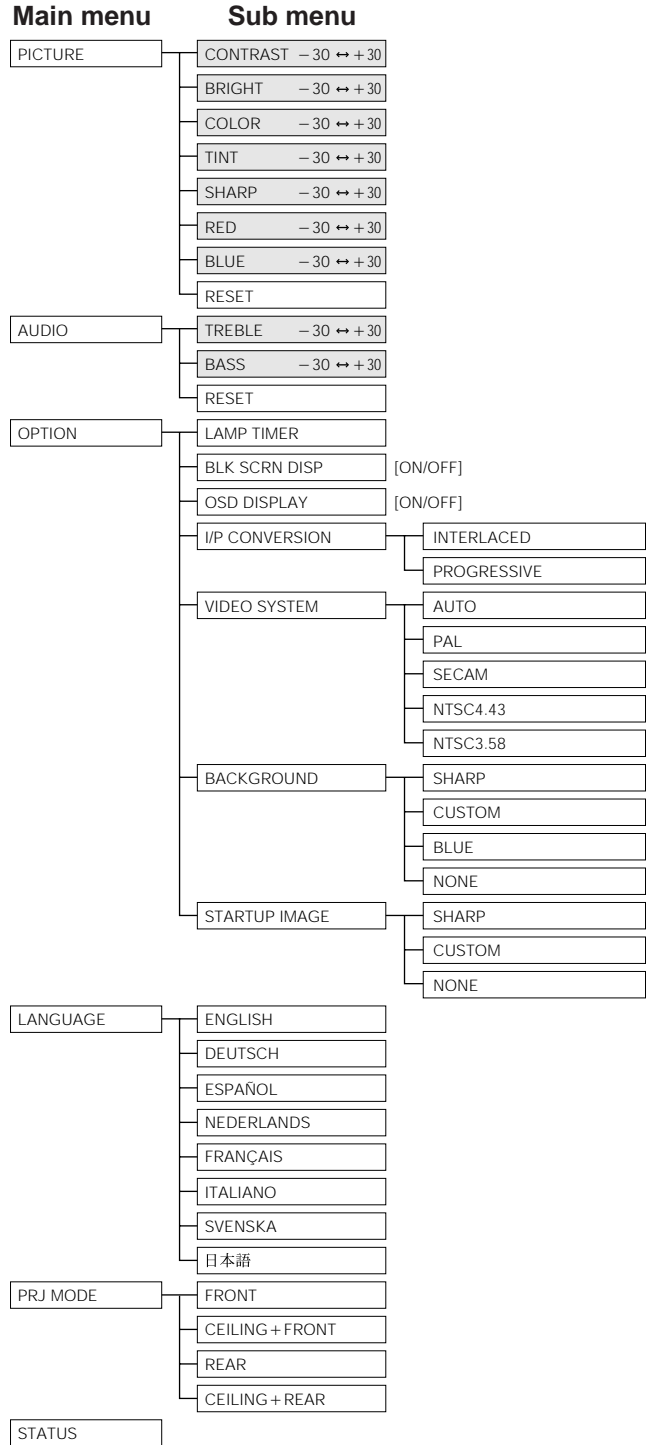

NOTE

- Only the items highlighted in the tree charts above can be adjusted.
- To adjust the items under the sub menu, press ► after entering the sub menu.





Using IrCOM for Wireless Presentations

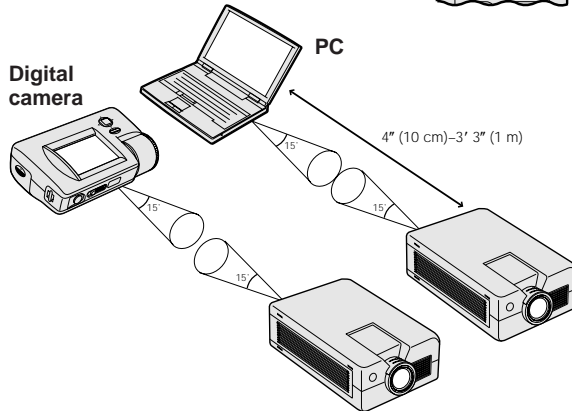
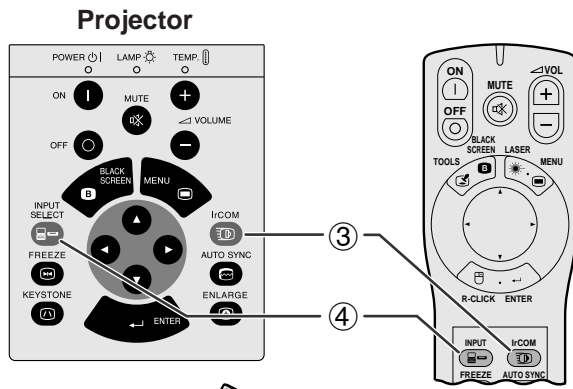
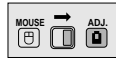

On-screen Display

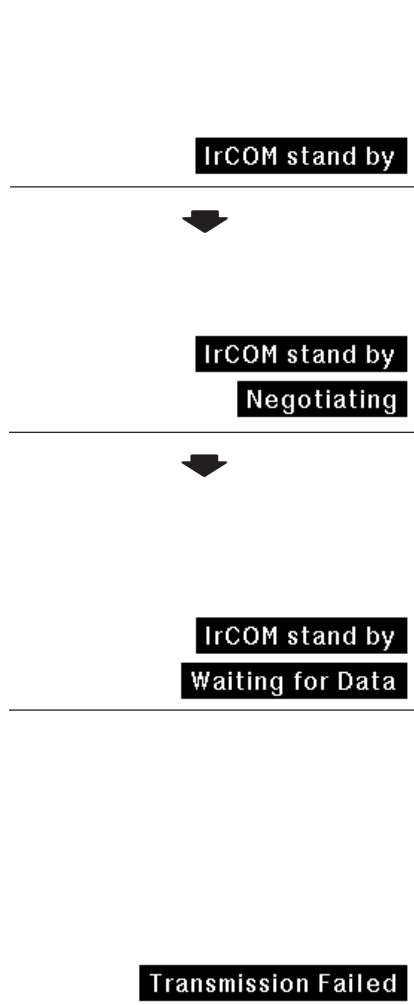

- The IrCOM function can be used to wirelessly transfer still images from a computer, handheld P/C or digital camera to the projector via infrared communication. This function is used with the supplied Sharp Advanced Presentation Software. See the operation manual of the software for installation and operating instructions.
- Position the projector and the IrCOM transmitting device within the range shown on the left.

NOTE

- To avoid transmission errors or changes in the image, ensure the following when setting up the projector and transmitting device.
 - The IrCOM sensors on both the projector and transmitting device are protected from direct sunlight or strong ambient light.
 - The transmitting device has sufficient battery power.
 - The projector and transmitting device are positioned within the designated operating range.
 - The IrCOM sensors on the projector and transmitting device are correctly aligned.

- 1 Before setting up the projector and transmitting device, install the Sharp Advanced Presentation Software in the supplied CD-ROM on the computer. See the operation manual of the software for installation details.

NOTE

- The distance between the projector and transmitting device may have to be less than 10 cm depending on the transmitting device.
- When using the digital still camera, set it to the image transmission mode and set the computer to the image reception mode.

- 2 Align the projector and transmitting device at the same height and angle at a distance of 4" (10 cm) to 3' 3" (1 meter) with an unobstructed line of view.
- 3 Press **IrCOM** on the projector or the "Power" remote control to enter the IrCOM mode. The On-screen Display changes as shown on the left.

NOTE

- To use the "Power" remote control to operate this function, slide the **MOUSE/ADJUSTMENT** switch to the ADJ. position before pressing **IrCOM**.
- If the On-screen Display does not change as shown on the left, the projector may not be within the reception range from the IrCOM transmitting device.

- 4 Press **INPUT SELECT** on the projector or **INPUT** on the "Power" remote control to exit the IrCOM mode.

NOTE

- If the projector is unable to receive images from the IrCOM transmitting device, the On-screen display on the left will appear.





Selecting the On-screen Display Language

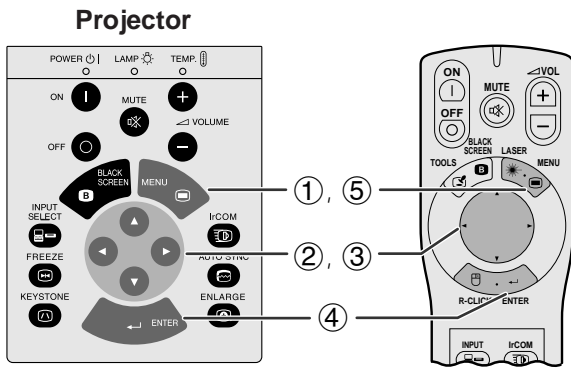
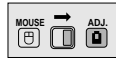

English is the preset language for the On-screen Display. It can be changed to English, German, Spanish, Dutch, French, Italian, Swedish or Japanese.

(For use with the "Power" remote control, slide the **MOUSE/ADJUSTMENT** switch to the ADJ. position.)

- ① Press **MENU**.
- ② Press **◀/▶** to select "Language".
- ③ Press **▲/▼** to select the desired language .
- ④ Press **ENTER** to save the setting. The On-screen Display is now programed to display in the language selected.
- ⑤ To exit from the GUI, press **MENU**.

(GUI) On-screen Display



Selecting the Video Input System Mode (VIDEO mode only)

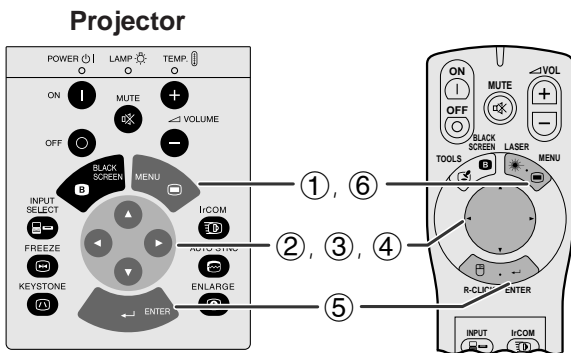
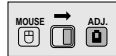

The video input system mode is preset to "Auto"; however, it can be changed to a specific system mode, if the selected system mode is not compatible with the connected audiovisual equipment.

(For use with the "Power" remote control, slide the **MOUSE/ADJUSTMENT** switch to the ADJ. position.)

- ① Press **MENU**.
- ② Press **◀/▶** to select "Option".
- ③ Press **▲/▼** to select "Video System".
- ④ Press **▲/▼** to select the desired video system mode.
- ⑤ Press **ENTER** to save the setting.
- ⑥ To exit from the GUI, press **MENU**.

NOTE

- When the system mode is set to "Auto", you may not receive a clear picture due to signal differences. Should this occur, switch to the video system you are viewing.

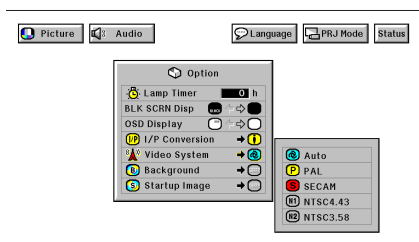

Picture Adjustments

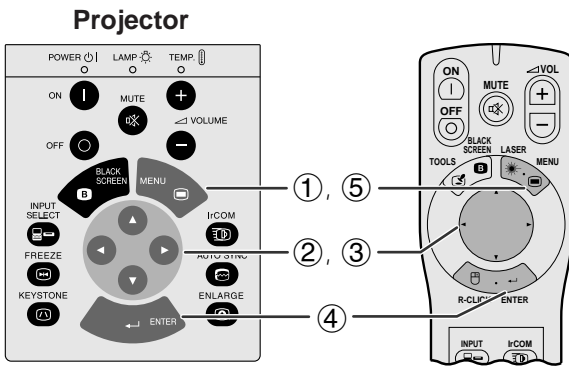
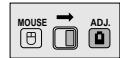

You can adjust the projector's picture to your preferences with the following picture settings.

Description of Adjustment Items

Selected item in COMPUTER mode	◀ button	▶ button
Contrast	For less contrast	For more contrast
Bright	For less brightness	For more brightness
Red	For weaker red	For stronger red
Blue	For weaker blue	For stronger blue
Reset	All computer adjustment items are returned to the factory preset settings.	

Selected item in VIDEO mode	◀ button	▶ button
Contrast	For less contrast	For more contrast
Bright	For less brightness	For more brightness
Color	For less color intensity	For more color intensity
Tint	Skin tones become purplish	Skin tones become greenish
Sharp	For less sharpness	For more sharpness
Red	For weaker red	For stronger red
Blue	For weaker blue	For stronger blue
Reset	All video adjustment items are returned to the factory preset settings.	

(The following steps are used as an example in adjusting the picture in "COMPUTER" mode.)

(For use with the "Power" remote control, slide the **MOUSE/ADJUSTMENT** switch to the ADJ. position.)

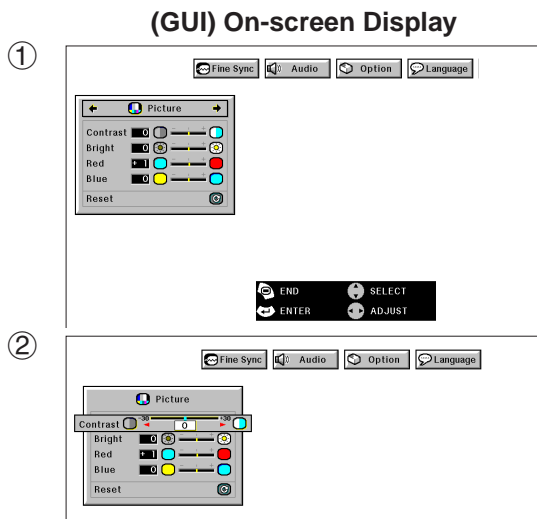

- ① Press **MENU**. Menu bar and "Picture" menu screen appears. GUI Operation guide is also displayed.
- ② Press ▲/▼ to select a specific adjustment item.
- ③ Press ◀/▶ to move the ◐ mark of the selected adjustment item to the desired setting.
- ④ Press **ENTER** to save the setting.
- ⑤ To exit from the GUI, press **MENU**.

NOTE

- To reset all adjustment items, select "Reset" on the "Picture" menu screen and press **ENTER**.
- The adjustments can be stored separately in the "COMPUTER1", "COMPUTER2" and "VIDEO" modes.
- "Tint" appears only in "NTSC3.58" and "NTSC4.43" modes.





Audio Adjustments

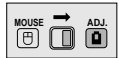

Projector

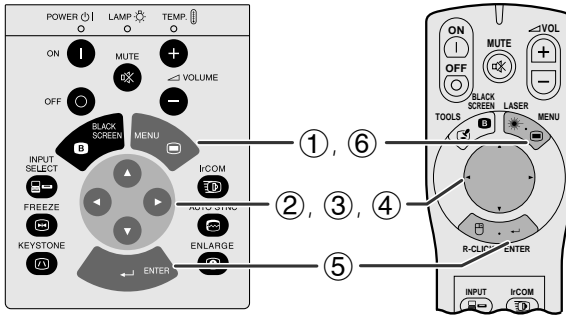

This projector's audio is factory preset to standard settings. However, you can adjust it to suit your own preferences by adjusting the following audio settings.

Description of Adjustment Items

Selected item	◀ button	▶ button
Treble	For weaker treble	For stronger treble
Bass	For weaker bass	For stronger bass
Reset	All audio adjustment items are returned to the factory preset settings.	

(For use with the "Power" remote control, slide the **MOUSE/ADJUSTMENT** switch to the ADJ. position.)

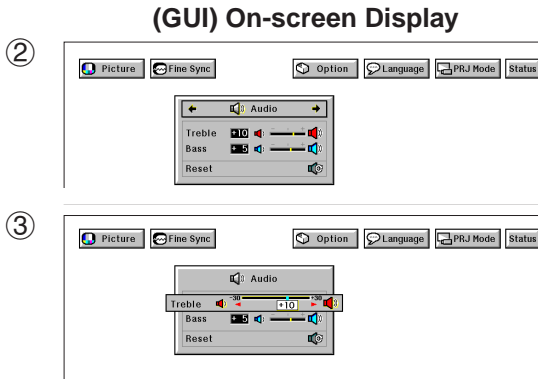

① Press **MENU**. Menu bar and "Picture" menu screen appears. GUI Operation guide is also displayed.

② Press ◀/▶ to select "Audio".

③ Press ▲/▼ to select a specific adjustment item.

④ Press ◀/▶ to move the ◐ mark of the selected adjustment item to the desired setting.

⑤ Press **ENTER** to save the setting.

⑥ To exit from the GUI, press **MENU**.

NOTE

- To reset all adjustment items, select "Reset" on the "Audio" menu screen and press **ENTER**.





Computer Image Adjustments

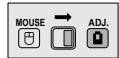

Projector

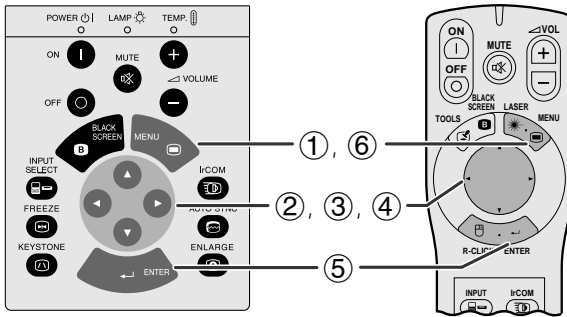

When displaying computer patterns which are very detailed (tiling, vertical stripes, etc.), interference may occur between the LCD pixels, causing flickering, vertical stripes, or contrast irregularities in portions of the screen. Should this occur, adjust "Clock", "Phase", "H-Pos" and "V-Pos" for optimum computer image.

Description of Adjustment Items

Selected item	Description
Clock	Adjusts vertical noise.
Phase	Adjusts horizontal noise (similar to tracking on your VCR).
H-Pos	Centers the on-screen image by moving it to the left or right.
V-Pos	Centers the on-screen image by moving it up or down.

NOTE

- Computer image adjustment can be made easily by pressing **AUTO SYNC** (⊞) on the projector or the "Power" remote control. See the next page for details.

(GUI) On-Screen Display

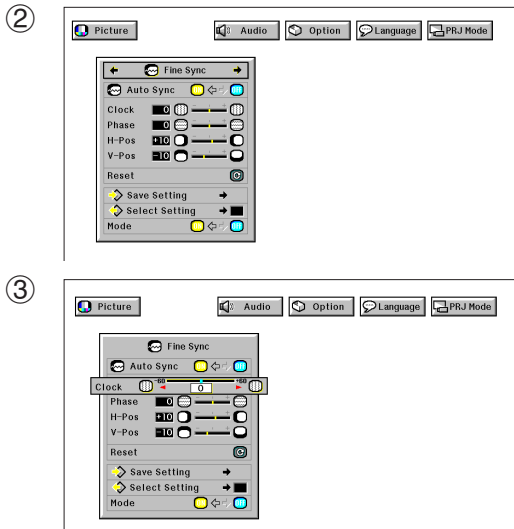

(Select the desired computer input mode with **INPUT SELECT** on the projector or **INPUT** on the "Power" remote control.)

(For use with the "Power" remote control, slide the **MOUSE/ADJUSTMENT** switch to the ADJ. position.)

- 1 Press **MENU**. Menu bar and "Picture" menu screen appears. GUI Operation guide is also displayed.
- 2 Press **◀/▶** to select "Fine Sync".
- 3 Press **▲/▼** to select a specific adjustment item.
- 4 Press **◀/▶** to move the **●** mark of the selected adjustment item to the desired setting.
- 5 Press **ENTER** to save the setting.
- 6 To exit from the GUI, press **MENU**.

NOTE

- To reset all adjustment items, select "Reset" on the "Fine Sync" menu screen and press **ENTER**.



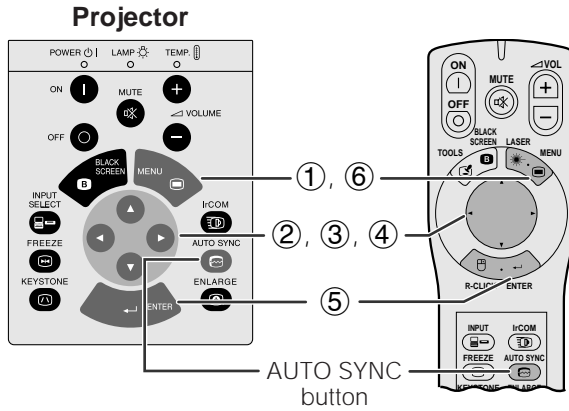

Auto Sync Adjustment

- Used to automatically adjust a COMPUTER image.
- Auto Sync adjustment can be made manually by pressing **AUTO SYNC** on the projector or the "Power" remote control, or automatically by setting "Auto Sync" to "ON" in the projector's GUI menu.

When "Auto Sync" is set to "ON":

- The sync adjustment is automatically made each time the projector is turned on while connected to a computer or the input selection is changed.
- The Auto Sync adjustment setting previously made is cleared when the projector's setting is changed.

(For use with the "Power" remote control, slide the **MOUSE/ADJUSTMENT** switch to the ADJ. position.)

- 1 Press **MENU**.
- 2 Press **◀/▶** to select "Fine Sync".
- 3 Press **▲/▼** to select "Auto Sync".
- 4 Press **◀/▶** to select "ON".
- 5 Press **ENTER** to save the setting.
- 6 To exit from the GUI, press **MENU**.

NOTE

- Automatic adjustments can be made by pressing **AUTO SYNC** on the projector or the "Power" remote control.
- When the optimum image cannot be achieved with Auto Sync adjustment, use manual adjustments. (See the previous page.)

During Auto Sync adjustment, the On-screen Display changes as shown on the left.

NOTE

- Auto Sync adjustment may take some time to complete, depending on the image of the computer connected to the projector.

(GUI) On-screen Display

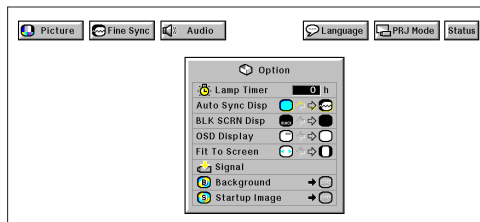
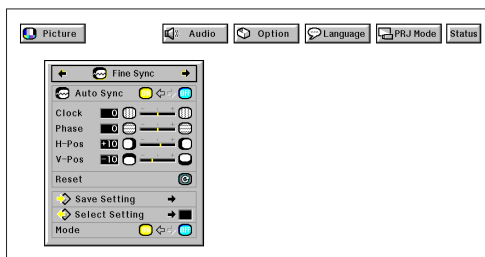

Auto Sync Display Function

By default a Sharp image is superimposed during Auto Sync adjustment. You can choose not to have this superimposed image during Auto Sync adjustment.

(For use with the "Power" remote control, slide the **MOUSE/ADJUSTMENT** switch to the ADJ. position.)

- 1 Press **MENU**.
- 2 Press **◀/▶** to select "Option".
- 3 Press **▲/▼** to select "Auto Sync Disp".
- 4 Press **◀/▶** to select "OFF" to remove the auto sync display during Auto Sync adjustment.
- 5 Press **ENTER** to save the setting.
- 6 To exit from the GUI, press **MENU**.





Projector

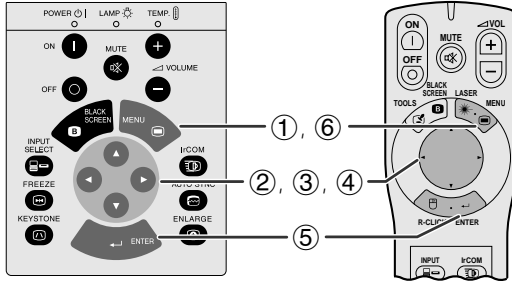

(GUI) On-screen Display

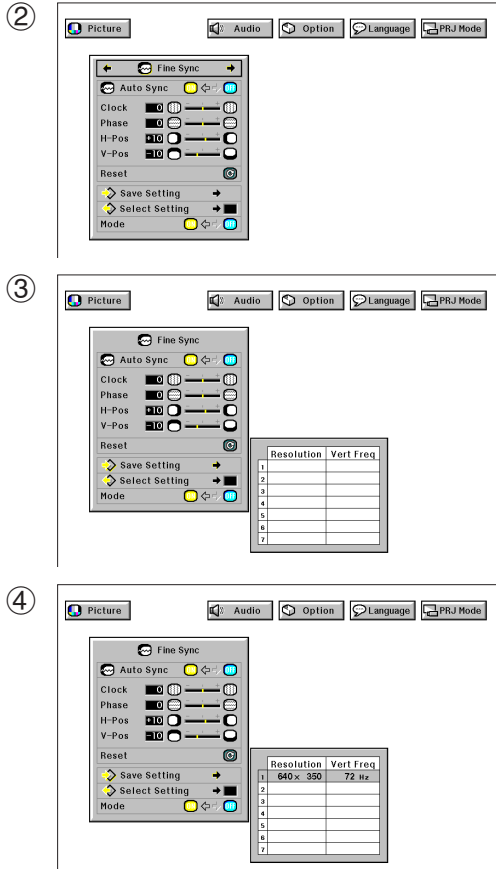

Mode Adjustment

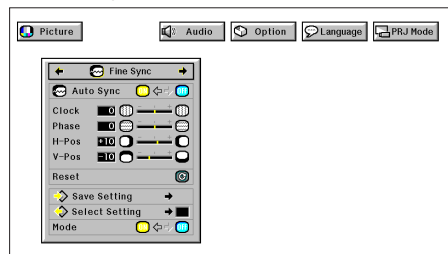

Saving and Selecting Adjustment Settings

This projector allows you to store up to seven adjustment settings for use with various computers. Once these settings are stored, they can be easily selected each time you connect the computer to the projector.

Saving the adjustment setting

(For use with the "Power" remote control, slide the **MOUSE/ADJUSTMENT** switch to the ADJ. position.)

- ① Press **MENU**.
- ② Press **◀/▶** to select "Fine Sync".
- ③ Press **▲/▼** to select "Save Setting", and then press **▶**.
- ④ Press **▲/▼** to select the desired memory location of the setting.
- ⑤ Press **ENTER** to save the setting.
- ⑥ To exit from the GUI, press **ENTER**.

Selecting a saved setting

(For use with the "Power" remote control, slide the **MOUSE/ADJUSTMENT** switch to the ADJ. position.)

- ① Press **MENU**.
- ② Press **◀/▶** to select "Fine Sync".
- ③ Press **▲/▼** to select "Select Setting", and then press **▶**.
- ④ Press **▲/▼** to select the desired memory setting.
- ⑤ Press **ENTER** to select the setting.
- ⑥ To exit from the GUI, press **MENU**.

NOTE

- If the memory position has not been set, the resolution and frequency will not be displayed.
- When selecting the stored adjustment setting with "Select Setting", the computer system should match the stored setting.

Mode Adjustment

Used to display image in the text and graphic modes.

CONNECTING TO IBM-PC COMPUTERS

- Ordinarily, the type of input signal is detected and the correct resolution mode (Text or Graphics) is automatically selected. However, for the following signals, set "Mode" on the "Fine Sync" menu screen to "ON" or "OFF" to select the projector's resolution mode to match the computer display mode properly.

(For use with the "Power" remote control, slide the **MOUSE/ADJUSTMENT** switch to the ADJ. position.)

- ① Press **MENU**.
- ② Press **◀/▶** to select "Fine Sync".
- ③ Press **▲/▼** to select "Mode".
- ④ Press **◀/▶** to select "ON" for text mode (720 dots × 350 lines, 720 dots × 400 lines or 1,152 dots × 864 lines, 60 Hz) or "OFF" for graphic mode (640 dots × 350 lines, 640 dots × 400 lines or 1,024 dots × 864 lines, 60 Hz). (For IBM-PC) Press **◀/▶** to select "ON" when connecting to a Macintosh II with 35 kHz dot frequency or "OFF" when connecting to a Macintosh LC Series computer with 34.79 kHz dot frequency. (For Macintosh LC Series)
- ⑤ Press **ENTER** to save the setting.
- ⑥ To exit from the GUI, press **MENU**.

NOTE

- When connecting third party video cards and other Macintosh computers, set "Mode" on the "Fine Sync" menu screen to "ON" or "OFF" to select the correct display mode.
- When the input signal is automatically detected or when there is no input signal, "Mode (---)" appears on the screen and the display mode cannot be changed.
- Avoid displaying computer patterns which repeat every other line (horizontal stripes). (Flickering may occur, making the image hard to see.)





Digital Image Magnification and Reduction

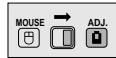

Projector

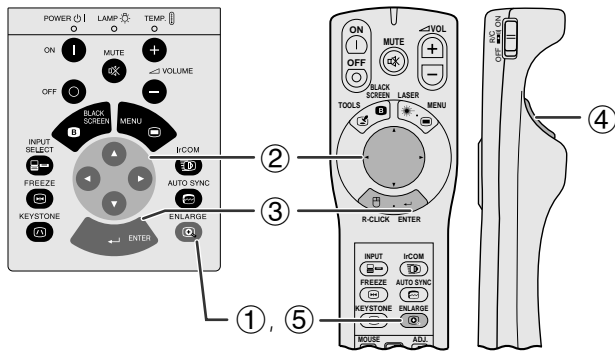

This function allows you to magnify or reduce a specific portion of an image. This is useful when you want to display a detailed portion of the image or display it in its native resolution.

(To use the "Power" remote control to operate this function, slide the **MOUSE/ADJUSTMENT** switch to the ADJ. position before pressing **ENLARGE**.)

- ① Press **ENLARGE**. A rectangle appears on the screen.
- ② Press **▲/▼/◀/▶** to select the area of the image you want to enlarge or reduce.
- ③ Press **ENTER** to enlarge the area of the image.
- ④ Press **LEFT-CLICK** on the "Power" remote control to reduce the area of the image.
- ⑤ Press **ENLARGE** again to turn off the rectangular on the screen.

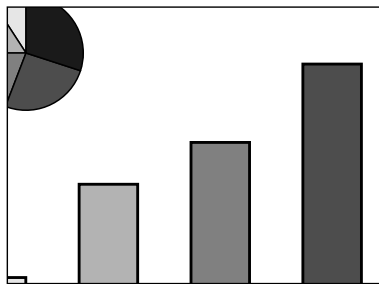
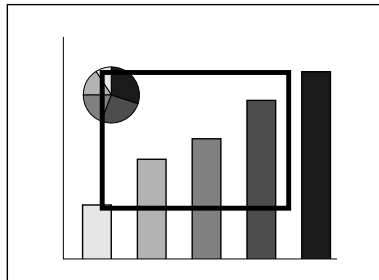

NOTE

- Picture reduction can only be made with the "Power" remote control.
- If the image has an SXGA or UXGA resolution, you can scroll the image on the screen by using **▲/▼/◀/▶**.
- Each time **ENTER** or **LEFT-CLICK** is pressed, image magnification and reduction patterns toggle as shown below.

Pressing ENTER

Dot by dot → ×1 → ×2 → ×4 → ×8

Pressing LEFT-CLICK

Dot by dot → ×8 → ×4 → ×2 → ×1

Dot by dot mode display

This mode displays images in their native resolution and not expanded to fit the LCD resolution. See the steps and the third note above to display an image in dot by dot mode.



Black Screen Function

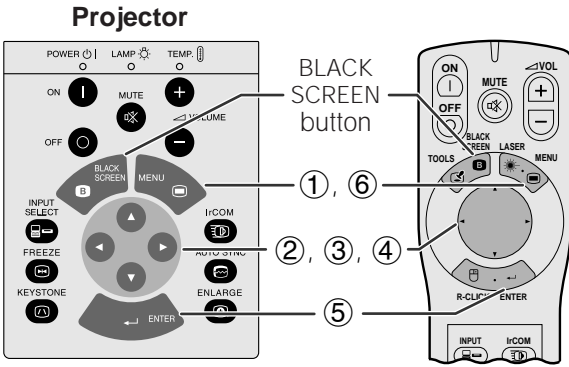
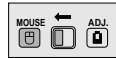

This function can be used to superimpose a black screen over the projected image.

Blacking out the Projected Image

Press **BLACK SCREEN**. "BLACK SCREEN" is displayed on the screen. To return to the original projected image, press **BLACK SCREEN** again.

NOTE

- To use the "Power" remote control to operate this function, slide the **MOUSE/ADJUSTMENT** switch to the **MOUSE** position before pressing **BLACK SCREEN**.

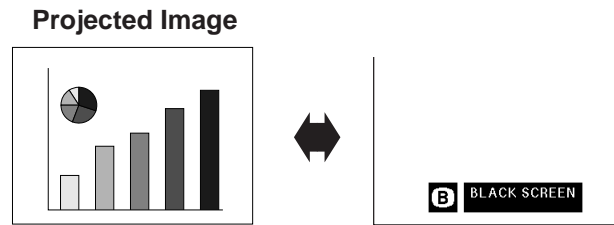

Turning off the On-screen Display



The On-screen Display ("BLACK SCREEN") that appears during black screen can be turned off. When "BLK SCR N Disp" is set to "●" in the projector's GUI menu, "BLACK SCREEN" will not be displayed during function.

(For use with the "Power" remote control, slide the **MOUSE/ADJUSTMENT** switch to the **ADJ.** position.)

(GUI) On-screen Display

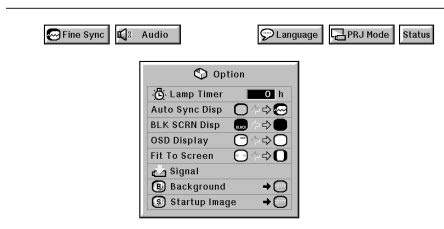

- Press **MENU**.
- Press **◀/▶** to select "Option".
- Press **▲/▼** to select "BLK SCR N Disp".
- Press **◀/▶** to select "●" to turn on or "●" to turn off the function.
- Press **ENTER** to save the setting.
- To exit from the GUI, press **MENU**.

On-screen Display Override Function

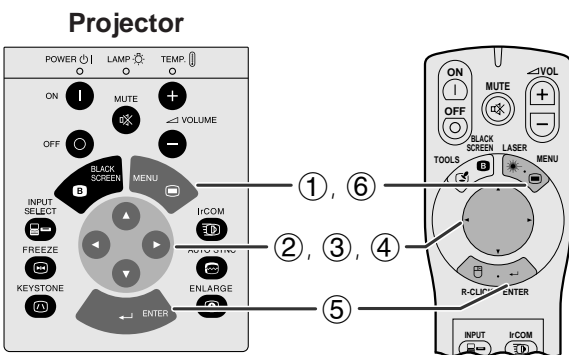
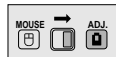

This function allows you to turn off the on-screen messages that appear during "input select", "IrCOM" and "FREEZE" functions. Once "OSD Display" is set to "○" in the projector's GUI menu, the on-screen messages will not appear when **INPUT**, **IrCOM** and **FREEZE** on the projector or the "Power" remote control are pressed.

(For use with the "Power" remote control, slide the **MOUSE/ADJUSTMENT** switch to the **ADJ.** position.)

- Press **MENU**.
- Press **◀/▶** to select "Option".
- Press **▲/▼** to select "OSD Display".
- Press **◀/▶** to select "○" to turn off the On-screen Display.
- Press **ENTER** to save the setting.
- To exit from the GUI, press **MENU**.

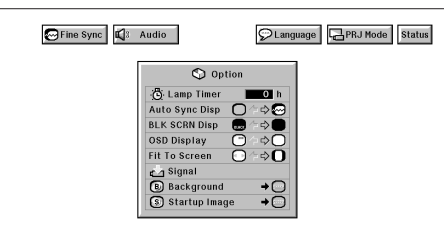

Fit to Screen Function

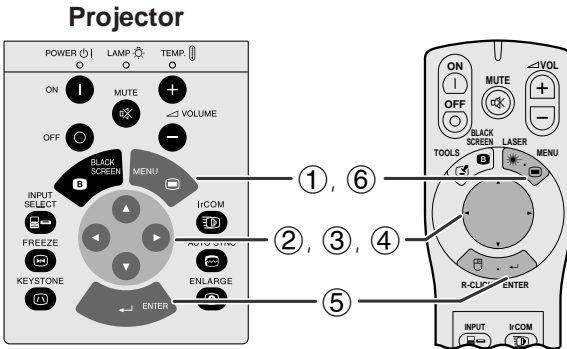
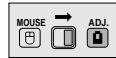

This function can be used to expand or compress images which are not native 4:3 aspect ratio (i.e. 1,152 × 864 resolution).

(For use with the "Power" remote control, slide the **MOUSE/ADJUSTMENT** switch to the ADJ. position.)

- ① Press **MENU**.
- ② Press **◀/▶** to select "Option".
- ③ Press **▲/▼** to select "Fit To Screen".
- ④ Press **◀/▶** to select "**O**" to display the image in its native resolution or "**⊕**" to expand the image, to fill the screen.
- ⑤ Press **ENTER** to save the setting.
- ⑥ To exit from the GUI, press **MENU**.

(GUI) On-screen Display

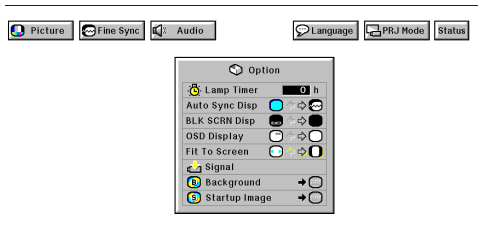

I/P Conversion (VIDEO mode only)

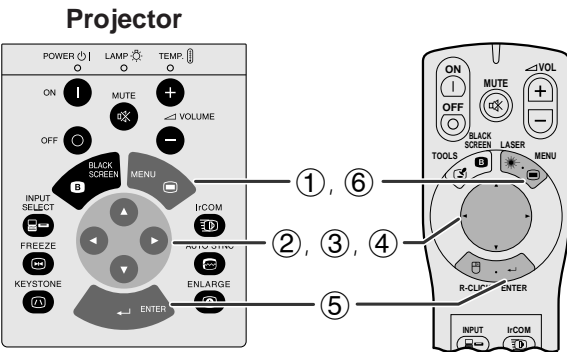

This function allows you to select either an interlaced display or a progressive display of a video signal. The progressive display projects a smooth video image.

(For use with the "Power" remote control, slide the **MOUSE/ADJUSTMENT** switch to the ADJ. position.)

- ① Press **MENU**.
- ② Press **◀/▶** to select "Option".
- ③ Press **▲/▼** to select "I/P Conversion" and then press **▶**.
- ④ Press **▲/▼** to select "Interlaced" or "Progressive".
- ⑤ Press **ENTER** to save the setting.
- ⑥ To exit from the GUI, press **MENU**.

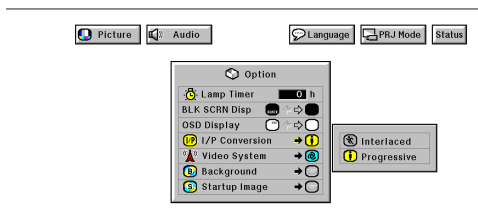



Checking the Input Signal and Lamp Usage Time

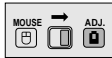

Projector

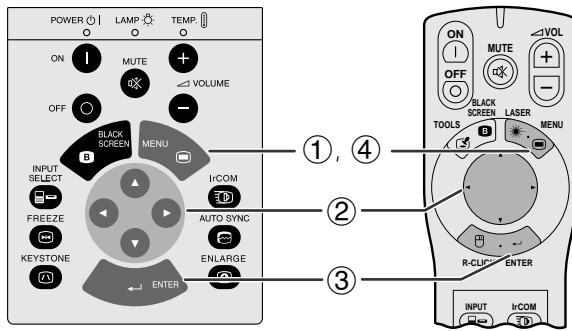

This function allows you to check the current input signal information and accumulated lamp usage time.

(For use with the "Power" remote control, slide the **MOUSE/ADJUSTMENT** switch to the ADJ. position.)

- ① Press **MENU**.
- ② Press **◀/▶** to select "Option". The lamp usage time will be displayed.
- ③ Press **▲/▼** to select "Signal" to display the current input signal.
- ④ To exit from the GUI, press **MENU**.

NOTE

- It is recommended that the lamp be replaced after 1,900 hours of usage. See pages 39 and 40 for lamp replacement.
- In VIDEO mode, the resolution and frequency settings will not be displayed.

(GUI) On-screen Display

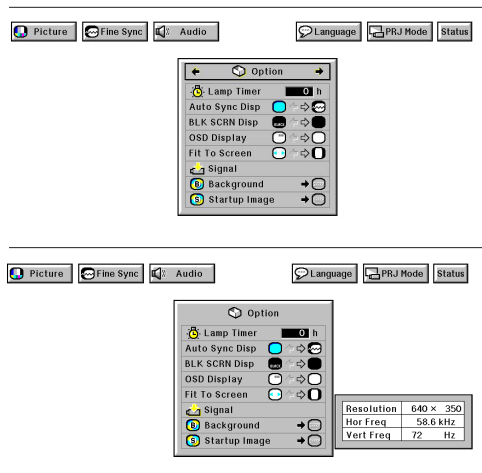

Setting a Background Image

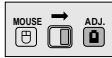

Projector

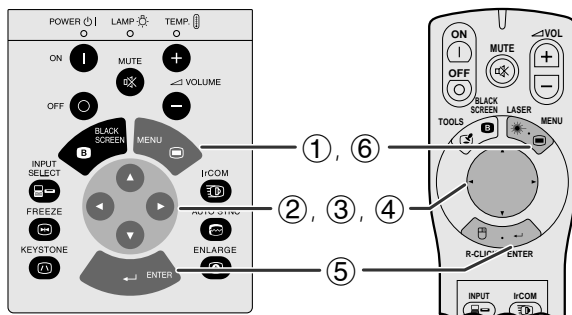

This function allows you to select the image displayed when no signal is being sent to the projector.

Description of Background Images

Selected item	Background image
Sharp	SHARP default image
Custom	User customized image
Blue	Blue screen
None	Black screen

(For use with the "Power" remote control, slide the **MOUSE/ADJUSTMENT** switch to the ADJ. position.)

- ① Press **MENU**.
- ② Press **◀/▶** to select "Option".
- ③ Press **▲/▼** to select "Background", and then press **▶**.
- ④ Press **▲/▼** to select the background image you want to display on the screen.
- ⑤ Press **ENTER** to save the setting.
- ⑥ To exit from the GUI, press **MENU**.

NOTE

- By selecting "Custom", the projector can display a custom image (i.e. your company logo) as the background image. Please see the Sharp Advanced Presentation Software's operation manual for how to save (or change) a custom image.



Selecting a Startup Image

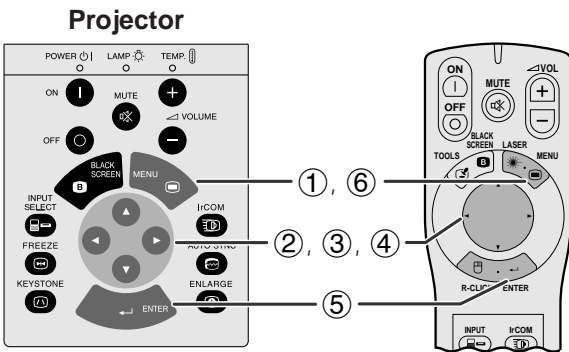
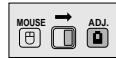

- This function allows you to specify the image to be displayed upon the projector's startup.
- A custom image (i.e. your company logo) can be loaded on the projector via IrCOM or an RS-232C cable. See pages 15 and 22 in this operation manual, and also the supplied Sharp Advanced Presentation Software's operation manual for detailed instructions.

Description of Startup Images

Selected item	Startup image
Sharp	SHARP default image
Custom	User customized image
None	Black screen

(GUI) On-screen Display

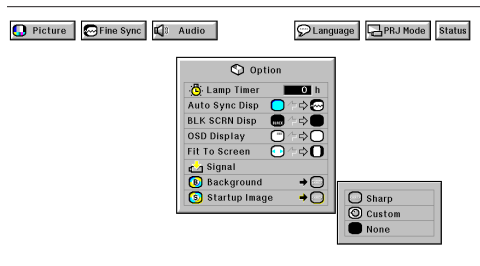

(For use with the "Power" remote control, slide the **MOUSE/ADJUSTMENT** switch to the ADJ. position.)

- 1 Press **MENU**.
- 2 Press **◀/▶** to select "Option".
- 3 Press **▲/▼** to select "Startup Image", and then press **▶**.
- 4 Press **▲/▼** to select the startup image you want to display on the screen.
- 5 Press **ENTER** to save the setting.
- 6 To exit from the GUI, press **MENU**.

NOTE

- By selecting "Custom", the projector can display a custom image (i.e. your company logo) as the startup image. Please see the Sharp Advanced Presentation Software's operation manual for how to save (or change) a custom image.

Freeze Function

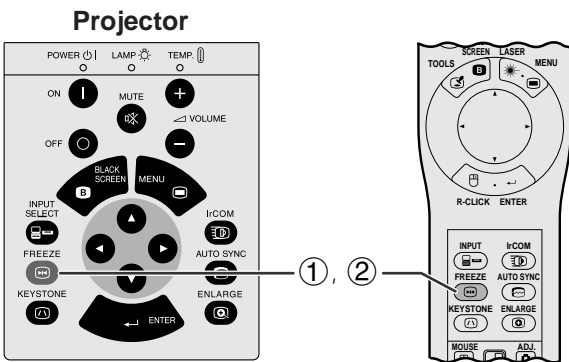

This function allows you to instantly freeze a moving image. This is useful when you want to display a still image of a video, giving you more time to explain the image to the audience.

- 1 Press **FREEZE** to freeze the image.
- 2 Press **FREEZE** again to return to the moving image.

NOTE

- To turn off the "FREEZE" On-screen Display, set "OSD Display" to "□" in the projector's GUI menu system. (See page 30 for details.)





Reverse/Invert Image Function

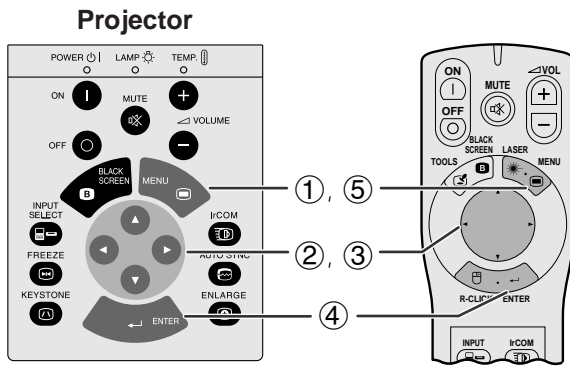
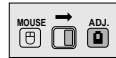

This projector is equipped with a reverse/invert image function which allows you to reverse or invert the projected image for various applications.

Description of Projected Images

Selected item	Projected image
FRONT	Normal image
CEILING + FRONT	Inverted image
REAR	Reversed image
CEILING + REAR	Reversed and inverted image

(GUI) On-screen Display

When Selecting "Front"



When Selecting "Ceiling + Front"



When Selecting "Rear"



When Selecting "Ceiling + Rear"



(For use with the "Power" remote control, slide the **MOUSE/ADJUSTMENT** switch to the ADJ. position.)

- ① Press **MENU**.
- ② Press **◀/▶** to select "PRJ Mode".
- ③ Press **▲/▼** to select the desired projection mode.
- ④ Press **ENTER** to save the setting.
- ⑤ To exit from the GUI, press **MENU**.

NOTE

- This function is used for the reversed image and ceiling-mount setups. See pages 12 and 13 for these setups.





Using the Presentation Tools

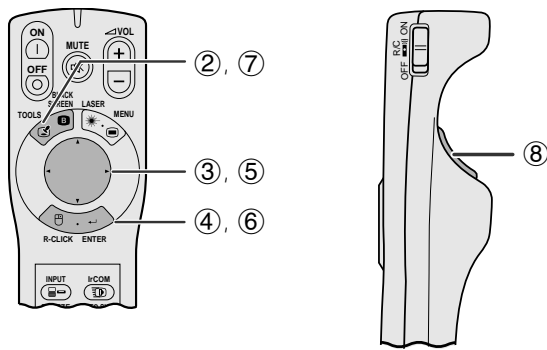
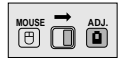

On-screen Display



Menu Window

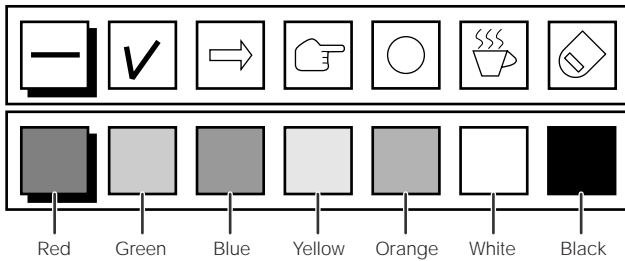

This projector is equipped with presentation tools, which can be accessed from the "Power" remote control. These will help you emphasize keypoints within your presentation.

- ① Slide the **MOUSE/ADJUSTMENT** switch to the ADJ. position.
- ② Press **TOOLS** to display the presentation tools menu window on the screen.
- ③ Press **▲/▼/◀/▶** to select the desired tool and color.
- ④ Press **ENTER** to select it.
- ⑤ Once the tool is displayed on the screen, press **▲/▼/◀/▶** to move it around the screen.
- ⑥ Press **ENTER** to stamp the tool on the screen.
- ⑦ To remove the menu from the screen, press **TOOLS**.
- ⑧ To clear the stamped tool on the screen, press **LEFT-CLICK**.

NOTE

- You can stamp each tool as many times as you want on the screen.
- To clear all the stamped presentation tools on the screen, press **▲/▼/◀/▶** to select "☕" and **ENTER**, or simply use **LEFT-CLICK** on the "Power" remote control.

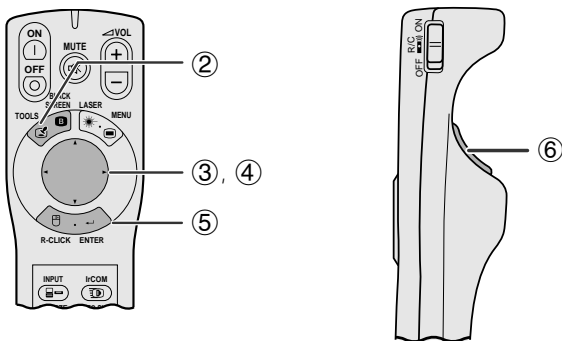

Displaying the break time

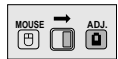

- ① Slide the **MOUSE/ADJUSTMENT** switch to the ADJ. position.
- ② Press **TOOLS** to display the presentation tools menu window on the screen.
- ③ Press **▲/▼/◀/▶** to select "☕" in the menu window.
- ④ Press **ENTER** to start counting down the break time.
- ⑤ Press **▲** to increase or **▼** to decrease the break time.
- ⑥ To clear the break time from the screen, press **LEFT-CLICK**.

NOTE

- The break time is displayed against the background image selected in "Setting a Background Image". (See page 32.)

When selecting Sharp default image





Checking the Adjustment Status

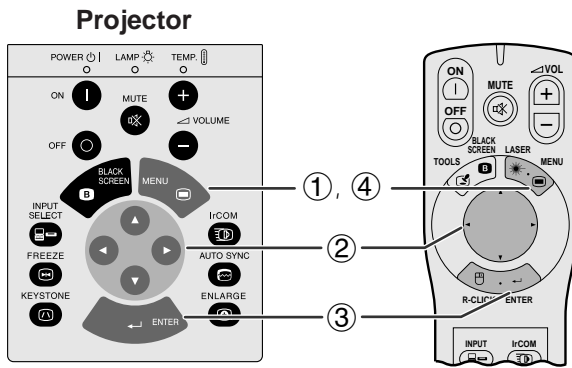
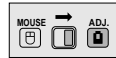

This function can be used to display all the adjusted settings on the screen simultaneously.

(For use with the "Power" remote control, slide the **MOUSE/ADJUSTMENT** switch to the ADJ. position.)

- ① Press **MENU**.
- ② Press **◀/▶** to select "Status".
- ③ Press **ENTER** to display all the adjusted settings.
- ④ To exit from the GUI, press **MENU**.

(GUI) On-screen display

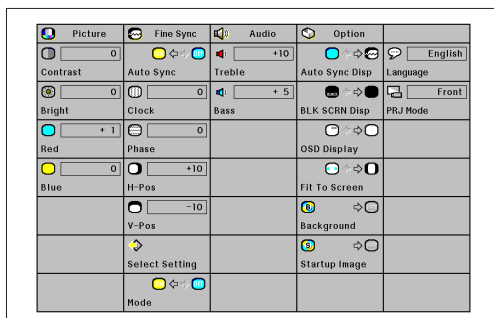
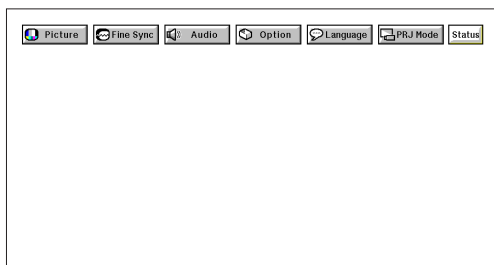

Automatic Power Shutoff Function



When no input signal is detected for more than 15 minutes, the projector will automatically shut down. The on-screen message on the left will appear five minutes before the power is automatically turned off.

NOTE

- When "None" is selected in the "Background Image" setting, the Automatic Power Shutoff function does not operate.



Air Filter Maintenance

- This projector is equipped with three air filters to ensure the optimal operating condition of the projector.
- The air filters should be cleaned every 100 hours of use. Clean the filters more often when the projector is used in a dusty or smoky location.
- Have your nearest Authorized Sharp Industrial LCD Products Dealer or Service Center exchange the filter (PFILD0076CEZZ) when it is no longer possible to clean it.

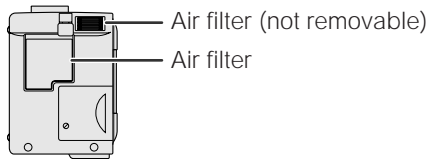

Bottom View



Side and Rear View

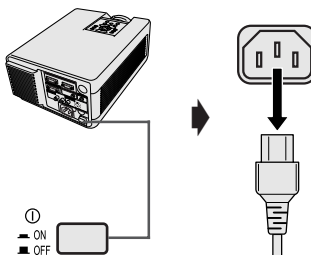
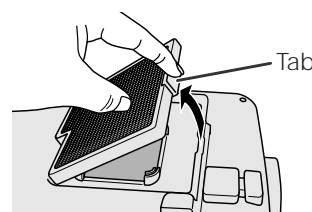
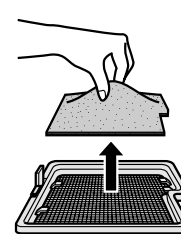

Cleaning and replacing the bottom air filter

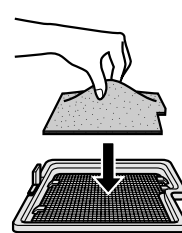
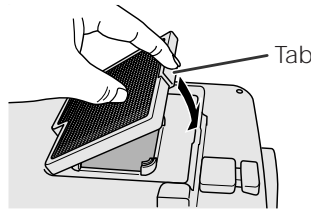
<p>1 Turn off the main power.</p>	<p>2 Remove the bottom filter cover.</p>	<p>3 Remove the air filter.</p>
<p>Turn off the MAIN POWER switch. Then unplug the power cord.</p> 	<p>Turn over the projector. Press the tab and lift open the filter cover in the direction of the arrow.</p> 	<p>Grasp the air filter between your fingers and lift it out of the filter cover.</p> 
<p>4 Clean the air filter.</p>	<p>5 Replace the air filter.</p>	<p>6 Replace the filter cover.</p>
<p>Clean the dust off the air filter and cover with a vacuum cleaner extension hose.</p> 	<p>Place the air filter underneath the tabs on the filter frame.</p> 	<p>Insert the tab on the end of the filter cover into the filter cover opening and press the filter cover into position.</p> 

NOTE

- Be sure the filter cover is securely installed. The power will not turn on unless it is correctly installed.

Cleaning the side and bottom air filters (not removable)

If dust or dirt has collected inside the air filters, clean the filters with a vacuum cleaner extension hose.

NOTE

- The side and bottom air filters cannot be removed.





Lamp/Maintenance Indicators

Maintenance Indicators

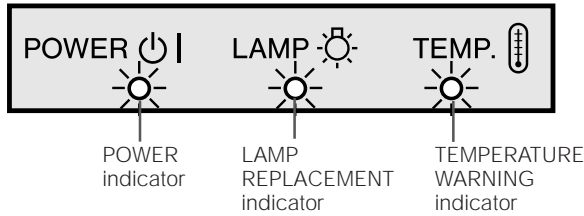

- The warning lights on the projector indicate problems inside the projector.
- There are two warning lights: a TEMPERATURE WARNING indicator which warns that the projector is too hot, and a LAMP REPLACEMENT indicator which lets you know when to change the lamp.
- If a problem occurs, either the TEMPERATURE WARNING indicator or the LAMP REPLACEMENT indicator will light up red, and the power will shut off. After turning off the power, follow the procedures given below.

Maintenance Indicator	Condition	Problem	Possible Solution
TEMPERATURE WARNING indicator	The internal temperature is abnormally high.	• Blocked air intake.	• Relocate the projector to an area with proper ventilation.
		• Clogged air filter.	• Clean the filter. (See page 37.)
		• Cooling fan breakdown. • Internal circuit failure.	• Take the projector to your nearest Authorized Sharp Industrial LCD Products Dealer or Service Center for repair.
LAMP REPLACEMENT indicator	The lamp does not light up.	• Burnt-out lamp. • Lamp circuit failure.	• Carefully replace the lamp. (See pages 39 and 40.) • Take the projector to your nearest Authorized Sharp Industrial LCD Products Dealer or Service Center for repair.
	The lamp requires replacement.	• Lamp has been used for over 1,900 hours.	
POWER indicator	The POWER indicator flashes in red when POWER ON is pressed.	• The bottom filter cover is open.	• Securely install the bottom filter cover.

NOTE

- If the TEMPERATURE WARNING indicator lights up, follow the above possible solutions and then wait until the projector has cooled down completely before turning the power back on. (At least 5 minutes.)
- If the power is turned off and then turned on again, as during a brief rest, the LAMP REPLACEMENT indicator may be triggered, preventing the power from going on. Should this occur, take the power cord out of the wall outlet and put it back in again.

Lamp

The lamp in this projector operates for approximately 2,000 cumulative hours, depending on the usage environment. It is recommended that the lamp be replaced after 1,900 cumulative hours of use or when you notice a significant deterioration of the picture and color quality.

CAUTION

- Intense light hazard. Do not attempt to look into the aperture and lens while the projector is operating.

NOTE

- The lamp usage time can be checked with the On-screen Display (see page 32).
- As the usage environment can vary significantly, the projector lamp may not operate for 2,000 hours.

Condition	Problem	Possible Solution
The LAMP REPLACEMENT indicator lights up red, and "LAMP" and "⊠" will flash in yellow in the lower-left corner of the picture.	• Lamp has been used for over 1,900 hours.	• Purchase a replacement lamp unit (lamp cage/module) of the current type BQC-XGNV5XU/1 from your nearest Authorized Sharp Industrial LCD Products Dealer or Service Center. • Replace the lamp. (See pages 39 and 40.) If you wish, you may have the lamp replaced at your nearest Authorized Sharp Industrial LCD Products Dealer or Service Center.
A significant deterioration of the picture and color quality occurs.		
The power will automatically turn off and the projector will enter standby mode.	• Lamp has been used for over 2,000 hours.	
"LAMP" and "⊠" will flash in red in the lower-left corner of the picture, and the power will turn off.		





Replacing the Projection Lamp

It is recommended that the lamp be replaced after 1,900 cumulative hours of use or when you notice a significant deterioration of the picture and color quality. Carefully change the lamp by following the steps below. If the new lamp does not light after replacement, take your projector to the nearest Authorized Sharp Industrial LCD Products Dealer or Service Center for repair.

IMPORTANT NOTE TO U.S. CUSTOMERS:

The lamp included with this projector is backed by a 90-day parts and labor limited warranty. All service of this projector under warranty, including lamp replacement, must be obtained through an Authorized Sharp Industrial LCD Products Dealer or Service Center. For the name of the nearest Authorized Sharp Industrial LCD Products Dealer or Service Center, please call toll-free: 1-800-BE-SHARP (1-800-237-4277). **U.S.A. ONLY**

Removing and installing the lamp unit

CAUTION

- Do not remove the lamp cage directly after operation of the projector. The lamp may be extremely hot. Wait at least one hour after the power cord is disconnected to allow the surface of the lamp cage to fully cool before removing the lamp cage.
- Be sure to remove the lamp cage by the handle. Be sure not to touch the glass surface of the lamp cage or the inside of the projector.
- To avoid injury to yourself and damage to the lamp, be sure to carefully follow the steps below.
- Before or after replacing the lamp, be sure to clean the air filters. See page 37 for cleaning the air filters.

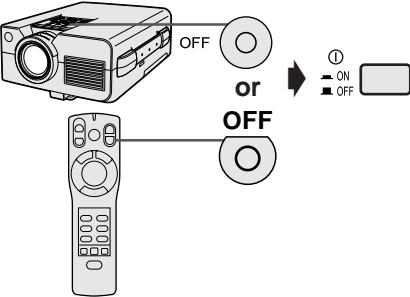
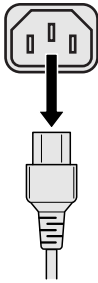
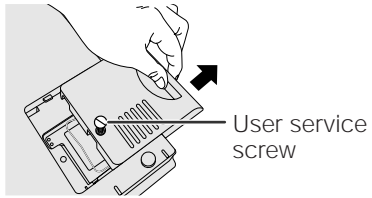
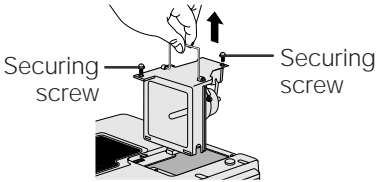
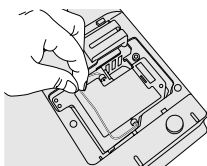
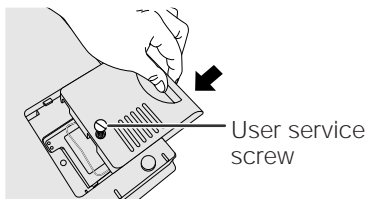
<p>1 Turn off the main power.</p> <p>Press POWER OFF. After the cooling fan stops, turn off the MAIN POWER switch.</p> 	<p>2 Disconnect the power cord.</p> <p>Unplug the power cord from the AC socket.</p> 	<p>3 Slide the lamp cage cover out.</p> <p>Turn over the projector and unfasten the user service screw that secures the lamp cage cover. Then slide the cover in the direction of the arrow.</p> 
<p>4 Remove the lamp cage.</p> <p>Remove the securing screws from the lamp cage. Hold the lamp cage by the handle and pull it towards you.</p> 	<p>5 Replace the lamp cage (after changing the lamp).</p> <p>Press the lamp cage firmly into the lamp cage compartment. Fasten the securing screws.</p> 	<p>6 Slide the lamp cage cover in.</p> <p>Slide the lamp cage cover in the direction of the arrow. Then fasten the user service screw.</p> 





Replacing the Projection Lamp

Resetting the lamp timer

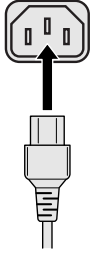
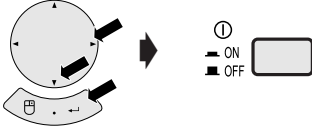
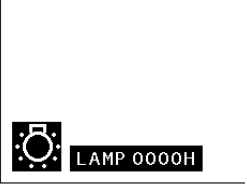
<p>1 Connect the power cord.</p> <p>Plug the power cord into the AC socket of the projector.</p> 	<p>2 Reset the lamp timer.</p> <p>While pressing ▼, ▶ and ENTER on the projector, turn on the MAIN POWER switch.</p> 	<p>"LAMP 0000H" is displayed, indicating that the lamp timer is reset.</p> 
---	---	--

NOTE

- Reset the lamp timer only after replacing the lamp.



Using the Kensington Lock

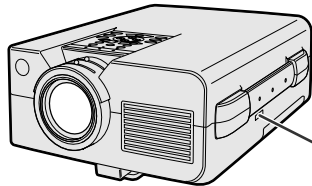

Kensington Security Standard connector

This projector has a Kensington Security Standard connector for use with a Kensington MicroSaver Security System. Refer to the information that came with the system for instructions on how to use it to secure the projector.



Troubleshooting

Problem	Check
No picture and no sound.	<ul style="list-style-type: none"> • Projector power cord is not plugged into the wall outlet. • MAIN POWER switch is not on. • The bottom filter cover is not securely installed. • Input is wrong. (See pages 19.) • Cables improperly connected to rear panel of the projector. (See pages 15, 16 and 17.) • "Power" remote control batteries have run down. (See page 10.) • Main power of the "Power" remote control is not turned on. • "Power" remote control's MOUSE/ADJUSTMENT switch is set to MOUSE.
Sound is heard but no picture appears.	<ul style="list-style-type: none"> • Cables improperly connected to rear panel of the projector. (See pages 15, 16 and 17.) • "Contrast" and "Bright" adjustments are set to minimum position. (See page 24.) • On-screen Display ("BLACK SCREEN") is turned off and Black Screen function is turned on, creating a black image. (See page 30.)
Color is faded or poor.	<ul style="list-style-type: none"> • "Color" and "Tint" adjustments are not correct. (See page 24.)
Picture is blurred.	<ul style="list-style-type: none"> • Adjust the focus. (See page 18.) • Projection distance is too long or too short to allow for proper focus. (See page 12.)
Picture appears but no sound is heard.	<ul style="list-style-type: none"> • Cables improperly connected to rear panel of the projector. (See pages 15, 16 and 17.) • Volume is set to minimum. (See page 19.)
An unusual sound is occasionally heard from the cabinet.	<ul style="list-style-type: none"> • If the picture is normal, the sound is due to cabinet shrinkage caused by temperature changes. This will not affect operation or performance.
Maintenance indicator lights up.	<ul style="list-style-type: none"> • Refer to "Lamp/Maintenance Indicators" on page 38.
Data cannot be received via IrCOM.	<ul style="list-style-type: none"> • Distance and angle between the projector and transmitting device are out of the designated range. (See page 22.) • Refer to the operation manual of the transmitting device. • Refer to the section "Troubleshooting" in the operation manual of the supplied software.



Transporting the Projector

When transporting the projector, carry it by the carrying handle on the side. A soft-side carrying bag is also provided to transport the projector.

Using the Carrying Handle

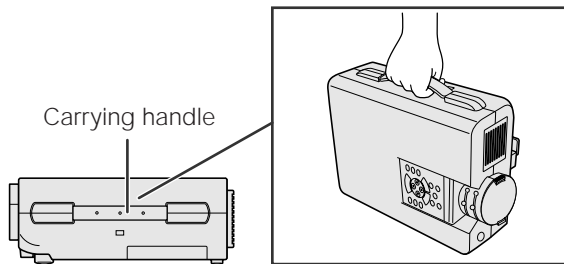

CAUTION

- Always put on the lens cap to prevent damage to the lens when transporting the projector.
- Do not lift or carry the projector by the lens or the lens cap as this may damage the lens.

Using the Carrying Bag

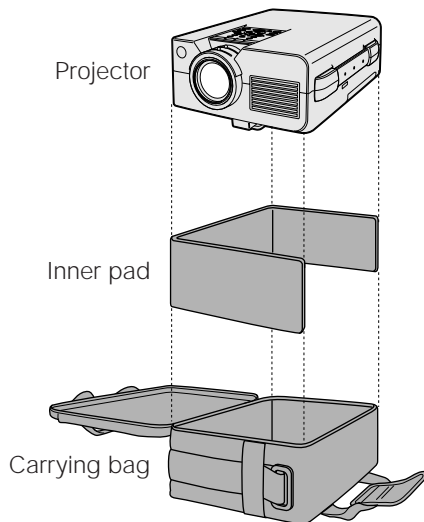

Before placing the projector into the carrying bag, set up the inner pad inside the bag as shown.

CAUTION

- The supplied carrying bag is made exclusively for the projector and its supplied accessories. Do not place other items into the carrying bag with the projector or use the bag to transport items other than the projector and its accessories.
- This bag is provided merely to transport the projector and its accessories, not to protect these products from damage as a result of rough handling. Do not expose these products to shocks or impact when transported in the carrying bag.
- Wait until the projector has sufficiently cooled before placing it into the carrying bag. If the projector is placed into the bag while it is still hot, the heat may damage the bag lining.

Attaching the shoulder strap to the carrying bag



1 Take the shoulder strap out.

The shoulder strap is stored in the pocket located in front of the carrying bag.

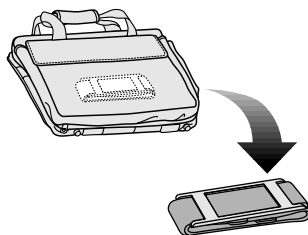

2 Fasten the shoulder strap to the carrying bag.

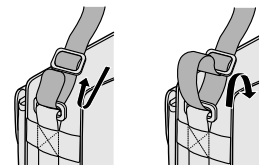

2 1/2" (6 cm)
The strap should extend at least 2 1/2" (6 cm) from the buckle.

Follow the same procedure for the other end of the strap.



Connection Pin Assignments

Analog Computer 1 and 2 Signal Input

Ports: 15-pin mini D-sub female connector

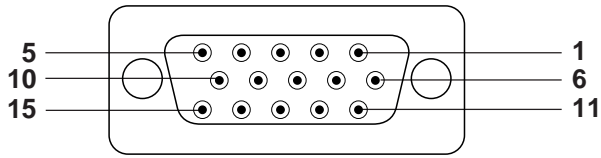

Computer Input

Analog

- | | |
|--------------------------------------|----------------------------|
| 1. Video input (red) | 9. Not connected |
| 2. Video input (green/sync on green) | 10. GND |
| 3. Video input (blue) | 11. GND |
| 4. Reserve input 1 | 12. Bi-directional data |
| 5. Composite sync | 13. Horizontal sync signal |
| 6. Earth (red) | 14. Vertical sync signal |
| 7. Earth (green/sync on green) | 15. Data clock |
| 8. Earth (blue) | |

RS-232C Port: 9-pin D-sub male connector

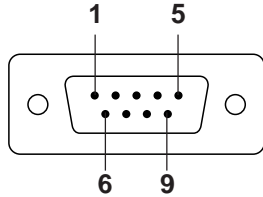

Pin No.	Signal	Name	I/O	Reference
1	CD			Not connected
2	RD	Receive Data	Input	Connected to internal circuit
3	SD	Send Data	Output	Connected to internal circuit
4	ER			Not connected
5	SG	Signal Ground		Connected to internal circuit
6	DR	Data Set Ready	Output	Not connected
7	RS	Request to Send	Output	Connected to internal circuit
8	CS			Not connected
9	CI			Not connected



RS-232C Port Specifications

PC control

A computer can be used to control the projector by connecting an RS-232C cable (cross type, sold separately) to the projector. (See page 15 for connection.)

Communication conditions

Set the serial port settings of the computer to match that of the table on the next page.

Signal format: Conforms to RS-232C standard.

Baud rate: 9,600 bps

Data length: 8 bits

Parity bit: NON

Stop bit: 1 bit

Flow control: None

Basic format

Commands from the computer are sent in the following order: command, parameter, and return code. After the projector processes the command from the computer, it sends a response code to the computer.

Command format

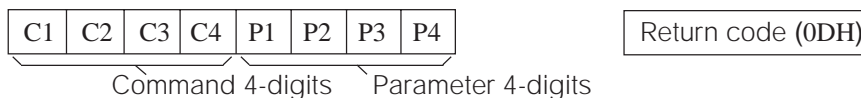

Response code format

Normal response



Problem response (communication error or incorrect command)



When more than one code is being sent, send each command only after the OK response code for the previous command from the projector is verified.

NOTE

- When using the computer control function of the projector, the projector operating status cannot be read to the computer. Therefore, confirm the status by transmitting the display commands for each adjustment menu and checking the status with the On-screen Display. If the projector receives a command other than a menu display command, it will execute the command without displaying the On-screen Display.





Commands

EXAMPLE

- When "Bright" of COMPUTER 1 IMAGE ADJUSTMENT is set to -10.

Computer

R A B R _ _ 1 0

Projector

O K

CONTROL ITEM	COMMAND				PARAMETER				CONTROL CONTENTS
	C1	C2	C3	C4	P1	P2	P3	P4	
POWER SETTING	P	O	W	R	_	_	_	0	POWER OFF
	P	O	W	R	_	_	_	1	POWER ON
INPUT SWITCHING	I	V	E	D	_	_	_	1	VIDEO
	I	R	G	B	_	_	_	1	COMPUTER 1
	I	R	G	B	_	_	_	2	COMPUTER 2
	I	C	O	M	_	_	_	1	IrCOM
INPUT CHECK	I	C	H	K	_	_	_	0	INPUT CHECK
KEYSTONE ADJUSTMENT	K	E	Y	S	*	*	*	*	KEYSTONE
LANGUAGE SELECTION	M	E	L	A	_	_	_	1	ENGLISH
	M	E	L	A	_	_	_	2	DEUTSCH
	M	E	L	A	_	_	_	3	ESPAÑOL
	M	E	L	A	_	_	_	4	NEDERLANDS
	M	E	L	A	_	_	_	5	FRANÇAIS
	M	E	L	A	_	_	_	6	ITALIANO
	M	E	L	A	_	_	_	7	SVENSKA
	M	E	L	A	_	_	_	8	JAPANESE
VIDEO SYSTEM SELECTION	M	E	S	Y	_	_	_	1	AUTO
	M	E	S	Y	_	_	_	2	PAL
	M	E	S	Y	_	_	_	3	SECAM
	M	E	S	Y	_	_	_	4	NTSC 4.43
	M	E	S	Y	_	_	_	5	NTSC 3.58
VIDEO IMAGE ADJUSTMENT	V	A	P	I	_	*	*	*	CONTRAST (-30 - +30)
	V	A	B	R	_	*	*	*	BRIGHT (-30 - +30)
	V	A	C	O	_	*	*	*	COLOR (-30 - +30)
	V	A	T	I	_	*	*	*	TINT (-30 - +30)
	V	A	S	H	_	*	*	*	SHARPNESS (-30 - +30)
	V	A	R	E	_	_	_	1	RESET
	W	B	R	D	_	*	*	*	RED (-30 - +30)
	W	B	B	E	_	*	*	*	BLUE (-30 - +30)
	V	A	R	E	_	_	_	0	VIDEO DISPLAY
	W	B	R	E	_	_	_	1	RESET
BACKGROUND SELECTION	I	M	B	G	_	_	_	1	SHARP IMAGE
	I	M	B	G	_	_	_	2	CUSTOM IMAGE
	I	M	B	G	_	_	_	3	BLUE BACK
	I	M	B	G	_	_	_	4	NONE
STARTUP IMAGE SELECTION	I	M	S	I	_	_	_	1	SHARP IMAGE
	I	M	S	I	_	_	_	2	CUSTOM IMAGE
	I	M	S	I	_	_	_	3	NONE
VOLUME ADJUSTMENT	V	O	L	A	_	_	*	*	VOLUME (00 - 60)
	M	U	T	E	_	_	_	0	MUTE OFF
	M	U	T	E	_	_	_	1	MUTE ON
AUDIO ADJUSTMENT	A	A	T	E	_	*	*	*	TREBLE (-30 - +30)
	A	A	B	A	_	*	*	*	BASS (-30 - +30)
	A	A	R	E	_	_	_	0	AUDIO DISPLAY
	A	A	R	E	_	_	_	1	RESET

CONTROL ITEM	COMMAND				PARAMETER				CONTROL CONTENTS	
	C1	C2	C3	C4	P1	P2	P3	P4		
COMPUTER 1 IMAGE ADJUSTMENT	R	A	P	I	_	*	*	*	CONTRAST (-30 - +30)	
	R	A	B	R	_	*	*	*	BRIGHT (-30 - +30)	
	R	A	R	D	_	*	*	*	RED (-30 - +30)	
	R	A	B	E	_	*	*	*	BLUE (-30 - +30)	
	R	A	R	E	_	_	_	0	COMPUTER 1 DISPLAY	
	R	A	R	E	_	_	_	1	RESET	
COMPUTER 2 IMAGE ADJUSTMENT	R	B	P	I	_	*	*	*	CONTRAST (-30 - +30)	
	R	B	B	R	_	*	*	*	BRIGHT (-30 - +30)	
	R	B	R	D	_	*	*	*	RED (-30 - +30)	
	R	B	B	E	_	*	*	*	BLUE (-30 - +30)	
COMPUTER INPUT AUTO SYNCHRONIZATION	R	B	R	E	_	_	_	0	COMPUTER 2 DISPLAY	
	R	B	R	E	_	_	_	1	RESET	
	A	A	D	J	_	_	_	0	AUTO SYNC OFF	
	A	A	D	J	_	_	_	1	AUTO SYNC ON	
COMPUTER INPUT ADJUSTMENT	A	D	J	S	_	_	_	1	AUTO SYNC START	
	I	N	C	L	_	*	*	*	CLOCK (-90 - +90)	
	I	N	P	H	_	*	*	*	PHASE (-60 - +60)	
	I	A	H	P	_	*	*	*	H-POS (-90 - +90)	
SCREEN SETTING	I	A	V	P	_	*	*	*	V-POS (-60 - +60)	
	I	A	R	E	_	_	_	0	COMPUTER INPUT DISPLAY	
	I	A	R	E	_	_	_	1	RESET	
	I	M	F	S	_	_	_	0	FIT TO SCREEN OFF	
VIDEO CONFIRMATION	I	M	F	S	_	_	_	1	FIT TO SCREEN ON	
	I	M	D	I	_	_	_	0	OSD DISPLAY OFF	
	I	M	D	I	_	_	_	1	OSD DISPLAY ON	
	I	M	R	E	_	_	_	0	REVERSE OFF	
	I	M	R	E	_	_	_	1	REVERSE ON	
	I	M	I	N	_	_	_	0	INVERT OFF	
	I	M	I	N	_	_	_	1	INVERT ON	
	I	M	A	S	_	_	_	0	AUTO SYNC DISPLAY OFF	
	I	M	A	S	_	_	_	1	AUTO SYNC DISPLAY ON	
	I	M	I	P	_	_	_	0	I/P CONVERSION OFF	
	I	M	I	P	_	_	_	1	I/P CONVERSION ON	
	S	Y	S	E	_	_	_	0	DISPLAY	
	BLACK SCREEN	I	M	B	K	_	_	_	0	BLACK SCREEN OFF
		I	M	B	K	_	_	_	1	BLACK SCREEN ON
I		M	B	O	_	_	_	0	BLACK SCREEN DISPLAY OFF	
I		M	B	O	_	_	_	1	BLACK SCREEN DISPLAY ON	
SCREEN MODE MEMORY	M	E	M	S	_	_	_	*	SELECT SETTING (1-7)	
	M	E	M	L	_	_	_	*	SAVE SETTING (1-7)	

NOTE

- If a dash (_) appears in the parameter column, enter a space. If an asterisk (*) appears, enter a value in the range indicated in brackets under CONTROL CONTENTS.
- COMPUTER INPUT ADJUSTMENT can only be set in the displayed computer mode.





Input Signals (Recommended Timing)

The computer output signal timing of different types of computer signals are shown below for reference.

For IBM and compatibles

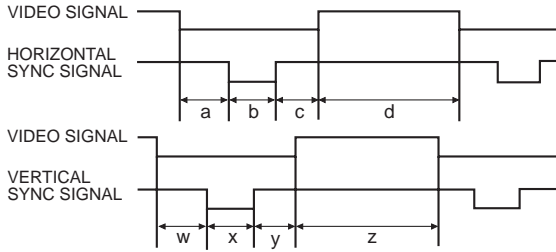

For Macintosh Series

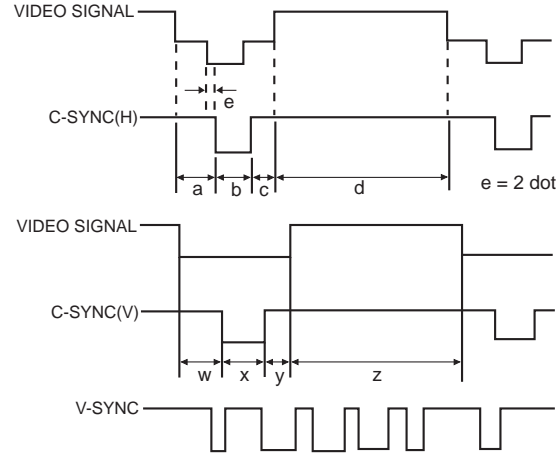

The following is a list of compatible VESA standards. Please note that this projector also accepts signals outside of the VESA standards.

NOTE

- Depending on the mode selected, the projector may clearly display images under 100 Hz.

	MODE	VIDEO		HSYNC										VSYNC														
				FRONT PORCH	SYNC	BACK PORCH	VIDEO PERIOD	1H		1dot	1H	1dot	LEVEL	SYNC POLARITY	FRONT PORCH	SYNC	BACK PORCH	VIDEO PERIOD	1V		1V	LEVEL	SYNC POLARITY					
				a	b	c	d	dot	μs	ns	kHz	MHz	+/-	H	H	H	H	H	ms	Hz	+/-							
IBM	VGA	VESA Standard	640	350	0.7 Vp-p 75 Ω load	R-G-B	32	64	96	640	832	26.413	31.7	37.861	31.500	TTL	+	32	3	60	350	445	11.754	85.080	-			
			640	400			32	64	96	640	832	26.413	31.7	37.861	31.500		-	1	3	41	400	445	11.754	85.080	+			
			720	400			36	72	108	720	936	26.366	28.2	37.927	35.500		-	1	3	42	400	446	11.759	85.039	+			
		640	480	16			40	120	640	832	26.413	31.7	37.861	31.500	-		1	3	20	480	520	13.735	72.809	-				
		640	480	16			64	120	640	840	26.667	31.7	37.500	31.500	-		1	3	16	480	500	13.333	75.000	-				
		800	600	40			128	88	800	1,056	26.400	25.0	37.879	40.000	+		1	4	23	600	628	16.579	60.317	+				
	800	600	16	80			160	800	1,056	21.333	20.2	46.875	49.500	+	1		3	21	600	625	13.333	75.000	+					
	800	600	32	64			152	800	1,048	18.631	17.8	53.674	56.250	+	1		3	27	600	631	11.756	85.061	+					
	800	600	8	176			56	1,024	1,264	28.151	22.3	35.522	44.900	+	0		4	20	768	817	23.000	43.479	+					
	1,024	768	24	136			144	1,024	1,328	17.707	13.3	56.476	75.000	-	3		6	29	768	806	14.272	70.069	-					
	1,024	768	48	96			208	1,024	1,376	14.561	10.6	68.677	94.500	+	1		3	36	768	808	11.765	84.997	+					
	1,152	864	64	128			256	1,152	1,600	14.815	9.3	67.500	108.000	+	1		3	32	864	900	13.333	75.000	+					
	1,280	960	96	112			312	1,280	1,800	16.667	9.3	60.000	108.000	+	1		3	36	960	1,000	16.667	60.000	+					
	SXGA	1,280	1,024	48			112	248	1,280	1,688	15.630	9.3	63.981	108.000	+		1	3	38	1,024	1,066	16.661	60.020	+				
		1,280	1,024	16			144	248	1,280	1,688	12.504	7.4	79.976	135.000	+		1	3	38	1,024	1,066	13.329	75.025	+				
	1,600	1,200	64	64			96	640	864	28.5714	33.0688	35.0000	30.2400	-	3		3	39	480	525	15.000	66.667	-					
	APPLE	Macintosh™ IIfx	13" Monitor	640			480	1 Vp-p max 75 Ω load	R-G-B C.SYNC	78	62	116	640	896	28.595		31.914063	34.971149	31.334149	-	3	3	39	480	525	15.000	66.667	-
			Macintosh™ LC	640			480	0.7 Vp-p max 75 Ω load		31	65	224	832	1,152	20.124		17.468	49.693	57.246	-	1	3	39	624	667	13.423	74.502	-
		Macintosh™	16" Monitor	832			624	0.7 Vp-p max 75 Ω load		35	96	173	1,024	1,328	16.650		12.538	60.0	79.76	-	3	3	30	768	804	13.387	74.70	-
			19" Monitor	1,024			768	0.7 Vp-p max 75 Ω load		36	128	140	1,152	1,456	14.5165		9.9701	68.8874	100.300	-	3	3	39	870	915	13.2826	75.2867	-
21" Monitor		1,152	870	0.7 Vp-p max 75 Ω load	R-G-B H.V.C.SYNC	36	128	140		1,152	1,456	14.5165	9.9701	68.8874	100.300	-	3	3	39	870	915	13.2826	75.2867	-				

NOTE

- This projector may not be able to display images from notebook computers in simultaneous (CRT/LCD) mode. Should this occur, turn off the LCD display on the notebook computer and output the display data in "CRT only" mode. Details on how to change display modes can be found in your notebook computer's operation manual.





Specifications

Product type	LCD Projector
Model	XG-NV5XU
Video system	PAL/SECAM/NTSC 3.58/NTSC 4.43
Display method	LCD panel × 3, RGB optical shutter method
LCD panel	Panel size: 0.9" (13.9 [H] × 18.5 [W] mm) Display method: Translucent TN liquid crystal panel Drive method: TFT (Thin Film Transistor) Active Matrix panel No. of dots: 786,432 dots (1,024 [H] × 768 [V])
Lens	1-1.5× zoom lens, F2.0-2.6, f = 37-55.5 mm
Projection lamp	AC 150 W lamp
Brightness (ANSI lumen)	600 ANSI lumens
Contrast ratio	200:1
Video input signal	RCA Connector: VIDEO, composite video, 1.0 Vp-p, sync negative, 75 Ω terminated RCA Connector: AUDIO, 0.5 Vrms more than 22 kΩ (stereo)
S-video input signal	4-pin mini DIN connector Y (luminance signal): 1.0 Vp-p, sync negative, 75 Ω terminated C (chrominance signal): Burst 0.286 Vp-p, 75 Ω terminated
Horizontal resolution	700 TV lines (video input)
Audio output	2 W (monaural)
Computer RGB input signal	<i>Video signal</i> 15-PIN MINI D-SUB CONNECTOR (Computer Input Port 1, 2): RGB separate/composite sync/sync on green type analog input: 0-0.7 Vp-p, positive, 75 Ω terminated STEREO MINIJACK: AUDIO, 0.5 Vrms, more than 22 kΩ (stereo) HORIZONTAL SYNC. SIGNAL: TTL level (positive/negative) or composite sync (Apple only) VERTICAL SYNC. SIGNAL: Same as above
Computer control signal	9-pin D-sub male connector (RS-232C Input Port)
Speaker system	3 ³ / ₃₂ " (8 cm) round
Rated voltage	AC 110-120/220-240 V
Input current	2.4 A/1.2 A
Rated frequency	50/60 Hz
Power consumption	270 W
Operating temperature	41°F to 104°F (+5°C to +40°C)
Storage temperature	-4°F to 140°F (-20°C to +60°C)
Cabinet	Plastic
I/R Carrier frequency	40 kHz
Laser Pointer of Remote Control	<i>Wave length:</i> 670 nm <i>Max. output:</i> 1 mW Class II Laser Product
Dimensions (approx.)	9 ¹ / ₆₄ " (W) × 4 ⁴⁹ / ₆₄ " (H) × 12 ¹³ / ₆₄ " (D) (229 × 121 × 310 mm) (main body only) 9 ¹⁹ / ₃₂ " (W) × 5 ³ / ₆₄ " (H) × 13 ¹⁷ / ₆₄ " (D) (243.5 × 128 × 337 mm) (including an adjustment foot and projecting parts)
Weight (approx.)	10.6 lbs. (4.8 kg)
Supplied accessories	"Power" remote control, Simple presentation remote control, Four AA size batteries, Two AAA size batteries, Power cord (9' 10", 3 m), Computer cable (9' 10", 3 m), Computer audio cable (9' 10", 3 m), Macintosh adaptor, Mouse control serial cable (3' 3", 1 m), Mouse control cable for IBM PS/2 (3' 3", 1 m), Mouse control cable for Mac (6 ⁴⁵ / ₆₄ ", 17 cm), Remote mouse receiver, Extra air filter, Lens cap (attached), Carrying bag, CD-ROM, LCD projector operation manual, LCD projector quick reference, Sharp Advanced Presentation Software operation manual, Sharp Advanced Presentation Software quick reference
Replacement parts	Lamp unit (Lamp/cage module) (BQC-XGNV5XU/1), "Power" remote control (RRMCG1470CESA), Simple presentation remote control (RRMCG1480CESA), AA size batteries (UBATU0025GEZZ), AAA size batteries (UBATU0026GEZZ), Power cord (CACCU5013CE01), Computer cable (QCNW-5108CEZZ), Computer audio cable (QCNW-4870CEZZ), Macintosh adaptor (QPLGJ1512CEZZ), Mouse control serial cable (QCNW-5112CEZZ), Mouse control cable for IBM PS/2 (QCNW-5113CEZZ), Mouse control cable for Mac (QCNW-5114CEZZ), Remote mouse receiver (RUNTK0648CEZZ), Air filter (PFILD0076CEZZ), Lens cap (GCOVH1307CESA), Carrying bag (GCASN0001CESA), CD-ROM (UDSKA-0001CE01), LCD projector operation manual (TINS-6583CEZZ), LCD projector quick reference (TINS-6598CEZZ), Sharp Advanced Presentation Software operation manual (TINS-6601CEZZ), Sharp Advanced Presentation quick reference (TINS-6676CEZZ)

This SHARP projector uses LCD (Liquid Crystal Display) panels. These very sophisticated panels contain 786,432 pixels (× RGB) TFTs (Thin Film Transistors). As with any high technology electronic equipment such as large screen TVs, video systems and video cameras, there are certain acceptable tolerances that the equipment must conform to.

This unit has some inactive TFTs within acceptable tolerances which may result in illuminated or inactive dots on the picture screen. This will not affect the picture quality or the life expectancy of the unit. If you have any questions about this matter, please call toll free 1-800-BE-SHARP (1-800-237-4277). U.S.A. ONLY

Specifications are subject to change without notice.



Dimensions

Rear View

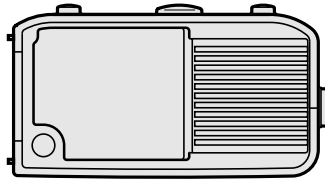

Top View

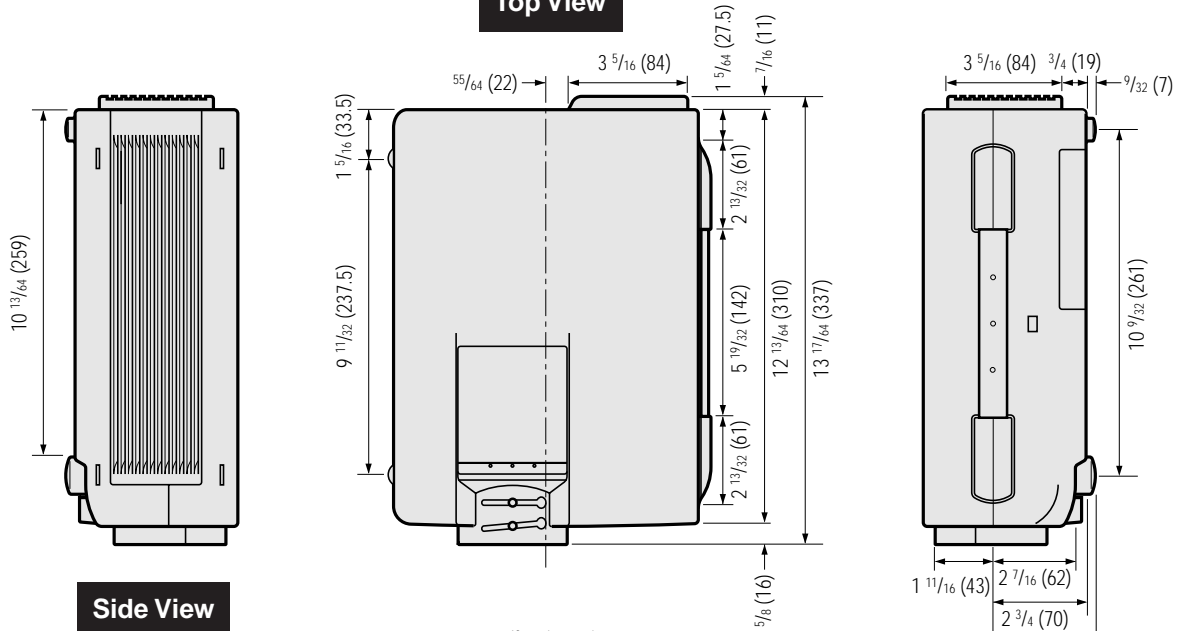

Side View

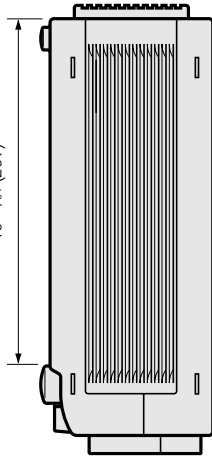

Front View

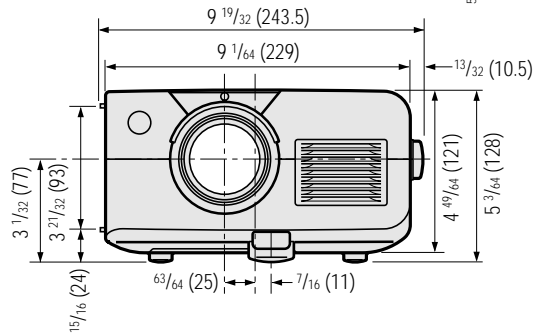

Bottom View

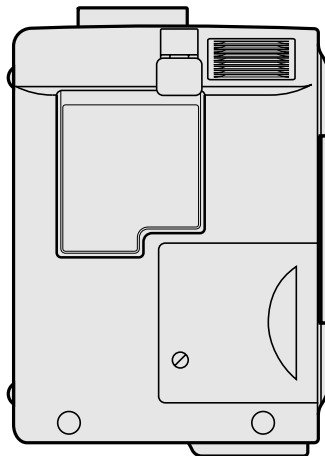

Units: inches (mm)





Guide to Effective Presentations

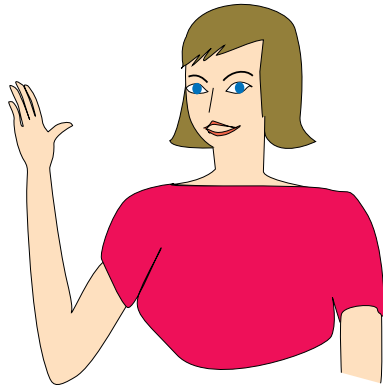

Electronic presentations are one of the most effective tools presenters can use to persuade an audience. There are several ways to enhance your presentation and maximize your effectiveness. The following are guidelines to help you create and deliver a dynamic presentation.

a. Types of Presentations

Computer Presentations

- To present basic information such as graphs, spreadsheets, documents and images, use word processing and spreadsheet applications.
- To convey more complex information and create more dynamic presentations which allow you to control the pace of your delivery, utilize software such as Astound®, Freelance®, Persuasion® or PowerPoint®.
- For high-end multimedia and interactive presentations, use software such as Macromedia Director®.

NOTE

- Astound®, Freelance®, Persuasion®, PowerPoint® and Macromedia Director® are trademarks of their respective companies.

Video Presentations

Use of video equipment, such as a VCR, DVD player and LD player, can be effective for delivering instructional or illustrative information that is difficult to present.

Digital Cameras and Personal digital Assistants (PDAs)

For highly compact and portable presentations, still cameras, digital video cameras, document cameras and PDAs are ideal for transferring data without cumbersome conversions.

Multimedia Presentations

You can integrate all of the above methods for a full multimedia presentation including video, audio, computer applications and World Wide Web information.

Wireless Presentations

Use any IrDA/IrTranP compatible source such as a laptop, digital camera or PDA to project still images quickly and effortlessly without the use of cables.

b. Creative Presentations

Oftentimes presenters do not take advantage of the many subtle ways they can manipulate their electronic slides to more effectively persuade the audience.

Color has a great effect on the audience during a presentation. When used correctly and legibly, studies show that background & foreground colors establish an emotional tone for a presentation, help viewers understand and retain information, and influence an audience to take a desired course of action.

Color Considerations

- Choose legible colors
- Text and graphics colors need sufficient contrast.
- Use darker colors for the background since a lighter background can create uncomfortable glare. (Yellow on black creates an ideal contrast.)

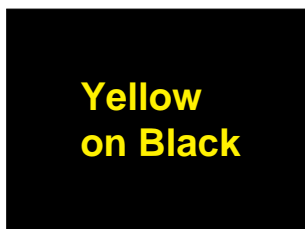
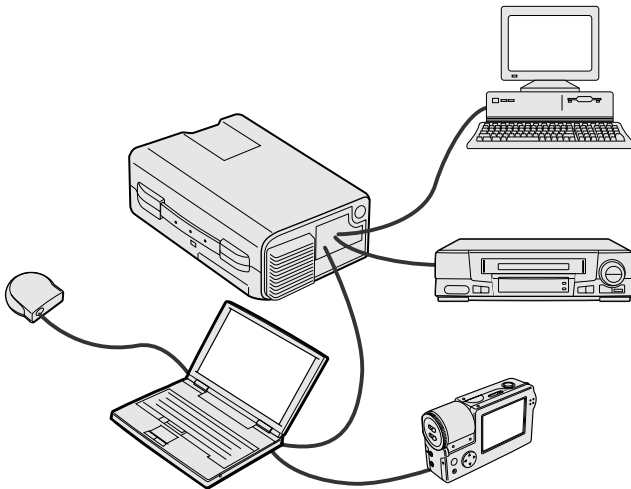
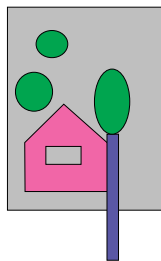
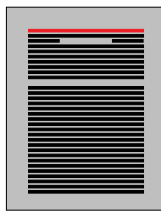
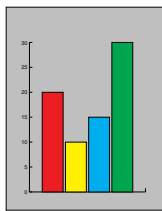

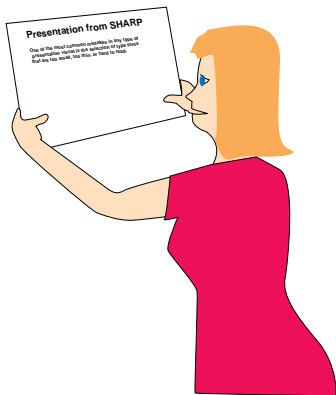
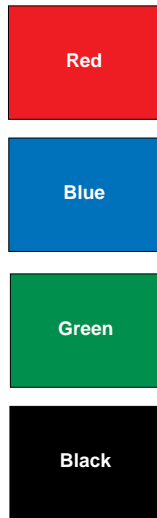

Sans-serif

Serif

- Background colors can subconsciously affect the audience:

Red—increases viewers' pulse and breathing and encourages risk taking but can also be associated with financial loss.

Blue—has a calming and conservative affect on the audience but can also create boredom among corporate audiences that are often inundated with this background color.

Green—stimulates interaction.

Black—conveys finality and certainty. Use it as a transitional color between slides when moving from one idea to another

- Foreground colors create a major impact on how well an audience understands and remembers a message.
 - Use one or two bright colors for emphasis.
 - Highlight important messages.
- The eye has a difficult time reading certain colored text on certain colored backgrounds. For example, text and background colors in red and green, and blue and black make for difficult viewing.
- Colorblind individuals may find it difficult to distinguish between red and green, brown and green, and purple and blue. Avoid using these colors together.

Fonts

- One of the most common mistakes in any type of presentation visual is the selection of type fonts that are too small, too thin, or too difficult to read.
- If you're not sure how well a given font will read on a screen at various sizes, try this: Draw a 6" × 8" box on a piece of paper and print out several lines of text inside the box with your computer printer at 300 or 600 dpi resolution. Vary the sizes of text to simulate headline, body and text call-outs for any charts or graphs. Hold the printout at arm's length. This is how your text will look on a 4 feet (1.2 meters)-wide screen at 10 feet (3 meters), on a 7.5 feet (2.3 meters)-wide screen at 20 feet (6.1 meters) and a 12 foot (3.7 meters)-wide screen at 30 feet (9.1 meters). If you cannot read the text easily, you should put less copy on your visuals or use larger typefaces.
- Design your visuals so that they are visible by the viewer in the last row.
- Nothing will ruin your presentation faster than misspelled words. Take the time to proofread and edit your work before your visuals become a permanent part of your presentation.
- Mixed case text is easier to read than text which is displayed in capital letters.
- Another important attribute of fonts is whether any particular face is serif or sans-serif. Serifs are small, usually horizontal cross strokes that are added to the end of a letter's main strokes. Because of their ability to coax the eye along the line of type, fonts with serifs are generally acknowledged to be more readable.



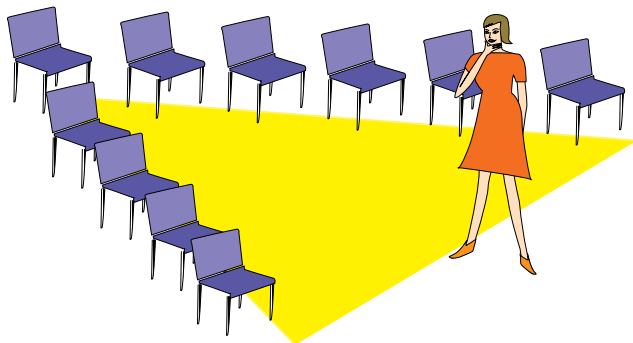
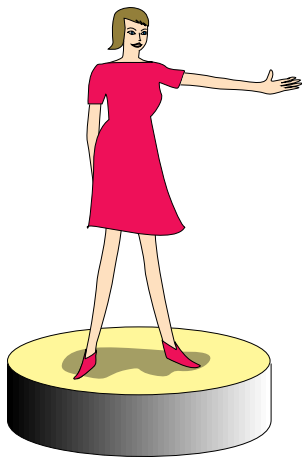
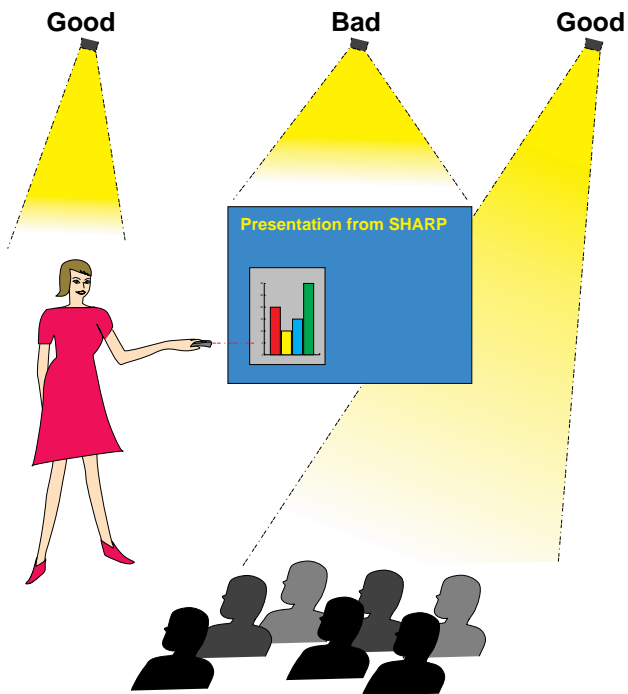

c. Set-Up

When giving a presentation, you need to set the stage both figuratively and literally for success. The way you set up a presentation room will have a great impact on the audience's perception of you and your message. By manipulating the placement and use of the following tools, you will improve the impact of your presentation.

Lighting—Good lighting is an important component of a successful presentation. You should strive to create an unequal distribution of light. An audience should always see as much of the presenter's face as possible, so most of the light should be focused on you. Because it is important for you to be able to read the audience's faces and body language, some light should be shed upon them. However, no light should shine on the screen.

Stage—When presenting on the same level surface that your audience is on, most people can only see the top one-third of your body. Therefore, it is recommended that when giving a presentation to an audience of 25 or more, you stand on a stage or platform. As more of your body is visible, the easier it is to communicate with an audience.

Podiums—The best presenters avoid podiums because they hide 75% of the body and restrict movement. However, many people feel more comfortable with a podium to hold their notes and hide their discomfort. If you must use a podium, angle it at 45 degrees to the audience so that you are not completely hidden.

Visuals—It is imperative that you make sure your visuals are large enough and projected far enough for the audience to see. Eight times the height of an image is the optimal viewing distance to read 24 point type. The bottom of a screen should be at least 6 feet (1.8 meters) above the floor.

Screen—The screen should always be in the center of the room so that all audience members can see it. Because people read from left to right, you should always stand to the audience's left when discussing visuals.

Seating—Arrange seating according to the dynamics of your presentation. If the presentation is more than half-a-day, use classroom style seating—a chair and a desk. If you would like to encourage audience interaction, use chevron seating, angling the chairs into a "V" shape. When you have a very small audience, a "U" shaped arrangement will increase interchange.





d. Rehearsing & Delivery

- The best time to rehearse is the day or evening before, not a couple of hours before, and the best place to rehearse is in the actual room. Rehearsing a speech in a small office is not the same as standing up in front of 100 people in a hotel ballroom or classroom.
- Due to varying processor speeds of computers, practice your slide transitions for proper timing.
- Whenever possible, set up your equipment well in advance to allow adequate time to resolve any unexpected issues such as lighting, power, seating and audio.
- Thoroughly check every piece of equipment you bring along. Make sure you have fresh batteries in your remote controls and laptop computer. Fully charge your computer's battery before the presentation and connect your AC adaptor for added safety.
- Make sure you are completely familiar with the control panel on your projector and remote controls.
- If you are using a microphone, check it out before hand and walk around to see where you might have problems with feedback. Avoid standing in these problem areas during your presentation.

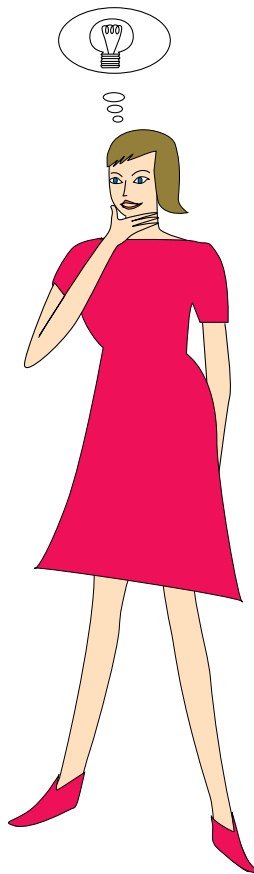

e. Presentation Tips

- Before beginning, visualize yourself delivering an outstanding presentation.
- Know your speech, memorizing at least the first three minutes of your presentation will allow you to focus on your rhythm and pacing.
- Speak to early arrivals to help you build a rapport with the audience and make you feel more comfortable.
- Don't be overly dependent on your visuals by reciting what your audience is already reading. Know your material well enough to be able to deliver the presentation with ease. Use your visuals to emphasize keypoints.
- Be sure to project your voice clearly and use eye contact to maintain audience attention.
- Do not wait until half way through your presentation to get your point across. If you wait and try to create a "build-up", you may lose some of your audience along the way.
- Keep your audience's attention. As most people only focus for 15 to 20 minutes during a one hour presentation, it is important to recapture their attention periodically. Use phrases like, "This is critical to my point" or "This is absolutely fundamental" to remind them you are saying something they need to hear.





Glossary

Aspect ratio

Width and height ratio of an image. The normal aspect ratio of a computer and video image is 4 : 3. There are also wide images with an aspect ratio of 16 : 9 and 21 : 9.

ANSI lumen

Brightness unit established by the American National Standards Institute.

Auto sync

Optimizes projected computer images by automatically adjusting certain characteristics.

Background

Initial setting image projected when no signal is being input.

Clock

Clock adjustment is used to adjust vertical noise when clock level is incorrect.

Compatibility

Ability to use with various image signal modes.

Composite sync

Signal combining horizontal and vertical sync pulses.

Digital keystone correction

Function to digitally correct a distorted image when the projector is set up at an angle.

Dot by dot mode

Mode that projects images in their native resolution.

Enlarge

Digitally zooms in on a portion of an image.

Fit to screen

Function to adjust an image without keeping a native aspect ratio other than 4 : 3, and project it in a 4 : 3 ratio.

Freeze

Function to freeze a moving image.

GUI

Graphical User Interface. User interface with graphics that allow easier operation.

I/P conversion

Function to convert an image between "Interlaced" and "Progressive" scan displays.

Intelligent compression

High quality resizing of lower and higher resolution images to fit the projector's native resolution.

IrCOM

Function to transmit still images from a computer, hand-held PC or digital still camera via infrared communication for "Wireless Presentations".

PDF

Portable Document Format. Documentation format used to transfer text and images from the CD-ROM.

Phase

Phase shift is a timing shift between isomorphic signals with the same resolution. When phase level is incorrect, the projected image typically displays horizontal flicker.

Presentation tools

Helpful tools used to emphasize keypoints throughout a presentation.

RS-232C

Function to control the projector from the computer by using the RS-232C ports on the projector and computer.

Startup image

The image displayed when the projector is turned on.

Status function

Displays the settings of each adjustment item.

Sync

Synchronizes the resolution and phase shift of two signals. When receiving an image with a resolution different from that of the computer, the projected image may be distorted.

Sync on green

Video signal mode of a computer which overlaps horizontal and vertical sync signal to green color signal pin.

Wireless mouse control

Function to operate the mouse control of the computer with the supplied remote control.

XGA resolution

The resolution with 1,024 × 768 pixels that uses the signal of an IBM/AT compatible (DOS/V) computer.





Index

A

AA size batteries	10
AC socket	18
ADJUSTMENT buttons	20
Air filter	37
Aspect ratio saving	31
Audio adjustment	25
AUDIO INPUT terminals	17
AUDIO OUTPUT terminal	17
Auto sync adjustment	27
AUTO SYNC button	27
Automatic power shutoff when receiving no signals	36

B

Background selection	32
BACKLIGHT button	11
BLACK SCREEN button	30

C

Carrying bag	41
Carrying handle	41
Ceiling-mount	13
Ceiling + Rear	34
Computer audio cable	15
COMPUTER AUDIO INPUT terminal	15
Computer cable	15
COMPUTER INPUT 1 port	15
COMPUTER INPUT 2 port	15
Cooling fan (Exhaust vent)	4
Cooling fan (Intake vent)	4

D

Dot by dot	29
------------------	----

E

ENLARGE button	29
ENTER button	20
Extra air filter	37

F

Fit to screen	31
Focus knob	18
Foot release	14
FREEZE button	33

G

GUI	20
-----------	----

I

Image memory	28
Image transmission software	22
INPUT SELECT button	19
Input signal confirmation	19
I/P conversion	31

K

Kensington Security Standard connector	40
KEYSTONE button	14

L

LAMP REPLACEMENT indicator	38
Language selection	23
LASER POINTER button	11
LEFT-CLICK button	11
Lens cap	41

M

Macintosh adaptor	16
MAIN POWER switch	18
MENU button	20
MOUSE/ADJUSTMENT switch	11
Mouse control cable for IBM PS/2	15
Mouse control cable for Mac	15
Mouse control serial cable	15
MUTE button	19

O

Opening image	33
---------------------	----

P

PDF	6
Picture adjustment	24
POWER buttons	18
Power cord	18
POWER indicator	18

R

Rear projection	12
Remote control	11
Remote control sensor	10
Remote mouse receiver	10
RIGHT-CLICK button	11
RS-232C port	15

S

Speaker	8
Startup image	33
Status confirmation	19
S-VIDEO INPUT terminal	17

T

TEMPERATURE WARNING indicator	38
TOOLS button	35

V

VIDEO INPUT terminal	17
VOLUME buttons	19

Z

Zoom knob	18
-----------------	----



SHARP CORPORATION

OSAKA, JAPAN

Printed in Japan
TINS-6583CEZZ
T2028-A
8P11-JWG

Free Manuals Download Website

<http://myh66.com>

<http://usermanuals.us>

<http://www.somanuals.com>

<http://www.4manuals.cc>

<http://www.manual-lib.com>

<http://www.404manual.com>

<http://www.luxmanual.com>

<http://aubethermostatmanual.com>

Golf course search by state

<http://golfingnear.com>

Email search by domain

<http://emailbydomain.com>

Auto manuals search

<http://auto.somanuals.com>

TV manuals search

<http://tv.somanuals.com>