

SHARP®

OPERATION MANUAL



MODEL PG-C20XE

LCD PROJECTOR



香港電器安全規格
(國際電工委員會規格適合)

Important
Information



Setup & Connections



Operation



Useful Features



Maintenance &
Troubleshooting



Appendix



This equipment complies with the requirements of Directives 89/336/EEC and 73/23/EEC as amended by 93/68/EEC.

Dieses Gerät entspricht den Anforderungen der EG-Richtlinien 89/336/EWG und 73/23/EWG mit Änderung 93/68/EWG.

Ce matériel répond aux exigences contenues dans les directives 89/336/CEE et 73/23/CEE modifiées par la directive 93/68/CEE.

Dit apparaat voldoet aan de eisen van de richtlijnen 89/336/EEG en 73/23/EEG, gewijzigd door 93/68/EEG.

Dette udstyr overholder kravene i direktiv nr. 89/336/EEC og 73/23/EEC med tillæg nr. 93/68/EEC.

Quest' apparecchio è conforme ai requisiti delle direttive 89/336/EEC e 73/23/EEC, come emendata dalla direttiva 93/68/EEC.

Η εγκατάσταση αυτή ανταποκρίνεται στις απαιτήσεις των οδηγιών της Ευρωπαϊκής Ένωσης 89/336/ΕΟΚ και 73/23/ΕΟΚ, όπως οι κανονισμοί αυτοί συμπληρώθηκαν από την οδηγία 93/68/ΕΟΚ.

Este equipamento obedece às exigências das directivas 89/336/CEE e 73/23/CEE, na sua versão corrigida pela directiva 93/68/CEE.



Este aparato satisface las exigencias de las Directivas 89/336/CEE y 73/23/CEE, modificadas por medio de la 93/68/CEE.

Denna utrustning uppfyller kraven enligt riktlinjerna 89/336/EEC och 73/23/EEC så som kompletteras av 93/68/EEC.

Dette produktet oppfyller betingelsene i direktivene 89/336/EEC og 73/23/EEC i endringen 93/68/EEC.

Tämä laite täyttää direktiivien 89/336/EEC ja 73/23/EEC vaatimukset, joita on muutettu direktiivillä 93/68/EEC.

SPECIAL NOTE FOR USERS IN THE U.K.

The mains lead of this product is fitted with a non-rewireable (moulded) plug incorporating a 13A fuse. Should the fuse need to be replaced, a BSI or ASTA approved BS 1362 fuse marked  or  and of the same rating as above, which is also indicated on the pin face of the plug, must be used.

Always refit the fuse cover after replacing the fuse. Never use the plug without the fuse cover fitted.

In the unlikely event of the socket outlet in your home not being compatible with the plug supplied, cut off the mains plug and fit an appropriate type.

DANGER:

The fuse from the cut-off plug should be removed and the cut-off plug destroyed immediately and disposed of in a safe manner.

Under no circumstances should the cut-off plug be inserted elsewhere into a 13A socket outlet, as a serious electric shock may occur.

To fit an appropriate plug to the mains lead, follow the instructions below:

IMPORTANT:

The wires in the mains lead are coloured in accordance with the following code:

Blue: Neutral

Brown: Live

As the colours of the wires in the mains lead of this product may not correspond with the coloured markings identifying the terminals in your plug, proceed as follows:

- The wire which is coloured blue must be connected to the plug terminal which is marked N or coloured black.
- The wire which is coloured brown must be connected to the plug terminal which is marked L or coloured red.

Ensure that neither the brown nor the blue wire is connected to the earth terminal in your three-pin plug.

Before replacing the plug cover make sure that:

- If the new fitted plug contains a fuse, its value is the same as that removed from the cut-off plug.
- The cord grip is clamped over the sheath of the mains lead, and not simply over the lead wires.

IF YOU HAVE ANY DOUBT, CONSULT A QUALIFIED ELECTRICIAN.

The supplied CD-ROM contains operation instructions in English, German, French, Swedish, Spanish, Italian, Dutch, Chinese, Korean and Arabic. Carefully read through the operation instructions before operating the LCD projector.

Die mitgelieferte CD-ROM enthält Bedienungsanleitungen in Englisch, Deutsch, Französisch, Schwedisch, Spanisch, Italienisch, Niederländisch, Chinesisch, Koreanisch und Arabisch. Bitte lesen Sie die Bedienungsanleitung vor der Verwendung des LCD-Projektors sorgfältig durch.

Le CD-ROM fourni contient les instructions de fonctionnement en anglais, allemand, français, suédois, espagnol, italien, néerlandais, chinois, coréen et arabe. Veuillez lire attentivement ces instructions avant de faire fonctionner le projecteur LCD.

Den medföljande CD-ROM-skivan innehåller bruksanvisningar på engelska, tyska, franska, svenska, spanska, italienska, holländska, kinesiska, koreanska och arabiska. Läs noga igenom bruksanvisningen innan projektorn tas i bruk.

El CD-ROM suministrado contiene instrucciones de operación en inglés, alemán, francés, sueco, español, italiano, holandés, chino, coreano y árabe. Lea cuidadosamente las instrucciones de operación antes de utilizar el proyector LCD.

Il CD-ROM in dotazione contiene istruzioni per l'uso in inglese, tedesco, francese, svedese, spagnolo, italiano, olandese, cinese, coreano e arabo. Leggere attentamente le istruzioni per l'uso prima di usare il proiettore LCD.

De meegeleverde CD-ROM bevat handleidingen in het Engels, Duits, Frans, Zweeds, Spaans, Italiaans, Nederlands, Chinees, Koreaans en Arabisch. Lees de handleiding zorgvuldig door voor u de LCD projector in gebruik neemt.

附送之CD-ROM光碟中，有用英文、德文、法文、瑞典文、西班牙文、意大利文、荷蘭文、中文、韓國文和阿拉伯文所寫的使用說明書。在操作液晶投影機之前，請務必仔細閱讀整本使用說明書。

제공된 CD-ROM에는 영어, 독일어, 프랑스어, 스웨덴어, 스페인어, 이탈리아어, 덴마크어, 중국어, 한국어, 그리고 아랍어로 작성된 조작 설명서가 포함되어 있습니다. LCD 프로젝터를 조작하기 전에 조작 지침을 상세하게 숙지하십시오.

تناسطوانة CD-ROM المجهّزة تتضمن تعليمات التشغيل لكل من اللغات الانجليزية، الالمانية، الفرنسية، السويدية، الاسبانية، الايطالية، الهولندية، الصينية، الكورية والعربية. قم بعناية بقراءة تعليمات التشغيل قبل تشغيل جهاز العرض الاسقاطي بشاشة الكريستال السائل.

Before using the LCD projector, please read this operation manual carefully.

OPERATION MANUAL

ENGLISH

IMPORTANT

For your assistance in reporting the loss or theft of your Colour LCD Projector, please record the Serial Number located on the bottom of the projector and retain this information. Before recycling the packaging, please be sure that you have checked the contents of the carton thoroughly against the list of "Supplied Accessories" on page 11.

Model No.: PG-C20XE

Serial No.:

WARNING:

Intense light source. Do not look into the beam or view it directly. Be especially careful that children do not look directly into the beam.

WARNING:

To reduce the risk of fire or electric shock, do not expose this appliance to liquids.

CAUTION:

To reduce the risk of electric shock, do not remove cabinet. No user-serviceable parts are inside. Refer servicing to qualified service personnel.

WARNING:

This is a class A product. In a domestic environment this product may cause radio interference in which case the user may be required to take adequate measures.

**WARNING:**

The cooling fan in this projector continues to run for about 90 seconds after the projector is turned off. During normal operation, when turning the power off always use the **ON/OFF** button on the projector or the **POWER** button on the remote control. Ensure the cooling fan has stopped before disconnecting the power cord. **DURING NORMAL OPERATION, NEVER TURN THE PROJECTOR OFF BY DISCONNECTING THE POWER CORD. FAILURE TO OBSERVE THIS WILL RESULT IN PREMATURE LAMP FAILURE.**

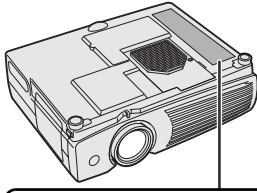
**Caution Concerning the Lamp Replacement**

See "Replacing the Projection Lamp" on pages 40 and 41.

**LAMP REPLACEMENT CAUTION**

BEFORE REMOVING THE SCREW, DISCONNECT POWER CORD. HOT SURFACE INSIDE. ALLOW 1 HOUR TO COOL BEFORE REPLACING THE LAMP. REPLACE WITH SAME SHARP LAMP UNIT. TYPE BQC-PGC20X//1 ONLY. UV RADIATION: CAN CAUSE EYE DAMAGE. TURN OFF LAMP BEFORE SERVICING. MEDIUM PRESSURE LAMP - RISK OF EXPLOSION. POTENTIAL HAZARD OF GLASS PARTICLES IF LAMP HAS RUPTURED. HANDLE WITH CARE. SEE OPERATION MANUAL.

**PRECAUTIONS A OBSERVER LORS DU REMPLACEMENT DE LA LAMPE.**

DEBRANCHER LE CORDON D'ALIMENTATION AVANT DE RETIRER LES VIS. L'INTERIEUR DU BOITIER ETANT EXTREMEMENT CHAUD, ATTENDRE 1 HEURE AVANT DE PROCEDER AU REMPLACEMENT DE LA LAMPE. NE REMPLACER QUE PAR UNE LAMPE SHARP DE TYPE BQC-PGC20X//1. RAYONS ULTRAVIOLETS: PEUVENT ENDOMMAGER LES YEUX. ETEINDRE LA LAMPE AVANT DE PROCEDER A L'ENTRETIEN. LAMPE A MOYENNE PRESSION: RISQUE D'EXPLOSION. DANGER POTENTIEL DE PARTICULES DE VERRE EN CAS D'ECLATEMENT DE LA LAMPE. A MANIPULER AVEC PRECAUTION, SE REPORTER AU MODE D'EMPLOI.

USER SERVICE SCREW
VIS POUR ENTRETIEN PAR L'UTILISATEUR ↓



Important Safeguards



ATTENTION: Please read all of these instructions before you operate your LCD Projector for the first time. Save these instructions for future reference.

For your own protection and prolonged operation of your LCD Projector, be sure to read the following “Important Safeguards” carefully, before use.

This projector has been engineered and manufactured to ensure your personal safety. But IMPROPER USE CAN RESULT IN POTENTIAL ELECTRICAL SHOCK OR FIRE HAZARDS. In order not to defeat the safeguards incorporated into this LCD Projector, observe the following basic rules for its installation, use and servicing.

1. Unplug the LCD Projector from the wall outlet before cleaning.
2. Do not use liquid cleaners or aerosol cleaners. Use a damp cloth for cleaning.
3. Do not use attachments not recommended by the LCD Projector manufacturer, as they may cause hazards.
4. Do not use the LCD Projector near water; for example, near a bathtub, washbowl, kitchen sink, laundry tub, in a wet basement, near a swimming pool, etc. Never spill liquid into the projector.
5. Do not place the LCD Projector on an unstable cart, stand, or table. The LCD Projector may fall, which may cause serious injury to a child or an adult, and/or serious damage to the unit.
6. Wall or Ceiling Mounting—The product should be mounted to a wall or ceiling only as recommended by the manufacturer.
7. LCD Projector equipment and cart combinations should be moved with care. Quick stops, excessive force, and uneven surfaces may cause the equipment and cart combination to overturn. 
8. Slots and openings in the cabinet back and bottom are provided for ventilation. To ensure reliable operation of the LCD Projector and to protect it from overheating, these openings must not be blocked or covered. The openings should never be covered with cloth or other material.
9. This LCD Projector should never be placed near or over a radiator or heating vent. The LCD Projector should not be placed in a built-in installation such as a bookcase unless proper ventilation is provided.
10. The LCD Projector should be operated only from the type of power source indicated on the back of the projector or in the specifications. If you are not sure of the type of power supplied to your home, consult your LCD Projector dealer or local power company.
11. Do not place the LCD Projector where the cord will be abused by persons walking on it.
12. Follow all warnings and instructions marked on the LCD Projector.
13. To prevent damage to the projector due to lightning and power-line surges, unplug the projector from the power outlet, when not in use.
14. Do not overload wall outlets and extension cords with too many products, because this can result in fire or electric shock.
15. Never push objects of any kind into the LCD Projector through the cabinet slots as they may touch high-voltage points or cause a short circuit. This could result in a fire or electric shock.
16. Do not attempt to service the LCD Projector yourself. Opening or removing covers may expose you to dangerous voltage or other hazards. Refer all servicing to qualified service personnel.
17. Unplug the LCD Projector equipment from the wall outlet and refer servicing to qualified service personnel under the following conditions:
 - a. When the power cord or plug is damaged or frayed.
 - b. If liquid has been spilled into the LCD Projector.
 - c. If the LCD Projector has been exposed to rain or water.
 - d. If the LCD Projector does not operate normally when you follow the operating instructions. Adjust only those controls that are covered by the operating instructions, as improper adjustment of other controls may cause damage and will often require extensive work by a qualified technician to restore the LCD Projector to normal operation.
 - e. If the LCD Projector has been dropped or the cabinet has been damaged.
 - f. When the LCD Projector exhibits a distinct change in performance—this indicates a need for service.
18. When replacement parts are required, be sure the service technician has used replacement parts specified by the manufacturer that have the same characteristics as the original parts. Unauthorised substitutions may result in fire, electric shock, or other hazards.
19. This LCD Projector is provided with one of the following types of plugs. If the plug should fail to fit into the power outlet, please contact your electrician.

Do not defeat the safety purpose of the plug.

 - a. Two-wire type mains plug.
 - b. Three-wire grounding type mains plug with a grounding terminal.
This plug will only fit into a grounding type power outlet.



Outstanding Features

1. **ADVANCED COMPATIBILITY WITH HIGH-END WORKSTATIONS AND PCS**

Compatible with up to 85 Hz vertical refresh rate, Sync on Green and **Composite Sync** signals for use with a wide variety of high-end PCs and Workstations. (Page 12)

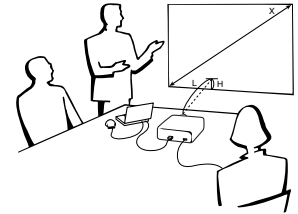

2. **3D DIGITAL UNIFORMITY**

Equipped with new 3D digital uniformity technology for a clearer, more uniform image.

3. **ACTIVE DIGITAL KEystone CORRECTION**

Corrects keystone distortion caused when the projected image is not perpendicular to the screen. This method provides not only horizontal correction, but vertical as well, thus maintaining the original 4:3 aspect ratio and eliminating jag lines. (Page 20)

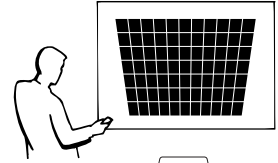

4. **EASY-TO-USE GRAPHICAL USER INTERFACE (GUI)**

A multi-colour menu system allows for simple image adjustments. (Page 23)

5. **AUTO SYNC TECHNOLOGY FOR AUTOMATIC IMAGE PERFECTION**

Automatically makes any necessary adjustments for perfectly synced computer images. (Page 28)

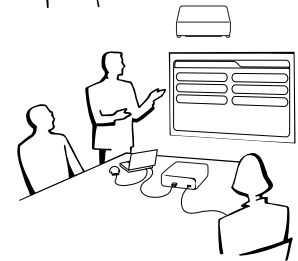

6. **INTELLIGENT COMPRESSION AND EXPANSION**

By using intelligent resizing technology, this projector can display higher and lower resolution images in detail without compromising quality. (Page 33)

7. **GAMMA CORRECTION FUNCTION**

Offers richer image viewing with dark scene phase and contrast correction according to image and room brightness. Three gamma settings are available. (Page 32)

8. **POWER SAVE MODE FUNCTION**

Function with toggle switch to control the quantity of projected light. Select "ON" or "OFF" to decrease or increase brightness, power consumption and fan noise. (Page 35)

9. **XGA RESOLUTION FOR HIGH RESOLUTION PRESENTATIONS**

With XGA (1,024 × 768) resolution, this projector can display very detailed presentation information.

10. **SXGA COMPATIBLE**

SXGA (1,280 × 1,024) resolution images are intelligently resized to 1,024 × 768 for full-screen.





Contents



Important Information

Important Safeguards	3
Outstanding Features	4
Contents	5
Usage Guidelines	6
How to Access the PDF Operation Manuals (for Windows and Macintosh)	7
Part Names	8



Setup & Connections

Supplied Accessories	11
Connecting the Projector	12



Operation

Basic Operations	16
Setting up the Screen	18
Operating the Wireless Mouse from the Remote Control	21
Using the GUI (Graphical User Interface) Menu Screens	23
Selecting the On-screen Display Language ...	26
Selecting the Video Input System Mode (INPUT 2 or 3 mode only)	26
Picture Adjustments	27
Computer Image Adjustments (INPUT 1 mode only)	28
Auto Sync Adjustment	28
Adjusting the Computer Image	29



Useful Features

Freeze Function	30
Digital Image Magnification	31
Gamma Correction	32
Selecting the Picture Display Mode	33
Checking the Input Signal and the Lamp Usage Time	34
Automatic Power Shutoff Function	34
Selecting a Background Image	35
Power Save Mode Function	35
Reverse/Invert Image Function	36
Special Mode Adjustment	36



Maintenance & Troubleshooting

Air Filter Maintenance	37
Lamp/Maintenance Indicators	39
Replacing the Projection Lamp	40
Using the Kensington Lock	42
Troubleshooting	42



Appendix

Attaching the Lens Cap	43
Connection Pin Assignments	44
RS-232C Port Specifications	45
Computer Compatibility Chart	47
Specifications	48
Dimensions	49
Glossary	50
Index	51





Usage Guidelines

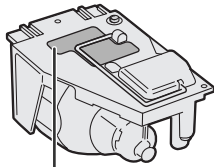

⚠ 高温注意
CAUTION
ATTENTION



Caution Concerning the Lamp Unit

Potential hazard of glass particles if lamp ruptures. Please have Sharp Authorised LCD Projector Dealer or Service Centre replace lamp if rupture occurs. See "Replacing the Projection Lamp" on pages 40 and 41.

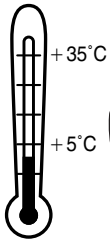

Cautions Concerning the Setup of the Projector

For minimal servicing and to maintain high image quality, SHARP recommends that this projector be installed in an area free from humidity, dust and cigarette smoke. If the projector is used in these environments, the lens and filter will need to be cleaned (or the filter replaced) more often, and internal cleaning may become necessary. As long as the projector is regularly cleaned, use in these environments will not reduce the overall operation life of the unit. Internal cleaning should only be performed by a Sharp Authorised LCD Projector Dealer or Service Centre.

- Do not expose the projector to extreme heat or cold.
Operating temperature: +5°C to +35°C
Storage temperature: -20°C to +60°C

Notes on Operation

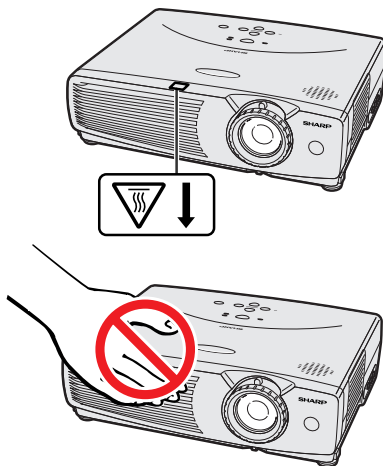

- The mark shown on the left calls the user's attention to a part of the projector that emits intense heat during operation.
- The exhaust vent, the lamp cage cover and adjacent areas may be extremely hot during projector operation. To prevent injury, do not touch these areas until they have sufficiently cooled.
- Allow at least 10 cm of space between the cooling fan (exhaust vent) and the nearest wall or obstruction.
- If the cooling fan becomes obstructed, a protection device will automatically turn off the projector lamp. This does not indicate a malfunction. Remove the projector power cord from the wall outlet and wait at least 10 minutes. Then turn on the power by plugging the power cord back in. This will return the projector to the normal operating condition.

Temperature Monitor Function

If the projector starts to overheat due to setup problems or a dirty air filter, "TEMP." will appear in the lower-left corner of the picture. If the temperature continues to rise, the lamp will turn off, the TEMPERATURE WARNING indicator on the projector will flash, and after a 90-second cooling-off period the power will shut off. Refer to "Lamp/Maintenance Indicators" on page 39, for details.

NOTE

- The cooling fan regulates the internal temperature, and its performance is automatically controlled. The sound of the fan may change during projector operation due to changes in the fan speed.



Lamp Monitor Function

When the projector is turned on after the lamp has been used for 900 hours, "LAMP" will appear in the lower-left corner of the picture to advise you to replace the lamp. See pages 40 and 41 for lamp replacement. If the lamp has been used for 1,000 hours, the projector power will automatically turn off and the projector will enter standby mode. Refer to "Lamp/Maintenance Indicators" on page 39, for details.





How to Access the PDF Operation Manuals (for Windows and Macintosh)



PDF operation manuals in several languages are included in the CD-ROM. To utilize these manuals, you need to install Adobe Acrobat Reader on your PC (Windows or Macintosh). If you have not installed Acrobat Reader yet, you can download it from the Internet (<http://www.adobe.com>) or install it from the CD-ROM.

To Install Acrobat Reader from the CD-ROM

For Windows:

- ① Insert the CD-ROM in the CD-ROM drive.
- ② Double click on the "My Computer" icon.
- ③ Double click on the "CD-ROM" drive.
- ④ Double click on the "manuals" folder.
- ⑤ Double click on the "acrobat" folder.
- ⑥ Double click on the "windows" folder.
- ⑦ Double click on the desired installation programme and follow the instructions on the screen.

For Macintosh:

- ① Insert the CD-ROM in the CD-ROM drive.
- ② Double click on the "CD-ROM" icon.
- ③ Double click on the "manuals" folder.
- ④ Double click on the "acrobat" folder.
- ⑤ Double click on the "mac" folder.
- ⑥ Double click on the desired installation programme and follow the instructions on the screen.

For other operating systems:

Please download Acrobat Reader from the Internet (<http://www.adobe.com>).

For other languages:

If you prefer using Acrobat Reader for languages other than those included in the CD-ROM, please download the appropriate version from the Internet.

Accessing the PDF Manuals

For Windows:

- ① Insert the CD-ROM in the CD-ROM drive.
- ② Double click on the "My Computer" icon.
- ③ Double click on the "CD-ROM" drive.
- ④ Double click on the "manuals" folder.
- ⑤ Double click on the "pg-c20xe" folder.
- ⑥ Double click on the language (name of the folder) that you want to view.
- ⑦ Double click on the "c20" pdf file to access the projector manuals.
- ⑧ Double click on the pdf file.

For Macintosh:

- ① Insert the CD-ROM in the CD-ROM drive.
- ② Double click on the "CD-ROM" icon.
- ③ Double click on the "manuals" folder.
- ④ Double click on the "pg-c20xe" folder.
- ⑤ Double click on the language (name of the folder) that you want to view.
- ⑥ Double click on the "c20" pdf file to access the projector manuals.
- ⑦ Double click on the pdf file.

NOTE

- If the desired pdf file cannot be opened by double clicking the mouse, start Acrobat Reader first, then specify the desired file using the "File", "Open" menu.
- See the "readme.txt" file on the CD-ROM for important information on the CD-ROM not included in this operation manual.



Part Names

Numbers next to the part names refer to the main pages in this manual where the topic is explained.

Projector

Front and Top View

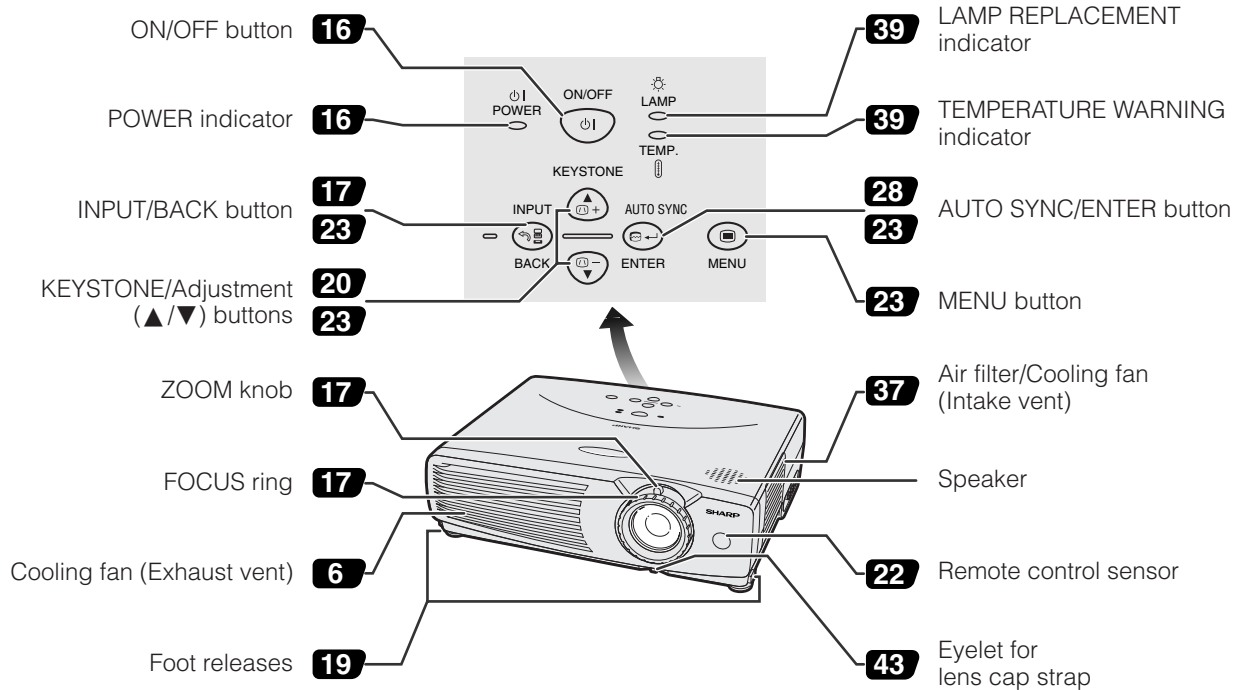

Side and Rear View

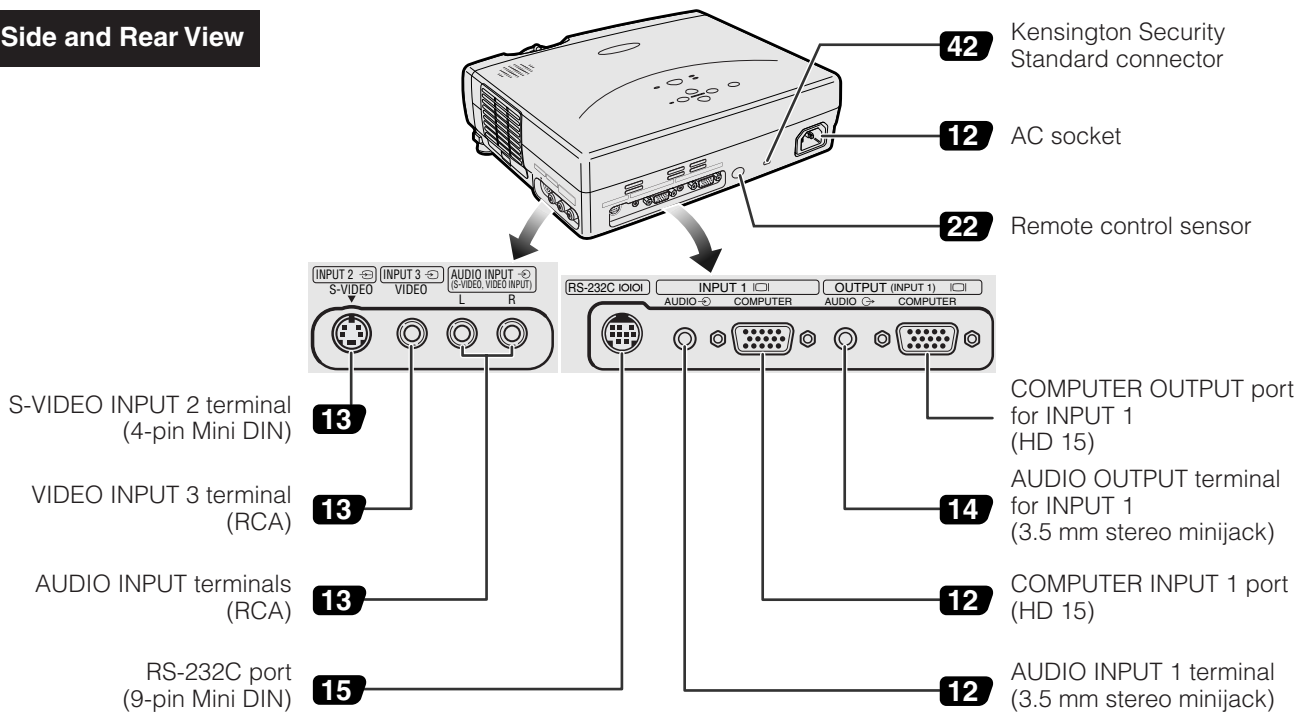



Remote Control

Front View

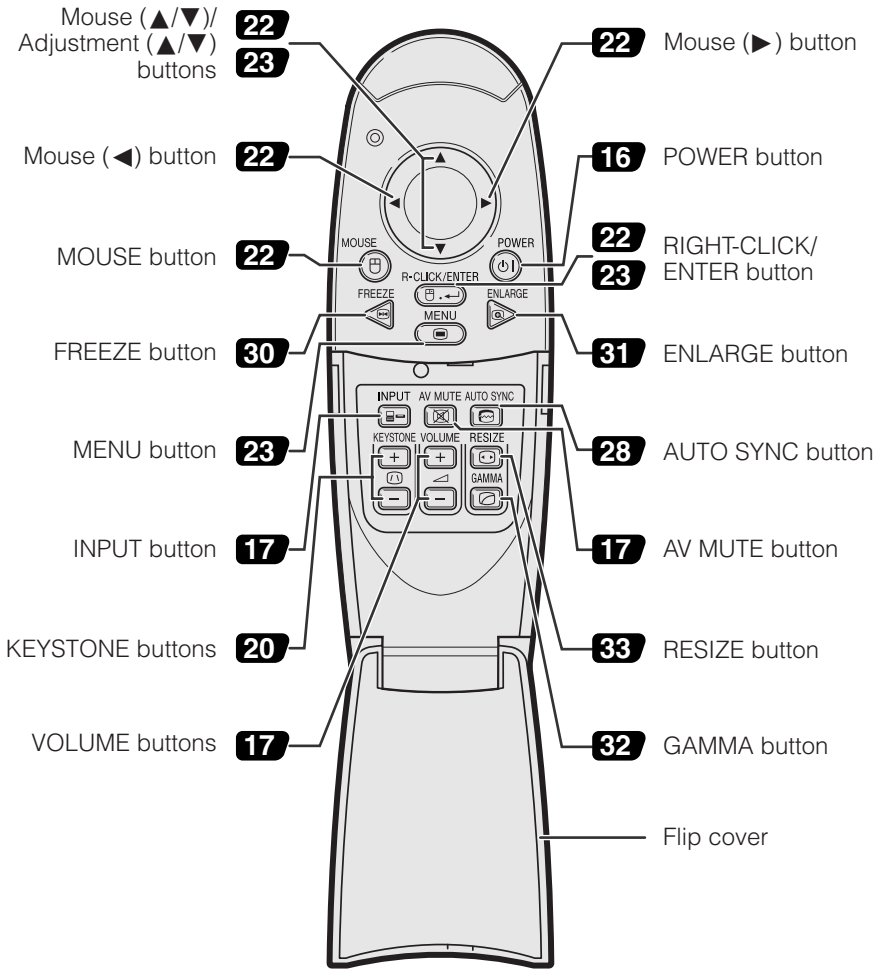

Rear View

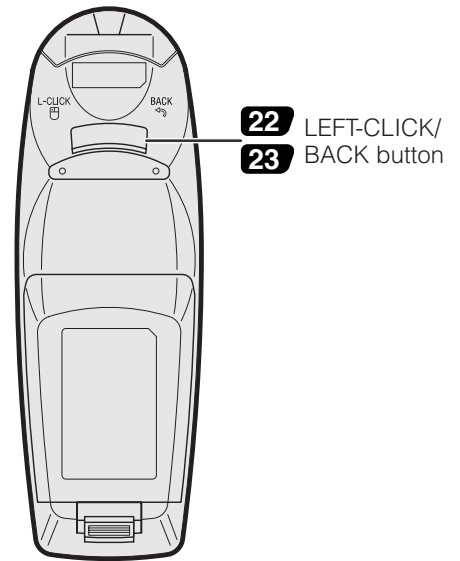

Opening the Flip Cover

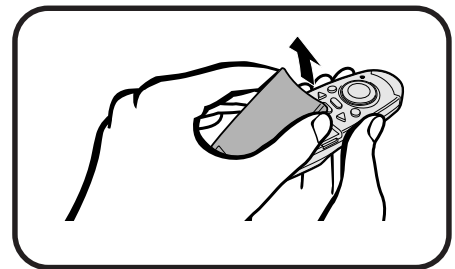

Inserting the Batteries

<p>1 Press the tab and lift open the battery cover in the direction of the arrow.</p>	<p>2 Insert two AAA size batteries, making sure their polarities match the + and - marks inside the battery compartment.</p>	<p>3 Insert the tabs on the end of the battery cover into their slots and press the cover into position.</p>

NOTE

- If the remote control gets wet, wipe it dry immediately.
- Avoid excessive heat and humidity.
- If you will not be using the remote control for a long time, remove the batteries.
- Do not mix new and old or different types of batteries.
- There are operations that can only be carried out by remote control. Handle the remote control carefully.





Setup & Connections





Supplied Accessories



Remote control



Two AAA size batteries

Power cord

For Europe, Hong Kong and Singapore

For Australia, New Zealand, and Oceania

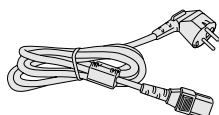

(For Europe, except U.K.)

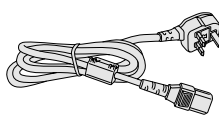

(For U.K., Hong Kong and Singapore)

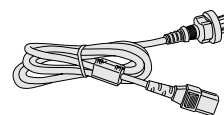

NOTE

- The configuration of wall outlets differs from country to country. Use the power cord that corresponds to the wall outlet in your country.

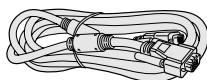

Computer RGB cable

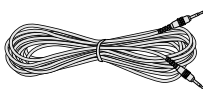

Computer audio cable

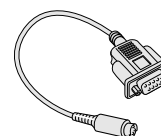

DIN-D-sub RS-232C cable

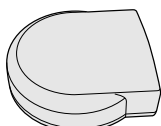

Remote mouse receiver

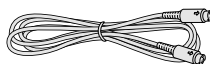

PS/2 mouse control cable

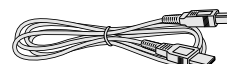

USB mouse control cable

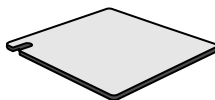

Extra air filter



Lens cap



Lens cap strap

CD-ROM

LCD projector quick reference guides

LCD projector operation manual



Connecting the Projector

Connecting the Power Cord

Plug the supplied power cord into the AC socket on the back of the projector.

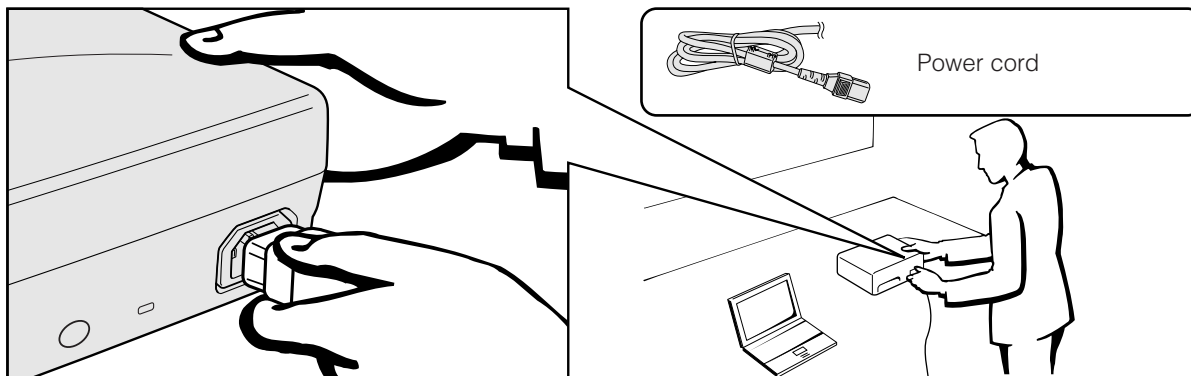

CAUTION

- Make sure you connect the power cord firmly into the AC socket.

NOTE

- The configuration of wall outlets differs from country to country. Use the power cord that corresponds to the wall outlet in your country.

Connecting the Projector to a Computer

You can connect your projector to a computer for projection of full colour computer images.

Connecting a computer using the standard 15-pin input

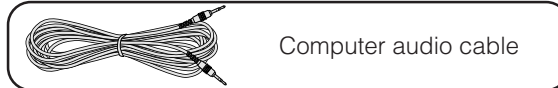
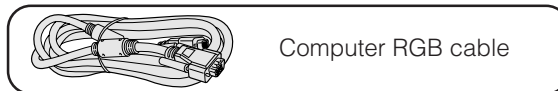
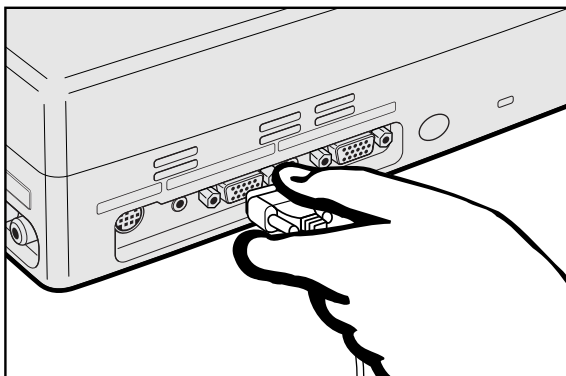

- ① Connect one end of the supplied computer RGB cable to the COMPUTER INPUT 1 port on the projector.
- ② Connect the other end to the Monitor output port on the computer. Secure the connectors by tightening the thumb screws.
- ③ To use the built-in audio system, connect one end of the supplied computer audio cable to the AUDIO INPUT 1 terminal on the projector.
- ④ Connect the other end to the Audio output terminal on the computer.

CAUTION

- Before connecting, be sure to turn both the projector and the computer off. After making all connections, turn the projector on first. The computer should always be turned on last.

NOTE

- Please read the computer's operation manual carefully.
- Refer to page 47 "Computer Compatibility Chart" for a list of computer signals compatible with the projector. Use with computer signals other than those listed may cause some of the functions not to work.
- A Macintosh adaptor may be required for use with some Macintosh computers. Contact your nearest Sharp Authorised LCD Projector Dealer or Service Centre.

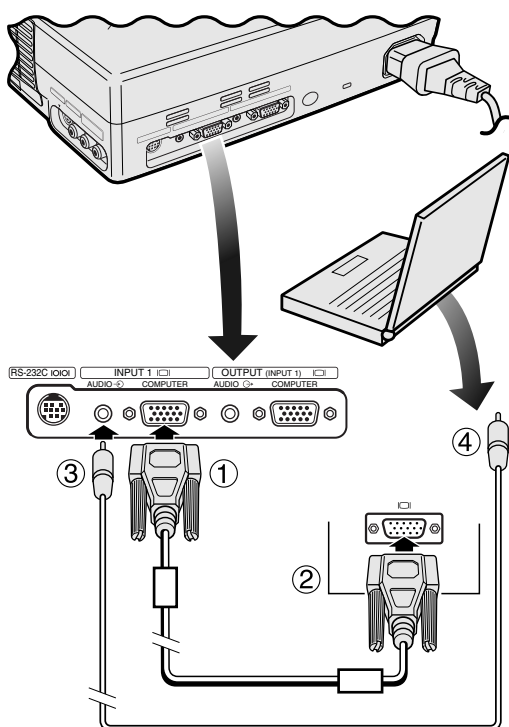



Connecting the Projector

Connecting other compatible computers

When connecting the projector to a compatible computer other than an IBM-PC (VGA/SVGA/XGA/SXGA) or Macintosh (i.e. Workstation), a separate cable may be needed. Please contact your dealer for more information.

NOTE

- Connecting computers other than the recommended types may result in damage to the projector, the computer, or both.

“Plug and Play” function

- This projector is compatible with VESA-standard DDC 1/DDC 2B. The projector and a VESA DDC compatible computer will communicate their setting requirements, allowing for quick and easy setup.
- Before using the “Plug and Play” function, be sure to turn on the projector first and the connected computer last.

NOTE

- The DDC, Plug and Play function of this projector operates only when used in conjunction with a VESA DDC compatible computer.

Connecting the Projector to Video Equipment

You can connect your projector to a VCR, laser disc player, DVD player, DTV* decoder and other audiovisual equipment.

CAUTION

- Always turn off the projector while connecting to audiovisual equipment, in order to protect both the projector and the equipment being connected.

Connecting a video source (VCR, laser disc player, DTV decoder or DVD player) using the standard video input

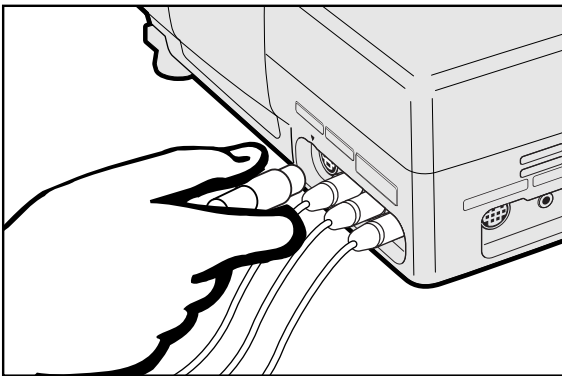

- ① Connect one end of the S-video cable to the S-VIDEO INPUT 2 terminal, or one end of the video cable to the VIDEO INPUT 3 terminal on the projector and the video output terminal on the video source.
- ② To use the built-in audio system, connect the red and white RCA connectors to the corresponding red and white AUDIO INPUT terminals on the projector and the audio output terminals on the video source.

The S-VIDEO INPUT 2 terminal uses a video signal system in which the picture is separated into a colour and a luminance signal to realise a higher-quality image.

NOTE

- For higher quality video, you may use the S-VIDEO INPUT 2 terminal on the projector. S-video cable is sold separately.
- If your video equipment does not have an S-video output terminal, use the composite video output terminal.

Projector

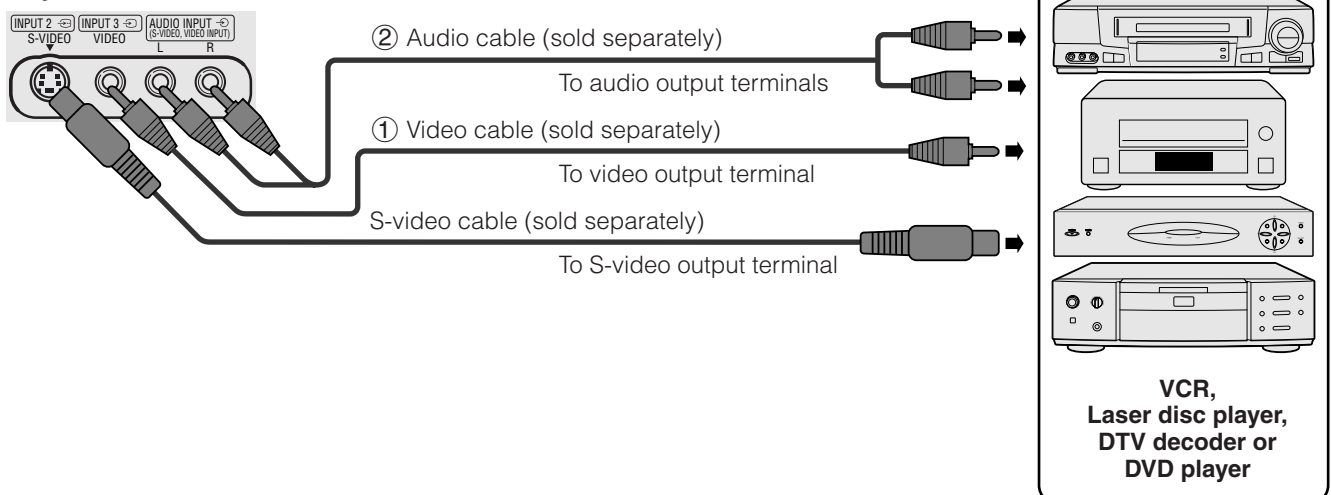

*DTV is the umbrella term used to describe the new digital television system in the united states.



Connecting the Projector

Connecting a video source (DTV decoder or DVD player) using the 15-pin input

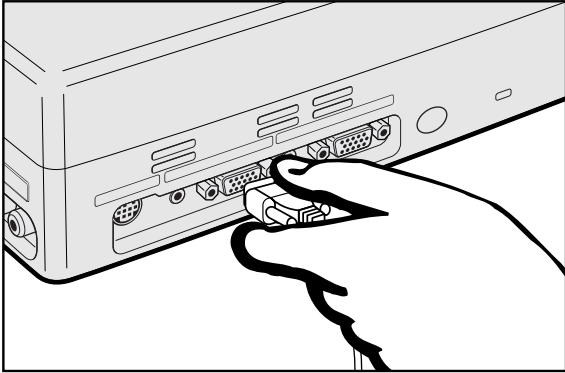

- ① Connect one end of the HD-15/RCA cable or the HD-15-RGB cable to the COMPUTER INPUT 1 port on the projector.
- ② Connect the other end to the corresponding terminals on the video source.
- ③ To use the built-in audio system, connect one end of the audio cable to AUDIO INPUT 1 terminal on the projector. Connect the other end to the audio output terminals on the video source.

NOTE

- The projector can only accept 480P DTV signals through COMPUTER INPUT 1 terminal. Therefore, set your DTV to RGB monitor output.
- The image quality may become lower depending on DTV signal compatibility.

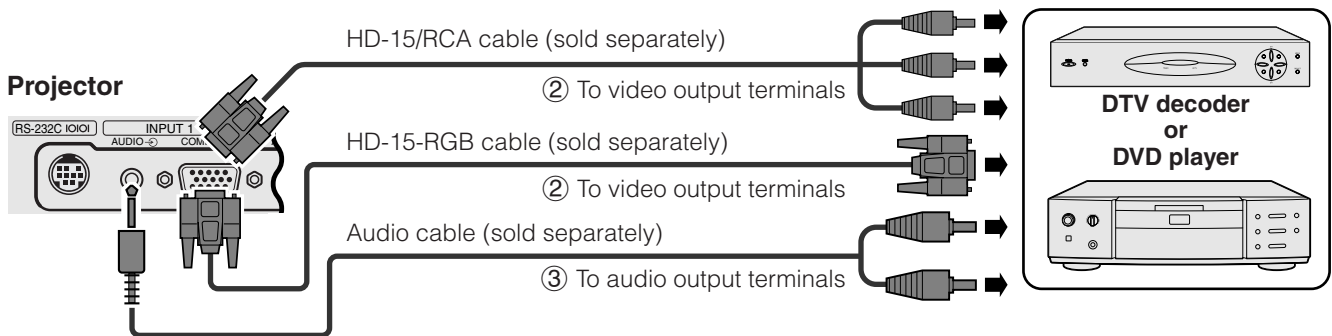

Connecting an amplifier and other audio components

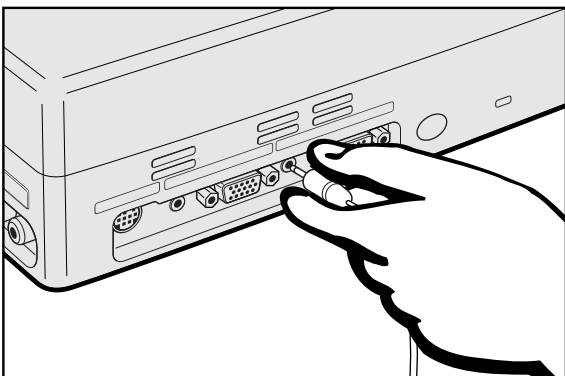

- ① Connect one end of the audio cable to the AUDIO OUTPUT terminal for INPUT 1 on the projector.
- ② Connect the other end to the corresponding terminals on the audio components.

CAUTION

- Always turn off the projector while connecting to audio components, in order to protect both the projector and the components being connected.

NOTE

- By using external audio components, the volume can be amplified for better sound.
- The AUDIO OUTPUT terminal for INPUT 1 allows you to output audio to audio components from the AUDIO INPUT 1 terminal connected to audiovisual equipment.

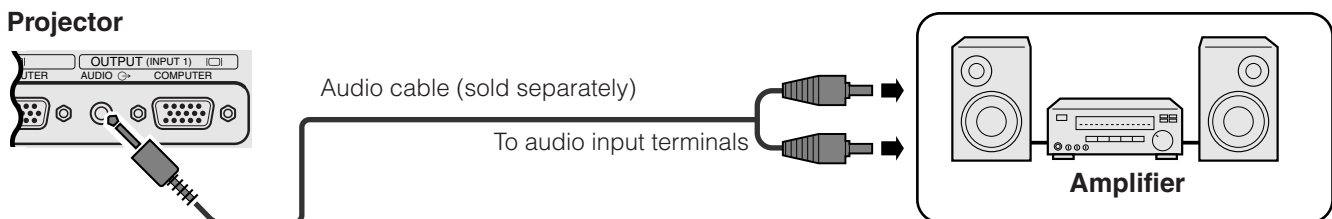



Connecting RS-232C Port

When the RS-232C port on the projector is connected to a computer with an RS-232C cable (null modem, cross type, sold separately), the computer can be used to control the projector and check the status of the projector. See pages 45 and 46 for details.

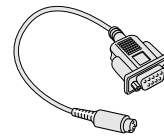

DIN-D-sub RS-232C cable

- ① Connect the supplied DIN-D-sub RS-232C cable to the RS-232C port on the projector.
- ② Connect an RS-232C cable (null modem, cross type, sold separately) to the other end of DIN-D-sub RS-232C cable and to the serial port on the computer.

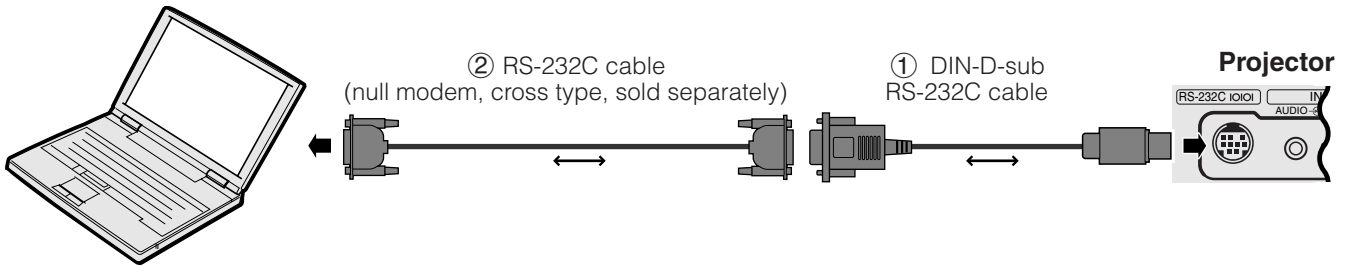

CAUTION

- Do not connect or disconnect an RS-232C cable to or from the computer while it is on. This may damage your computer.

NOTE

- The wireless mouse or RS-232C function may not operate if your computer port is not correctly set up. Please refer to the operation manual of the computer for details on setting up/installing the correct mouse driver.
- A Macintosh adaptor may be required for use with some Macintosh computers. Contact your nearest Sharp Authorised LCD Projector Dealer or Service Centre.





Operation

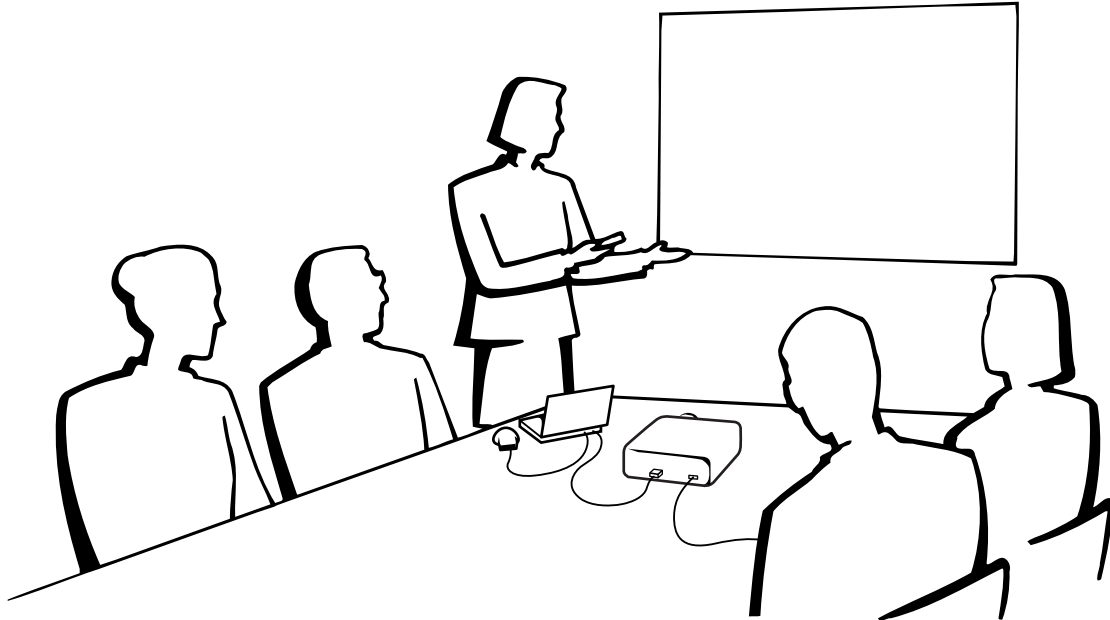

Basic Operations

Maintenance indicators

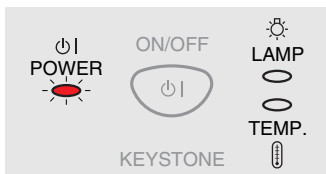

Projector

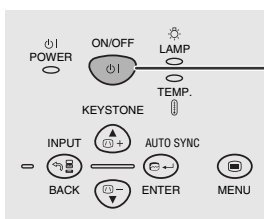

Remote control

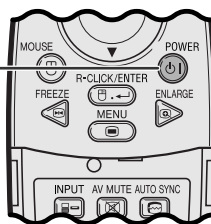

②

Maintenance indicators

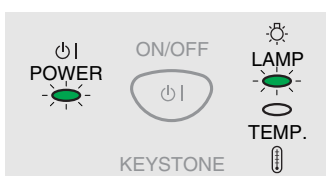

- ① Make the necessary connections before proceeding. Connect the power cord to a wall outlet. The POWER indicator illuminates red and the projector enters standby mode.

NOTE

- If the side filter cover is not securely installed, the POWER indicator flashes.

- ② Press **ON/OFF** on the projector or **POWER** on the remote control for over one second.

NOTE

- The flashing green LAMP REPLACEMENT indicator shows that the lamp is warming up. Wait until the indicator stops flashing before operating the projector.
- The power cannot be turned off for one minute after the power is turned on.
- If the power is turned off and then immediately turned on again, it may take a short while before the lamp turns on.
- After the projector is unpacked and turned on for the first time, a slight odour may be emitted from the exhaust vent. This odour will soon disappear with use.
- Do not press any buttons before the startup image disappears. Before "Adjusting The Image" appears, only **ON/OFF** or **POWER** is available.

When the power is on, the LAMP REPLACEMENT indicator lights indicating the status of the lamp.

- Green:** Lamp is ready.
- Flashing green:** Warming up.
- Red:** Change the lamp.



Basic Operations

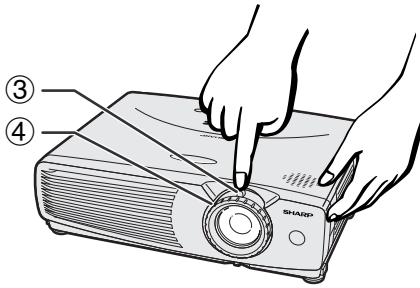

- ③ Slide the ZOOM knob. The image can be adjusted to the desired size within the zoom range.
- ④ Rotate the FOCUS ring until the image on the screen becomes clear.

Projector

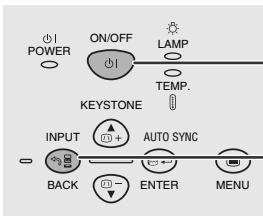

Remote control

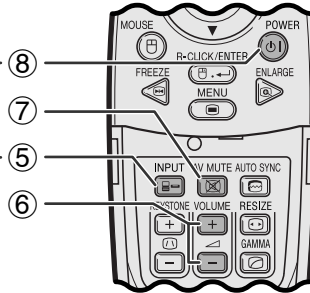

- ⑤ Press **INPUT** to select the desired input mode. Press **INPUT** again to change the mode.

NOTE

- When the selected input signal is being received, "Adjusting The Image" will be displayed.
- When no signal is being received, "NO SIGNAL" will be displayed. When a signal that the projector is not preset to receive is being received, "NOT REG." will be displayed.

- ⑥ Press **VOLUME** on the remote control to adjust the volume.

- ⑦ Press **AV MUTE** on the remote control to temporarily turn off the picture and the sound. Press **AV MUTE** again to turn the picture and the sound back on.

- ⑧ Press **ON/OFF** on the projector or **POWER** on the remote control for over one second. Press **ON/OFF** or **POWER** again while the message is displayed.

NOTE

- If you accidentally pressed **ON/OFF** or **POWER** and do not want to turn off the power, wait until the power off screen disappears.
- When **ON/OFF** or **POWER** is pressed twice, the POWER indicator will light up red and the cooling fan will run for about 90 seconds. The projector will then enter standby mode.
- Wait until the cooling fan stops before disconnecting the power cord.
- The power can be turned on again by pressing **ON/OFF** or **POWER**. When the power is turned on, the POWER indicator and the LAMP REPLACEMENT indicator light green.
- The POWER indicator flashes if the right side filter cover is not securely installed.

WARNING:

The cooling fan in this projector continues to run for about 90 seconds after the projector is turned off. During normal operation, when turning the power off always use the **ON/OFF** button on the projector or the **POWER** button on the remote control. Ensure the cooling fan has stopped before disconnecting the power cord. DURING NORMAL OPERATION, NEVER TURN THE PROJECTOR OFF BY DISCONNECTING THE POWER CORD. FAILURE TO OBSERVE THIS WILL RESULT IN PREMATURE LAMP FAILURE.

EXAMPLE

- ⑤ **INPUT 1 (RGB) Mode**

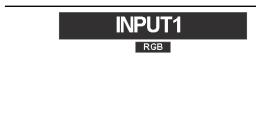

- INPUT 1 (COMPONENT) Mode**

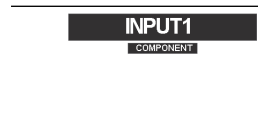

- INPUT 3 (VIDEO) Mode**



- INPUT2 (S-VIDEO) Mode**

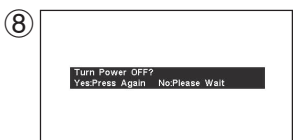
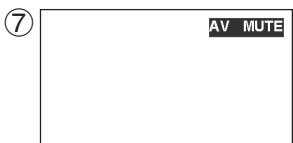
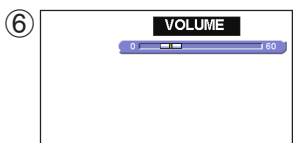



Setting up the Screen

Position the projector perpendicular to the screen with all feet flat and level to achieve an optimal image. Move the projector forward or backward if the edges of the image are distorted.

NOTE

- The projector lens should be centred in the middle of the screen. If the lens centre is not perpendicular to the screen, the image will be distorted, making viewing difficult.
- Position the screen so that it is not in direct sunlight or room light. Light falling directly onto the screen washes out colours, making viewing difficult. Close the curtains and dim the lights when setting up the screen in a sunny or bright room.
- A polarizing screen cannot be used with this projector.

Standard Setup (Front Projection)

Place the projector at the required distance from the screen according to the desired picture size. (See the table below.)

NORMAL Mode (4:3)

Picture size (diag.) (x)	Projection distance (L)		Distance from the lens centre to the bottom of the image (H)
	Maximum	Minimum	
635 cm (250")	10.0 m	9.9 m	38.1 cm
508 cm (200")	9.6 m	7.9 m	30.5 cm
381 cm (150")	7.2 m	5.9 m	22.9 cm
254 cm (100")	4.8 m	3.9 m	15.2 cm
213 cm (84")	4.0 m	3.3 m	12.8 cm
183 cm (72")	3.4 m	2.8 m	11.0 cm
152 cm (60")	2.8 m	2.3 m	9.1 cm
102 cm (40")	1.9 m	1.6 m	6.1 cm

STRETCH Mode (16:9)

Picture size (diag.) (x)	Projection distance (L)		Distance from the lens centre to the bottom of the image (H)
	Maximum	Minimum	
572 cm (225")	10.0 m	9.8 m	-9.3 cm
508 cm (200")	10.0 m	8.7 m	-8.3 cm
381 cm (150")	7.8 m	6.5 m	-6.2 cm
338 cm (133")	6.9 m	5.7 m	-5.5 cm
269 cm (106")	5.5 m	4.6 m	-4.4 cm
254 cm (100")	5.2 m	4.3 m	-4.2 cm
234 cm (92")	4.8 m	4.0 m	-3.8 cm
213 cm (84")	4.4 m	3.6 m	-3.5 cm
183 cm (72")	3.7 m	3.1 m	-3.0 cm
152 cm (60")	3.1 m	2.6 m	-2.5 cm
102 cm (40")	2.0 m	1.7 m	-1.7 cm

BORDER Mode (4:3)

Picture size (diag.) (x)	Projection distance (L)		Distance from the lens centre to the bottom of the image (H)
	Maximum	Minimum	
457 cm (180")	10.0 m	9.5 m	-9.1 cm
381 cm (150")	9.6 m	7.9 m	-7.6 cm
254 cm (100")	6.3 m	5.3 m	-5.1 cm
213 cm (84")	5.3 m	4.4 m	-4.3 cm
183 cm (72")	4.6 m	3.8 m	-3.7 cm
152 cm (60")	3.8 m	3.1 m	-3.0 cm
102 cm (40")	2.5 m	2.1 m	-2.0 cm

NOTE

- Values with a minus (-) sign indicate the distance of the lens centre below the bottom of the screen.





Setting up the Screen

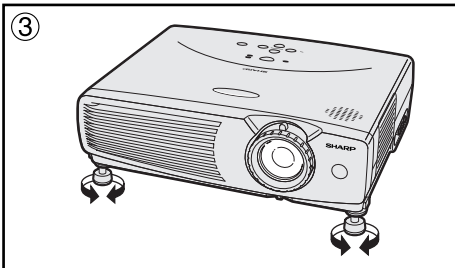
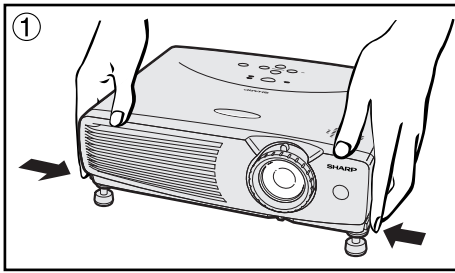

Using the Adjustment Feet

You can adjust the height of the image by raising the projector with the foot releases.

- ① Press the foot releases and lift the projector to the desired angle. (Adjustable up to approximately 7° from the standard position.)
- ② Remove your hands from the foot releases. Once the adjustment feet have locked in position, release the projector.
- ③ If the screen is at an angle, the adjusters can be used to adjust the angle of the image.

Returning the projector to its original position

While holding the projector, press the foot releases and slowly lower the projector to its original position.

NOTE

- When an adjustment is made, the image may become distorted (keystoned), depending on the relative positions of the projector and the screen.

CAUTION

- Do not press the foot releases when the adjustment feet are extended without firmly holding the projector.
- Do not hold the lens when lifting or lowering the projector.
- When lowering the projector, be careful not to get your fingers caught in the area between the adjustment feet and the projector.

Reversed Image Setup

Rear projection

- Place a translucent screen between the projector and the audience.
- Use the projector's menu system to reverse the projected image. (See page 36 for use of this function.)

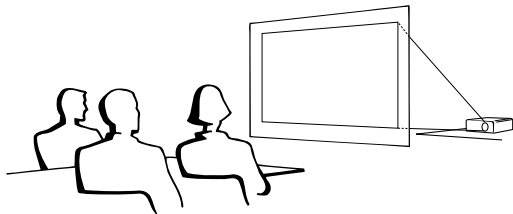

Projection using a mirror

- When the distance between the projector and screen is not sufficient for normal rear projection, you can use a mirror to reflect the image onto the screen.
- Place a mirror (normal flat type) in front of the lens.
- Project the normal image onto the mirror.
- The image reflected from the mirror is projected onto the translucent screen.

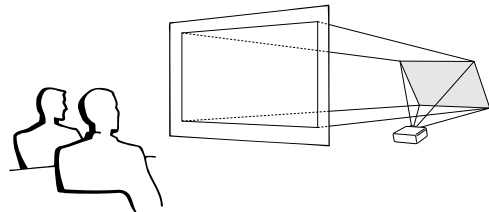

NOTE

- Optimal image quality can be achieved when the projector is positioned perpendicular to the screen with all feet flat and level.

CAUTION

- When using a mirror, be sure to carefully position both the projector and the mirror so the light does not shine into the eyes of the audience.

Ceiling-mount Setup

- It is recommended that you use the optional Sharp ceiling-mount bracket for this installation.
- Before mounting the projector, contact your nearest Sharp Authorised LCD Projector Dealer or Service Centre to obtain the recommended ceiling-mount bracket (sold separately). (AN-Z7T ceiling-mount bracket, AN-TK201/202 extension tube for AN-Z7T.)
- When the projector is in the inverted position, use the upper edge of the screen as the base line.
- Use the projector's menu system to select the appropriate projection mode. (See page 36 for use of this function.)

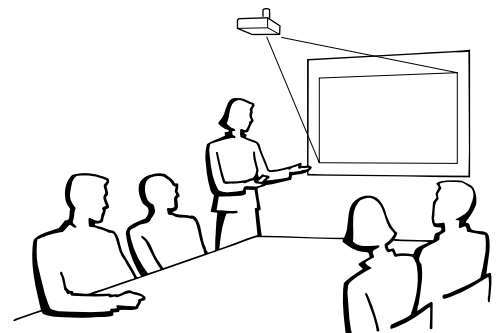



Setting up the Screen

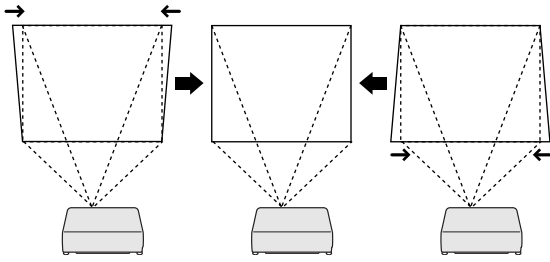

Projector

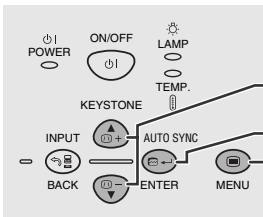

Remote control

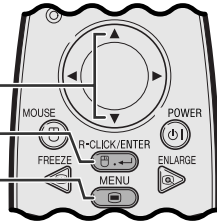

(GUI) On-screen Display

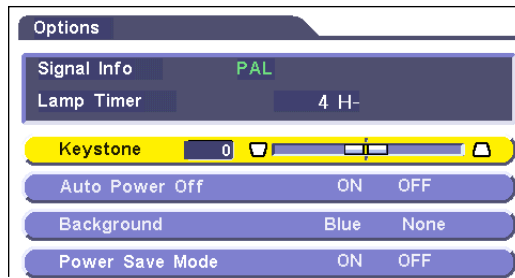

Projector

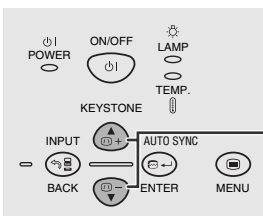

Remote control

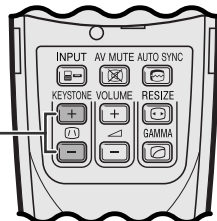

Digital Keystone Correction

- When the image is distorted due to the projection angle, the digital keystone correction function allows you to correct it.
- The digital keystone correction can be made by pressing **KEYSTONE**, or by setting "Keystone" correction in the GUI menu.

Using the GUI menu

- ① Press **MENU**.
- ② Press **▲/▼** to select "Options", and then press **ENTER**.
- ③ Press **▲/▼** to select "Keystone", and then press **ENTER**.
- ④ Press **▲/▼** to move the  mark to the desired setting.
- ⑤ To exit from the GUI, press **MENU**.

NOTE

- To reset the keystone setting, press **BACK**.
- Straight lines and the edges of the displayed image may appear jagged, when adjusting the keystone setting.

Using the KEYSTONE buttons

- ① Press **KEYSTONE** to adjust the setting.





Operating the **Wireless Mouse** from the Remote Control

You can use the remote control as a remote mouse.

Connecting the Remote Mouse Receiver

Connecting to the USB port on a PC or Macintosh

- ① Connect one end of the supplied USB mouse control cable to the corresponding terminal on the computer.
- ② Connect the other end to the USB port on the remote mouse receiver.

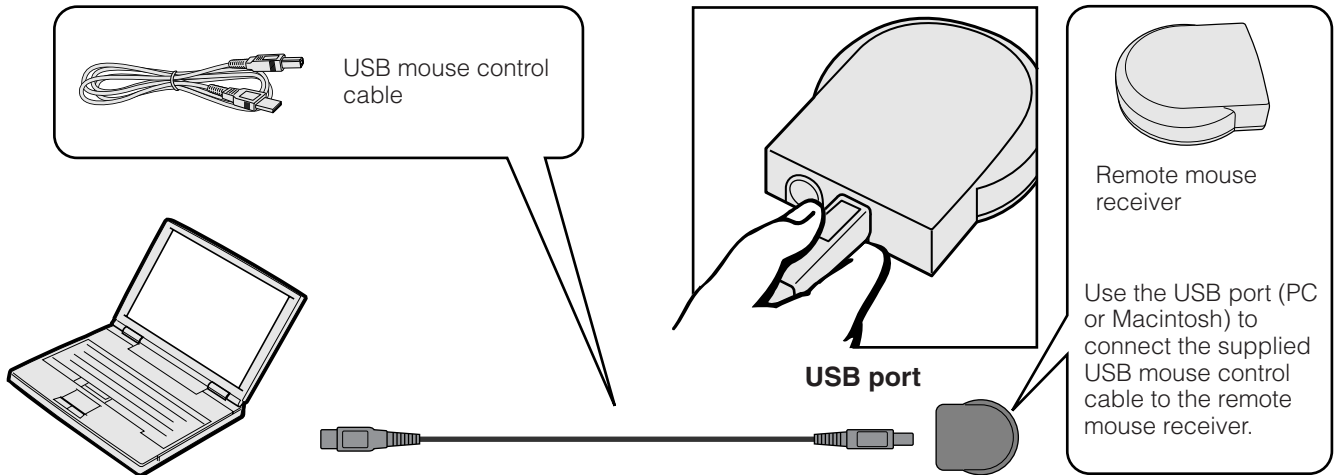

Connecting to the PS/2 port on a PC

- ① Turn off the power of the PC.
- ② Connect one end of the supplied PS/2 mouse control cable to the corresponding terminal on the PC.
- ③ Connect the other end to the PS/2 port on the remote mouse receiver.
- ④ Turn on the power of the PC.

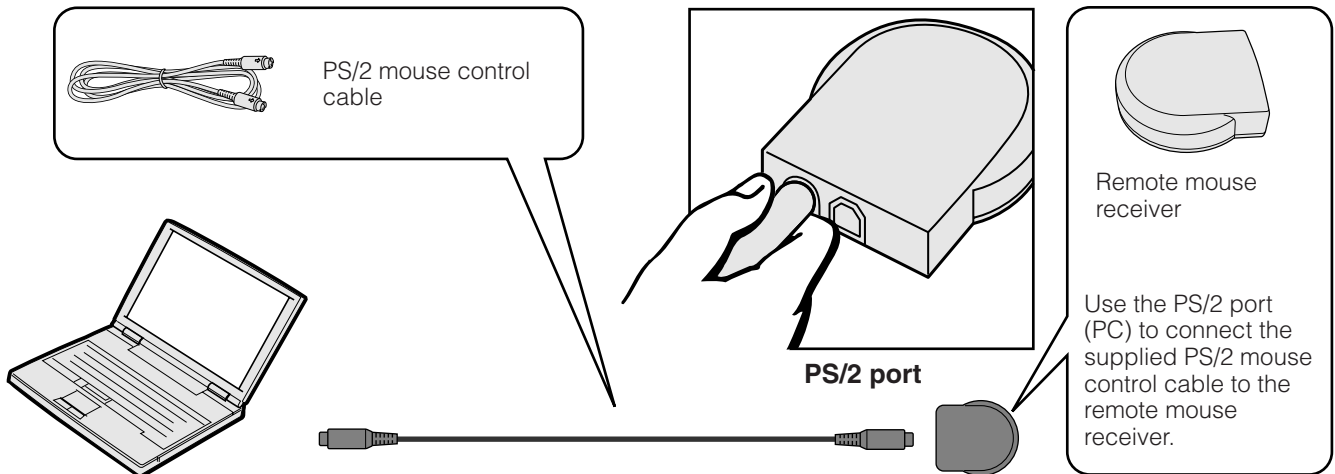

CAUTION

- Do not connect or disconnect the mouse control cables to or from the computer while it is on. This may damage your computer.
- Do not connect both the PS/2 and USB mouse control cables to the remote mouse receiver.
- Windows 95 does not support USB mouse driver software.
- The minimum system requirements for the USB type mouse system are shown below.

Windows

Hardware: PC/AT compatible machine with USB port that has Windows 98/Windows 2000 or higher installed.
 OS: Windows 98/Windows 2000 or higher

Macintosh

Hardware: Macintosh series with USB port
 OS: Mac OS 8.5 or higher

NOTE

- The wireless mouse functions can be used to operate computers compatible with PS/2 or USB type mouse systems.



Remote Control/Mouse Receiver Positioning

- The remote control can be used to control the projector within the ranges shown below.
- The remote mouse receiver can be used with the remote control to control the mouse functions of a connected computer within the ranges shown below.

NOTE

- The signal from the remote control can be reflected off a screen for easy operation. However, the effective distance of the signal may differ due to the screen material.

Controlling the Projector

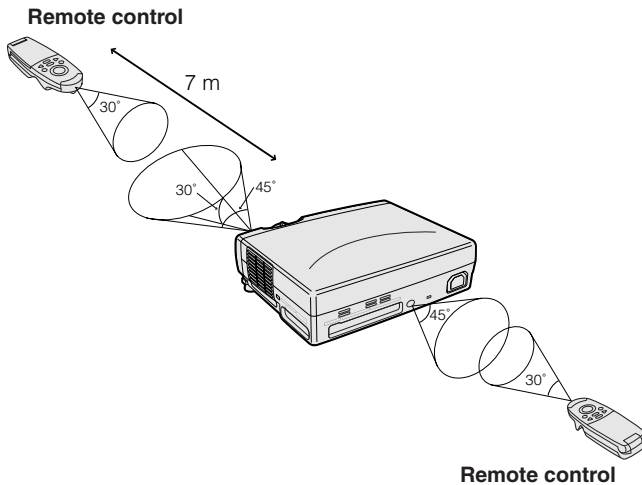

Using the Wireless Mouse

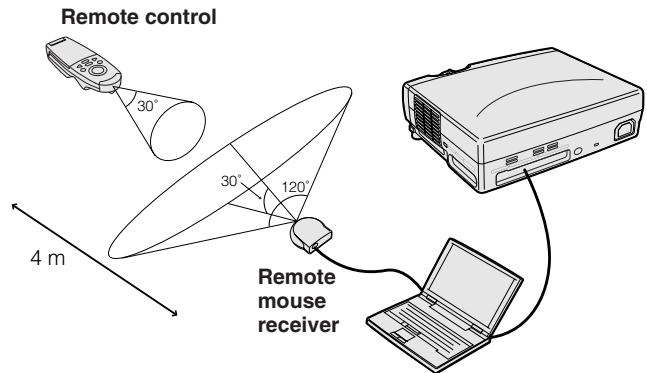

Effective buttons in MOUSE mode

Remote control (Front view)

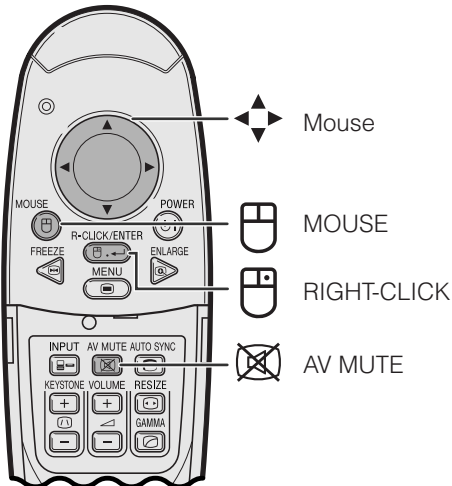

Remote control (Rear view)

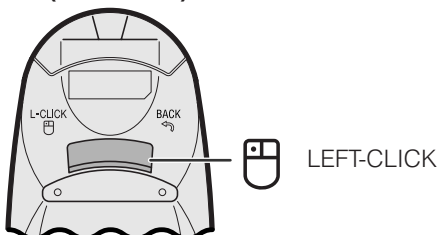

Using as a Wireless Mouse

- When **MOUSE** is pressed, the buttons on the remote control light up and the remote control enters MOUSE mode.
- During MOUSE mode, the cursor can be used as the pointer. MOUSE mode is for about ten seconds while the buttons are lighting.
- When **MENU** or **ENLARGE** is pressed, MOUSE mode is released to the normal mode.
- Be sure the supplied remote mouse receiver is connected to your computer.

NOTE

- The wireless mouse may not operate correctly if your computer serial port is not correctly set up. Refer to the computer's operation manual for details of setting up/ installing the mouse driver.
- For one-button mouse systems, use either the **LEFT-CLICK** or **RIGHT-CLICK** button.





Using the GUI (Graphical User Interface) Menu Screens

This projector has three sets of menu screens (INPUT 1 (RGB), INPUT 1 (COMPONENT) and INPUT 2 (S-VIDEO) or 3 (VIDEO)) that allow you to adjust the image and various projector settings. These menu screens can be operated from the projector or the remote control with the following buttons.

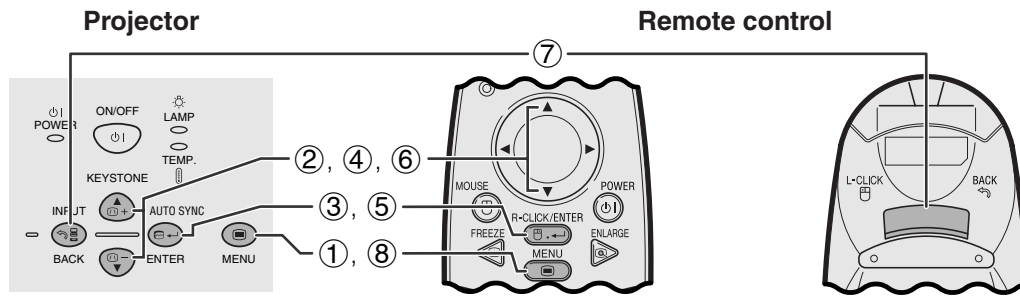

(GUI) On-screen Display

INPUT 1 (RGB) mode

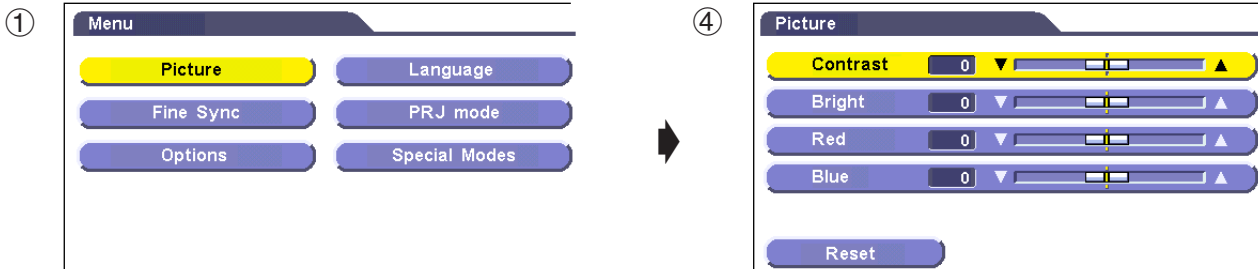

INPUT 1 (COMPONENT) mode

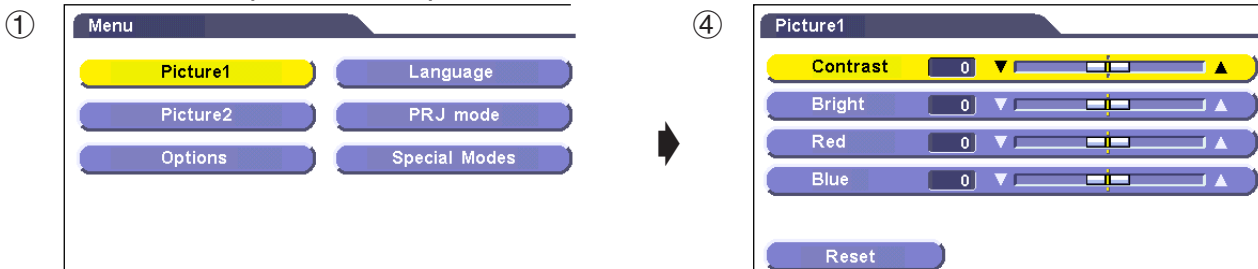

INPUT 2 (S-VIDEO) or 3 (VIDEO) mode

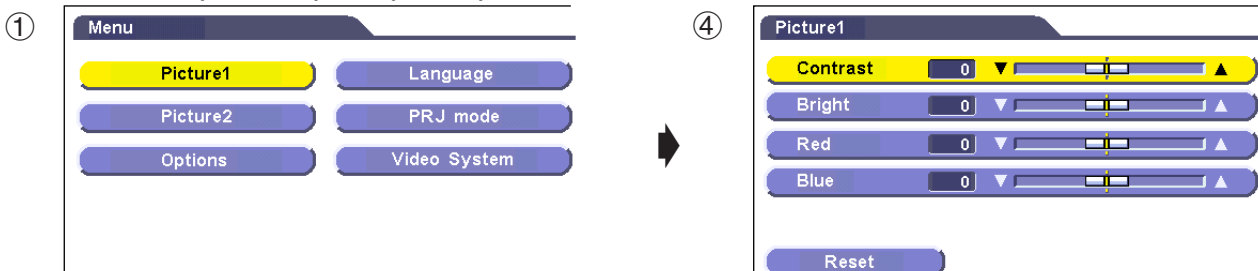

- ① Press **MENU** to display the main menu.
- ② Press **▲/▼** to select an adjustment item in the main menu.
- ③ Press **ENTER** to display the sub menu.
- ④ Press **▲/▼** to select an adjustment item in the sub menu.
- ⑤ Press **ENTER** to activate the selected adjustment item.
- ⑥ Press **▲/▼** to adjust the item.
- ⑦ Press **BACK** to return to the previous screen.
- ⑧ Press **MENU** to exit from the GUI.

NOTE

- For details on items on the menu screen, see the tree charts on pages 24 and 25.



Items on the INPUT 1 (RGB) Mode Menu Bar

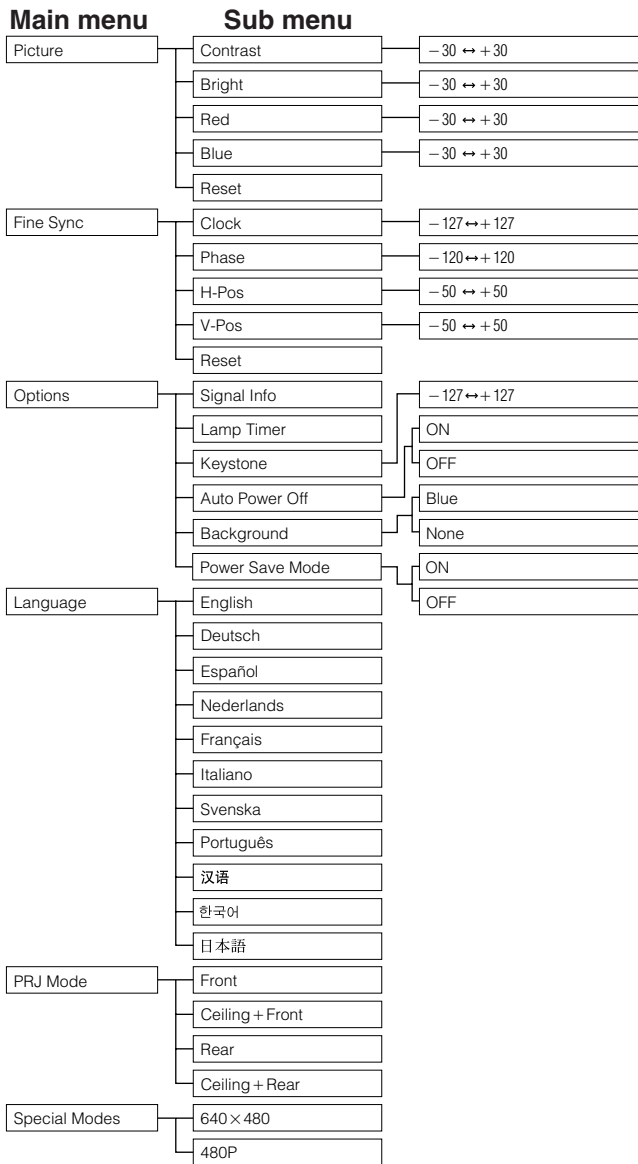

Items on the INPUT 1 (COMPONENT) Mode Menu Bar

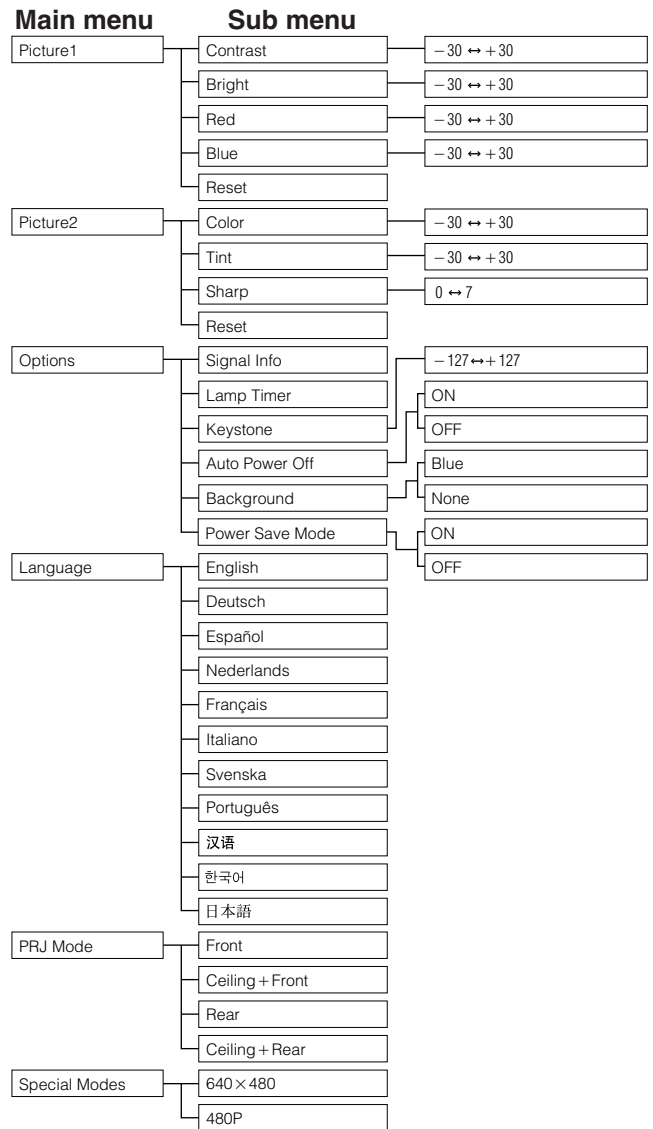



Items on the INPUT 2 (S-VIDEO) or INPUT 3 (VIDEO) Mode Menu Bar

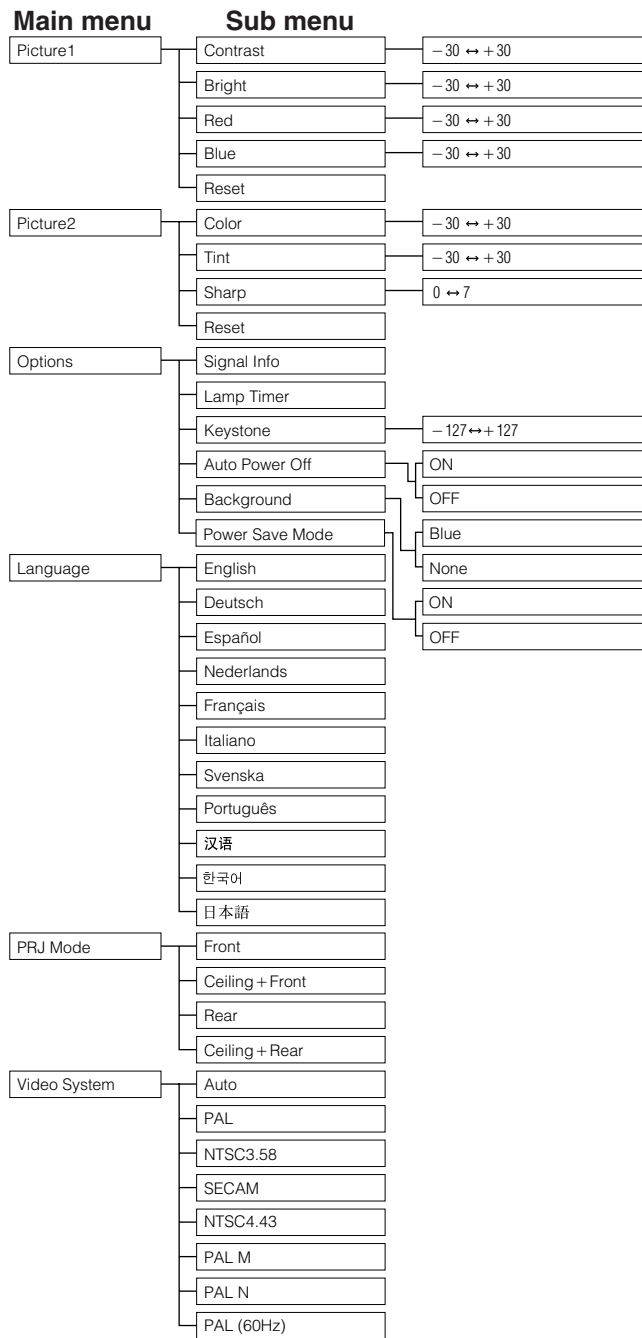

NOTE

- "Tint" does not appear when receiving "PAL", "SECAM", "PAL M", "PAL N" or "PAL (60Hz)" in the INPUT 2 (S-VIDEO) or INPUT 3 (VIDEO) mode.



Selecting the On-screen Display Language

Projector

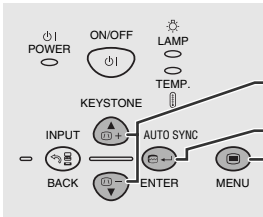

Remote control

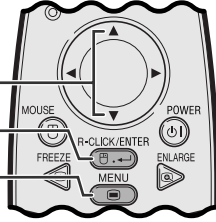

English is the preset language for the On-screen Display. The language can be set to English, German, Spanish, Dutch, French, Italian, Swedish, Portuguese, Chinese, Korean or Japanese.

- ① Press **MENU**.
- ② Press **▲/▼** to select “Language”, and then press **ENTER**.
- ③ Press **▲/▼** to select the desired language.
- ④ Press **ENTER** to save the setting. The On-screen Display is now programmed to display in the language selected.
- ⑤ To exit from the GUI, press **MENU**.

(GUI) On-screen Display



Selecting the Video Input System Mode (INPUT 2 or 3 mode only)

Projector

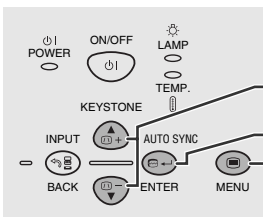

Remote control

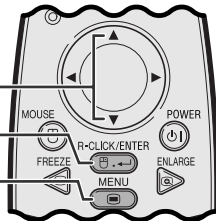

The video input system mode is preset to “Auto”; however, it can be changed to a specific system mode, if the selected system mode is not compatible with the connected audiovisual equipment.

- ① Press **MENU**.
- ② Press **▲/▼** to select “Video System”, and then press **ENTER**.
- ③ Press **▲/▼** to select the desired video system mode.
- ④ Press **ENTER** to save the setting.
- ⑤ To exit from the GUI, press **MENU**.

(GUI) On-screen Display

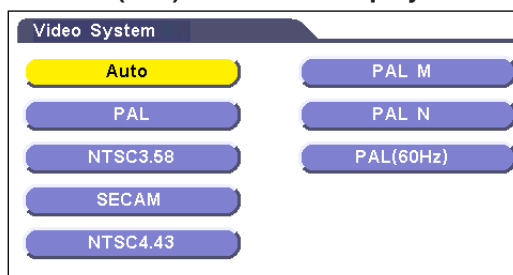

NOTE

- When the system mode is set to “Auto”, you may not receive a clear picture due to signal differences. Should this occur, switch to the video system of the source signal.





Picture Adjustments

Projector

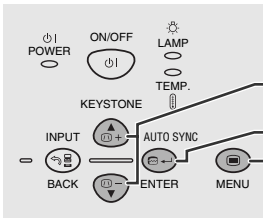

Remote control

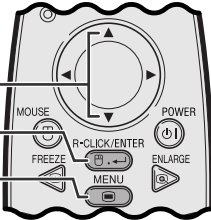

(GUI) On-screen Display INPUT 1 (RGB) mode

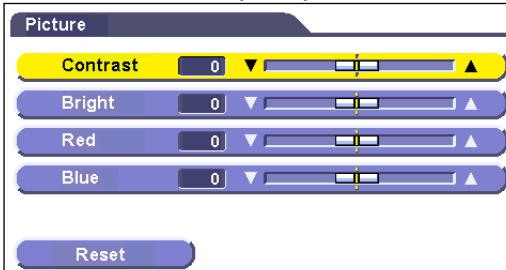

INPUT 1 (COMPONENT) mode

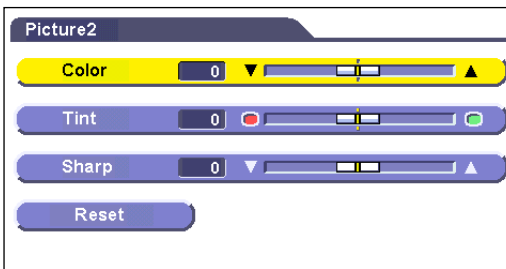

INPUT 2 (S-VIDEO) or INPUT 3 (VIDEO) mode

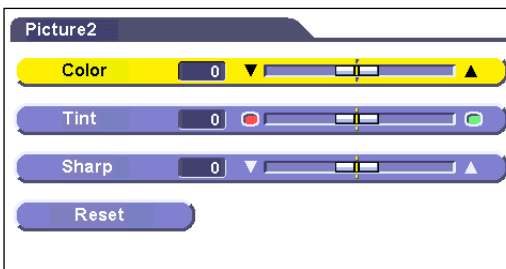
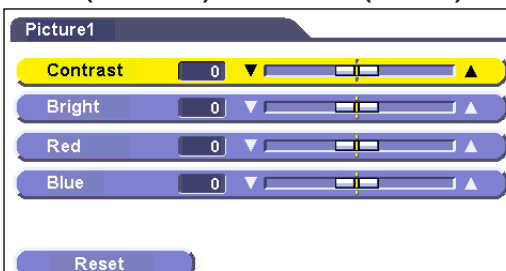

You can adjust the projector's picture to your preferences with the following picture settings.

Description of Adjustment Items

Selected item	▼ button	▲ button
Contrast	For less contrast	For more contrast
Bright	For less brightness	For more brightness
Red	For weaker red	For stronger red
Blue	For weaker blue	For stronger blue
Reset	All image adjustment items are returned to the factory preset settings.	
Color	For less colour intensity	For more colour intensity
Tint	Skin tones become purplish	Skin tones become greenish
Sharp	For less sharpness	For more sharpness

NOTE

- "Color", "Tint" and "Sharp" do not appear in the INPUT 1 (RGB) mode.
- "Tint" does not appear when receiving "PAL", "SECAM", "PAL M", "PAL N" or "PAL (60 Hz)" in the INPUT 2 (S-VIDEO) or INPUT 3 (VIDEO) mode.

- ① Press **MENU**.
- ② Press ▲/▼ to select "Picture" in INPUT 1 (RGB) mode, or to select "Picture1" or "Picture2" in INPUT 1 (COMPONENT), INPUT 2 (S-VIDEO) or INPUT 3 (VIDEO) mode, and then press **ENTER**.
- ③ Press ▲/▼ to select a specific adjustment item, and then press **ENTER**.
- ④ Press ▲/▼ to move the  mark of the selected adjustment item to the desired setting.
- ⑤ To exit from the GUI, press **MENU**.

NOTE

- To reset all adjustment items, select "Reset", and then press **ENTER**.
- The adjustments can be stored separately in the INPUT 1, INPUT 2 and INPUT 3 modes.





Computer Image Adjustments (INPUT 1 mode only)

Projector

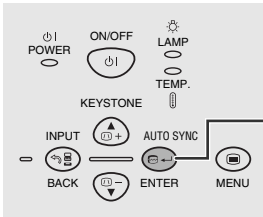

Remote control

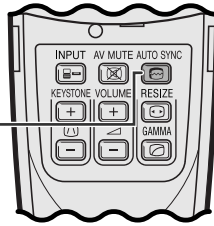

Auto Sync Adjustment

- Used to automatically adjust a computer image.
- Auto Sync adjustment can be made manually by pressing **AUTO SYNC**.

NOTE

- The sync adjustment is automatically made each time the projector is turned on while connected to a computer or the input selection is changed.

- ① Press **AUTO SYNC**.

During Auto Sync adjustment, "Adjusting The Image" is displayed as shown on the left.

On-screen Display



NOTE

- Auto Sync adjustment may take some time to complete, depending on the image of the computer connected to the projector.
- When the optimum image cannot be achieved with Auto Sync adjustment, use manual adjustments. (See page 29.)





Projector

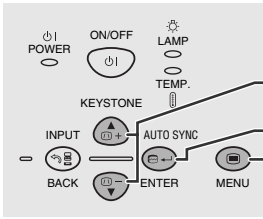

Remote control

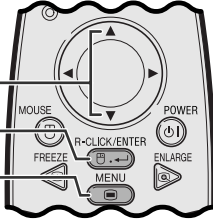

Adjusting the Computer Image

When displaying computer patterns which are very detailed (tiling, vertical stripes, etc.), interference may occur between the LCD pixels, causing flickering, vertical stripes, or contrast irregularities in portions of the screen. Should this occur, adjust "Clock", "Phase", "H-Pos" and "V-Pos" for the optimum computer image.

Description of Adjustment Items

Selected item	Description
Clock	Adjusts vertical noise.
Phase	Adjusts horizontal noise (similar to tracking on your VCR).
H-Pos	Centres the on-screen image by moving it to the left or right.
V-Pos	Centres the on-screen image by moving it up or down.

(GUI) On-screen Display



NOTE

- Computer image adjustments can be made easily by pressing **AUTO SYNC** (⊞). See page 28 for details.

(Select the desired computer input mode with **INPUT**.)

- 1 Press **MENU**.
- 2 Press **▲/▼** to select "Fine Sync", and then press **ENTER**.
- 3 Press **▲/▼** to select a specific adjustment item, and then press **ENTER**.
- 4 Press **▲/▼** to move the mark of the selected adjustment item to the desired setting.
- 5 To exit from the GUI, press **MENU**.

NOTE

- To reset all adjustment items, select "Reset" on the "Fine Sync" menu screen and press **ENTER**.





Useful Features

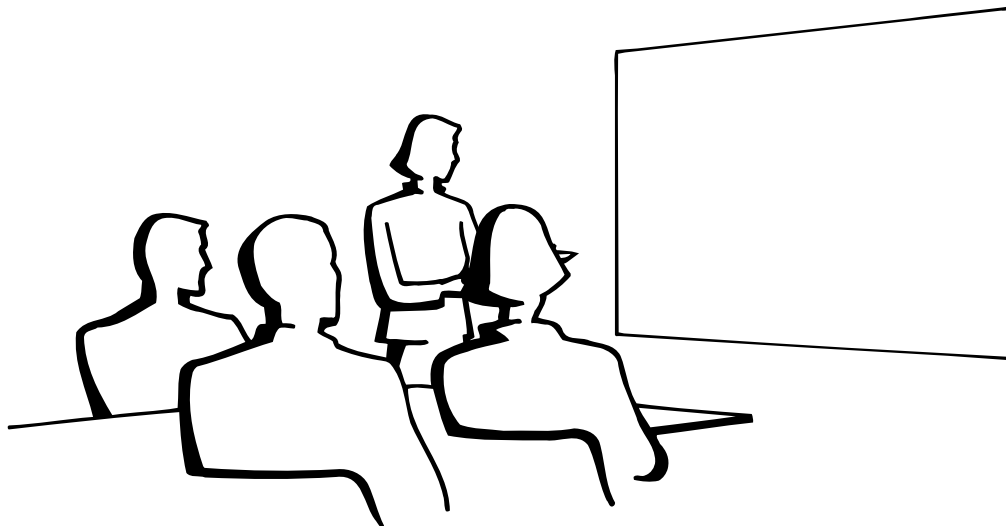

Freeze Function

Remote control

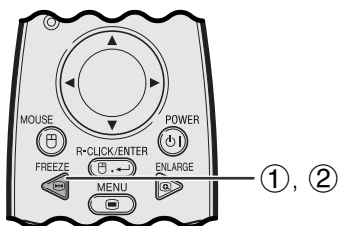

This function allows you to instantly freeze a moving image. This is useful when you want to display a still image from a computer or video, giving you more time to explain the image to the audience.

You can also use this function to display a still image from a computer while you make preparations for the next computer images to be presented.

- ① Press **FREEZE** on the remote control to freeze the image.
- ② Press **FREEZE** again to return to the moving image.

On-screen Display

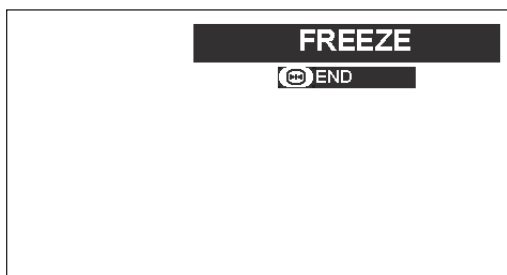



Digital Image Magnification

Remote control

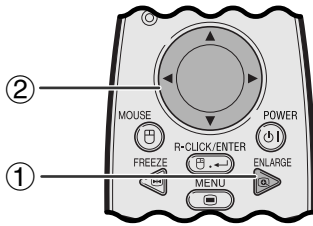

This function allows you to magnify a specific portion of an image. This is useful when you want to display a detailed portion of the image.

- ① Press **ENLARGE** on the remote control. Each time **ENLARGE** is pressed, the image will be magnified.
- ② When the image is magnified, you can pan and scan around the image by using **▲/▼** or **◀/▶**.

On-screen Display

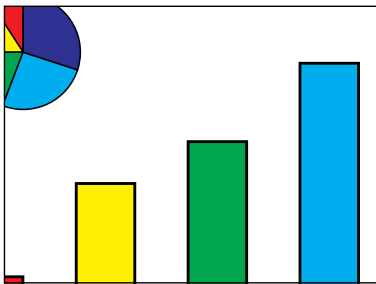
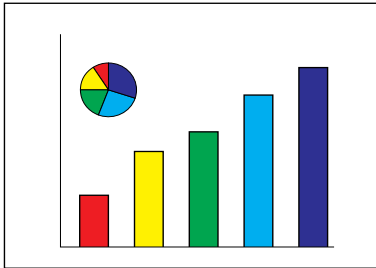

NOTE

- To return to $\times 1$, press **BACK**.
- Each time **ENLARGE** is pressed, image magnification toggles as shown below.

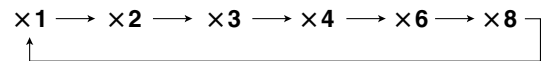

- If the input signal is changed during digital image magnification, the image will return to $\times 1$. The input signal is changed
 - (a) when **INPUT** is pressed,
 - (b) when the input signal is interrupted, or
 - (c) when the input resolution and refresh rate changes.





Gamma Correction

Remote control

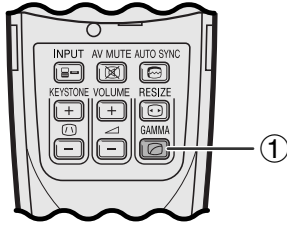

On-screen Display

STANDARD

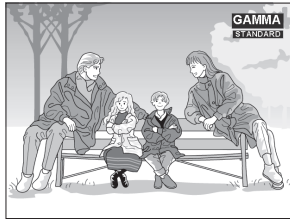

GAMMA 1

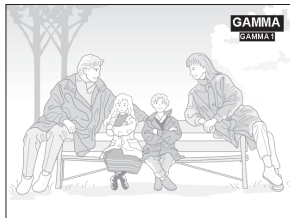

GAMMA 2

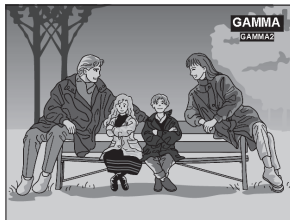

- Gamma is an image quality enhancement function that offers a richer image by brightening the darker portions of the image without altering the brightness of the brighter portions.
- Three gamma settings are available to allow for differences in the images displayed and in the brightness of the room.
- When you are displaying images with frequent, dark scenes, such as a film or concert, or when you are displaying images in a bright room, this feature makes the dark scenes easier to see and gives the impression of greater depth in the image.

Gamma Modes

Selected Mode	Gamma mode
STANDARD	For a highly defined image emphasising high contrast and colour reproduction.
GAMMA 1	Most suitable when viewing images in a brightly lit room.
GAMMA 2	For a warm and moist image controlling contrast and brightness.

- ① Press **GAMMA** on the remote control. Each time **GAMMA** is pressed, the gamma level toggles as shown on the left.





Selecting the Picture Display Mode

Remote control

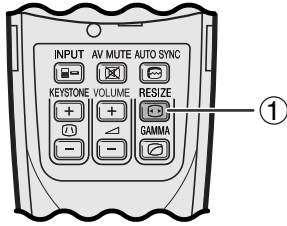

This function allows you to modify or customise the picture display mode to enhance the input image. Depending on the input signal, you can choose the picture display mode preferred.

- Press **RESIZE** on the remote control. Each time **RESIZE** is pressed, the picture mode changes as shown below.

COMPUTER

EXAMPLE

		NORMAL	DOT BY DOT
4:3 aspect ratio	SVGA (800 × 600)	1024 × 768	800 × 600
	XGA (1024 × 768)	1024 × 768	-
Other aspect ratios	SXGA (1280 × 1024)	1024 × 768	1280 × 1024

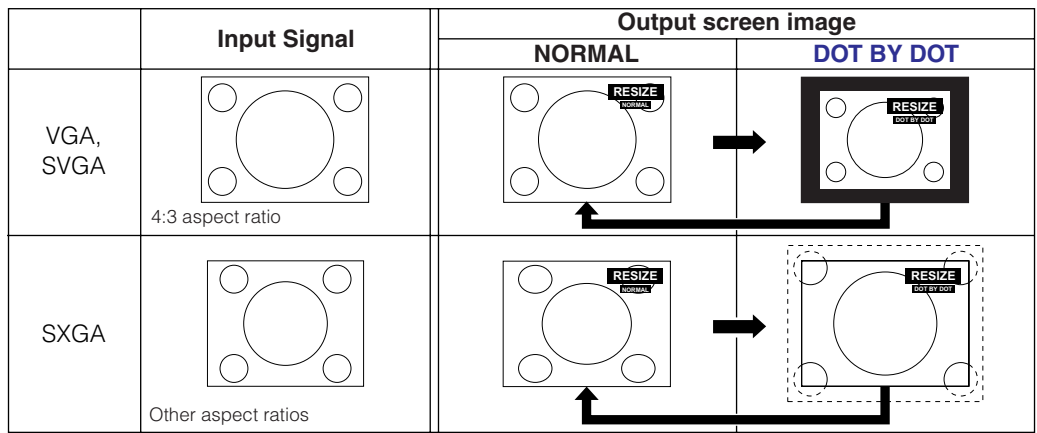

VIDEO/DTV

EXAMPLE

		NORMAL	STRETCH	BORDER
4:3 aspect ratio 480I/P, NTSC, PAL, SECAM	4:3	1024 × 768	1024 × 576	768 × 576
	Letterbox	1024 × 768	1024 × 576	768 × 576
	Squeeze	1024 × 768	1024 × 576	768 × 576

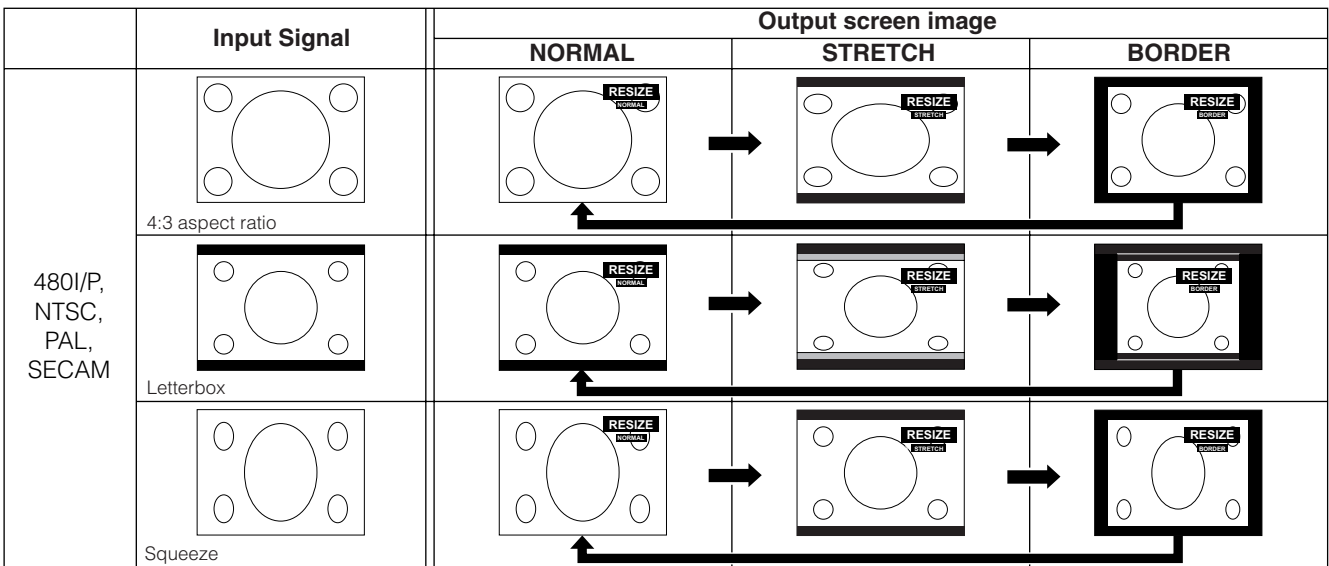



Checking the Input Signal and the Lamp Usage Time

Projector

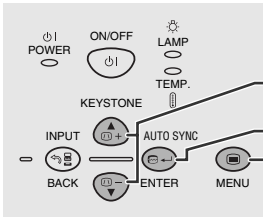

Remote control

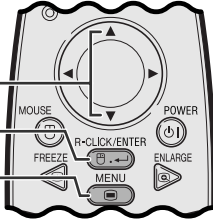

This function allows you to check the current input signal information and the accumulated lamp usage time.

- ① Press **MENU**.
- ② Press **▲/▼** to select “Options”, and then press **ENTER**. The current input signal information and the lamp usage time will be displayed.

NOTE

- It is recommended that the lamp be replaced after approximately 900 hours of usage. See pages 40 and 41 for lamp replacement.

(GUI) On-screen Display

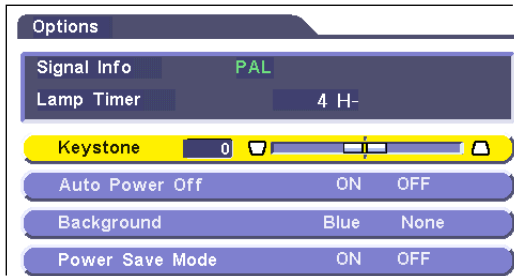

Automatic Power Shutoff Function

Projector

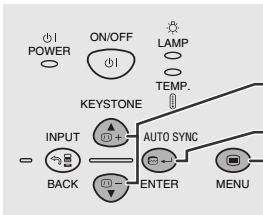

Remote control

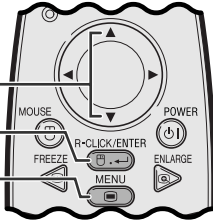

When no input signal is detected for more than 15 minutes, the projector will automatically shut off.

Description of Automatic Power Shutoff

ON	Power automatically shuts off after 15 minutes without a signal being input.
OFF	Automatic Power Shutoff disabled.

- ① Press **MENU**.
- ② Press **▲/▼** to select “Options”, and then press **ENTER**.
- ③ Press **▲/▼** to select “Auto Power Off”, and then press **ENTER**.
- ④ Press **▲/▼** to select “ON” or “OFF”.
- ⑤ To exit from the GUI, press **MENU**.

NOTE

- “Auto Power Off” is factory preset to “ON”.

(GUI) On-screen Display





Selecting a Background Image

Projector

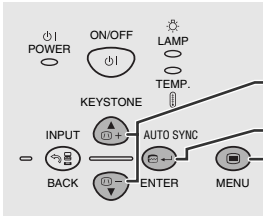

Remote control

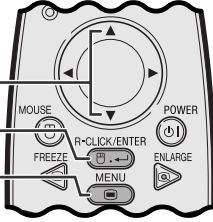

This function allows you to select the image displayed when no signal is being sent to the projector.

Description of Background Images

Blue	Blue screen
None	Black screen

(GUI) On-screen Display



- 1 Press **MENU**.
- 2 Press **▲/▼** to select "Options", and then press **ENTER**.
- 3 Press **▲/▼** to select "Background", and then press **ENTER**.
- 4 Press **▲/▼** to select "Blue" or "None".
- 5 To exit from the GUI, press **MENU**.



Power Save Mode Function

Projector

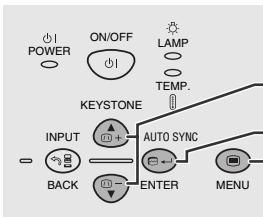

Remote control

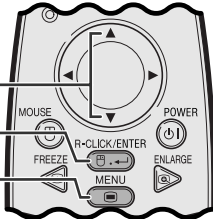

Function with toggle switch to control the quantity of projected light. Select "ON" or "OFF" to decrease or increase brightness, power consumption and fan noise.

Description of Power Save Modes

ON	Quantity of light is 70%. Power consumption is 200 W.
OFF	Quantity of light is 100%. Power consumption is 230 W.

(GUI) On-screen Display



- 1 Press **MENU**.
- 2 Press **▲/▼** to select "Options", and then press **ENTER**.
- 3 Press **▲/▼** to select "Power Save Mode", and then press **ENTER**.
- 4 Press **▲/▼** to select "ON" or "OFF".
- 5 To exit from the GUI, press **MENU**.

NOTE

- "Power Save Mode" is factory preset to "OFF".
- When selecting "OFF" in "Power Save Mode", fan noise is increased.
- Even when selecting "ON" in "Power Save Mode", fan noise may increase if internal temperature rises enough to activate the cooling function.



Reverse/Invert Image Function

Projector

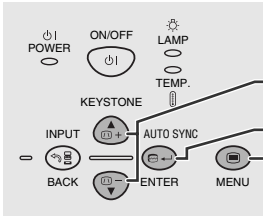

Remote control

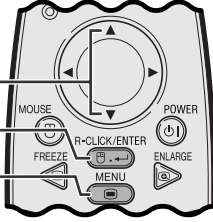

This projector is equipped with a reverse/invert image function which allows you to reverse or invert the projected image for various applications.

Description of Projected Images

Selected item	Projected image
Front	Normal image
Ceiling + Front	Inverted image
Rear	Reversed image
Ceiling + Rear	Reversed and inverted image

(GUI) On-screen Display

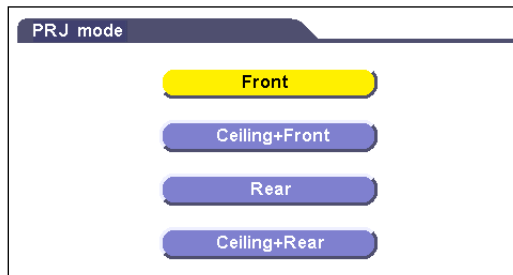

- ① Press **MENU**.
- ② Press **▲/▼** to select "PRJ Mode", and then press **ENTER**.
- ③ Press **▲/▼** to select the desired projection mode, and then press **ENTER**.
- ④ To exit from the GUI, press **MENU**.

NOTE

- This function is used for the reversed image and ceiling-mount setups. See page 19 for these setups.



Special Mode Adjustment

Projector

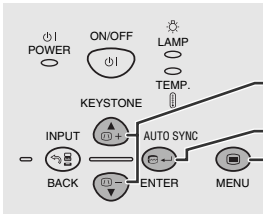

Remote control

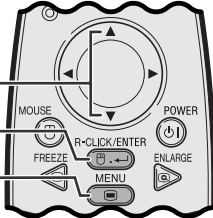

Ordinarily, the type of input signal is detected and the correct resolution mode is automatically selected. However, since the projector cannot distinguish 640×480 signal resolution on computers or 480P on DTVs, select an appropriate mode on "Special Modes."

(GUI) On-screen Display

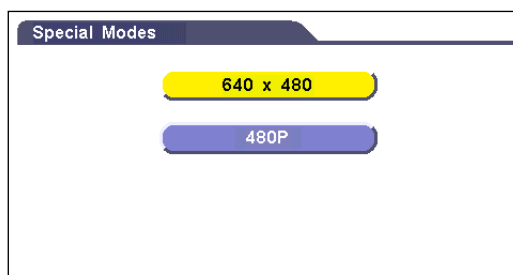

- ① Press **MENU**.
- ② Press **▲/▼** to select "Special Modes", and then press **ENTER**.
- ③ Press **▲/▼** to select the optimal resolution mode.
- ④ Press **ENTER** to save the setting.
- ⑤ To exit from the GUI, press **MENU**.

NOTE

- When inputting DTV 480P signals, select "480P" in step ③ above.





Maintenance & Troubleshooting

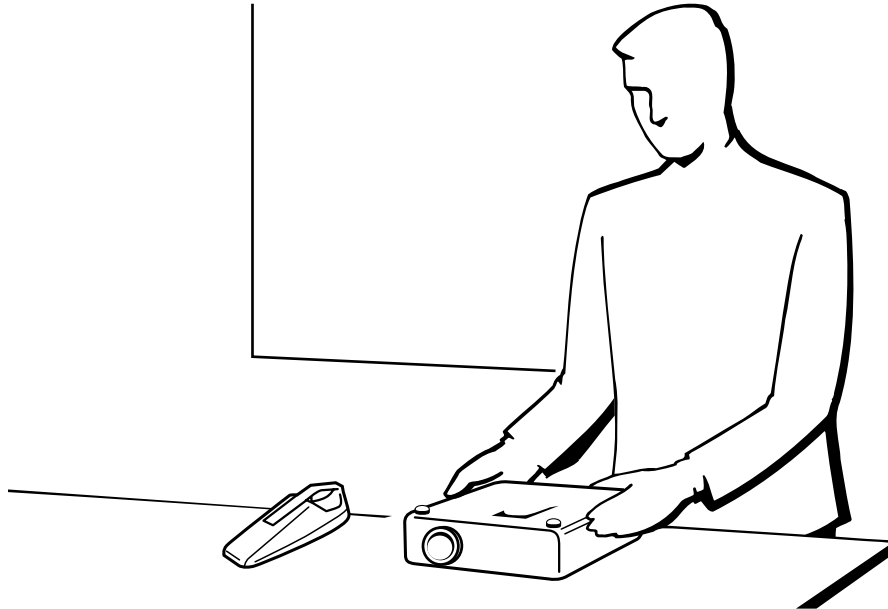

Air Filter Maintenance

Right Side View

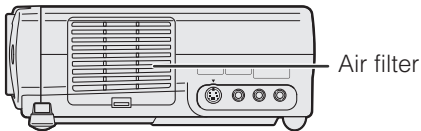

- This projector is equipped with an air filter to ensure the optimal operating condition of the projector.
- The air filter should be cleaned every 100 hours of use. Clean the filters more often when the projector is used in a dusty or smoky location.
- Have your nearest Sharp Authorised LCD Projector Dealer or Service Centre exchange the filter (PFILD0123CEZZ) when it is no longer possible to clean it.

Cleaning the air filter

1 Disconnect the power cord.

Unplug the power cord from the AC socket.

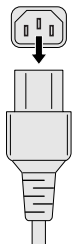

2 Remove the filter cover.

Turn over the projector. Press the tab and remove the filter cover in the direction of the arrow.

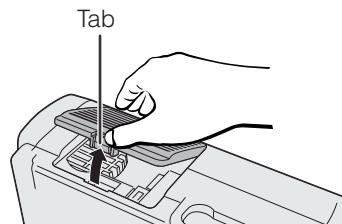



Air Filter Maintenance

3 Clean the air filter.

Clean the dust off the air filter and cover with a vacuum cleaner extension hose.

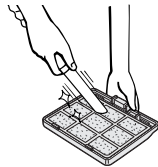

4 Replace the filter cover.

Insert the tab on the end of the filter cover into the filter cover opening and press the filter cover into position.

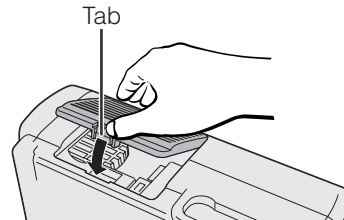

Replacing the air filter

1 Disconnect the power cord.

Unplug the power cord from the AC socket.

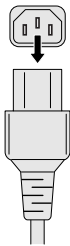

2 Remove the filter cover.

Turn over the projector. Press the tab and remove the filter cover in the direction of the arrow.

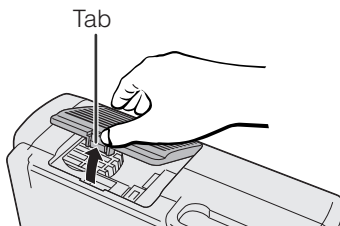

3 Remove the air filter.

- ① Remove the air filter stopper.
- ② Remove the air filter.

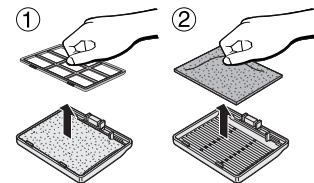

4 Replace the air filter.

- ① Put the new air filter into position.
- ② Put the air filter stopper back into position.

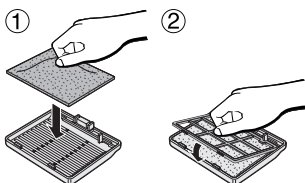

5 Replace the filter cover.

Insert the tab on the end of the filter cover into the filter cover opening and press the filter cover into position.

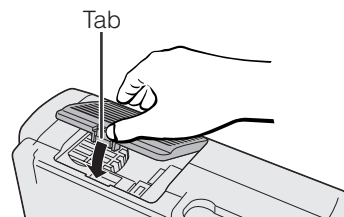

NOTE

- Be sure the filter cover is securely installed. The power will not turn on unless it is correctly installed.





Lamp/Maintenance Indicators

Maintenance Indicators

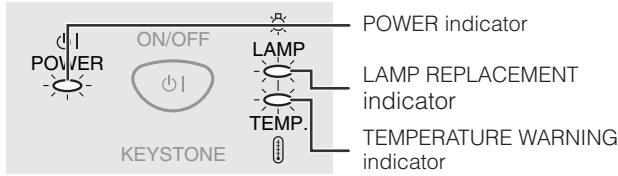

- The warning lights on the projector indicate problems inside the projector.
- There are two warning lights: a TEMPERATURE WARNING indicator which warns that the projector is too hot, and a LAMP REPLACEMENT indicator which lets you know when to change the lamp.
- If a problem occurs, either the TEMPERATURE WARNING indicator or the LAMP REPLACEMENT indicator will illuminate red. After turning off the power, follow the procedures given below.

Maintenance Indicator	Condition	Problem	Possible Solution
TEMPERATURE WARNING indicator	The internal temperature is abnormally high.	<ul style="list-style-type: none"> • Blocked air intake. • Clogged air filter. • Cooling fan breakdown. • Internal circuit failure. 	<ul style="list-style-type: none"> • Relocate the projector to an area with proper ventilation. • Clean the filter. (See pages 37 and 38.) • Take the projector to your nearest Sharp Authorised LCD Projector Dealer or Service Centre for repair.
	The indicator flashes in red.	<ul style="list-style-type: none"> • Cooling down. 	<ul style="list-style-type: none"> • Wait until the indicator stops flashing and turns off.
LAMP REPLACEMENT indicator	The lamp does not illuminate.	<ul style="list-style-type: none"> • Burnt-out lamp. • Lamp circuit failure. 	<ul style="list-style-type: none"> • Carefully replace the lamp. (See pages 40 and 41.) • Take the projector to your nearest Sharp Authorised LCD Projector Dealer or Service Centre for repair.
	The lamp requires replacement.	<ul style="list-style-type: none"> • Lamp has been used for over 900 hours. 	
POWER indicator	The indicator flashes in red when the projector is on.	<ul style="list-style-type: none"> • The filter cover is open. 	<ul style="list-style-type: none"> • Securely install the filter cover.

NOTE

- If the TEMPERATURE WARNING indicator illuminates, follow the solution listed above and then wait until the projector has cooled down completely before turning the power back on. (At least 5 minutes.)
- If the power is turned off and then turned on again, as during a brief rest, the LAMP REPLACEMENT indicator may be triggered, preventing the power from going on. Should this occur, remove the power cord from the wall outlet and plug it in again.

Lamp

The lamp in this projector operates for approximately 1,000 cumulative hours, depending on the usage environment. It is recommended that the lamp be replaced after 900 cumulative hours of use or when you notice a significant deterioration of the picture and colour quality. The lamp usage timer can be checked with the On-screen Display. (See page 34.)

CAUTION

- Intense light hazard. Do not attempt to look into the aperture and lens while the projector is operating.

NOTE

- As the usage environment can vary significantly, the projector lamp may not operate for 1,000 hours.
- "1,000 hours" above indicates average life span and should be used for reference only. This is different than the warranty period.
- For safety, the power will not be turned on from the fourth times when turning on the power without changing the lamp after use for 1,000 hours.

Condition	Problem	Possible Solution
The LAMP REPLACEMENT indicator illuminates red, and "LAMP" will appear in yellow in the lower-left corner of the picture.	<ul style="list-style-type: none"> • Lamp has been used for over 900 hours. 	<ul style="list-style-type: none"> • Purchase a replacement lamp unit (lamp cage/module) of the current type BQC-PGC20X//1 from your nearest Sharp Authorised LCD Projector Dealer or Service Centre.
A significant deterioration of the picture and colour quality occurs.		
The power will automatically turn off and the projector will enter standby mode.	<ul style="list-style-type: none"> • Lamp has been used for over 1,000 hours. 	<ul style="list-style-type: none"> • Replace the lamp. (See pages 40 and 41.) If you wish, you may have the lamp replaced at your nearest Sharp Authorised LCD Projector Dealer or Service Centre.
"LAMP" will appear in red in the lower-left corner of the picture, and the power will turn off.		





Replacing the Projection Lamp

CAUTION:

- **Potential hazard of glass particles if lamp ruptures. Please have Sharp Authorised LCD Projector Dealer or Service Centre replace lamp if rupture occurs.**
- **Do not remove the lamp cage directly after operation of the projector. The lamp may be extremely hot. Wait at least one hour after the power cord is disconnected to allow the surface of the lamp cage to fully cool before removing the lamp cage.**

It is recommended that the lamp be replaced after approximately 900 cumulative hours of use or when you notice a significant deterioration of the picture and colour quality. Carefully change the lamp by following the steps below.

If the new lamp does not light after replacement, take your projector to the nearest Sharp Authorised LCD Projector Dealer or Service Centre for repair. Purchase a replacement lamp unit (lamp/cage module) of the current type BQC-PGC20X//1 from your nearest Sharp Authorised LCD Projector Dealer or Service Centre. Then carefully change the lamp by following the instructions below. If you wish, you may have the lamp replaced at your nearest Sharp Authorised LCD Projector Dealer or Service Centre.

Removing and installing the lamp unit

CAUTION

- Be sure to remove the lamp cage by the handle. Be sure not to touch the glass surface of the lamp cage or the inside of the projector.
- To avoid injury to yourself and damage to the lamp, be sure to carefully follow the steps below.
- Be sure to change the air filter during lamp replacement. The air filter comes packaged with the lamp unit.

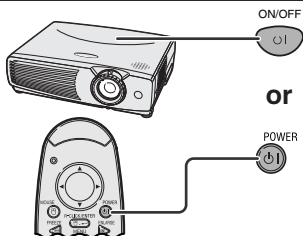
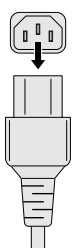
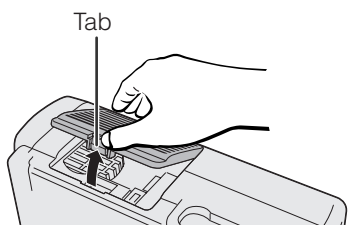
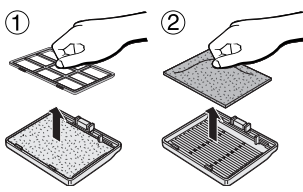
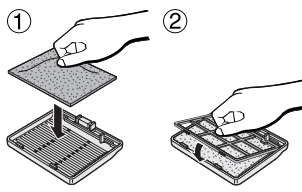
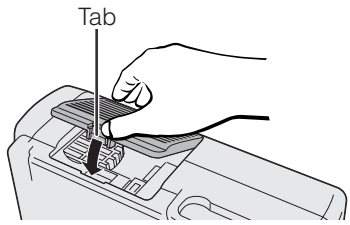
<p>1 Turn off the power.</p> <p>Press ON/OFF on the projector or POWER on the remote control. Wait until the cooling fan stops.</p> 	<p>2 Disconnect the power cord.</p> <p>Unplug the power cord from the AC socket.</p> 	<p>3 Remove the filter cover.</p> <p>Turn over the projector. Press the tab and remove the filter cover in the direction of the arrow.</p> 
<p>4 Remove the air filter.</p> <ol style="list-style-type: none"> 1 Remove the air filter stopper. 2 Remove the air filter. 	<p>5 Replace the air filter.</p> <ol style="list-style-type: none"> 1 Put the new air filter into position. 2 Put the air filter stopper back into position. 	<p>6 Replace the filter cover.</p> <p>Insert the tab on the end of the filter cover into the filter cover opening and press the filter cover into position.</p> 





Replacing the Projection Lamp

7 Remove the lamp cage cover.

Turn over the projector and loosen the user service screw that secures the lamp cage cover. Then lift open the cover in the direction of the arrow.

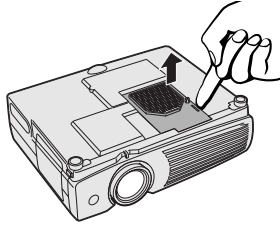

8 Remove the lamp cage.

Loosen the securing screws on the lamp cage. Hold the lamp cage by the handle and pull it towards you.

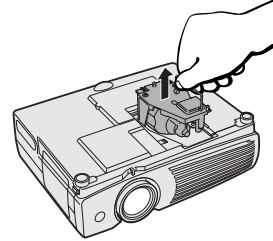

9 Insert the new lamp cage.

Press the lamp cage firmly into the lamp cage compartment. Fasten the securing screws.

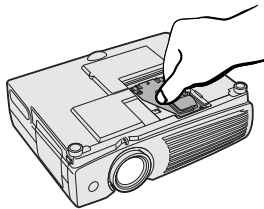

10 Attach the lamp cage cover.

Slide the lamp cage cover in the direction of the arrow. Then tighten the user service screw.

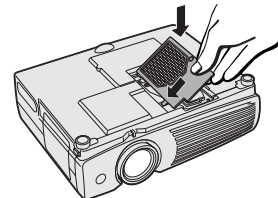

Resetting the lamp timer

1 Connect the power cord.

Plug the power cord into the AC socket of the projector.

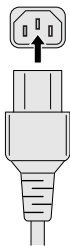

2 Reset the lamp timer.

- ① Press **KEYSTONE ▲** and **KEYSTONE ▼** on the projector at the same time.
- ② Press **INPUT** and **AUTO SYNC** on the projector at the same time.
- ③ Press **AUTO SYNC** and **MENU** on the projector at the same time.

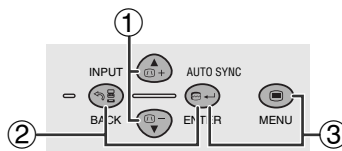

"LAMP 0000H" is displayed, indicating that the lamp timer is reset.

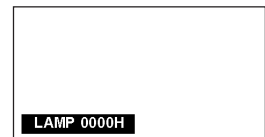

NOTE

- Reset the lamp timer only after replacing the lamp.





Using the Kensington Lock

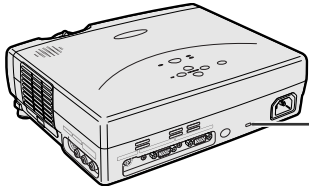

Kensington Security Standard connector

This projector has a Kensington Security Standard connector for use with a Kensington MicroSaver Security System. Refer to the information that came with the system for instructions on how to use it to secure the projector.



Troubleshooting

Problem	Check
No picture and no sound.	<ul style="list-style-type: none"> • Projector power cord is not plugged into the wall outlet. • The filter cover is not securely installed. • Selected input is wrong. (See page 17.) • Cables incorrectly connected to side and rear panels of the projector. (See pages 12–15.) • Remote control batteries have run down. (See page 9.)
Sound is heard but no picture appears.	<ul style="list-style-type: none"> • Cables incorrectly connected to side and rear panels of the projector. (See pages 12–15.) • “Contrast” and “Bright” adjustments are set to minimum position. (See page 27.)
Colour is faded or poor.	<ul style="list-style-type: none"> • “Color” and “Tint” adjustments are not correct. (See page 27.)
Picture is blurred.	<ul style="list-style-type: none"> • Adjust the focus. (See page 17.) • Projection distance is too long or too short to allow for proper focus. (See page 18.)
Picture appears but no sound is heard.	<ul style="list-style-type: none"> • Cables incorrectly connected to side and rear panels of the projector. (See pages 12–15.) • Volume is set to minimum. (See page 17.)
An unusual sound is occasionally heard from the cabinet.	<ul style="list-style-type: none"> • If the picture is normal, the sound is due to cabinet shrinkage caused by temperature changes. This will not affect operation or performance.
Maintenance indicator illuminates.	<ul style="list-style-type: none"> • Refer to “Lamp/Maintenance Indicators” on page 39.
Picture noise appears.	<ul style="list-style-type: none"> • Adjust the “Phase” setting. (See page 29.)
480P images do not appear.	<ul style="list-style-type: none"> • Set the resolution mode to 480P. (See page 36.)





Appendix

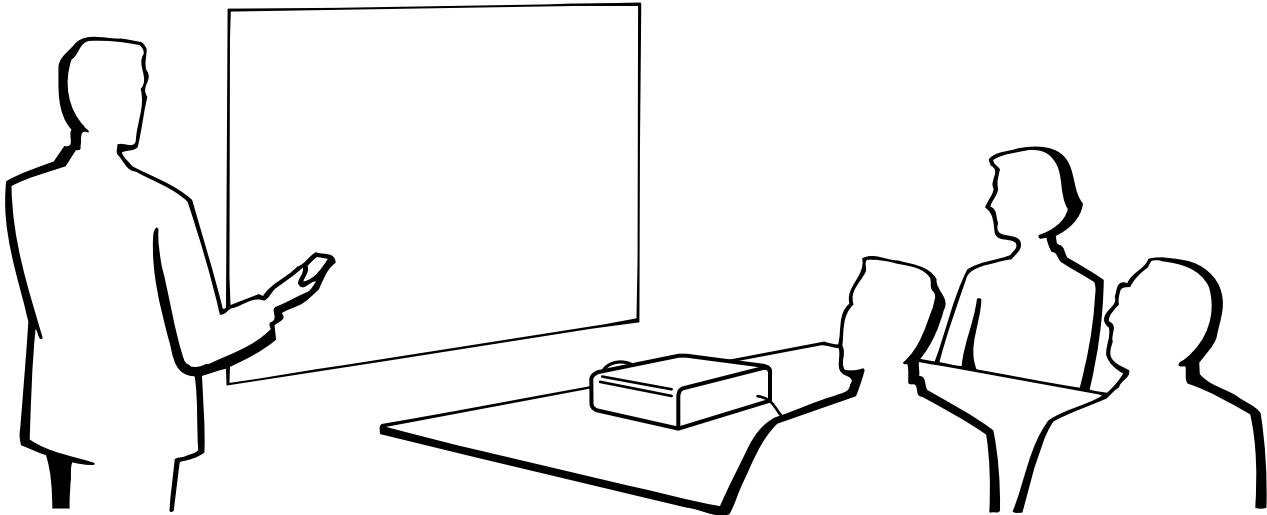

Attaching the Lens Cap

Put on the lens cap to prevent damage to the lens when transporting the projector. A lens cap strap is provided to prevent the loss of the lens cap.

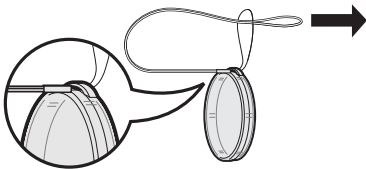
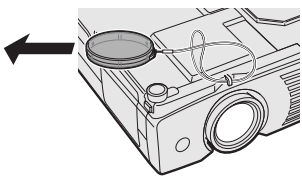
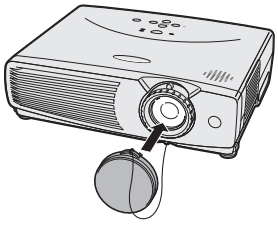
1 Attach the lens cap strap to the lens cap.	2 Attach the lens cap strap to the projector.	3 Attach the lens cap to the projector with the lens cap eyelet facing up.
		

CAUTION

- Do not lift or carry the projector by the lens or the lens cap as this may damage the lens.

NOTE

- You can also use the end of a mechanical pencil or other pointed object to feed the lens cap strap through the openings.





Connection Pin Assignments

COMPUTER INPUT 1 Port: 15-pin mini D-sub female connector

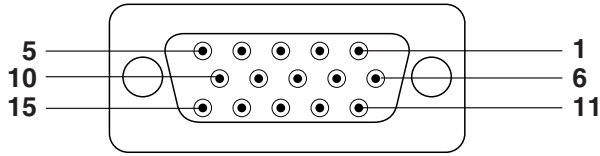

Computer Input

Analog

- | | |
|---|----------------------------|
| 1. Video input (red) | 9. Not connected |
| 2. Video input
(green/sync on green) | 10. Not connected |
| 3. Video input (blue) | 11. GND |
| 4. Not connected | 12. Bi-directional data |
| 5. Composite sync | 13. Horizontal sync signal |
| 6. GND (red) | 14. Vertical sync signal |
| 7. GND (green/sync on green) | 15. Data clock |
| 8. GND (blue) | |

RS-232C Port: 9-pin D-sub male connector of the DIN-D-sub RS-232C cable

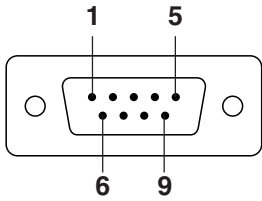

Pin No.	Signal	Name	I/O	Reference
1				Not connected
2	RD	Receive Data	Input	Connected to internal circuit
3	SD	Send Data	Output	Connected to internal circuit
4				Not connected
5	SG	Signal Ground		Connected to internal circuit
6				Not connected
7				Not connected
8				Not connected
9				Not connected

RS-232C Terminal: 9-pin Mini DIN female connector

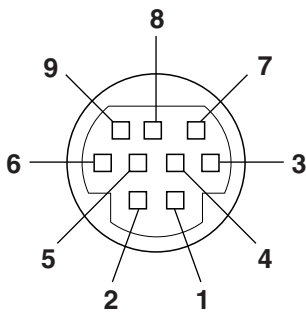

Pin No.	Signal	Name	I/O	Reference
1				Not connected
2	RD	Receive Data	Input	Connected to internal circuit
3	SD	Send Data	Output	Connected to internal circuit
4				Not connected
5	SG	Signal Ground		Connected to internal circuit
6				Not connected
7				Not connected
8				Not connected
9				Not connected





RS-232C Port Specifications

PC control

A computer can be used to control the projector by connecting an RS-232C cable (null modem, cross type, sold separately) to the projector. (See page 15 for connection.)

Communication conditions

Set the serial port settings of the computer to match that of the table.

Signal format: Conforms to RS-232C standard.

Baud rate: 9,600 bps

Data length: 8 bits

Parity bit: NON

Stop bit: 1 bit

Flow control: None

Basic format

Commands from the computer are sent in the following order: command, parameter, and return code. After the projector processes the command from the computer, it sends a response code to the computer.

Command format

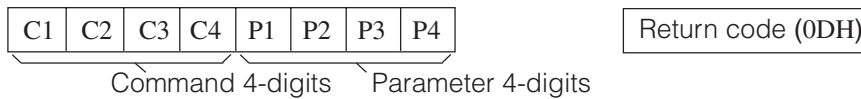

Response code format

Normal response



Problem response (Failure due to incorrect command/parameter or the other communication errors)



When more than one code is being sent, send each command only after the OK response code for the previous command from the projector is verified.

NOTE

- When using the computer control function of the projector, the projector operating status cannot be read to the computer. Therefore, confirm the status by transmitting the display commands for each adjustment menu and checking the status with the On-screen Display. If the projector receives a command other than a menu display command, it will execute the command without displaying the On-screen Display.





RS-232C Port Specifications

Commands

EXAMPLE

- When "BRIGHT" of INPUT 1 (RGB) IMAGE ADJUSTMENT is set to -10.

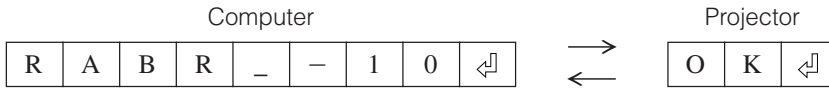

CONTROL ITEM	COMMAND				PARAMETER				CONTROL CONTENTS
	C1	C2	C3	C4	P1	P2	P3	P4	
SPECIAL MODE	S	P	M	D	_	_	_	0	640×480
	S	P	M	D	_	_	_	1	480P
AUTO POWER OFF	A	P	O	W	_	_	_	0	AUTO POWER OFF (OFF)
	A	P	O	W	_	_	_	1	AUTO POWER OFF (ON)
POWER SAVE MODE	T	H	M	D	_	_	_	0	POWER SAVE MODE OFF
	T	H	M	D	_	_	_	1	POWER SAVE MODE ON
POWER SETTING	P	O	W	R	_	_	_	0	POWER OFF (STANDBY)
	P	O	W	R	_	_	_	1	POWER ON
INPUT SWITCHING	I	R	G	B	_	_	_	1	INPUT1 (RGB)
	I	R	G	B	_	_	_	2	INPUT1 (COMPONENT)
	I	V	E	D	_	_	_	1	INPUT2 (S-VIDEO)
	I	V	E	D	_	_	_	2	INPUT3 (VIDEO)
INPUT CHECK	I	C	H	K	_	_	_	0	INPUT CHECK
VOLUME ADJUSTMENT	V	O	L	A	_	_	*	*	VOLUME (00 - 60)
AV MUTE	I	M	B	K	_	_	_	0	AV MUTE OFF
	I	M	B	K	_	_	_	1	AV MUTE ON
KEYSTONE ADJUSTMENT	K	E	Y	S	*	*	*	*	KEYSTONE (-127 - +127)
INPUT1 (RGB) IMAGE ADJUSTMENT	R	B	P	I	_	*	*	*	CONTRAST (-30 - +30)
	R	B	B	R	_	*	*	*	BRIGHT (-30 - +30)
	R	B	R	D	_	*	*	*	RED (-30 - +30)
	R	B	B	E	_	*	*	*	BLUE (-30 - +30)
	R	B	R	E	_	_	_	1	RESET
INPUT2(S-VIDEO)/ INPUT3(VIDEO) IMAGE ADJUSTMENT 1	V	A	P	I	_	*	*	*	CONTRAST (-30 - +30)
	V	A	B	R	_	*	*	*	BRIGHT (-30 - +30)
	V	A	R	D	_	*	*	*	RED (-30 - +30)
	V	A	B	E	_	*	*	*	BLUE (-30 - +30)
	V	A	R	E	_	_	_	1	RESET
INPUT2(S-VIDEO)/ INPUT3(VIDEO) IMAGE ADJUSTMENT 2	V	A	C	O	_	*	*	*	COLOR (-30 - +30)
	V	A	T	I	_	*	*	*	TINT (-30 - +30)
	V	A	S	H	_	_	_	*	SHARPNESS (0 - 7)
	V	A	R	E	_	_	_	2	RESET
INPUT1 (COMPONENT) IMAGE ADJUSTMENT 1	R	A	P	I	_	*	*	*	CONTRAST (-30 - +30)
	R	A	B	R	_	*	*	*	BRIGHT (-30 - +30)
	R	A	R	D	_	*	*	*	RED (-30 - +30)
	R	A	B	E	_	*	*	*	BLUE (-30 - +30)
	R	A	R	E	_	_	_	1	RESET
INPUT1 (COMPONENT) IMAGE ADJUSTMENT 2	R	A	C	O	_	*	*	*	COLOR (-30 - +30)
	R	A	T	I	_	*	*	*	TINT (-30 - +30)
	R	A	S	H	_	_	_	*	SHARPNESS (0 - 7)
	R	A	R	E	_	_	_	2	RESET
INPUT AUTO SYNCHRONIZATION	A	D	J	S	_	_	_	1	AUTO SYNC START

CONTROL ITEM	COMMAND				PARAMETER				CONTROL CONTENTS
	C1	C2	C3	C4	P1	P2	P3	P4	
VIDEO SYSTEM SELECTION	M	E	S	Y	_	_	_	1	AUTO
	M	E	S	Y	_	_	_	2	PAL
	M	E	S	Y	_	_	_	3	NTSC 3.58
	M	E	S	Y	_	_	_	4	SECAM
	M	E	S	Y	_	_	_	5	NTSC 4.43
	M	E	S	Y	_	_	_	6	PAL (M)
	M	E	S	Y	_	_	_	7	PAL (N)
	M	E	S	Y	_	_	_	8	PAL (60 Hz)
BACKGROUND SELECTION	I	M	B	G	_	_	_	3	BLUE
	I	M	B	G	_	_	_	4	NONE
LANGUAGE SELECTION	M	E	L	A	_	_	_	1	ENGLISH
	M	E	L	A	_	_	_	2	DEUTSCH
	M	E	L	A	_	_	_	3	ESPAÑOL
	M	E	L	A	_	_	_	4	NEDERLANDS
	M	E	L	A	_	_	_	5	FRANÇAIS
	M	E	L	A	_	_	_	6	ITALIANO
	M	E	L	A	_	_	_	7	SVENSKA
	M	E	L	A	_	_	_	8	PORTUGUÊS
	M	E	L	A	_	_	_	9	汉语
	M	E	L	A	_	_	_	10	한국어
INPUT1 (RGB) GAMMA SELECTION	M	E	L	A	_	_	_	1	日本語
	M	E	L	A	_	_	_	1	日本語
INPUT1 (RGB) GAMMA SELECTION	G	A	M	R	_	_	_	1	STANDARD
	G	A	M	R	_	_	_	2	GAMMA1
	G	A	M	R	_	_	_	3	GAMMA2
INPUT2(S-VIDEO)/ INPUT3(VIDEO) GAMMA SELECTION	G	A	M	V	_	_	_	1	STANDARD
	G	A	M	V	_	_	_	2	GAMMA1
	G	A	M	V	_	_	_	3	GAMMA2
INPUT1 (COMPONENT) GAMMA SELECTION	G	A	M	V	_	_	_	1	STANDARD
	G	A	M	V	_	_	_	2	GAMMA1
	G	A	M	V	_	_	_	3	GAMMA2
INPUT1 (RGB) RESIZE	R	B	S	R	_	_	_	1	NORMAL
	R	B	S	R	_	_	_	2	DOT BY DOT
INPUT2(S-VIDEO)/ INPUT3(VIDEO) RESIZE	R	A	S	V	_	_	_	1	NORMAL
	R	A	S	V	_	_	_	2	STRETCH
	R	A	S	V	_	_	_	3	BORDER
INPUT1 (COMPONENT) RESIZE	R	A	S	R	_	_	_	1	NORMAL
	R	A	S	R	_	_	_	2	STRETCH
	R	A	S	R	_	_	_	3	BORDER
SCREEN SETTING	I	M	R	E	_	_	_	0	REVERSE OFF
	I	M	R	E	_	_	_	1	REVERSE ON
	I	M	I	N	_	_	_	0	INVERT OFF
	I	M	I	N	_	_	_	1	INVERT ON

NOTE

- If an underbar (_) appears in the parameter column, enter a space. If an asterisk (*) appears, enter a value in the range indicated in brackets under CONTROL CONTENTS.





Computer Compatibility Chart

Horizontal Frequency: 15–80 kHz

Vertical Frequency: 43–85 Hz

Pixel Clock: 12–108 MHz

Compatible with sync on green and composite sync signals

SXGA (1,280 × 1,024) compatible in intelligent compression

PC/MAC/WS	Resolution	Horizontal Frequency (kHz)	Vertical Frequency (Hz)	VESA Standard	Display		
PC	VGA	640 × 350	27.0	60		Upscale	
			31.5	70			
			37.9	85	×		
		720 × 350	27.0	60			
			31.5	70			
			27.0	60			
		640 × 400	31.5	70	×		
			37.9	85	×		
			27.0	60			
	31.5		70	×			
	37.9		85	×			
	27.0		60				
	720 × 400	31.5	70	×			
		37.9	85	×			
		26.2	50				
		31.5	60	×			
		34.7	70				
		37.9	72	×			
	640 × 480	37.5	75	×			
		43.3	85	×			
		31.3	50				
		35.1	56	×			
		37.9	60	×			
		44.5	70				
		48.1	72	×			
		46.9	75	×			
		53.7	85	×			
	SVGA	800 × 600	35.5	43	×		True
			40.3	50			
			48.4	60	×		
56.5			70	×			
60.0			75	×			
68.7			85	×			
XGA			1,024 × 768	55.0	60		
				66.2	70		
				67.5	75	×	
	54.8	60					
	65.9	72					
	64.0	60		×			
PC/MAC 13"	VGA	640 × 480	35.0	67		Upscale	
PC/MAC 19"	XGA	1,024 × 768	48.4	60	×	Intelligent Compression	
			60.0	75	×		
MAC 16"	SVGA	832 × 624	49.7	75		Intelligent Compression	
MAC 21"	SXGA	1,152 × 870	68.7	75			

NOTE

- This projector may not be able to display images from notebook computers in simultaneous (CRT/LCD) mode. Should this occur, turn off the LCD display on the notebook computer and output the display data in "CRT only" mode. Details on how to change display modes can be found in your notebook computer's operation manual.
- This projector can receive 640 × 350 VESA format VGA signals, however, "640 × 400" will appear on the screen.





Specifications

Product type	LCD Projector
Model	PG-C20XE
Video system	PAL/PAL 60/PAL-M/PAL-N/SECAM/NTSC 3.58/NTSC 4.43/DTV 480P
Display method	LCD panel × 3, RGB optical shutter method
LCD panel	Panel size: 22.9 mm (0.9") (13.9 [H] × 18.5 [W] mm) Display method: Translucent TN liquid crystal panel Drive method: TFT (Thin Film Transistor) Active Matrix panel No. of dots: 786,432 dots (1,024 [H] × 768 [V])
Lens	1–1.2× zoom lens, F2.3–2.6, f = 36.0–43.2 mm
Projection lamp	DC 150 W lamp
Contrast ratio	500:1
Video input signal	RCA Connector: VIDEO, composite video, 1.0 Vp-p, sync negative, 75 Ω terminated RCA Connector: AUDIO, 0.5 Vrms more than 22 kΩ (stereo)
S-video input signal	4-pin Mini DIN connector Y (luminance signal): 1.0 Vp-p, sync negative, 75 Ω terminated C (chrominance signal): Burst 0.286 Vp-p, 75 Ω terminated
Horizontal resolution	580 TV lines (video input)
Audio output	1.0 W (monaural)
Computer RGB input signal	15-PIN MINI D-SUB CONNECTOR (COMPUTER INPUT 1 port, COMPUTER OUTPUT port): RGB separate/composite sync/sync on green type analog input: 0–0.7 Vp-p, positive, 75 Ω terminated STEREO MINIJACK: AUDIO, 0.5 Vrms, more than 22 kΩ (stereo) HORIZONTAL SYNC. SIGNAL: TTL level (positive/negative) or composite sync (Apple only) VERTICAL SYNC. SIGNAL: Same as above
Pixel clock	12–108 MHz
Vertical frequency	43–85 Hz
Horizontal frequency	15–80 kHz
Computer control signal	9-pin Mini DIN female connector (RS-232C port)
Speaker system	2.8 cm (1 1/64") round
Rated voltage	AC 100–240 V
Input current	2.6 A
Rated frequency	50/60 Hz
Power consumption	230 W (Selecting "OFF" in the "Power Save Mode".) 200 W (Selecting "ON" in the "Power Save Mode".)
Operating temperature	+5°C to +35°C
Storage temperature	–20°C to +60°C
Cabinet	Plastic
I/R carrier frequency	38 kHz
Dimensions (approx.)	260 × 74 × 207 mm (W × H × D) (main body only) 260 × 82 × 207 mm (W × H × D) (including adjustment feet and projecting parts)
Weight (approx.)	5.73 lbs. (2.6 kg)
Supplied accessories	Remote control, Two AAA size batteries, Power cord (3.6 m), Computer RGB cable (3 m), Computer audio cable (3 m), PS/2 mouse control cable (1 m), USB mouse control cable (1.5 m), DIN-D-sub RS-232C cable (15 cm), Remote mouse receiver, Extra air filter, Lens cap (attached), Lens cap strap, CD-ROM, LCD projector operation manual, LCD projector quick reference guide
Replacement parts	Lamp unit (Lamp/cage module) (BQC-PGC20X//1), Remote control (RRMCG1613CESA), AAA size batteries, Power cord, Computer RGB cable (QCNWG0002CEZZ), Computer audio cable (QCNW-4870CEZZ), PS/2 mouse control cable (QCNW-5113CEZZ), USB mouse control cable (QCNW-5680CEZZ), DIN-D-sub RS-232C cable (QCNW-5288CEZZ), Remote mouse receiver (RUNTK0694CEZZ), Air filter (PFILD0123CEZZ), Lens cap (PCOVZ1095CEKA), Lens cap strap (UBNDT0013CEZZ), CD-ROM (UDSKA0048CEN1), LCD projector operation manual (TINS-7271CEZZ), LCD projector quick reference guides (TINS-7272CEZZ, TINS-7284CEZZ, TINS-7285CEZZ)

This SHARP projector uses LCD (Liquid Crystal Display) panels. These very sophisticated panels contain 786,432 pixels (× RGB) TFTs (Thin Film Transistors). As with any high technology electronic equipment such as large screen TVs, video systems and video cameras, there are certain acceptable tolerances that the equipment must conform to.

This unit has some inactive TFTs within acceptable tolerances which may result in illuminated or inactive dots on the picture screen. This will not affect the picture quality or the life expectancy of the unit.

Specifications are subject to change without notice.





Dimensions

Rear View

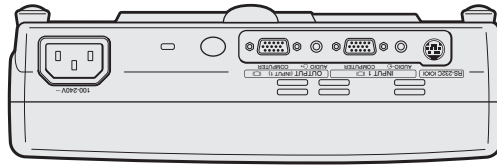

Top View

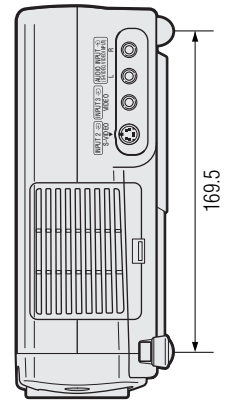
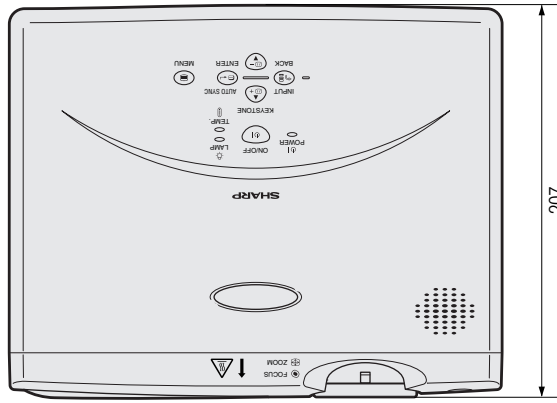
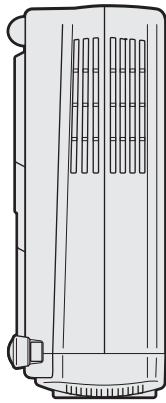

Side View

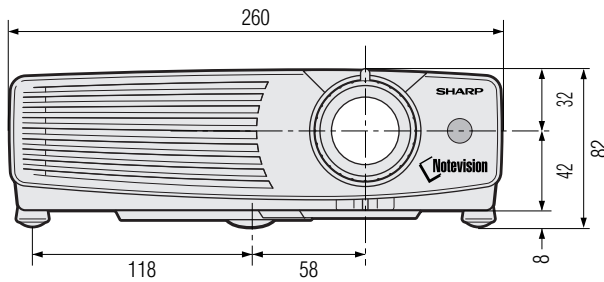

Front View

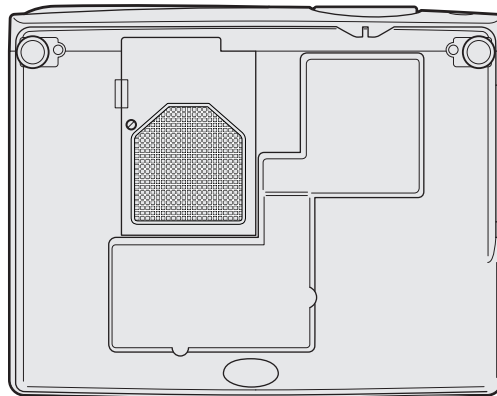

Bottom View

Units: mm



Glossary

Active digital keystone correction

Corrects keystone distortion caused when the projected image is not perpendicular to the screen. This method provides not only horizontal correction, but vertical as well, thus maintaining the original 4:3 aspect ratio and eliminating jag lines.

Aspect ratio

Width and height ratio of an image. The normal aspect ratio of a computer and video image is 4 : 3. There are also wide images with an aspect ratio of 16 : 9 and 21 : 9.

Auto sync

Optimises projected computer images by automatically adjusting certain characteristics.

Background

Initial setting image projected when no signal is being input.

Clock

Clock adjustment is used to adjust vertical noise when clock level is incorrect.

Compatibility

Ability to use with various image signal modes.

Composite sync

Signal combining horizontal and vertical sync pulses.

Dot by dot

Mode that projects images in their native resolution.

Freeze

Function to freeze a moving image.

Gamma correction

Offers richer image viewing with dark scene phase and contrast correction according to image and room brightness. Three gamma settings are available.

GUI

Graphical User Interface. User interface with graphics that allow easier operation.

Intelligent compression and expansion

High quality resizing of lower and higher resolution images to fit the projector's native resolution.

Magnification

Digitally zooms in on a portion of an image.

Power save mode function

Function with toggle switch to control the quantity of projected light. Select "ON" or "OFF" to decrease or increase brightness, power consumption and fan noise.

PDF

Portable Document Format. Documentation format used to transfer text and images from the CD-ROM.

Phase

Phase shift is a timing shift between isomorphic signals with the same resolution. When phase level is incorrect, the projected image typically displays horizontal flicker.

RS-232C

Function to control the projector from the computer by using the RS-232C ports on the projector and computer.

Sync on green

Video signal mode of a computer which overlaps horizontal and vertical sync signal to green colour signal pin.

Wireless mouse

Function to operate the mouse control of a computer with the supplied remote control.

XGA resolution

Resolution with 1,024 × 768 pixels that uses the signal of an IBM/AT compatible (DOS/V) computer.





Index

A	
Active digital keystone correction	4
AC socket	12
Adjustment buttons	23
Air filter	37
Aspect ratio	33
AUDIO INPUT terminals	13
AUDIO INPUT 1 terminal	12
AUDIO OUTPUT terminal for INPUT 1	14
Automatic power shutoff function	34
Auto sync adjustment	28
AUTO SYNC button	28
AV MUTE button	17
B	
BACK button	23
Background	35
C	
Ceiling-mount	19
Ceiling + Rear	36
Clock	29
Computer audio cable	12
COMPUTER INPUT 1 port	12
COMPUTER OUTPUT port for INPUT 1	8
Computer RGB cable	12
Cooling fan (Exhaust vent)	6
Cooling fan (Intake vent)	37
D	
Digital image magnification	31
DIN-D-sub RS-232C cable	15
Dot by dot	33
E	
ENLARGE button	31
ENTER button	23
Extra air filter	37
Eyelet for lens cap strap	43
F	
Flip cover	9
FOCUS ring	17
Foot releases	19
FREEZE button	30
G	
GAMMA button	32
GUI (Graphical User Interface)	23
I	
INPUT button	17
Intelligent compression and expansion	4
K	
Kensington Security Standard connector	42
KEystone buttons	20
L	
LAMP REPLACEMENT indicator	39
Lamp timer	34
LEFT-CLICK button	22
Lens cap	43
M	
MENU button	23
MOUSE button	22
Mouse buttons	22
O	
ON/OFF button	17
On-screen display language	26
P	
PDF	7
Phase	29
Picture adjustments	27
Picture display mode	33
POWER button	17
Power cord	12
Power save mode	35
POWER indicator	16
PS/2 mouse control cable	21
R	
Rear projection	19
Remote control	22
Remote control sensor	22
Remote mouse receiver	21
RESIZE button	33
RIGHT-CLICK button	22
RS-232C port	15
S	
Signal info	34
Speaker	8
S-VIDEO INPUT 2 terminal	13
Sync on green	44
T	
TEMPERATURE WARNING indicator	39
U	
USB mouse control cable	21
V	
VIDEO INPUT 3 terminal	13
VOLUME buttons	17
W	
Wireless mouse	21
X	
XGA resolution	4
Z	
ZOOM knob	17



SHARP CORPORATION

Free Manuals Download Website

<http://myh66.com>

<http://usermanuals.us>

<http://www.somanuals.com>

<http://www.4manuals.cc>

<http://www.manual-lib.com>

<http://www.404manual.com>

<http://www.luxmanual.com>

<http://aubethermostatmanual.com>

Golf course search by state

<http://golfingnear.com>

Email search by domain

<http://emailbydomain.com>

Auto manuals search

<http://auto.somanuals.com>

TV manuals search

<http://tv.somanuals.com>