



Swann™

English



ADS-450

SwannSmart Video Security

M450IPC050411E

Before You Begin

FCC Verification

NOTE: This equipment has been tested and found to comply with the limits for Class B digital device, pursuant to part 15 of the FCC Rules. These limits are designed to provide reasonable protection against harmful interference in a residential installation. This equipment generates, uses and can radiate radio frequency energy and, if not installed and used in accordance with the instructions, may cause harmful interference to radio or television reception, which can be determined by turning the equipment off and on, the user is encouraged to try to correct the interference by one or more of the following measures:

- Reorient or relocate the receiving antenna
- Increase the separation between the equipment and the receiver
- Connect the equipment into an outlet on a circuit different from that to which the receiver is connected
- Consult the dealer or an experienced radio/TV technician for help

These devices comply with part 15 of the FCC Rules. Operation is subject to the following two conditions:

1. These devices may not cause harmful interference, and
2. These devices must accept any interference received, including interference that may cause undesired operation.

IMPORTANT NOTE:

All jurisdictions have specific laws and regulations relating to the use of cameras. Before using any camera for any purpose, it is the buyer's responsibility to be aware of all applicable laws and regulations that prohibit or limit the use of cameras and to comply with the applicable laws and regulations.

FCC Regulation (for USA): Prohibition against eavesdropping

Except for the operations of law enforcement officers conducted under lawful authority, no person shall use, either directly or indirectly, a device operated pursuant to the provisions of this Part for the purpose of overhearing or recording the private conversations of others unless such use is authorized by all of the parties engaging in the conversation.

WARNING

Modifications not approved by the party responsible for compliance could void user's authority to operate the equipment.

IMPORTANT SAFETY INSTRUCTIONS

- Make sure product is fixed correctly and stable if fastened in place
 - Do not operate if wires and terminals are exposed
- Do not cover vents on the side or back of the camera and allow adequate space for ventilation



Contents

Before You Begin	2	Interface: Login & Camera List	11
Contents	3	Navigating the Mobile Interface	12
Package Contents	3	Access via the SwannSmart Website	12
Mounting Diagram	4	Interface: Live View	13
Introduction	5	Interface: Events	14
Layout	6	Interface: Camera Settings	15
Local WIFI Configuration: Access	7	SwannSmart App Settings	17
Local WIFI Configuration: Details	8	Expanding Your Service	18
Local WIFI Configuration: Connecting to Internet	9	Technical Specifications	18
IMPORTANT: Turning off Local WIFI Configuration	9	Warranty Information	19
Registering Your Account with SwannSmart	10	Helpdesk / Technical Support Details	20

Package Contents



ADS-450 Camera



Operating Instructions



Ethernet Cable



5V 1.5A Power Adapter

Mounting Diagram

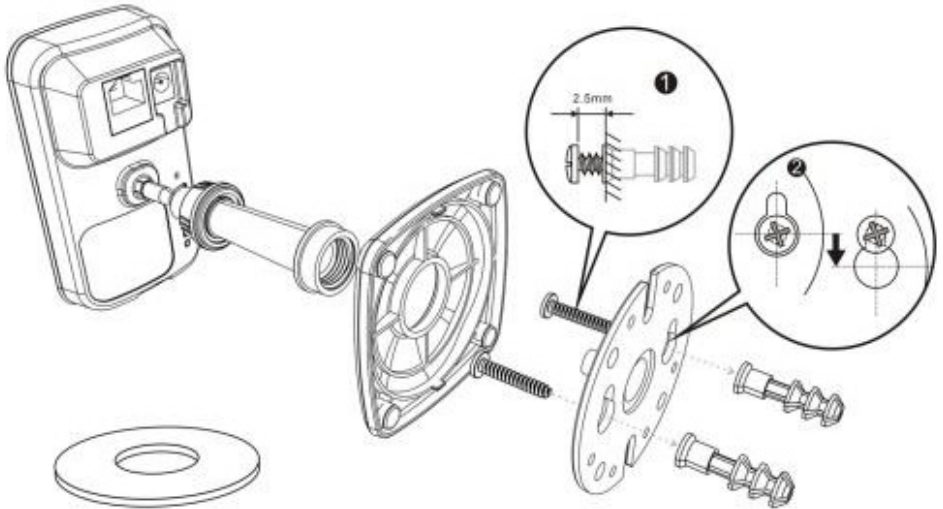

To permanently mount the camera:

- Remove the circular mounting plate from the base of the stand by unscrewing the stand. *See the image (right).*
- Remove the metal ring. Keep it somewhere safe if you think you might need it.
- Take the plastic mounting plate and apply it to a wall. Mark the two main screw points.
- Insert two screws into the wall. If mounting to masonry/brickwork, use wall plugs. Leave approximately 2.5mm (about 1/10 of an inch) of screw protruding.
- Apply the plastic mounting plate to the wall. Twist to lock in place.
- Attach the stand and camera to the mounting plate.



Unscrewing the stand. The plastic screw thread has a tight grip, so it may take a little force to unscrew.

Note: There's no *requirement* to mount the camera. The metal ring in the base provides weight so the camera can simply be placed on a flat, horizontal surface and be stable.

Introduction

Congratulations on your purchase of this ADS-450 camera, the central component of your *SwannSmart Video Security* system. This camera is versatile, powerful, easy to install and configure and looks pretty stylish, too.

Best of all, it can be totally wireless - if there's a WIFI network your camera can connect to the Internet through, then just connect the camera to power and you're good to go.

You'll be able to view images from your camera(s) from just about anywhere you can find a mobile Internet signal.



The **Network LED** will be constantly illuminated **green** when the camera is connected to a network and is working correctly.

It will flash **orange** when the camera is connecting to a network - if the flashing persists, it indicates communication difficulties.

If the **Network LED** is **red**, this indicates that it cannot connect to the network you chose, and probably needs to be re-configured.



The **Power LED** will be constantly illuminated **green** when the camera is connected to power and switched on.

If this turns either **orange** or **red**, this indicates a problem with your power supply - the camera is not receiving enough power. Ensure you're using the correct power supply, that the cables are undamaged and all connections are firmly made.



The **Local WIFI Configuration LED** will be illuminated **green** while the camera is set to Local WIFI Configuration mode (set by the switch of the same name).

If this is either **orange** or **red**, this indicates a problem with the camera's built-in WIFI access point.

The **Local WIFI Configuration Switch** is located directly above the LED of the same name. **Local WIFI Config** will be turned **on** when the switch is in the **up** position, and will be turned **off** when in the **down** position.

Reset: Located immediately above the **Local WIFI Config** switch is the **Reset Button**. Pressing this button while the camera is powered and operating will **clear all settings**, and reset the camera to its factory default settings.

The button itself is located behind the small hole for protection against accidental bumps or knocks. You'll need a thin (but not sharp) object, such as a bent paper clip or similar, to push the reset button.

Layout

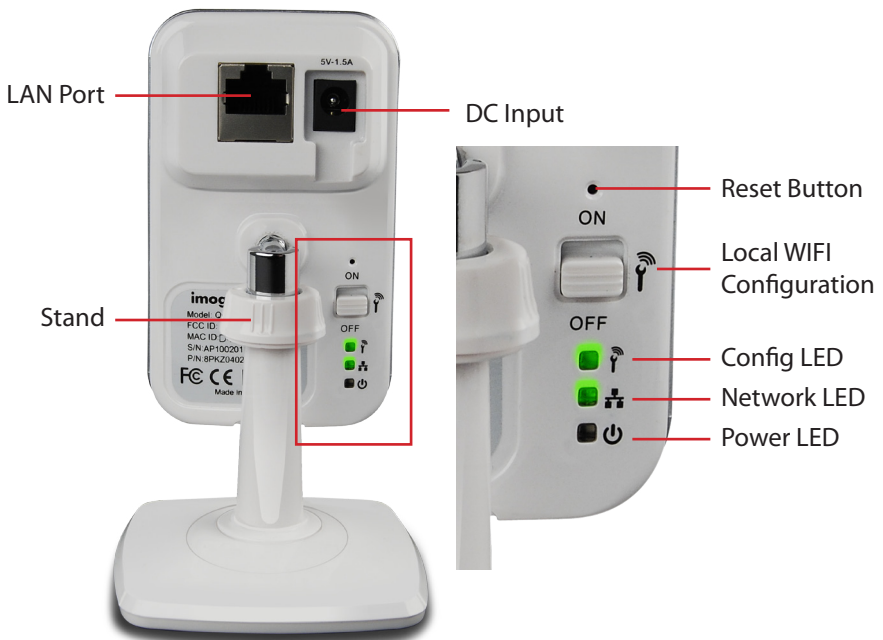

Local WIFI Configuration: Access

To configure the camera via the **Local WIFI Configuration** mode, you'll need the following:

- Your *Android* device or *iPhone/iPad* with the *SwannSmart* app correctly installed.
- An internet connection (other than your mobile device) that the camera can use to connect to the Internet.

Local WIFI

The camera will act as its own WIFI access point, allowing you to connect directly to the camera from your phone/tablet using the *SwannSmart* app. All the local configuration is achieved through this local configuration mode.

To initiate local WIFI configuration mode:

- Flip the switch on the rear of the camera.
- While  is set to ON, the camera will act as its own WIFI server. You'll be able to connect directly to the camera from an Android-handset or an iPhone, with the appropriate app installed correctly.

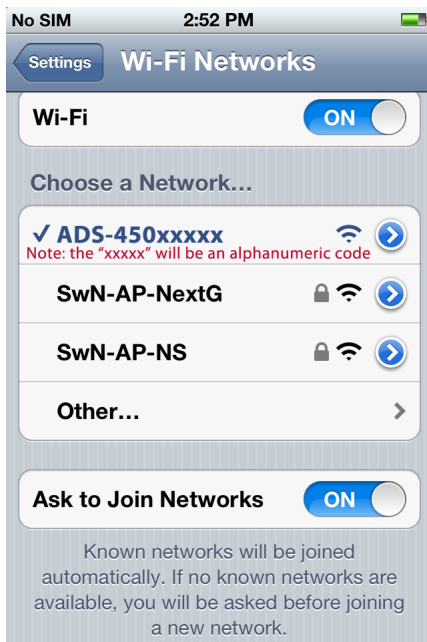

Connecting to the camera locally from an iPhone/iPad or Android device:

- **Android:** Open *Settings* > *Wireless & networks* > *Wi-Fi Settings*
- **iPhone:** Choose *Settings* > *Wi-Fi*
- From the list of available networks, choose ADS-450xxxx (where "xxxx" is a code which will vary).
- Each time Local WIFI mode is turned on, the network name will change slightly (to avoid creating conflicts or creating errors when devices cache network lists).
- If you've got multiple cameras in Local WIFI Config mode, then configure them **one at a time**.
- Launch the *SwannSmart* app.

Local WIFI Configuration: Details

You will receive an on-screen message upon starting the app informing you that SwannSmart has detected the camera, asking if you would like to proceed with configuration. Choose **Yes** to proceed.

If you don't get this message, it indicates that either the camera's local WIFI is not on, or that your mobile device isn't properly connected to the local WIFI network.

There are two stages to **Local WIFI Configuration**:

- Connecting to the Internet
- Configuring *SwannSmart*

You'll be taken to the splash screen. Choose **Continue**.

Note: *The software images shown are for illustration purposes only. We're continually making improvements to the SwannEye apps, and their appearance will change over time.*

These images are from the iOS app. The Android app will appear slightly different, but is functionally similar.

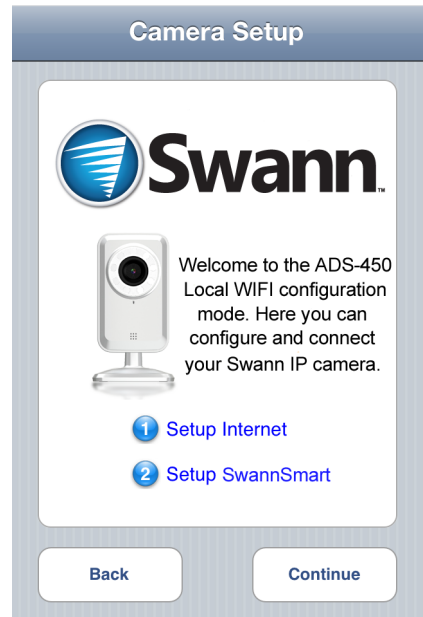
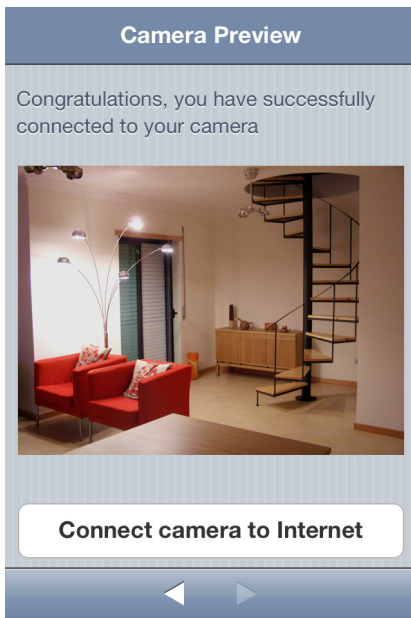

The first thing you'll see is a preview image of what your camera is seeing.

If you're not getting a picture at this stage, it indicates that something is very amiss with either the camera or your mobile device.

To continue, select **Connect camera to Internet**.

Local WIFI Configuration: Connecting to Internet

Connect to Internet

You'll need to decide whether you're using a wireless or a wired network to connect to the Internet. We suggest using the wireless connection as it's one less cable to worry about - however, wired connections don't suffer connectivity problems as often as wireless ones and are inherently more secure.

Wireless networks:

- Select the wireless network of your choice in the list presented onscreen.
- If your chosen network is secured, then you'll need to enter the **network key**. **We strongly suggest using a secure wireless network.**

Wired Networks:

- Ensure that the camera is connected to your network with a high quality ethernet cable (cat5e or higher).
- Choose **Use Ethernet**.

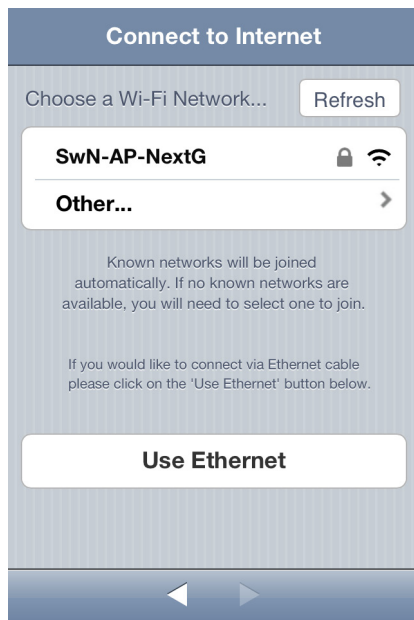

IMPORTANT: Turning off Local WIFI Configuration

Once you're finished configuring the camera (make sure you register an account if you have to - see the next page) **ensure that you set the Local Configuration WIFI switch to OFF.**

Until the Local Configuration WIFI switch is OFF, the camera won't connect to the network of your choice, as it will still be acting as an ad-hoc wireless network hub.

Registering Your Account with SwannSmart

To access your ADS-450 via the Internet, you'll need to setup a *SwannSmart* account.

- Accounts are easy to setup, and it only takes a moment.
- You can create an account during the **Local WIFI Configuration** step, or you can do it via the SwannSmart website.

Register an Account during Local WIFI Configuration

- You'll automatically be taken to the Connect to *SwannSmart* interface once you've connected the camera to the Internet.
- If you've already registered with SwannSmart, choose **Use Existing**.
- If you need to make a new account, enter a **Username**, **Password** (and **Confirm**) and a valid **Email** address.
- Then choose **Continue**.

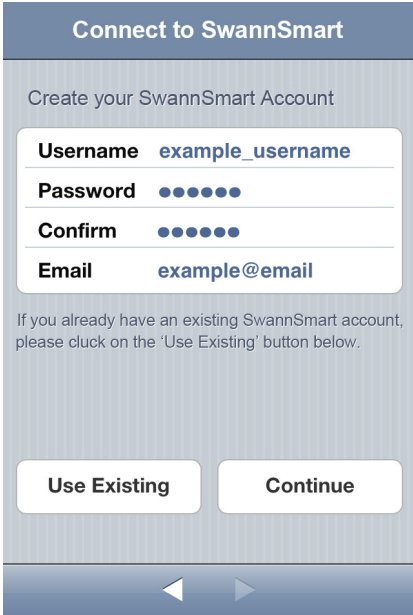

The screenshot shows a mobile interface titled "Connect to SwannSmart". Below the title is the instruction "Create your SwannSmart Account". There are four input fields: "Username" with the value "example_username", "Password" with six dots, "Confirm" with six dots, and "Email" with the value "example@email". Below the fields is a note: "If you already have an existing SwannSmart account, please click on the 'Use Existing' button below." At the bottom are two buttons: "Use Existing" and "Continue". Navigation arrows are visible at the very bottom of the screen.

Note that you can only log into one device at a time.

Register an Account with SwannSmart via the Website

- Open a web browser and enter www.swannsmart.com in the address bar.
- On the *SwannSmart* website, click the button labelled "Register".
- Enter your username and a valid email address, then choose a password and confirm it.

**Ensure that you use a valid email address:
If anything goes wrong with your account, or if you forget your password,
this is how we'll verify that you're really you.**

Interface: Login & Camera List

Logging In

Once the camera has been configured and connected to the Internet, and the Local WIFI Configuration switch has been turned OFF, then you'll be able to login to your account and view images from the camera.

Remember: You may need to adjust the WIFI settings on your mobile device - some phones/tablets don't automatically switch wireless networks when it loses connectivity.

To login:

- Enter your **Username** and **Password** into the fields provided.
- Choose **Login**.

The Camera List (below, left)

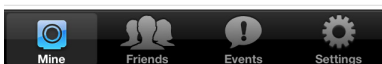
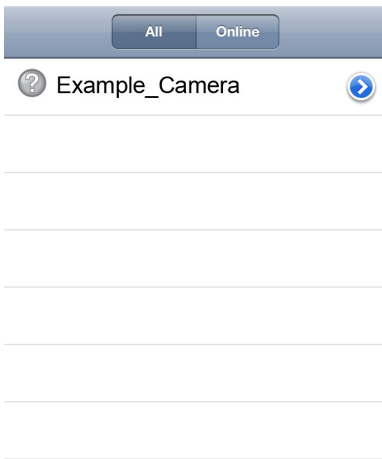

The camera list will show you a list of all devices that you've registered with *SwannSmart*, as well as any friend's cameras to which they've granted you access.

The **Mine** camera list will show you all your camera(s). Choose the  icon to adjust the settings for that camera (see "Interface: Camera Settings" on page 15 for details).



The Camera List: Friends (right)

The **Friends** camera list works much the same way as the **Mine** list. The main difference is that you can't change the settings on friend's cameras.

- ### Icons:
-  The camera can be detected.
 -  *SwannSmart* can't detect the state of the camera.
 -  The camera is **not** online.

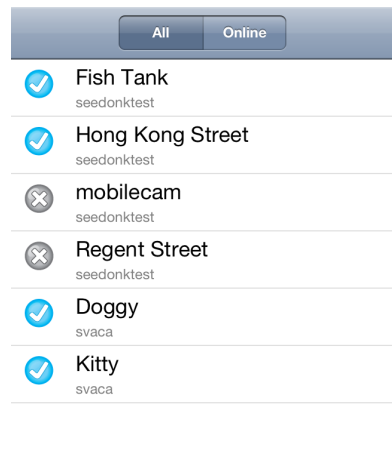

Navigating the Mobile Interface



The navigation bar gives you access to the various interfaces, camera lists and settings contained within the *SwannSmart* app.



Mine: Opens the list of cameras that are registered to you, as shown in "Interface: Login & Camera List" on page 11.

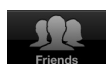

Friends: Shows a list of friend's cameras to which they've granted you access, as well as "demo" cameras.



Events: If you've expanded your service to include motion and/or event detection recording, then you'll be able to access a log here.



Settings: Opens the local settings page (see "SwannSmart App Settings" on page 17 for details). Note that the App Settings screen is quite separate from the Camera Settings screen (see "Interface: Camera Settings" on page 15).

Access via the *SwannSmart* Website

From a web browser, you can login to your account via the *SwannSmart* website. You'll be able to view images from your cameras, as well as configure the advanced aspects of your account and/or expand your service(s) - see "Expanding Your Service" on page 18 for more.

Simply open a web browser and enter:

www.swannsmart.com







into the address bar.

Interface: Live View



The **Live View** interface is the default interface when you open a camera from the list. The image will always be displayed in landscape mode (where the device is held so that the screen is wider than it is tall). Other modes (such as the **Event** interface) use a portrait orientation.

Icons

-  Exits the camera's feed and returns you to the camera list.
-  Alters the size of the video. You can stretch an image across the whole screen (as pictured above) or reduce the size to "actual pixels" (if your mobile device has a high enough resolution to display the video - if your device has a low resolution, the image may actually expand).
-  Toggles the video streaming on and off (audio will continue while video is off).
-  Captures a snapshot of the current image, and saves it to the **Gallery / Images** folder on your mobile device.
-  Triggers local recording, or stops a recording in progress.
-  Toggles audio on and off.

Interface: Events

Shown here is an example of the Events interface as seen on an iPhone.

The Android app will appear slightly different, but is functionally similar.

Note that you'll need to properly configure and upgrade your SwannSmart account before you can access the Event interface.

Event List

The events recorded are listed here in chronological order. Select an event to begin viewing the recorded slideshow - the number on the right hand side indicates how many images are contained within the slide show for that event.

Newer/Older: Skips back or forth through events, allowing you to quickly scan through event history.

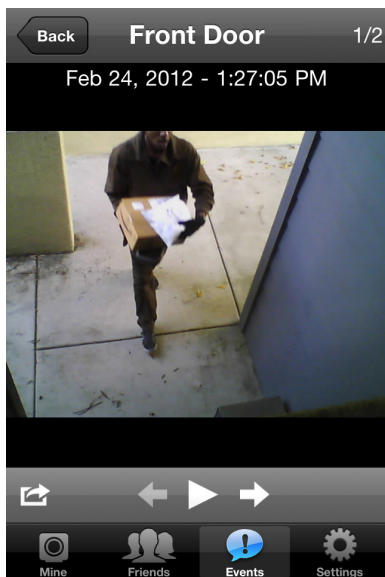
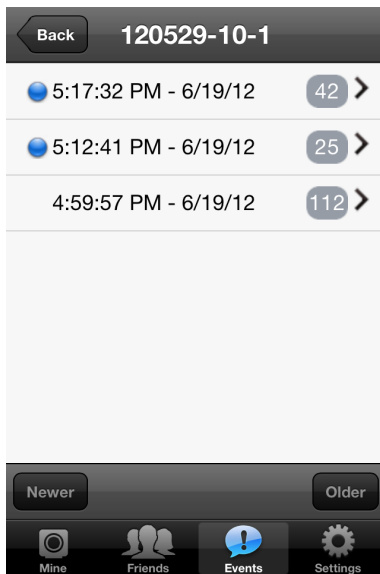

The Event Playback Screen

Back (Top Left): Leaves the camera interface and returns to the camera list.

Previous: Changes the view to the previous image (event) on the list.

Next: Changes view to the next image (event) on the list.

Play: Plays/pauses the slideshow.

Interface: Camera Settings



General

Name: The title you've selected for the camera during the **Local WIFI Configuration** stage.

Share/Unshare: Whether you want to share access to this camera with other people using *SwannSmart*. There's no requirement to share, and - if you choose to do so - you can be very specific about who has access. **All users/cameras involved require properly configured *SwannSmart* accounts to use this feature.**

Status: Whether the camera is currently detected as being online or not.

Online: *SwannSmart* can detect your camera over the Internet, and foresees no problem with connecting to it and streaming images.

Offline: The camera cannot be detected by the *SwannSmart* server.

Video

Rotation: The orientation of the camera's images on your screen. If you've mounted the camera on the ceiling or using the mounting bracket (i.e. upside down) then this option will flip the image "the right way up".

IR: The behavior of the infrared LEDs, which are responsible for the ADS-450's night vision capabilities - you can think of them like an invisible spotlight that only the camera can see.

Regular Stream

The options listed under **Regular Stream** will affect the way that images are streamed from the camera over the Internet. These settings will affect both the perceived quality of your images, as well as the bandwidth required to send/receive them.

Frame Rate: The number of images per second the camera will send over the Internet. The higher the frame rate, the “smoother” motion in your video will appear. However, high framerates require much more bandwidth than low framerates.

Quality: Adjusts the bit-rate of the video being streamed. A high quality (bit-rate) will feature crisp, sharp images but requires a lot of bandwidth. A low quality setting requires much less bandwidth, but will look a little fuzzy.

Video Size: The resolution of the video being streamed. The higher the resolution, the more data will be required to cleanly reproduce the image (and you’ll need a correspondingly higher Quality setting to maintain per-pixel sharpness).

Note: The three parameters above (**Frame Rate**, **Quality** and **Video Size**) are inextricably linked to one another. For example, if you want the maximum clarity in your images but want to reduce bandwidth, a high Video Size and a high Quality setting with a low Frame Rate may be the best combination.

We suggest experimenting with these settings to figure out what works best for you.

Audio

Microphone: The internal microphone can be enabled or disabled here. When the microphone is off, no sound will be sent from the camera or recorded.

iSecurity + Services

The advanced **iSecurity + Services** features are available only for registered SwannSmart accounts which have additional services selected. See “Expanding Your Service” on page 18 for more information.

Motion Detection: Toggles motion detection on or off.

Sensitivity: How much motion must occur before the camera registers motion.

Email Notification: Turns email notifications on or off. The conditions that generate an email notification as well as the recipient’s email address must be correctly configured for the email function to work - you can set this up from the SwannSmart website.

Phone Notification: Enables or disables notifications to be sent to your phone in the form of push notifications. You’ll need to properly upgrade and configure your SwannSmart account (see the website for up-to-date details) for phone notifications to be an available option.

SwannSmart App Settings

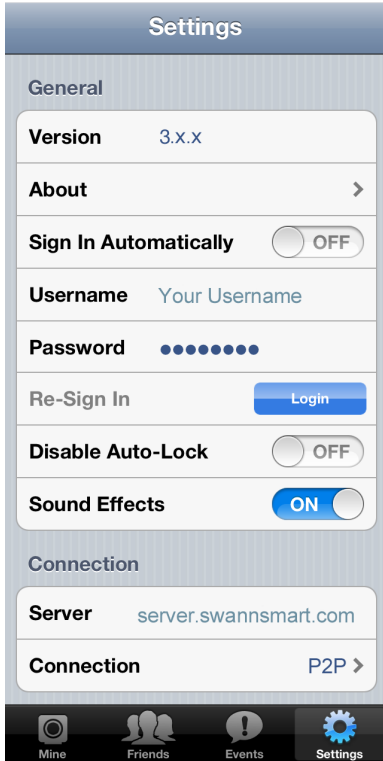

General

Version: The version number of the mobile app you're running. You might need to know this number if you're in contact with Swann Technical Support - however, if you've got auto-updates enabled for your phone/tablet, you should be using the most recent one by default. (The "x"s will be numbers.)

About: The release notes and general information for the app. Basically, it's stuff that we didn't write here because we didn't think of it or it hadn't happened yet.

Sign In Automatically: When enabled, *SwannSmart* will automatically login to your account whenever the app is booted. When disabled, the app will ask for your username and password each time, although it will remember them: you'll need to confirm signing in.

Username: The username you used when you registered with *SwannSmart*.

Password: The password you selected when you registered with *SwannSmart*.

Re-Sign In: Whether you want the *SwannSmart* app to automatically re-sign in when your connection times-out.

Disable Auto-Lock: When auto-lock is disabled, your phone won't automatically lock after a period of inactivity. This can be useful if you're watching images in real-time and don't want the screen to turn off. However, it can be troublesome if you leave the app running and pocket the phone - you'll probably wind up pocket dialing someone.

Sound Effects: You can turn the application's sounds on and off here. This won't affect the internal microphone in your camera, just the notification/warning sounds that the *SwannSmart* app makes.

Connection

Server: The server you're using to access images from your cameras. This should be set to server.swannsmart.com. **Do not change this unless instructed to by Swann technical support staff.**

Connection: The type of connection that you want to use. By default - and unless you're some kind of evil networking genius - this should be **P2P**.

Expanding Your Service

So, you've got your ADS-450 connected to the internet, you've signed up for your free account and are enjoying the *seriously-this-was-like-totally-sci-fi-like-ten-short-years-ago* feeling of viewing images from your camera(s) from your phone... but it's just not enough, eh?

Well then: **good news, everyone!** *SwannSmart* offers loads of additional services including (but not limited to):

- **Secure online cloud-based data storage.** Never lose a recording or risk missing an event.
- **Security-based event recording with motion detection.** Never miss something that happens!
- **Push notifications.** Don't wait to find out what's going on, have the information sent directly from *SwannSmart's* secure online server direct to your phone/tablet!
- **Advanced video codecs.** Get better quality images and/or reduce the bandwidth required to transmit them.

We're continually expanding the services that *SwannSmart* offers, and finding ways to improve the performance and functionality of your Swann IP camera.

We offer several competitive plans that you can choose from to find the best combination of services for your unique needs. As these are continually changing, check out the website for the most up-to-date information possible.

www.swannsmart.com

Note: A small subscription fee may apply to some additional services.

Technical Specifications

Video	Resolution	640 x 480
	Frames Per Second	30fps (max)
Audio	Microphone	1-way (camera to mobile device)
Recording	Snap Shot Format	JPEG
	Video Record function	MJPEG
Network	Connections	Wireless / Wired
	Access	HTTP

Warranty Information

Swann Communications USA Inc.
12636 Clark Street
Santa Fe Springs CA 90670
USA

Swann Communications
Unit 13, 331 Ingles Street,
Port Melbourne Vic 3207

Swann Communications LTD.
Stag Gates House
63/64 The Avenue
SO171XS
United Kingdom

Limited Warranty Terms & Conditions

Swann Communications warrants this product against defects in workmanship and material for a period of one (1) year from its original purchase date. You must present your receipt as proof of date of purchase for warranty validation. Any unit which proves defective during the stated period will be repaired without charge for parts or labor or replaced at the sole discretion of Swann. The end user is responsible for all freight charges incurred to send the product to Swann's repair centers. The end user is responsible for all shipping costs incurred when shipping from and to any country other than the country of origin.

The warranty does not cover any incidental, accidental or consequential damages arising from the use of or the inability to use this product. Any costs associated with the fitting or removal of this product by a tradesman or other person or any other costs associated with its use are the responsibility of the end user. This warranty applies to the original purchaser of the product only and is not transferable to any third party. Unauthorized end user or third party modifications to any component or evidence of misuse or abuse of the device will render all warranties void.

By law some countries do not allow limitations on certain exclusions in this warranty. Where applicable by local laws, regulations and legal rights will take precedence.

For Australia: Our goods come with guarantees which cannot be excluded under Australian Consumer Law. You are entitled to a replacement or refund for a major failure and for compensation for any other reasonably foreseeable loss or damage. You are also entitled to have the goods repaired or replaced if the goods fail to be of acceptable quality and the failure does not amount to major failure.

Helpdesk / Technical Support Details

USA toll free

1-800-627-2799

(Su, 2pm-10pm US PT)

(M-Th, 6am-10pm US PT)

(F 6am-2pm US PT)

USA Exchange & Repairs

1-800-627-2799 (Option 1)

(M-F, 9am-5pm US PT)

AUSTRALIA toll free

1300 138 324

(M 9am-5pm AUS ET)

(Tu-F 1am-5pm AUS ET)

(Sa 1am-9am AUS ET)

NEW ZEALAND toll free

0800 479 266

UK

0203 027 0979



Swann
© Swann Communications 2012

Free Manuals Download Website

<http://myh66.com>

<http://usermanuals.us>

<http://www.somanuals.com>

<http://www.4manuals.cc>

<http://www.manual-lib.com>

<http://www.404manual.com>

<http://www.luxmanual.com>

<http://aubethermostatmanual.com>

Golf course search by state

<http://golfingnear.com>

Email search by domain

<http://emailbydomain.com>

Auto manuals search

<http://auto.somanuals.com>

TV manuals search

<http://tv.somanuals.com>