

SHARP®

ELECTRONIC ORGANIZER

MODEL
IQ-8900
IQ-8920

OPERATION MANUAL



I ntroduction

Congratulations on purchasing the IQ-8900/IQ-8920 unit. Please read this operation manual thoroughly to familiarize yourself with all the features of the unit and to ensure years of reliable operation. You may also find it useful to keep this operation manual on hand for reference.

- The only difference between the IQ-8900 and the IQ-8920 is memory capacity.
- Unless otherwise specified, the text and materials in this manual apply to both models,

One of the models or certain accessories described in this manual may not be available in your country when you purchase this product.

Check with your local SHARP dealer concerning availability.

All company and/or product names are trademarks and/or registered trademarks of their respective manufacturers.

NOTICE

- SHARP strongly recommends that separate permanent written records be kept of all important data. Data may be lost or altered in virtually any electronic memory product under certain circumstances. Therefore, SHARP assumes no responsibility for data lost or otherwise rendered unusable whether as a result of improper use, repairs, defects, battery replacement, use after the specified battery life has expired, or any other cause.
- SHARP assumes no responsibility, directly or indirectly, for financial losses or claims from third persons resulting from the use of this product and any of its functions, such as stolen credit card numbers, the loss of or alteration of stored data, etc.
- The information provided in this manual is subject to change without notice.

To open the unit.

Press the lock button and open the unit.

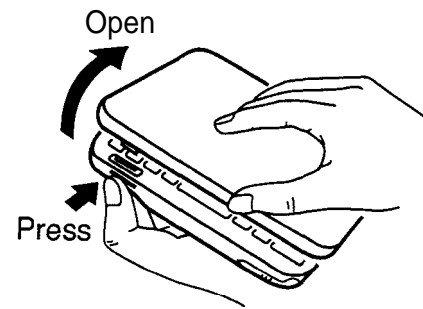

To remove/replace the touch pen.

To remove the touch pen, which is installed at the front right of the unit, pull in the direction indicated.

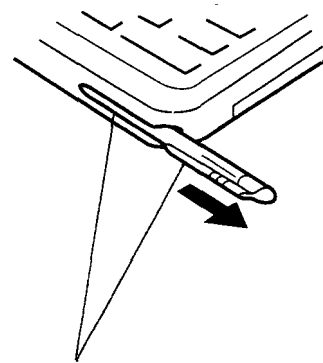

To replace the touch pen, slowly push the pen point back into place (push in the opposite direction to that indicated), then check the pen is safely secured.

Take care to ensure the ridge grip on the touch pen aligns correctly with the mounting slot.

Caution:

Use only the attached touch pen to operate with the display.

Do not use a pencil or any other sharp pointed object, and always keep the point of the touch pen and the display clean, to prevent scratching and damage to the display.

Display angle adjustment

The display can be adjusted to any angle to make reading easy.

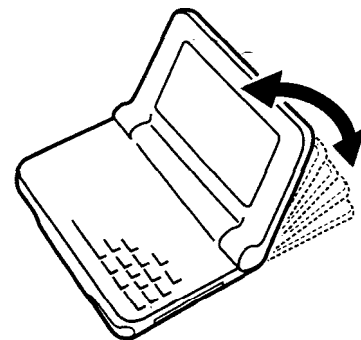



Quick Start

Important things to do:

- Please read through this Quick Start section even if you hate to read operation manuals. The Quick Start section will get you up and running with your unit in just a few minutes. Refer to the rest of the manual for more details about a particular operation.
- Please read through the section for answers to commonly asked questions. There is a good chance that any general questions you have about your unit will be answered there.
- 3** Press (2nd) ^{HELP} **H** when you need help using a particular application on the unit. The on-screen help is a quick reference guide explaining various controls and their functions.

Installing (or replacing) the batteries

- 1 Set the battery replacement switch on the back of the unit to "REPLACE BATTERIES" (exposing the red dot). (Fig. 1)

- 2 Slide off the operation battery cover. (Fig. 1)

- 3 Insert the two batteries atop the ribbon tab, as shown. (Fig. 2)

- 4 Replace the operation battery cover. (Fig. 3)

- 5 Set the battery replacement switch to "NORMAL OPERATION". (Fig. 3)

If this is the first time you have installed batteries in your unit, proceed to the following steps.

- 6 While holding down the **ON** key on the keyboard, push the **RESET** button on the back of the unit using the touch pen or a similar object.

- 7 When a message appears, touch **YES** to initialize the unit, completely clearing the memory.

On average, you can expect to get about two months of battery life based on one hour a day of constant use. Actual battery life will vary depending on individual use.

See "Getting the Unit Up and Running," Chapter 1, for more details.

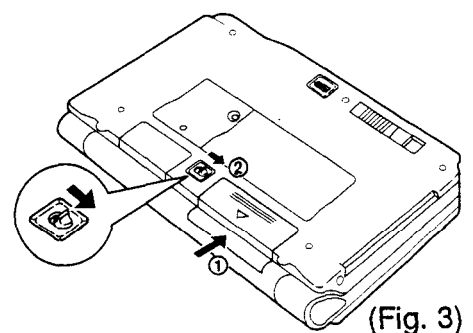
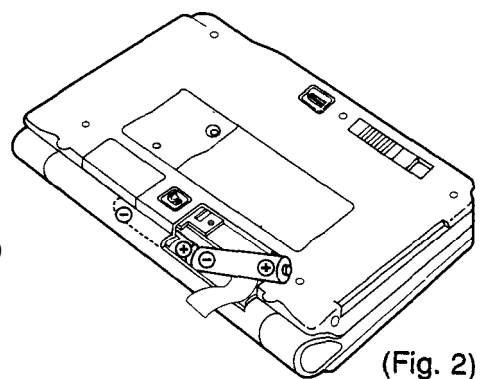
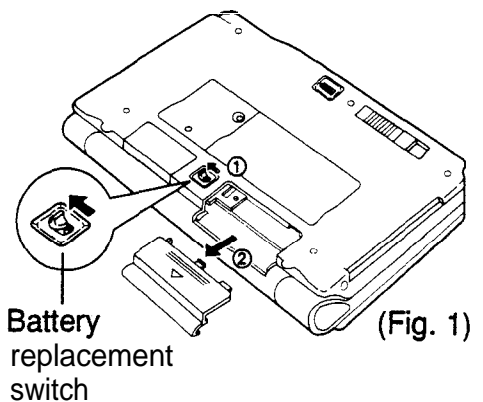

Adjusting the touch panel

Before using the unit, you should adjust the touch panel to ensure optimal response when touching or writing on the display.

- 1 Press **MENU** and then touch **TOOLS** to open the TOOLS menu.

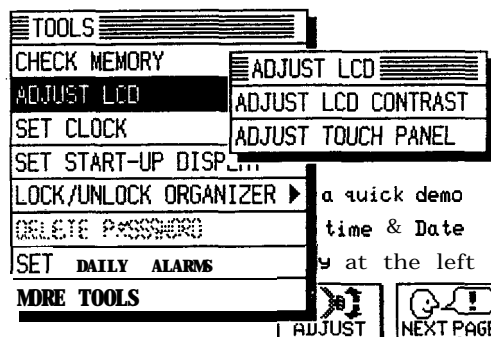

- 2 Touch **ADJUST LCD** on the TOOLS menu and then touch **ADJUST TOUCH PANEL** on the submenu.

- 3 Touch all four of the cross-points with the touch pen.

Note: If the display is not cleared from the screen, verify that you have touched each point. (Points that have been touched appear gray.)

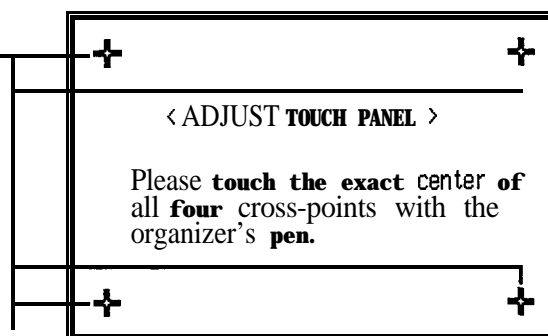

See "Getting the Unit Up and Running," Chapter 1, for more details.

Adjusting the LCD contrast

You may find it necessary to adjust the LCD contrast to suit certain lighting conditions.

- 1 Press (MENU) and then touch **TOOLS** to open the TOOLS menu.

- 2 Touch **ADJUST LCD** on the menu, then touch **ADJUST LCD CONTRAST** on the submenu.

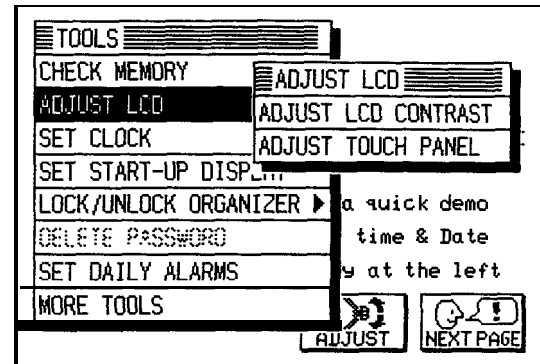

- 3 Touch the buttons to adjust the contrast to your liking.

Note: If dark, horizontal lines appear on the display, then you have set the contrast too dark. Simply lighten it until the lines disappear.

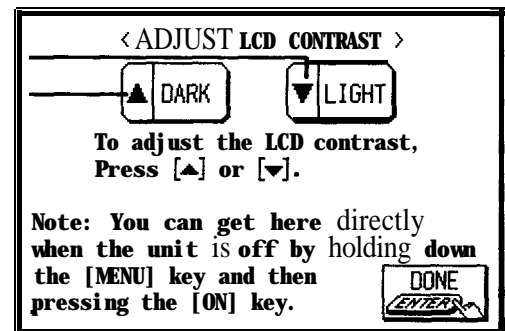

- 4 Touch **DONE** when you are finished.

See "Getting the Unit Up and Running," Chapter 1, for more details,

Setting the time and date

1 Press **ON** and touch



(If the demo has already been disabled, select SET CLOCK from the TOOLS menu, then select ADJUST TIME/DATE from the submenu.)

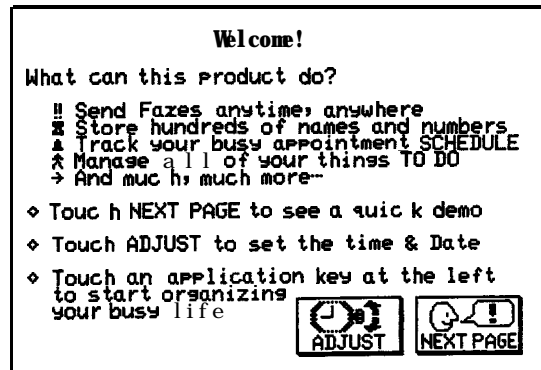

2 Touch to set your home city.

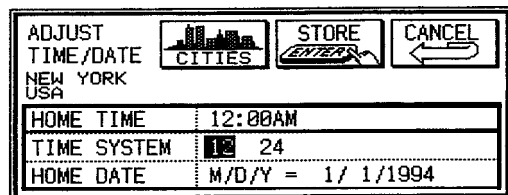

3 Press the first letter of the name of your home country, then press until you find a city in your time zone.

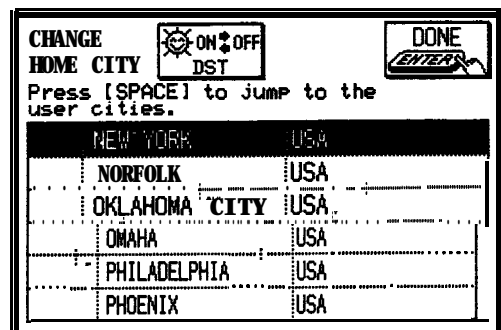

4 Touch the city to select it and then touch .

5 Type the correct time and then press twice.

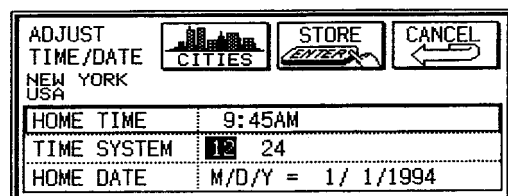

(For example: **0** **9**
AM
4 **5** **%** for 9:45 AM.)

6 Type the correct date and then touch .

(For example: **0** **(5)** **0** **3** **1** **9** **9** **4** for May 3, 1994.)

See "Getting the Unit Up and Running," Chapter 1, for more details.

Disabling the demonstration start-up display

Your unit comes with a built-in demo which is turned on by default. You will most likely want to shut this off at this time.

1 Press **MENU** and then touch **TOOLS** to open the TOOLS menu.

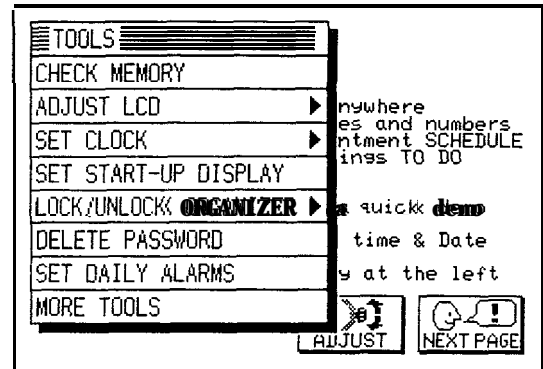

2 Touch **SET START-UP DISPLAY**.

3 Touch OFF in the box next to START-UP to disable the demo start-up display.

If you want your name, number and address to be displayed on start-up, touch ON instead of OFF.

GLOBE is the default start-up display. To paste in a picture you have copied from Scrapbook, select USER'S and then type **2nd PASTE**.

Type in your name, number, and address here.

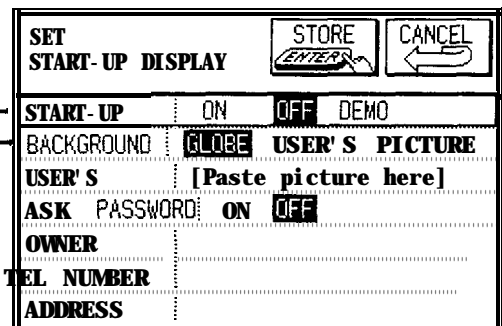

Touch **STORE** to save all the changes.



See "Setting the Start-Up Display," Chapter 9, for more details.

Making your first entry (a Telephone entry)



Note: The procedures described in the example below can be used in many of this unit's applications.

1 Press .

2 Press .

3 Type in a name, press , type in a number, press , then type in an address.

Use  to move to the next line within a field.

Use  or  the cursor keys to correct mistakes.

4 Touch  when you are finished.

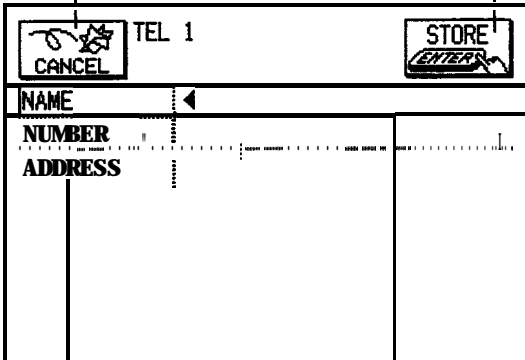

The screenshot shows a form titled 'TEL 1'. At the top left is a 'CANCEL' button with a hand icon, and at the top right is a 'STORE' button with a hand icon and the word 'ENTER' below it. Below the title are three input fields: 'NAME', 'NUMBER', and 'ADDRESS'. The 'NAME' field is currently selected, indicated by a dark outline and a cursor arrow pointing to the right. The 'NUMBER' and 'ADDRESS' fields are also outlined but not selected. Annotations with lines pointing to the buttons and fields provide instructions: 'Touch here to cancel the new entry.' points to the CANCEL button; 'Touch here to store the entry into memory.' points to the STORE button; 'Simply touch a field name to select the field for data entry.' points to the NAME field; and 'The dark outlines around a field indicates that it is selected.' points to the dark outline around the NAME field.

Simply touch a field name to select the field for data entry.

The dark outlines around a field indicates that it is selected.

See "Making a New Entry," Chapter 2, for more details.

Jotting down a quick note into the Scrapbook

1 Press  .

2 Take the pen and write a note on the display.

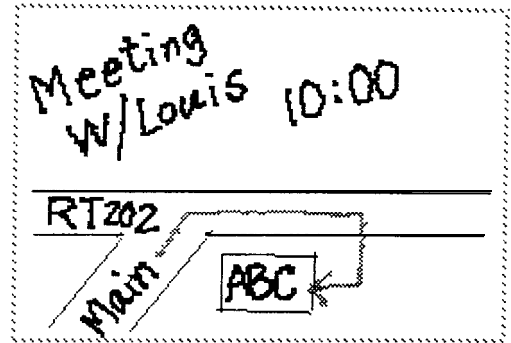

3 Press **ENTER** when you are finished drawing.

Now you can close the Scrapbook by pressing another application key or press **NEW** to create other drawings.

Other Scrapbook Features

Use **PREV** , **NEXT** to view other scrapbook entries.

Use **MENU** to access other features.

Touch **VIEWS** .

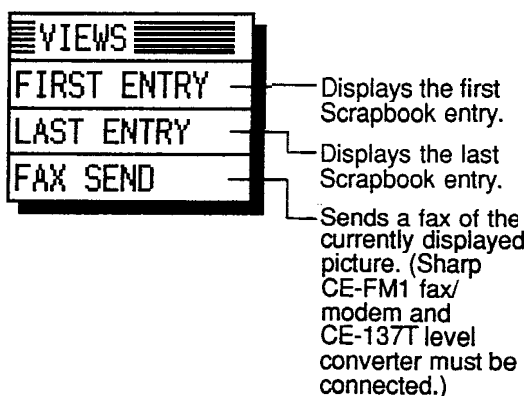

Touch **MODIFY** .

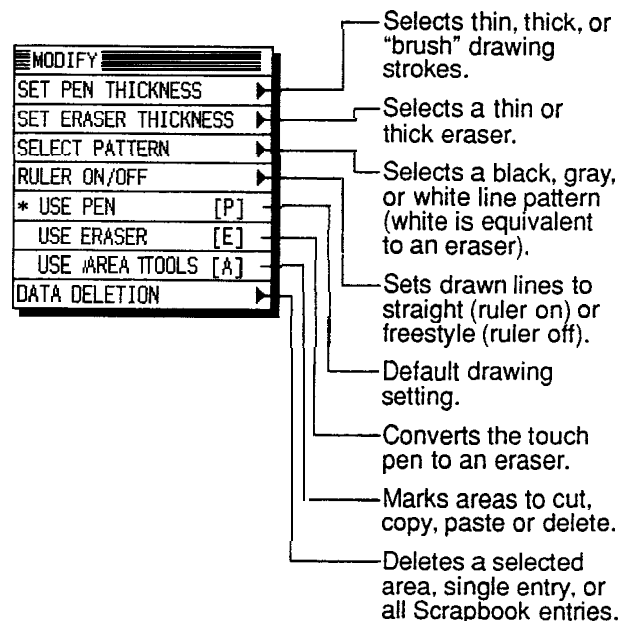

See "The Scrapbook Application," Chapter 6, for more details.

Recording an appointment

- 1 Press  .
- 2 Touch the day you wish to make an appointment on.

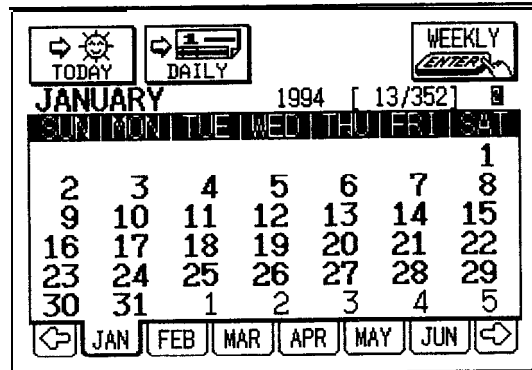

- 3 Press  .

- 4 Touch the time bar at the time the appointment begins, then touch it again at the time the appointment ends.

You can also use the keyboard to enter the times if your appointment does not fall on the hour or half-hour.

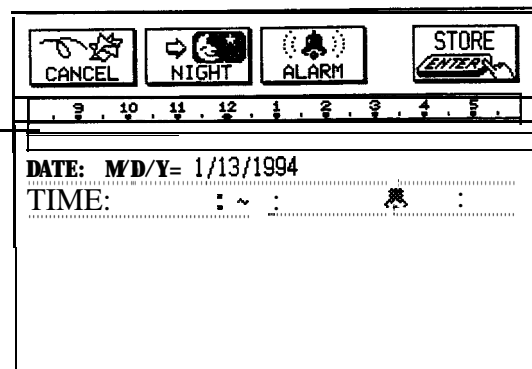

- 5 Press  and type in a description. (Example: "Meeting with Pat")

If you want to set an alarm to remind you of the appointment,

touch  now.

- 6 Touch  to store the entry into memory.

See "The Schedule Application," Chapter 3, for more details.

Moving an appointment

Appointment times and dates can frequently change. Rather than re-typing the information, you can easily change an appointment stored in the unit.

- 1 Find the Schedule entry you want to move.
- 2 Press **EDIT**.
- 3 Press **PREV** and type in the new date (if the date has been changed).
- 4 Press **NEXT** to move to the time field and touch the time bar at the time the appointment begins, then touch it again at the time the appointment ends (if the time has been changed).
- 5 Touch **STORE** to save the changes.

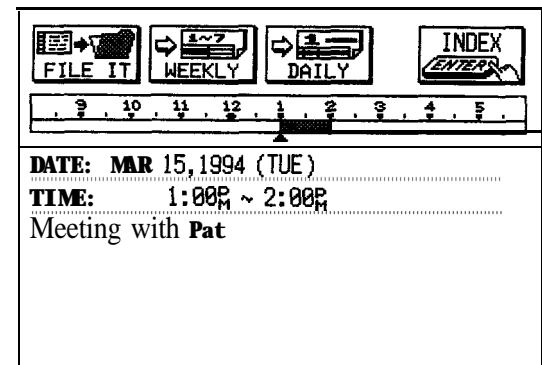
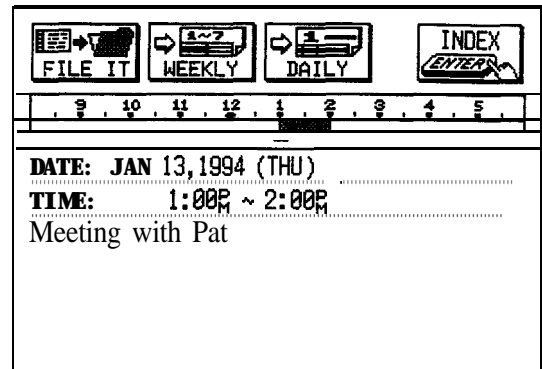

Note: You can also use the Cut and Paste functions to move an appointment. See p. 207.

See "The Schedule Application," Chapter 3, for more details.

Entering a To Do item

1 Press .

2 Press .

3 Type in a description.

4 If desired, type in any other information.

You can assign the task a priority using a single character. (0 ~ 9 or A ~ Z).

Type in a due date here if the To Do item has one.

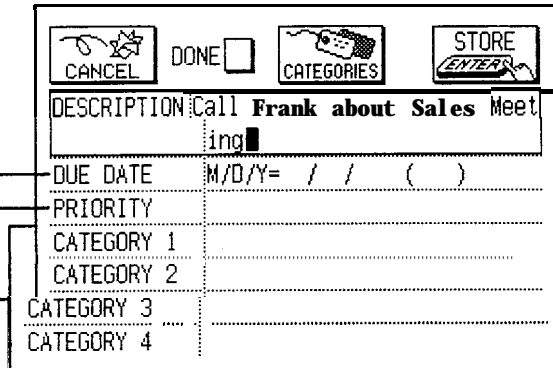

CANCEL		DONE		CATEGORIES		STORE	
DESCRIPTION: Call Frank about Sales Meeting							
DUE DATE		M/D/Y= / / ()					
PRIORITY							
CATEGORY 1							
CATEGORY 2							
CATEGORY 3							
CATEGORY 4							

You can assign up to 5 categories to a task, then later use these to filter the item in a To Do list.

5 Touch  when you are finished.

You can now press  to see a list of all your To Do items or you can review them in the Calendar views.

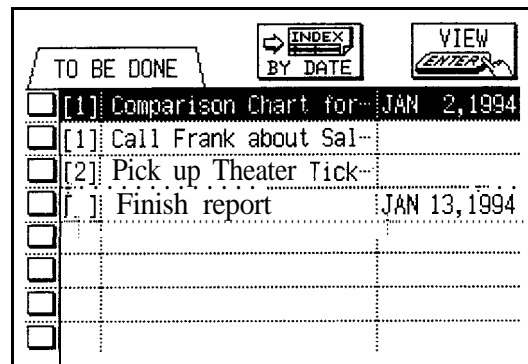

TO BE DONE		INDEX BY DATE		VIEW	
<input type="checkbox"/>	[1]	Comparison Chart for	JAN 2, 1994		
<input type="checkbox"/>	[1]	Call Frank about Sal			
<input type="checkbox"/>	[2]	Pick up Theater Tick			
<input type="checkbox"/>	[]	Finish report	JAN 13, 1994		
<input type="checkbox"/>					
<input type="checkbox"/>					
<input type="checkbox"/>					

See "The To Do Application," Chapter 3, for more details.

Searching for information anywhere in the unit

1 Press .

2 Type in any word stored in an entry that you want to search for.

You can use up to 16 characters (letters, numbers, symbols, etc.).



If you highlight a word in an entry



with the pen and then press ,

that word will automatically appear in the search word box.

3 Select the application you want to search.

The application you were using last will always be the default application.

4 Touch  to begin searching (or touch  to search in all applications).

5 Touch  until you find the entry you are looking for, then touch .

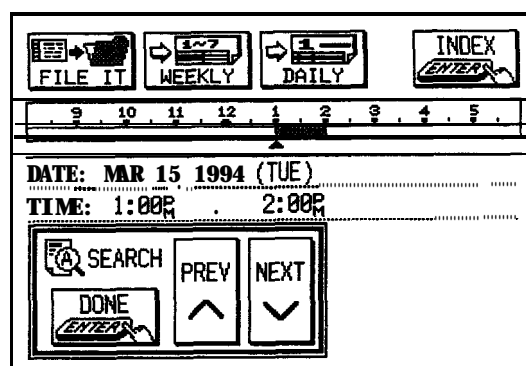
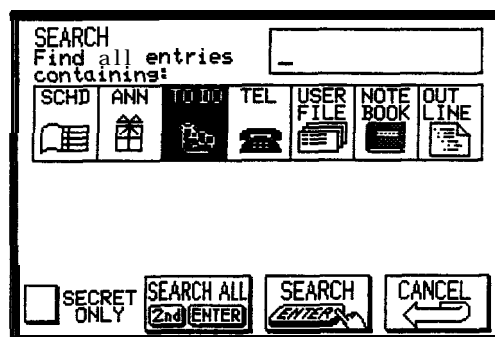

See "General Operation," Chapter 2, for more details.

Finding an entry from the Index mode

The Index modes for Tel, User File, Outline and Notebook are very similar.



- 1 Select an application and go to the Index mode.

Touch these tabs to jump to these alphabetical listings.

Touch  with a desired name highlighted or touch a name twice to view a particular entry in full.

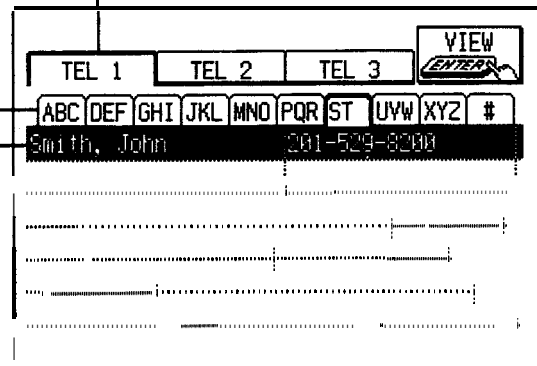
Touch one of these tabs to select the file.



Press  to edit the selected entry, or press  to delete the selected entry.

- 2 Type the first few letters of an entry to begin the Go To search.

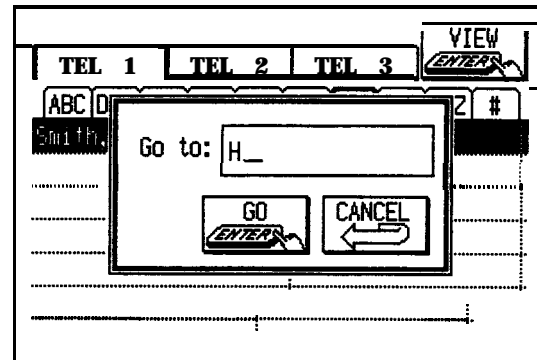

- 3 Touch  to jump to the entry that starts with these letters.

- 4 Press  until you see the entry you are looking for.

See "General Operation," Chapter 2, for more details.

Using the Calendar views

The Calendar consists of 5 different views: a 3-month, 1-month, 1-week, 1-week (graphical), and a 1-day view. These views allow you to see information stored in Schedule, Ann and To Do.

- 1** Press  to display the 1-month view.

Exclamation points indicate To Do items.

Reversed dates indicate Anniversary events.

Dots indicate appointments.

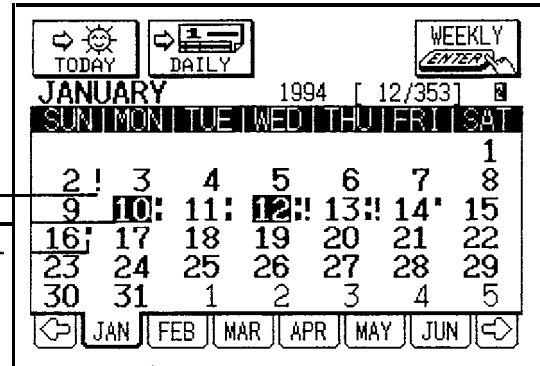

- 2** Touch a date and then touch  to see more details.

Touch to hide Schedule and Ann information so that only To Do information is visible. Touch again to restore the hidden information.

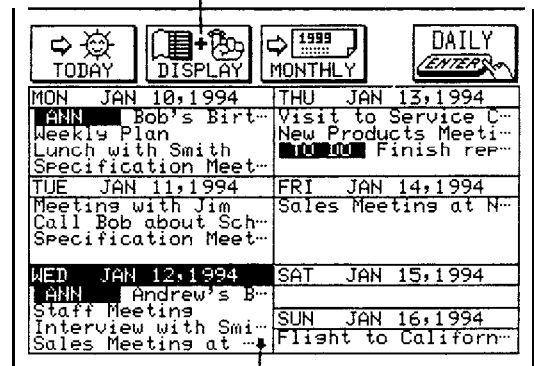

This symbol indicates there are more entires on this day.

See "The Calendar Application," Chapter 3, for more details.

- 3** Touch  to see the details of the selected date.

This time bar shows you when you have appointments and when you have free time.

You can mark To Do items off as done by touching here.

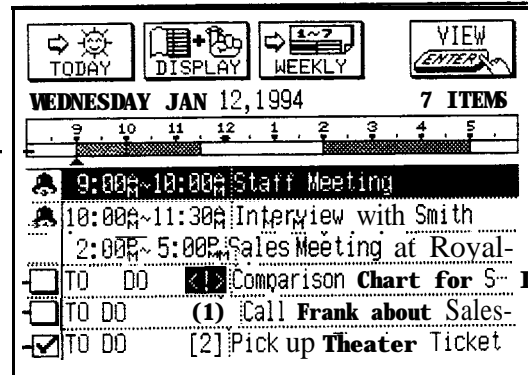

- 4** Touch an entry to select it and then touch  to go to that entry's application.

Note: The Calendar application only displays information stored in Schedule, Anniversary, and To Do. You cannot actually store information in the Calendar application.

If you press  in any of these views, the unit will assume you want to make a new Schedule entry on the currently selected date.

You can access any of these views directly by pressing (MENU) and then touching .

See "The Calendar Application," Chapter 3, for more details.

Editing an Entry

1 Find an entry that you wish to change.

2 Press [EDIT].

3 Make any necessary changes.

You can also drag the pen over text to select it, then cut the text and paste it elsewhere, or just delete it.

The screenshot shows a contact entry form titled "TEL 1". At the top left is a "CANCEL" button with a pen icon, and at the top right is a "STORE" button with an "ENTER" key icon. The form contains three fields: "NAME" with the value "Smith John", "NUMBER" with the value "012-345-6789", and "ADDRESS" with the value "101 4th Ave, New York, N.Y. 107250, U.S.A." and a cursor. A line from the text below points to the "ADDRESS" field.

4 Touch  when you are finished.

If you make a mistake and want to restore the original entry, simply touch  instead.

If you want to save these changes as a new entry (thus preserving the original) press **2nd** **ENTER** instead.

See "Editing an Existing Entry," Chapter 2, for more details,

Deleting an Entry

- 1 Find an entry that you wish to delete.
- 2 Press **DEL**.
- 3 Touch **YES** to confirm the deletion.

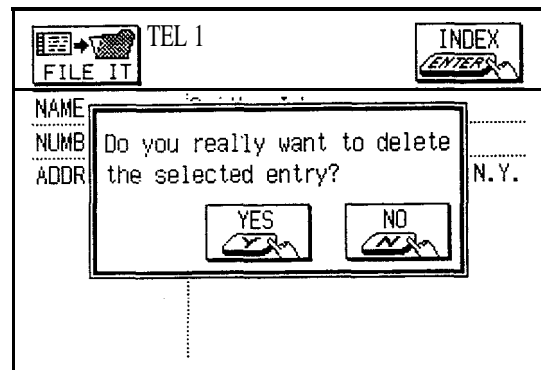

Deleting Multiple Entries

- 1 Select an application that you want to delete data from.
- 2 Press **MENU**, and then touch **MODIFY** to open the MODIFY menu.
- 3 Touch **DATA DELETION**.
- 4 Select which group of information you wish to delete. (The selection will vary for each application.)

See "Deleting Entries from the Unit," Chapter 2, for more details.

Assigning an entry to a Filer folder

Note: The entry will not be copied or moved to a folder. It is simply “assigned” to the folder. Entries assigned to folders can be worked with as usual.

- 1 Find the entry you wish to assign to a folder. Be sure to display the entry in the VIEW mode (not the INDEX).

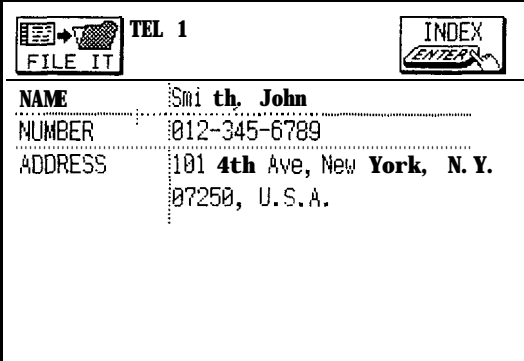

FILE IT TEL 1 INDEX
ENTER

NAME	Smith, John
NUMBER	012-345-6789
ADDRESS	101 4th Ave, New York, N.Y. 07250, U.S.A.

- 2 Touch  .

- 3 Touch the folder(s) you want to assign this entry to.

Touch once to select a folder.
Touch again to cancel a selection.

You can select multiple folders.

Note: You can assign entries to an unnamed folder and name the folder later.

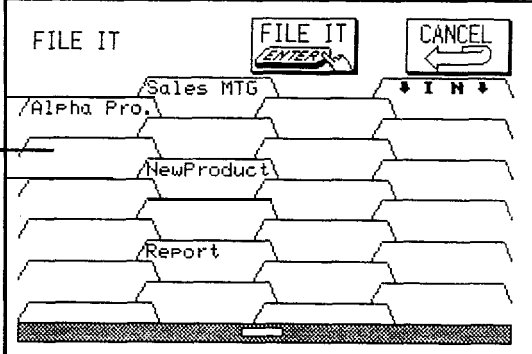

FILE IT FILE IT CANCEL
ENTER ENTER

Sales MTG
Alpha Pro.
NewProduct
Report

- 4 Touch  when you finish selecting the folder(s).

See “The Filer Application,” Chapter 7, for more details.

Using the Filer

The Filer allows you to group your entries into folders, which lets you access and manage your information by subject matter instead of just by application.

1 Press  to access your folders.

2 Touch a folder to select it. Now you can:

Press  to name (or rename) the folder.

Touch  to have the unit automatically assign a group of entries to the selected folder based on a search word.

Touch  to merge the selected folder with another folder.

Press  to send a copy of all the entries assigned to this folder to another 8900/9000 Series unit (via infrared transfer). All entries will appear in the receiving unit's "IN" folder.

Touch  to fax a copy of all the entries in the selected folder (the Sharp CE-FM1 fax/modem and CE-137T level converter are required).

3 Touch  to view all the entries assigned to the folder.

4 To go to the actual entry (VIEW mode), simply touch the entry and then touch .

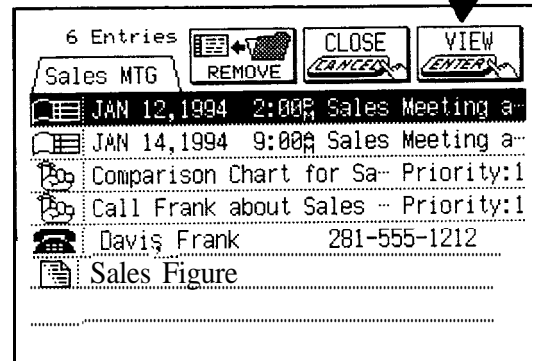
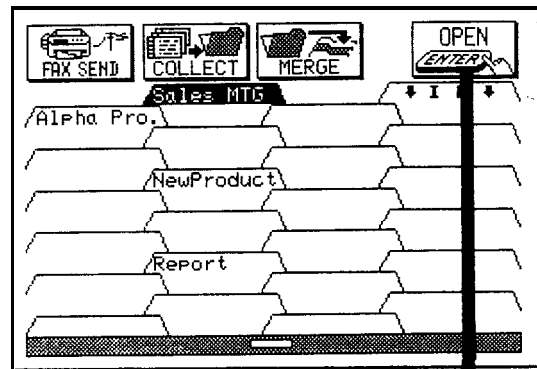

See "The Filer Application," Chapter 7, for more details.

Copying and pasting text between applications

You may find a need to copy text from one place to another in the unit.

- 1 Go to the entry you want to copy text from.

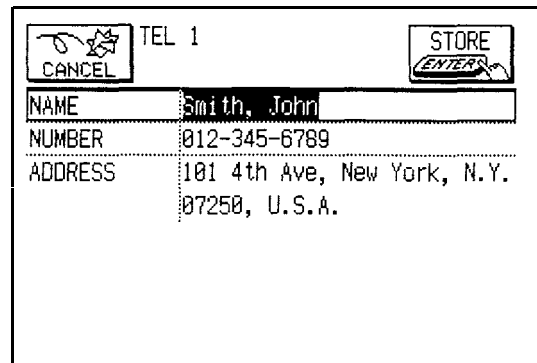

TEL 1	
NAME	Smith, John
NUMBER	012-345-6789
ADDRESS	101 4th Ave, New York, N.Y. 07250, U.S.A.

- 2 Drag the pen over a word or sentence to select it.

The text will be displayed in reverse — white on black — to indicate it is selected.

- 3 Press **(2nd) C** to copy the text to the clipboard.

Anything currently on the clipboard is replaced with the text you just copied.

- 4 Go to the entry you want to add the text to.

Be sure you are in the EDIT mode when adding text to an entry.

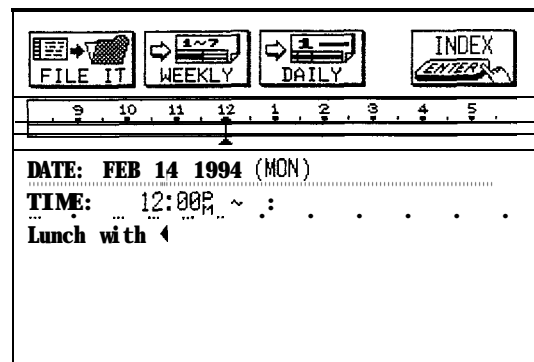

FILE IT	WEEKLY	DAILY	INDEX
DATE: FEB 14 1994 (MON)			
TIME: 12:00P ~ :			
Lunch with ↓			

- 5 Touch the desired place of insertion.

- 6 Press **(2nd) V**.

See "Copying or Moving a Block of Text," Chapter 7, for more details.

Using the Calculator

In addition to working like a standard calculator, the unit's Calculator can work with numbers stored in an entry.

- 1 Find an entry that you have stored numbers in.
- 2 Drag the pen over a number to highlight it.
- 3 Press 2nd $\overset{\text{COW}}{\text{C}}$ to copy the number to the clipboard.
- 4 Press CALC to call the Calculator.
- 5 Press 2nd $\overset{\text{PASTE}}{\text{V}}$ to enter the copied number to the Calculator.
- 6 Perform any calculations you desire by touching the Calculator's keypad.

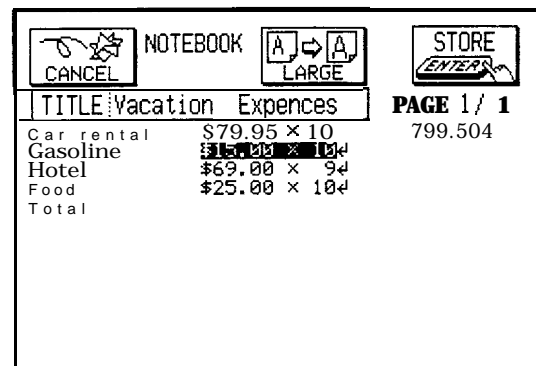

NOTEBOOK

CANCEL LARGE STORE ENTER

TITLE	Vacation Expenses	PAGE 1 / 1
Car rental	\$79.95 × 10	799.504
Gasoline	\$15.00 × 10	
Hotel	\$69.00 × 9	
Food	\$25.00 × 10	
Total		

Touch if you want to display an electronic "print out" to check calculations as you work.

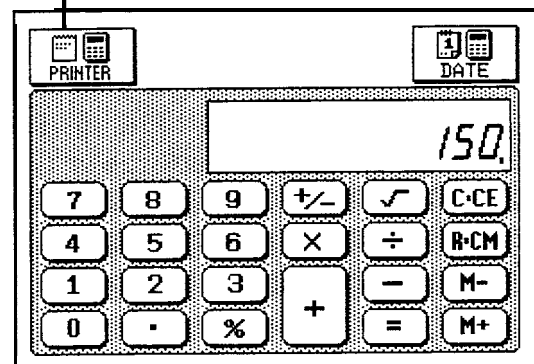

See "The Calc Application," Chapter 6, for more details.

Answers to Commonly Asked Questions

Q: *My batteries only lasted for two months. Is there something wrong? Will I lose data in memory when I change the batteries?*

A: There is probably nothing wrong with your unit. Battery life will vary from user to user. A number of factors will affect battery life, including how much the unit is used. The battery life is rated at 70 hours of continuous use. Assuming an average of one hour per day of continuous use, you would get about 2 months of battery life. Two months indicates heavier usage.

When you change the main operating batteries, the back-up battery will protect data in memory. Be sure to follow the directions carefully when changing the batteries.

An optional battery case is available, which will extend the life of your operating batteries.

Q: *I have a SHARP 8000* Series Organizer. How can I transfer my data from it to this new unit?*

A: The data format on your new unit is different to that on the 8000 Series Organizer. You can get data from the 8000 Series (or 7000 Series) one application at a time using one of the following methods:

- If you have your 8000 Series data on a RAM card, do the following:
 - Insert the RAM card into the 8900 Series.*
 - Turn on the 8900 Series.
 - Go to an application (Tel, Schedule, etc.).
 - Press **MENU** and then touch **PERIPHERALS1**, select IMPORT OTHER FORMAT, then select VIA RAM CARD.
 - Repeat the last two steps for each application you wish to import.
- If you own one of the Sharp Organizer Link software packages for an 8000 Series Organizer (either for the IBM and compatibles or the Macintosh) do the following:
 - Hook up the cable to the 8900 Series.
 - Turn on the 8900 Series.
 - Press **MENU** and then touch **PERIPHERALS**, select IMPORT OTHER FORMAT, then select VIA PC LINK.
 - Now use the link software on the PC to send the Information to the 8900 Series.



* 8000 Series: IQ-8000, 08200, IQ-8400, IQ-8100M, IQ-8300M, IQ-8500M
8900 Series: IQ-8900, IQ-8920
9000 Series: IQ-9000, IQ-9200

- You can purchase the CE-315L transfer cable. Then do the following:
 - Hook up the cable to the 8900 Series and the 8000 Series Organizer.
 - Turn on the 8000 Series Organizer and press **SHIFT** **OPTION** **4** .
 - Turn on the 8900 Series.
 - Go to an application (Tel, Schedule, etc.).
 - Press **MENU** and then touch **PERIPHERALS** , select **IMPORT OTHER FORMAT**, then select **VIA DIRECT CABLE**.
 - Repeat the last two steps for each application you wish to import.

Note: Data can only be transferred from an 8000 or 7000 Series Organizer to the 8900/9000 Series unit, and not vice versa.

The procedures above will not replace the existing data on the Organizer but add to it.

Warning: If you have used free fields in Telephone on your 8000 Series Organizer, you must set the number of fields in Telephone on the 8900 Series to be the same (8) BEFORE transferring the information to the 8900 Series. Otherwise the data in the free fields will not be transferred onto the 8900 Series.

To do this touch  , **MENU** , **MODIFY** touch **CONFIGURE** **CONFIGURE TELEPHONE 1** (or **CONFIGURE TELEPHONE 2** or **CONFIGURE TELEPHONE 3**) and then select **FILE NAME**. Enter the number of fields (at least 8) and then touch  w g o back and import the 8000 Series data. See p. 134,276 and 277.

Q: I have an older model of the SHARP Organizer and imported the data into this unit. But when I went to the Tel application in my new unit, all of my entries looked strange. Some words were split in two and some lines ended too early. The entries don't look like this in the other Organizer. What can I do?

A: In certain applications, such as Tel, the number of characters allowed per line is different from that of other Organizer models. This means that the new line characters you entered in the older Organizer will not produce the same formatting in this unit. You will need to edit the relevant entries and reformat them by deleting old new line characters and entering new ones.

Q: I saw the message "There is not enough memory..." after trying to store an entry. What does this mean?

A: You have filled your unit with information. Here are some things you should try in order to free up some memory:

1. Check your Scrapbook. These drawings take up more memory than regular entries. Be sure to delete any notes or drawings that you no longer need.
2. Check for old Schedule items. Delete those you no longer need. You can delete all Schedule entries for an entire month using the Calendar menu.
3. Check for completed To Do items. You can delete all completed To Do items using the Jo Do menu.

If you wish, you can purchase a memory expansion RAM card. You can use these cards like floppy disks, keeping several to store your data by subject, for example.

Q: *I want to print out my unit information. What do I need?*

A: Here are the things you will need:

1. The SHARP CE-IR1 wireless interface for printers.
2. Any parallel PC printer that emulates one of the following printers:

Canon	BJ-1 Oe series
IBM	ProPrinter series
Epson	FX series, LQ series
Hewlett-Packard	LaserJet series

Most printers, including portable ink-jet printers on the market today, emulate at least one of these printers. Check with your local computer dealer for more information about printers.

Q: *How can I back up my data?*

A: It is important to always have a back-up of your important information. Here are some ways of doing this:

- You can print out a hard copy using the optional accessories. See p. 222.
- You can back up your entire unit using the IQ-783 256KB RAM card (for the IQ-8900) or IQ-784 512 KB RAM card (for the IQ-8900 and the IQ-8920). (if needed, you can just as easily restore your information back to the unit.) See p. 238.
- You can use PC or Macintosh link software either from SHARP or a third party. You will also need one of the various PC-Link cables or the CE-IR2 wireless interface for computers. Check with your local dealer regarding features and availability of these products.

Q: *I can't seem to turn my unit on. I changed the batteries but still nothing happens. What should I do?*

A: Check the following before sending the unit in for service:

- Check to see that the CARD LOCK switch is LOCKED and not in the RELEASE position. You may have accidentally left it unlocked after removing an IC card.
- Check that the battery replacement switch on the back of the unit is in the “NORMAL OPERATION” position. If the switch is in the “REPLACE BATTERIES” position, the unit cannot be turned on.
- Check or replace the operating batteries, even if you have just replaced the batteries. It is possible that the batteries were not fresh when you purchased them.
- Press the RESET switch. If the unit has been dropped, for example, it may have to be reset. This will not delete your data. If for any reason data is missing after resetting the unit, it was lost before you pressed the RESET switch. The RESET switch simply re-starts the unit.

If none of the procedures above works, you will need to send the unit to a service center. Check the back page of this operation manual for the location of your nearest service center and call for more information.

Q: *What happens if I am working on an entry and the auto power off function shuts off the unit before I store the entry?*

A: You will not lose any information. The next time you turn the unit on, the Resume feature returns you to exactly where you left off.

Q: *I would like to use the Filer feature but I am afraid of using up memory. How does the Filer work? Does it make a copy of each entry?*

A: No. When you assign an entry to a folder in the Filer, it does not use up any extra memory. The unit doesn't actually make a copy of the entry, it simply “assigns” the entry to a folder. Entries are still stored in each individual application (Tel, Notebook, etc.). The Filer is a great way to organize your information and there is no reason not to use it.

Q: *I have an older model 8000 Series 256K Organizer that was about 99% full. When I loaded all of the data into my new unit (IQ-8920) and checked the memory, it read about 65% full. I expected it to read about 50% full. What happened?*

A: This unit uses memory differently to other SHARP Organizers, providing many more features, formatting capabilities, etc., which require more memory. Importing data from another type of unit will require more memory on this unit. This amount will vary depending on the number and type of records you import.

Q: *What is the Outline application? Why would I want to use it instead of Notebook?*

A: The Outline application allows you to group and categorize information using a hierarchical structure. Everyone has a lot of small but important pieces of information that have to be memorized or kept track of in a written record, for example, important personal information: Social Security number, credit card numbers, various ID numbers, account numbers, clothing sizes, etc. Using the unit, you could make a number of Notebook entries for each piece of information, but a better way to manage the information would be to make a single Outline file called "Personal Information." This file could then contain a number of headings (such as Car info., Travel info., Health info., Financial info., etc.), under which relevant pieces of information could be stored. This makes it easier to access information and prevents your unit from becoming cluttered with hundreds of individual entries.

Additional Outline files could also be made, including: favorite movie list, project management file, To Do lists, price lists, product line-up and specification file, business plans, product proposals, and meeting notes. Many types of information can be more easily and efficiently managed in an Outline structure.

Another use of the Outline application is document preparation. Many times you might want to write a memo, letter, proposal, marketing plan, etc., but find it difficult to write an entire document from scratch. The Outline application allows you to capture your thoughts and ideas, then rearrange and categorize them at any time. You can also copy an Outline file and paste it into the Notebook application to finish the document there, adding text to the major topics.

Q: *I want to send faxes from my IQ-8900 series unit, but what do I need besides the unit itself?*

A: The IQ-8900 series unit has fax software built in, but you will also need the PC fax/modem and the CE-137T level converter.

Not all PC fax/modems can be used with the IQ-8900 series unit. Contact your nearest SHARP dealer for information about compatibility and availability of the PC fax/modems. (If the CE-FM1 Fax/Modem is not available for use in your country because of the specifications of the telephone lines, ignore references to it in this manual.)



C ontents

Introduction	1
Quick Start	3
Answers to Commonly Asked Questions	24
Contents	29
What Your Unit Can Do	37
About this Manual	39
Conventions Used in this Manual	41
Caring for the unit	42
Chapter 1 Getting Started	45
Part Names and Functions	46
Getting the Unit Up and Running	48
Installing the batteries	48
Initializing	48
Setting the clock	49
Turning the unit on and off	51
Calibrating the touch panel	52
Setting the LCD contrast to suit various lighting conditions	52
Turning off the welcome display	53
Turning the key beep on and off	54
Getting to Know Your Unit	54
Touch buttons and the touch panel	55
Applications	55
Menu operation	56
The keyboard	57
Display symbols	57
Built-in help and other messages	58

Chapter 2 General Operation	61
Opening an Application	62
Selecting Display Modes	62
The Index mode..	62
The View mode..	63
The Edit mode	64
Making a New Entry	65
Editing an Existing Entry	67
Editing Techniques	67
Fields	67
The cursor	68
Typing in text.....	68
Moving around the display	69
Moving between fields	70
Inserting and overwriting text.....	70
Deleting text..	70
Working with blocks of text.....	71
Scrolling the display	72
Finding Specific Entries in Your Unit	72
Using the index mode.....	72
Using keywords..	73
By topic	74
By date	74
Deleting Entries from the Unit	75
Deleting single entries	75
Deleting entries using the application menu.....	76
Drawing Using the Scrapbook	77
Using the drawing tools	77
Making new graphic entries	78
Finding graphic entries	79
Revising graphic entries	79
Deleting graphic entries..	80
Checking the Time and Date	81
Checking the Unit's Memory	81
The Tools Menu-the Unit's Basic Utilities	82

Chapter 3 Time Management	85
The Calendar Application	86
Selecting a calendar view	86
The Monthly view	87
The Three-month view.....	87
The Weekly view	88
The Weekly Graph view	88
The Daily view	89
Finding entries using the Calendar views.....	91
Selecting a date	91
The Calendar application menus	92
The Schedule Application.....	93
Making new entries	93
Finding entries	95
Moving appointments and editing entries	96
Deleting entries	97
Selecting a specific date	99
Making entries for recurring and extended events ...	100
Setting a Schedule alarm	102
The Schedule application menus	103
The To Do Application	104
Making new entries	104
Finding and reviewing entries	107
Editing entries	109
Checking off completed entries	109
Using categories	112
Deleting entries	117
The To Do application menus.....	118
The Ann (Anniversary) Application	119
Making new entries	119
Finding entries	121
Editing entries	122
Deleting entries	122
The Ann application menus	123
Chapter 4 Creating Your Own Database	125
The Tel and User File Applications	126*

Selecting a file	126
Making new entries	127
Finding entries	127
Editing entries	129
Deleting entries	129
Using picture fields	130
The Tel application menus..	132
The User File application menus..	133
Customizing the Tel and User File Applications	133
Changing file names	133
Configuring fields	134
Customizing the Index display	136
Chapter 5 Word Processing and Outlining	139
The Notebook Application	140
Making new entries	140
Making a new entry based on an existing entry.....	142
Finding entries	142
Editing entries	144
Deleting entries	144
Changing the character size on the display.....	145
Searching for specific words in the text.....	146
Changing character (font) styles	146
Using indents and tabs	148
Turning word wrap on and off	152
Printing a full-size document	152
The Notebook application menus	157
The Outline Application	157
Creating an outline..	158
Finding outlines	160
Displaying full topics	161
Revising outlines..	161
Outline deletion	165
Using subtopics (children)	167
The Outline application menus..	171
Chapter 6 Desk Accessories	173

The Calc (Calculator) Application	174
Performing calculations	174
The paperless printer	175
Date calculation	177
Using the Calculator with other applications.....	179
When E appears	180
Calculation examples	181
The Clock Application	182
Changing the Home city	182
Setting the time and date	184
Checking the time in a city	185
Adding a User's city	186
Daylight saving time (DST)	187
Setting daily alarms	188
The Scrapbook Application	190
Making new entries	191
Using the drawing tools	192
Finding entries	192
Editing entries	192
Selecting an area	192
Moving or copying sections of graphic entries.....	193
Adding text strings to graphic entries.....	194
Deleting entries	195
The scrapbook application (VIEWS) menu	196
Chapter 7 Features and Utilities for Added Power	197
The Filer Application	198
Assigning entries to folders	199
Naming or renaming folders	202
Viewing entries via the Filer	203
Unassigning entries from folders	204
Merging folders	205
Deleting all entries in a folder.....	206
Sharing folders	206
The Filer application menus	207
Copying or Moving a Block of Text	207
Copying or Moving Entries	209

Creating a New Entry Based on an Existing One	210
The Time Stamp and Date Stamp Functions	211
The Word Key	211
Registering your words or phrases	212
Inserting a word or phrase with the Word key.. . . .	213
Editing a word or phrase	213
Deleting a word or phrase	213
The Filter Function	213
Turning the Filter on	214
Turning the Filter off.. . . .	215
Deleting filtered entries	215
Special Characters	216
Chapter 8 Using the Optional Peripherals	219
The Peripherals Menu	220
Application IC Cards	220
Installing an IC card	220
Printing from the unit.. . . .	222
Setting up the unit for printing	223
Printing the current display	224
Printing a single entry.. . . .	225
Printing a specified group of entries.. . . .	225
Printing all entries	227
Sending Fax from the unit.. . . .	227
Connecting the fax/modem	228
Setting fax/modem options.. . . .	228
Setting up the Fax directory	230
Setting up your personal information for cover sheets & page header	231
Sending a fax (Automatic dialing)	232
Making other changes to the number	233
Sending a fax (Manual dialing).	233
Using a cover sheet.. . . .	235
Speed buttons.. . . .	236
Editing speed button information.. . . .	237
Making a speed button secret	237

Enhancing Capabilities Using a RAM Card	238
Memory expansion..	239
Backing up data to a RAM card	240
Sharing data with another unit	241
Transferring Data	242
Transfer between 8900/9000 Series units	244
Receiving data from units other than the 8900/9000 Series..	249
Transferring data to/from a RAM card application	251
Exchanging Information with a Personal Computer	251
Terminal Mode	253
Hardware requirements	253
Connecting the modem..	254
Opening the Terminal mode	254
Configuring the modem settings.....	255
Dialing settings..	256
Changing dialing entry settings	260
Making a call..	260
Hanging up.....	261
Receiving a call	262
On-line operations (Terminal menus)	263
Data transfer	264
Auto log-on	268
Terminal emulation..	270
Telecommunications troubleshooting	271
About External Power Supply	273
Points to Remember When Using Peripherals..	274
Chapter 9 Personalizing Your Unit	279
The Star&-Up Display	280
Setting the start-up display	280
Responses to the start-up display..	281
The Secret Function	282
Registering a password	283
Marking/unmarking entries as secret	284
Accessing secret entries	284

Locking the unit..	286
Changing or deleting the password..	286
If you forget your password	287
RAM cards and the Secret function	287
Changing the Calendar Display Format	288
Setting the date format	288
Setting the monthly format.....	288
Setting up the Calendar..	289
Appendices	291
A. List of Key Notations	292
B. ASCII Control Code Table	298
C. Resetting the unit	299
All reset operation..	299
D. Troubleshooting	300
E. Battery Replacement.....	301
General guidelines.....	301
Replacing the operating batteries..	302
Replacing the memory backup battery.....	304
F. Specifications..	306
Index.....	311



What Your Unit Can Do

The IQ-8900/IQ-8920 is a full-featured, pocket-size information manager with a new, easy-to-use graphical user interface, a large, easy-to-read screen, and pen-based panel operation. Wireless communications capability with other IQ-8900 series units and personal computers is built in, and the IQ-8900/IQ-8920 also provides fax sending capability.

To help you better manage your time and appointments, you can record appointments, meetings, or any other information connected with a date in the **Schedule** application; the **To Do** application helps you track tasks and goals — arranged in a priority you assign to them; the **Ann** application lets you record important annual events such as anniversaries and birthdays; and the **Calendar** can display your **Schedule**, **To Do**, and **Ann** entries in a daily, weekly, or monthly format.

The **Tel** application can be used like an address book to record names, phone numbers and addresses, while the **User File** application is a database for any important information, entered into categories you set up. Both can be configured to include the information you need most.

The unit is a word processor as well. The **Notebook** application offers advanced features, including margin set, word wrap, and a choice of font size and styles, allowing you to use the unit for everything from simple note taking to creating a formal, full-size letter. And the **Outline** application lets you enter and organize your thoughts and ideas using topics and subtopics, easily reorganizing them at any time.

The unit's powerful desk accessories include the **Scrapbook** application, which lets you create drawings or write notes directly on the display. The **Calculator** can

perform a full range of mathematical functions, and the built-in **Clock** keeps track of both local and international time.

The unit combines quick access to your information with the ability to search files using a keyword or heading. The **Filter** function makes it possible to select and work with specified entries. And the **Filer** lets you collect all entries containing information you specify into one location, ensuring that all data on a single topic is at your fingertips. You can also “cut and paste” information within or between entries and files. And when a printer is connected to the unit using the optional CE-IR1 wireless interface, you can make hard copies of your data.

The IQ-8900 Series also has powerful telecommunications functions. Using the optional CE-FM1 Fax/Modem and CE-137T level converter, you can send faxes directly from the unit (with or without a cover sheet), and transfer data to and from other units or to remote computers. And the unit can be given even greater capability through the use of SHARP application IC cards. Memory capacity can also be expanded using any of the optional RAM cards. Features and enhancements such as these, coupled with capability and ease of use make the IQ-8900 Series one of the most versatile and advanced hand-held information managers available in the world today.



About this Manual

This manual is designed to help you to fully understand the capabilities and operations of your unit. The first two chapters provide a general introduction and instructions about set-up and initialization, including an overview of the keyboard, the display, and the operations.

Other chapters are organized according to the type of task, for example, **Time Management** and **Creating Your Own Database**, so that you can give your attention only to those functions and features that meet your particular needs.

This manual consists of 9 chapters and a set of appendices:

Chapter 1. Getting Started

introduces part names and functions, and shows you how to set up and initialize the unit, including how to install batteries and set the built-in clock.

Chapter 2. General Operation

introduces you to basic concepts and operations on the unit, including opening an application, using menus, and the built-in help feature.

Chapter 3. Time Management

Explains those features that help you structure your time and keep track of appointments and important events: the **Calendar**, **Schedule**, **To Do**, and **Ann** applications.

Chapter 4. Creating Your Own Database

Explains the **Tel** and **User File** applications, which not only store information such as addresses and phone numbers, but also can be configured to manage almost any type of information.

Chapter 5. Word Processing and Outlining

Explains word processing in the **Notebook** application, and how to structure your ideas and writings using a simple outline form in the **Outline** application.

Chapter 6. The Desk Accessories

Explains drawing using the **Scrapbook**, and using the **Calculator** and Clock-applications that can be opened on the display whenever they are needed.

Chapter 7. Features and Utilities for Added Power

Explains how to copy entries and other productivity enhancing features and utilities, including quick access to information with the **Filer** application, filtering selected entries, and more.

Chapter 8. Using the Optional Peripherals

Explains printing using the unit, how to transfer data to and from other units (including previous models), how to send faxes or exchange data with personal computers using the optional fax/modem, and using the optional IC cards.

Chapter 9. Personalizing your unit





Explains how to change the opening display and **Calendar** display format, and how to use the **Secret** function and a password.

Appendices

- A. List of Key Notations
- B. ASCII Control Code Table
- C. Reset
- D. Troubleshooting
- E. Battery Replacement
- F. Specifications

C onventions Used in this Manual

The following keyboard and symbol conventions are used throughout this manual:

- **WEEKLY** , **STORE** , and other similar key notations indicate “touch buttons” on the display which can be activated by touching with a finger or the touch pen. (For more information about touch buttons, see p. 55.)
 - (ON), (ENTER) , and other similar notations indicate keys on the keyboard that should be pressed to perform operations.
 - Letters and numbers to be entered in examples are shown in italics, for example *lunch* indicates that l-u-n-c-h should be typed in. Words shown in boldfaced letters, such as **Calendar** and **TOOLS**, indicate the names of applications, functions or menus.
 - Some keys have more than one function, accessed by using them in combination with  or (2nd). ‘H’, for example, also accesses the **HELP** screen when the (2nd) key is used with it. When a key’s second function is referred to in an explanation, only that function is shown. For example, the instruction to see the **HELP** screen would be shown as (2nd) **HELP** , not as (2nd) **H** .
 - The  symbol indicates a tip or important point.
 - The unit often lets you perform operations in more than one way. These alternatives are indicated by the  symbol.
 - Cross-references to other helpful information are marked by the  symbol.
-  For a full list of key notation, see Appendix A, p. 292.
- in this manual, 8000 Series, 8900 Series and 9000 Series means the following models:
8000 Series: IQ-8000, IQ-8200, IQ-8400, IQ-81 OOM, IQ-8300M, IQ-8500M
8900 Series: IQ-8900, IQ-8920
9000 Series: IQ-9000, IQ-9200

Caring for the unit

The unit contains sophisticated circuitry and a glass display panel which can be damaged if not cared for properly. A few precautions should be taken regarding the unit's care so that it will give you many years of reliable use.

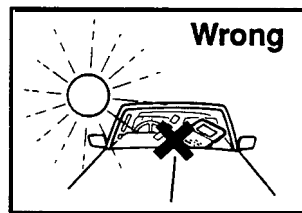

Keep the unit away from extreme heat. Do not leave it on the dashboard of a car or near a heater. Do not leave it in any place that is extremely damp or dusty.

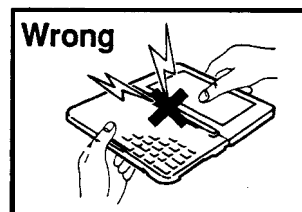

Do not drop the unit or subject it to severe impact or extreme force. Bending the unit beyond its capacity can damage the circuitry.

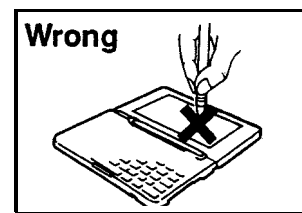

Do not use extreme force when pressing buttons on the display or the keys. Do not use any sharp, pointed object or your fingernails to press them. It is recommended that you use only the included touch pen to write or to touch the buttons on the unit's display screen.

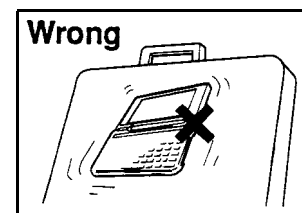

Sharp or hard objects can scratch the unit. Be careful that it is protected when carried with other objects. Do not store it loose in a bag or briefcase.

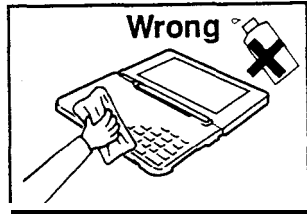

Clean the unit only with a soft, dry cloth. Do not use solvents.

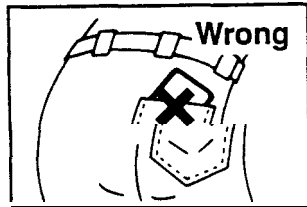

Do not carry the unit around in your back pocket, as it may break when you sit down. The display is made of glass and is particularly vulnerable.



Replace the batteries as soon as they become weak (see p. 301). Failing to replace weak batteries may result in leakage or lost data.

30450

microwell

8-27-11



1

Getting Started

This chapter explains everything you need to know to set up and begin working with your unit, from installing the batteries to initialization. The chapter also includes a labeled illustration of the parts of the unit, and basic explanations of its key features, from the keyboard to the touch panel display and its symbols.

Part Names and Functions

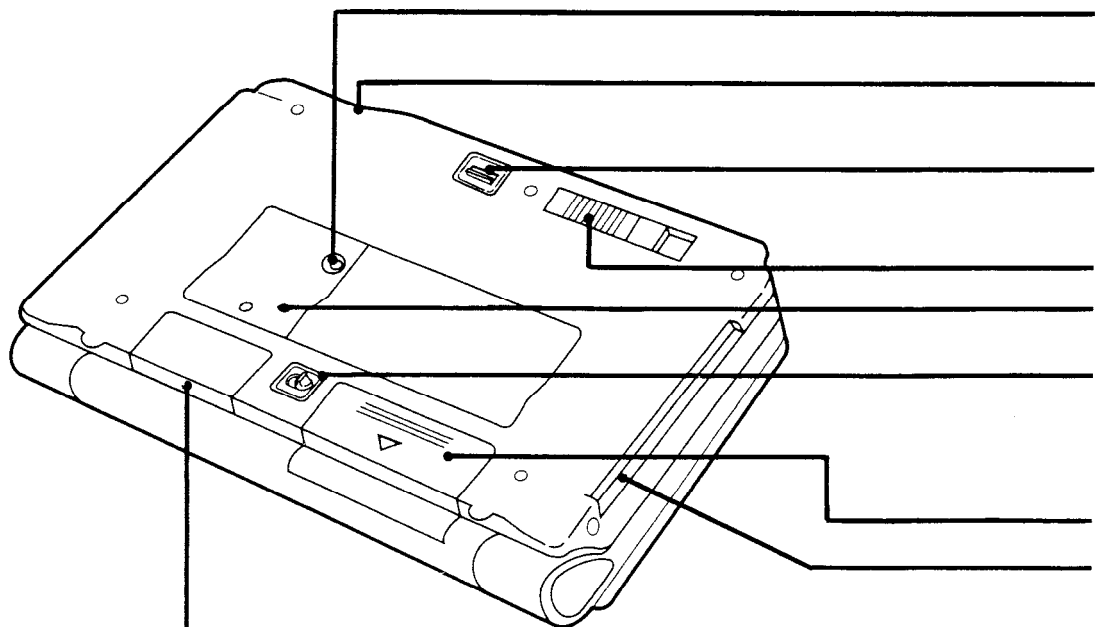
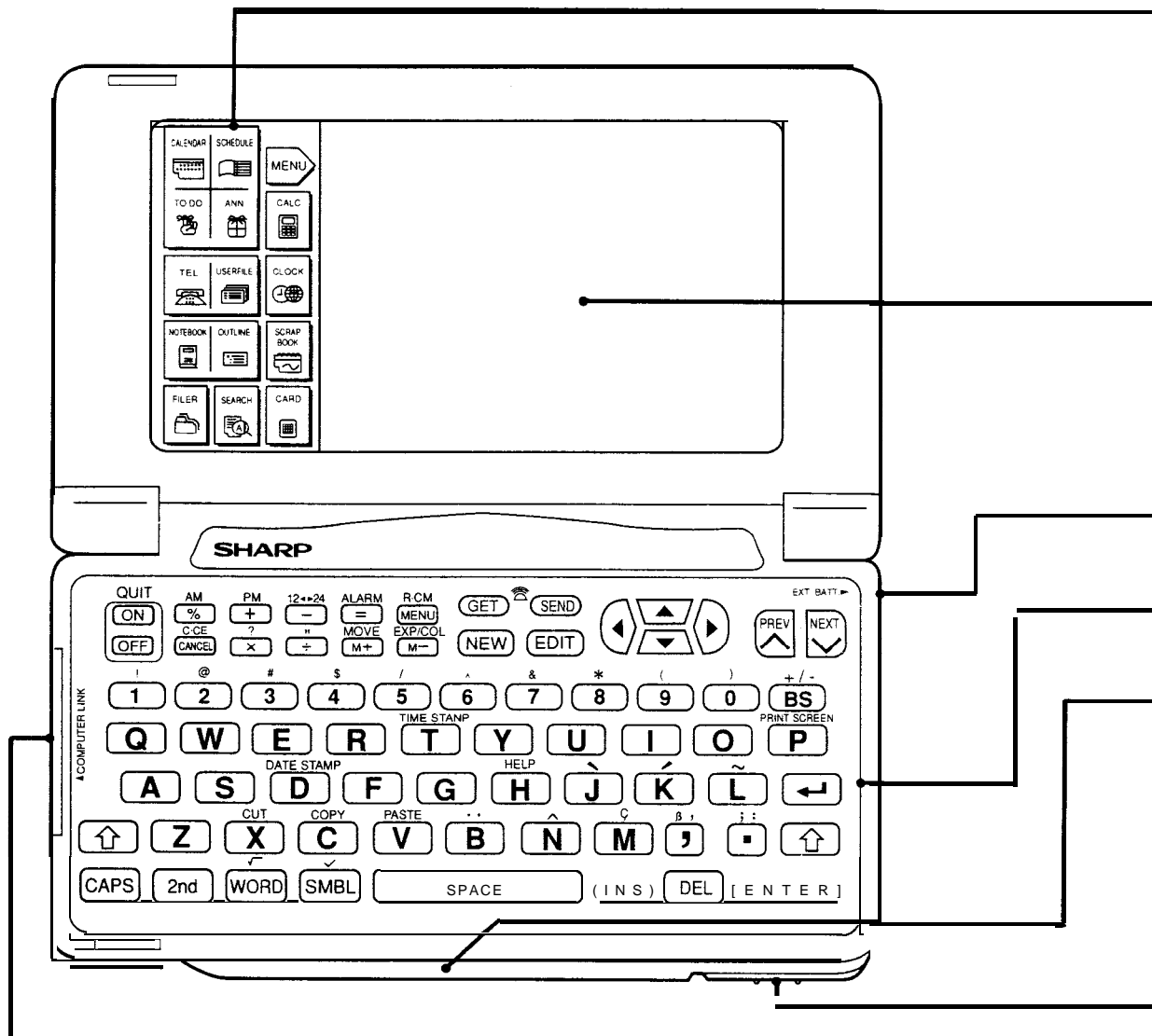

_____	Application keys	Open appropriate applications.
_____	Display	Shows information, and functions as a “touch panel” for navigation, data entry, etc.
_____	External power supply pin	Connects the unit to the optional CE-76BC battery case.
_____	Keyboard	For entry of characters and commands.
_____	Touch pen holder	Use for selecting touch buttons and drawing on the touch panel.
_____	Touch pen	
_____	15-pin cable jack	Connects a data transfer cable for computer links, modem hook-ups, etc.
_____	Reset button	Use to initialize and reset the unit.
_____	Lock button	Press to open the unit.
_____	IC card lock switch	Locks the installed IC card into the unit.
_____	IC card eject switch	Use to eject an IC card.
_____	Memory back-up battery compartment	Secures batteries into the battery compartment.
_____	Battery replacement switch	
_____	Operation battery compartment	
_____	IC card slot	For loading an IC card.
_____	Infrared port	For infrared communications with other 8900/9000 Series units, etc.

Getting the Unit Up and Running

Installing the batteries

1. Set the battery replacement switch on the back of the unit to "REPLACE BATTERIES" (exposing the red dot).
2. Slide off the operation battery cover.

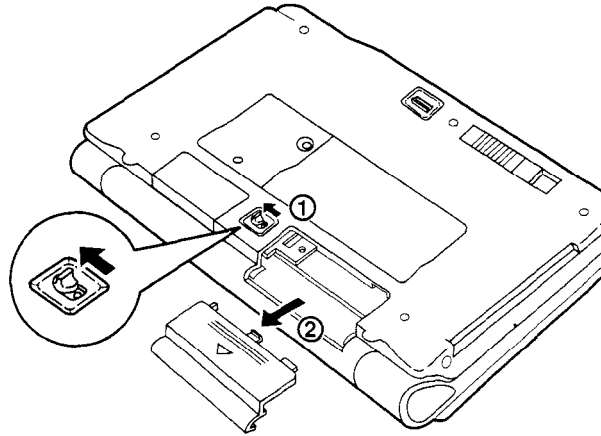

3. Insert the two batteries atop the ribbon tab, positioning them according to plus (+) and minus (-) polarity, as shown below.

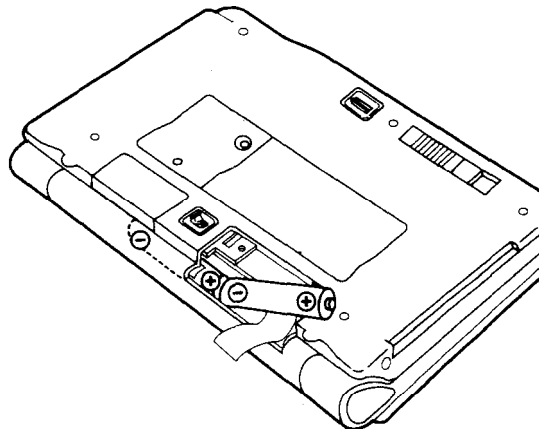

4. Replace the operation battery cover.
5. Set the battery replacement switch to "NORMAL OPERATION".

Initializing

The unit must be initialized the first time it is used.

1. Press and hold the (ON) key.

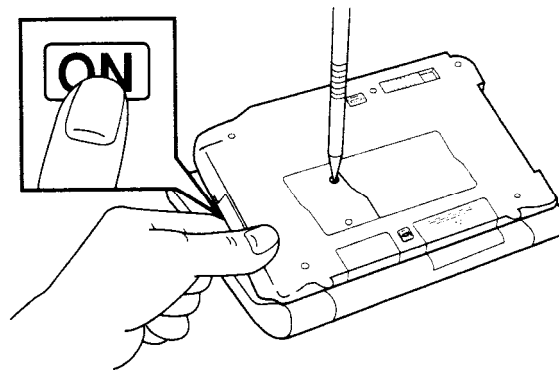

2. While holding down the **ON** key, push the RESET button on the back of the unit using the included touch pen or a similar object. The following message will appear.

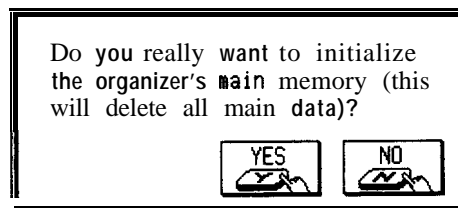

3. Touch **YES** to initialize the unit.

An initial display welcoming you to the unit appears.

- If you want to take a tour and have a demonstration of some of the features, touch **NEXT PAGE**. You can press **ON** to leave the demonstration at any time and go back to the initial display.
- The welcome display is shown each time the unit is turned on unless it is set to off (see p. 53).
- To skip the tour, or after finishing it, proceed to setting the clock, below.

Setting the clock

In order for the **Calendar**, **Schedule**, **To Do**, and other time-based applications to be accurate, the built-in clock must be set to the correct city, time and date.

1. Touch **ADJUST** on the welcome display.

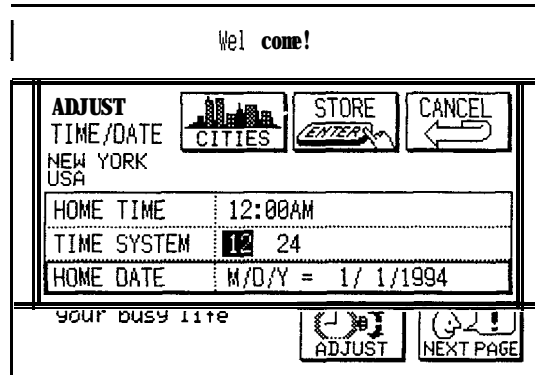

2. Touch **CITIES** .
A list of cities appears.

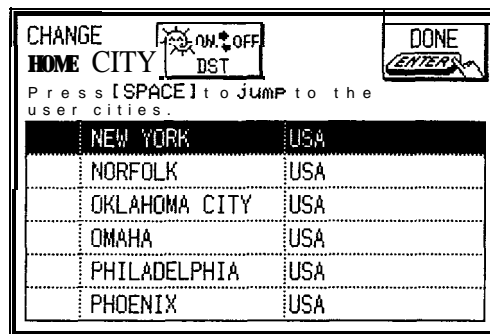

3. If the desired city is not displayed, press **PREV** or **NEXT** to display the city.
4. Touch the desired city to select it and touch **DONE** .
The ADJUST TIME/DATE window reappears with the selected city displayed.
5. Enter the correct time using the numeric keys on the keyboard.
Enter a zero (0) in front of any single-digit hour or minute entries.
6. Press **AM** or (PM) (above the top row of keys on the keyboard).
7. Press **NEXT** .
Press **12 <=> 24** to select the time system.

8. Press (NEXT) .

Enter the correct date in the order of month, date, year.
Enter a zero (0) in front of any single-digit month or date.
Use four digits to enter the year.

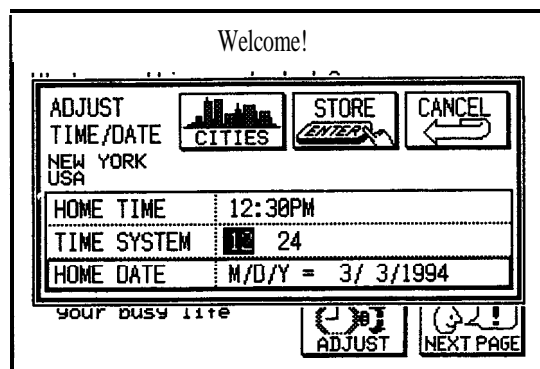

9. Touch **STORE** .

The city, time, and date are set and the window closes.

★ If you want to reset the clock in the future, use the **TOOLS** menu. See p. 182.

Turning the unit on and Off

Press (ON) to turn the power on and (OFF) to turn the power off. The unit will not operate if the IC card lock switch is in the RELEASE position or the battery replacement switch is in the "REPLACE BATTERIES" position. Either batteries or the optional CE-76BC battery case (see p. 273) can be used as the unit's power source.

Auto power off

To conserve battery power, the unit will turn itself off if it has not been used for about 12 consecutive minutes. In order to avoid interrupting data transfers, the auto power off function is disabled when communicating with other devices.

If the unit auto powers off before an entry you are working with is stored in an application, the data will not be lost. When you press (ON), the unit will return to the same operating state as before auto power off.

Calibrating the touch panel

Each person holds a pen differently. In order for the unit to be able to respond properly to your individual style of writing, drawing, or selecting touch buttons, the touch panel must be calibrated.

1. Press **MENU** and then touch **TOOLS**.
2. Touch **ADJUST LCD**.
A submenu appears.
3. Touch **ADJUST TOUCH PANEL**.

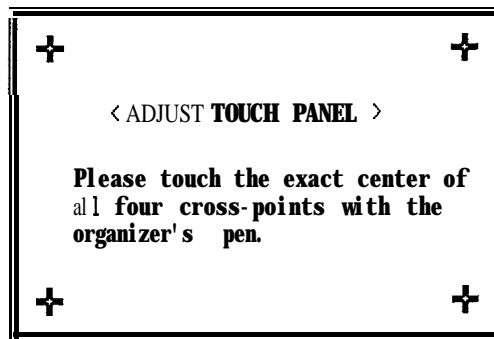

4. Touch the center of each of the four crosses with the touch pen.

If the adjustment is successful, "Adjusted!" appears on the display. If for some reason the adjustment fails, the message "Sorry, please try again" will appear. Touch the centers of all four crosses again until the touch panel is calibrated.

Setting the LCD contrast to suit various lighting conditions

From time to time, the contrast of the LCD display may have to be adjusted. You may find, for example, that a contrast setting that was fine for the home or office is not adequate when outside or on an airplane. Follow the procedure below to adjust the LCD contrast.

1. Press **MENU** and then touch **TOOLS**.
2. Touch **ADJUST LCD**.
A submenu appears.

3. Touch ADJUST LCD CONTRAST.



4. Adjust the contrast by touching **LIGHT** or **DARK** .

5. Touch **DONE** when you are satisfied with the contrast.

- ★ If for some reason the display is too light or dark for you to read the display and operate the unit, you can access the contrast adjustment directly by turning off the unit, then holding down **MENU** on the keyboard while pressing **ON** . Press **▲** and **▼** to darken or lighten the contrast.

Turning off the welcome display

You may find that after taking a tour of the unit and seeing a demonstration of its features once or twice, you want to turn off the welcome display.

1. Press **MENU** and then touch **TOOLS** .
2. Touch SET START-UP DISPLAY.
The SET START-UP DISPLAY window opens.
3. Touch OFF in the box next to START-UP.

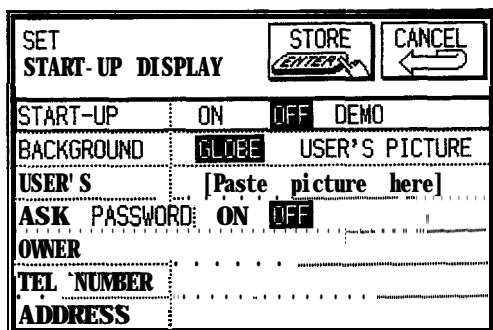

If you make a mistake, touch **CANCEL** and start again.

4. Touch **STORE** .

The welcome display is now disabled.

→ For more information about configuring the start-up display, see p. 280.

Turning the key beep on and off

The unit can be set to make a sound (a beep) each time a key or button is pressed. The default setting is on, indicated by  on the display. You can use the **TOOLS** menu to change the setting.

1. Press **MENU** and then touch **TOOLS** .
2. Touch MORE TOOLS and then touch KEY SOUND ON/OFF.

A submenu appears. The current setting is marked with an asterisk.

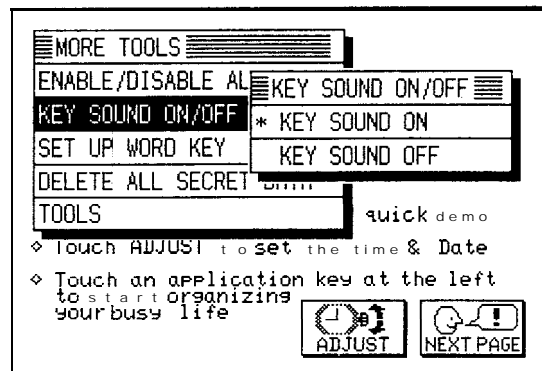

3. Touch KEY SOUND OFF.

The key beep is now turned off and  disappears.

Getting to Know Your Unit

A major advantage of this unit is its graphical user interface, which displays commands and can carry out functions through a combination of graphical images and text. The graphical user interface is not only easy to use, it also gives you a great deal of versatility, since many

operations can be carried out using the touch pen on the display, keys on the keyboard, or a combination of the two.

Touch buttons and the touch panel

The unit's display not only shows information, it is also a "touch panel" which can respond to the touch of a finger or the touch pen to call up functions and execute commands. The icons on the display are "touch buttons" which allow you to access various operations simply by touching the desired button.

Many operations which are carried out using the touch buttons can also be carried out using keys on the keyboard. To store an entry, for example, you can touch **STORE** on the display or press **ENTER** on the keyboard.

- Keyboard alternatives are shown on some touch buttons. For example  , shown as **STORE** in the manual, indicates that you can touch **STORE** on the display or press **ENTER** on the keyboard.
- When a symbol on the display matches a key or symbol on the keyboard, either can be used to perform the same operation. For example **CANCEL** function the same as **CANCEL** .

Applications

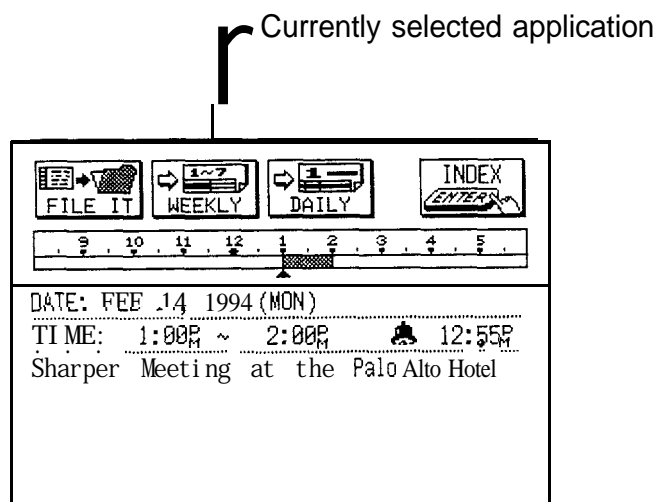



Operations on the unit are performed using “applications.” The unit’s **Calendar** and **Schedule**, for example, are applications—they perform an operation and accomplish a task based on your directions. To open an application, select it by pressing the appropriate key on the left of the display.

When working in one application, you can switch to another application simply by pressing that application key. Data being processed in the first application will, in most cases, be preserved and the operation can be completed when the application is selected again. In cases when an operation or procedure cannot be completed, a warning message will indicate this and give you the option of remaining in the application.

Menu operation

Another powerful aspect of the unit’s graphical user interface is its system of menus, which can be used to quickly execute commands and perform operations. With the exception of the **Clock**, two “universal” menus — **PERIPHERALS** and **TOOLS** — can be accessed from any application. In addition, except for the **Clock**, all applications have **VIEWS** and **MODIFY** menus, with specific functions and selections that are unique to each application.

To change the display view, touch **VIEWS** and select the desired view from the menu. To modify entries, for example to delete one or several entries, touch **MODIFY** and select the desired operation. When you want to perform an operation in another menu, you can move between the four menus (**PERIPHERALS** and **TOOLS**, **VIEWS** and **MODIFY**) using the  and  keys.

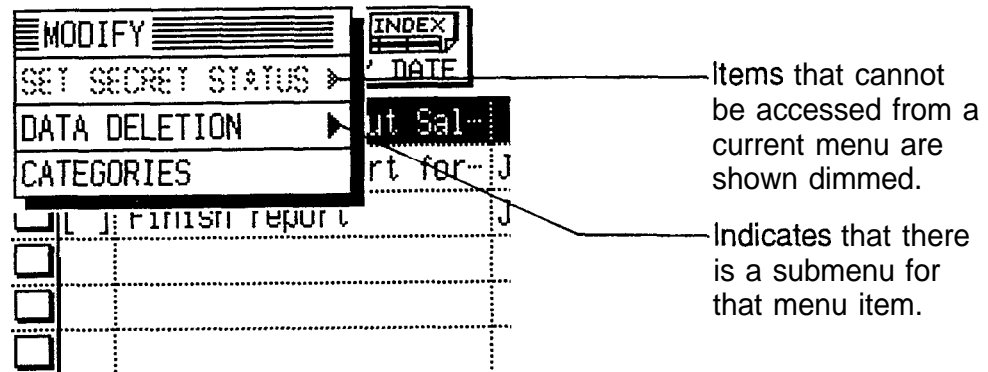

To do application menu

The keyboard





The unit's keyboard is laid out in a standard format, much the same as on a typewriter or computer. functions the same as the Shift key on a typewriter or computer, and (CAPS) the same as a Caps Lock key.

- Functions (MOVE and EXP/COL) are automatically activated when using the **Outline** application-it is not necessary to press any other key.
 - Symbols in white above a key such as ' or : can be accessed by holding down and then pressing the appropriate key.
 - Functions in blue above a key, such as HELP, can be accessed by pressing the key after is pressed. There is no need to hold down while you press the other key.
- Special symbols and characters, such as ¥ and é, can also be entered on the unit using . For a full explanation, see p. 216.

Display symbols

The following symbols appear at the top of the screen indicating various operating conditions.

- BATT** The operating batteries are weak and need to be replaced (see p. 302).
- CARD An IC card is currently being used.
- EDIT The current entry is in the Edit mode.

- 2nd The **2nd** key has been pressed.
- CAPS **CAPS** has been pressed. In caps lock mode, all typed letters will be in uppercase. Press **CAPS** to turn off caps lock.
- * This symbol indicates that the current entry is marked as “secret” and can only be accessed when the unit is unlocked (see p. 282).
-  The unit is locked. Entries marked as secret cannot be recalled without first entering the password and unlocking the unit (see p. 282).
-  The key sound is on (see p. 54).
-  All alarms are enabled. When this symbol is not shown, the alarm sound for any set alarms is disabled (see p. 189).
-  They indicate that all information in an entry cannot be shown at one time on the display. There is additional information in the direction indicated, which can be viewed using the cursor keys.

Built-in help and other messages

The unit has a built-in help feature which acts as a convenient, on-line reference manual. You can call up the **Help** feature at any time simply by pressing **2nd** (**HELP**) . On-line help is an extensive resource, so not all the information available may fit on one display. Use **PREV** or **NEXT** scroll the information, then touch **DONE** when you want to return to the regular display.

During the course of normal operations, the unit will display several different messages to guide you through these operations. Many of these messages will give you a choice of commands or ask you to confirm important operations, while others will simply display information for you to read. In most cases, you must make a selection or simply acknowledge the message before continuing.

Other messages will flash information briefly and then disappear.

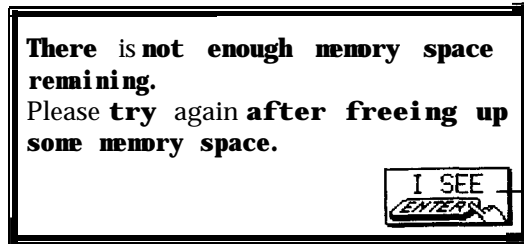

Touch to proceed.

Out of memory

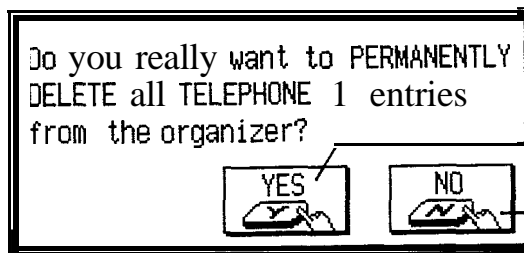

Touch to proceed.

Cancels the operation.

Delete confirmation

In this chapter you will learn most of the unit's basic operations. The **Tel** and **Scrapbook** applications will be used for the examples. However, most of the techniques described here can be applied to all of the built-in applications. Each application is described in detail later on in the manual.

- For a full explanation of the **Tel** application, see p. 126.
- For a full explanation of the **Scrapbook** application, see p. 190.

Opening an Application

To start using an application, simply press the desired key, located to the left of the display. Each time you press [(TO DO), AR], [SCHEDULE], [ANN], [TEL], [USER FILE], [NOTEBOOK], [OUTLINE], [FILER], [SCRAPBOOK] or [CALC], the selected application will appear. Any application open on the display will now be hidden when a new application is selected. You can always return to another application at the exact point where you left off simply by pressing its key again. Only one application will ever be visible at a time. The Clock is displayed only while [CLOCK] is pressed.

Selecting Display Modes

Once an application is open, you can switch between three basic display modes: Index, View, and Edit. Each display mode has its own unique appearance and particular purpose.



The **Calc**, **Calendar**, and **Clock** applications do not have Index, View, or Edit modes.

The Index mode

The Index mode shows you a one line view of each entry. From this you can easily find a particular entry. This is the default view the first time you use an application or when there are no entries in a particular application.

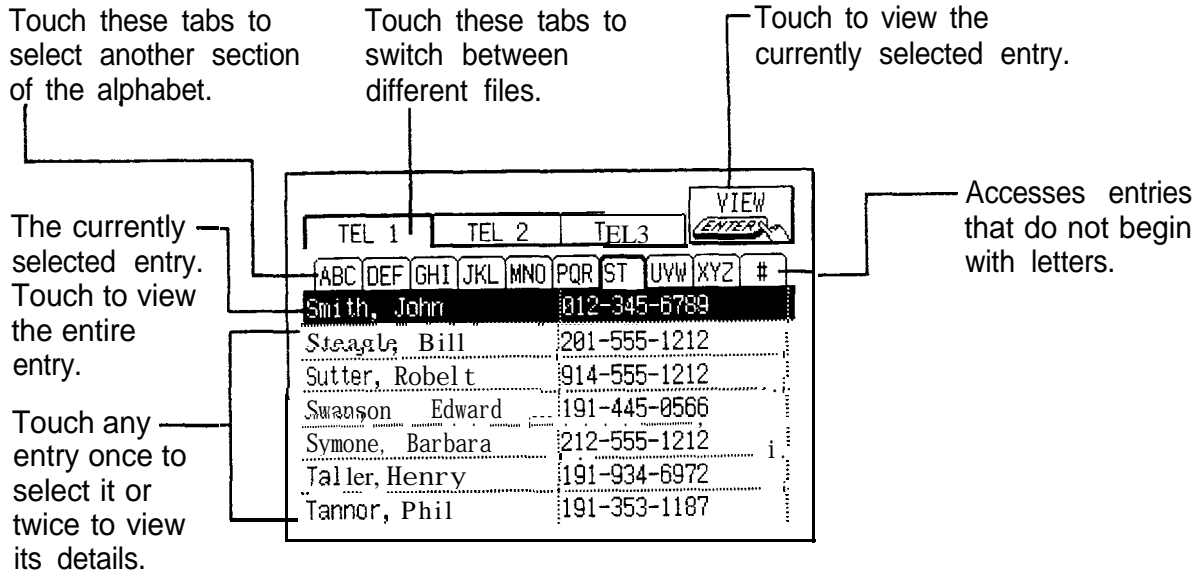

Other operations from the keyboard:

- NEW** Creates a new entry (Edit mode).
- EDIT** Edits the currently selected entry (Edit mode).
- DEL** Deletes the currently selected entry.
- ENTER** Displays the currently selected entry in the View mode.
- PREV** **NEXT** Displays any previous/subsequent entries not shown.
- ▲** **▼** Selects an entry.

The View mode

The View mode shows a single entry in its entirety.

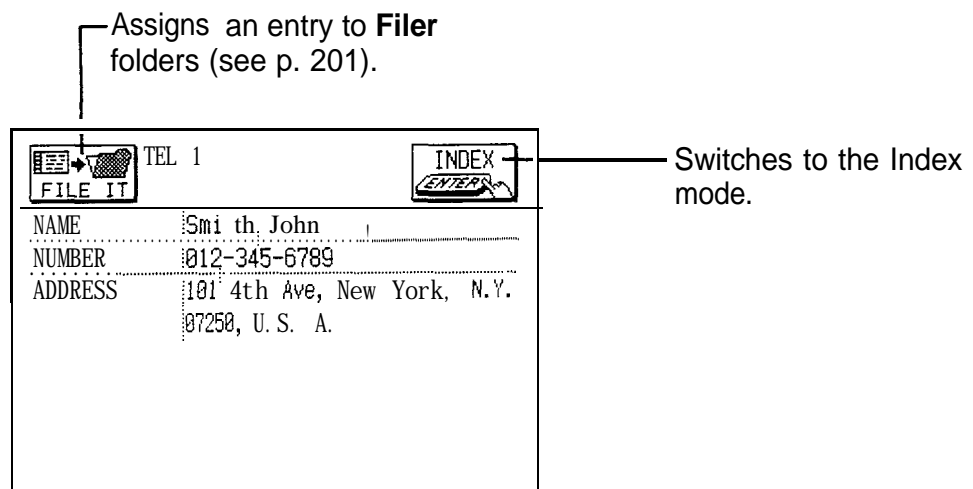

Other operations from the keyboard:

NEW

Creates a new entry (Edit mode).

EDIT

Edits the currently displayed entry (Edit mode).

(i i)

Deletes the currently displayed entry.

PREV **NEXT**

Sequentially displays the previous/ following entries.

The Edit mode

Entries are made and all editing and corrections are carried out in the Edit mode.

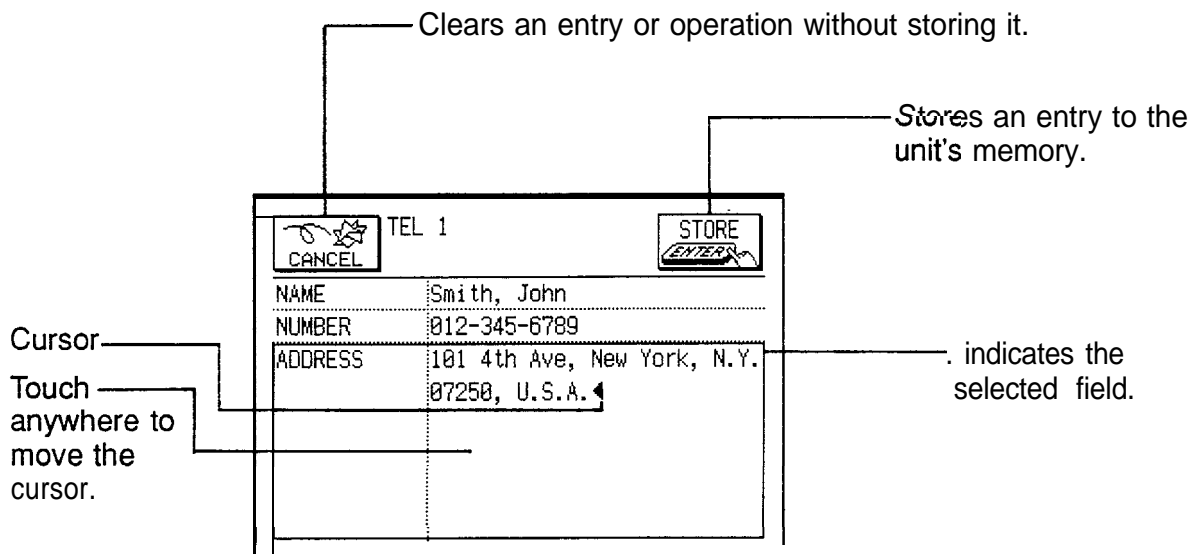

Other operations from the keyboard:

↑ **NEW**

Clears a selected field.

(C A N)

Clears an entry or operation without storing it.

(ENTER)

Stores an entry to the memory.

▲ **▼** **▶** **◀**

Moves the cursor.

PREV **NEXT**

Selects a field.

Making a New Entry

In the Index or View mode, pressing **NEW** opens a blank form for creating a new entry.

Make the following new Tel entry:

Name	<i>John Smith</i>
Tel.	20 1-529-8200
Fax.	20 1-529-9695
Address	<i>123 Main Street, Mahwah, NJ 07430</i>

1. Press **TEL** to open the application.
The application opens in the Index mode.
2. Press **NEW** on the keyboard.
A blank form opens in the Edit mode.

3. Type in the name *Smith, John*.
4. Press **NEXT** to move to the NUMBER field.
★ Touch NUMBER to move to the field.
5. Type in 201-529-8200 and then press **↵**.
Notice that the cursor has moved to the next line and the size of the field box has been automatically adjusted.

TEL 1		STORE ENTER
CANCEL		
NAME	Smith, John	
NUMBER	201-529-8200	
ADDRESS		

6. Type in 201-529-9695 FAX.

7. Press **NEXT** to move to the ADDRESS field.

★ Touch ADDRESS to move to the field.

8. Type in 123 Main Street followed by **↵**.
Type in Mahwah, NJ 07430.

TEL 1		STORE ENTER
CANCEL		
NAME	Smith, John	
NUMBER	201-529-8200	
	201-529-9695 FAX	
ADDRESS	123 Main Street	
	Mahwah, NJ 07430	

9. Press **ENTER** to store the entry.

★ Touch **STORE**.

The message "Stored!" will appear briefly. The entry is now stored in memory and displayed in the View mode.

☞ In order for the fax function to automatically dial a fax number, it must be entered in FAX NUMBER field. See p. 136 for more information.

➔ For other useful methods available in the Edit mode, see p. 67.

Editing an Existing Entry

To edit an entry already stored in memory, you must first open the entry in the Edit mode where it was created.

1. Press **TEL** to open the application.
 2. Select the desired entry in the Index mode or display it in the View mode.
 3. Press **EDIT** to open the entry in the Edit mode.
 4. Make any necessary changes.
 5. Touch **STORE** to store the changes when you are finished.
- ★ Press **ENTER**.

The new, edited entry is now stored, replacing the original entry.

Editing Techniques

This section explains all the general editing techniques used in the Edit mode when making a new entry or editing an existing entry in all of the applications. (The **Notebook** application has many additional features for working with text; see p. 140 for more information.)

Fields

Most applications divide the display into field boxes. The number of fields in each application varies, as do the types of fields. The different field types include text fields, a date field, time field, and picture field. There are also a few other special types of text fields. You can define the number, type, and names of fields in the **Tel** and **User File** applications (see p. 133).

You can type any character into a text field. The size of a

text field is limited only by the size of the entry. Text fields adjust their size automatically to accommodate the number of lines entered.

Only a date can be entered in a date field, usually in the format of **MM/DD/YYYY**. For example, you would type 06231994 to enter June 23, 1994.

Only the time of day can be entered in the time field, in the format of **HH:MM** followed by **(AM)** or **(PM)**. For example, to enter 9:00 AM, you would type 0900 then press **(AM)**.

You can insert a picture from the **Scrapbook** into a picture field. You cannot enter anything directly into a picture field; a picture must be pasted from the **Scrapbook**. A picture can also be deleted from the field.

➔ See p. 130 for more information about using picture fields.

The cursor

The cursor is used to work with text, indicating the position where text will be entered or deleted. The cursor is also used to indicate selection items in menus or lists. In text fields, where there is no restriction on the type of text (letters or numbers) or number of characters (lines) that can be entered, the cursor appears as ◀ in insertion mode, or as ■ in overwrite mode (see p. 70).

In the date and time fields, the cursor appears as ■, indicating that numbers only should be entered in a specified format (see above).







In some text fields or boxes, the cursor appears as _.

Typing in text

Typing in text is simple and straightforward. The unit's keyboard is laid out similar to the keyboard on a typewriter or computer.





Letters (lowercase and uppercase)

Any of the standard letters (A to Z) can be entered by pressing the appropriate key. All letters will normally appear in lower case. Hold down either of the  keys while pressing letter key(s) to enter upper-case letters.  functions as a "CAPS lock" key on a typewriter or computer. Once pressed, the symbol CAPS will appear in the display. Any letters typed while the Organizer is in CAPS mode will appear in uppercase. To switch back to lower-case mode, simply press  again. To enter lower-case letters while in CAPS mode, hold down  while pressing a letter key.

Numbers



The unit has numeric keys located on the keyboard above the letter keys. Regardless of the CAPS mode (on or off), pressing these keys will enter numbers. Holding down  while pressing a numeric key will, however, enter the symbol printed above that key.

Symbols

The symbols that appear in white above certain keys can be entered directly from the keyboard. Holding down  while pressing a key will allow you to enter these symbols. One symbol, the semicolon, can be entered by first pressing  and then the  key. In addition, a number of special symbols are available by pressing  (see p. 216).

Moving around the display

When working in an entry, the easiest way to move the cursor to a specific location on the display is to touch the location with the pen. The cursor will immediately move to the selected position.

You can also move the cursor around the display with the cursor keys , , and . This may sometimes be more convenient when you are working from the keyboard. In addition, you can hold any cursor key down for rapid movement.

The following convenient key combinations are also available in the Edit mode:



Moves the cursor to the end of the line.



Moves the cursor to the beginning of the line.



Moves the cursor to the first line of a field (or the last line of the previous field if the cursor is already positioned on the first line of a field).



Moves the cursor to the last line of a field (or the first line of the next field if the cursor is already positioned on the last line of a field).

Moving between fields

In addition to the methods described above, you can move the cursor directly to the next field in an entry by touching the desired field name on the display, or by pressing (NEXT) or (PREV). In either case, the cursor moves to the beginning of the desired field.

Inserting and overwriting text

To insert text into existing text, move the cursor to the character you wish to insert text in front of and begin typing. Insertion mode is the unit's default setting, indicated by the triangle cursor ◀. To switch to the overwrite mode, press (INS]. Any text you enter will replace existing text. The cursor appears as ■ in the overwrite mode.

Deleting text

If you make a mistake while entering text, use the following keys to delete the mistake, then enter the correct text:



Deletes the character behind the cursor.



Deletes the character under the cursor.



Deletes the entire line the cursor is on.



Clears the currently selected field. Except in the **Notebook** and **Outline** applications.



Working with blocks of text

It is easy to work with blocks of text on the unit. The first step is to select the text to work with.

1. Hold the touch pen at the beginning of the text and drag it over the entire text that you want to work with. This will “highlight” the text (display it in reverse-white on black). Take the pen off the display when the desired text is highlighted.

TEL 1	
NAME	Smith, John
NUMBER	201-529-8200 201-529-9695 FAX
ADDRESS	100 Main Street Mahwah, NJ 07430

2. You can now perform a number of operations on the selected text:

BS or **DEL**

Deletes all of the selected text.

2nd COPY

Copies the selected text to the clipboard so that it can later be pasted to another location.

2nd CUT

Deletes the selected text from its current location and moves it to the clipboard.



2nd PASTE

Replaces the selected text with whatever is currently in the clipboard.

Once text is selected, any new text that is typed in will replace the selected text.

- ★ You can also delete selected text using DATA DELETION from the menu.
- ➔ For a full explanation of the Cut/Copy/Paste functions, see p. 207.

Scrolling the display

If there is more information than can be displayed at one time, ↓ or ↑ will appear on the top of the display. The arrows indicate the direction you need to scroll in. Press  or  to scroll the information one line at a time.

Finding Specific Entries in Your Unit

There are a number of ways that you can locate entries and information in your unit.

Using the Index mode

The Index mode shows you a listing of all your entries in a particular application.

1. Press the desired application key.
 2. Go to the Index mode if it is not displayed.
 3. Select the file that the entry is in by touching the appropriate tab.
 4. Use the letter tabs to jump to a particular place in the alphabet.
- ★ You can also jump to a specific entry by entering the first letters of the entry. A GO TO window will open, filled in with the letters you typed.

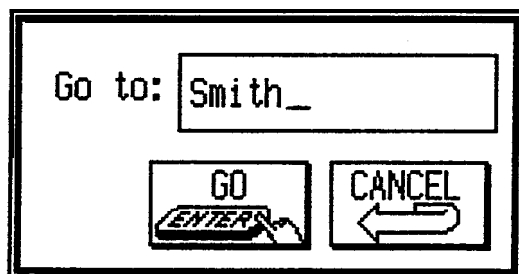

Touch  to jump to that entry.

5. If the entry is still not displayed, press **NEXT** and **PREV** to scroll the list of entries.
6. When the desired entry is displayed, select it and touch **VIEW** to see the entry in full.

Using keywords

If you have no idea where an entry is or what letters it begins with, you will want to use the Search function. For example, suppose that you find a phone number without a name and you want to know whose number it is.

1. Press **SEARCH**.

The SEARCH window will open.

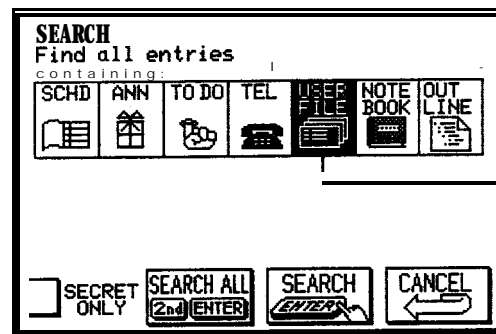

The application you were previously using is selected to be searched by default.

2. Enter the phone number you have found. Type *529-8200*.



To search only secret entries (see p. 282), touch the **SECRET ONLY** box.

3. Touch **TEL** to select this application to search and touch **SEARCH** to begin the search operation. If you are not sure about the application, touch **SEARCH ALL** to search all applications.

The unit will now display the first entry that contains the text, or “keyword,” that you entered.

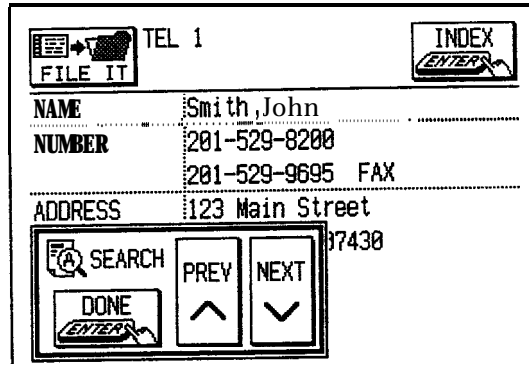

If there is more than one entry that contains the keyword, touch **NEXT** until you find the entry you are looking for. Then touch **DONE** when you have finished searching.



If you highlight text in an entry before pressing **SEARCH**, the text is automatically entered as a keyword.

By topic

The **Filer** lets you group entries by subject. For example, all entries relating to a particular project could be placed into a single **Filer** folder, making it easy to open one or more of the entries when necessary. You can group entries regardless of the applications they were created in, and entries can belong to more than one folder.



Before you can access entries using the **Filer**, you must first assign them to folders. See p. 198 for a full explanation of the **Filer**.

By date

You can use the various **Calendar** views to quickly and easily find information related to a time and/or date.

1. Press **[CALENDAR]**.

The monthly calendar will appear.

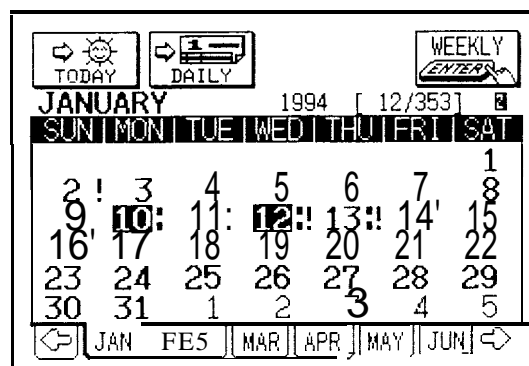

2. Select a day by touching it, then touch **DAILY** or **WEEKLY** to see a more detailed view.

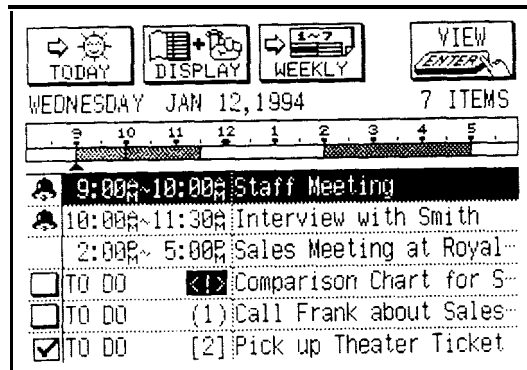

Daily view

3. In the Daily view touch an entry to select it and touch **VIEW** to display the details of the entry.
- ➔ For more information about using the **Calendar** application, see p. 86.

Deleting Entries from the Unit

Entries in the unit can be deleted using either the keyboard or the application menu.

Deleting single entries

1. Open the desired application.
2. Select the entry in the Index mode or display it in the View mode.
3. Press **DEL** on the keyboard.

A warning message appears asking if you are sure you want to delete the entry.

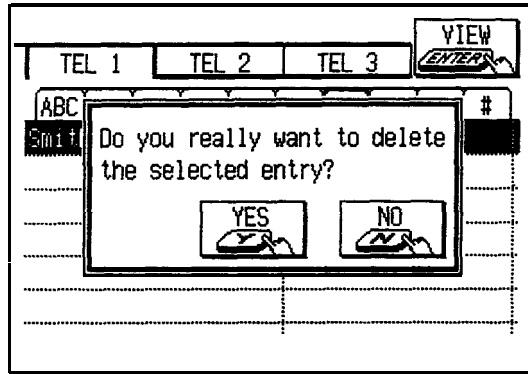

4. Touch **YES** (or **NO** to cancel the deletion).

★ Press **Y** or **N** , respectively.

Deleting entries using the application menu

You can also make deletions using the application menu. The DATA DELETION submenu-a secondary menu opened from the main application menu-gives you a great deal of flexibility in doing this.

1. Open the desired application.
2. Select the entry in the Index mode or display it in the View mode.
3. Press **MENU** and then touch **MODIFY** to open the MODIFY menu.
4. Touch DATA DELETION.

The submenu appears.

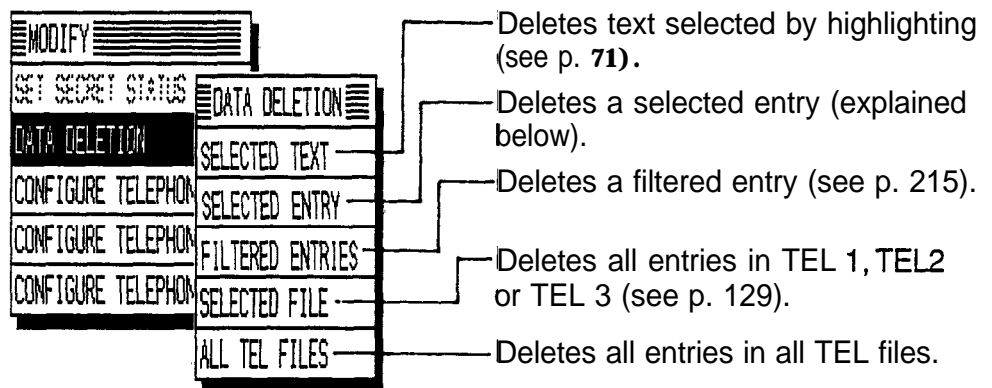

DATA DELETION submenu in the Tel application

5. Touch **SELECTED ENTRY**.
A warning message appears asking if you are sure you want to delete the entry.
 6. Touch **YES** (or **NO** to cancel the deletion).
- ★ Press **Y** or **NJ** , respectively.

Drawing Using the Scrapbook

One of the unit's most powerful, fun, and innovative features is the **Scrapbook** application. The **Scrapbook** gives you the ability to enter drawings as well as handwritten letters and numbers directly on the display. (It is recommended that you use only the touch pen when drawing or writing on the display.)

The **Scrapbook** application always opens to a "blank page."

Using the drawing tools

1. Press **[SCRAPBOOK]** to open the application.

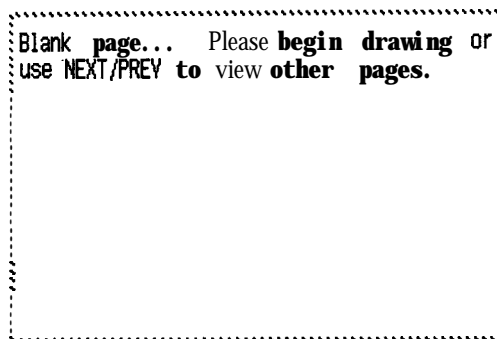

2. You can immediately begin drawing using default set of drawing tools or you can select a different set of tools. (To change the tools, press **(NEW)** and then follow STEP 3.)
3. Press **(MENU)** and touch **MODIFY** .
The **MODIFY** menu appears.

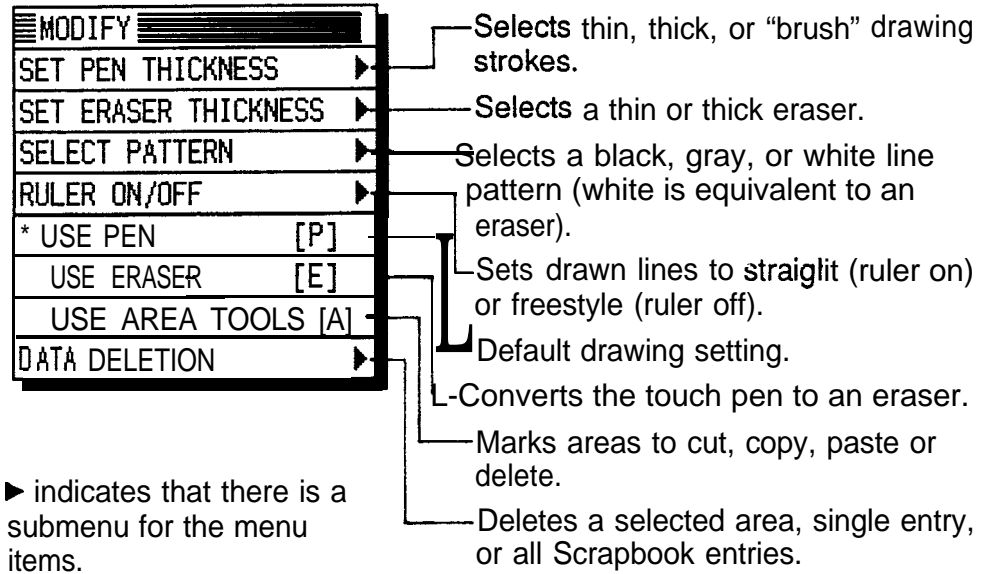

After storing an entry, or pressing **PREV** or **NEXT** to recall a stored entry to the blank page, the display changes to a "viewing page." Existing graphic entries are viewed on this page.

Making new graphic entries

1. Press **SCRAPBOOK** to open the application.
A "blank page" appears on the display.
2. Start drawing anywhere in the drawing area with the touch pen.
3. Write the letter A and draw a circle around it.

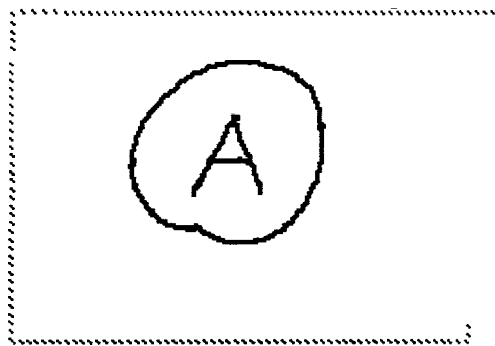

4. Press **ENTER**.

The drawing is now stored.



If you make a mistake while drawing, you can clear it any time before it is stored by pressing **CANCEL**.

Scrapbook entries are stored in the order that they are created, and it is not possible to name the entries.

Press **[SCRAPBOOK]** to open the application.
Press **[PREV]** or **[NEXT]** until the desired entry is displayed.

Revising a graphic entry is similar to making a new graphic entry—both procedures are carried out using the drawing page.

1. Press **[SCRAPBOOK]**.
2. Display the entry in the viewing page.
3. Press **[EDIT]**.
The entry is displayed on the drawing page.

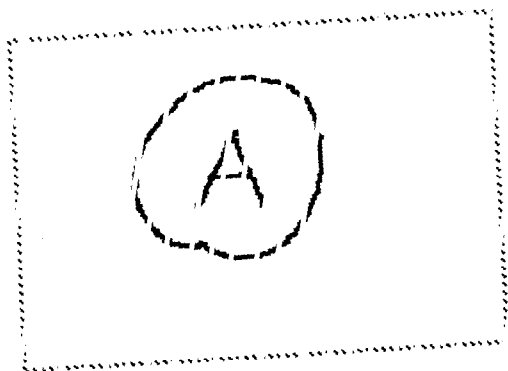

4. Press **[MENU]** and then touch **[MODIFY]** to open the MODIFY menu.
5. Select USE ERASER.
The touch pen can now be used as an eraser.
6. Trace over the letter A with the touch pen.

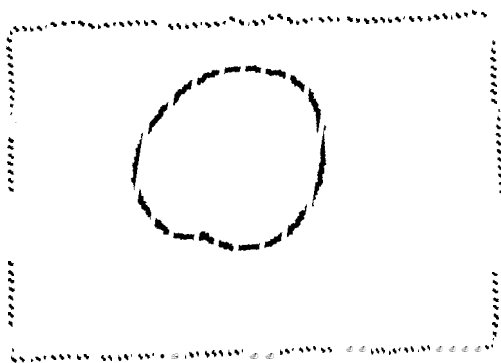

7. Press **MENU** and then touch **MODIFY**.
8. Select **USE PEN** to switch the touch pen back to writing.
9. Draw the letter B.

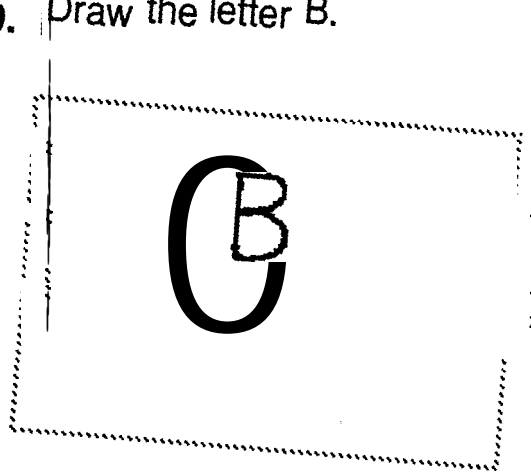

10. Press **ENTER**.
The changes are now stored.

Deleting graphic entries

1. Press **SCRAPBOOK** to open the application.
2. Press **NEXT** or **PREV** to display the drawing you want to delete on the viewing page.
3. Press **DEL**.
A warning message appears asking if you are sure you want to delete the entry.

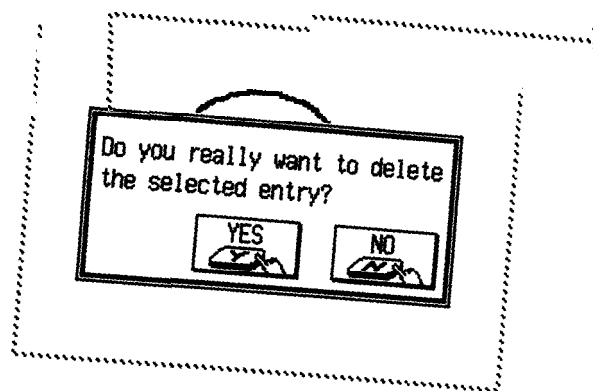

4. Touch **YES** (or **NO** to cancel the deletion).
Press **Y** or **N**, respectively.

Checking the Time and Date

1. To check the current date and time, press and hold **CLOCK**.

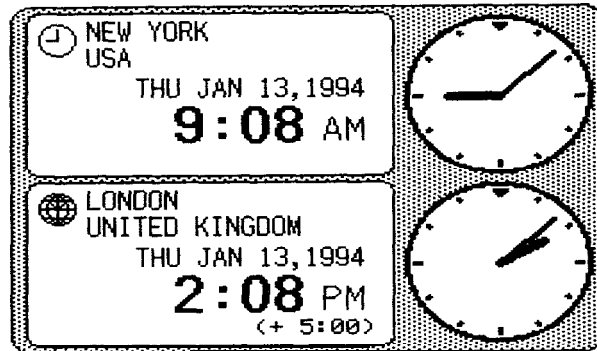

2. Release the key to close the Clock application.
- ➔ For a full explanation of the Clock application, see page 182.

Checking the Unit's Memory

The unit has a certain memory capacity in which operations are carried out and data that has been entered, such as phone numbers and memos, is stored. When the amount of data already stored approaches the unit's maximum memory capacity, you may not be able to store an entry or the data being processed may be lost when you change applications. To avoid these problems, you should check the remaining memory space regularly and free up space when necessary by deleting previous entries.

The **Check Memory** function makes it possible to easily check the amount of free memory available in the unit, as well as in a RAM card (if one is installed), avoiding the inconvenience of seeing an out-of-memory message.

1. Press **MENU** and then touch **TOOLS** to open the TOOLS menu.
2. Select CHECK MEMORY.

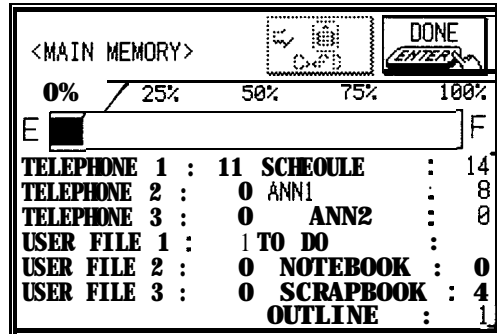

Percentage of memory used.

Number of entries stored for each application.

If a RAM card is installed, you can touch **→CARD** to check the memory available on it.

3. Touch **DONE**.



Even if the display shows a small amount of free memory available, the free memory may be too small for certain features to function.

The Tools Menu-the Unit's Basic Utilities

Many of the unit's basic utilities are accessed through the **TOOLS** menu. The menu is also used to set up and configure certain features such as the display and the **WORD** key. An illustration and summary of the **TOOLS** menu (including page references where full explanations can be found) are provided below.

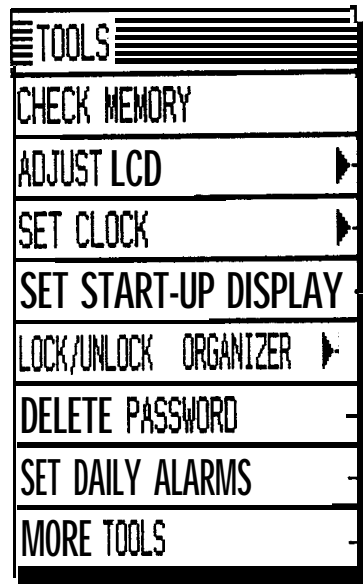

- Shows the amount of free and used memory (see p. 81).
- Adjusts the contrast of the LCD display and calibrates the touch panel (see p. 52).
- Sets the built-in clock (see p. 182).
- Configures the start-up display (see p. 280).
- Locks and unlocks entries protected by the Secret function (see p. 283 to p. 285).
- Changes and deletes passwords (see p. 286).
- Sets and turns off up to 7 alarms to sound daily (see p. 189).
- Open the second TOOLS menu.

First TOOLS menu

Touch MORE TOOLS to open the second TOOLS menu.



- Turns the alarm sound for set alarms on and off (see p. 189).
- Turns the key beep on and off (see p. 54).
- Use to assign words to the **WORD** key (see p. 211).
- Deletes all entries marked as secret (see p. 287).
- Goes back to the first TOOLS menu.

Second TOOLS menu





3

Time Management

3

The unit's **Calendar**, **Schedule**, **To Do**, and **Ann (Anniversary)** applications let you easily structure and manage your time, whether scheduling appointments or providing reminders about important people and events. The explanations and examples in this chapter will give you the information you need to make all of the time management features of these applications work for you on a daily basis.

The Calendar Application

The **Calendar** serves as the unit's "central exchange." It's a calendar that you can reference at any time for the correct date, and it's also a management assistant, indicating important dates so that you can better manage your time and appointments. The application plays three major roles on the unit:

- It is a reliable calendar that can show you any month from January 1901 to December 2099.
- It indicates entries made in other applications, including **Ann, Schedule, and To Do.**
- In the Daily view, it serves as a way of accessing entries made in the **Ann, Schedule, and To Do** applications.

Selecting a calendar view

The **Calendar** application is used to display and indirectly access information. You cannot make entries in the **Calendar**, so it does not have Index, View, and Edit modes. What the application does offer you is five views: Daily, Weekly, Weekly Graph, Monthly, and a Three-month view. Monthly is the default view and it appears each time the application is selected (except when selected from the **To Do** application).

The views are linked, which means that you can switch from one to another and the selected date will not change.

To change the view, touch the desired date then the appropriate button for the required **Calendar** view.

- ★ You can also use the menu to select a **Calendar** view directly from any other view.
 - Press **MENU** and then touch **VIEWS** to open the VIEWS menu.
 - Select the desired view in the submenu.
- ➔ You can change the **Calendar** application's initial display. See p. 288.

The Monthly view

The Monthly view is the **Calendar** application's default view, and appears every time **CALENDAR** is pressed to open the application.

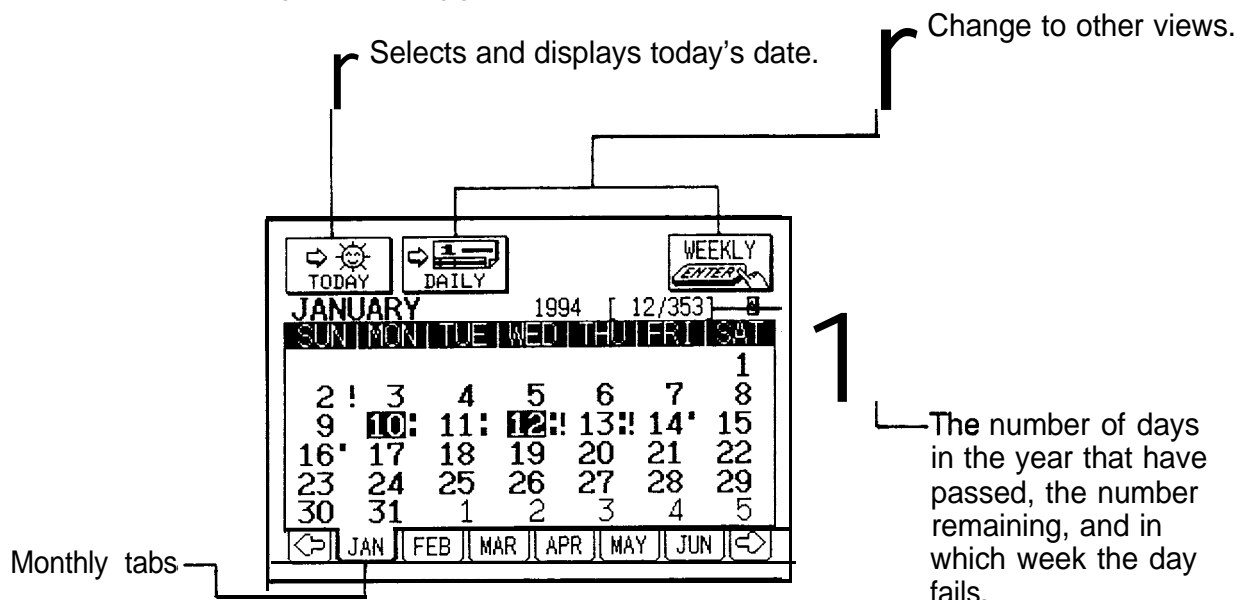

- The flashing date indicates the currently selected date.
- There is an **Ann** entry on the highlighted day (see p. 119).
- ! indicates that the day is a due date for a **To Do** entry (see p. 104).
- An upper dot indicates a **Schedule** entry in the morning, and a lower dot indicates one in the afternoon or evening (see p. 93).

To display another month, touch the monthly tab for the desired month. Touching or displays the following or previous six months, respectively.

★ You can also step through the months sequentially using **PREV** and **NEXT**.

The Three-month view

The Three-month view gives you an overview of a selected month and the month preceding and following it. To open the Three-month view, touch **3 MONTH CALENDAR** in the **IEWS** menu.

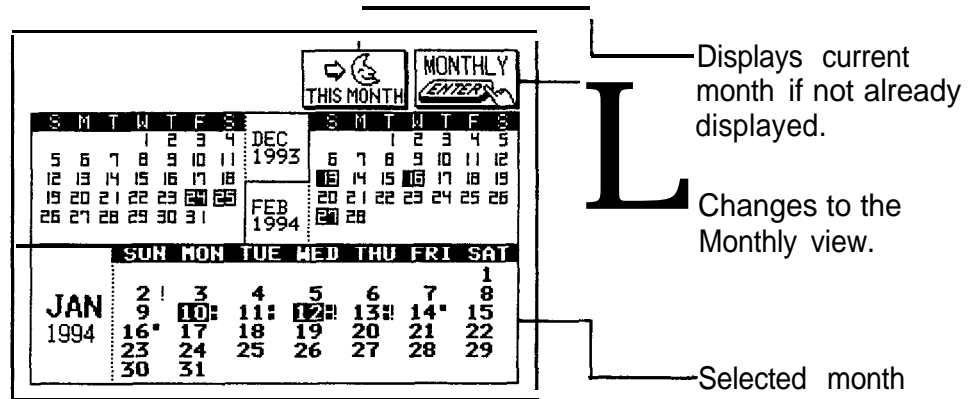

Press **PREV** or **NEXT** to see the previous or next set of three months, respectively.

You can display a Monthly view by touching the selected month.

The Weekly view

The Weekly view shows the schedule over a one-week period. To open the Weekly view, select a date in the Daily or Monthly view and touch **WEEKLY**.

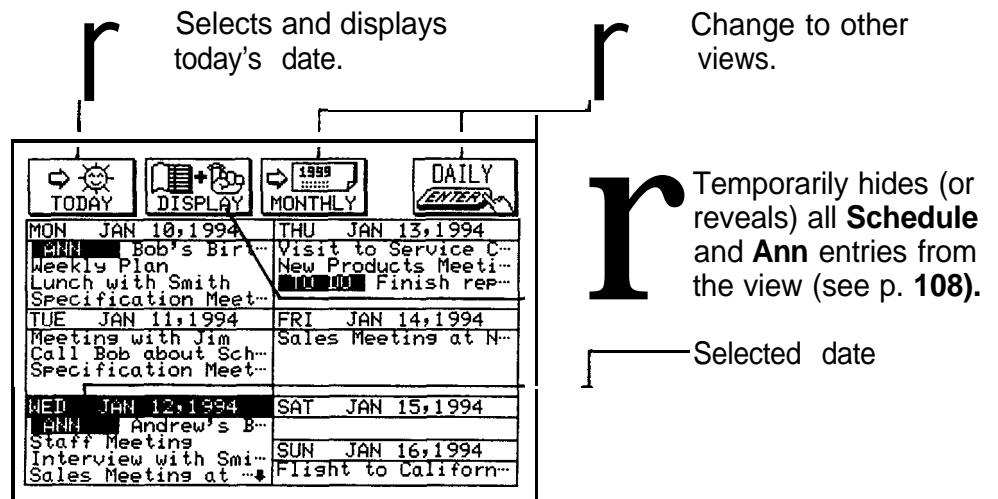

Press **PREV** or **NEXT** to display the preceding or following weeks, respectively.

You can also go to a Daily view by touching the required date twice.

The Weekly Graph view

The Weekly Graph view shows **Schedule** entries over a one-week period, helping you avoid conflicting appointments and letting you check your free time at a

glance. The view must be selected from the application menu.

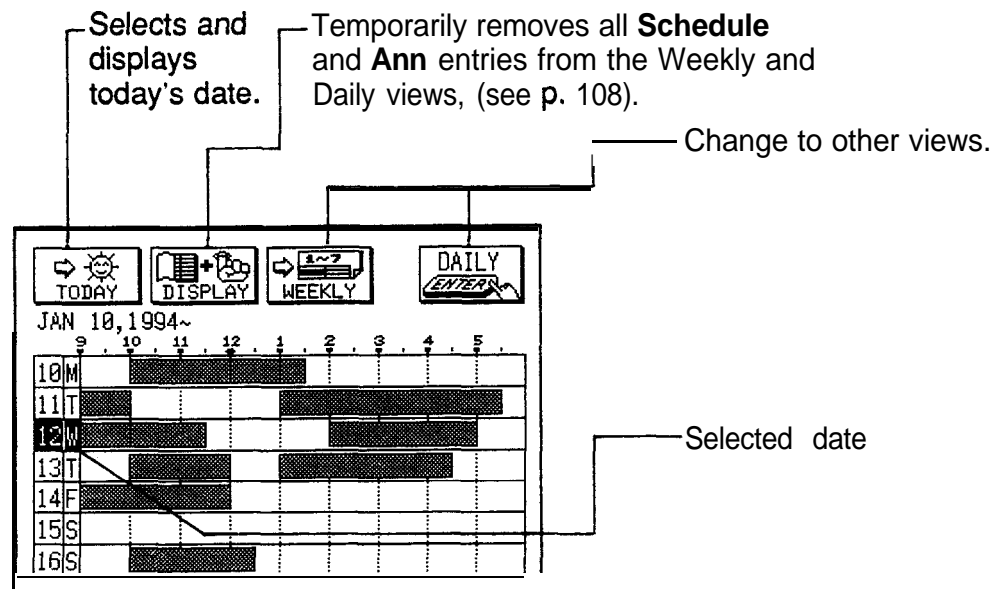

- **Schedule** entries are shown in five-minute blocks.
- Shaded portions indicate times of the day when you have appointments or other commitments. Portions that are blackened indicate that you have more than one appointment during that period.
- To see the morning or evening schedule, press or , respectively.

Press or to display the preceding or following weeks, respectively.

You can go to a Daily view by touching the required day twice.

The Daily view

The Daily view is convenient for viewing all entries for a single day. It can be accessed from the Monthly or Weekly view by selecting a day and touching .

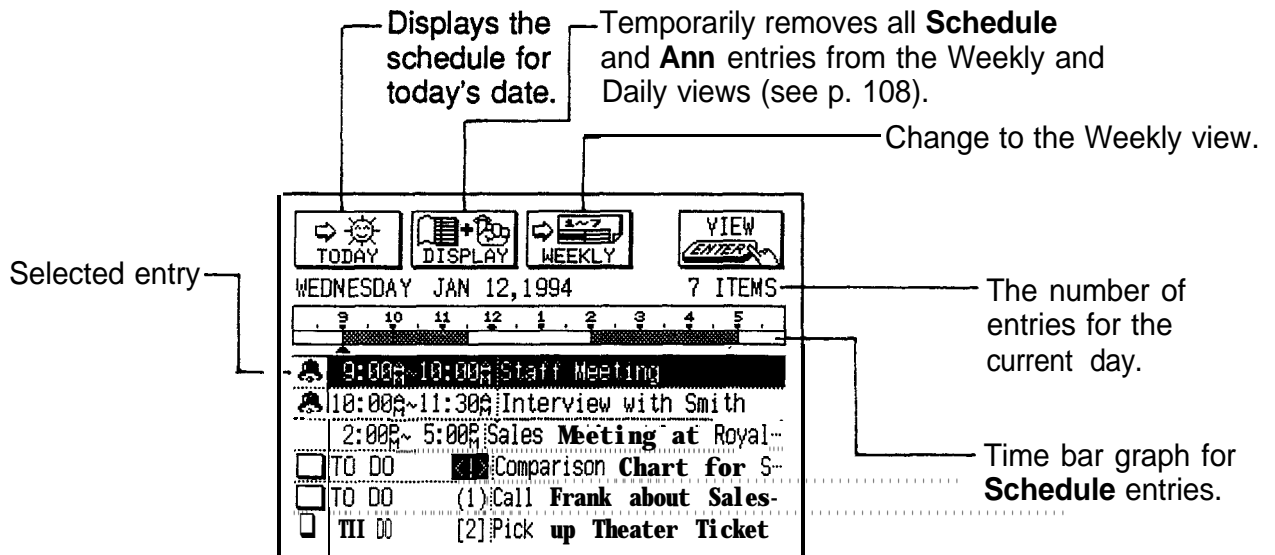

Shaded portions on the bar graph indicate times of the day when you have appointments or other commitments. Portions that are blackened indicate that you have more than one appointment during that period.

Press to display the morning bar graph and to display the evening bar graph.

Touch an entry to select it, or use and to step through the entries, then touch to display the entry in the View mode of the application that was used to create it.

- ★ Touch the entry twice.
- ★ You can also step through days one by one using and .
- If the amount of available memory is small, To Do entries may not be properly displayed in the Daily view. In this case, a message will appear indicating this when the Daily view is selected. To properly display all To Do entries, delete any unnecessary data, then reselect Daily view.

Finding entries using the Calendar views Entries in the **Schedule**, **To Do**, and **Ann** applications can be recalled from the **Calendar's** Daily view.

- In the **Calendar** application,
1. Go to the Daily view.

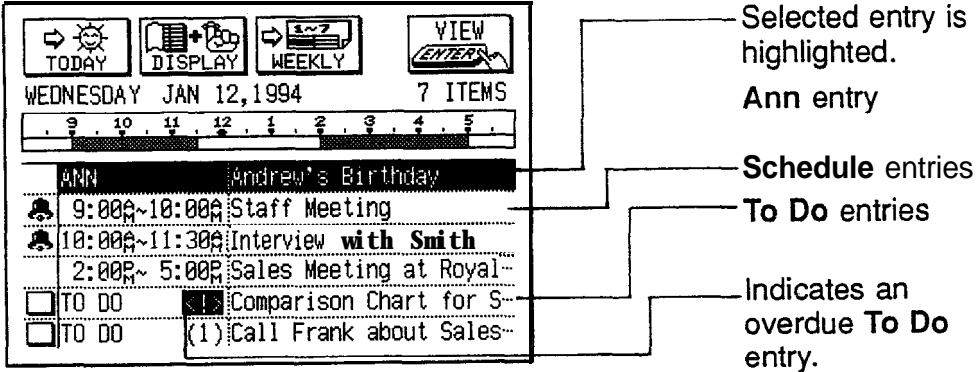

2. Select the entry you want to see in full.
 3. Touch **VIEW**.
- The selected entry is displayed in detail in the View mode.

★ You can also touch the entry twice in the Daily view to go directly to the application's View mode.

- ☞ An overdue entry in the **To Do** application (an entry for which the due date has passed) will always be shown on the display for today's date in **Calendar** views.
- Monthly goals in the **To Do** application can only be accessed via the Monthly view.

Selecting a date

From any view, you can scroll to the previous or next time period (whether the next month, week, or day) by pressing **PREV** or **NEXT**, then touch a particular date, or move the cursor to it, to select it for display in another **Calendar** view. However, another convenient way of selecting a date that is not on the display is using **GO TO A SPECIFIC DATE** in the **Calendar** application menu.

1. Press **MENU**, touch **VIEWS** in any **Calendar** view, and select **GO TO A SPECIFIC DATE**.

A date entry window appears.

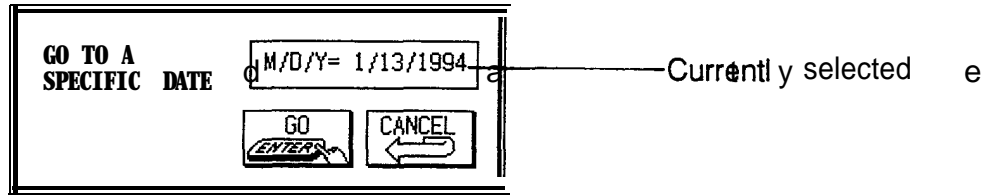

2. Enter the date you want to select in the order of month, day, and year. Prefix single-digit months and days with a 0.

3. Touch **GO**.

The selected date will appear in the current **Calendar** view.

→ You can calculate a date some time in the future or the past using the **Calc** application. See p. 174.

The Calendar application menus

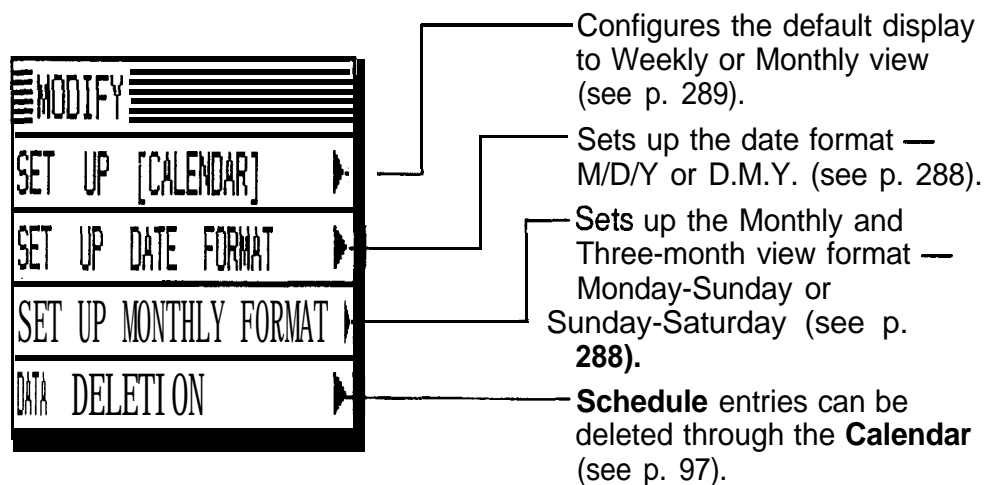
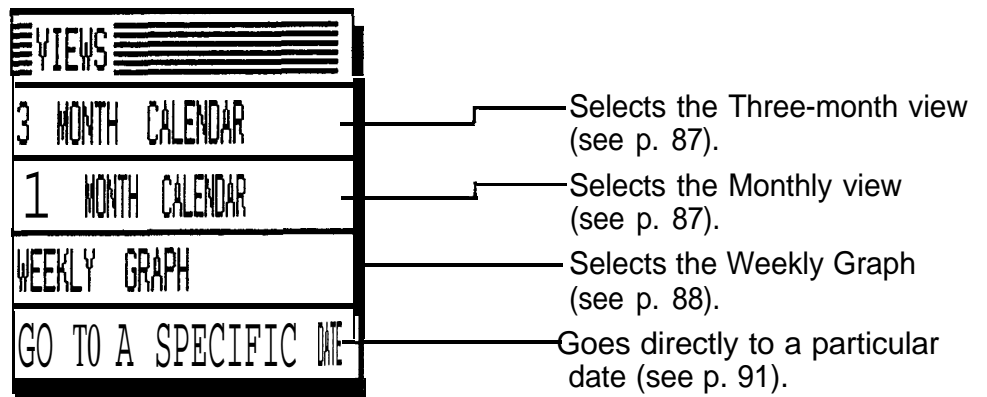

The Schedule Application

The **Schedule** application allows you to enter appointments, times and dates for meetings, parties and events, and set an alarm to sound prior to or at the time of a scheduled entry. This makes it easy to organize your entire day and always arrive at appointments on time. **Schedule** entries are indicated on the **Calendar's** Monthly view with a small black dot next to the date of an entry, providing an overview of your schedule.

Making new entries

A **Schedule** entry has three fields-for the date, time, and a description of the event.

There are three basic steps to making a new entry in the **Schedule** application: selecting the date, entering the starting and ending time, and entering a description for the entry. (Entering a starting and ending time is optional, but you must enter a description.) The date for a new **Schedule** entry can easily be selected in the **Calendar** application.

Enter the following information:

Date	<i>March 15, 1994</i>
Time	<i>8:30 p.m. – 12:00 a.m.</i>
Description	<i>Ides of March Costume Ball</i>

1. Press **CALENDAR**.
2. Display and select the desired date.
3. Press **NEW**.

The Edit mode opens in the **Schedule** application.

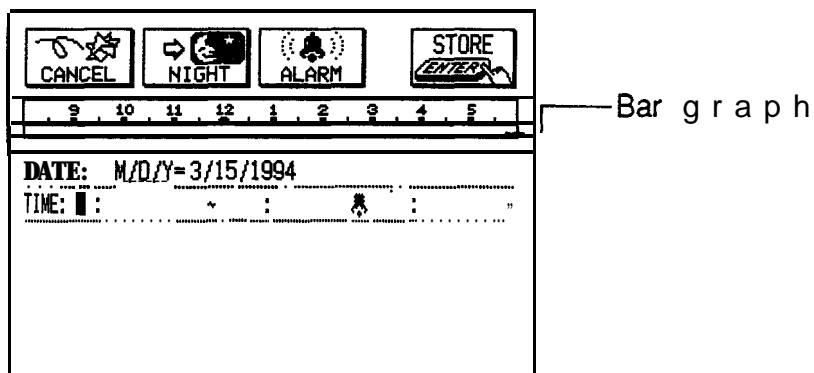

4. Enter the party's starting time from the keyboard. Type 08 30 and press **PM** .

★ You can also enter the starting time using the bar graph, Touch **NIGHT** to display the evening bar graph and then touch beneath 8:30 with the touch pen.

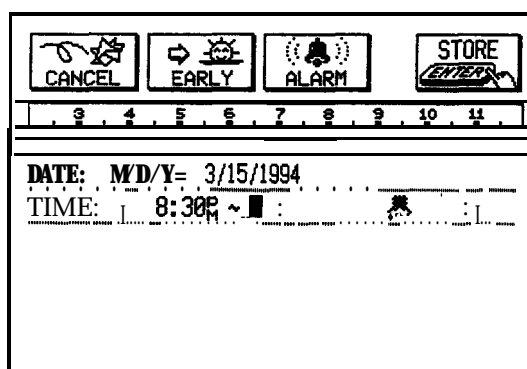

5. Enter the ending time. Type 12 00 and press **(AM)]**.

★ You can also enter the ending time using the bar graph. Touch the end of the bar graph.

6. Move to the DESCRIPTION field.

7. Type *Ides of March Costume Ball*.

8. Touch **(STORE]**.

The new entry is now stored.

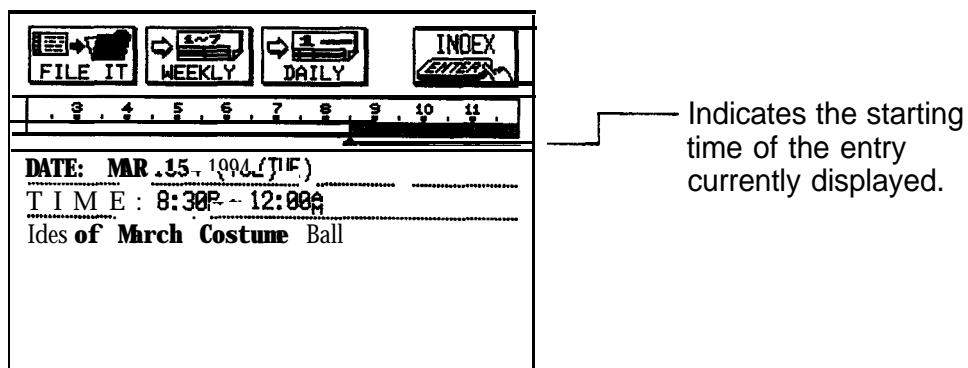

Press (NEW) if you want to make another entry on the same day.

- ➔ You can also select a date for the new entry using the application menu. See p. 99.

Finding entries

Using the Index mode

1. **Go** to the Index mode.

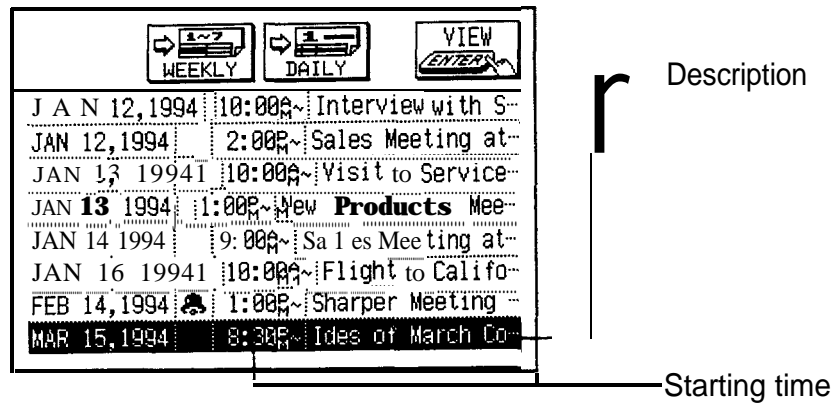

2. Select an entry.
3. Touch **VIEW**.

The full entry is shown in the View mode.

- ★ In step 2, touching an entry twice will also display it directly in the View mode.
- ☞ In the View mode, press **NEXT** and **PREV** to display entries sequentially. This will also display the days that have no entries (as blank pages).

- ➔ You can also jump to entries by specifying the date. See p. 99.

Using the Calendar view

You can access the **Schedule** entries from the Daily view of the **Calendar** application by touching the desired entry twice. (See p. 89 for details.)

Using keywords

Even though you cannot remember the date of an event or appointment, if you know the contents and/or a word that appears in the DESCRIPTION field of the entry, you can access the entry in the following manner.

1. Press **SEARCH**.
The SEARCH window appears.
2. Type in any word that should appear in the DESCRIPTION field of the entry you are looking for.
3. Touch **SEARCH**.
If you still do not see the desired entry, press **NEXT** to display the following matching entries.
4. Touch **DONE** when you find the entry you want.

-  This function does not distinguish between upper- and lower-case letters.

Moving appointments and editing entries

You can easily keep track of schedule changes, including the date and time, by editing entries, without reentering all the information from the beginning.

If the time and/or date of a **Schedule** entry is changed, the entry is automatically resorted.

1. Select the entry you want to change in the Index mode or display it in the View mode.
2. Press **EDIT**.
3. Move to the field you want to change.
4. Make the desired changes.

5. Touch **STORE**.

The new, edited entry is now stored.

You can also use cut and paste to move appointments.

Deleting entries

You can delete single entries or groups of entries.

- ➔ For a full explanation of deleting filtered entries, see p. 215.

Deleting single entries

1. In the **Schedule** application, select the entry you want to delete in the Index mode or display it in the View mode. Or in the **Calendar** application, select the entry you want to delete in the Daily view.
2. Press **MENU**, touch **MODIFY**, and select DATA DELETION.

A submenu opens.

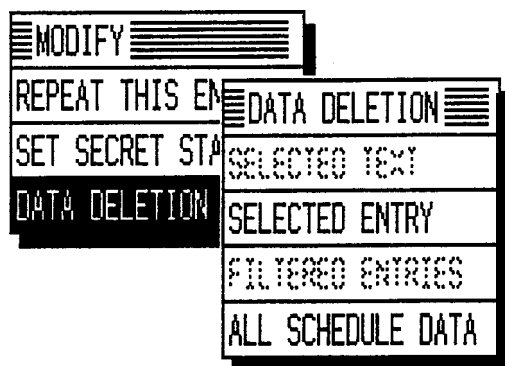

3. Select **SELECTED ENTRY**.

A warning message will appear asking if you are sure you want to delete the entry.

4. Touch **YES** (or **NO** to cancel the deletion).

- ★ You can also delete an entry by pressing **DEL** after selecting or displaying it.

Deleting all entries

All **Schedule** entries can be deleted at one time using the application menu.

1. Press **MENU** and then touch **MODIFY** in the Index or View mode.
2. Select DATA DELETION.
A submenu appears.
3. Select ALL SCHEDULE DATA.
A warning message will appear asking if you are sure you want to delete all the entries in the application.
4. Touch **YES** (or **NO** to cancel the deletion).

 It is not possible to delete all entries simultaneously if the unit is locked. See p. 282.

Deletion of entries over a specific period

You can delete all **Schedule** entries for a period of a month, a week, or a single day through the **Calendar** application.

1. Press **CALENDAR** and select the date which falls in the period you want to delete all **Schedule** entries in.
2. Press **MENU**, touch **MODIFY** and select DATA DELETION.
A submenu appears.

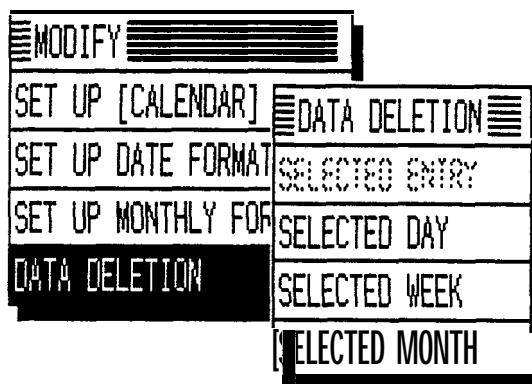

3. Select the desired period for deletion.

A warning message appears asking if you are sure you want to delete all the entries for the selected period.

4. Touch **YES** (or **NO** to cancel the deletion).

★ You can also delete **Schedule** entries for the selected date in any **Calendar** view with **DEL**.

- ☞
- Deletion of entries over a specific period cannot be done if the unit is locked (see p. 282).
 - To delete all **Schedule** entries over a specific period, you must be in a **Calendar** view which includes the entire period you want to delete. For example, you cannot delete entries for an entire week while in the Daily view.
 - The unit recognizes each Monday-to-Sunday interval as one week. If you select a week for deletion, entries over this period will be deleted even if a Monthly view is displayed with a Sunday-to-Saturday format.

Selecting a specific date

If you want to jump to a specific date to find entries or make a new entry, it can be selected easily using the application menu.

1. In the Index or View mode of the **Schedule** application, press **MENU**, touch **VIEWS**, and select GO TO A SPECIFIC DATE.

A date entry window appears.

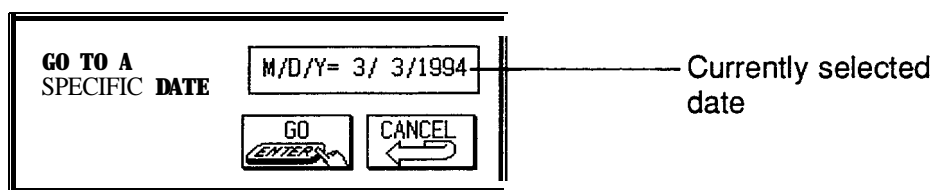

2. Enter the date you want to go to.

3. Touch **GO**.

The first entry on that day is selected in the Index mode, or displayed in the View mode.

If you would like to make a new entry, press [NEW], or if you would like to view other entries on that date, press **NEXT** or **PREV**.

Making entries for recurring and extended events

Using the **Schedule** application's Repeat function, you can copy entries to other days or dates without having to type in each one individually. This is convenient for those appointments, meetings, and other events that are held regularly. The Repeat function can also be used to enter an event that spans a period of a few days or a few weeks, such as a business trip or vacation. Six different types of repeating events include:

- **Daily** Repeats a day-for events that span consecutive days.
- **Weekly** Repeats the same day each week-for regular weekly events.
- **Monthly by day** Repeats the same day of each month (for example, the first Tuesday)-for regular monthly events on a specific day.
- **Monthly by date** Repeats the same date each month (for example, the 10th)—for regular monthly events on a specific date.
- **Bi-weekly** Repeats a day every other week.
- **Work day** The same as Daily repeat, but excludes weekends.

You have a five-day vacation beginning on June 24th.

1. Select the date that the entry will occur for the first time in the **Schedule** or in the **Calendar** application.
2. Press **NEW**.
3. Move to the DESCRIPTION field.
4. Enter the description. Type *Vacation*.
5. Touch **STORE**.
6. Press **MENU**, touch **MODIFY** and select REPEAT THIS ENTRY.

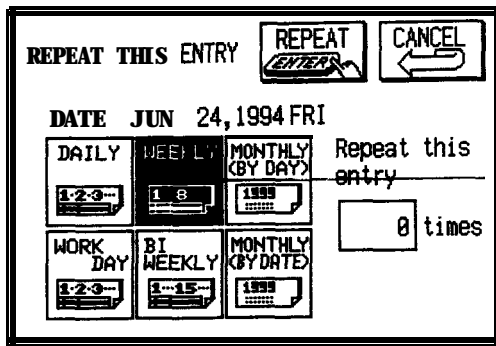

WEEKLY is the default repeat setting.

7. Touch **DAILY**.

8. Enter the number of additional days on which the event will repeat. An entry can be repeated up to 999 times. In this case, type 4.

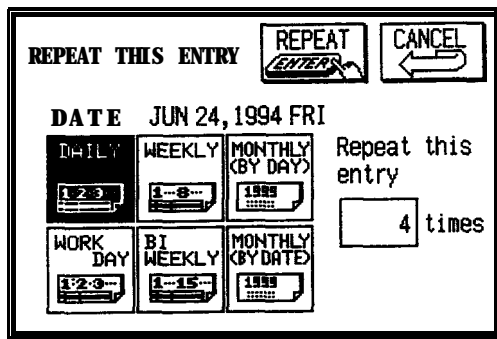

9. Touch **REPEAT**.

Your five-day vacation is now stored.

You can confirm that your vacation has been entered by looking at the **Calendar** view.

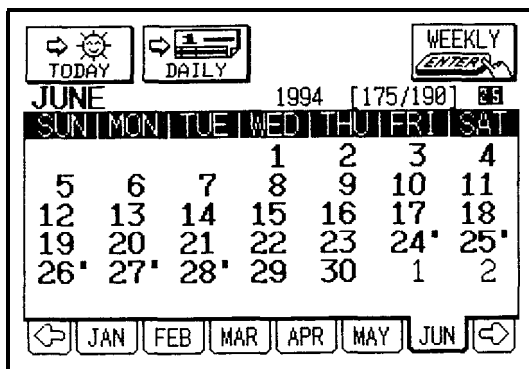



- To repeat an entry that has already been stored, select it in the Index mode or display it in the View mode, then proceed from step 6 above.
- Events like “the second and fourth Thursday of each month” can be generated by making two different schedule entries and repeating each one.

Setting a Schedule alarm

A Schedule alarm can be set to remind you of scheduled events such as appointments and meetings. You can set an alarm for any entry that has a starting time set. Set alarms will sound even if the unit is turned off. After setting the alarm for a scheduled event,  will appear next to the event in the Index mode and in the **Calendar's** Daily view.

Enter the following information with an alarm set for one hour in advance:

Date	<i>March 16, 1994</i>
Time	<i>1:00-2:00 pm</i>
Description	<i>Lunch with Jo</i>

1. In the **Calendar** or **Schedule** application, select the date and press **NEW**.
2. Enter the starting time and ending time, each followed by **PM**.
The cursor moves to the alarm time field.
3. Enter the desired alarm. Type **1200 PM**.
4. Touch **ALARM**.
★ Press **2nd** **[ALARM]**.
 appears.

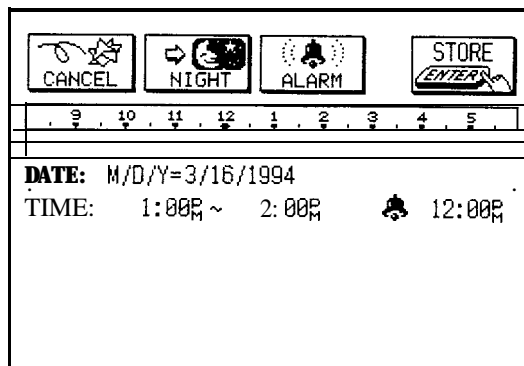

5. Move to the DESCRIPTION field and type *Lunch with Jo*.
6. Touch **STORE**.

 appears at the top of the display indicating that any set alarms will sound when their respective times are reached.

- ★
 - If you want to set the alarm at the schedule's starting time, skip step 3 above.
 - To set an alarm for an entry that has already been stored, display the entry in the View mode and press **2nd** **ALARM**. This will set the alarm at the entry's starting time. If you want to set a different alarm time, you must display the entry in the Edit mode.
- ➔ You can also set alarms separately from Schedule entries. See p. 188.

Clearing a set alarm

To clear an alarm that has been set for an entry, display the entry in the View mode and press **2nd** **ALARM**, or touch **ALARM** when the entry is displayed in the Edit mode.

- ➔ You can disable all set alarms at once. See p. 189.

The Schedule application menus

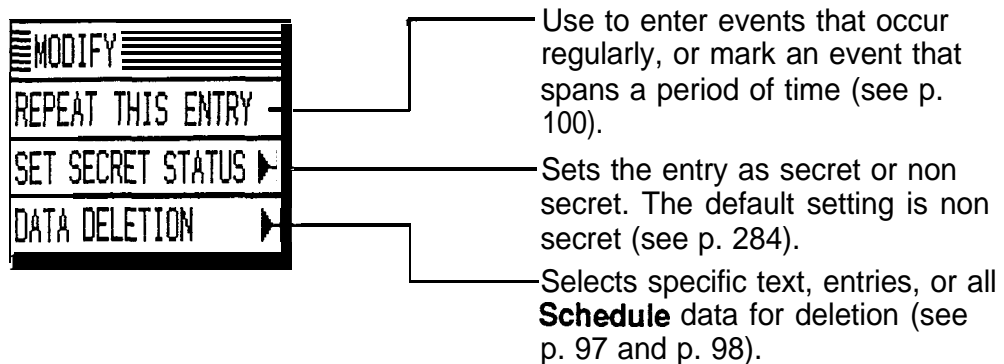
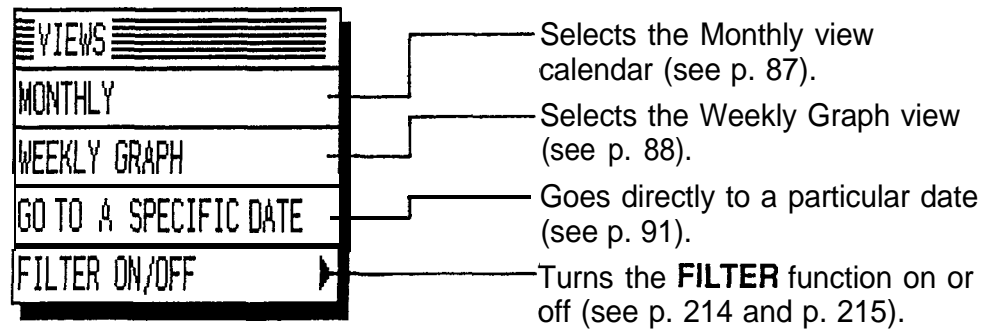

The To Do Application

The **To Do** application is a valuable organizational tool to help meet deadlines and to add structure and efficiency to your work and the goals that you set for yourself. This application allows you to organize and track tasks and objectives, to assign them a level of priority, and to assign up to five categories to each entry, making it possible to access them in a variety of ways. To help you in this effort, entries are automatically categorized by the unit as TO BE DONE, DONE ENTRIES, or MONTHLY GOALS.

Making new entries

Entries in the **To Do** application contain eight fields: Description, Due Date, Priority, and five fields for categories. These categories, which you can define and assign, can be used to manage tasks by project, the personnel involved in them, etc.

The way in which **To Do** entries are displayed in the **Calendar** views will differ depending on the contents of the Due Date field, as follows:

- Entries with no due date are always shown on the display for today's date.
- Entries with a full due date (month, day, and year) are shown only on that date.
- Entries for which only a month and year (no day) have been entered appear in the monthly goals box in the Monthly view.

This system provides the flexibility for an entry to be displayed according to the type of task. For example, you could enter a daily task, leaving the DUE DATE field blank, and it would be displayed every day in that day's schedule; or for a long-term project, enter the month in the DUE DATE field without a specific date and it will be shown only in the Monthly view.

Assigning priority to entries

In the PRIORITY field you can enter a number (0-9) or letter (A-Z) (but not special or accented characters), which then act to indicate the importance of a task or project. (Numbers are given priority over letters.)

Enter the following information:

Description	<i>Prepare Alpha project proposal for John</i>
Priority	<i>1</i>

1. Press **(TO)**.
2. Press **(NEW)**.
The Edit mode opens.

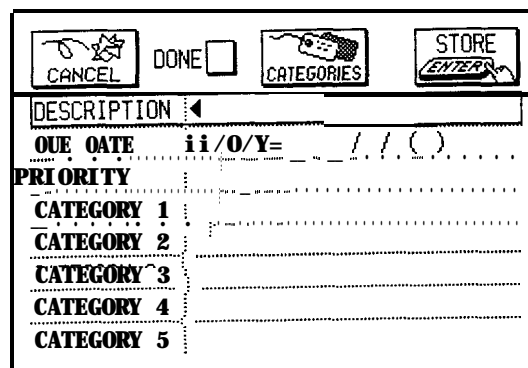

3. Enter the description of the entry. Type *Prepare Alpha project* **(↵)** *proposal for John*.
4. Skip the DUE DATE field and move to the PRIORITY field.
5. Type *1*.

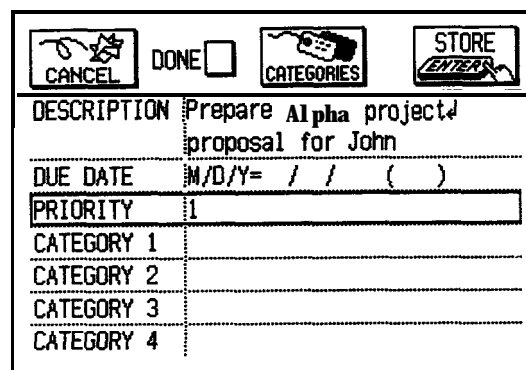

6. Touch **(STORE)**.
The entry is now stored.

Assigning due dates to entries

Enter the following information:

Description	<i>Sales report</i>
Due Date	<i>Mar10, 1994</i>

In the **To Do** application,

1. Press (NEW) .
2. Type *Sales report?*.
3. Move to the DUE DATE field. Enter the due date in the order of month, day, year. Type *03 10 1994*,
4. Touch .

Entering a monthly goal

If you enter only the month and year in an entry's DUE DATE field (with no specific date), the entry becomes a "monthly goal," and will be displayed in the Monthly view of the **Calendar**.

You have a manuscript you have to read by the end of August.

In the **To Do** application,

1. Press .
2. Enter a description. Type *Read manuscript*.
3. Move to the DUE DATE field.
4. Enter the month when you want to accomplish this. Type **08**.
5. Press **|** twice (skipping the date) and enter the year. Type 1994.
6. Touch .
The entry is now stored.
Now check that the entry you made is displayed on the **Calendar**.
7. Press .

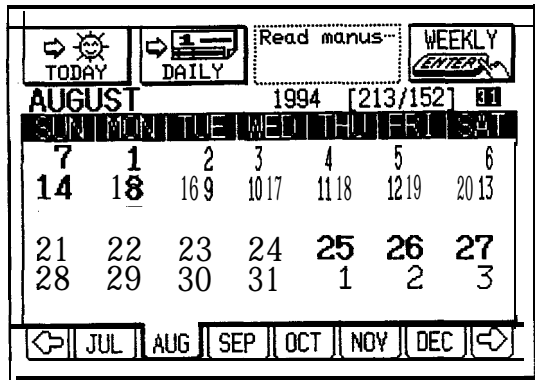

Touch the description in the dotted — border box to access the Index mode for monthly goal entries.

Finding and reviewing entries **Using the Index mode**

1. Go to the Index mode.

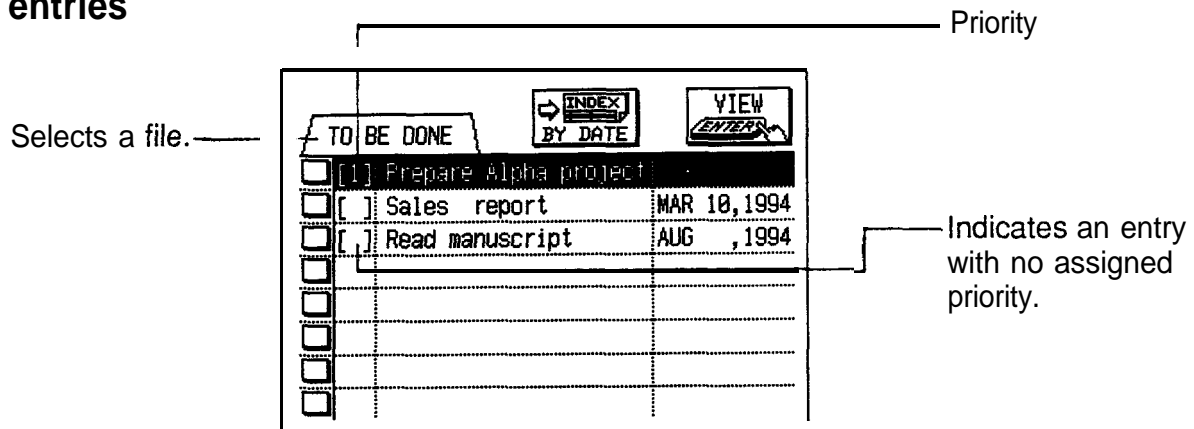

The Index mode in the **To Do** application can show entries based either on their priority level or their due date. In the default setting, entries with an assigned priority are displayed first (in the order of number, letter), followed by entries with no assigned priority. Touch **BY DATE** in the Index mode to display entries in chronological order based on the due date. To return to a display based on priority, touch **PRIORITY**. This means you can access entries in the way that is most convenient for you.

2. Press **MENU**, touch **VIEW**, and select the file you want to review.
3. If you want to see the details of an entry, select the entry and touch **VIEW**.

- ★ Touch the entry twice.
The entry is displayed in the View mode.

Using the Calendar views

To Do entries are indicated with an ! beside their due dates in the Monthly view of the **Calendar** application. In the Daily and Weekly views, you can get a clear overview of the **To Do** entries by temporarily eliminating all **Ann** and **Schedule** entries from the current view.

1. Press **CALENDAR**.
2. Go to the Daily view.
3. Touch **DISPLAY**.
All **Ann** and **Schedule** entries are hidden from view.

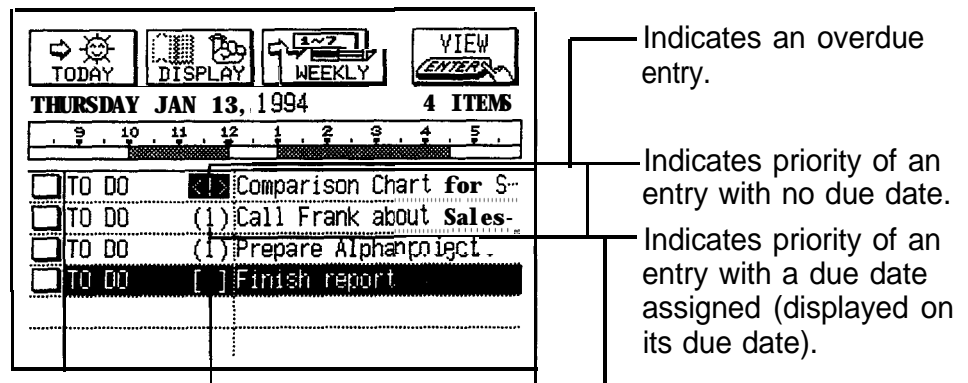

4. If you want see the details of an entry, select the entry and touch **VIEW**.

- ★ Touch the entry twice.
The entry is displayed in the **To Do** View mode.

- ☞
 - Once the **Ann** and **Schedule** entries are hidden, this setting will remain in effect and they will not be displayed in either the Weekly or Daily views.
 - To return hidden **Ann** and **Schedule** entries to the display, touch **DISPLAY** again in the Weekly or Daily view.
 - An overdue entry (an entry for which the due date has passed) will always be shown on the display for today's date in addition to its due date in the **Calendar** views.

Using keywords

Using the contents of any fields, including the DUE DATE and PRIORITY fields, you can access desired entries directly.

a

In the **To Do** application,

1. Press **SEARCH**.
The SEARCH window appears.
2. Type in any word you remember in the entry you are looking for. This word may appear in any field of the entry.
3. Touch **SEARCH**.
If you still do not see the desired entry, touch **NEXT** to display the following matching entries.
4. Touch **DONE** when you find the entry you want.



This function does not distinguish between upper- and lower-case letters.

Editing entries

1. Select the entry you want to change in the Index mode or display it in the View mode.
2. Press **EDIT**.
The Edit mode opens with the selected entry.
3. Make the desired changes.
4. Touch **STORE**.
The new, edited entry is now stored, and resorted based on the new data.

Checking off completed entries

Once you have reached a target or goal you set for yourself, it is a good idea to check off the entry as completed so that you can always focus on things to be done. An entry marked done will be resorted into the DONE ENTRIES file and remain displayed on the “done date” in the **Calendar** views. This allows you to go back and review entries that have been completed.

This operation can be done either using the **Calendar**,

which makes it easy to check completed entries when you check your schedule for the day, or in the **To Do** application, which lets you check off a Monthly goal entry or a task that you have completed before its due date.

Checking off entries using the Calendar

1. Press **CALENDAR**.
2. Go to the Daily view.
3. Display the date you want to check, or touch **TODAY** if you want to check today's schedule.
If the entry you want to check off is not displayed, press **▼** until it appears.

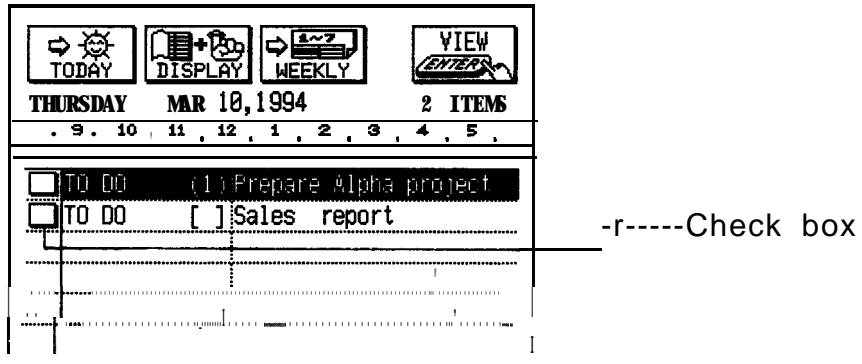

4. Touch the check box next to the entry you have completed.
- ★ Select the completed entry and press **✓** on the bottom row of the keyboard.

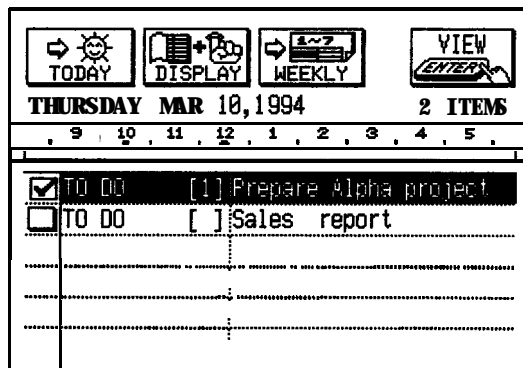

The box is marked with **✓**. The entry is now marked as completed, and it is marked as having been completed

today. The entry is now resorted into the DONE ENTRIES file.

- ☞ If you mistakenly check off an entry as completed, you can uncheck the entry by touching the check box or pressing again. However, if you do this, the entry will be stored without a due date.

Checking off entries in the To Do application

1. Select the entry in the Index mode or display it in the View mode.

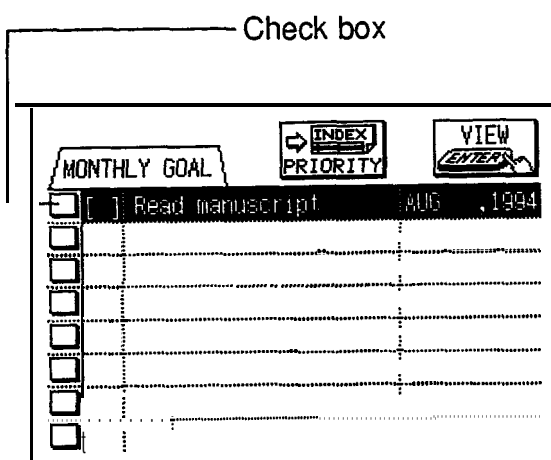

2. Touch the check box.

★ Press .

The entry is checked off and the box is marked with . The DUE DATE field changes to the DONE DATE field and today's date appears in it.

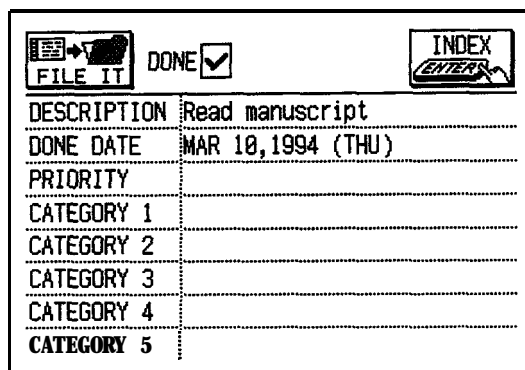

The entry is now restored into the DONE ENTRIES file.

- ☞ If you mistakenly check off an entry as completed, you can uncheck the entry by touching the check box or pressing again. However, if you do this, the entry will be stored without a due date.
- ➔ Once a project or task is completed, and you no longer need the **To Do** reminder, you can delete the entry, or groups of entries, which will free up memory in the unit. See p. 117.

Using categories

A category is a field that can contain keywords of up to 12 characters that you specify. You can use categories to facilitate information management, for example, to group tasks by project, personnel, or other criteria that are important to you. A total of up to 32 categories can be used in the **To Do** application, and up to five categories can be assigned to each entry.

Once a word is entered in the category field of an entry, that word is automatically registered and sorted alphabetically in the category list, in which you can select a category to assign to an entry. You can also manually add a word directly to the category list, as well as editing and deleting words in the list.

- ☞ Be careful when manually adding categories the unit recognizes upper and lower case letters differently. In other words “For John” and “for john” are considered 2 different categories by the unit.

Making entries using categories

Enter the following:

Description	<i>Call Frank about Alpha Project</i>
Due Date	<i>Mar 15, 1994</i>
Category 1	<i>Phone Call</i>
Category 2	<i>Alpha Pro.</i>

1. Press .
2. Enter the description and due date. Type *Call Frank about* *Alpha Project* *03 15 1994.*
3. Move to the CATEGORY 1 field.

4. Enter the category. Type *Phone Call*.
5. Move to CATEGORY 2. Type *Alpha Pro*.

	DONE <input type="checkbox"/>		
DESCRIPTION	Call Frank about Alpha Project		
DUE DATE	M/D/Y= 3/12/1994(SAT)		
PRIORITY		
CATEGORY 1	Phone Call		
CATEGORY 2	Alpha Pro.		
CATEGORY 3		
CATEGORY 4		

6. Touch **STORE** .
The entry is stored and, at the same time, the two categories you entered are registered in the category list.
7. Press **MENU** , touch **VIEWS** , and select VIEW BY CATEGORY to check the list.

VIEW SCREEN		
TO BE DONE	DONE	MONTHLY GOAL
CATEGORIES		
Alpha Pro.	Phone Call	PREV ^
.....	NEXT v

You cannot use the same category more than once in the same entry.

Assigning categories using the category list

1. When entering or editing an entry in the Edit mode, move to any of the five CATEGORY fields.
2. Touch **CATEGORIES** .

The Category window opens with the first category selected. Categories are listed in alphabetical order.

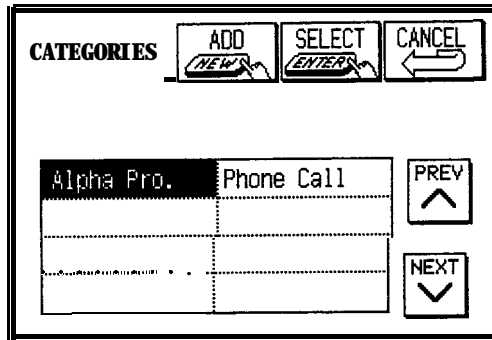

3. Select the desired category and touch **[SELECT]**.
- ★ Touch the desired category twice.
The category window closes and the selected category is entered in the entry.
4. Touch **[STORE]**.
- ★ You can also open the CATEGORIES window using the menu. In step 2, press **[MENU]**, touch **[MODIFY]**, and select CATEGORIES.
- ☞ You cannot use the same category more than once in the same entry.

Reviewing the To Do list by category

You can check only the entries that have been assigned a specific category.

1. Press **[MENU]** and then touch **[VIEWS]**.

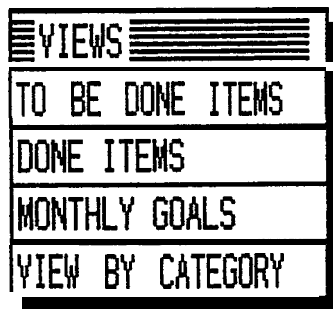

2. Select VIEW BY CATEGORY.
A box opens showing the first 8 categories.
Touch **[PREV]** or **[NEXT]** to see the preceding or following 8 categories, respectively.

3. Select the category that you want to check by touching it twice.

All entries that have been assigned the selected category are shown in the Index mode. You can return to the view screen by touching the category tab once.

Adding categories to the category list

You can add a category directly to the category list at any time in the **To Do** application. You can have up to 32 categories.

1. Press (MENU), touch **MODIFY** , and select CATEGORIES.
 - ★ If you are in the Edit mode, touch [**CATEGORIES**] .
The CATEGORIES window opens.
2. Touch **ADD** .
 - ★ Press **NEW** .
A NEW CATEGORY window opens.

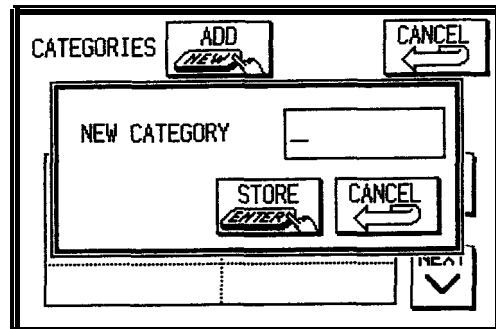

3. Enter a category name up to 12 characters long.
4. Touch **STORE** .
The new category is added to the list, and all categories are resorted.

Editing categories

If you want to edit a category name, you are

recommended to use the category list so the changes will be reflected in all entries that category is assigned to. You can edit a category at any time in the **To Do** application.

1. Press (MENU), touch **MODIFY** , and select CATEGORIES.

2. Select the category you want to edit.

3. Press **EDIT**.

If the category is currently being used in an entry, a message asks if you want to edit it anyway. Touch **YES** to proceed.

An EDIT CATEGORY window opens.

4. Make any desired changes.

5. Touch **STORE** .

The new, edited category is now stored in the list, and the changes are reflected in all entries the category is assigned to.



If you edit a category in an entry, it is registered in the category list as a new category.

Deleting categories

When you find a category that is not needed any more, after project completion for example, you may want to delete the category from the category list.

A category cannot be deleted if it is being used by an entry.

1. Press (MENU) , touch (MODIFY), and select CATEGORIES.

2. Select the category you want to delete.

3. Press **DEL** .

A warning message will appear asking if you are sure you want to delete the category.

4. Touch **YES** (or **NO** to cancel the deletion).

Deleting entries

Deleting single entries

1. Select the desired entry in the Index mode or display it in the View mode.
 2. Press **MENU** , touch **MODIFY** , and select DATA DELETION.
A submenu opens.
 3. Select **SELECTED ENTRY**.
A warning message will appear asking if you are sure you want to delete the entry.
 4. Touch **YES** (or **NO** to cancel the deletion).
- ★ You can also delete single entries by pressing **DEL** in step 2 above.

Deleting all entries in the current view

You can delete all the entries in the TO BE DONE, DONE ENTRIES, or MONTHLY GOALS file, or all entries assigned a specific category, using the application's MODIFY menu. This is especially convenient for deleting all of those entries that have been checked off as completed.

1. Press **MENU** , touch **VIEW** , and select the file containing the entries you want to delete.
2. Press **MENU** , touch **MODIFY** , and select DATA DELETION.

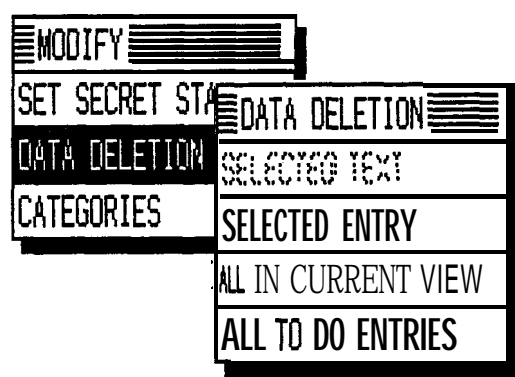

3. Select **ALL IN CURRENT VIEW**.

A warning message will appear asking if you are sure you want to delete all the entries in the selected file.

4. Touch **YES** (or **NO** to cancel the deletion).

☞ It is not possible to delete all entries in a file simultaneously if the unit is locked. See p. 282.

Deleting all To Do entries

You can delete all of the **To Do** entries in all files.

1. Press **MENU**, touch **MODIFY**, and select DATA DELETION.
2. Select ALL TO DO ENTRIES.

A warning message will appear asking if you are sure you want to delete all **To Do** entries.

3. Touch **YES** (or **NO** to cancel the deletion).

☞ It is not possible to delete all entries simultaneously if the unit is locked: See p. 282.

The To Do application menus

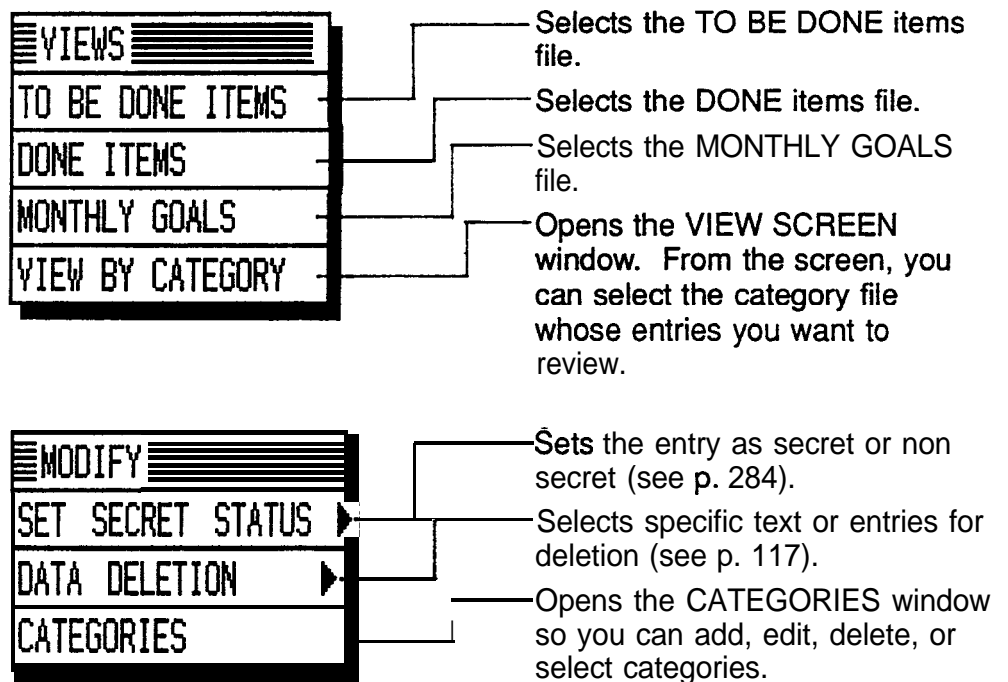

The Ann (Anniversary) Application

The **Ann (Anniversary)** application makes it easy for you to keep track of annual events, such as wedding anniversaries and birthdays of friends, relatives and business associates. Once entered, the dates of annual events are displayed on the **Calendar** highlighted in white on black, making it possible to prepare for them well in advance every year.

Making new entries

There are two files in the **Ann** application. The first file, ANN 1, stores and displays entries that occur on a specific date every year, and the second, ANN 2, stores and displays entries that occur on a specific day, for example, the first Tuesday in November. ANN 1 is the default file.

Making new entries in the ANN 1 file

Enter the following in the ANN 1 file:

Date *May 17*
Description *Jo's Birthday*

1. Press **ANN** .
The Index mode opens in the ANN 1 file.
2. Press **NEW** .
The Edit mode opens.

The screenshot shows the ANN 1 application interface. At the top, there is a title bar with 'ANN 1' in the center. On the left side of the title bar is a 'CANCEL' button with a cursor icon, and on the right side is a 'STORE ENTER' button with a cursor icon. Below the title bar, there is a form with two main sections. The first section is labeled 'DATE' and contains a sub-section 'M/D=' followed by a space for the day. The second section is labeled 'DESCRIPTION' and is currently empty.

3. Enter the date in the order of month, day (there is no year entry). Type 05 17.

4. Move to the DESCRIPTION field.
5. Enter the description of the event. Type Jo's *Birthday*.

ANN 1

CANCEL STORE ENTER

DATE M/D= 5/17

DESCRIPTION Jo's Birthday4

6. Touch **STORE** .
- The entry is now stored.

Making new entries in the ANN 2 file

Enter the following in the ANN 2 file:

Day	<i>The second Sunday in May</i>
Description	<i>Mother's Day</i>

In the **Ann** application,

1. Press (**MENU**) and then touch **VIEWS** .
2. Select ANN 2.
The Index mode opens.
3. Press (**NEW**) .
The Edit mode opens.

ANN 2

CANCEL STORE ENTER

M=MONTH W=WEEK
D=0: SUN 1: MON 2: TUE 3: WED 4: THU 5: FRI 6: SAT

DAY M/W/D= / /

DESCRIPTION

4. Enter the month and day, using the appropriate number equivalents shown on the display. Type 05 2 0.

5. Move to the DESCRIPTION field.
6. Enter the description. Type *Mother's Day*.
7. Touch **STORE**.

- ★ In the Index mode, you can select a file simply by touching an index tab for the desired file.

Finding entries

Entries are stored in chronological order in each file.

Using the Index mode

1. Go to the Index mode.
2. Select the file by touching the appropriate tab. If the desired entry is not displayed, press **PREV** or **NEXT**.
3. Select the entry and then touch **VIEW** to display the entry in full.

- ★ Touch the entry twice.

Using the Calendar view

In the **Calendar's** Monthly view, **Ann** entries are indicated by dates highlighted in white on black, clearly showing that you have important annual events on those days.

You can access the **Ann** entries from the Daily view in the **Calendar** application by touching the desired entry twice. (See p. 94 for details.)

Using keywords

If you cannot remember the exact date of an important anniversary, a friend's birthday for example, follow the procedure below to access the entry and check the date.

1. Press **SEARCH**.
The SEARCH window appears.
2. Type in any word that should appear in the DESCRIPTION field of the entry you are looking for.
3. Touch **SEARCH**.
If you still do not see the desired entry, touch **NEXT** to display the following matching entries.

4. Touch **DONE** when you find the desired entry.

 This function does not distinguish between upper- and lower-case letters.

Editing entries

1. Select the file in which the desired entry is stored.
2. Select the entry in the Index mode or display it in the View mode.
3. Press **EDIT** to open the Edit mode.
4. Make the desired changes.
5. Touch **STORE** .
The new, correct entry is now stored.

Deleting entries

Deleting single entries

1. Select the entry in the Index mode or display it in the View mode.
2. Press **MENU** , touch **MODIFY** , and select DATA DELETION.
A submenu opens.
3. Select **SELECTED ENTRY** .
A warning message will appear asking if you are sure you want to delete the entry.
4. Touch **YES** (or **NO** to cancel the deletion).

★ You can also delete single entries by pressing **DEL** in step 2 above.

Deleting all entries

1. Press **MENU** , touch **MODIFY** , in the Index or View mode and select DATA DELETION.
A submenu appears.
2. Select **ALL ANN 1** or **ALL ANN 2** .
A warning message will appear asking if you are sure you want to delete all entries in the file.

3. Touch **YES** (or **NO** to cancel the deletion).

★ You can also delete all entries in both ANN files. Simply select ALL ANN FILES in step 2 above.

👉 It is not possible to delete all entries simultaneously if the unit is locked. See p. 282.



The Ann application menus

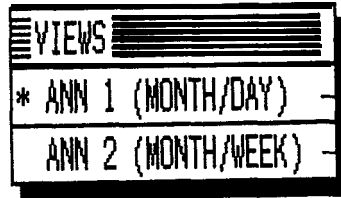

Selects the ANN1 file.

Selects the ANN2 file.

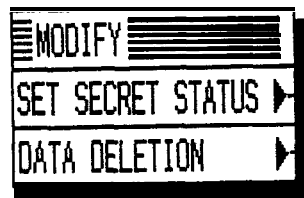

Sets the entry as secret or non secret (see p. 284).

Selects specific text or entries for deletion (see p. 122).



4

Creating Your Own Database

4

This chapter will discuss using the **Tel (Telephone)** and **User File** applications. The two applications are actually identical in the way that they function, except that they have different default file and field names to accommodate different types of information. The flexibility of these applications allows you to manage a wide variety of information, from a simple address book to an extensive restaurant guide or even a listing of your favorite movies. You can even store graphic images in each entry.

The Tel and User File Applications

Each application comes with three files (or directories).

- The three **Tel** files are all set up by default to manage a simple address book. Each entry is set up to contain three fields (Name, Number, and Address).

- The three **User File** directories are set up by default as follows:

USER FILE 1 Business card file containing eight text fields (Company, Name, Position, Ext./Direct, Department, Tel. number, Fax number, Address) and one picture field (Map)

USER FILE 2 Restaurant guide file containing seven text fields (Cuisine, Name, Number, Address, Prices, Attire, Remarks) and one picture field (Map)

USER FILE 3 Free file containing five text fields

You can store information in any file you want.

- Remember that you can easily change these settings to meet your personal needs. See page 133 for more information on customizing these applications.

Selecting a file

Before beginning a particular operation, you must first select a file you want to work with.

1. Press **TEL** or **USER FILE** to open the desired application.
2. Press **MENU** and touch **VIEWS** to open the VIEWS menu. The currently selected file is marked with an asterisk.
3. Select the desired file.

- ★ In the Index mode, you can select a file simply by touching the tab of the desired file.

Making new entries

- In the **Tel** or **User File** application,
1. Select the file in which you want to store the information using the procedure shown above.
 2. Press [NEW].
The Edit mode opens.
 3. Type in all the information desired in each field.
 - In the Name field of a **Tel** entry, enter the last name first if you want to sort entries by last names.
 - You must always enter information in the first field.

BUSINESS	
CANCEL	STORE ENTER
COMPANY	ABC Consulting
NAME	Hamil ton Olivia
POSITION	Account Manager
EXT/DIRECT	8977
DEPARTMENT	Eas t Coast Region
TEL NUMBER	212-555-1212
FAX NUMBER	212-555-1253
ADDRESS	Sharp Plaza, New Jersey)

4. Touch [STORE] when you are finished.
The message "Stored!" will appear briefly, indicating that the entry is now stored in memory.

→ See p. 130 regarding how to enter graphic images into the picture field.

Finding entries

Entries in the **Tel** and **User File** applications are stored alphabetically based on the contents of the first field. There are three basic ways to find and display an entry.

Using the Index mode

1. Go to the Index mode.
2. Touch the tab for the file you believe the entry is in.
3. Touch the tab of the letter that the entry begins with.
If you do not see the entry you are looking for, press [NEXT] until you do.

4. Select the entry, then touch **VIEW** to see it in detail.
- ★ Touch the entry twice.

Search by heading

If you know the contents of the first field of the entry you are looking for, the Go To search is a very fast way to retrieve the entry.

1. In the View or Index mode, type in the first few letters of the first field of the entry.
The GO TO window will open, filled in with the letters you have typed.
2. Touch **GO**.
 - If you do not see the entry you are looking for, press **NEXT** until you do.
 - If you are in the Index mode, select the entry and touch **VIEW** to see it in detail.

☞ Go To search does not distinguish between upper- and lower-case letters.

Using keywords

If you are not sure of the name or the contents of the first field of an entry, but you do know a word that appears in the entry, then use the Search function to find it.

1. Press **SEARCH**.
The SEARCH window appears.
2. Type in a word that appears in the entry you are looking for.
3. Touch **SEARCH**.
If you do not see the entry you are looking for, touch **NEXT** until you do.
4. Touch **DONE** when you find the entry.

☞ The Search function does not distinguish between upper- and lower-case letters.

Editing entries

1. Select the entry in the **Index mode** or display it in the **View mode**.
 2. Press **EDIT**.
The entry opens in the **Edit mode** with the cursor in the first field.
 3. Make any desired changes.
Touch **CANCEL** at any time to discard any changes you have made.
 4. Touch **STORE** when you have finished.
The message "Stored!" will appear briefly, indicating that the changes are now stored in memory.
-  If you changed the contents of the first field, the entry is resorted based on the changes.

Deleting entries

Deleting single entries

1. Select the entry you want to delete in the **Index mode**, or open it in the **View mode**.
 2. Press **MENU**, touch **MODIFY** and select **DATA DELETION**.
 3. Select **SELECTED ENTRY**.
A warning message will appear asking if you are sure you want to delete the entry.
 4. Touch **YES** (or **NO** to cancel the deletion).
- ★ You can also delete single entries by pressing **DEL** in step 2 above.

Deleting all entries

1. Press **MENU**, touch **VIEWS**, and select the file you want to clear all entries.
2. Press **MENU**, touch **MODIFY**, and select **DATA DELETION**.
3. From the submenu, select **SELECTED FILE**.

A warning message will appear asking if you are sure you want to delete all entries in the selected file.

4. Touch **YES** (or **NO** to cancel the deletion).

★ You can also delete all entries in all three of the application's files. Simply select ALL TEL FILES or ALL USER FILES in step 3 above.

👉 It is not possible to delete all entries either in a single file or in all three files simultaneously if the unit is locked. See p. 282.

Using picture fields

Any drawing created in the **Scrapbook** can be copied and then pasted into a picture field. Both the **Tel** and **User File** applications can have picture fields. These pictures can be, for example, hand drawn maps, notes, or a signature.

➔ For information about defining field types, see p. 134.



Adding a picture to an entry

To add a picture to an entry, first be sure that the file you are using has at least one field set up as a picture field. USER FILEs 1 and 2 come set up with a picture field (Map).

While entering or editing an entry in the Edit mode:

1. Press **SCRAPBOOK** to open the application.
2. Press **PREV** or **NEXT** to display the desired drawing. If you have not yet made a drawing, make one now and press **ENTER**.
3. Press (2nd) **COPY** to copy the drawing to the clipboard, or press (2nd) **CUT** then touch **YES** if you will not need the drawing again in the **Scrapbook** application; this saves memory since the drawing is not duplicated.
4. Press **USER FILE** to go back to the application.
5. Move to the picture field.

6. Press (2nd) **PASTE** to paste the picture into the field.

	BUSINESS	
CANCEL		
NAME	Hamilton, Olivia	
POSITION	Account Manager	
EXT/DIRECT	8877	
DEPARTMENT	East Coast Region	
TEL NUMBER	212-555-1212	
FAX NUMBER	212-555-1253	
ADDRESS	Sharp Plaza, New Jersey	
MAP	[Paste picture here]	

4

Note that the message in the field changes from “Paste picture here” to “Touch to view picture.”

7. Touch **STORE** .

Viewing the contents of picture fields

If you want to see the contents of the picture field, simply touch the message “Touch to view picture”. This will display the picture.

Editing the contents of picture fields

Contents of picture fields cannot be edited directly in the **Tel** and **User File** applications. Amend them by replacing the old picture with a new one, or edit by copying the picture back to the **Scrapbook** application.

1. In the View mode touch the message “Touch to view picture” to open the picture you want to edit, then press (2nd) **COPY** .

If you are in the Edit mode, move the cursor to the picture field, then press (2nd) **COPY** .

The picture is copied to the clipboard.

2. Press **SCRAPBOOK** to open the application.

3. Press (2nd) **PASTE** .

The picture is pasted to the drawing page.

4. Make any changes desired to the picture and press **ENTER**

- Copy the revised picture and paste it back to the picture field in the **Tel** or **User File** entry opened in the Edit mode (see p. 136).

Be sure to touch **STORE** after pasting to store the entry with the new picture.

Deleting the contents of picture fields

- Open the entry in the Edit mode whose picture field contents you want to delete.
- Move to the picture field.
- Press **DEL**.
The picture is opened with a message asking if you are sure you want to delete the contents of the field.
- Touch **YES** (or **NO** to cancel the deletion).
- Touch **STORE** when you have finished editing the entry.

→ Deleting a picture from the picture field in the **Tel** or **User File** does not affect entries in the **Scrapbook**.

The Tel application menu

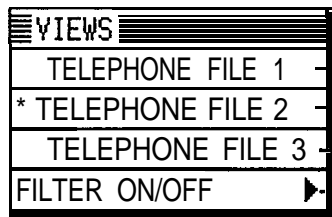

- Selects the TEL1 file.
- Selects the TEL2 file.
- Selects the TEL3 file.
- Turning the Filer function on allows you to view only specified entries (see p. 214).

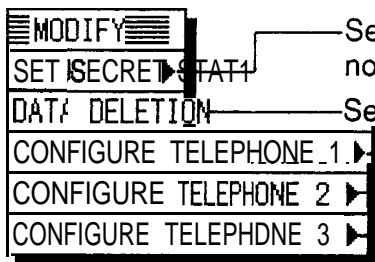

- Sets the entry as secret or non-secret (see p. 284).
- Selects specific text or entries for deletion (see p. 129).
- Define your own file and index format (see p. 133).

The User File application menus

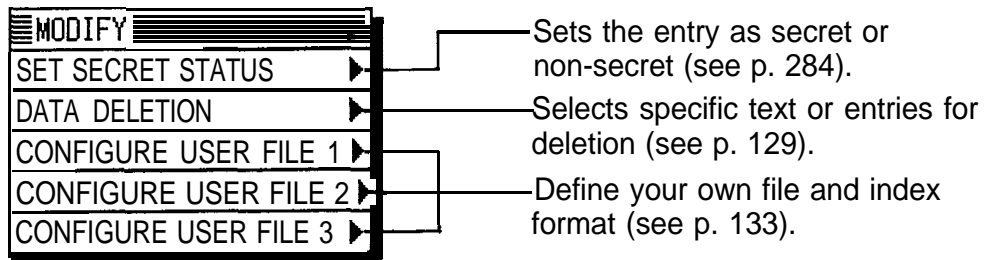
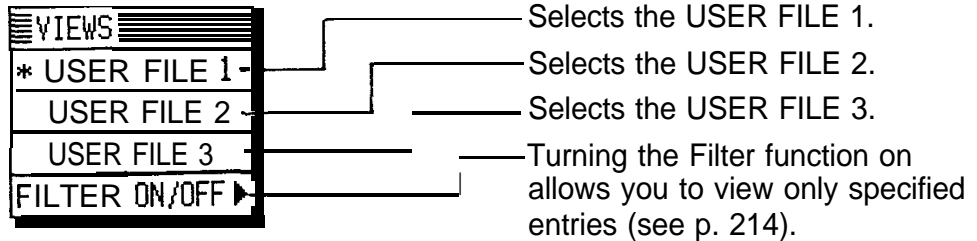

Customizing the Tel and User File Applications

You can customize the **Tel** and **User File** applications in the following three ways:

- File names: you can give each file a name of up to 10 characters of your choice.
- Fields: you can change the field names (up to 12 characters per field), the field type (text or picture), and the number of fields that each entry can have (up to 16).
- The Index mode display: you can determine which fields (up to 3) are displayed in the Index mode and how many characters are displayed for each field (up to 38 characters total).

Changing file names

1. Press **TEL** or **USER FILE** to open the application containing the file that you want to change the name of.
2. Press **MENU**, touch **MODIFY**, and select one of the three CONFIGURE menus.

The CONFIGURE submenu appears.

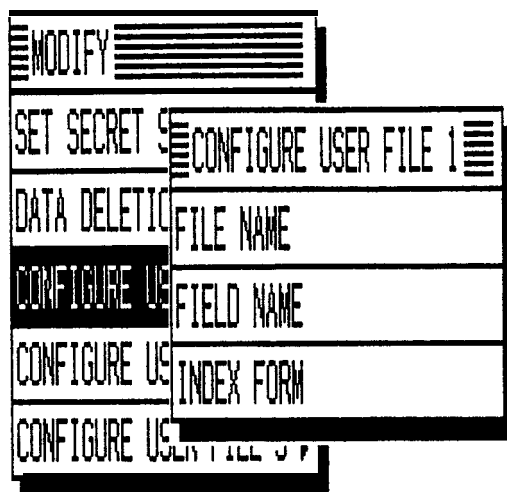

3. Select FILE NAME. The FILE NAME window opens.

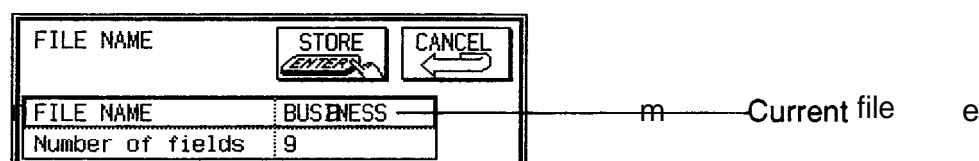

4. Press to clear the current name.
5. Enter the new name (up to 10 characters).
Letters, numbers, and symbols can all be entered.
6. Touch to store the new name.
(Or to cancel any changes and leave the original file name.)

Configuring fields

If you do not want to change the number of entry fields, skip steps 1-6 below.

1. Press or to open the application that you want to set up the fields in.
2. Press , touch , and select one of the three CONFIGURE menus.
The CONFIGURE submenu appears.
3. Select FILE NAME. The FILE NAME window opens.

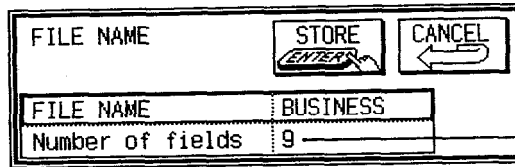

Number of fields currently set and used in this file.

4. Move to “Number of fields” and press (a) **NEW** to clear the current number in the field.
5. Enter the number of fields that you want your entries to have.



If you decrease the number of fields for a file that has some entries stored, fields will be deleted from the bottom of the file until the decreased number of fields is reached. The information stored in those fields will also be deleted.

6. Touch **STORE** to store the number of fields you entered. (Or **CANCEL** to cancel any changes and leave the original number,)
7. Press **MENU**, touch **MODIFY**, and select one of the three CONFIGURE menus.
The CONFIGURE submenu appears.
8. Select FIELD NAME. The FIELD NAME window opens.

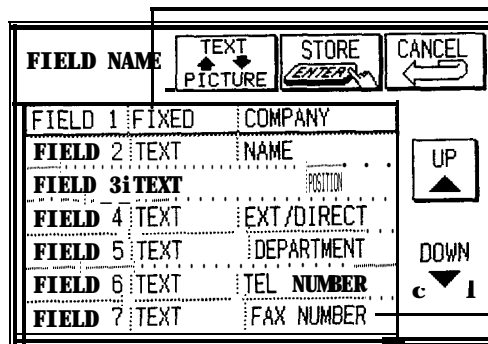

The field data type: fields marked for TEXT store text, and fields marked for PICTURE store graphic images.

Field name: enter the name of the field (up to 12 characters).

9. Move to the desired fields and change them as required.
 - Use **NEW** to clear the current name.
 - Enter the new name (up to 12 characters). Letters, numbers, and symbols can all be entered.

- Touch **TEXT↔PICTURE** to toggle between the two data types.
10. Touch **STORE** when you have finished.
(Or **CANCEL** to cancel the changes and leave the fields as they were.)

-  • If you change the data type setting of a field between TEXT and PICTURE, all entries made in the field at the previous setting will be deleted.
- The data type for Field 1 is TEXT and cannot be changed. You can specify PICTURE for any of the remaining 15 fields. However, picture data requires greater memory space than text data and the picture data space for each entry is limited. You cannot paste pictures to an entry exceeding this limit.

Configuring a fax number field The fax number field is used by the fax function for automatic dialing. While the User File has a fax number field built in, one must be set up for the Tel application. To do so, follow the procedure above. In step 8, enter FAX NUMBER as one of your fields, and touch STORE when you are finished.

-  When entering fax numbers in the FAX NUMBER field, be sure to include hyphens in the appropriate places. A hyphen following the area code is necessary for the fax function to correctly dial locally or long distance, as specified during faxing.

Customizing the Index display You can set up a different Index format for each of the three files in the **Tel** and **User File** applications, designating up to three fields you want displayed in the Index mode and the number of characters for each field.

In the **Tel** or **User File** application,

1. Press (MENU), touch **MODIFY**, and select one of the three CONFIGURE menus.
2. Select INDEX FORM. The INDEX FORM window opens.

Field name	Number of characters
COMPANY	13
NAME	13
POSITION	0
EXT/DIRECT	0
DEPARTMENT	0
TEL NUMBER	12
FAX NUMBER	0

4

- From one to three fields can be displayed in the Index mode.
 - The total number of characters you can have for all fields is 38.
3. Select and enter 0 in those fields that you do not want to appear in the Index mode.
 4. Select the fields that you want to appear in the Index mode, and enter the number of characters that you want the field to be able to hold. Remember that the total maximum number of characters for all fields is 38. If the desired fields are not all displayed, use **UP** and **DOWN** to scroll the display.
 5. Touch **STORE** when you have finished (or **CANCEL** to cancel the changes).
- You can set any text fields to be displayed in the Index mode. No matter which fields appear in the Index, entries are sorted and accessed by the contents of the first field.
 - You must set at least one field to be displayed.



5

Word Processing and Outlining

5

This chapter explains the features of the **Notebook** application, the unit's built-in word processor, and the **Outline** application, a simple but powerful outliner for structuring your thoughts, ideas, and writings. Used together, first outlining a document and then developing it in the **Notebook**, these two applications provide powerful word processing capabilities in a hand-held device.

The Notebook Application

The unit's **Notebook** application provides you with a simple yet powerful means of recording information, from notes at a meeting and letters to passages of a speech. As with a standard word processor, the **Notebook** lets you set margins, tabs and indents, select A4, letter, or legal page size, turn word wrap on or off, and change fonts. With a printer connected to the unit, this gives you the capability to print out attractive full-page letters, reports and other documents (see p. 152).

Before reading this chapter, be sure you have read "Editing Techniques" in Chapter 2. More advanced editing features are used in this chapter. Be sure you have a good understanding of basic editing procedures used on the unit before beginning to use the **Notebook** application.

Making new entries

Enter the following:

Title: *Letter to Frank*
Text: *May 10, 1994*
Mr. Frank Smith
Chairman
ABC Co. Ltd.

Dear Mr. Smith:
Thank you for your fax of May 5th, 1994 regarding the Alpha Project.
We agree that it is too difficult to answer your questions about our new project properly based on the available information.
We will receive the proper documentation within the next week.
This shouldn't cause any delay in our production schedules.
Sincerely,

1. Press **NOTEBOOK** to open the application.
As with the other applications you have used, the **Notebook** application opens in the Index mode.
2. Press **[NEW]**.

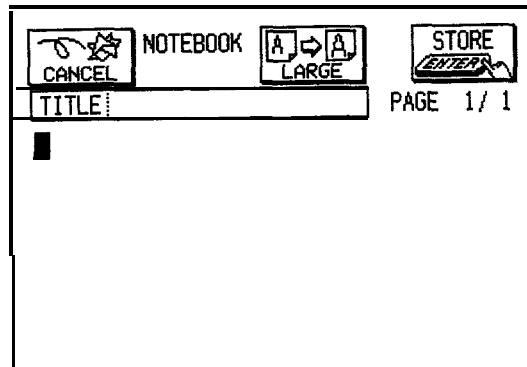

3. Enter the contents. Type the letter above.
It is not necessary to press **[↵]** at the end of each line. The unit will automatically forward the words to the new line which would be split between two lines.

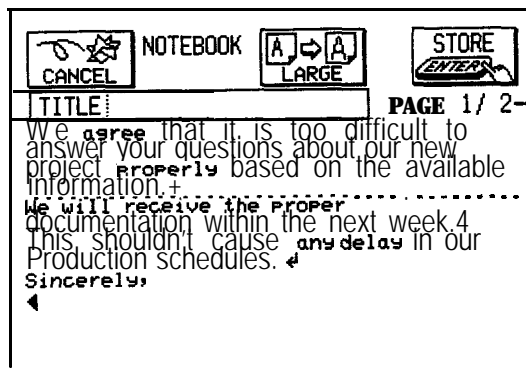

J-Indicates that the text displayed on the first line of the screen is on the first page of a two-page entry.

4. Touch **STORE**.
5. The unit will prompt you for a title. Type in "Letter to Frank".
6. Touch **STORE**.
The entry is now stored.

Making a new entry based on an existing entry

Once you have written this letter to Frank, you may need to write a similar letter to someone else. Rather than having to format another letter, you can instead make a copy of an existing letter and simply change the new person's name and address.

The unit allows you to quickly make a copy of an existing entry which you can begin editing immediately.

1. Select an existing entry
2. Press (2nd) **EDIT** .
3. Make any necessary changes to the entry. You may want to change the title so as not to confuse this entry with the original.
4. Touch **STORE** .

The unit now saves this copy without effecting the original. If you return to the INDEX view you will see both the original entry and this new entry.

Finding entries

Notebook entries are stored alphabetically according to their title. There are three options to find an entry in the application, depending on the situation.

Using the Index mode

1. Go to the Index mode.

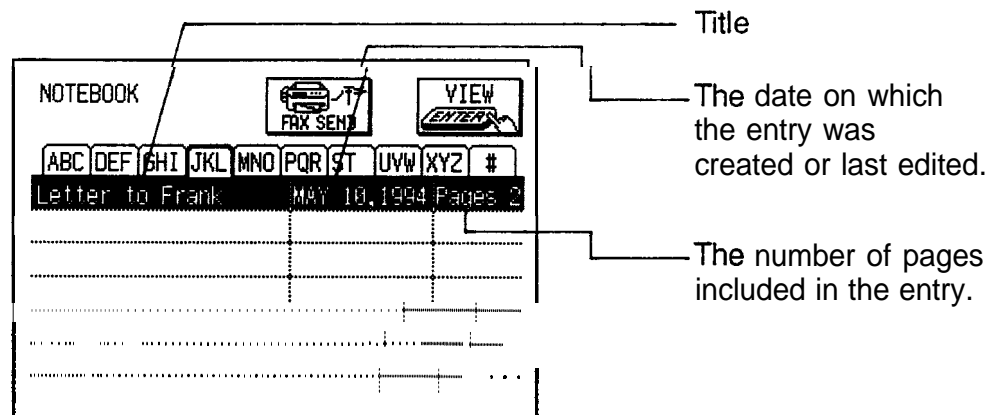

2. Touch the tab of the letter that the title of the entry begins with.

- ★ You can also use **PREV** and **NEXT** .
3. Select the entry, then touch **VIEW** to see it in detail.

- ★ Touch the entry twice.
The full entry is displayed.

If an entry is so long that it cannot all fit on the screen, you can press **PREV** or **NEXT** to move through the entry one display screen at a time, or **▲** or **▼** to scroll one line at a time.

Search by title

1. In the View or Index mode, type in the first few characters of the title of the entry you are looking for.
The GO TO window will open, filled in with the letters you typed.

2. Touch **GO** .
 - If you still do not see the desired entry, press **NEXT** until you do.
 - If you are in the Index mode, select the entry and touch **VIEW** to see it in detail.

- ☞ This does not distinguish between upper- and lower-case letters.

Using keywords

If you cannot remember the exact title of an entry, but you know a word or words that appear somewhere in the entry (including its TITLE field), use the Search function to find the entry.

1. Press **SEARCH**.
The SEARCH window appears.
2. Type in the words you remember in the entry you are looking for.
3. Touch **SEARCH** .
If you still do not see the desired entry, touch **NEXT** to display the following matching entries.

4. Touch **DONE** when you find the entry.

 The Search function does not distinguish between upper- and lower-case letters.

Editing entries

1. Select the entry in the Index mode or display it in the View mode.

2. Press **EDIT**.

The entry opens in the Edit mode.

3. Make any desired changes.

If you are working with a long piece of text that goes off the display, use **▲** or **▼** to scroll up or down line by line, or use **PREV** or **NEXT** to move up or down within the text one display screen at a time.

4. Touch **STORE** when you are finished.

 Touch **CANCEL** at any time before touching **STORE** to discard any changes you have made.

Deleting entries

Deleting single entries

1. Select the entry you want to delete in the Index mode, or display it in the View mode.

2. Press **MENU**, touch **MODIFY**, and select DATA DELETION.

3. Select SELECTED ENTRY.

A warning message appears asking if you are sure you want to delete the entry.

4. Touch **YES** (or **NO** to cancel the deletion).

 You can also delete single entries by pressing **DEL** in step 2 above.

Deleting all entries

1. Press **MENU**, touch **MODIFY**, and select DATA DELETION.

2. Select ALL NOTEBOOK DATA.

A warning message appears asking if you are sure you want to delete all entries in the application.

3. Touch **YES** (or **NO** to cancel the deletion).



It is not possible to delete all entries simultaneously if the unit is locked. See p. 282.

Changing the character size on the display

You may find that there are times when you want to make the characters larger so that they will be easier to read. This is easy to do. To select a large character size, simply touch **LARGE** in the Edit or View mode. The text will be displayed in a large format (40 x 8 characters on the display), and the button will switch to **SMALL**. To return to the regular format (40 x 12 characters), touch **SMALL**.

5

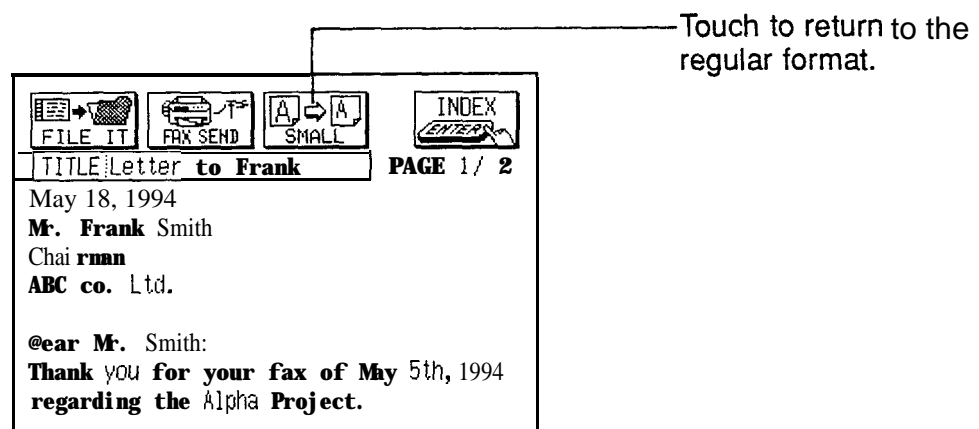

Large character format

In large format, characters exceeding 40 x 8 go off the display. To see them, use the cursor keys.



- While the large character size may be easier to read and to work with when selecting text for copying, for example, using the small size makes it possible to include more text on the display.
- Changing the character size on the display does not affect the size of printed text.

Searching for specific words in the text

When editing or revising an entry in the **Notebook** application, you may want to change or delete only a single word or one string of text in that entry. Or you may simply want to locate a word or text string while viewing an entry. The FIND TEXT feature in the application menu makes it easy to find up to a 20-character string of text (including spaces).

1. In the View or Edit mode, press **MENU** , touch **VIEWS** , and select FIND TEXT



Press **2nd** **F**.

The FIND TEXT window opens.

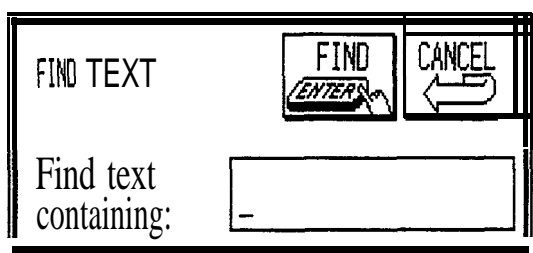

2. Enter the text you want to find.
3. Touch **FIND** .

The window closes and the text search starts from the beginning of the entry. When a match is found, the first matching text in the entry is selected. If you are in the Edit mode, you can delete, cut, copy, paste or edit the text as desired. To continue searching for the same text, repeat steps 1 and 3 above. The unit will begin searching from the location of the last match.

If no matching text is found, a message indicating this is displayed.



No matter where the cursor was in an entry, any new search starts from the beginning of the entry.

Changing character (font) styles

The unit offers you four character (font) styles-plain, underline, italic, and bold-that can be applied to text. Plain is the default style. Underline can also be used in combination with italic and bold. The font styles add

richness to the way your text appears, and can be used, for example, to differentiate titles of books and other works from regular text or to emphasize importance.

The styles are included when you print a document on a printer that is compatible with your unit (consult your printer manual).

1. In the Edit mode, press **MENU** , touch **MODIFY** and select SET FONT STYLE.

A submenu appears. An asterisk indicates the current font style settings.

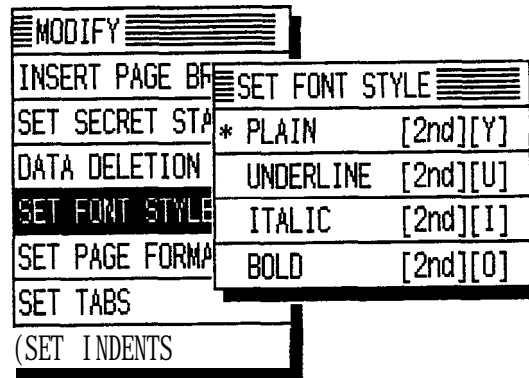

2. Select the style that you want the text you will enter to be in. For example, touch UNDERLINE if you want the text you are going to enter to be underlined.

The menu closes.

3. Type the text you want to enter.

The text appears in the selected style.

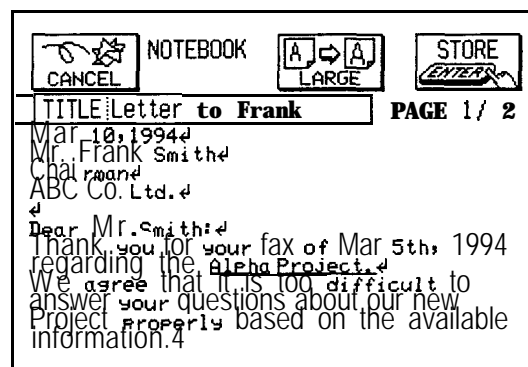

The settings remain in effect until another font style is selected. To change the font style back to plain or to another style, repeat the above procedure, making the appropriate selection.

- ★ You can also use keyboard shortcuts to change the font style, which make it possible to change font styles “on the fly” from the keyboard. The keyboard shortcuts (which are indicated on the SET FONT STYLE submenu) are as follows:

(2nd) **Y** → Plain
(2nd) **U** → Underline
(2nd) **I** → Italic
(2nd) **O** → Bold

- ★ To change the font style of text that has already been entered, select the text in the Edit mode by dragging the pen across it, then choose a font style from the menu, or by using keyboard shortcuts.

- ☞
 - The font style cannot be changed within the TITLE field.
 - The underline setting remains in effect until plain is reselected.Any text inserted into a block takes on the font style of the block of text.

Using indents and tabs

Indents and tabs let you format the appearance of text and blocks of text. The difference between an indent and a tab is that, once entered, an indent setting remains in effect until it is turned off or changed. In other words, if you set an indent, all text entered after that will also be indented. A tab affects a single line only.

Setting indents

Text indenting can be turned on and off, and text can be indented from the left margin and/or right margin, using the application menu. Indent off is the default setting. On your unit, indents are set by specifying the number of characters you want to indent. For example, if you enter 5 as the indent, a line will be indented by five spaces.

You can specify as many indents as you want in an entry. However, it is not possible to change the setting in the middle of a paragraph (which ends with J).

The maximum number of characters you can specify for indents depends on the page format (see p. 153).

1. In the Edit mode, place the cursor on the line where you want to start indenting.
2. Press **MENU** , touch **MODIFY** , and select SET INDENTS.

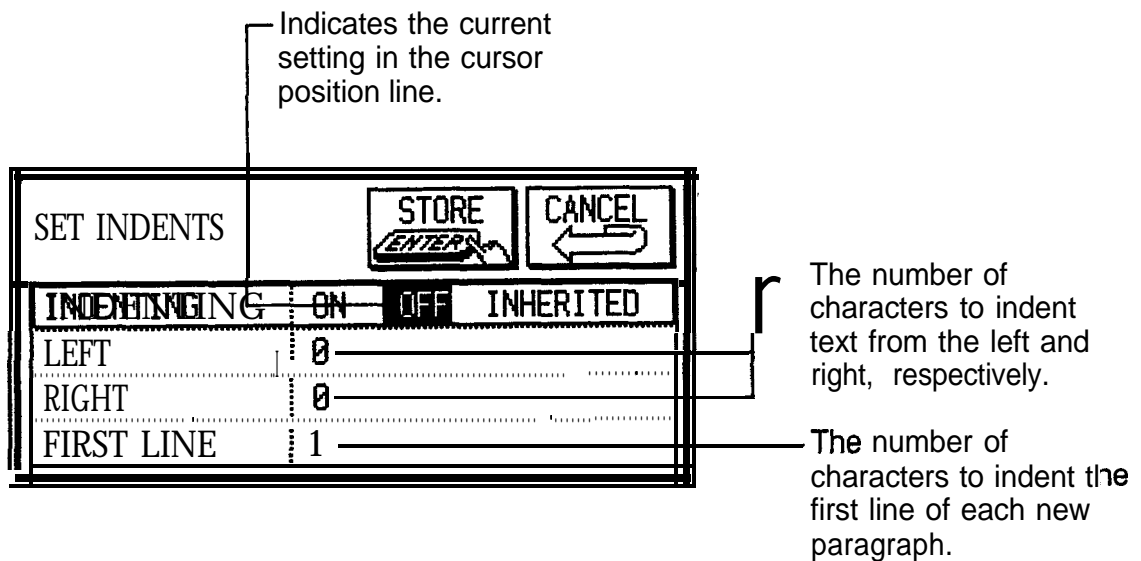

3. Select ON in the INDENTING field.
4. Move to the field you want to set an indent for. Press **DEL** to delete the current value and enter the number of characters you want to indent.
5. Touch **STORE** when you have finished making all the desired settings (or **CANCEL** to cancel the settings).
When indenting is turned on, **1** is shown on the display at the indent position. All current text or text entered after **1** will be indented the specified number of characters from the left or right until indenting is turned off or changed.

- ☞ Turning indenting on automatically sets FIRST LINE to 1, its minimum value. If you have set a LEFT indent, and want to indent the first lines of paragraphs even further than this, note that the indent settings are always counted from the far left margin and so the FIRST LINE setting must be greater than the LEFT indent setting.

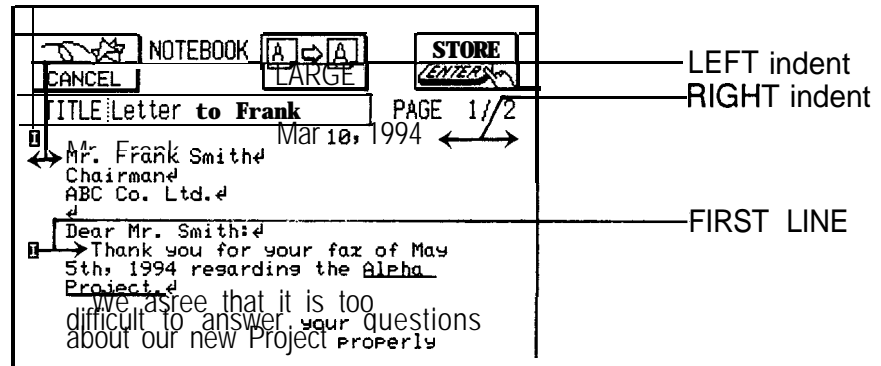

An entry with indents set

Changing or canceling indents

To re-format text for which indents have been set, or to change to a different layout from the one selected at the beginning of the document, follow the procedure below.

1. In the Edit mode, position the cursor where you want the change to take effect.
2. Press (MENU), touch **MODIFY**, and select SET INDENTS.



The SET INDENTS window appears and ON or INHERITED is selected in the INDENTING field.

3. To cancel the indent, select OFF.
To change the indent, select ON and enter the new values in any fields you want.
To cancel an indent and use the setting which has been applied to the text above the paragraph you are working in, select INHERITED.
4. Touch **STORE**.
The text on the line the cursor is on and all text that

follows or is entered subsequently is laid out according to the new setting.



- If the cursor is positioned anywhere within a paragraph, the whole paragraph and all text following it will be laid out according to the new setting. A setting change can only be made starting from a line which is immediately preceded by ↵.
- If you have changed any of the indent settings and attempt to store the new settings without selecting ON in the INDENTING field, the unit will prompt you to recheck the settings.

Tab settings

In the default settings, eight tab positions are specified at intervals of four characters each. Pressing   moves the cursor to the next tab position to the right. In the insertion mode, this shifts any text following the cursor. (This works only in the **Notebook** application.) You can change the default four-character setting for each individual entry using SET TABS in the application menu.

As with indents, the unit for this setting is the number of characters. You can have up to eight tab settings per line.

1. In the Edit mode, press  , touch  , and select SET TABS.

SET TABS		STORE 	CANCEL 
TAB 1	4	TAB 5	20
TAB 2	8	TAB 6	24
TAB 3	12	TAB 7	28
TAB 4	16	TAB 8	32

TAB 1 sets the first tab position, TAB 2 sets the second, etc. Tab position settings are measured by the number of characters from the beginning of the line.

2. Move to the field you want to change and enter the desired number of characters.
3. Touch **STORE** when you have finished making all the desired settings (or **CANCEL** to leave the original settings).

Turning word wrap on and off

Word wrap automatically moves text which will not fit onto the end of a line to a new line, preventing words from being split when you type. The default setting for the unit's word wrap function is on. There may be times, however, when you want to turn off the word wrap function. This can be done for each individual entry.

1. In the Edit mode, press **MENU** , touch **MODIFY** , and select SET PAGE FORMAT.
2. Select OFF in the WORD-WRAPPING field.
3. Touch **STORE** .



To turn word wrap back on for an entry, repeat the procedure and select ON in step 2.

Printing a full-size document

So far you have worked only in the limited space of the unit's display. However, you can make the text fit on a standard letter-size sheet in order to print out full-size documents.

The following sections will discuss page layout and printing. If you will not be printing your **Notebook** entries and are using the **Notebook** only for keeping short notes and memos, you can skip over these sections.



For a full explanation of printing, see p. 222.

Setting the margins

The unit's display is smaller than a standard letter-size sheet (8.5" x 11 "). However, the display can be set up to work like a "floating window" which moves across the page, letting you create full-size documents. For novice users, the default right and bottom page margins in the **Notebook** have been set to make the writing area-the

part of the page text is entered to-the same size as the display.

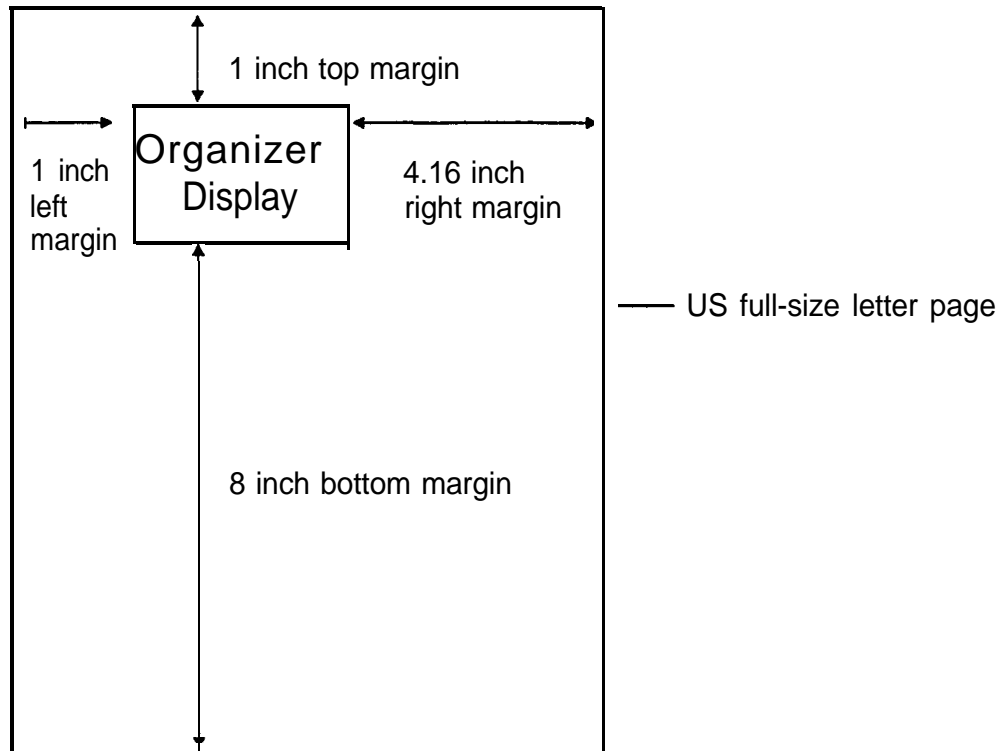

5

Default margin settings

If you want to change the default margins, for example, to print full-size documents, you can do so for individual entries using the application menu.

1. In the Edit mode, press **MENU** , touch **MODIFY** , and select SET PAGE FORMAT.

A window opens showing all of the page format settings.

SET PAGE FORMATS		STORE ENTERS	CANCEL
WORD-WRAPPING	ON	OFF	
PAGE SIZE	A4	LETTER	LEGAL
TOP MARGIN	1		
BOTTOM MARGIN	8		
LEFT MARGIN	1		
RIGHT MARGIN	4.16		
PRINT FONT	PICA	ELITE	PS

2. Move to the margin field you want to change-TOP, BOTTOM, LEFT, or RIGHT-then use **DEL** to delete the current values, and enter the desired ones.
3. Touch **STORE** .
The new page format for the entry is now stored.

With a page format that is larger than the unit's display, the display functions as a floating window and moves around the page. You can type text continuously and the display will automatically shift across the page.

To view text currently off the display in either the View or Edit mode, use the cursor keys. In the View mode, the display moves vertically one line at a time. In the Edit mode, the display shifts in the same way as for typing in text. You can also press **PREV** or **NEXT** to move the display up or down, respectively, one display screen at a time.



The minimum margin setting is 0.5”.

Inserting a page break

The unit automatically inserts a page break at the end of a page (according to the selected page size). A page break is indicated on the display by a dotted line.

However, you can also insert a page break yourself for layout purposes. These page breaks are entered as code in the entry, and are also marked by dotted lines on the display.

1. In the Edit mode, position the cursor at the location where you want to insert a page break.
2. Press **MENU** , touch **MODIFY** , and select INSERT PAGE BREAK.

P is entered at the cursor position, and subsequent text is moved to a new page.



Use **DEL** to delete **□** to cancel a user-created page break.

View page layout

If you are working with a full-size page, and you want to check that text is formatting properly on the page, you can do so using PAGE LAYOUT in the application menu. While this function does not allow you to read the entered text, it does show you the full page at one time.

1. In the View or Edit mode, press **MENU** , touch **VIEWS** , and select PAGE LAYOUT.

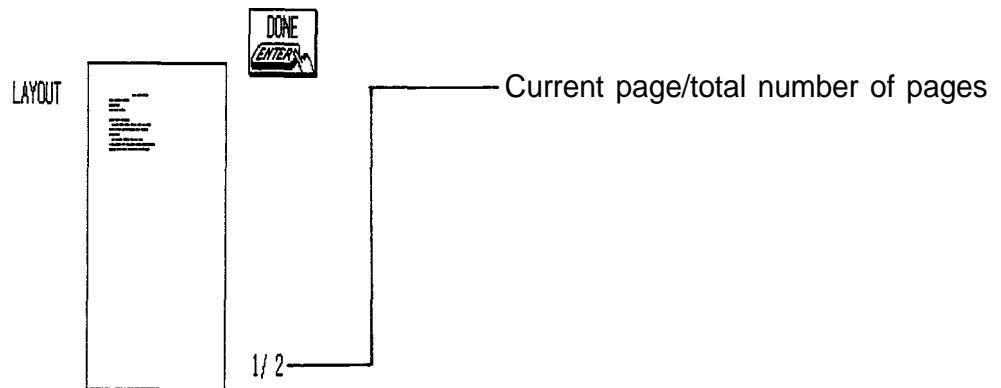

2. If you are working with a document several pages long, you can view different pages by pressing **PREV** (NEXT).
3. Touch **DONE** to return to the normal display.

Selecting the paper size and font type for printing

When you have an entry that you want to print, you need to select the size of paper and the font that you want to use to print the entry (on a printer connected to the unit). These selections are made through the **Notebook** application menu.

1. In the Edit mode, press **MENU** , touch **MODIFY** , and select SET PAGE FORMATS.

SET PAGE FORMATS		STORE ENTER	CANCEL
WORD-WRAPPING	<input checked="" type="checkbox"/>	OFF	
PAGE SIZE	A4	LETTER	LEGAL
TOP MARGIN	1		
BOTTOM MARGIN	8		
LEFT MARGIN	1		
RIGHT MARGIN	4.16		
PRINT FONT	PICA	ELITE	PS

2. Move to the PAGE SIZE field and select the size that corresponds to the size of the paper you will be using in your printer.

The three page sizes available are Letter (8.5 x 11 in.), A4 (210 x 297 mm), and Legal (8.5 x 14 in.).

3. Move to the PRINT FONT field and select the font that you want.

ELITE is a well-known font, which is set at 12 cpi (characters per inch).

PICA is also a common font, set at 10 cpi.

PS is proportional spacing (spacing between letters is adjusted depending on the letter's width), set at 12 cpi.

You will be able to fit more text on a printed page using a 12 cpi font than using a 10 cpi font.

4. Touch **STORE** (or press **CANCEL** to cancel the settings).



- Selecting a paper size that your printer is not set up for may delay or prevent printing. Consult your printer manual regarding printer set-up.
- The selected font is not shown on the unit's display, but only when printed out. However, you can check the layout when ELITE or PICA is selected using PAGE LAYOUT in the application menu. See p. 155. When PS is selected, the text is displayed on the unit in the same format as for ELITE.

The Notebook application menus

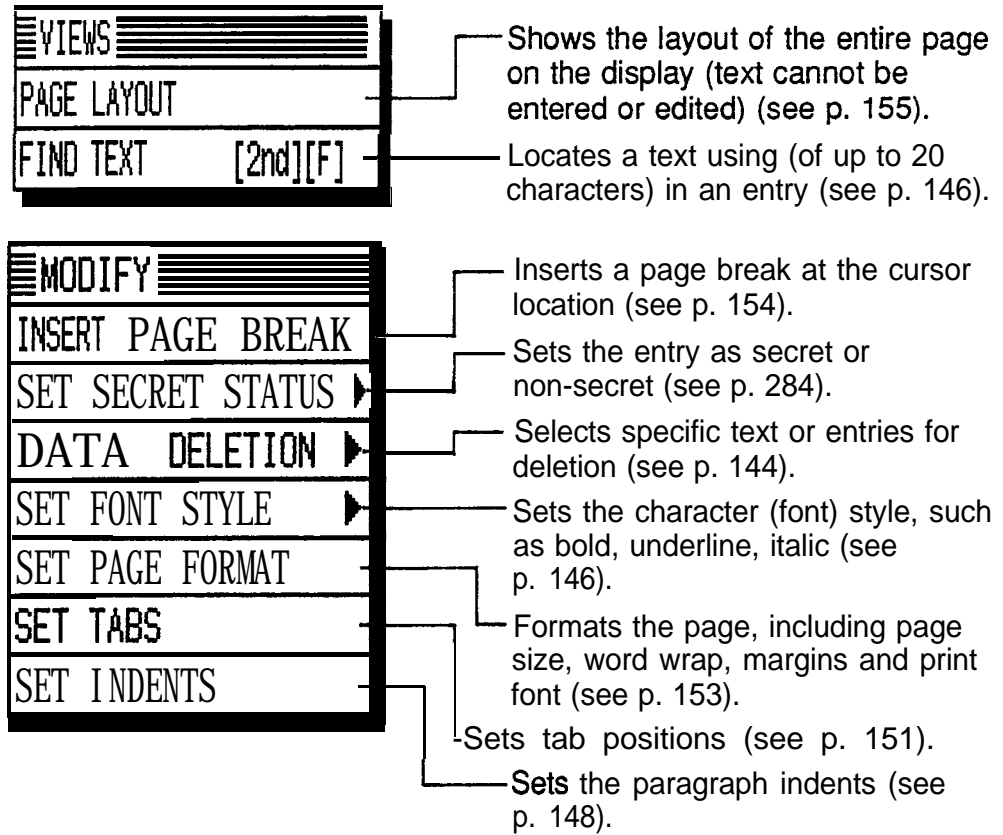

5

The Outline Application

The unit's **Outline** application is a simple, convenient tool to help you order information or key points of your thoughts and writings in a clear, easy-to-understand hierarchical structure. This is ideal for organizing your plans and ideas, and the application's features provide the flexibility to restructure the order whenever necessary.

The outline structure consists of a title and one or more topics, which can have one or more subtopics. These topics can be rearranged, grouped together, or even hidden from view, so that you can manage a lot of information easily and efficiently.

Each topic in an outline is much like an entry in the other applications, and the outline itself can be thought of as a file holding all of those topics (or entries). But in an outline, you can enter, edit, or delete topics while maintaining an overview of the entire outline and its topics.

Creating an outline

Below is an example of how a price list might look in the **Outline** application in full view mode.

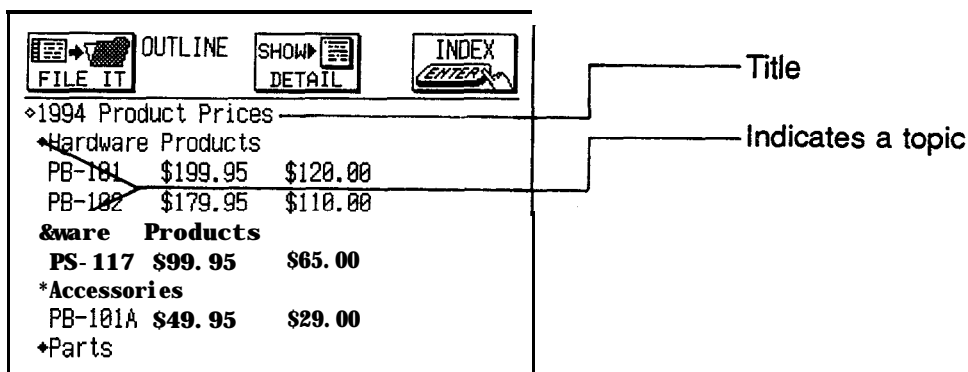

Each individual topic heading is marked with a diamond. Up to 20 characters can be used as the title of an outline, and each single topic can contain up to 2,048 characters.

Enter the outline above.

1. Press (OUTLINE) to open the application.

2. Press (**NEW**).

A title window appears.



3. Type in the title.

4. Touch (STORE).

The View mode opens with the title as the first topic in the new outline. A flashing diamond prompts you to enter a topic.

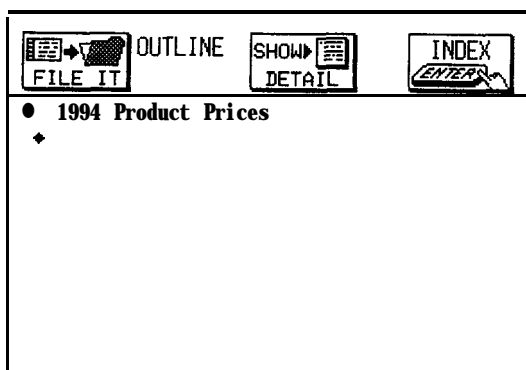

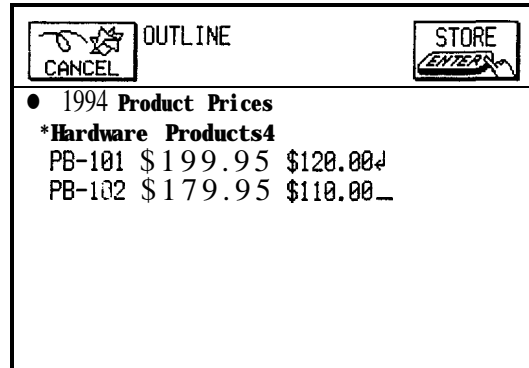

5. Type the first subtopic, pressing  at the end of each line.

When you begin typing, the display automatically switches to the Edit mode.



5

6. Touch .





Alternatively, you can press  to discard the text you have entered. This will not cancel the entire outline but only the topic that is about to be stored.

The View mode appears again, and the second and subsequent lines of the topic just entered disappear from view. This feature allows you to store a lot of information on one page but only see the first line (heading) of each topic. You can then selectively view the details of a particular topic when needed.

7. Enter the other topics in the list above. Be sure to touch  after entering each one.

You can see that there is no final command to store the outline. You can exit one outline at any time by displaying another entry, changing to the Index mode, or creating a new outline by pressing (NEW).



- If you want to view the entire contents of a particular topic, touch the topic, then  (or press ). Touch  (or press ) to return to the regular display.
- By editing, text first entered as the title can be extended to up to 2048 characters.

Finding outlines

Outlines are stored in alphabetical order according to their titles.

Using the Index mode

1. Go to the Index mode.
 2. Touch a tab to display the entries stored there alphabetically.
 3. Select the desired entry and touch **VIEW** to see it in detail.
- ★ Touch the desired outline twice.

Search by title

1. In the Index mode, type in the first few characters of the title of the entry you are looking for.
The GO TO window will open, filled in with the letters you typed.
 2. Touch **GO**.
If you still do not see the desired entry, press **NEXT** until you do.
 3. Select the entry and touch **VIEW** to see it in detail.
- 👉 Go To search does not distinguish between upper- and lower-case letters.

Using keywords

If you know a word or words that appear in an entry though you cannot remember the exact title, then use the Search function to find the entry.

1. Press **SEARCH**.
The SEARCH window appears.
2. Type in any word you remember in the entry you are looking for.
3. Touch **SEARCH**.
If you still do not see the desired entry, touch **NEXT** to display the following matching entries.

4. Touch **DONE** when you find the entry you want.

 The Search function does not distinguish between upper- and lower-case letters.

Displaying full topics

In the default settings, the **Outline** is set to display only the first line of each topic. You can change this to display an outline in full.

1. Display the outline you want to work with in the View mode.
2. Press **MENU**, touch **VIEWS**, and select 1 LINE/FULL VIEW.

A submenu appears. An asterisk indicates the current selection.

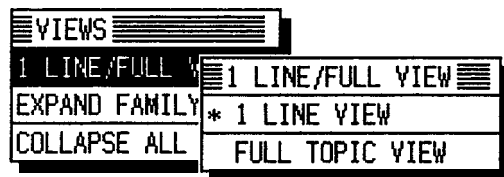

3. Select FULL TOPIC VIEW.

All second and subsequent lines of all the topics appear.

To return to the one-line view, follow the above procedure, but select 1 LINE TOPIC VIEW in step 3.

To see contents that are off the display, scroll the display using **PREV** and **NEXT** or the cursor keys.





 Changing the view mode in an outline does not affect the view mode setting of other outlines. However, a new entry adopts the same view mode as the entry that was last displayed.

Revising outlines

Once an outline has been created, it is easy to revise either the text in the outline or the outline structure itself. The text of topics and subtopics can be revised one at a time in the Edit mode. Restructuring outlines is carried out in the View mode.

Selecting topics

Simply touch anywhere on a topic to select it. The flashing diamond indicates the currently selected topic. You can also move between topics one by one, using the cursor keys.



Press   to move directly to the last topic and   to move directly to the first topic, i.e. the title.



Editing text

Only one topic can be edited at a time.

1. Display the outline you want to revise in the View mode.
2. Select the topic you want to edit.
3. Press .

The cursor is positioned at the beginning of the text. (When in one-line view mode, the hidden lines of the topic appear.)

4. Make any necessary changes.
5. Touch  (or  to discard the changes).
The new, edited topic is now stored.

 In the **Outline** application, pressing  in the Index mode does not open the Edit mode.



Adding topics



As your plans and ideas grow, you may want to add topics to an existing outline. To add a topic at the end of an outline, display the outline in the View mode, and then press  until you pass the last topic. Begin typing when the new diamond appears.

To insert a new topic anywhere else in the outline, use the procedure below. Only one new topic can be inserted at a time.

1. Display the outline that you want to add a topic to in the View mode.
2. Press (INS).

I is displayed to indicate the insertion position.

3. Move **I** to the desired location using  and .
4. Type in the new topic.
5. Touch .







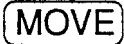

Press  at any time before touching  to cancel the insertion.

- ★ You can also add a topic between existing topics by first selecting the topic after which you want to insert the new topic, then simply starting to type the new topic.

5

Moving topics

Even after you have stored a topic, you can change its location easily.

1. In the View mode, select the topic you want to move.
 2. Press  (the second row from the top on the keyboard).
The entire topic is momentarily highlighted, then replaced by .
 3. Move  to the new location using  and .
 4. Press .
-  reverts back to the full contents of the topic.
- Press  at any time before pressing  to cancel the move.

-  Topics cannot be moved to a position above the title.

Joining two topics into one

You can join (merge) any two consecutive topics into one using the application menu. A selected topic is joined to the topic above it.

1. In the View mode, select the topic you want to join to the one above it.

If the entry is in the one-line view mode, select full view mode (see p. 168) to display all the hidden parts of the outline.

2. Press **MENU** , touch **MODIFY** , and select JOIN/SPLIT TOPIC.

A submenu appears

3. Select JOIN 2 TOPICS.

The topic you selected is joined with the one above it.

FILE IT	OUTLINE	SHOW DETAIL	INDEX ENTER
◊1994 Product Prices			
♦Hardware Products			
PB-101	\$199.95	\$120.00	
PB-102	\$179.95	\$110.00	
♦Software Products			
PS-117	\$99.95	\$65.00	
*Accessories			
PB-101A	\$49.95	\$29.00	Parts
PB-1BB	\$99.95	\$65.00	

Beginning of topic selected for joining.

Because no space is inserted between the two topics when they are joined, you may want to open the new, joined topic in the Edit mode and make any desired changes, for example adding a space, "and," etc.



If you attempt to join two topics which, when joined, will exceed the limit of 2,048 characters, the operation will be automatically canceled and nothing will happen.

Splitting one topic into two

Any single topic can be easily divided (split) into two.

1. In the View mode, select the topic you want to split.
2. Press **MENU** , touch **MODIFY** , and select JOIN/SPLIT TOPIC.

A submenu appears.

3. Select SPLIT 1 TOPIC INTO 2.

The selected topic is displayed with the cursor positioned on the first character.

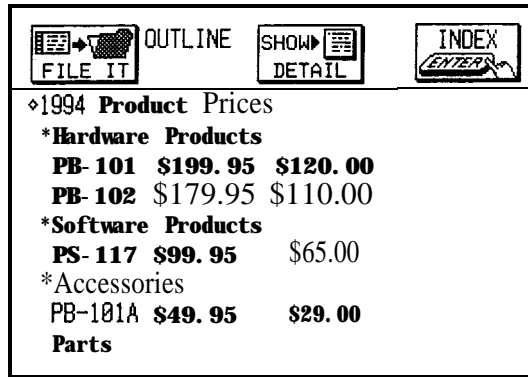

4. Move the cursor to the point where you want to split the topic (on the last character of the first topic).

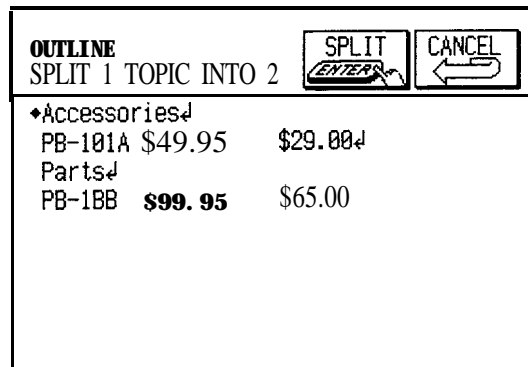

5. Press **ENTER**.

The part of the topic following the cursor position becomes a new topic.



If a topic that contains subtopics (see p. 167) is split, the subtopics are assigned to the second, new topic.

Outline Deletion

1. In the View display mode, select the topic you want to delete.

2. Press **MENU**, touch **MODIFY**, and select DATA DELETION.

A submenu appears.

3. Select SELECTED FAMILY.

The selected topic is highlighted, and a warning message appears asking if you are sure you want to delete it.

4. Touch **YES** (or **NO** to cancel the deletion).

★ You can also delete a selected topic (family) by pressing **DEL** in step 2 above.

☞ If you select a topic for deletion, all the subtopics (see p. 167) below it will also be deleted. You may want to rearrange an outline beforehand to prevent this (see p. 169).

Deleting an outline

1. Select the outline you want to delete in the Index mode or display it in the View mode.

2. Press **MENU**, touch **MODIFY**, and select DATA DELETION.

A submenu appears.

3. Select **SELECTED OUTLINE**.

A warning message appears asking if you are sure you want to delete the outline.

4. Touch **YES** (or **NO** to cancel the deletion).

★ You can also delete an outline by pressing **DEL** in step 2 above. To do this in the View mode, the title must be selected.

Deleting all outlines

1. In the Index or View mode press **MENU**, touch **MODIFY**, and select DATA DELETION.

A submenu appears.

2. Select **ALL OUTLINES**.

A warning message appears asking if you are sure you want to delete all outlines in the application.

3. Touch **YES** (or **NO** to cancel the deletion).

☞ It is not possible to delete all outlines simultaneously if the unit is locked. See p. 282.

Using subtopics (children)

The examples used so far have only contained one level of topics (excluding the title, which is always on the first level by itself). This simple outline form may be all you need to organize your information. You can, however, create subtopics for greater flexibility. Each subtopic belongs to the particular topic that is on the next level above it. A subtopic can, in turn, have its own subtopics: these can continue for 15 levels below the title. Subtopics are often referred to as “children,” the topic they belong to as the “parent,” and parents and children together as a “family.” The example below shows an outline illustrating these points.

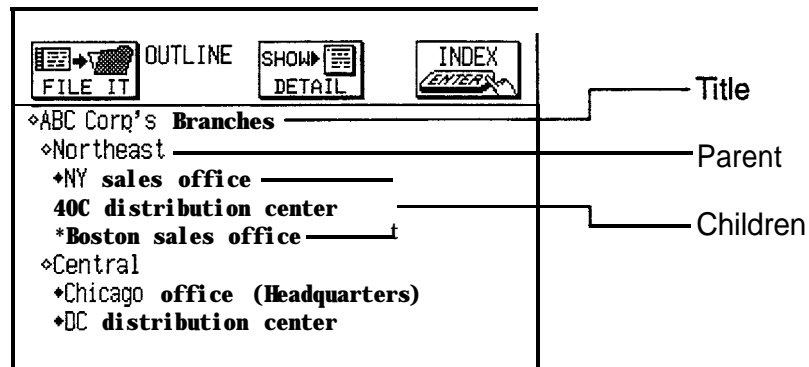

The hollow diamond indicates that the topic is a parent (has subtopics) while a solid diamond indicates that the topic has no children. This is useful because a topic's children may be hidden from view.

You can create a subtopic by pressing I,) before creating or when moving a topic. It will then become a subtopic of the topic directly above it. If you later find it necessary to reorganize an outline, you can promote a subtopic to the same level as its parent topic using

MOVE and **◀**.

Entering subtopics

Create the example above.

1. Press (OUTLINE) to open the application.
2. Press (NEW) and type in a title for the outline, then

touch **STORE** .

3. Type in the first topic, then touch **STORE** .

4. Press  to make the second topic a child (subtopic) of "Northeast".

★ Touch the area to the right of  .
The cursor is now indented one character.

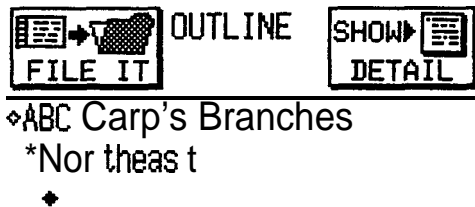

5. Now type in the text of the topic, and touch **STORE** when done.

6. Continue entering the outline until you get to "Central".

7. Press  to place the new topic "Central" on the same level as "Northeast".

★ Touch the area to the left of  .

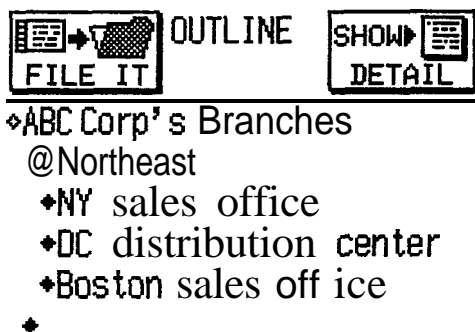

8. Continue and complete the outline in this manner.

Collapsing families

As an outline grows in size and depth, you may find it

difficult to manage. The collapse function allows you to condense the view and later expand only those topics and families that you need to see. It hides all subtopics from view, displaying only first-level topics and the title.

1. Display the outline in the View mode.
2. Press **MENU** , touch **VIEWS** , and select COLLAPSE ALL.

All subtopics are collapsed into their topics and eliminated from the display.

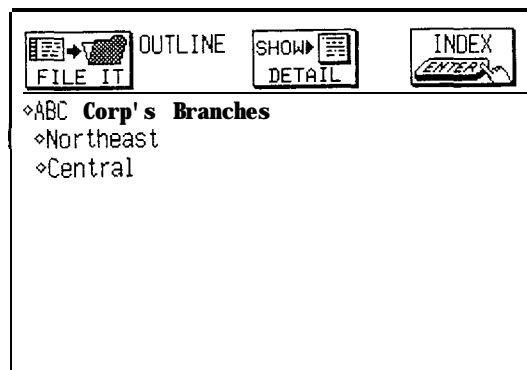

- ★ If you want to collapse only one specific family, select its parent topic and then press **EXP/COL** or touch ◊ for the topic. All subtopics belonging to that topic will be hidden from view.

Expanding families

All subtopics that have been collapsed in a family or in the entire outline can be expanded.



1. Display the collapsed outline in the View mode.
2. Select the topic you want to expand, or the title if you want to expand the entire outline.
3. Press **MENU** , touch **VIEWS** , and select EXPAND FAMILY.

All subtopics of the selected topic are displayed to the furthest level beneath the topic.

- ★ You can also expand a family to display only the next-level subtopics below the parent topic. Select the topic whose next-level subtopics you want to see and press **EXP/COL** or touch 0 for the topic.

Restructuring families

You can move, delete, join and divide families just as you can topics. You can also use  to move directly from a selected topic to its parent. However, these operations will affect the entire family regardless of whether or not the topic is collapsed and its subtopics are visible. So you have to proceed with caution. The following restrictions apply when working with families.

- You may not be able to change the level of a collapsed family in certain situations. No other topics may be moved into a family unless the family is expanded. In general, if you are having problems with moving, expand all of the families (see above) and then try the desired move again.
- You cannot insert a topic between a parent and its child at the same level as a parent. For example, pressing  in the situation below would not move the flashing  to the left.



```

♦ABC Corp's Branches
  *Northeast
    |
    *NY sales office
    ♦DC distribution center
    ♦Boston sales office
  ♦Central
    *Chicago off ice (Headquarters )
    *DC distribution center
  
```

- When moving topics (or families):
 - a. You cannot indent a topic more than one character to the right of the topic directly above it.
 - b. You cannot indent a topic directly below a collapsed family. You first have to expand the family.

- c. You cannot move a topic one character to the left if this action would split up a parent and child. Move the selected topic to another location and then promote it.
- If you divide a topic that has subtopics (children), the second half of the divided topic will become the parent of these subtopics. The two parts of the original topic remain on the same level.
- You should not attempt to join a topic with a collapsed topic above it. If you do, the unit will ask for confirmation. If you continue, it will combine the topic with the last topic in the preceding topic's family. It is better to first expand the collapsed topic's family in order to see what you are combining with.

The Outline application menus

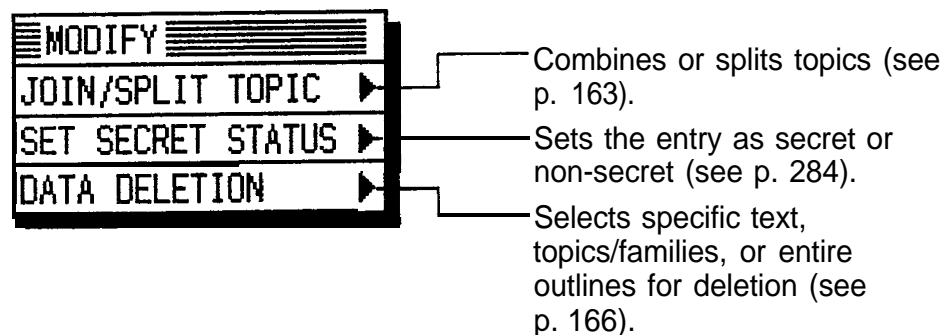
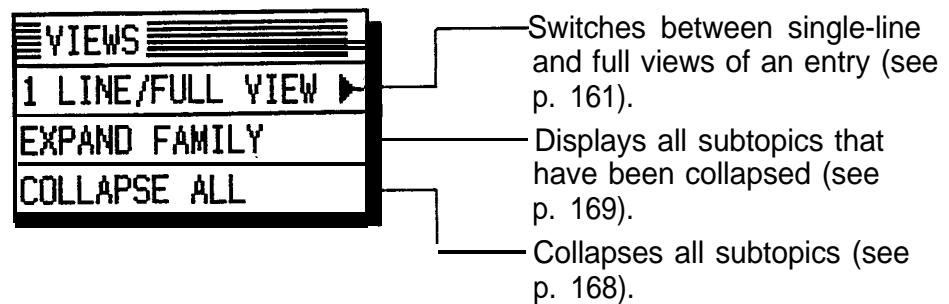



6

Desk Accessories

6

The “desk accessories” are valuable utilities for everyday use. The **Calc** (Calculator) can perform on-the-fly calculations on numbers entered from the display or copied from other applications. The **Clock** can simultaneously display the day, date, and time in two cities of your choice. And with the **Scrapbook** application, you can make a drawing directly on the display, copy that drawing to another application, or even send it by fax directly from the IQ-8900/IQ-8920. This chapter provides all the information you need to use the features in each of these applications.

The Calc (Calculator) Application

The unit has a 10-digit calculator which performs mathematical operations, including square root and percentage calculation, and can also calculate duration of time based on a date, such as the number of days you have to complete a project. In addition, it has a paperless printer feature, which displays all calculations in a vertical column on the display.

There are three different displays in the **Calc** application, and the application opens with the display that was last used.

Performing calculations

1. Press **CALC** to open the application window.

The calculator's key pad appears on the display.

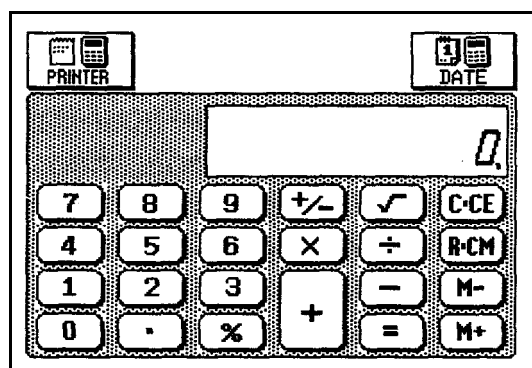

2. Enter the calculation by touching the key pad.

- ★ You can also use the numeric and mathematical symbol keys on the keyboard.

To quit the **Calc** application, press any other application key.

- ☞ To clear an entered value, touch **C·CE** once, and to clear a calculator operation, touch **C·CE** twice.
- Calculations are performed in the order of entry, not according to algebraic convention, i.e., $8 + 2 \times 3 = (8 + 2) \times 3$, not $8 + (2 \times 3)$.
- on the display indicates that a number is stored in memory. Touch **R·CM** twice to clear the memory.

- Press to erase the last digit typed.
- E on the display indicates an error. Touch to clear the error.
- Touch to change the sign of a displayed value.
- To perform a square root calculation using the keyboard, press (on the bottom row).

→ For other calculation operations, see p. 181.

The paperless printer

In the basic calculator mode, only the results of a calculation are displayed. Using the paperless printer, you can retain the steps in a calculation and later edit that calculation. This allows you to change numbers and operators (+, -, x, ÷, =) and back up intermediate results within a calculation so that you do not later have to reenter the entire calculation.

, , and terminate a calculation sequence, and a value entered following any of these keys begins a new calculation. Using the paperless printer, a calculation sequence is retained and can be recalled with even after the display has been cleared with until a new one is entered, or all steps are deleted using .

Up to 50 steps have been be stored for a calculation. (Power calculations must be carried out using multiple multiplication. Otherwise, the functions are the same as those for the basic calculator mode.)

Performing calculations

1. Press to open the application.
2. Touch . Enter the calculation.

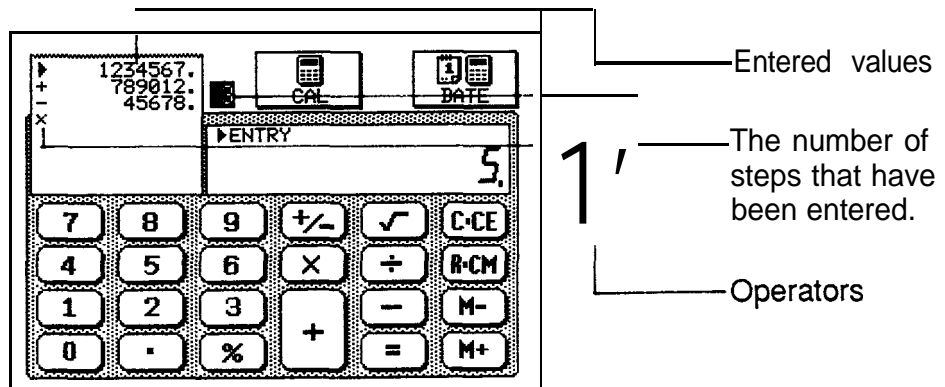

► marks the starting entry. The value on the display of the key pad is the value you have just entered or final result of the calculation, as indicated by ENTRY or ANSWER, respectively, shown above the value.

3. Touch [=] to get the result.

Checking intermediate results

1. Press [PREV] until you reach the line of the calculation you want to check.

The total up to and including the highlighted line is displayed.

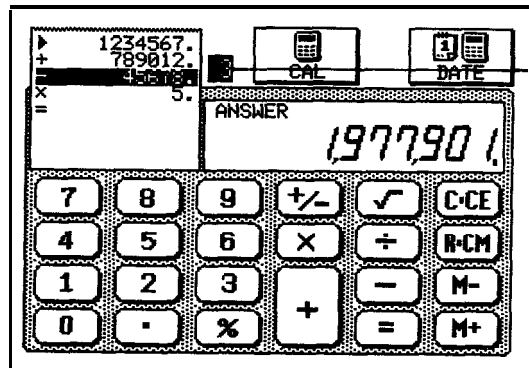

1 -Indicates the current step.

2. Touch [C·CE] once to return to the display of the final result, and again to clear the display.

Inserting figures

1. Move to the line before which you want to insert the new value.

2. Press [INS].

INSERT MODE briefly appears on the key pad's display.

3. Enter the operator and the value to be inserted then press [ENTER].

The value is now included in the calculation.

4. Press [ENTER] again to get the total.

Once the total has been calculated the insert mode automatically changes to the normal entry mode. To return to the entry mode while editing a calculation, press [INS] again.

Changing part of a calculation

1. Move to the line you want to change using **PREV** .
2. Enter the new operator and value then press **ENTER** .
3. Press **ENTER** again to get the new answer.

Deleting a line

1. Move to the line you want to delete using **PREV** .
2. Press **DEL** .
3. Press **ENTER** to get the new total.

Date calculation

Using the **Calc** application, you can calculate the period of time (in days) between two specific dates, and also determine what the date will be a certain number of days before or after a specific date.

Calculating the number of days between two dates

1. Touch **DATE** to call the date calculator.

The current date is the default starting date.

If you want the calculation to start from the current date, skip step 2 below.

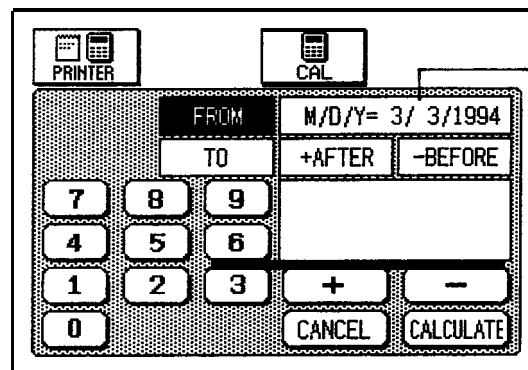

2. Touch **CANCEL** to clear the starting date field and enter the desired starting date. Prefix a single-digit month or date with a 0.

★ You can also modify a specific part of a date by touching it, then entering the desired numbers.

3. Touch **TO** .

4. Enter the ending date.
5. Touch **CALCULATE** .

The number of days between the two dates is shown.

- ☞ • if you make a mistake, touch **CANCEL** to return to a previous step.
- If you enter an invalid date or other value, for example if you forget to enter the year, the operation will not be recognized and nothing will happen when you touch **CALCULATE** .

Calculating a date by specifying a number of days

1. Touch **DATE** to call the date calculator.

The current date is the default starting date. If you want to calculate a date from the current date, skip the next step.

2. Touch **CANCEL** to clear the starting date field and enter the desired starting date. Prefix a single-digit month or date with a 0.

- ★ You can also modify a specific part of a date by touching it, then entering the desired numbers.

3. Touch **AFTER** to obtain a date in the future, or **BEFORE** for a date in the past.

- ★ Touch **+** or **-** , respectively.

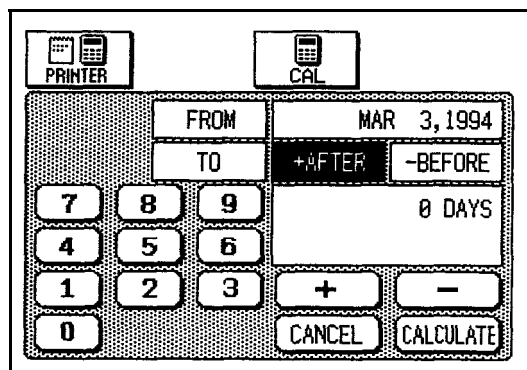

4. Enter the number of days to base your calculation on.
5. Touch **CALCULATE** .

The date is displayed.

- ★ You can continue to calculate dates in the future or past using the calculated date as a new starting date; after a date is calculated, touch **[+]** or **[-]**, respectively. The calculated date is automatically entered in the FROM field. Proceed from step 4 above.
- ☞ If you make a mistake, touch **[CANCEL]** to return to a previous step.

Using the Calculator with other applications

You can perform calculations that are written out in an entry of any application using the **Calc** application. You can also transfer calculated values into an entry.

From an entry to Calc

1. Press the application key for the entry with the data you want to calculate.
2. Highlight the calculation you want to perform.

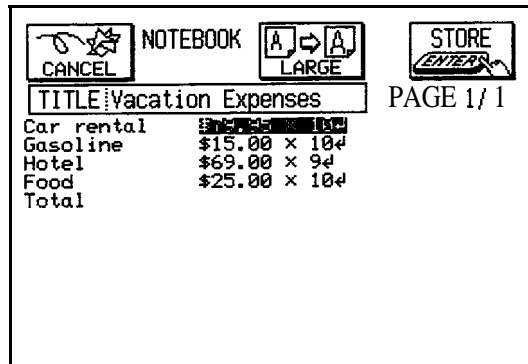

3. Press **(2nd) [COPY]**.
4. Press **[CALC]** to open the **Calc** application and press **(2nd) [PASTE]**.

The copied calculation is performed automatically, and the result is displayed.

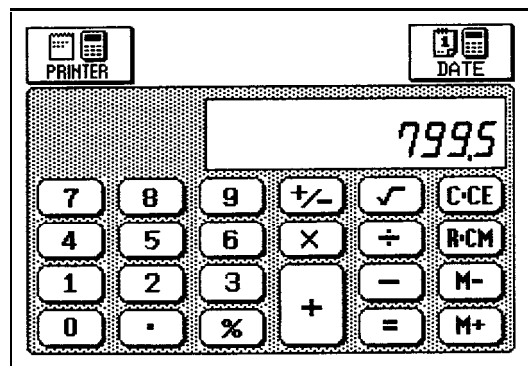

From Calc to entry

1. After a calculation, touch the value displayed in the **Calc** window to highlight it, and press (2nd) **(COPY)** .
2. Open an entry in the Edit mode of an application and touch the position where you want to enter the calculated figure.
3. Press (2nd) **(PASTE)**.
Now the copied value is included in the entry.

When E appears

When any of the following situations occur? the error indicator E appears. Touch **(C·CE)** to clear the error.

- The integer part of the calculation result is within the range of 11 to 20 digits (a rough calculation is obtained).

Example: 4567890123 **(×)** 456 **(=)**

“208.2957896” is displayed with E, which indicates that

$208.2957896 \times 10^{10} = 2,082,957,896,000$
is the rough result.

In the paperless printer mode, no rough calculation can be obtained.

- The integer part of the calculation result exceeds 20 digits.
- The integer part of the numerical value in the memory exceeds 10 digits.
- A number is divided by 0.

Calculation examples

Calculation	Example	Operation	Display (answer)
Arithmetic	$12 \times 3 + 5 =$ $(-24) \div 4 - 2 =$	$12 \boxed{\times} 3 \boxed{+} 5 \boxed{=}$ $24 \boxed{+/-} \boxed{\div} 4 \boxed{/} 2 \boxed{=}$	41. -8.
Constant	$34 + 57 =$ $45 + 57 =$ $68 \times 25 =$ $68 \times 40 =$	$34 \boxed{+} 57 \boxed{=}$ The addend $45 \boxed{=}$ becomes a constant. (Subtraction and division are performed in the same manner.) $68 \boxed{\times} 25 \boxed{=}$ The multiplicand $40 \boxed{=}$ becomes a constant.	91. 102. 1,700. 2,720.
Percent	What is 10% of 200? What percentage is 9 of 36?	$200 \boxed{\times} 10 \boxed{\%}$ $9 \boxed{\div} 36 \boxed{\%}$	20. 25.
Add-on	What results from a 10% increase of 200?	$200 \boxed{+} 10 \boxed{\%}$ (or $200 \boxed{\times} 10 \boxed{\%} \boxed{+} \boxed{=}$)	220.
Discount	What is 500 after a 20% discount?	$500 \boxed{-} 20 \boxed{\%}$ (or $500 \boxed{\times} 20 \boxed{\%} \boxed{-} \boxed{=}$)	400.
Square root	$\sqrt{25 - 9} =$	$25 \boxed{-} 9 \boxed{=} \boxed{/} \boxed{\sqrt{\quad}}$	4.
Power	$(4^3)^2 =$	$4 \boxed{\times} \boxed{=} \boxed{=} \boxed{\times} \boxed{=}$	4,096.
Reciprocal	$1/8 =$	$8 \boxed{\div} 1 \boxed{=} \boxed{/}$	0.125
Memory	Summation $25 \times 5 =$ $-) 84 \div 3 =$ $+) 68 + 17 =$ (Total) = Temporary memory $(14 - 3 \times 2) \times$ $(52 - 35) =$	Clear the memory before performing any calculations. $\boxed{R\cdot CM} \boxed{R\cdot CM}$ $25 \boxed{5} \boxed{M+}$ $84 \boxed{\div} 3 \boxed{M-}$ $68 \boxed{+} 17 \boxed{M+}$ $\boxed{R\cdot CM}$ $\boxed{R\cdot CM} \boxed{R\cdot CM}$ $14 \boxed{M+} 3 \boxed{\times} 2 \boxed{M-}$ $52 \boxed{-} 35 \boxed{\times} \boxed{R\cdot CM} \boxed{=}$	125. M 28. M 85. M 182. M 6. M 136. M

The Clock Application

The unit's built-in clock makes it possible not only to know the correct time in your area, but also to know the time in other cities or any region around the world. The **Clock** is used as the reference time by the **Calendar**, **Schedule**, and **To Do** applications. In addition to these features, daylight saving time (DST) can be enabled for any city you designate.

To view the **Clock**, simply press and hold **CLOCK**.

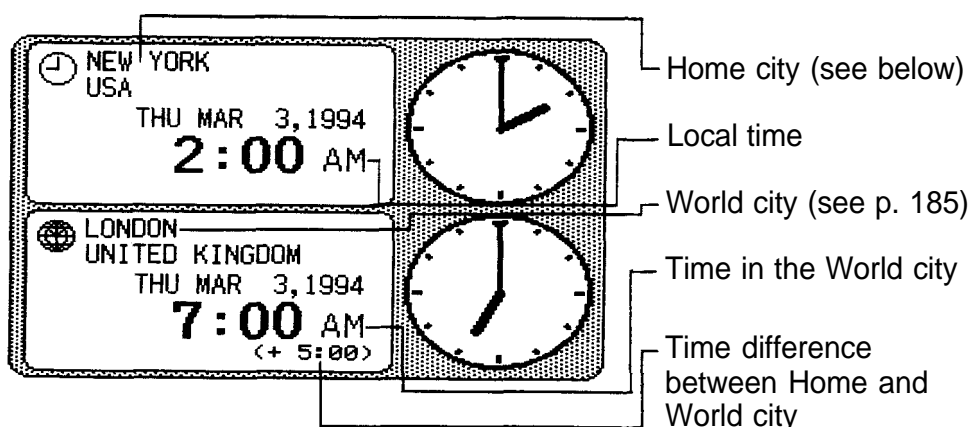

Changing the Home city

The Home city is the city selected for the local time. New York City is the default Home city. To change this setting:

1. Press **MENU** and touch **TOOLS** to open the **TOOLS** menu.
2. Select SET CLOCK.
3. Select CHANGE HOME CITY.

A list of cities appears. The currently selected city is at the top of the list. The cities are listed in alphabetical order by country and then by city name.

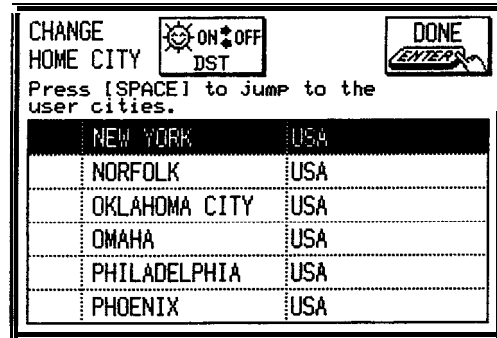

4. Type the first letter of the name of the country where the city you want to select is located. (For example, if you wanted to select San Francisco, you would type U for United States.) Then use **PREV** and **NEXT** to display the city you want.
 5. Touch the desired city.
 - ★ Use **▲** and **▼** to select a city.
 6. If daylight saving time is currently in effect for the selected city, touch **DST ON ◀▶ OFF** to specify this. This advances the Home time by one hour. ☀ appears beside the city, indicating that daylight saving time has been set.
 7. Touch **DONE**.
The **Clock** window appears briefly, indicating the new Home city. The time is automatically adjusted.
- ☞ • If you have set a User city and want to select it as the Home city, press **(SPACE)** to access it (see p. 186).
 - Certain countries will be abbreviated on the display as follows:

Federal Republic of Germany	GERMANY, F.R.
Papua New Guinea	PAPUA N.GUINEA
Republic of Trinidad and Tobago	TRINID. & TOB.
United Arab Emirates	U.A. EMIRATES
United States of America	USA
 - Country and city names in the list and the time differences used to adjust the clock are as of January 1992

Setting the time and date

1. Press **MENU** and touch **TOOLS** to open the **TOOLS** menu.

2. Select SET CLOCK.

3. Select ADJUST TIME/DATE.

The TIME/DATE window opens.

ADJUST TIME/DATE	CITIES	STORE	CANCEL
NEW YORK USA			
HOME TIME	2:00AM		
TIME SYSTEM	24		
HOME DATE	M/D/Y = 3/ 3/1994		

The window has three fields-Home Time, Time System, and Home Date.

4. Enter the current time and press **AM** or **PM** . Enter a 0 before a single-digit hour or minute entry.

5. Move to the TIME SYSTEM field. Press **12** or **24** to select whether you want the time shown in 12- or 24-hour format.

★ Touch the desired setting.

6. Move to the HOME DATE field. Enter the current month and day in two digits, and the year in four digits. You can set any date from January 1st, 1901 to December 31 st, 2099.

7. Touch **STORE** (or **CANCEL** to cancel the changes). The time and date are now stored.

- ☞
- You can access the CHANGE HOME CITY window from this window by touching **CITIES** . Because the unit automatically adjusts the time after the Home city is changed, it is recommended that the Home city be selected before setting the time and date.
 - Changing the setting in the TIME SYSTEM field also changes the time display format for all time related applications and functions, such as **Schedule** and time stamp.

Checking the time in a city

You can find out the time anywhere in the world using the **Clock** application, based on the difference between the time in the Home city and the selected region. Specifying a city as the World city will display the time in that city when you press and hold **CLOCK**. London is the default World city.

1. Press **MENU** and touch **TOOLS** to open the **TOOLS** menu.
2. Select SET CLOCK.
3. Select CHANGE WORLD CITY.

A list of six cities appears. The cities in this list will be those that you last selected, or checked the time in. The currently selected World city is at the top of the list.

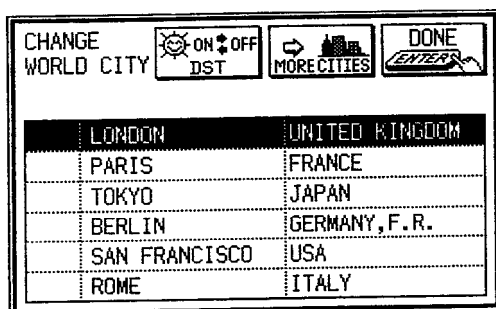

4.
 - If the city you want to select as your World city is on the list, select it and then proceed from step 7 below.
 - If the city you want is not on the list, touch **MORE CITIES**.

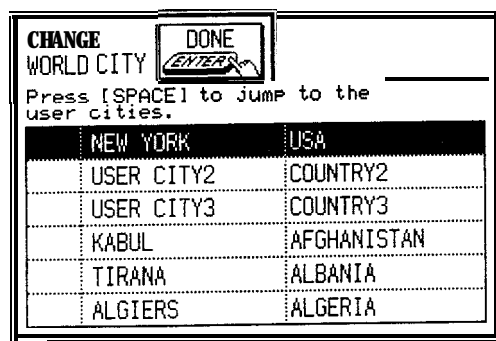

A list of cities appears. The first three cities are User cities which you can specify (see below). As in the HOME

CITY list, all cities in this list are in alphabetical order according to country name.

5. Type the first letter of the name of the country where the city you want to check the time for is located. Then use **PREV** and **NEXT** to display the city you want.
6. Select the desired city by touching it.
7. If daylight saving time is currently in effect for the selected city, touch **DST ON ◀▶ OFF** to specify this. ☀ appears beside the city, indicating that daylight saving time has been set.
8. Touch **DONE**.
The city is selected as the World city and the window closes.
The **Clock** window briefly appears, indicating the time in the selected World city.



You can press **SPACE** at any time to return to the first page of the list.

Adding a User's city

The **Clock** application lets you register your own cities, called "User cities," and designate them as the Home and World cities.

1. Press **MENU** and touch **TOOLS** to open the **TOOLS** menu.
2. Select SET CLOCK.
3. Select ADD USER'S CITY.

The USER'S CITY window opens.

ADD USER'S CITY		STORE 	CANCEL
USER CITY1	NEW YORK		
COUNTRY	USA		
GMT +/- [hours]	i-5		
USER CITY2	USER CITY2		
COUNTRY	COUNTRY2		
GMT +/- [hours]	0		
USER CITY3	USER CITY3		

You can set up to three cities by entering information in the three fields. In the unit's default settings, New York has been designated as USER CITY1.

4. Move to the field you would like to change-USER CITY1, 2, or 3.
 5. Press lo> **NEW** to delete the current setting and enter the name of your desired city.
 6. Move to the COUNTRY field.
 7. Delete the current setting and enter the name of the country where the city is located.
 8. Move to the GMT (Greenwich Mean Time) field.
 9. Enter the time difference between your city and Greenwich Mean Time (the international time reference). Press **-** before a number for a negative time difference. You can specify any value from -11.5 to +12 with 0.5 hour precision.
 10. Touch **STORE** .
The city you entered is set as a User city, and is listed on the first page on both the Home and World city lists.
- To select the User city you have just entered as the Home or World city, see p. 182 or p. 185, respectively.

6

Daylight saving time (DST)

Assigning DST to a city

Designating daylight saving time for a city automatically sets the time for that city one hour ahead.

This can be done using either the Home city or World city list, accessed from the menu.

1. Press **MENU** , touch **TOOLS** , and select SET CLOCK.
2. Select either CHANGE HOME CITY or CHANGE WORLD CITY.
3. Bring the desired city to the display using **PREV** and **NEXT** , then select it.
4. Touch **DST ON ◀▶ OFF** .

☀ appears to the left of the city, indicating that DST has been assigned to it.

5. Touch **DONE**.

To unassign a city's DST setting, simply follow the above procedure and touch **DST ON ◀▶ OFF** again (the button toggles between on and off).

Enabling and disabling DST

Once DST is assigned to a city, it remains in effect until it is unassigned. Once a year cities using DST will switch back to regular time. Rather than having to unassign DST for each city, you can temporarily disable the entire DST feature. Then when these cities switch back to DST, you can reenable the feature.

1. Press **MENU** and touch **TOOLS** to open the **TOOLS** menu.
2. Select SET CLOCK.
3. The current DST setting (enabled or disabled) is indicated by an asterisk. To enable DST on all cities for which it is assigned, select ENABLE DST. To disable DST on these cities, select DISABLE DST.

Setting daily alarms

You can set alarms just like on a regular clock, separately from **Schedule** events, using the **TOOLS** menu. Set alarms will sound even if the Organizer is turned off. This can be especially convenient, for example, when you need an alarm as a reminder or to wake you up, but do not want to make a full **Schedule** entry.

From any application,

1. Press **MENU** and touch **TOOLS**, to open the **TOOLS** menu and select SET DAILY ALARMS.

The SET DAILY ALARMS window opens. You can set up to seven alarms.

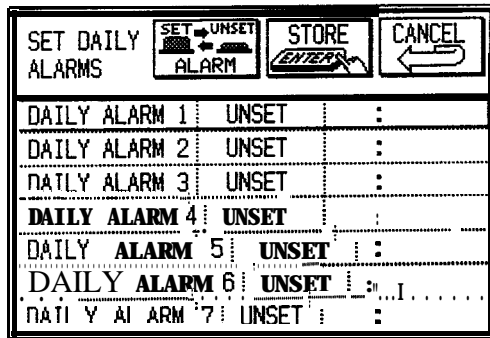

2. Enter the time that you would like an alarm to go off, followed by **AM** or (PM).

3. Touch **SET-UNSET ALARM** to set the alarm.

★ Press **(2nd) ALARM** .

4. Move to the next field and set any alarms you want to set using this procedure.

5. Touch **STORE** (or **CANCEL** to cancel the setting).

Turning alarms on and off

To turn off an alarm that is sounding, press **ON** . Alarms will turn off automatically after sounding for 15 seconds. To unset an alarm, select SET DAILY ALARMS from the **TOOLS** menu, select the alarm you want to turn off, and touch **SET—UNSET ALARM** (alarms are indicated as set or unset in the display's middle field).

★ You can also press **(2nd) ALARM** after selecting the desired alarm.

Disabling all alarm sounds

Once you have set an alarm, it will sound at the appropriate time whether the unit is on or off. When the unit is on,  at the right side of the display indicates that any alarm that is set will sound.

There may be times when you do not want to hear any of the set alarms. You can disable all Schedule and Daily alarms at once.

1. Press **MENU** and touch **TOOLS** .

To open the second tools menu, touch MORE TOOLS and select ENABLE/DISABLE ALARM.

The ENABLE/DISABLE ALARM submenu opens. The setting in effect is indicated by an asterisk.

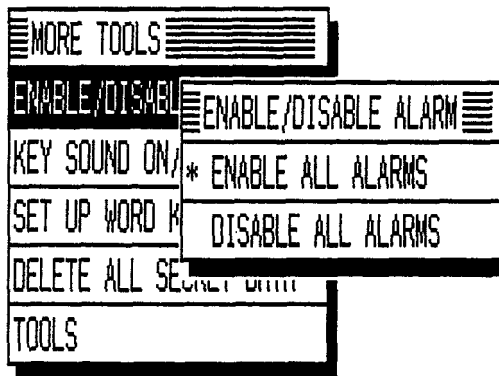

2. Select DISABLE ALL ALARMS.

 disappears from the display. All alarms are turned off, i.e. no audible alarm will sound, until you use the above procedure to turn them on again by selecting ENABLE ALL ALARMS. However, the display will still indicate when each alarm reaches its set time, even when the unit is turned off.

- ★ You can also press 2nd I,) to enable/disable all alarms.

The Scrapbook Application

The unit's **Scrapbook** makes it possible to draw maps, create illustrations, or make a quick note by writing directly on the display. The drawings can then be pasted into entries in the **Tel** and **User File** applications, and become part of those databases (see p. 126).

-  Graphic entries take up a lot more space in the unit's memory than text entries, so it is a good idea to delete those graphic entries you do not need, or copy them to a RAM memory card.

- ➔ General operations for graphic entries using the **Scrapbook** application were introduced in Chapter 2. If you want to review those operations, turn to page 77.

Making new entries

1. Press [SCRAPBOOK] to open the application.
A “blank page” opens.

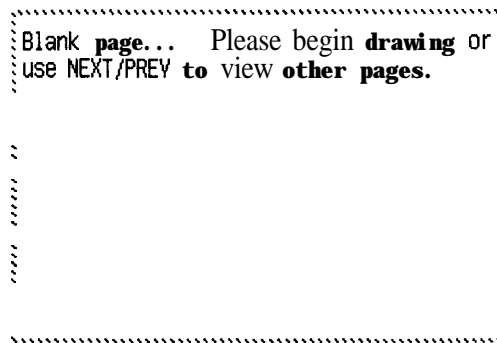

6

2. Using the touch pen, start writing whatever you would like directly on the display.
The page automatically changes to the “drawing page.” THICK is the default drawing tool (for an explanation of drawing tools, see below).

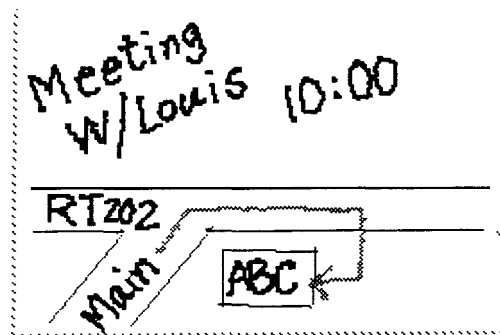

3. Press (ENTER) .
Your drawing is now stored, and the display changes to the viewing page.
4. Touch [NEW] to make another entry, or press any other application key to close the **Scrapbook**.

Using the drawing tools

The drawing tools add versatility and capability to creating graphics with the unit. The tools are selected from the **MODIFY** menu.

Press **MENU** and touch **MODIFY** .
The **MODIFY** menu appears.

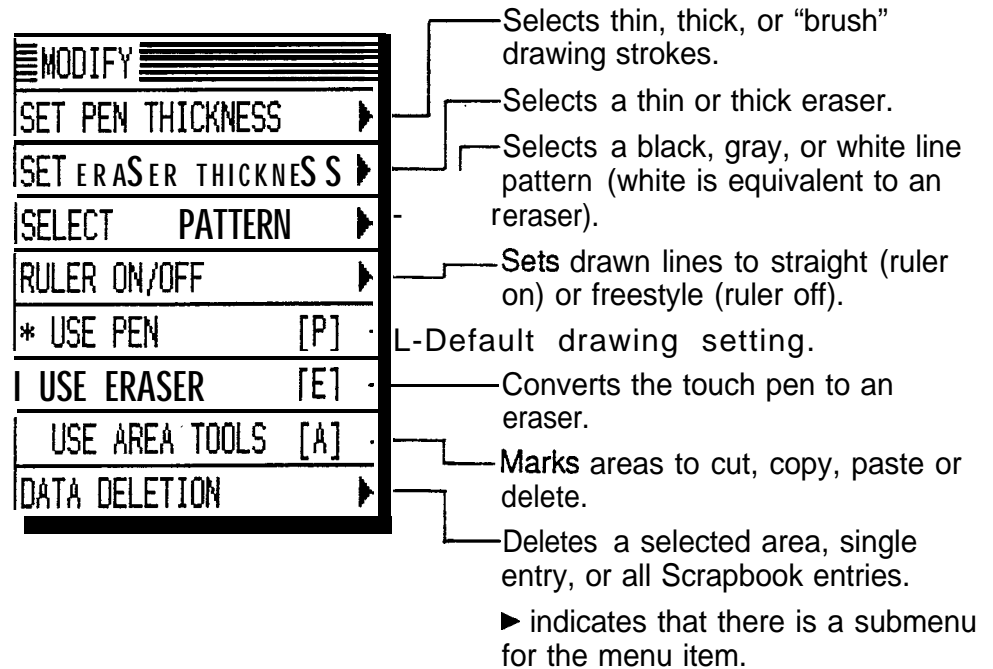

Finding entries

Entries are saved in the order that they are stored, and are displayed using **PREV** or **NEXT** from the initial blank page screen.

Editing entries

1. Display the entry you want to revise using the procedure above.
2. Touch **EDIT** .
The drawing page is displayed.
3. Make any desired changes.
4. Press **ENTER** .
The revised drawing is now stored.

Selecting an area

You can select a section of a drawing for copying, deleting, and other operations.

1. Make sure you are on the drawing page. Press **MENU** , touch **MODIFY** , and select **USE AREA TOOLS** .

2. Draw a line to select the area you want.

You select an area by drawing a line diagonally across it. The unit recognizes the line as a diagonal and places a rectangular box around it, which marks the area for an operation.

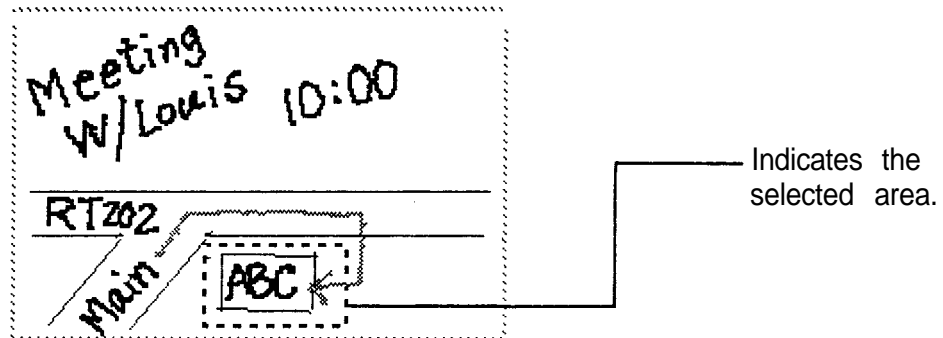

6

3. Proceed to the sections below corresponding to the operation you want to perform on the selected area.
To deselect an area, simply touch anywhere in the drawing area.
4. When you have finished working with a selected area, open the **MODIFY** menu and select USE PEN (or USE ERASER) to quit the area operation and continue working with the picture, or press (ENTER) to store the picture.

Moving or copying sections of graphic entries

You can move or copy sections of graphic entries only within the **Scrapbook** application.

1. Select the area to be moved or copied to another location.
2. Press (2nd) (CUT) to move or (2nd) (COPY) to copy.
3. Select the area you want to move or copy the drawing to.

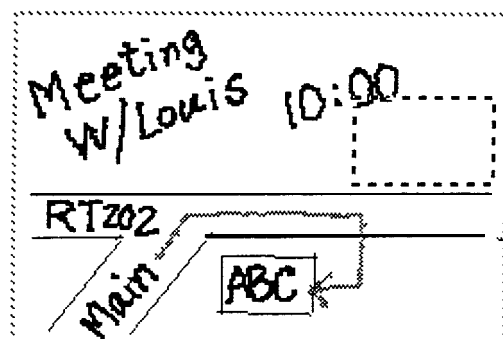

4. Press (2nd) (PASTE) .

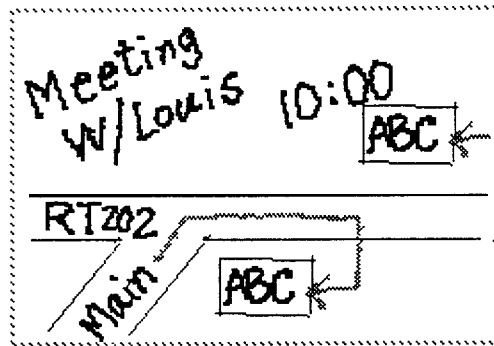

- ☞ You cannot reduce or enlarge an area of graphics. No matter what size area you select to paste to, the cut/copied graphics (or a part thereof) will be reproduced at the same size as the original.
- ➔ To move or copy an entire area of graphics, see p. 130 or p. 209.

Deleting sections of graphic entries

1. Select the area you want to delete.
2. Press **[DEL]** .

Adding text strings to graphic entries

You can import text from other applications to the **Scrapbook**.

1. Display the entry that you want to import text from in the View mode.
2. Copy the desired text by using (2nd) **[COPY]** or (2nd) **[CUT]** .
3. Press **[SCRAPBOOK]** .
4. Display an existing drawing and touch **[EDIT]** , or begin drawing to make a new entry.
5. Select the area where you want to place the text.

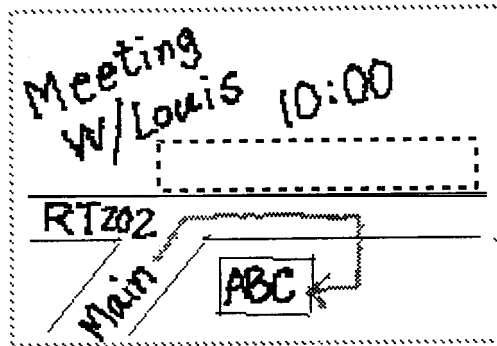

6. Press (2nd) **PASTE** .

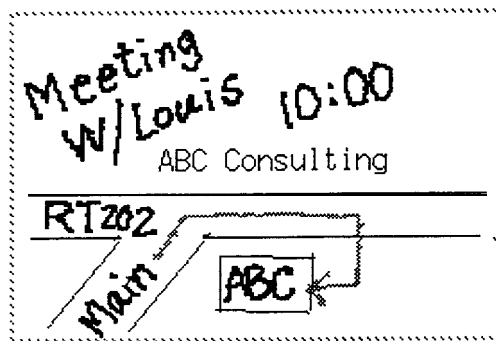

6

The text is reproduced so that it fits in the area you specify with lines of text split over several lines if necessary.

If the specified area is not big enough to contain the entire cut/copied text, only part of it will be pasted.

Deleting entries

Deleting single entries

1. Display the drawing you want to delete in the viewing page.

2. Press **DEL** .

A warning message appears asking if you are sure you want to delete the entry.

3. Touch **YES** (or **NO** to cancel the deletion).

Deleting all entries

In any application,

1. Press **MENU** , touch **MODIFY** , and select DATA DELETION.

The DATA DELETION submenu appears.

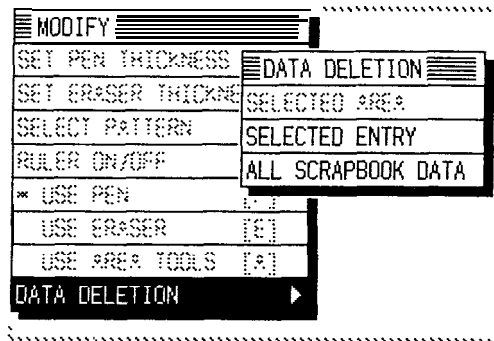

2. Select ALL SCRAPBOOK DATA.

A warning message appears asking if you are sure you want to delete all the **Scrapbook** entries.

3. Touch YES (or NO to cancel the deletion).

The
Scrapbook
application
(VIEWS)
menu

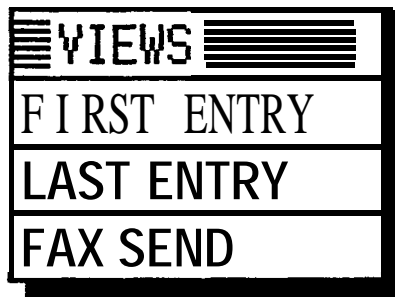

— Displays the first Scrapbook entry.

— Displays the last Scrapbook entry.

— Sends a fax of the currently displayed picture. (Sharp CE-FM1 fax/modem and CE-137T level converter must be connected.)



7

Features and Utilities for Added Power

7

In addition to its basic features, the unit also provides an array of utilities that gives you even greater control over your information. This chapter introduces and explains those features, from cut, copy, and paste, to filing, filtering selected entries, and more. Not everyone will need to use all of these features on a daily basis-pick and choose from among them to find those that suit the job at hand and your own working style.



In general, all of the unit's applications share the features explained in this chapter. Exceptions are noted.

The Filer Application

This unique and easy-to-use application allows you to manage your information by topics rather than by type of entry. Using **Filer** folders, you can organize information the same way as you would in your office. For example, suppose you have a project called "Andromeda". In your unit you might have the names and phone numbers of three personnel involved in the project stored in one of the **Tel** files, two pages of meeting notes in the **Notebook** application, one outline describing the project in the **Outline** application, three action items in the **To Do** application, and five Andromeda meetings in the **Schedule** application. With the **Filer**, you can assign all entries related to the Andromeda project to a single folder, then simply select the folder when you want to carry out an operation such as view, print, transfer, FAX, delete, etc. This makes it possible to manage all entries related to the project as a single folder.

Press **FILER** to open the application.

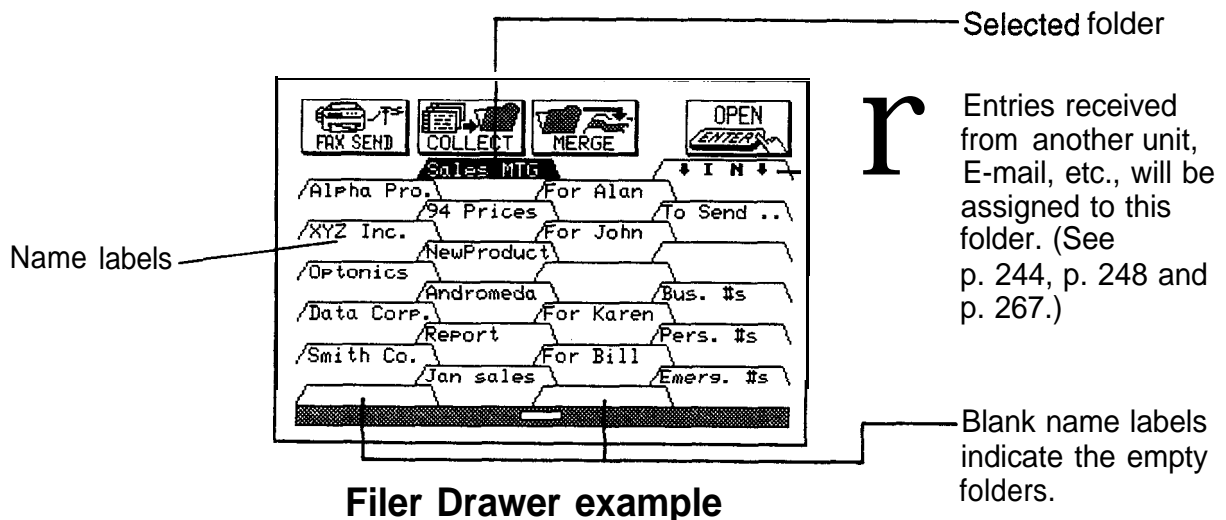

Filer Drawer example

The Filer Drawer is the initial display in the **Filer** application, from which you can manage folders and perform various operations on them.

Before you can use this convenient application, you must first assign the entries to folders.

Assigning entries to folders

There are two ways of assigning entries to a folder: you can assign a group of entries to one folder, or you can assign individual entries to one or more folders. No matter which type you decide to use, the entries themselves are not moved to or stored in the folder, they are simply assigned to it; the entries are retained in the applications that created them.

Assigning related entries to one folder

You can assign groups of entries linked by a common keyword to a specified folder using **COLLECT**. This function also lets you select which applications to search for entries containing the keyword.

1. Press **[FILER]** to open the application.

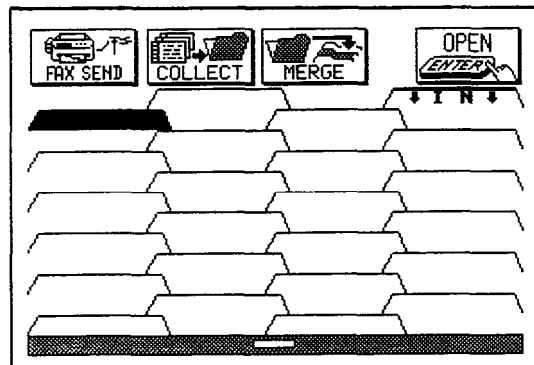

2. Touch a name label to select the folder that you want to assign the entries to.

★ You can also use the cursor keys to select a folder.

3. Touch **COLLECT**.

The COLLECT ENTRIES window opens.

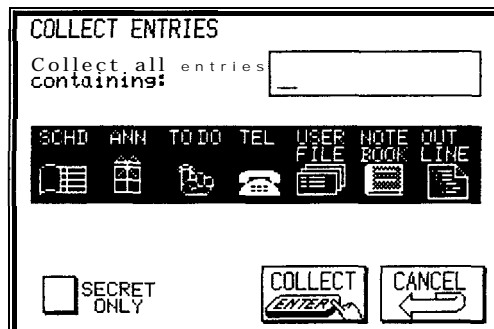

- If you select a folder that already contains entries and touch **COLLECT**, a message indicates that if you proceed, the existing entries will be unassigned from that folder. Touch **YES** to proceed (or **NO** to cancel the selection and choose another folder).
 - You may notice that buttons for some applications are missing from the COLLECT ENTRIES window. It is not possible to create entries in the **Calendar**, **Calc**, and **Clock** application windows, so these applications are not included. Graphic entries cannot be assigned to folders, so the **Scrapbook** is also not included.
4. Enter a keyword up to 16 characters long. Letters, numbers, and symbols can all be used. (The unit does not distinguish between upper- and lower-case letters.)
 - Touch the SECRET ONLY box to collect on/y secret entries. (This box will not be displayed if the unit is locked.) Entering a keyword is optional in this case. (Touch the box again to deselect it.)
 5. Since all the applications are selected by default, touch the buttons to deselect any applications you do not want to collect entries from.

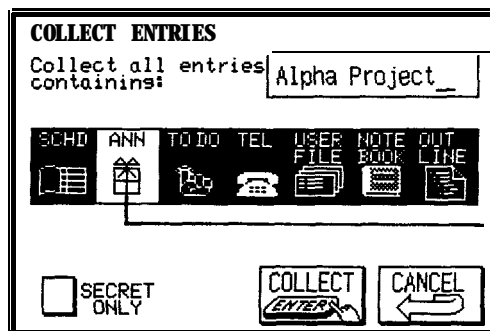

Touch again to select.

6. Touch **COLLECT** in the window.

A "Collecting" message appears. If there are no entries containing the keyword, a message indicates this. You may want to try again using a different keyword, or touch **CANCEL** to close the box.

All entries containing the keyword are assigned to the specified folder. The first ten characters of the keyword

are displayed as the name of the folder (or UNTITLED is displayed if you collected secret entries without specifying a keyword).

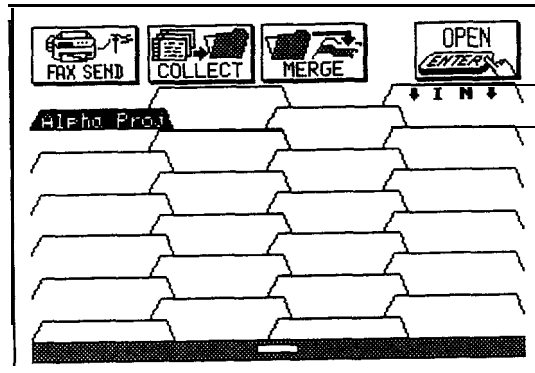

- You can easily change the name as you like. See p. 202, “Naming or renaming folders”.

7

Assigning a single entry to folders

1. Display the entry that you want to assign to a folder in the View mode of its application.
2. Touch **FILE IT** .
A window opens.

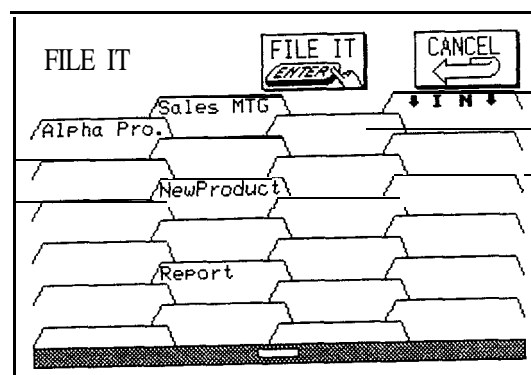

3. Touch as many folders as you want to assign the entry to. (Touch a folder again to deselect it.)
4. Touch **FILE IT** .
A “Filed!” message is displayed and the View mode reappears.

The entry is appended to any existing entries in the selected folder(s).

- ☞ If you select an empty folder to assign an entry to, the first ten characters of the contents of the first text field of the entry are shown on the name label.
- ➔ You can easily change the name as you like. See the following section, "Naming or renaming folders."

Naming or renaming folders 1. In the Filer Drawer, touch the name label to select any folder (except the IN folder) that you would like to name or rename.

- ★ You can also use the cursor keys to select a folder.

2. Press (EDIT),
The EDIT FOLDER NAME window opens.

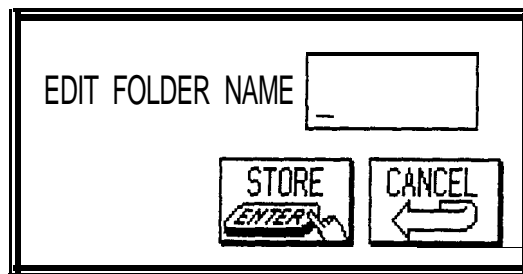

3. Enter any name up to ten characters long that you would like to use for the folder. Letters, numbers, and symbols can all be used.

When renaming, first press  **NEW** to delete the existing name.

4. Touch **STORE** to register the name (or **CANCEL** to cancel it).

The name you entered appears on the name label.

- ★ You can also name a folder using the **MODIFY** menu. In step 2, select EDIT FOLDER NAME from the menu.

Viewing entries via the Filer

Once an entry has been assigned to a folder, it can be easily accessed using the **Filer**. The advantage to accessing information via the **Filer** is that you can browse through your information by topic rather than by application.

1. Press **FILER** and go to the Filer Drawer display if it does not appear.
 2. Select the folder containing the entries that you want to see then touch **OPEN**. (Only one folder can be opened at a time.)
- ★ Touch the folder twice.
Entries in the folder are displayed in the Filer Index.

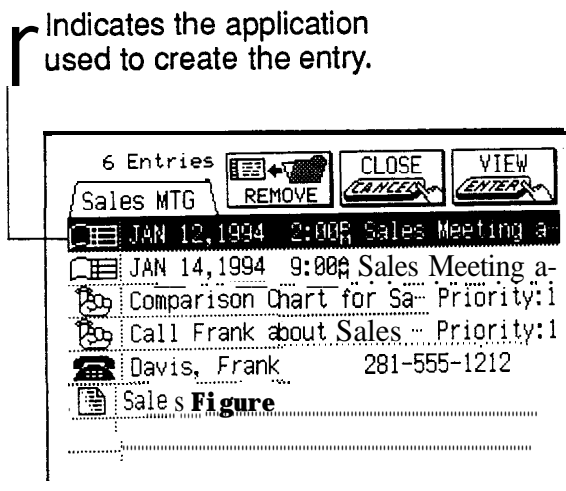

Entries in a folder are sorted by application. If there are more than eight entries assigned to the folder, press **PREV** or **NEXT** to display additional entries.

3. Select the entry you want to view in detail, then touch **VIEW**.
- ★ Touch the entry twice.
The entry now appears in the View mode of its application.
4. Press **FILER** to return to the Filer Index.
 5. Touch **CLOSE** to return to the Filer Drawer.
- ★ Touch the folder's name label.

Editing and deleting assigned entries

Once an entry has been assigned to a **Filer** folder or folders, any changes made to the entry in its application will be reflected in all relevant folders.

Before an entry can be edited or deleted, its application must be opened.

1. Open the desired folder.
2. Select the entry you want to edit or delete then touch **VIEW**.
3. Perform the desired operation.
4. Press **FILER** when you have finished to return to the Filer Index.



- It is not possible to create a new entry in the **Filer** application. New entries must be created in individual applications.
- Deletion of single entries can only be done in the individual applications. However, you can delete all entries in a folder using the **Filer** application (see p. 206).

Unassigning entries from folders

Unassigning single entries from folders

If you assign an entry into the wrong folder, or no longer need a particular entry assigned to a folder, you can unassign it using **REMOVE**.

1. Select the folder in the Filer Drawer that contains the entry that you want to unassign.
2. Touch **OPEN**.
If the desired entry is not displayed, press **NEXT** until it appears.
3. Select the entry that you want to remove.
4. Touch **REMOVE**.

Since the entry is not deleted from the unit, there is no user message asking you to confirm the operation. The entry is unassigned from the folder.

5. Touch **CLOSE** to return to the Filer Drawer.

Unassigning all entries from a folder

You can easily unassign all of the entries assigned to a folder using the application menu.

1. In the Filer Drawer, select the folder you want to empty.
2. Press **MENU** , touch **MODIFY** , and select **EMPTY THIS FOLDER**.

A message appears to confirm that you want to unassign everything in the folder.

3. Touch **YES** to empty the folder (or **NO** to cancel the operation).

The name label is now blank, indicating an empty folder.

Merging folders

At times, you may find two folders whose contents, names, or purpose are duplicated. Or you may find that you want to move or combine the contents of two folders into a single folder. This is easy to do on the unit.

Combining a folder that has been named with an empty, unnamed folder results in “moving.”

Combining a folder that has been named with another named folder results in “merging” (even if UNTITLED is the name of one or both files).

1. Select the folder in the Filer Drawer that you want to merge with another folder.
2. Touch **MERGE** .
“MERGE 2 FOLDERS” is displayed.

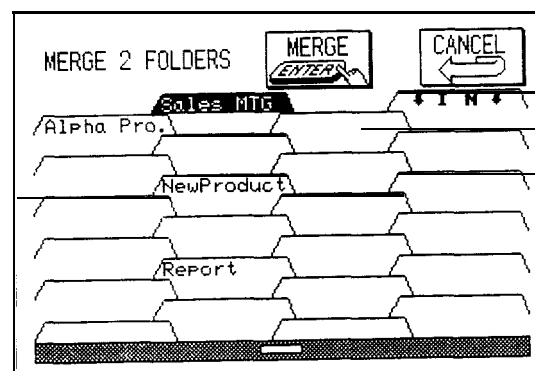

3. Select the folder that you want to merge the first folder with (destination folder).

The contents of the first selected folder are appended to the destination folder. When merging folders, the name of the destination folder has priority. If there are duplicates of the contents in folders being merged, one of the duplicates is automatically deleted.

4. Touch **MERGE** (or **CANCEL** to cancel the procedure).

The folders are now merged and the Filer Drawer appears.

Deleting all entries in a folder

Deleting all entries from a folder deletes them completely from the unit.

1. Press **FILER**.
2. Select the folder in the Filer Drawer containing the entries that you want to delete. (Only one folder can be selected at a time.)
3. Press **MENU**, touch **MODIFY**, and select **DELETE FOLDER CONTENTS**.

A warning message appears asking if you are sure you want to delete all the entries in the folder.

4. Touch **YES** (or **NO** to cancel the deletion).

 It is not possible to delete all entries simultaneously, if the unit is locked. See p. 282.

Sharing folders

You can send (via infrared) all entries assigned to a particular folder to another 8900/9000 series unit.

1. Press **GET** on the receiving unit.
2. Press **FILER** on the sending unit.
3. Reverse a folder in the Filer Drawer and press **SEND**.

All entries assigned to the selected folder will be transmitted to the receiving unit. All entries will be automatically assigned to the receiving unit's IN folder.

See page 248 for more information about unit to unit transfers.

The Filer application menus

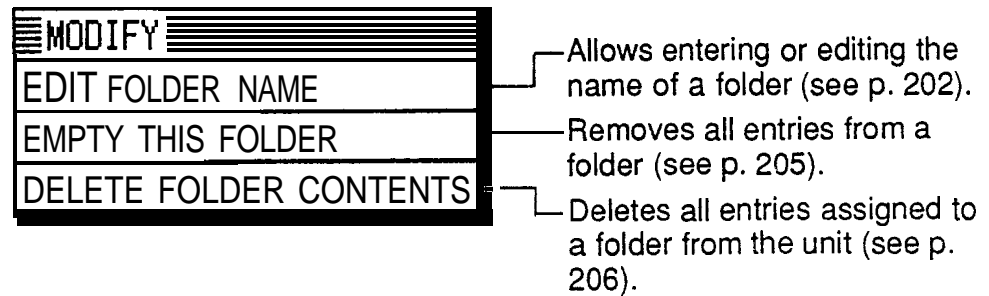
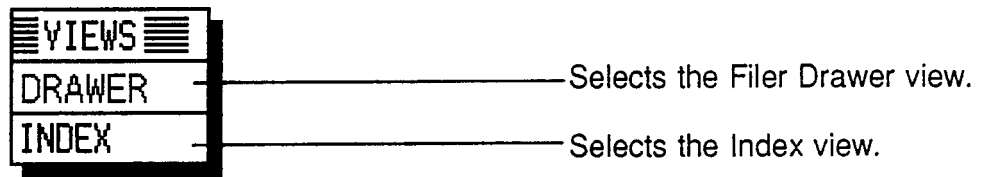

7

Copying or Moving a Block of Text

The unit lets you cut, copy, or paste blocks of text or selected areas of graphic images, using the application menu. The first step in cutting, copying, and pasting is to select the block of text or the area of the graphic you want to work with.

Text or a graphic that has been cut or copied is stored on the unit's internal "clipboard." Only one block of text or graphic can be stored in the clipboard at a time, and it will remain there until a new block of text or graphic is cut or copied. There is no limit to the number of times you can paste text or graphics from the clipboard.

You can copy or move blocks of text in virtually any application.

➔ For a full explanation of using CUT/COPY/PASTE with graphics, see p. 193.

1. Select an entry in the Index mode or display it in the View mode of an application and press **EDIT**.

The entry opens in the Edit mode.

2. Drag the touch pen from the beginning to the end of the text that you want to move or copy.
3. Press **(2nd) (CUT)** if you want to delete the selected text so that it can be pasted to a new location.
Press **(2nd) (copy)** if you want to make a copy of the text (and leave the original unchanged).
The text is copied in the clipboard.
4. Touch **[STORE]** if you want to store the original entry with any changes, or touch **[CANCEL]** to discard all the changes you have made to the original entry, including text cutting.
5. Move the cursor to the location where you want to place the text, either within the same entry or in another entry.
6. Press **(2nd) [PASTE]**.
The text you selected is now moved or copied to the new location.
7. Touch **[STORE]** to store the moved or copied text in its new location.



- Pasted text is inserted into existing text regardless of whether the insertion or overwriting mode is selected. By highlighting the text before **(2nd) [PASTE]** is pressed, however, it can be replaced with the pasted text.
- Only numbers and operators can be pasted to and from the **Calc** application. Any text that is pasted will be ignored. Pasted calculations can then be performed in the **Calc** application.
- A block of text can also be copied (but not cut) from an entry opened in the View mode.

Copying or Moving Entries

The CUT/COPY/PASTE function provides a quick, convenient way for you to copy or move an entire entry to another location. Entries do not have to be in the same file or even in the same application-CUT/COPY/PASTE works across virtually all applications including those on a RAM card. Graphic entries, however, can be copied or moved only within the **Scrapbook** or to a picture field in a **Tel** or **User File** entry, or to the start-up display.

1. Display an entry that you want to copy or move in the View mode, or select it in the Index mode.
2. Press (2nd) **CUT** if you want to move the entry. A message will ask if you are sure you want to delete the entry from its present location. Touch **YES** to proceed (or **NO** to cancel the operation).
Press (2nd) **COPY** if you want to make a copy of the entry.
3. Press **NEW** in the application you want to move or copy the entry to. You can also append the copied/cut entry to an existing entry. Open an entry in the Edit mode, and move the cursor to the position where you want to append the entry.
4. Press (2nd) **PASTE**.
5. Make any necessary changes to the moved/copied entry. Touch **STORE** when you have finished to store the entry.

The entry you selected is now moved or copied to the new location.



- In the View mode in the **Outline** application, to copy or move an entire outline, you must first select its title. If you select a topic in the outline, only the selected topic and its subtopics will be copied.
- **Scrapbook** entries can only be pasted within the **Scrapbook** application or into the picture field of a **Tel**



or **User File** entry (see p. 130), or to the start-up display (see p. 280). Pasting **Scrapbook** entries in any other place only displays “«PICTURE»” there.

- Only text data can be moved/copied from a **Notebook** entry to another application. The format in which the entry was stored is not reproduced. Additionally, if a tab is included in the original entry, any subsequent text will not be pasted.
- Indents and page format settings in a **Notebook** entry will not be moved/copied, even if it is pasted within the same application.

Creating a New Entry Based on an Existing One

You may sometimes find it convenient or necessary to make changes to an entry without losing any of the information in the original entry in order to make a new entry that is very similar to a previous one.

In the **Notebook** application, for example, you may want to make a copy of a business letter so you can use the format in another letter.

By using (2nd) **ENTER** , you can edit or change an entry, then store those changes in a new entry, ensuring that information in the old entry remains intact.

1. Recall an entry and make any changes to it that you would like in the Edit mode.
2. Press (2nd) **ENTER** .

The edited entry is now stored as a new entry, and the original remains unchanged.



- In the **Notebook** application, you will be asked under which title the new entry should be stored. Enter the new title and touch **STORE** . If you use the same title as for the original entry, you will have duplicate titles for entries with different contents.
- Pressing the (2nd) **EDIT** stores an entry as a copy so that you can save the original entry and edit the duplicated entry.

The Time Stamp and Date Stamp Functions

The time and date stamp functions can be used to insert or “stamp” the current time and date anywhere in an entry, including time/date fields in applications such as **Schedule** and **To Do**. This is very convenient for keeping track of such things as telephone conversations or when tracking expenses.

1. When working in the Edit mode of an application, place the cursor at the location where you want to insert the time or date.
2. Press (2nd) **TIME STAMP** to insert the time, or (2nd) **DATE STAMP** to insert the date, or both. When you store the entry, the time and date stamps will be stored with it.

7

TEL 1	
CANCEL	STORE ENTER
NAME	Smith, John
NUMBER	201-529-8200
	201-529-9695 FAX
ADDRESS	123 Main Street
	Mahwah, NJ 07430
	3/ 3/1994 4:30P

- Time and date stamps inserted into an entry are included in any printout of the entry.
- You cannot stamp a **Scrapbook** entry with the time or date.

The Word Key

You may sometimes find yourself having to enter the same word over and over again—in lists, for example—or you may have several memos or letters you have to write that are all on the same topic. Using the **WORD** key,

you can easily insert words, numbers, and phrases (up to 32 characters long) in an entry with the press of a key.

Registering your words or phrases

There are no default words assigned to the unit's **WORD** key, so to use the key you must first register your words or phrases.

1. Press **MENU** and touch **TOOLS** to open the **TOOLS** menu. Select MORE TOOLS and then select SET UP WORD KEY.

A list appears-now blank-which you will use to assign words to the Word key.

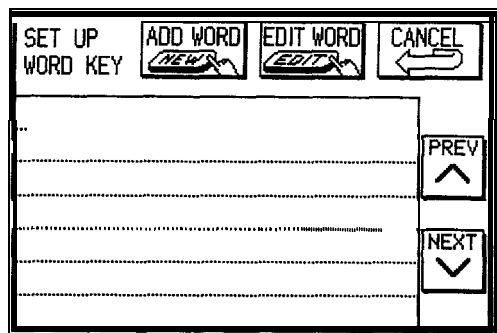

2. Touch **(ADD)**.
A NEW WORD window opens.

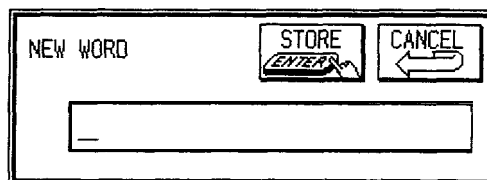

3. Enter any word, number, or phrase (up to 32 characters) that you want to be able to recall using **WORD**.
4. Touch **STORE**.
5. Repeat steps 2 to 4 above to register any other words you might like to insert into a document using **WORD**.
Words are registered and sorted alphabetically.
6. Touch **CANCEL** when you are finished.

Inserting a word or phrase with the Word key

1. When entering or editing an entry in the Edit mode, place the cursor where you want to enter a word.
 2. Press **WORD**.
The RECALL WORD window opens, showing an alphabetical list of the words you have registered.
 3. Select the word you want to insert. Touch **PREV** or **NEXT** to bring up more words if necessary.
 4. Touch **RECALL**.
The window closes and the word is inserted in the entry at the cursor position.
- ★ Touching a word twice in step 3 above also inserts it into an entry.

Editing a word or phrase

You can edit a word or phrase using basically the same procedure for adding a word or phrase (see above), but instead of touching **ADD WORD** in the SET UP WORD KEY window, select the word you want to edit and touch **EDIT WORD**. An EDIT WORD window opens. Make any desired changes and touch **STORE**. Then touch **CANCEL** to close the window.

Deleting a word or phrase

If you find that you no longer need a particular word or phrase, it is easy to delete it. Select SET UP WORD KEY from the **TOOLS** menu, select the word or phrase you want to delete, and press **DEL**. A warning message appears asking if you are sure you want to delete the selection. Touch **YES** (or **NO** to cancel the deletion). Then touch **CANCEL** to close the window.

The Filter Function

The unit's **Filter** function allows you to focus only on entries containing specified information in an application. For example, you could recall all the entries pertaining to a specific company. The **Filter** function does this by hiding all entries that do not match specified criteria from

all the display modes of an application until the function is turned off.

You can edit or view the displayed entries normally while the **Filter** is turned on.

The **Filter** function is available only in the **Schedule, Tel,** and **User File** applications.

Turning the Filter on

1. Open the application-Schedule, **Tel,** or **User** File-containing the entries you want to work with. Go to the Index or View mode.
2. Press **MENU** , touch **VIEWS** , and select FILTER ON/OFF.
A submenu appears.
3. Select TURN ON FILTER.
 - In the **Tel** and **User File** applications, a display similar to the Edit mode opens.

A screenshot of a submenu titled 'TURN ON FILTER'. At the top left, it says 'TURN ON FILTER'. To its right is a 'SECRET ONLY' checkbox which is currently unchecked. Further right are two buttons: 'FILTER ON' with a hand icon and 'CANCEL' with a left-pointing arrow icon. Below these elements is a list of fields: COMPANY, NAME, POSITION, EXT/DIRECT, DEPARTMENT, TEL NUMBER, and FAX NUMBER. Each field has a dotted line indicating it is a text input field.

- In the **Schedule** application, a window opens as shown below.

A screenshot of a submenu titled 'TURN ON FILTER'. At the top left, it says 'TURN ON FILTER'. To its right is a 'SECRET ONLY' checkbox which is currently unchecked. Further right are two buttons: 'FILTER ON' with a hand icon and 'CANCEL' with a left-pointing arrow icon. Below these elements is a single field labeled 'DESCRIPTION' with a dotted line indicating it is a text input field.

4. Touch the SECRET ONLY box to extract secret entries only (see p. 282). (This box will not be displayed if the unit is locked.) You can extract all the secret entries in the application by skipping step 5 below. (Touch the button again to deselect the feature.)

5. Type the keyword(s) you want to use as a filter. In the **Schedule**, keyword(s) must be those that appear in the DESCRIPTION field.

In the **Tel** and **User File**, enter keywords in as many-or as few-fields as you want. However, in picture fields, indicated by “[PICTURE],” you cannot enter anything. The more keywords you enter, the more selective the filtering process will be.

6. Touch **FILTER ON**.

The filtering process begins and an Index page appears with the first entry that matches your criteria.

If no matching entries are found, a message indicates this.



If a new entry is made or an entry is transferred from another device when the **Filter** function is on, the entry will be displayed even though it may not meet the criteria. If you want to remove these new entries, you will have to turn the **Filter** function off then repeat the above procedure.



Turning the Filter off

To turn **off** the **Filter** function, simply touch **TURN OFF FILTER** on the display or select TURN OFF FILTER from the FILTER ON/OFF submenu.

Deleting filtered entries

The **Filter** function also makes it possible to delete a group of entries related to one or several topics. This can be extremely helpful, for example, if you complete a project that has several entries relating to it, saving you time by deleting them as a group instead of one by one.

In the **Schedule**, **Tel**, or **User File** application,

1. Turn on the **Filter** using keywords to collect the entries you want to delete.
2. Press **MENU**, touch **MODIFY**, and select DATA DELETION.
A submenu appears.
3. Select FILTERED ENTRIES.

A message appears asking if you want to delete all filtered entries in the application.

4. Touch **YES** (or **NO** to cancel the procedure).
All the filtered entries are deleted and the **Filter** function is turned off.

Special Characters

The unit has a seventeen-page menu containing 136 symbols and accented characters, such as ù, ì, and ç, plus one page for 8 often-used symbols. These symbols and accented characters can be easily accessed and inserted into an entry. Selecting any of these special characters inserts it at the cursor location.

1. When entering data or editing an entry in the Edit mode, position the cursor where you want to insert a symbol or special character.
2. Press **SMBL** on the keyboard.
The Symbol menu appears.

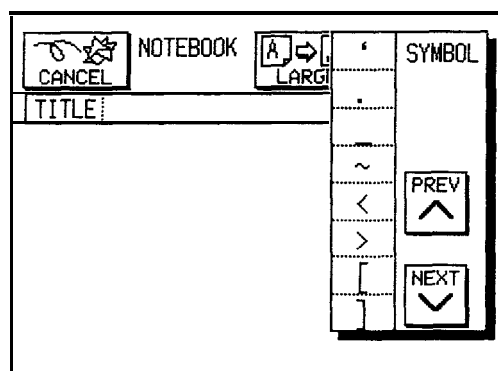











3. Press **PREV** or **NEXT** until you find the character you want to enter (there are 18 menu pages to look through).
4. Touch the desired symbol to select it.
The symbol menu closes and the selected character is entered at the current cursor position.

5. If the symbol you just selected is an accent mark (` , ´ , ¨ , ^ ~ ° or _), it will flash on the display. Type the letter you want to enter with that accent mark.







- When you next open the Symbol menu, the character you selected is at the top of the first page. The unit automatically registers the 8 characters most recently selected from the Symbol menu in its first page, making it easy to quickly access characters that you use frequently.
- When printing an entry, depending on your printer's capability, some selected symbols and characters may not be printed (consult your printer manual).
- You can use the following keyboard shortcuts:

Accent	Keyboard shortcut (followed by the desired letter)
--------	---

	 
`	 
'	 
¨	 
^	 

Special character/ symbol	Keyboard shortcut
------------------------------	-------------------

ç	 
ß	
;	





8

Using the Optional Peripherals

Your unit is a powerful pocket-size computer with self-contained functions that make it possible to accomplish a broad range of tasks, including printing. It has the flexibility to connect to other units and transfer data to desktop computers using the telecommunications functions, which are accessed through the **PERIPHERALS** menu. In addition, faxes can be sent from the **Notebook**, **Scrapbook**, and **Filer** applications. This chapter provides the explanations and examples to get you up and running with these features.



8

The Peripherals Menu

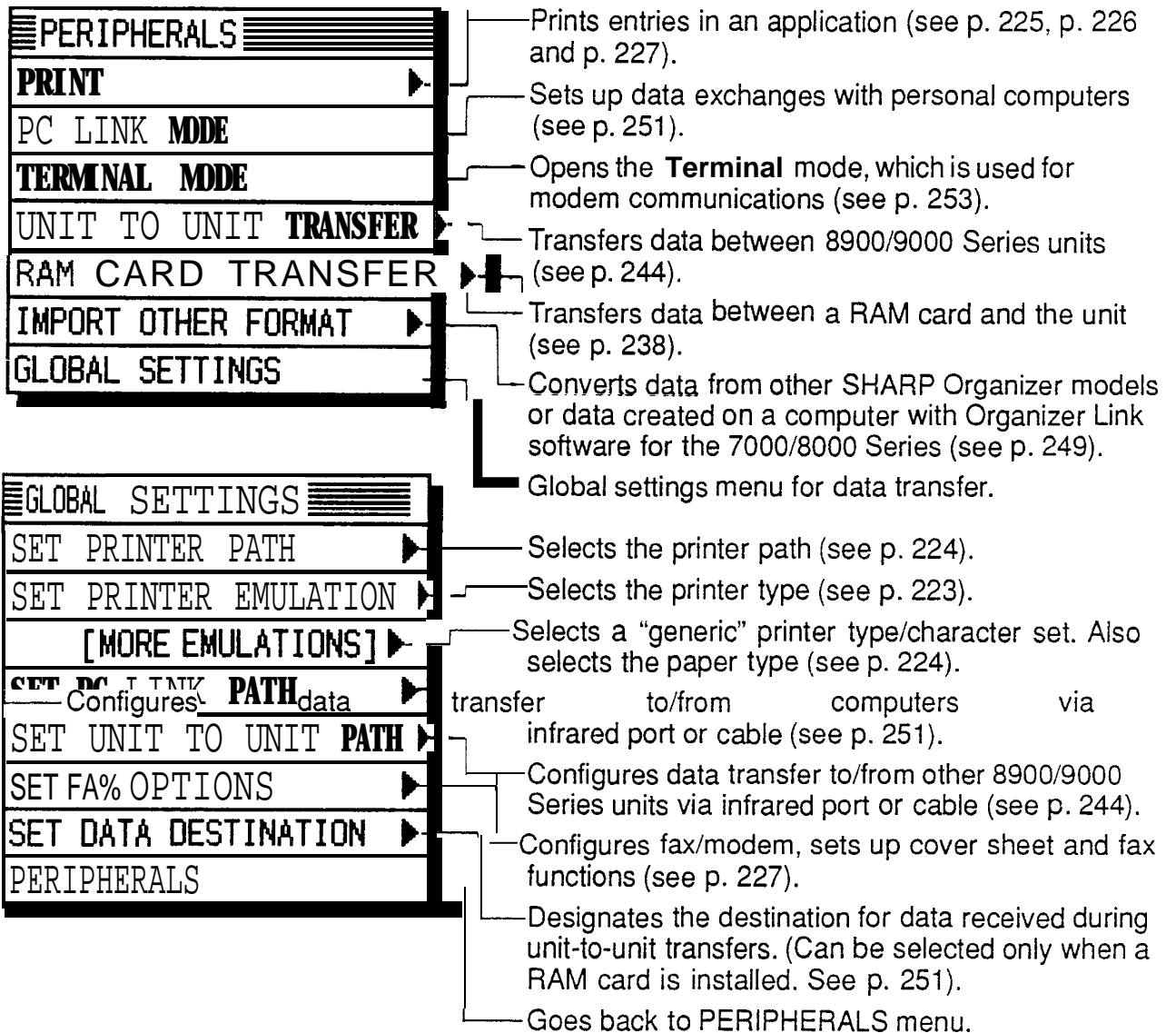

Application IC Cards

Many application IC cards are available as options for the unit, as well as RAM cards to add extra memory. Simply press **CARD** to access the function of an installed IC card.

The cards can be operated by touching the card keypad that appears on the display.

There are some restrictions when using IC cards formatted for units other than 8900/9000 series. (see p. 274).

- Installing an IC card**
1. Turn the unit off.
 2. Close the unit and turn it over.

3. Set the IC card lock switch to the RELEASE position, (a red bar can be seen in the RELEASE position.)
4. Slide the IC card eject switch and remove the protection card.

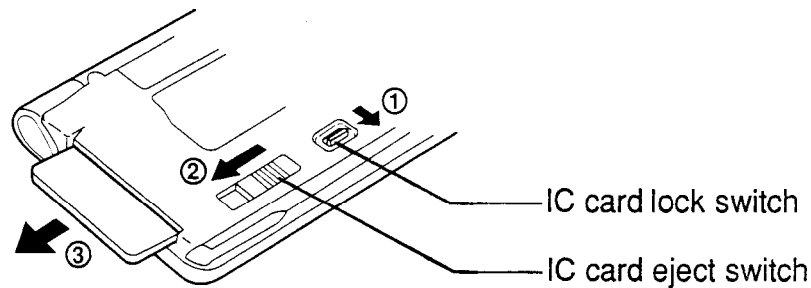

5. Insert the IC card all the way into the card slot, with the back of the card facing up.
6. Set the IC card lock switch to the LOCK position.

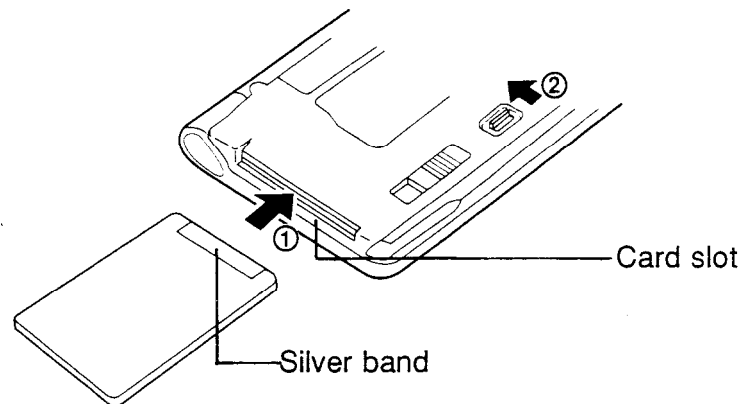

- The unit will not turn on if the IC card lock switch is in the RELEASE position.
- Store the protection card in a safe place and be sure to put it back into the unit when there is no IC card installed.
- If the battery of an installed card is depleted, a message indicating this will appear. Turn the unit off immediately and replace the IC card battery as soon as possible (leaving the card locked in the unit) to avoid losing data. Refer to the card manual for more information.
- If a message indicating a problem with card memory appears, touch **INITIALIZE** to continue, clearing the card memory.

- ➔ For a full explanation of using the unit with a RAM card, see p. 238.

Printing from the unit

You have great flexibility in what you can print out from the unit—from what is currently on the display to single entries to all of the entries in an application. The range of printing options depends on the particular application you are printing from.

Entries and information can be printed on any standard parallel PC printer connected to the unit via the optional CE-IR1 wireless interface. The unit has built-in printer drivers (a printer driver is software that instructs the printer how to format and print data) for the following printers:

- Canon BJ-10e Series
- Epson FX-80, FX-850 and LQ Series
- Hewlett Packard LaserJet **II** and **III** Series
- IBM Proprinter Series

The unit also works with printers that have an emulation mode for any of the above printers (consult your printer's manual regarding the emulation modes it supports). For information about other specific models supported by the unit, consult your local SHARP dealer.

- ☞
- Data may not be printed exactly the same as originally set in the unit if the printer being used does not support the settings which were made (italics set in the **Notebook** application, etc.).

The following restrictions also apply:

LaserJet Series:

Text set for ELITE or PS in a **Notebook** entry may not be printed properly using this model. (In the LaserJet **III**, ELITE is available). In this case, select PICA. No optional font from either printer can be used.

Proprinter Series:

The unit supports the Proprinter X24E. Printers that emulate other Proprinter models may not function

properly.

FX Series:

The unit supports the FX-80 and FX-850.

LQ Series:

The unit supports the LQ-510.

- To print from the unit to a printer, the optional SHARP CE-IRI wireless interface, as well as a standard computer printer cable, is required. See the operation manual for the CE-IRI regarding use with a printer.

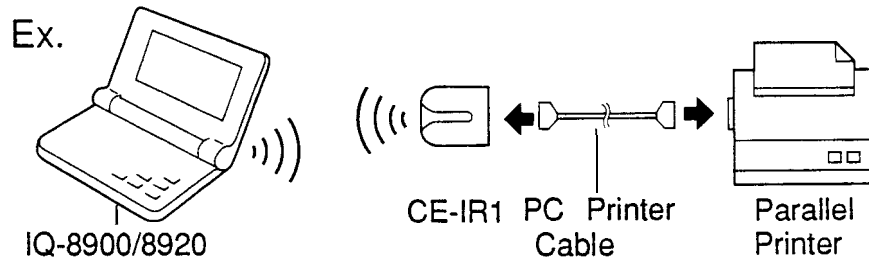

- Hardware compatibility between the printer and the CE-IRI may affect printing capability.

Setting up the unit for printing

1. Press **MENU** and then touch **PERIPHERALS** to open the **PERIPHERALS** menu.

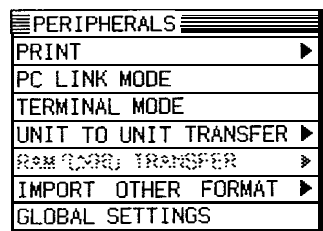

2. Select **GLOBAL SETTINGS**.
The submenu appears.
3. Select **SET PRINTER EMULATION**.
The emulation menu appears.

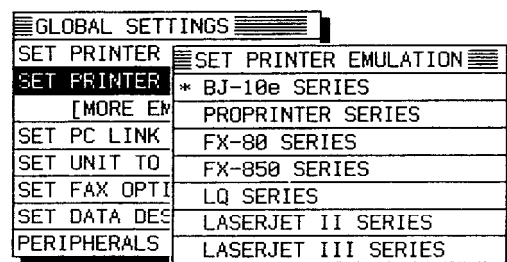

4. Select your printer type or one that your printer emulates

(see your printer's manual regarding the emulation modes it supports).

If your printer does not support any of the printer models listed, touch MORE EMULATIONS and select OTHER (US CHARACTERS) to print U.S. character codes or OTHER (INTERNATIONAL) to print other character code sets. The "OTHER" settings make use of the unit's "all-purpose" printer driver. Only text can be printed; graphic images cannot. In addition, because of the way in which code sent by the unit is converted to characters on the printer, information in the final printed copy may not appear exactly as on the unit.



- The SET PRINTER PATH feature in the **GLOBAL SETTINGS** menu lets you set the printer path before printing, which tells the unit how data is to be sent to a printer. VIA INFRARED PORT is the default setting. While VIA DIRECT CABLE and VIA OTHER are also listed under the SET PRINTER PATH submenu, these features are for possible future peripherals-they have no current function-so it is not necessary to change from the default VIA INFRARED PORT setting.
- To cancel printing, press **ON**. All other key operations are inoperative.
- To print secret entries, the unit must first be unlocked (see p. 278). If you try to print a group of entries or all entries when the unit is locked, only the non-secret entries will be printed.
- Entries are printed in the same format as for their View mode. For example, a collapsed **Outline** entry would be printed without its hidden subtopics, etc.
- When printing graphics, if there is a transfer problem or the print job is canceled while it is in progress, for example, the printer might not function properly until it is turned off and turned on again.

Printing the current display

Virtually any display on the unit can be printed as it appears. Exceptions to this are confirmation prompt (Yes/No) displays, messages, etc. Printing of graphic

images also depends on your printer's capabilities.

1. Open the display that you want to print.
2. Press **[2nd]** **[PRINT SCREEN]**.

 Press **[ON]** at any time to cancel printing.

Printing a single entry 1. Select the entry that you want to print in the Index mode or display it in the View mode.

2. Press **[2nd]** **[SEND]**.

 • Press **[ON]** at any time to cancel printing.
• If you are in an application other than **Notebook** or **Outline**, you have to remove the paper manually after printing. If you are using the Hewlett Packard LaserJet Series printer, the paper will exit automatically after printing.

★ You can also print single entries using the **PERIPHERALS** menu. After selecting or displaying the entry, select **PRINT** from the menu, then **THE SELECTED ENTRY** (or **THE SELECTED OUTLINE**) from the submenu.

Printing a specified group of entries

In the **To Do**, **Schedule**, **Tel**, and **User File** applications, and in the **Filer**, you can print only those entries that match specific criteria.

The procedure for specifying and printing a group of entries varies according to the application.

In the To Do application

1. **Go** to **VIEWS** menu and select the file-**TO BE DONE**, **DONE ENTRIES**, **MONTHLY GOALS**, or a category-containing the entries you want to print.
2. Press **[MENU]**, touch **[PERIPHERALS]**, and select **PRINT**.
3. Select **ALL ENTRIES IN VIEW**.

 Press **[ON]** at any time to cancel printing.

In the Schedule, Tel and User File applications

1. Open the desired application, press **[MENU]**, and touch

IEWS

2. Select FILTER ON/OFF, then select TURN ON FILTER from the submenu. Enter the information to define the entries you want to print.

The more information you enter, the more selective the filtering process will be.

3. Touch **FILTER ON**.
4. Press **MENU**, touch **PERIPHERALS**, and select PRINT
5. Select ALL [application name] ENTRIES.

 Press (ON) at any time to cancel printing.

→ For a full explanation of the **Filter** function, see p. 213.

Printing Schedule entries for specific periods

1. Press **CALENDAR** to open the application.
2. Display and select the date containing the entries you want to print, or a date that is included in the weekly or monthly period of entries that you want to print.
3. Press **MENU**, touch **PERIPHERALS**, and select PRINT.
4. Select ALL IN SELECTED DAY, . . .WEEK. or . . .MONTH.

 Press (ON) at any time to cancel printing.

Printing using the Filer application

Using the **Filer**, you can print related entries from different applications.

1. Press **FILER**.
2. Select the folder from the Filer Drawer that contains the entries you want to print.
3. Press **2nd** (**SEND**).

 Press **ON** at any time to cancel printing.

★ You can also print folder contents using the **PERIPHERALS** menu. After selecting the folder, select PRINT from the menu, then ALL IN SELECTED FOLDER from the submenu.

Printing all entries

All entries in an application (or in a selected file in the **Ann, Tel** and **User File** applications) can be printed.

To print all entries in an application,

1. Open the application containing the entries you want to print.
In the **Schedule, Tel** and **User File** applications, make sure that the **Filter** function is turned off (see p. 215).
2. Press (MENU), touch [PERIPHERALS], and select PRINT.
3. Select ALL [application name] ENTRIES.

 Press (ON) at any time to cancel printing.

To print all entries in a file in the **Ann, Tel** or **User File** application,

1. Open the application containing the file you want to print and select the file.
2. Press (MENU), touch [PERIPHERALS], and select PRINT.
3. Select ALL [file name] ENTRIES.

 Press (ON) at any time to cancel printing.



Sending Faxes from the unit

With the optional CE-137T level converter and Sharp CE-FM1 fax/modem connected to the unit, it is easy to send copies by fax of single **Notebook** or **Scrapbook** entries, or the entire contents of a Filer folder. This lets you provide friends and associates with a faxed copy of the information when they need it. The Fax Send function is also handy when someone needs a map or diagram, because with the **Scrapbook** function you can make a drawing and send it directly by fax.

Connecting the fax/modem

1. Turn off the unit.
2. Connect the unit and the level converter by plugging one end of the level converter into the unit's Computer Link port.
3. Connect the fax/modem and the level converter by plugging the cable of the fax/modem into the converter.
4. Plug the fax/modem into a wall jack.
5. Turn on the unit.

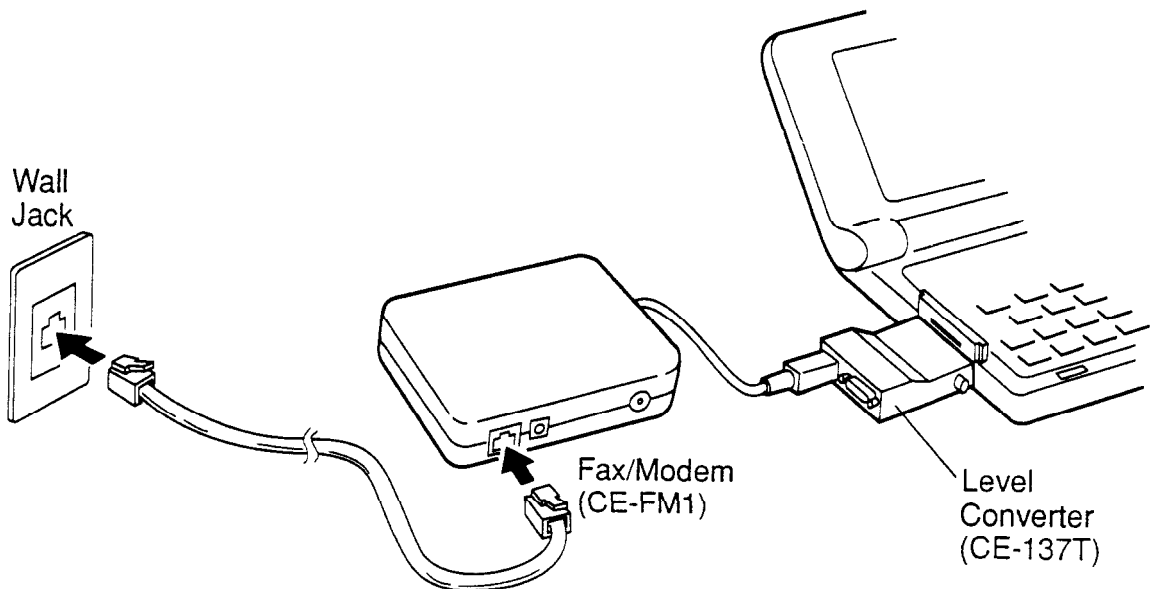

Setting fax/modem options

To use the fax/modem to send faxes, you first need to configure it.

With the fax/modem connected,

1. Turn on the unit.
2. Press **MENU** and then touch **PERIPHERALS** to open the PERIPHERALS menu.
3. Select GLOBAL SETTINGS.
The submenu appears.
4. Touch SET FAX OPTIONS and then touch SET FAX/MODEM OPTIONS. A display appears.

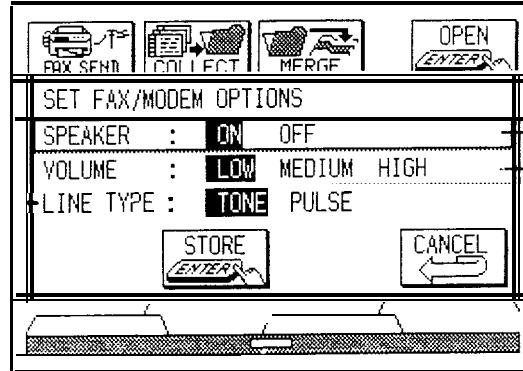

Turn the fax/modem speaker on or off by touching the relevant setting (turning the speaker on lets you hear dialling).
 Select the desired speaker volume by touching it.

Telephone lines use either pulse or tone dialing. Pushbutton phones generally (but not always) use tone dialing, and rotary phones use pulse dialing. Select the line type used at the location you are faxing from (different locations may have different line types).
 This unit cannot change the line type between TONE and PULSE while it is dialing.

5. Press **D** to display the second screen of the SET FAX/MODEM OPTIONS.

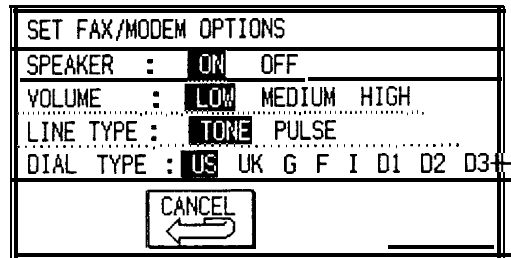

Telephone lines differ depending on the country.
 This unit can match the requirements of each country by selecting the dial type.
 [US] - - - - Set for US/Canada/Australia/Japan
 [UK] - - - - Set for United Kingdom
 [G] - - - - Set for Germany
 [F] - - - - Set for France
 [I] - - - - Set for Italy
 [D1] - - - - Reserved for other countries
 [D2] - - - - Reserved for other countries
 [D3] - - - - Reserved for other countries
 For more information, contact your local SHARP dealer.

6. Select the dial type by touching the relevant setting.
 7. Touch **STORE** . The fax/modem is now set up for faxing.

Setting up the Fax Directory

Any file in the Tel or User File application can be designated as the FAX directory. The designated file can be used normally in its application, while the names and fax numbers in the file's entries are listed in a directory used by the fax function. The directory opens automatically each time you want to send a fax, allowing you to select the recipient from the names shown.

1. Press **MENU** and touch **PERIPHERALS**.
2. Select GLOBAL SETTINGS, then SET FAX OPTIONS, and finally SET UP FAX DIRECTORY.

Touch the file you wish to serve as your FAX directory.

FILE to access for FAX Directory	NAME FIELD	OTHER FIELD	FAX NUMBER FIELD
TEL1 TEL2 TEL3	USER1 USER2 USER3	1	3

Touch here and enter the field number corresponding to the NAME FIELD in the Tel or User File application (see p. 67 and p. 134 for more information about fields and their configuration). The field's contents are printed on the fax cover sheet as the recipient's name.

Touch here and enter the number of the field containing information such as position or company name that you want to appear on the coversheet.

Touch here and enter the number of the field containing the fax number, which is used in dialling when sending a fax (see p. 136 about how to set up a fax number field).

3. Set up the directory and touch **STORE** when finished.
 - To use data on a RAM card in the FAX directory, touch **CARD** in SET UP FAX DIRECTORY display to toggle to the card directory.



When faxing, you can dial manually without using the FAX directory. See "Sending a fax" later in this chapter.

Setting up your personal information for cover sheets & page header.

You will need to enter your name and phone number as you want them to appear on the top of each faxed page and on the cover sheet (if you decide to use one when faxing).

To set this information:

1. Press **MENU**, touch **PERIPHERALS**, and then select **GLOBAL SETTINGS**.
2. Touch **SET FAX OPTIONS** and then select **SET UP COVER SHEET**.

Touch here and type in any information you would like to appear in the FROM section of your cover sheet (for example, your name and company). Use **ENTER** to enter text on multiple lines. The first 4 lines are used on your cover sheet.

Touch here and enter your name and fax or phone number. Use **ENTER** to move to the second line. This information will appear on the top of each fax page.

3. Enter the information and touch **STORE** when finished.

Below is a sample cover sheet:

The date and time are copied from the unit's clock at the time of faxing.

The first 17 characters from line one of the NAME & No. for Header field.

The first 17 characters from line two of the NAME & No. for Header field.

Total no. of pages (shown only when sending a **Notebook** entry).



Before faxing, be sure to set the correct date and time in the unit (see chapter 1). You are required by law to insure that your name, telephone, or fax number, and time and date appear on the top of each faxed page (see

the inside front cover of this manual). The unit will insert this information automatically if it has been entered correctly.

Sending a fax (Automatic dialing)

You can fax a single Notebook or Scrapbook entry or you can fax an entire Filer folder. With the unit connected to the CE-FM1 fax/modem, and the unit turned on.

1. **From the Notebook:** Select an entry and touch **FAX SEND**.
 - From the Scrapbook:** Select an entry, press **MENU**, touch **VIEWS**, and select **FAX SEND**.
 - From the Filer:** Select a folder and touch **FAX SEND**.
2. From the Fax directory display, select a recipient and then touch **CALL**.
 - If you need to access a different directory, touch **CHANGE FAX DIRECTORY**, which opens the **SET UP FAX DIRECTORY DISPLAY**.
 - If you want to use a cover sheet, check **USE A COVER SHEET** and see the section on **Using a Cover sheet** later in this chapter.



Be sure to enter hyphens in the appropriate places in the fax number.

3. Make any necessary adjustments to the number:

Confirmation box. The number being dialled is displayed here.

Touch here if you want the unit to skip the area code when dialling (you are faxing a local number).

Touch here if you want the unit to dial a 1 before dialling the complete number (you are making a long distance call within the US).

4. Touch **START**.
The unit will display the fax number in the confirmation box (with any changes you may have made) and dial it. Once connected, it will send the fax automatically.



The unit does not have an automatic redial function when faxing. If the line is busy, “A line error has occurred!” will be displayed and faxing will be terminated.

Making other changes to the number

In step 3 above, you may want to make other changes to the fax number or type in another number altogether. To do so, simply enter any number from the keypad (or keyboard) and then touch **START**. You can also use speed buttons to use predefined numbers or to add credit card codes in the dialing sequence (see Speed buttons later in this chapter).

First repeat steps 1 and 2 above.

For example, you may want to add a “9” prefix before the number to get an outside line from within a company phone system. To add a “9” to the number,

3. Touch **9** on the touch pad (or on the keyboard). The number will appear in the top line of the display.
4. Press **,** on the keyboard. This adds a one-half second dialing pause.
5. Touch the displayed fax number. It will be added to the confirmation box after the “9,“. Note the fax number is adjusted if LOCAL or USE 1 + NUMBER is checked. Note that the LOCAL selection may not work correctly in some areas.
6. Touch **START**. The unit will now dial the number in the confirmation box and begin faxing automatically.

8

Sending a fax (Manual dialing)

In some instances you may want to dial a fax number manually, allowing you to hear the dial tone and other dialing sounds. Dialing manually with the unit is just like pressing SPEAKER on a conventional fax machine and then dialing. Note that you must have a connection with the receiving FAX machine and hear a fax tone before touching **START**.

To send a FAX manually,

1. **From the Notebook:** Select an entry and touch **FAX SEND**.
From the Scrapbook: Select an entry, press **MENU**, touch **VIEWS**, and select FAX SEND.
From the Filer: Select a folder and touch **FAX SEND**.
2. From the Fax directory, simply touch **CALL**. There is no need to select a recipient unless you select a cover sheet and you wish the recipient's information to appear on it (see using a cover sheet later in this chapter).
3. Touch **MANUAL**. The **MANUAL** button changes to **HANG-UP**. You should hear a dial tone within a few seconds.

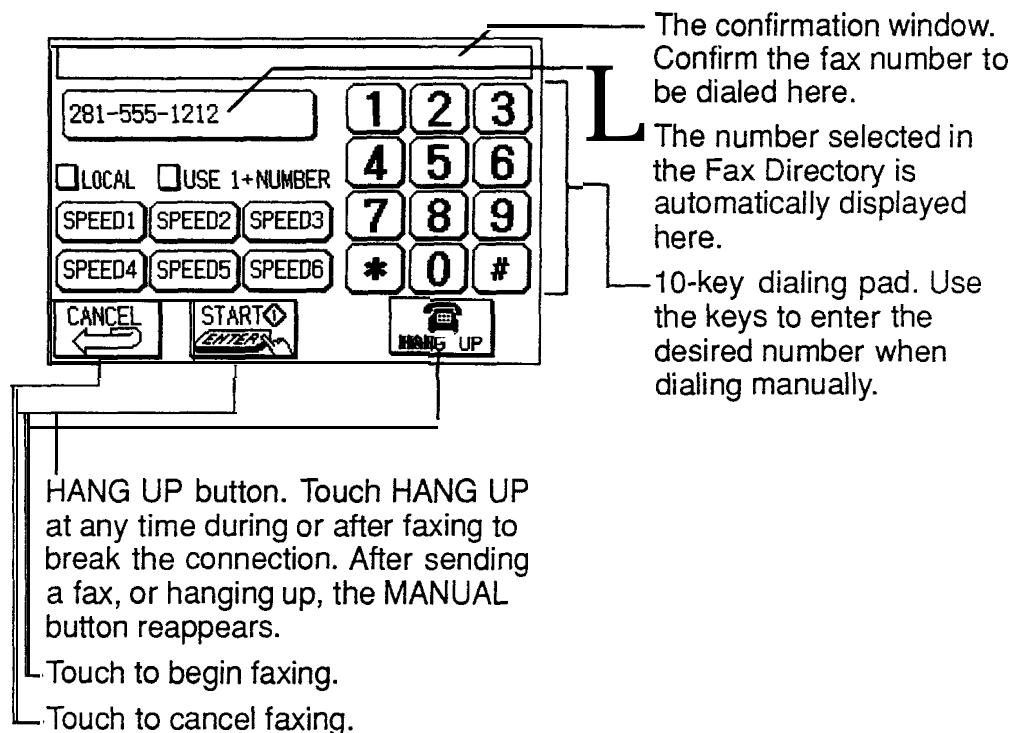

4. Now dial normally by touching the number pad on the screen.
5. Touch **START**.

 You can use speed buttons when dialing manually.

- ➔ You may find that, in some cases, the fax number dials too quickly for a connection to be made. You can slow down the dialing sequence by inserting a comma (for example, after an area code) in the fax number field of the entry you want to send. Each comma inserts a one-half second dialing pause. To do this, open the application for the entry, and insert a comma at the appropriate place(s) in the fax number field using the usual entry procedures (see the Tel or User File sections for more information).
- ☞ Touch **CANCEL** at any time before faxing to return to the Fax Directory.
- ☞ Touch **HANG-UP** or press (ON) to terminate fax sending at any time.
- ☞ When faxing Notebook entries, the following conditions apply:
 - Margin settings on the received fax may not match those in the Notebook entry.
 - A preset letter font is used for faxing. You cannot select between pica and elite, or change the font pitch.
 - If legal size paper is selected in the Notebook entry, and the receiving fax machine has roll-type paper, a legal-size page will be printed, if the receiving fax machine uses separate single sheets, the legal size page will be printed across two single pages.

Using a Cover sheet

1. **From the Notebook:** Select an entry and touch **FAX SEND** .
From the Scrapbook: Select an entry, press **MENU** , touch **VIEWS** , and select FAX SEND.
From the Filer: Select a folder and touch **FAX SEND** .
2. Touch the USE A COVER SHEET box and then **CALL** . The Cover Sheet Preview display appears.

COVERSHEET PREVIEW		CALL	CANCEL
Total 3 Pages		ENTER	←
TO:	Davis, Frank		
	11:44P		
No.:	281-555-1212		
FROM:	Smith, John		
	101 4th Ave, New York,		
	N.Y. 07250		

3. The name, position-company name and fax number of the fax recipient are entered automatically when you set up the Fax Directory (See p. 229). This information will appear on the faxed cover sheet. You can edit this information by touching the field and using the keyboard if you wish.
4. Touch **CALL**. The dialing screen appears. Use automatic or manual dialing procedures, as described (See p. 231 and p. 232).
5. Touch **START**. The faxing display appears. A flashing asterisk on the display indicates that faxing is under way. The number of pages sent and remaining to send are shown in the upper right.



The maximum size of each field in the Cover Sheet Preview is:

TO: 3 lines by 27 characters

No.: 1 line by 27 characters

FROM: 4 lines by 27 characters

Speed buttons

Any frequently dialed number can be assigned to one of the six Speed buttons shown in the Dialling Screen. Touching the Speed button for that number will then dial it automatically. This can significantly reduce your dialing time. Speed button numbers are set up via the **PERIPHERALS** menu.

1. Press **MENU** and touch **PERIPHERALS** to open the **PERIPHERALS** menu.
 - In faxing mode, select SET UP SPEED BUTTONS from modify menu, then proceed to step 4.

2. Select GLOBAL SETTINGS.
3. Touch SET FAX OPTIONS and then touch SET UP SPEED BUTTONS. The display appears.

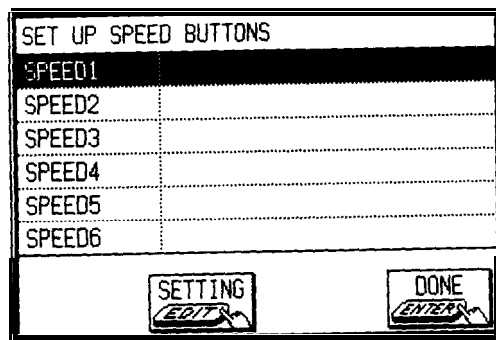

4. Touch **SETTING** and enter a title and a fax number for each button you want to use.
5. Touch **DONE**.

Editing Speed button information

In SET UP SPEED BUTTONS display,

1. Select the title or fax number to be edited.
2. Press **EDIT**.
3. Make your changes in the editing window that appears.
4. Touch **STORE**.

Making a Speed button secret

You can protect the security of Speed button numbers by assigning them the secret status. Secret numbers are displayed as asterisks in the confirmation window, so the actual digits cannot be seen.

1. After assigning the number to a Speed button (see above), press **MENU** and touch **MODIFY**. The **MODIFY** menu opens.
2. Touch SET SECRET STATUS, select SECRET, and touch **STORE**. The number has now been assigned the secret status, then the number field become blank.

To assign the number a non-secret status, follow the above procedure and select NOT SECRET in step 2.

To edit the secret number, you have to unlock the unit first.

Enhancing Capabilities Using a RAM Card

A RAM card can be used with your unit in any of three ways:

- to expand memory capacity,
- as a means of sharing data with other 8900/9000 Series units, or of making use of data from **7000** or 8000 Series Organizers,
- to backup the unit's data.

Before installing the RAM card, you must set the **Secret** function in your unit to match the **Secret** function setting in the RAM card. If the RAM card has never been used before and you will be initializing it, or if it has already been initialized but has never been used with a password, you *must* delete any password from your unit before installing the card. If the RAM card has been used with a password-whether in your unit or another-the password in the card and your unit *must* match.

- ➔ For a full explanation of the **Secret** function and using passwords, see p. 282.
- ➔ For a full explanation of how to install a RAM card, see p. **221**.

 If you install a RAM card that has been used in a model other than the 8900/9000 Series in this unit and then turn the power on, a message will appear indicating that the format of the card is different from that of the unit. To use such a RAM card in this unit, all data in the card must be erased and the card must be initialized. Perform the following operations,

- ➔ You can also use RAM card data created on other models in this unit. See p. 241.
1. With the card installed in the unit, turn the unit on. Touch **I SEE** when the card format message appears.
 2. Press the RESET switch while pressing **ON**.
A message will appear asking if you want to clear the

unit's memory.

3. Touch **NO**. (Be careful not to touch **YES** here or you will lose all the data in the unit.)

A message will appear asking if you want to clear the card memory.

4. Touch **YES**.

All data on the card will be deleted and the card can now be used in your unit.

Memory expansion

The RAM card provides extra memory in the unit. While a RAM card does not expand the amount of main memory in the unit, it does add an auxiliary memory that can be easily accessed.

To use a RAM card, install the card, select an application, and press **CARD**. The symbol **CARD** appears at the top of the display indicating that the card memory is now selected. All operations are the same as when using the main memory, but the RAM card gives you, for example, three more files in the **Tel** application, one more drawer of folders in the **Filer** application, etc. (See your RAM card manual for capacity and specifications.)



- When a RAM card is installed, pressing **SEARCH** displays a **SEARCH** window including buttons to select both card and unit memory.
- In the **Filer** application, you can collect entries only in the memory you are currently using.
- The unit keeps track of which memory (main or card) was last used for each application. So, for example, if you select the **To Do** application and it was last used with card memory, the unit will switch automatically to card memory. If you then select another application that was last used with main memory, the unit will switch back automatically to main memory.



You can also store data on a RAM card by copying all data from the main unit's memory. This is called "backing up." Unnecessary data can then be deleted from the

card. See the following section for more information.

Backing up data to a RAM card

“Backing up” means making a separate copy of your data which can be kept in a safe place. This is the simplest and easiest form of insurance against losing valuable information.



When you backup to a RAM card, any information already on that card will be lost.

With a RAM card installed in the unit:

1. Make sure that the unit is unlocked (see p. 282). Press **MENU** and touch **PERIPHERALS** to open the **PERIPHERALS** menu.

2. Select RAM CARD TRANSFER.

3. Select MAIN → CARD (REPLACE).

A warning message appears asking if you want to permanently delete all data on the RAM card.

4. Touch **YES** (or **NO** to cancel the operation).

The entries are backed up. (Backup time depends on how much data is stored in the unit.)



- Backing up data to a RAM card copies your information onto the card. The data in your unit's main memory is not deleted.
- Data copied to a RAM card can be edited, deleted and worked with in the same way as data on the unit.
- You **MUST** unlock the unit before attempting RAM card transfers. If the unit is locked, the RAM CARD TRANSFER function be disabled.

Restoring data from a RAM card

“Restoring” data means copying data that was backed up to a RAM card back to the unit. To restore data, you use nearly the same procedure as for backing up (above), but in step 3 be sure to select CARD → MAIN (REPLACE), which copies data from the RAM card to the unit.

- ☞ When you restore data from a RAM card, any existing information in the unit will be lost.

Sharing data with another unit

Data and entries can be transferred easily and quickly between 8900/9000 Series units simply by swapping a RAM card between them. You can receive data from 7000 and 8000 Series models (you cannot, however, move data from your unit to these models), and then work with that data, but it must first be converted into the format used on your unit.

- ☞
 - Applications may not match on different unit models. Entries can only be transferred if there is a matching application on the receiving unit.
 - Memo entries from the 7000 and 8000 Series Organizers will be transferred to the **Notebook**, and Business Card entries from the 8000 Series will be transferred to USER FILE 1 in the **User File** application. All other matching applications will share the same name.
 - A RAM card used with a password in a 7000 or 8000 Series Organizer cannot be used with this unit. You must first delete the password from the card in the other unit.
 - There are a few other restrictions for receiving 7000/8000 Series data via a RAM card. These are the same as for receiving data directly from a 7000/8000 Series Organizer. See p. 274.

To use data from 7000/8000 Series Organizers:

1. Turn the unit off and install the RAM card that has 7000/8000 Series data stored on it.
2. Turn on the unit.

A message appears.

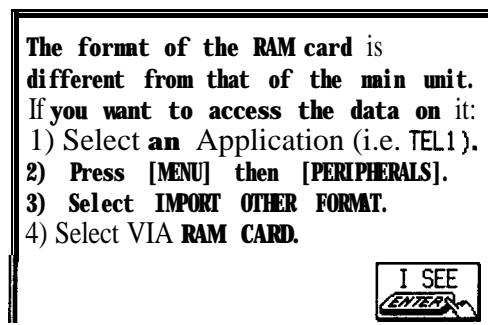

3. Touch **I SEE** .
4. Select the application on the unit that you want to append the card's entries to by pressing its application key.
In the **Tel** and **User File** applications, also select the file.
To receive Business Card entries, make sure that **USER FILE 1** is selected.
Only the entries in the corresponding application or file on the 7000/8000 Series card will be copied.
5. Press **(MENU)** and touch **PERIPHERALS** to open the **PERIPHERALS** menu.
6. Select **IMPORT OTHER FORMAT**
A submenu opens.
7. Select **VIA RAM CARD**.
A message appears.

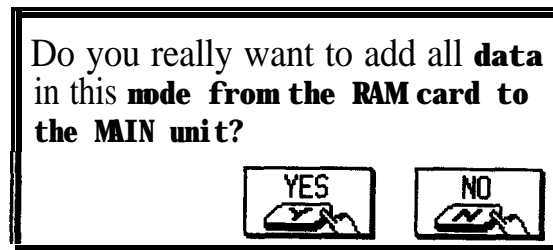

8. Touch **YES** .
All entries of the selected application on the RAM card are copied to your unit and appended to any existing data in the application.

Repeat the steps above for all applications you want to import to your unit.

Transferring Data

There are several ways to transfer information, entire entries, or files between the unit and other information processing devices, including personal computers and other SHARP Organizers. In this way, you can backup

your information to guard against losing it, or copy information so that you or someone else can work with it on another device. A summary of transfer devices, transferable data, and tasks a transfer device is most suited to is provided in the table below.

Transfer device	Transferable data and direction of transfer (→: send, ←: receive)	Peripherals required	Most suitable task
RAM card (See p. 238)	All entries → ←		The quickest and most convenient way to backup (copy) data.
	Entire files/applications ←	RAM card from other Organizer models	The easiest way to transfer data from other Organizer models.
Another 8900/9000 Series unit (See p. 244)	Single entry, entire file/applications, Filer folders — —	None for infrared transfers; CE-315L for cable transfers	Exchanging data with other 8900/9000 Series units.
600, 5000, 7000 and 8000 Series Organizers (See p. 249)	Entire applications —	CE-315L	Transferring data from other Organizer models.
Personal computer (See p. 251)	Single entry, entire files/applications → ←	Software* + CE-IR2 or compatible Organizer link cables or CE-137T + Null modem cable	Backup, archiving, printing and emulation of the Organizer on a computer.

Transfer device	Transferable data and direction of transfer (→: send, ←: receive)	Peripherals required	Most suitable task
Remote fax machines (See p. 227)	Single Notebook and Scrapbook entries. Filer Folders →	CE-137T level converter and CE-FM1 fax/modem	Sending a fax (with or without cover page) of information stored on the unit.
Remote computers, public E-mail services (See p. 253)	Single Notebook entry, Filer folders → ←	CE-137T level converter and CE-FM1 fax/modem, or Hayes-compatible modem and cable	Exchanging data with remote computers or units, accessing various information via E-mail services.

* Depending upon the SHARP or third party software you are using, features and capabilities may vary.



- The auto power off function (see p. 51) is disabled in all transfer modes.
- When transferring data from other models, only entries in a mode (application) supported on the 8900/9000 Series unit can be sent. However, the Memo mode on other models corresponds to the **Notebook** application on the 8900/9000 Series unit, and the Business Card mode on the 8000 Series to USER FILE 1 in the **User File** application.

Transfer between 8900/9000 Series units

Data can be transferred directly between two 8900/9000 Series units via the infrared port. Single entries or all the entries in an application can be transferred in the **Schedule, To Do, Ann, Notebook, Outline,** and **Scrapbook** applications; and single entries or all the entries in a file can be transferred in the **Tel** and **User File** applications. Using the **Filer**, a group of entries from different applications can also be transferred.

The transfer procedure differs according to whether single entries, complete files, or folders are to be transferred.



- Press **ON** at any time to cancel a transfer.
- After a transfer, the display returns to the application being used before the transfer procedure was begun.
- Received data is stored and appended to the existing data of the selected application. After a transfer with **GET** and **SEND**, the data is also automatically assigned to the IN folder of the **Filer** application so that you can check it after transfer. It is therefore recommended that you always keep the IN folder empty. (See p. 204).
- If a RAM card is installed, applications on it can also be selected to transfer data to or from. See p. 251.
- In the **Tel** or **User File** applications, the contents of fields that are not set up in the receiving file cannot be transferred. Also, if the type of a field (text or picture) is different in the two units, it cannot be transferred.
- No peripheral devices are required to transfer data via the infrared port. However, infrared transfers are easily affected by ambient conditions which may interfere with this type of transfer. Connecting the two units with the optional CE-315L cable will ensure a more reliable transfer. See p. 248.

Initial set-up

There is no special hardware set-up involved in infrared transfers. And if you only want to transfer single entries or single **Filer** folders using **GET** and **SEND**, there is no software set-up either: all you have to do is set up the units properly (step 4 below). For all other infrared transfers, follow the procedure below.

1. Press **MENU** and touch **PERIPHERALS** (or, on some models, press **2nd** **PERIPHERALS**) on both units to open the **PERIPHERALS** menu.
2. Select **GLOBAL SETTINGS** (only IQ-8900/8920) and then select **SET UNIT TO UNIT PATH**.
A submenu opens.
3. Select **VIA INFRARED PORT**.

4. Place the two units so that their infrared ports are in line and within 80 cm of each other.

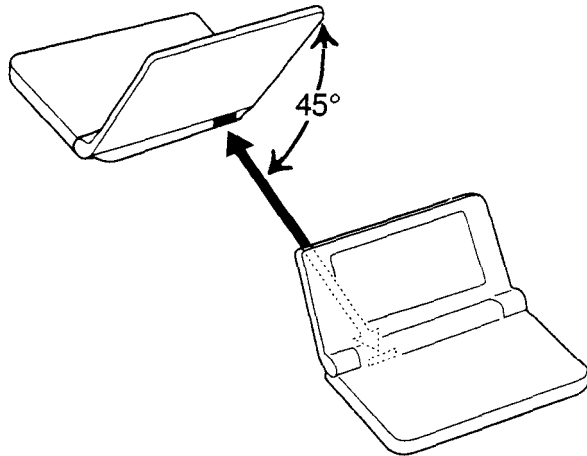

- Do not leave the unit cover more than three-quarters open during transfer or it will break the infrared transfer.
- When transferring entire applications or files, or entries marked as secret, both units must be unlocked (see p. 282).
- Although infrared transfer requires no special hardware, it is easily affected by ambient conditions and other factors such as external light, undercharged batteries, large transfer distance, transfer angle, etc. As a result, while infrared transfer is in itself quite easy, there is considerable scope for errors, failure to transfer data and incomplete data transfer (missing data). It is therefore recommended that you confirm the received data after an infrared transfer.
- Avoid direct sunlight.
- Keep the infrared port clean with a soft, dry cloth. Dust on the port will make transfer difficult.

Transferring single entries

Single entries can be transferred in all applications.

1. Turn on both units.
2. On the sending unit, select the entry you want to send in the Index mode or display it in the View mode.

3. Press **GET** on the receiving unit.
4. Press **SEND** on the sending unit.

The selected entry is transferred and appended to data in the appropriate application.

- ★ You can also transfer single entries using UNIT TO UNIT TRANSFER in the **PERIPHERALS** menu. In step 3, after opening the same application as on the sending unit, select GET DATA (APPEND) on the receiving unit. Then, in step 4, select SEND SELECTED ENTRY on the sending unit.

Transferring all entries in an application

With the exception of the **Tel** and **User File** applications, all entries in all applications can be transferred. In the **Tel** and **User File**, all entries in individual files can be transferred.

1. Turn on both unit.
2. Open the same application on each.
If **you** are in the **Tel** or **User File** application, also select the file.
3. On the receiving unit,
 - Press **MENU** and touch **PERIPHERALS**.
 - Select UNIT TO UNIT TRANSFER.

A submenu opens.

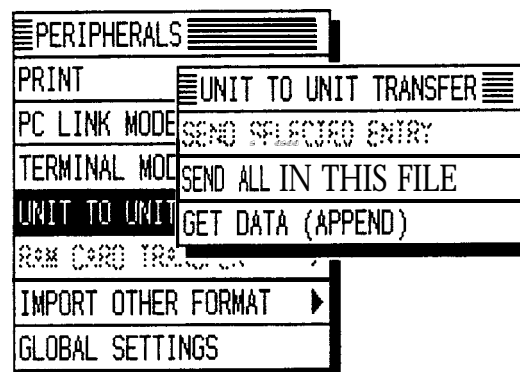

- Select GET DATA (APPEND).

4. On the sending unit,
 - Press **MENU** and touch **PERIPHERALS** .
 - Select UNIT TO UNIT TRANSFER.

A submenu opens.

- Select SEND ALL IN THIS MODE, or SEND ALL IN THIS FILE in the **Tel** and **User File** applications.

All entries in the application or in the selected file are transferred.

-  In the **Schedule**, **Tel** and **User File** applications, if the **Filter** function is turned on, only the filtered entries will be transferred.

Transferring a Filer folder

1. Turn on both units.
2. On the sending unit, select the folder you want to send in the Filer Drawer.
3. Press **GET** on the receiving unit.
4. Press **SEND** on the sending unit.

The transferred entries are stored in the appropriate applications and are also automatically assigned to the IN folder on the receiving unit.

-  • After completing the transfer, you should move the data from the IN folder on the receiving unit to another folder.

-  You can also transfer folders using UNIT TO UNIT TRANSFER in the **PERIPHERALS** menu. In step 3, after opening the **Filer** application, select GET DATA (ADD TO INBOX) on the receiving unit. Then, in step 4, select SEND SELECTED FOLDER.

Cable transfer

For more reliable data transfer, you can connect two 8900/9000 Series units using the optional CE-315L cable.

To set up the units with the cable,

1. Turn off both units.

2. Open the cover of the 15-pin cable jack on each unit.
3. Plug one end of the cable into the cable jack on each unit.

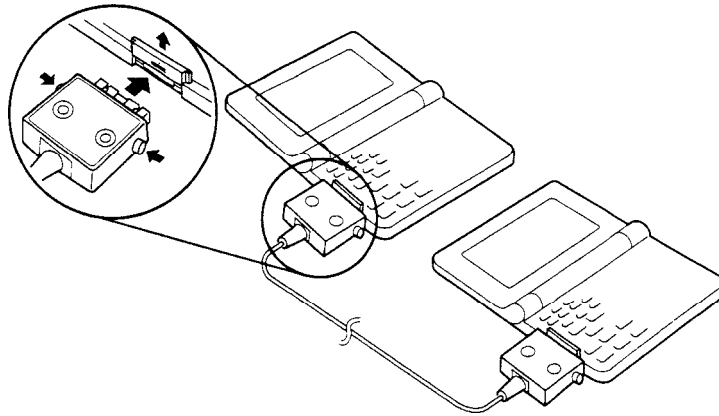

4. Turn on both units.
Press **MENU** and touch **PERIPHERALS** .
5. Select GLOBAL SETTINGS and SET UNIT TO UNIT PATH.
6. Select VIA DIRECT CABLE.

- ☞ • To conserve battery power, disconnect the cable as soon as a transfer is completed.
 - **GET** and **SEND** do not work in cable transfers. You must use the **PERIPHERALS** menu to transfer data by cable. Pressing these keys always initiates infrared transfer regardless of the selection for SET UNIT TO UNIT PATH or of whether the cable is connected or not.
7. Transfer data following the same menu procedures as for the infrared transfer shown on pages 246 to 248.

Receiving data from units other than the 89001 9000 Series

To connect the two units, you need the optional CE-315L cable.

Initial set-up

1. Turn off both units.
2. Open the cover of the 15-pin cable jack on each unit.
3. Plug one end of the cable into the cable jack on each unit.

- ☞ To conserve battery power, disconnect the cable as soon as a transfer is completed.

Transferring data

1. Turn on both units.
2. On the 8900/9000 Series unit, open the application in which you want to receive the data.
Only data corresponding to the application selected on the receiving unit will be transferred (regardless of the application selected on the sending unit).
In the **Tel** and **User File** applications, select the destination file. To receive Business Card entries, make sure that USER FILE 1 is selected.
3. On the 9000 Series unit.
 - Press (MENU) and touch **PERIPHERALS** (or, on some models, press (2nd) **PERIPHERALS**).
 - Select IMPORT OTHER FORMAT.A submenu opens.
 - Select VIA DIRECT CABLE.A message appears.

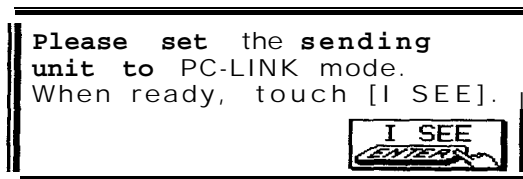

4. On the sending unit,
 - Press (2nd) (or (SHIFT) on some models) (OPTION) to open the **Option** menu.
 - Select PC LINK.
5. On the 8900/9000 Series unit, touch **I SEE** to receive all entries in the selected application on the other unit.

Repeat the steps above for all applications you want to import to your Organizer.



- Memo entries from units other than the 8900/9000 Series will be transferred to the **Notebook**, and Business Card entries will be transferred to USER FILE 1 in the **User File** application. All other matching applications will share the same name.
- There are a few other restrictions. See p. 274.

- You can also transfer data from units that are not 8900/9000 Series using a RAM card or via the PC-Link mode. See p. 241 and p. 251, respectively.

Transferring data to/from a RAM card application

To transfer data between two units, you can also select an application on the RAM card to transfer data either to or from.

Simply press **CARD** to select the card memory in the application in which you want to send or receive the data, then press **GET** or **SEND**, or open the **PERIPHERALS** menu.

To receive single entries using **GET** or **File** folders in the card memory by either infrared or cable transfer, first select the card memory using SET DATA DESTINATION in the **PERIPHERALS** menu on the receiving unit.

Exchanging Information with a Personal Computer

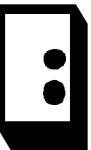

Using SHARP's optional Organizer Link software and cable package or certain third party software packages, you can exchange data with a personal computer. Certain software will allow you to exchange data with a personal computer via the unit's infrared port using the optional CE-IR2 wireless interface. This makes it possible, for example, to use the unit when outside your home or office, then later transfer the data you have entered on the unit to your desktop computer.

To set-up the unit for use with the Organizer Link:

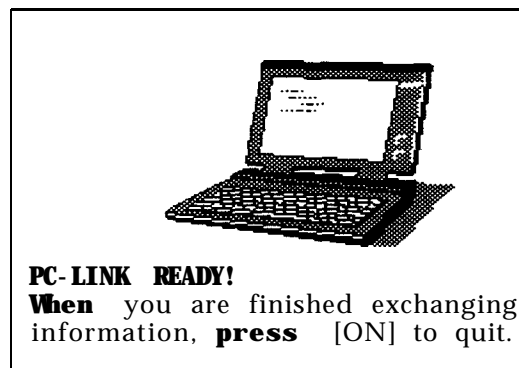

1. Make sure the unit is turned off.
2. • For infrared transfer, set up the unit with the CE-IR2 wireless interface. (See the CE-IR2 manual for details.)
 - For a cable transfer, connect the Organizer Link cable to the unit's 15-pin cable jack. (See the unit Link manual for details.)

3. Press [ON].
4. Press [MENU] and touch [PERIPHERALS].
5. Select GLOBAL SETTINGS.
6. Select SET PC LINK PATH.
7. Select VIA INFRARED PORT (for infrared transfer) or VIA DIRECT CABLE (for cable transfer).
8. Press [MENU], touch [PERIPHERALS], and select PC LINK MODE.



Your unit is now ready to transfer data. Consult the Organizer Link manual regarding subsequent transfer procedures.

Press (ON) at any time to exit the PC Link mode.

-  You can use the software developed for 7000/8000 Series Organizers. If you are doing this, select IMPORT OTHER FORMAT from the PERIPHERALS menu instead of PC LINK MODE in step 7 above. Then select VIA PC LINK. The above display will appear. This can also be used for transferring 7000/8000 Series data to your unit.
-  The Organizer Link is for transferring data to a computer in the same location as the unit. For a full explanation of how to transfer data to remote computers using telecommunications, see the "Terminal Mode" below.

Terminal Mode

The **Terminal** mode lets you use the telecommunications functions of the unit to link to a “remote” computer or system (one that is physically distant), including a computer bulletin board service (BBS) or an on-line information service such as CompuServe, and to transfer data via phone lines between the unit and a personal computer. The **Terminal** mode makes it possible, for example, to link your unit with your computer at home or at the office using ordinary telephone lines, or to download (receive) information from public or private subscription databases.

The **Terminal** mode is accessed through the **PERIPHERALS** menu. Once selected, it functions as any other application, with its own menu for carrying out commands and configuring the unit for telecommunications.

Hardware requirements

To transfer data in the **Terminal** mode, you will need the optional SHARP CE-FM1 FAX/MODEM and CE-137T LEVEL CONVERTER. If you already have a Hayes-compatible modem, you will need a SHARP CE-130T or CE-131T cable, -and a straight, male-to-male RS-232C cable to connect the modem to the unit. If you use the CE-131T cable, you will also need a null modem adapter. For an explanation of how to configure the null modem adapter, see the table below.

Null modem pin configuration

1	—	1
2	—	3
3	—	2
4	—	5
5	—	4
6, 8	—	20
7	—	7
20	—	6, 8



Using an incorrect cable may damage the cable, the modem, and/or the unit.

Connecting the modem

With the unit turned off, connect the modem to the unit's 15-pin cable jack as shown in the diagram below. (See your modem manual concerning how to connect the modem to the telephone line.)

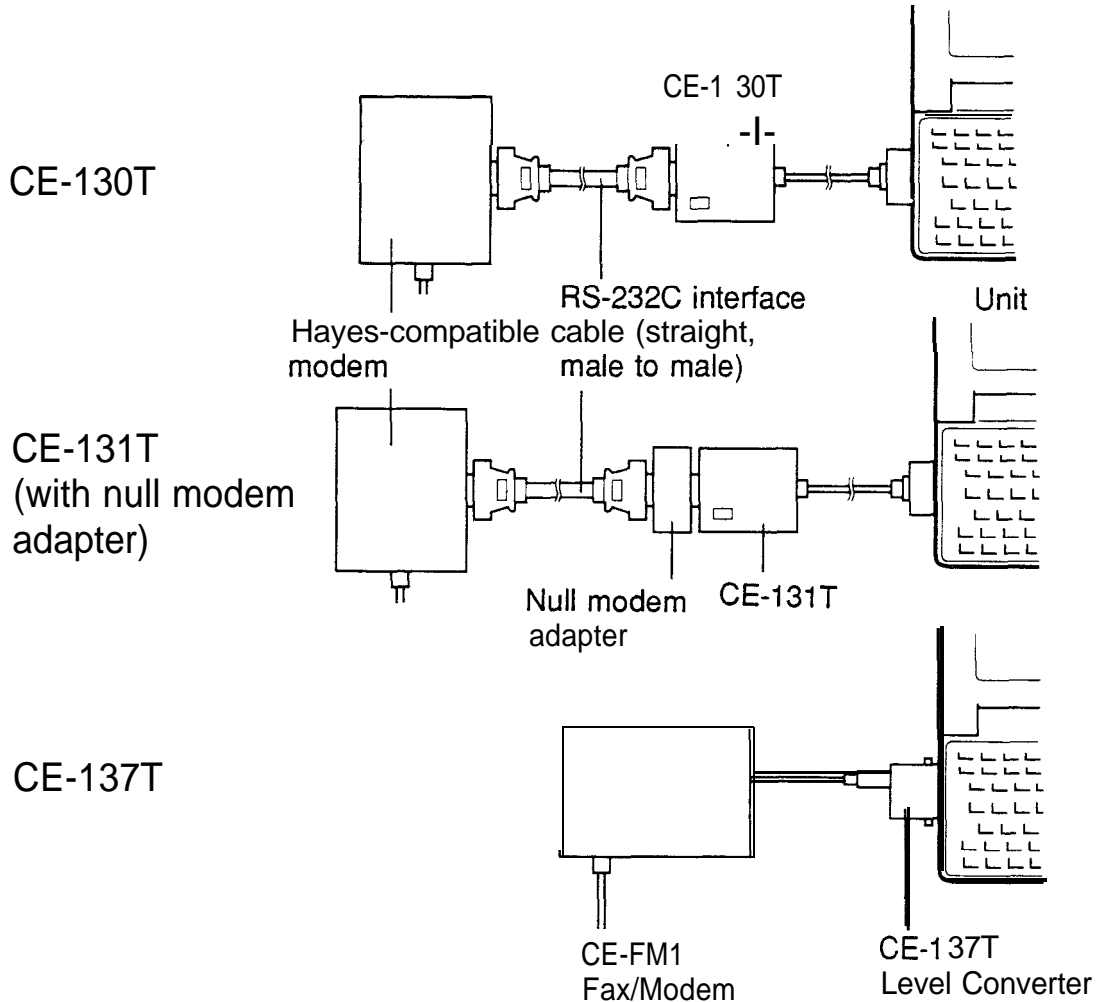

Opening the Terminal mode

With the modem connected,

1. Turn on the unit.
2. Press **MENU** and touch **PERIPHERALS** to open the **PERIPHERALS** menu.
3. Select **TERMINAL MODE**.
The Dialing Directory display opens.

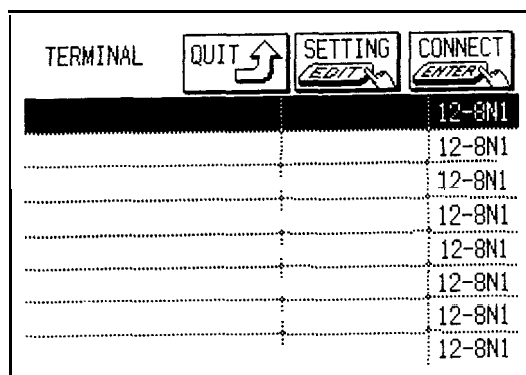

This is the initial display whenever the **Terminal** mode is selected. The display is blank now, but will show the entries you make for dialing access, similar to the Index mode in other applications.

Touch **QUIT** at any time to quit the **Terminal** mode.

Configuring the modem settings

In the **Terminal** mode,

1. Press **MENU**, touch **MODIFY**, and select MODEM SETTING.

The MODEM SETTING window opens.

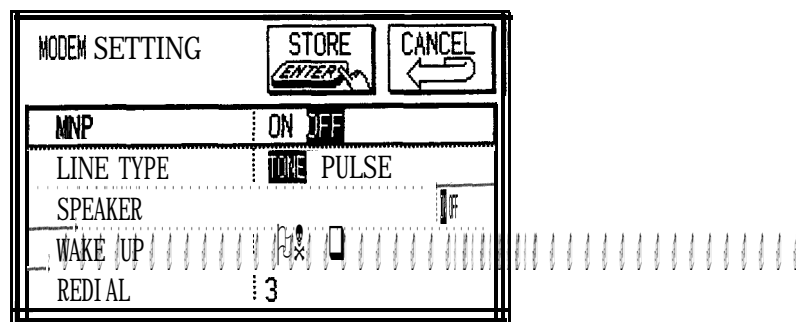

MNP

MNP (Microcorn Network Protocol) is an error-correction protocol implemented on many modems to help alleviate data errors caused by telephone line noise, etc. Set this to ON if your modem supports MNP.)

LINE TYPE

Telephone lines use either pulse or tone dialing. Pushbutton phones generally (but not always) use tone dialing, and rotary phones use pulse dialing. (For more information, see your modem manual.) Select your line type.

SPEAKER

If your modem has a built-in speaker, selecting ON lets you hear the dialing and connection tones. The speaker is turned off automatically after a connection is made.

WAKE UP





If set to ON, the unit will automatically turn on in the **Terminal** mode when called by a remote system unless ASK PASSWORD for the start-up display is set to ON. There are other hardware/software requirements for using this function. For more information, contact your local SHARP dealer.

REDIAL

This is the number of times the unit will redial a number if a connection is not made on the first attempt -if the number was busy or did not answer, for example. The number can be set in the range 0-99.

Of the settings above, the most important is the line type. Selecting an incorrect line type will not damage the modem or unit, but it will make it impossible to connect with a remote unit using the modem.

2. Touch any desired settings to select them.

★ Use  and  to move between fields, and  and  to select the desired settings.

3. Use the number keys to set REDIAL.

4. Touch  when you have finished with the settings.

Dialing settings

You set data transfer parameters for making dialing connections using the Setting display of the Dialing Directory. Each entry that you make can have its own settings, so that you can dial a number simply by selecting the desired entry.

In the **Terminal** mode,

1. Touch **SETTING** .

The Setting display appears. Scroll the display using **PREV** and **NEXT** to view all items.

TERMINAL			
NAME	:CompuServe		
NUMBER	:123-456-7890		
SPEED(bps)	300	1200	2400 4800 9600
PARITY	: NONE ODD EVEN		
DATA BITS	: 8	7	
STOP BITS	: 1	2	
Xon/Xoff	: ON		
LOCAL ECHO	: ON	OFF	

NAME

The name of the dialing entry.

NUMBER

The phone number to dial.

SPEED (bps)

Transmission speed, measured in bits per second (bps).

PARITY

A simple form of error checking during transmission.

DATA BITS

The size of each data character transmitted (which is measured in bits).

STOP BITS

Signals sent to indicate the end of each transmitted character.

Xon/Xoff

A form of “handshaking”-or flow control-between the modems.

LOCAL ECHO

Selects the display of characters when typing and connected to a remote terminal.

SHIFT IN/OUT

A switch to distinguish between accented and unaccented alphanumeric characters.



7F CODE CONVERSION

Selects whether a certain transmission code is interpreted as delete or backspace in 7-bit data transfer.

SEND LF AFTER CR

Affects formatting of lines on a remote terminal display.

RECEIVE LF AFTER CR

Affects formatting of lines on the unit's display.

DELAY TIME

The time the sending unit will wait for the receiving unit to read a line of sent text. Set any value from 0-99 tenths of a second.

EMULATION

Selects a type of computer "terminal" for the unit to emulate, which serves as a basic input/output device with some remote systems.

WRAP AROUND

Moves characters, to a new line when the end of a line is reached on the display.

TAB

Sets tab characters.

AUTO REPEAT

Repeats keys' functions when pressed and held.



CURSOR

Selects the appearance of the cursor.



CURSOR TRANSLATE (HORIZONTAL/VERTICAL)



Sets the number of characters or lines that  + cursor key operation moves the cursor.

Except for the transmission speed, the default settings on the unit should work fine for most modem communications (except that you have to enter the name and number). When settings do need to be changed, match the settings with those on the remote system being called.

Use  and  or touch the desired settings to select them.

2. Enter the name of the dialing entry.

3. Move to the NUMBER field.
4. Enter the telephone number (if it is not a local number, be sure to include the area code).
5. Move to the SPEED (bps) field.
Data transmission can only go as fast as the *slowest* of the two modems-your modem and the modem on the remote computer-being used. If one modem is capable of 2400 bps transmission speed and the other of 1200 bps, 1200 bps will have to be used.
6. Select the transmission speed.
7. Make any other necessary setting changes.
8. Press (2nd)  if you want to make it necessary to enter a password to access this entry (see p. 282). (Press   again to deselect it.)

TERMINAL			
NAME	:	-	
NUMBER	:		
SPEED (bps):	:	300	1200 2400 4800 9600
PARITY	:	NONE ODD EVEN	
DATA BITS	:	8	7
STOP BITS	:	1	2
Xon/Xof f	:	ON	OFF
LOCAL ECHO	:	ON	OFF

9. Touch  .
The settings for the dialing entry are now stored.

-  • If you are calling from a private PBX telephone system, you may have to dial 9 or some other number to get an outside line before dialing the number you want. Connection to an outside line on a PBX system usually takes a second or two, so if the modem immediately dials the number you want to call, part of the dialed number may be lost. To avoid this problem, put a comma (,) at the appropriate place(s) in the telephone number, which instructs the modem to pause when dialing.

- It is beyond the scope of this manual to explain all aspects of telecommunicating, including modem protocols, terminal emulation, etc. For further information, consult your modem manual or a good book on computer telecommunications.

Changing dialing entry settings

To change the settings in any dialing entry,

1. Select the entry from the Dialing Directory display.
 2. Touch **SETTING**.
- The entry appears in the Setting display.
3. Make any changes you would like.
 4. Touch **STORE**.



The new settings are stored.

Making a call

After you have set up the modem with the unit, and made an entry for the BBS, computer information service, or other remote computer you want to call, you are ready to telecommunicate.

1. Open the **Terminal** mode.

The Dialing Directory appears, showing the entry you have made. The field on the right indicates the four basic communications settings-transmission speed, data bits, parity, stop bits-that you selected for the entry.

TERMINAL	QUIT 	SETTING 	CONNECT 
CompuServe		123-456-789	12-8N1
John Smith		987-654-321	12-8N1
Brad DeMond		444-456-852	12-8N1
			12-8N1
			12-8N1
			12-8N1
			12-8N1
			12-8N1

2. Select the entry that you want to call.
 3. Touch **CONNECT**.
- The number is dialed. A message should appear

indicating that a connection is made with the modem on the other end of the line.

If the other modem answers, but no connection can be made due to a settings mismatch or another cause, or if a connection is made but “garbage” characters appear on the display, press **(ON)** to disconnect and try again. If you still have trouble connecting, see “Telecommunications troubleshooting” on p. 271.



- Line noise can generate “garbage” characters. If you can connect with a remote unit at 2400, 4800 or 9600 bps, but garbled characters appear on the screen, try making the connection using a slower transmission speed.
- If your telephone line has a “call waiting” feature, you may get data errors or garbage characters on the screen when someone tries to call you while you are connected to a remote computer. In some areas, you are able to temporarily disable this feature before linking up to the remote computer. Contact your telephone company for details.
- If you connect, but you do not see any characters on the display when you type, or you see double characters, change the local echo setting for the entry to ON or OFF, respectively (see p. 257).
- Unlock the unit before selecting a secret entry.

Hanging up

When you want to disconnect, you must “log off” from the remote computer. Do *not* simply unplug the modem or the telephone line connection. All BBSs and information databases have specific procedures for logging off, or hanging up. Follow those procedures, which will log you off automatically. After logging off, press **(ON)** on the unit to hang up. If for any reason, the auto log off procedure fails, or you are connected to another individual user, press **(ON)** at any time to end the call and return to the Dialing Directory display.

Receiving a call

In addition to making outgoing calls, it is also possible to receive calls from other modems by setting the unit to “auto answer” in the **Terminal** mode.

1. Open the **Terminal** mode.
The Dialing Directory appears.
2. Select a blank entry field and touch **SETTING** .
3. Enter the name of the expected caller, or some general name such as “Answer”. Leave the NUMBER field blank. Make the settings you would like to use to answer the incoming call (the speed setting may be be the only setting you need to change).
4. Touch **STORE** .
5. From the Dialing Directory display, select the entry that you just made.

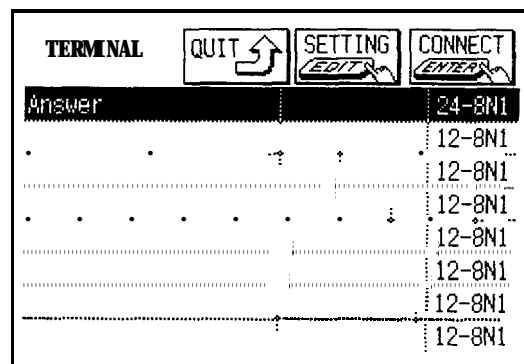

6. Touch **CONNECT** .
The on-line display appears.
7. Type *ATSO=1*.

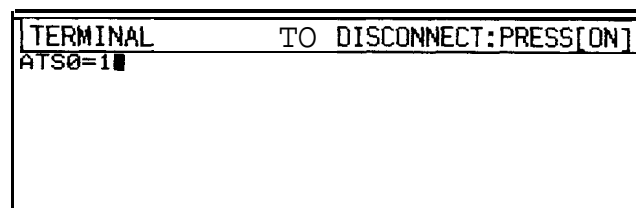

This sets the unit modem to automatically answer a call after one ring.

8. Press **ENTER**.

Any call will be automatically answered.

9. Press **(ON)** to turn off auto answer or to disconnect the call when finished.

☞ The unit's auto power off feature is disabled in the **Terminal** mode. Because power is drawn from the unit's batteries unless the optional external power supply is connected (see p. 273), auto answer should be set up just prior to the time a call is expected.

➔ For a full explanation of AT dialing commands (such as **ATS0=1**), consult your modem manual.

On-line operations (Terminal menus)

When you are connected to another computer via modem, anything you type on the keyboard is sent to the remote computer, and anything sent to you appears on your display.

Commands accessed from the **Terminal** menu add power and flexibility to the process. In the **Terminal** mode, press **(MENU)** and touch **IEWS** or **MODIFY**.



Selecting **FIXED** sets lines of text to "wrap" (breaks lines so they fit on the unit's display): **VIRTUAL** sets the unit's display as a window which can move across an 80 x 24 character full-size "virtual" display (see p. 271).

Changes the font size in the Terminal window display to large or small.

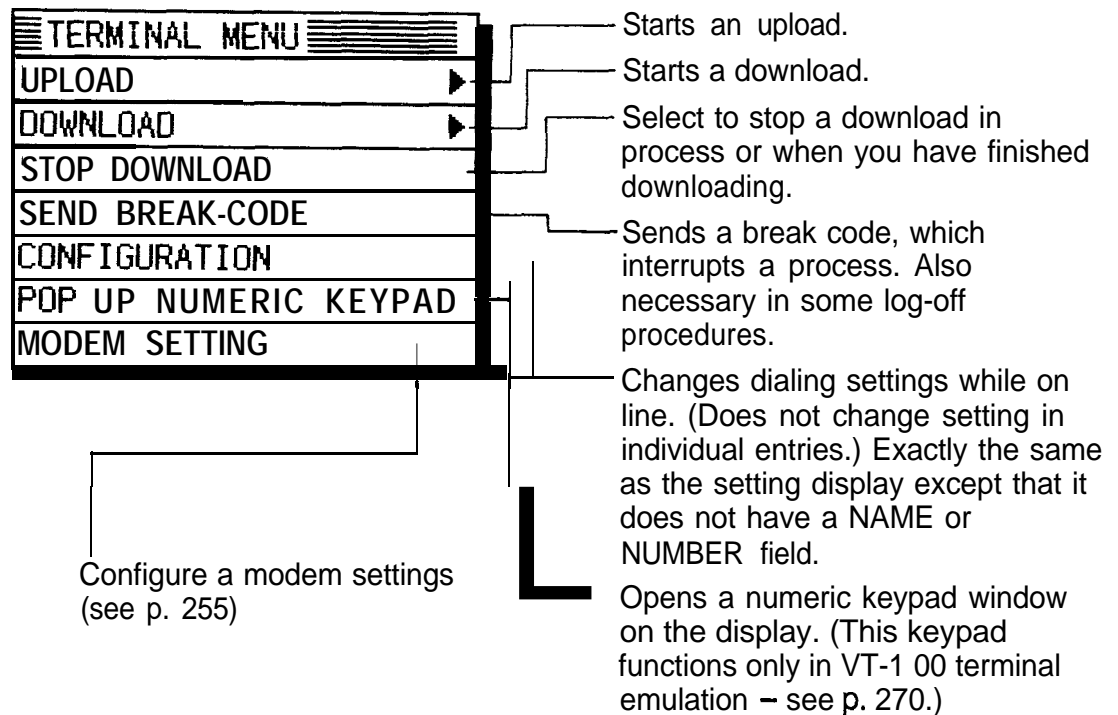

Press **ON** to leave the on-line mode.

- The **M-** key functions as a Control key while the unit is on-line. See p. 298 for the key combinations required to produce ASCII codes.
- To enter accented characters (é, ö, etc.) in on-line mode, use **SMBL**.
If you try to do this with SHIFT IN/OUT set to ON and DATA BIT to 7, the modem connection might be broken. If this occurs, press **ON** to leave the on-line mode and change SHIFT IN/OUT to OFF or DATA BIT to 8 in the dialing entry you are using, then try again.

Data transfer The unit can upload (send) entries from the **Notebook** application in either ASCII (text) format or using the XMODEM file transfer protocol. It can also send **Filer** folders using XMODEM. And it can download (receive) text and files using either ASCII or XMODEM. ASCII (the American Standard Code for Information Interchange) is an internationally recognized character set that makes it possible to transfer text between different kinds of computers, and for text typed on one computer to appear in the same form on a remote computer. No error

correction is implemented during an ASCII transfer. XMODEM is a file transfer protocol which implements error correction.

- ☞ The number of pages of data downloaded as a **Notebook** entry will be displayed as ** in the Index mode. Once this is downloaded, open the entry in the View or Edit mode to display the number correctly.

Uploading data

In the **Terminal** mode,

1. Access a remote computer or system by making or receiving a call.
2. Press (MENU), touch **MODIFY**, and select **UPLOAD**. The **UPLOAD** submenu appears.

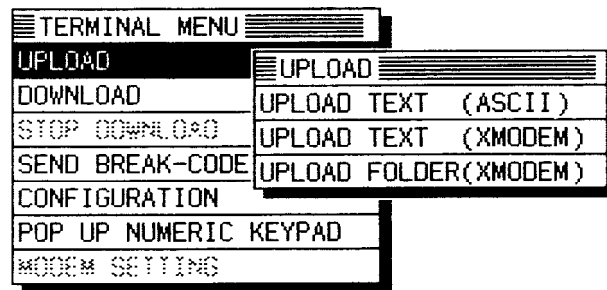

- For the **MODEM SETTING** (see p. 255.), when **MNP** is set to **ON** the **XMODEM** protocol is not available. Check **MNP** is set to **OFF**.
3. Select uploading text using **ASCII** or **XMODEM**, or uploading a folder using **XMODEM**.
 - If you selected an upload of text, a display similar to the Index mode appears, showing all the **Notebook** entries you have made. Select the entry containing the text you want to upload.
 - If you selected an upload of a folder, a display similar to the Filer Drawer opens. Select the folder you want to upload.
 4. Touch **UPLOAD** to upload your selection (or **CANCEL** to cancel it).

The selected entry or folder is uploaded.

Press (ON) at any time to cancel an upload.



Certain computer information services require specific log-on procedures before you can upload your data. Consult the service provider whose system you are using for details about this. You can automate the log-on procedures if you wish. See p. 268, "Auto log-on."

Downloading data

In the **Terminal** mode,

1. Access a remote computer or system by making or receiving a call.
2. Press **MENU** , touch **MODIFY** , and select **DOWNLOAD**.

The **DOWNLOAD** submenu appears.

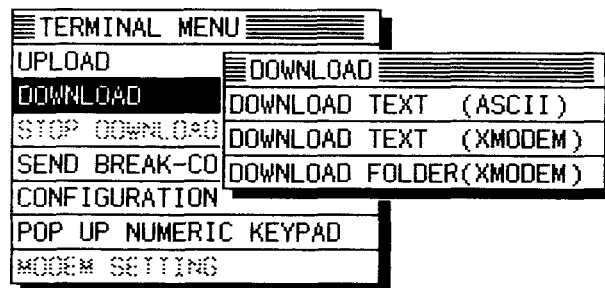

3. Select downloading text using ASCII or XMODEM, or downloading a folder using XMODEM.
 - If you select to download text by XMODEM, a text box opens at this time asking you to enter a name to store the entry under. Enter a name up to 20 characters long and touch **STORE** .

The selected entry or file is downloaded.

Press **ON** at any time to cancel a download.

4. When the download is completed, press **MENU** and

touch **MODIFY** .

5. Select STOP DOWNLOAD.

- If you selected to download text using ASCII, a text box opens at this time asking you to enter a name to store the entry under. Enter a name up to 20 characters long and touch **STORE** .



Certain computer information services require specific log-on procedures before you can download data. Consult the service provider whose system you are using for details about this. You can automate the log-on procedures if you wish. See p. 268, "Auto log-on."

Data transfer via CompuServe

It is easy to upload a folder from your unit to CompuServe, from where it can be downloaded by friends or associates whenever they want.

To upload a folder:

1. Access CompuServe using the normal log-on procedure.
2. Type GO *EASY* and press (**ENTER**) to go to the Electronic Mail Service.

The CompuServe Mail menu appears.

3. Press **3** to select UPLOAD a message.
4. Press **1** to select XMODEM (MODEM7) protocol.
5. Press **3** to select Binary.

The Transfer Type display appears.

6. Press **MENU** and touch **MODIFY** . Select UPLOAD, then select UPLOAD FOLDER (XMODEM).

The UPLOAD FOLDER window opens.

7. Select the folder you want to upload and touch **UPLOAD** .

The uploading process begins.

8. When you see the message, "File Transfer Completed! Press <CR>!", press **ENTER** .

The Send menu appears.

9. Press to select SEND.
10. Answer all prompts from CompuServe. Text in bold face indicates your answers.

Send to (Name or User ID) : 101115,3174 [ENTER]

Subject: **Product Info** [ENTER]

Your Name: **John Smith** [ENTER]

TO: 101115, 3174

From: John Smith

Subj: Product Info

Is this correct? (Y or N) y [ENTER]

Message sent to 101115, 3174

Press <CR>! [ENTER]

11. When the CompuServe Mail menu appears again, type bye and press to exit from CompuServe.

Auto log-on When you call a BBS or information database, **the log-on** procedure in which you enter your name, user number, and password to gain access to the system is probably the same each time you connect. You can automate this log-on procedure on the unit, making it faster (saving on telephone charges) and more convenient.

1. Open the **Terminal** mode.
The Dialing Directory appears.
2. Select the entry whose log-on procedure you want to automate.
3. Touch .
4. Touch .

The Auto Log-On display opens.

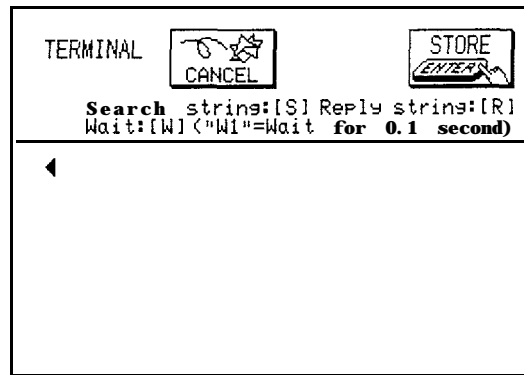

The auto log-on procedure is set up using the character strings (text) you would normally enter manually when logging on to the BBS or information database, in conjunction with these commands:

- Wn Wait *n* tenths of a second; for example, W2 would introduce a 0.2 second pause before the next step of a procedure.
- Sy Instructs the unit to search for a character string, sent from the BBS, for example, before moving to the next step of the log-on procedure. For example, SUSER ID: means wait for the text "USER ID:" to be received before continuing.
- Ry Instructs the unit to reply to a character string. For example, RJOHN JOHNSON means send the text "JOHN JOHNSON".
- ! Inserts a carriage return at the end of a character string. Carriage returns must be included at the end of lines in a log-on procedure to execute the procedure. ! is entered from unit using SMBL .

For example, if you are entering the log-on script to access CompuServe, you should see something like the screen below.

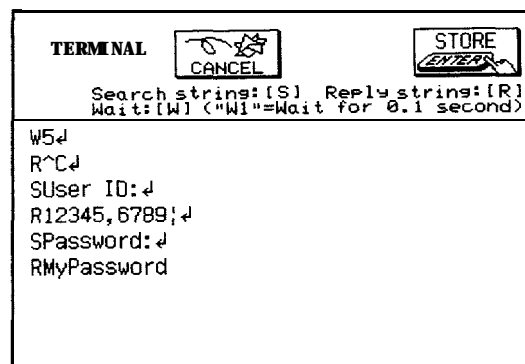

5. Enter your text.
 - Enter a ↵ after each command.
 - Search strings (entered using the S command) must be entered exactly as the system you're calling normally displays them. This means that you must enter upper- and lower-case letters in the auto log-on set-up exactly as those letters are shown when logging on manually. You may have to log onto a system manually at least once to copy the system's text strings in order to write a log-on procedure.
6. Touch **STORE** when you have finished to store the auto log-on text.
The Setting display appears.
7. Touch **STORE** again to store the entry.

Terminal emulation

There are two terminal emulation modes available on this unit: TTY (teletypewriter) and the more advanced VT-1 00 (VT stands for "video terminal"), which adds greater formatting controls and enhanced text handling and display. Select the one the remote computer/system which you are communicating with supports in the dialing entry.

You can then configure your terminal using the last six parameters in the entry (WRAP AROUND, TAB, AUTO REPEAT, CURSOR, CURSOR TRANSLATE (HORIZONTAL/VERTICAL)) according to your requirements.

While the unit's default settings will work fine for virtually all of your telecommunications, you may at some time find the need to change the emulation settings. (See p. 255.)

In VT-100 emulation mode, you can use a VT-1 00 numeric keypad, which can be used like the function keys on a standard computer, on the unit display. To use this in on-line mode,

1. Press **MENU**, touch **MODIFY**, and select POP UP NUMERIC KEYPAD.

The keypad appears.

2. Touch the keys on the keypad as required.
3. Touch **CANCEL** when you have finished with the keypad.

You can move the keypad to any place on the display. Touch the upper left-hand corner of the keypad and drag it to the place where you want it.



The **Terminal** menu cannot be accessed while-the keypad is displayed.

In addition, you can set the unit's display to **FIXED** or **VIRTUAL** using the menu. The unit's display is smaller than that of standard personal computers. When **VIRTUAL** is selected, text transferred from personal computers will be received in the same format as for a conventional remote terminal, and the unit's display will form a window on the text. Use the cursor keys to view text that is off the display. In the default setting, pressing  + cursor key will move the display window 40 characters horizontally or 8 lines vertically. If **FIXED** is selected, text that cannot fit on one line is moved to a new line.

Telecom- munications troubleshoot- ing

A list of common telecommunications problems and their solutions is provided below.

Problem:	Remote unit answers but no connection is made.
User message:	None, or NO CARRIER
Cause:	Settings mismatch between unit and remote unit. Excessive line noise.
Solution:	Check configuration (i.e. data speed, parity, data bits, stop bits) by selecting CONFIGURATION from the menu. Wait until line noise subsides and try again.

Problem: Remote unit answers but received characters are garbled.

User message: None.

Cause: Incorrect parity, data bits, or stop bits setting.

Excessive line noise.

Solution: Change parity, data bits and/or stop bits configuration settings.

Wait until line noise subsides-and try again.

Problem: Connection with remote unit terminates unexpectedly.

User message: None.

Cause: Surge of line noise, user error, etc.

Solution: Try again.

Problem: Dialing terminated unexpectedly.

User message: There was a problem during the dialing and auto dialing was terminated.

Cause: Incorrect phone number entered.
Incorrect line type selected (tone or pulse).

Modem not connected to phone line.

Solution: Press **ON** and check the phone number in the Dialing Directory.

Check the Line Type setting in the MODEM SETTING window.

Check that the modem is connected correctly to the unit and the telephone line.

Problem: Auto log-on fails.

User message: There was a problem during the auto log on. Please check out the auto log on commands.

Cause: Incorrect auto log-on settings.

Excessive line noise.

Solution: Check auto log-on settings. In particular, make sure the Sy and Ry character strings are correct and that ; is included

at the end of each line.
Wait until line noise subsides and try again.

About External Power Supply

When you connect the optional battery case CE-76BC to the unit, power can be supplied to the unit from the battery case. This helps minimize the use of the built-in operating batteries.

Connecting the battery case

1. Turn off the unit.
2. Plug the connector of the battery case into the external power supply pin (located on the right side of the keyboard).

- Batteries to be used

The following type of commercially available battery should be installed in the battery case:

Alkaline battery (LR03 or L30) x 6



Points to Remember When Using Peripherals

When using IC cards formatted for units other than 8900/9000 Series:

- Cards that are 3.4 mm thick, such as the IQ-780S and application cards of the IQ-775/IQ-776 format, cannot be used with this unit. Forcing these cards into the unit may cause damage.
- The IQ-709A, IQ-721 and IQ-8802 cards cannot be used with this unit.
- The following keys on this unit cannot be used (refer to the IC card operation manual as regards the other keys):

SCRAPBOOK **GET** **(SEND)** **NEW** **(DATE STAMP)**
(PRINT SCREEN) **WORD** **(CUT)** **(MENU)**

- The **SHIFT** key mentioned in IC card operation manuals is represented by the **(2nd)** key on this unit. Also, the **SHIFT** **FUNCTION** key operation is performed by pressing **(2nd)** then touching **(W)**, and the **SHIFT** **OPTION** operation by pressing **(2nd)** **(E)**. The displays for these operations might be different from those in the IC card manuals.
- To transfer data from a card, first select card memory, then press **(2nd)** **(E)**. To transfer data from the unit, press **(MENU)** then touch **PERIPHERALS** after selecting any application on the unit. To use the Memory Check or Data Deletion functions with a card, first select card memory then press **(2nd)** **(W)**.
- You cannot move the cursor by touching the IC card window and you cannot highlight text in it by dragging. Use the cursor keys to move the cursor.
- When using the IQ-702A, IQ-704B, IQ-711B, IQ-712B, IQ-715A, IQ-716B, IQ-8D01A, you can enter data in the clipboard by pressing **(2nd)** **(ENTER)**. However, you cannot enter data in the clipboard if the amount of free memory is small.
- The following cards can be used in conjunction with most of the unit's built-in applications. Press **(2nd)** **(CARD)** to access these dictionaries while using a

built-in application:

IQ-702A, IQ-704B, IQ-71 1 B, IQ-71 2B, IQ-71 5A,
IQ-71 6B, IQ-8DOI A

- TIME/DATE STAMP functions can be used by pressing **END** **TIME STAMP** **T** then enters the time, pressing **D** enters the date, and pressing **(SPACE)** enters both the time and the date.
- To enter special symbols, press **SMBL** to display the list of symbols and then enter the number corresponding to the symbol you want.
- When using the IQ-718M, IQ-8A02M or IQ-8C02, the **Clock** window may be displayed longer than usual. Press any key to close the window.
- When using the IQ-720, the **Calc** window cannot be opened.
- When using the IQ-701A, you cannot use **Calendar** application for a date entry.
- When using an IC card supporting multiple languages, including English, all messages are shown in English and cannot be switched to another language.

8

When using Organizer Link software designed for an unit other than the 8900/9000 Series:

- Data in applications that are not supported by the Organizer Link cannot be sent.
(USER FILE 1 corresponds to Business Card in the **8000** Series.)
- If you attempt to transfer an entry that contains more than a certain number of characters over the unit Link, only that number of characters will be transferred.
- The **Notebook** entry tab codes on your unit are converted carriage return characters J on a computer. If you restore **Notebook** entries back to your unit, these converted to carriage returns will not be changed back to tab codes, so the original layout will not be reproduced. Similarly, restored font styles will not be reproduced correctly.
- The first 20 characters, or the text on the first line, of a Memo entry received in the **Notebook** application are entered as the title and also appear in the text field.

When you restore the data back to the computer, the title and the first 20 characters are redundant.

- The names and contents of free fields in the **Tel** application cannot be sent over a 7000 Series Organizer Link.
- When using an 8000 Series Organizer Link:
 - You cannot transfer the following data. No error message will be displayed if these transfers are attempted, but the data will not be transferred to your unit.
 - . DAILY ALARM
 - TEL FILE NAME
 - TEL/BUSINESS CARD (corresponds to USER FILE 1 in the 8900/9000 Series) FREE FIELD NAME
 - USER'S DICTIONARY (corresponds to the Word key function in the 8900/9000 Series)
- You cannot transfer an entry from USER FILE 1 (BUSINESS) of the **User File** application if it has no data in its NAME field. It is also impossible to transfer any complete file that contains such an entry.

When receiving data from an unit other than the 8900/9000 Series or when using an Organizer Link designed for another Organizer:

- If an Outline entry is more than 32 Kbytes in size, only the first 32 Kbytes of data will be received in a 8900/9000 Series unit. Any subsequent text will not be transferred.
- For Memo entries received in the **Notebook** application:
 - The first 20 characters, or the text on the first line, will be entered as a title and will also appear in the text field.
 - The number of pages displayed in the index mode will be **. Once the data has been transferred, open the entry in the Edit or View mode to display the number correctly.
- Only data in applications/modes can be transferred. (Data in the Period mode of the 6000 and 8000 Series cannot be received in a 8900/9000 Series unit.)

- If you have used free fields in **Telephone** or **UserFile** on your other unit, you must set the number of fields in **Telephone** (or **UserFile**) on the 8900/9000 Series Organizer to be the same (e.g. 8 for the 8000 series) BEFORE transferring the information to the 8900/9000 Series unit. Otherwise the data in the free fields will not be transferred onto the 8900/9000 Series unit. Also, if the type of a field (text or picture) is different in the two units, it cannot be transferred.
- When transferring Business Card entries from- a 6000 or 8000 Series Organizer to USER FILE 1 or vice versa, the data will be entered into the corresponding fields. Even if the fields for USER FILE 1 are renamed, the data will be transferred to or from the fields with the corresponding default names.
- When transferring a Business Card entry, if receiving the contents of a field would make an entry exceed 2048 characters, which is the limit for a USER FILE 1 entry, neither that field nor any subsequent fields of the Business Card entry are transferred.





9

Personalizing Your Unit

Now that you have an understanding of all of the unit's functions and its operation, it's time to take a look at the ways you can configure the unit to your individual preferences: the display can show selected user information at start-up, entries can be made secure through password protection and by marking them as secret, and the **Calendar** display can be set to a format that's best for you.

9

The Start-Up Display

The unit can display your name, telephone number, and address every time it is turned on, set against one of two graphic backgrounds (one of which you can create using the **Scrapbook** application). If you ever lost or misplaced the unit, this could significantly increase the chances of having it returned to you.

Setting the start-up display

1. Press (MENU) and touch **TOOLS** to open the **TOOLS** menu, then select SET START-UP DISPLAY.

SET START-UP DISPLAY contains several fields. Current selections are shown in reverse.

SET START-UP DISPLAY	STORE ENTER	CANCEL	
START-UP	ON	OFF	DEMO
BACKGROUND	GLOBE	USER'S PICTURE	
USER'S	[Paste picture here]		
ASK PASSWORD;	ON	OFF	
OWNER			
TEL NUMBER			
ADDRESS			

START-UP

- ON: Turns on a user-specified display upon start-up.
- OFF: The unit starts up in the application or display mode that was in use when the unit was turned off.
- DEMO: Sets the unit to display its built-in demo at start-up. This is the default display.

BACKGROUND

Choose between the built-in background GLOBE or USER'S PICTURE, which selects a graphic image pasted to the USER'S PICTURE field. The selected background is displayed at start-up.

USER'S

Any graphic image pasted to this field and selected in the BACKGROUND field (above) is displayed at start-up. (For an explanation of how to paste graphic images, see p. 130.)

ASK PASSWORD

- ON: After registering a password (see p. 283), **you** will be prompted to enter that password upon start-up. The unit cannot be used if the password is not entered.
- OFF: You will not be prompted to enter your password upon start-up.

OWNER

Enter your name (up to 25 characters).

TEL NUMBER

Enter your telephone number (up to 20 characters).

ADDRESS

Enter your address (up to 75 characters).



The BACKGROUND field and all fields listed below it are activated only if "ON" is selected in the START-UP field.

2. Select the desired setting in each field.
3. Enter your name, telephone number, and address in the appropriate fields. (You can leave any or all of these fields blank if you wish.)

SET	START-UP	DISPLAY	STORE 	CANCEL
USER'S	[Paste picture here]			
ASK PASSWORD:	ON	OFF		
OWNER	OLIVIA HAMILTON			
TEL NUMBER	105-663-9521			
ADDRESS	701 BROADWAY, NEW YORK NY 10012_			

4. Touch **STORE** to store the settings (or **CANCEL** to cancel any changes).

Responses to the start-up display

If you have set START-UP and ASK PASSWORD to ON, and filled in your personal information, a display similar to the one below will appear every time the unit is turned on.

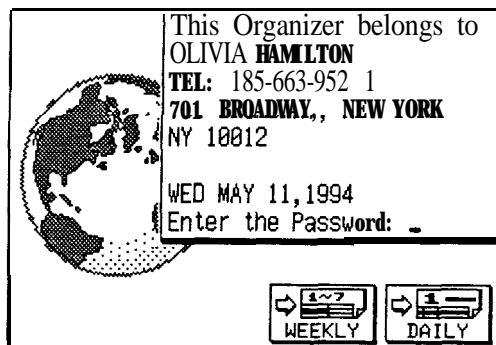

To use any function of the unit,

1. Type in the password as used for the **Secret** function.
You must enter the password exactly as you registered it, including upper- and lower-case letters.
2. Press **ENTER** .
ENTER PASSWORD disappears.
3. Touch **WEEKLY** or **DAILY** to go directly to these **Calendar** views, or press the key for any application you want to use.



- If no password has been registered, the prompt for the password will not be displayed even if ASK PASSWORD has been set to ON.
- If you set ASK PASSWORD to ON with START-UP set to ON and you forget your registered password, to access the unit you will have to reset the unit, losing all the data stored in it (see p. 299).

The Secret Function

The Secret function keeps information in your unit secure by locking it with a password that you specify. Entries marked as secret are hidden from all displays until the password is entered. Individual entries can be marked as “secret,” so that only someone who knows the password can access them, or all entries and operations can be

protected using the PASSWORD feature from SET START-UP DISPLAY in the **TOOLS** menu (see above, p. 276). Marking entries as secret has no effect until a password is entered in the unit.

Registering a password

1. Press **MENU** and touch **TOOLS** to open the **TOOLS** menu.
2. Select LOCK/UNLOCK ORGANIZER from the menu, then LOCK ORGANIZER from the submenu.

A LOCK ORGANIZER text box appears prompting you to enter a password.

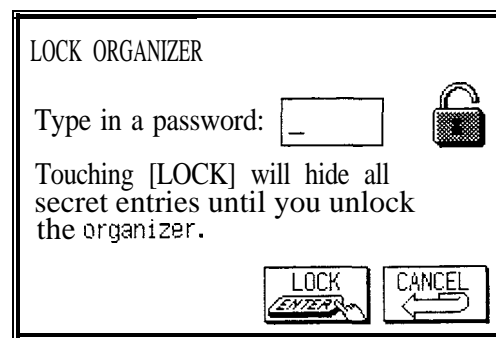

3. Enter any password up to seven characters long. Letters, numbers, and symbols can all be used. This text box is case sensitive, which means that upper- and lower-case letters are not recognized as being the same. The password SECRET, for example, is different from the passwords Secret or secret



Choose your password wisely. If you forget your password, there is no way to bypass the **Secret** function or enter a new password without losing all data marked as secret. It is strongly recommended that you use a *significant* password—one that you will always be able to remember.

4. Touch **LOCK** to store the password (or **CANCEL** to cancel the operation).

This “locks” the unit, making it impossible to access any data marked as secret without entering the password.

A message appears warning you not to forget the password. If you have any doubt about whether or not you will always be able to recall this password, write it down and keep the record of it in a safe place.

5. Touch **ISEE**.

 appears on the display, indicating that any information you mark as secret will now be hidden. The unit itself can still be accessed until you turn on the ASK PASSWORD feature in the SET START-UP DISPLAY window. See p. **280**.

- ★ You can also use **2nd**  to open the LOCK ORGANIZER window.

Marking/ unmarking entries as secret

You can mark or unmark any entry except those in the **Scrapbook** application as secret in the View or Edit mode.

1. Open the application containing the entry you want to mark as secret.
2. Display the entry in either the View or Edit mode.
3. Press **MENU**, touch **MODIFY**, and select SET SECRET STATUS.
4. Touch SECRET. An asterisk appears in the top left corner.

- ★ You can also press **2nd**  in step 3 above to set secret or non-secret.

-  If the unit has been locked (which hides all secret entries) an entry which has just been marked as secret will remain displayed until you go to another entry. Once you leave the entry marked as secret, it will be hidden with all other secret entries (for more information, see the next section).

Accessing secret entries

Entries marked as secret are not shown in any of the unit's display modes, and cannot be accessed using any of the search methods. To be able to view and recall secret entries, the unit must first be unlocked.

1. Press **MENU** and touch **TOOLS** to open the TOOLS menu. Select LOCK/UNLOCK ORGANIZER, then UNLOCK ORGANIZER.

A window appears, prompting you to enter your password.

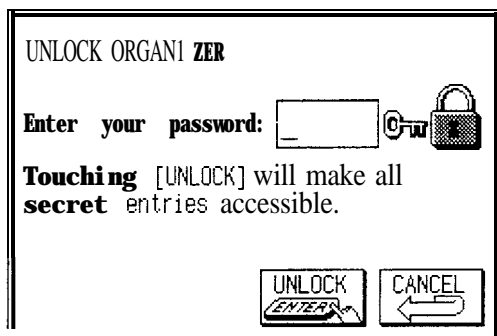

2. Enter your password exactly as you registered it (remember that the text box is case sensitive-distinguishing between upper- and lower-case letters).

3. Touch **UNLOCK** .

 disappears.

If the password is incorrect, a message appears indicating this.

4. After unlocking the unit, access any entry you want using the normal procedures.

★ You can also use (2nd)  to open the UNLOCK ORGANIZER window.

 If you forget your password, it will be impossible to unlock the unit. If this occurs, you will have to delete the old password to be able to continue to use the **Secret** function. This will also delete all entries marked as secret. For a full explanation of what to do if this occurs, see below, p. 287.

➔ You can use **SEARCH** to find only those entries marked as secret (see p. 73).

Locking the unit

Once a password has been registered, even though you unlock the unit using the procedure above, the unit will automatically lock itself each time you turn it off. This automatic lock feature guards your secret data in case you forget to relock the unit. The feature remains in effect as long as a password is registered.

You can also lock the unit yourself at any time:

1. Press **MENU** and touch **TOOLS** to open the **TOOLS** menu.
2. Select LOCK/UNLOCK ORGANIZER.
3. Select LOCK ORGANIZER.

 appears, indicating that the unit is locked.

★ You can also lock the unit simply by pressing **2nd** .

Changing or deleting the password

To register a new password, the current one must first be deleted.

1. Press **MENU** and touch **TOOLS** to open the **TOOLS** menu.
2. Select DELETE PASSWORD.

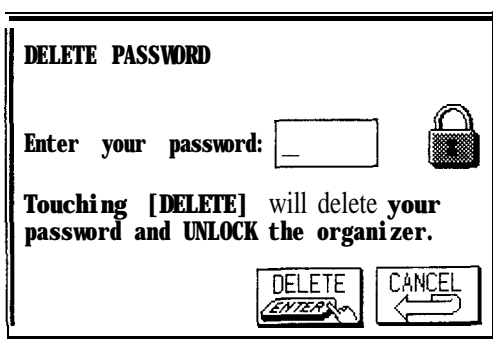

3. Enter your password exactly as you registered it (remember that the text box is case sensitive-distinguishing between upper- and lower-case letters).
4. Touch **DELETE**.

A message appears indicating that the unit is unlocked. Entries that were marked as secret can be accessed until a new password is registered (to register a new password, use the procedure for “Registering a password” on p. 283).

If you forget your password...

If you have forgotten your password, the only way you will be able to delete it and continue to use the **Secret** function is to delete all entries marked as secret.

1. Press **MENU** and touch **TOOLS** to open the **TOOLS** menu.
2. Touch MORE TOOLS.
3. Select DELETE ALL SECRET DATA.

A warning message appears asking if you are sure you want to delete all the secret entries. If you have forgotten your password, you have no choice but to proceed.

4. Touch **YES** to delete all secret entries. This will make it possible for you to enter a new password.



- If an optional RAM card is installed on which the same password is registered as that for the unit, the secret data on the card will also be deleted by this operation.
- If you set ASK PASSWORD in the SET START-UP display to ON, and forget your password, you will have to do an all reset operation (see p. 299).

RAM cards and the Secret function

If you are using a RAM card in the unit, the card is also protected by any password that you register. If you remove a RAM card and change your password, or register a password for the first time, you will be unable to use the card in the unit again unless you re-register the original password, or delete your password, respectively. It is therefore crucial to keep track of any passwords used with specific RAM cards. Also, before you use a new RAM card for the first time, you must delete any registered password or the unit will not recognize the card (see “Changing or deleting the password” on p. 286).

Changing the Calendar Display Format

The unit lets you change the default **Calendar** display to one you find more convenient. There are three aspects to changing the display: setting the date format, setting the monthly format, and setting up the **Calendar**. You can use any or all of them to create a display that you like.

Setting the date format

You can set dates to be shown in a month/day/year (this is the default) or day.month.year format in the **Calendar**, **Schedule** and **To Do** applications, as well as in the **Clock** application, etc.

In the **Calendar** application,

1. Press **MENU**, touch **MODIFY**, and select SET UP DATE FORMAT.

A submenu appears. The current setting is indicated by an asterisk.

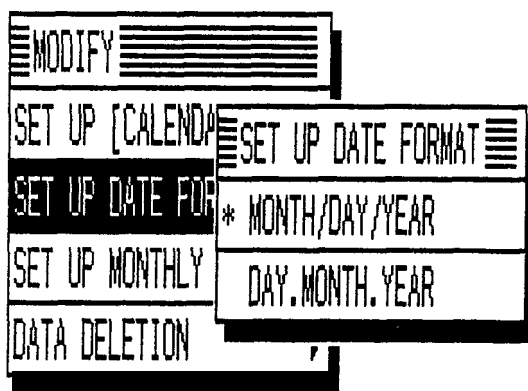

2. Select the desired format.

Setting the monthly format

You can set the Monthly and Three-month views in the **Calendar** application to show the weeks in a Sunday to Saturday (this is the default) or Monday to Sunday format.

In the **Calendar** application,

1. Press **MENU**, touch **MODIFY**, and select SET UP MONTHLY FORMAT.

A submenu appears. The current setting is indicated by an asterisk.

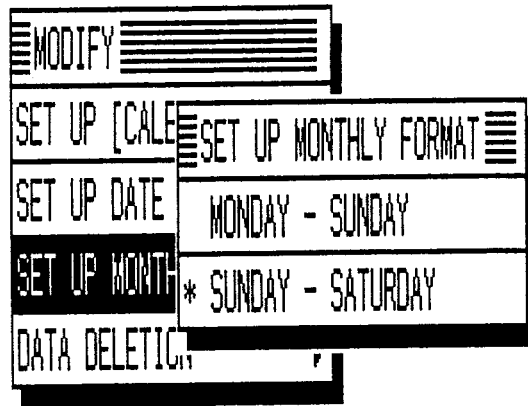

2. Select the desired format.

Setting up the Calendar

You can set up the **Calendar** to show either a Monthly or Weekly view each time the **Calendar** application is opened. The default setting is the Monthly view.

In the **Calendar** application,

1. Press **MENU**, touch **[MODIFY]** and select **SET UP [CALENDAR]**.

A submenu appears. The current setting is indicated by an asterisk.

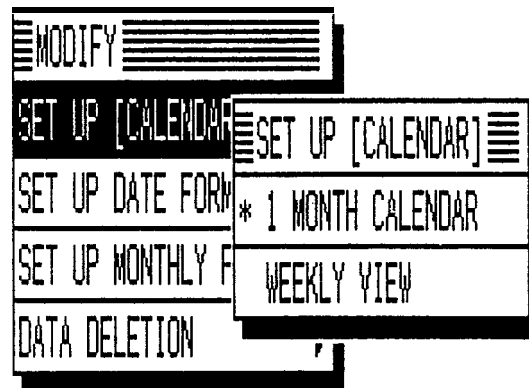















2. Select the desired format.













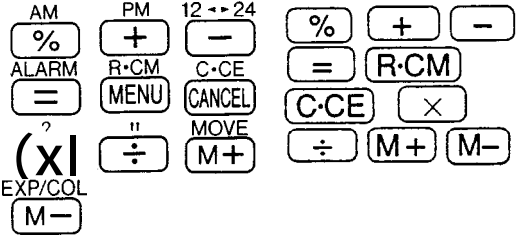

Appendices





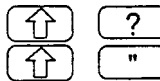









- A. List of Key Notations
- B. ASCII Control Code Table
- C. Resetting the unit
- D. Troubleshooting
- E. Battery Replacement
- F. Specifications

A. List of Key Notations























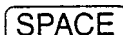

Key	Representation in text	Function
	CALENDAR	Opens the Calendar application.
	SCHEDULE	Opens the Schedule application.
	Touch and hold SCHEDULE	Opens the schedule of the current day.
	[MENU]	Opens application menus. Functions the same as MENU on the keyboard.
	TO DO	Opens the To Do application.
	(ANN)	Opens the Ann application. Subsequent presses switch between ANN 1 and ANN 2 files.
	CALC	Opens the Calc application. Subsequent presses switch to paperless printer mode, then to date calculator mode, then back to standard Calc Mode.
	TEL	Opens the Tel application. Subsequent presses switch between TEL1, TEL2 and TEL3 files.
	USER FILE	Opens the User File application. Subsequent presses switch between USER FILE 1, 2, and 3.
	CLOCK	Touch and hold to display the time and date on the built-in clock.
	NOTEBOOK	Opens the Notebook application.
	OUTLINE	Opens the Outline application.
	SCRAPBOOK	Opens the Scrapbook application.
	FILER	Opens the Filer application.
	(SEARCH)	Calls the Search function.

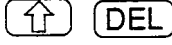
Key	Representation in text	Function
	CARD	Accesses any installed IC card.
QUIT 	ON	Turns the unit on.
	QUIT	Interrupts printing or data transfer.
	OFF	Turns the unit off.
		Calculator application function keys.
	(AM) M	A.M./P.M. selection. Automatically activated in appropriate applications.
		Enter $\overset{A}{M}$ and $\overset{P}{M}$ as symbols.
	12 \leftrightarrow 24	Switches between the 12-hour and 24-hour time display format. Automatically activated when setting the time.
	2nd ALARM	Sets/cancels Schedule alarms. Sets/resets an entry for daily alarms.
	MENU	Opens application menus.
	CANCEL	Clears an unstored entry. Cancels a selection, menu, or operation to return to the previous display.
		Enters the question mark. Enters the double quotation mark.
	MOVE	Moves topics in the Outline application.

Key	Representation in text	Function
EXP/COL M-	EXP/COL	Expands/collapses topics in the Outline application.
	NEW	Opens a new entry in an application.
NEW	↑ NEW	Clears field contents when entering/editing data.
	(EDIT)	Opens the Edit mode so that an entry can be edited.
(EDIT)	2nd EDIT	Stores an entry as a copy so that you can save the original entry and edit the duplicated entry in the Notebook application.
◀	←	Moves the cursor one character to the left.
	↑ ←	Moves the cursor to the beginning of a line.
	2nd ←	Turns the keying sound on and off. Equivalent to KEY SOUND ON/OFF in the TOOLS menu.
▲	▲	Moves the cursor one line up. Scrolls the display up.
	↑ ▲	Moves the cursor to the beginning of a field (in edit-mode) and also scrolls the displays one by one (in view mode) in the Notebook application. Moves the cursor to the first line of a field in other applications.
	(2nd) ▲	Marks/unmarks an entry as secret.
▼	▼	Moves the cursor one line down. Scrolls the display down.
	↑ ▼	Moves the cursor to the end of a field (in edit mode) and also scrolls the displays one by one (in view mode) in the Notebook application. Moves the cursor to the last line of a field in other applications.
	▼	Locks/unlocks the unit. Equivalent to LOCK/UNLOCK ORGANIZER in the TOOLS menu.
▶	▶	Moves the cursor one character to the right.
	↑ ▶	Moves the cursor to the end of a line.
	▶	Disables/enables all set alarms. Equivalent to ENABLE/DISABLE ALARM in the TOOLS menu.

Key	Representation in text	Function
	PREV	Moves the cursor between fields. Steps up through entries/screens. Continues to search backwards for a keyword.
	NEXT	Moves the cursor between fields. Steps down through entries/screens. Continues to search forwards for a keyword.
	1 - 0	Enter numerals 1-0.
	 	Enter symbols.
	BS	The backspace key. Deletes the character to the left of the cursor.
+/- m		Sign change key in Calc mode.
	 	Enters the symbol \pm .
	A - Z	Enter the letters A-Z.
TIME STAMP 	2nd (TIME STAMP)	Stamps the current local time at the cursor location in an entry.
	2nd Y 2nd U 2nd I 2nd O	Enter font settings in the Notebook application: plain, underline, italic and bold, respectively.
PRINT SCREEN 	2nd (PRINT SCREEN)	Prints the current display when a printer is connected.
DATE STAMP 	2nd (DATE STAMP)	Stamps the current local date at the cursor location in an entry.
	2nd F	Searches for a specific text in the Notebook application.
HELP 	(2nd) [HELP]	Calls the on-line help feature.
	2nd  2nd  2nd  2nd  2nd 	Enter accent marks: ` , ´ , ~ , ¨ , ^ , respectively. Press the keys and type a letter to create accented characters.

Key	Representation in text	Function
		Opens the TOOLS menu. (Equivalent to)
		Opens the PERIPHERALS menu. (Equivalent to)
		In the Scrapbook application, converts the touch pen to drawing tools.
		In the Scrapbook application, converts the touch pen to an eraser.
		In the Scrapbook application, marks areas to cut, <small>COPY</small> , paste or delete.
		Enters a carriage return.
		Enters a tab in the Notebook application.
		Switches the letter keys between upper and lower case when pressed. Enters a symbol in white above a key when held while the key is pressed.
		Cuts a specified text/picture or a selected entry to the clipboard for pasting to another location.
		Copies a specified text/picture or a selected entry to the clipboard for pasting to another location.
		Places a text/picture in the clipboard at the cursor location.
		Enters the French character ç.
		Enters a comma.
		Enters the German character β.
		Enters a quotation mark.
		Enters a period. In calculations, the period entered from the keyboard acts as a decimal point.
		Enters a colon.
		Enters a semicolon.

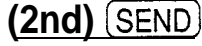
Key	Representation in text	Function
		Caps lock key. Switches the letter keys between upper- and lower-case modes.
		Press this key then another key to access any second function indicated in blue above the key. Also accesses keyboard shortcuts.
		Accesses a user word list.
		Performs a square root calculation in Calc mode.
		Enters "√" as a symbol.
		Accesses the symbol menus.
		Checks off the To Do entries.
		Enters "√" as a symbol.
		The space key.
		Toggles between insert and overwrite mode when entering/editing data.
		Deletes a character at the cursor position when entering/editing data. Deletes entries when viewing data.
		Deletes a line at the cursor location.
		Executes operations. Stores entries in memory.
		Stores an edited entry as new, leaving the original unchanged.
		Receives data via the infrared port from a 9000 Series unit.
		Sends data via the infrared port to a 8900/9000 Series unit.
		Prints the selected entry or folder when a printer is connected.

B. ASCII Control Code Table

The table below lists the key combinations required to generate the ASCII control codes in the **Terminal** mode.

Hex Value	Key Combination	ASCII Code
00	@	NUL
01	A	SOH
02	B	STX
03	C	ETX
04	D	EOT
05	E	ENQ
06	F	ACK
07	G	BEL
08	H or BS	BS
09	I or +	HT
0A	J	LF
0B	K	VT
0C	L	FF
0D	M or or	CR
0E	N	so
0F	O	SI
10	P	DLE
12	R	DC2
14	T	DC4
15	U	NAK
16	(M-IV	SYN
17	W	ETB
18	X	CAN
19	Y	EM
1A	Z	SUB
1B	[or	ESC
1C	\	FS
1D]	GS
1E	M - ^	RS
1F	M - _	us

C. Resetting the Unit

A strong impact, exposure to an electrical field, or other unusual conditions may render the unit inoperative, and pressing the keys or touch buttons will have no effect. If this occurs, you will have to press the RESET switch on the back of the unit using the touch pen or similar object to be able to continue to use the unit.

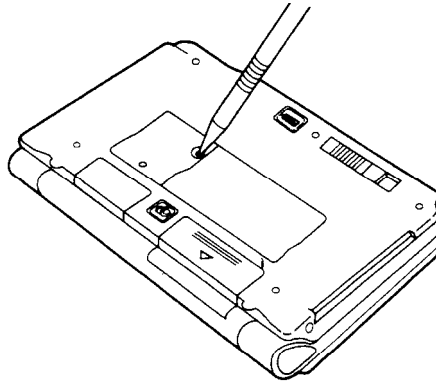

- A condition that makes the unit inoperative may erase some or all of the data stored in memory.
- Do not use anything breakable, anything with a sharp tip or anything that might break to press the RESET switch.

All reset operation

If the unit still fails to function after it has been reset using the procedure above, or you have forgotten the password to be entered in the start-up display, you will have to reset it using a slightly more complicated procedure:

1. While pressing and holding (ON), press and release the RESET switch.

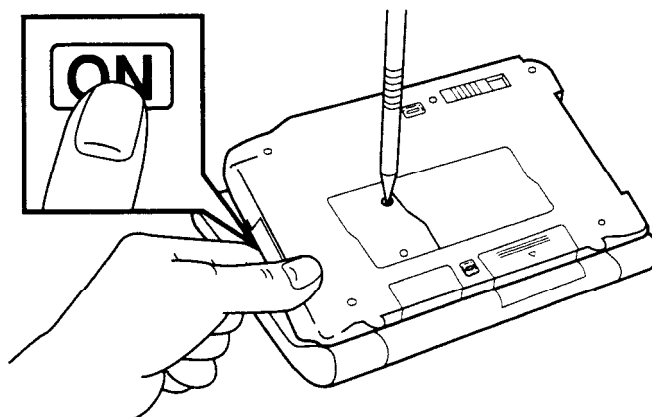

A message appears.

2. Release **ON**.

3. Touch **NO**.

The built-in clock and any set daily alarms are reset.



- Do not touch **YES** in step 3. Doing so will delete all data in the unit.
- However, if you have forgotten the password to be entered in the start-up display, you have no choice but to touch **YES**, losing all your data, to be able to use the unit.

D. Troubleshooting

Refer to the list below for solutions when the unit is not functioning properly before contacting your local SHARP dealer.

Problem	Solution
The display remains blank after pressing ON .	<ul style="list-style-type: none">• Set the card lock switch to LOCK.• Adjust the LCD contrast (see p. 52).• Install new batteries (see p. 302).
Poor display contrast.	Adjust the LCD contrast (see p. 52).
The unit is turned on, but pressing keys and touch buttons has no effect.	Reset the unit (see p. 299).
"Not enough memory" displayed.	The unit's memory is full or nearly full. Delete unnecessary data or install a RAM card (see p. 238). (You can check the amount of free memory using CHECK MEMORY in the TOOLS menu. See p. 81.)

Problem	Solution
The alarm does not sound at the set time.	Enable alarms using the TOOLS menu (see p. 189).
Pressing a touch button or touching the display has no effect. Or a function which is not selected is carried out.	Calibrate the touch panel (see p. 52).

E. Battery Replacement

General guidelines

The unit uses the following types of batteries:

Use	Type	Size/Model	Qty.
General operation	Alkaline batteries	LR03 (L30)	2
Memory backup	Lithium battery	CR2032	1

There are some extremely important points to remember when installing new batteries:



- Do not remove the operating and backup batteries at the same time. Doing so will result in the loss of all data stored in the unit's memory.
- Backup all important data before replacing the batteries.
- Remove any installed IC card before replacing the

batteries. If an IC card contains its own batteries, confirm that those batteries are not depleted before removing the card from the unit.

- Replace the two operating batteries at the same time with new batteries of the same type.
- The memory backup battery installed at the factory at the time of manufacture may have become depleted during shipment and may not have the full battery life indicated in the specifications.

Caution:

- Keep batteries out of the reach of children.
- Remove batteries from the unit when they become weak or when the unit is not to be used for a long period of time. Leaving weak batteries in the unit may cause battery leakage and damage from corrosion.
- Do not dispose of batteries by fire as they may explode.

Replacing the operating batteries

When using the unit, if the **BATT** symbol appears at the top of the display, the operating batteries may need to be replaced. To confirm this, turn the unit off and then on again. If the display shown below appears, replace both of the operating batteries immediately.

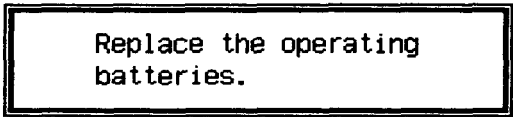

1. Turn off the unit.
2. Set the battery replacement switch on the back of the unit to "REPLACE BATTERIES" (a red dot will be visible).
3. Slide off the operation battery cover.

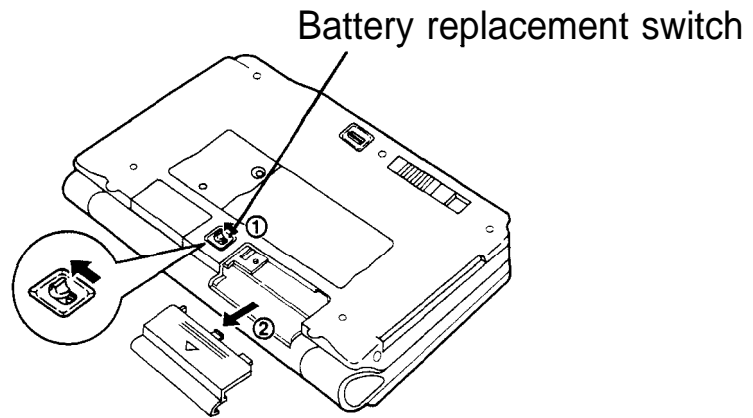

4. Remove the old batteries by pulling the ribbon tab.
5. Insert the two new batteries atop the ribbon tab, positioning them according to plus (+) and minus (-) polarity, as shown below.

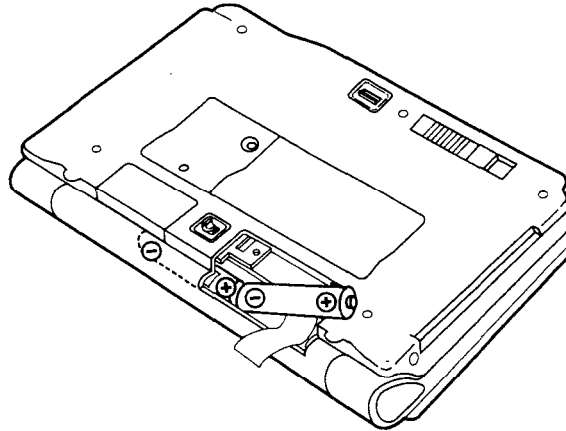

6. Replace the operation battery cover.
7. Set the battery replacement switch to "NORMAL OPERATION."

If nothing happens when you press :

- Setting the battery replacement switch to "REPLACE BATTERIES" shuts off power to the unit. Check that the battery replacement switch is set to "NORMAL OPERATION."
- Check that the card lock switch is set to LOCK,
- Repeat the above battery replacement procedure step by step.

Replacing the memory backup battery

The unit's memory backup battery has an expected life of approximately five years under normal conditions (temperature extremes can shorten the life of the battery). Replace the memory backup battery every five years or whenever the following display appears.

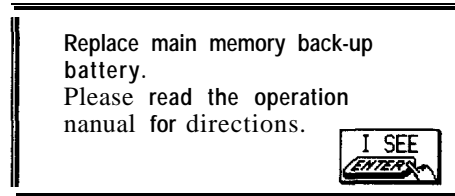

Do not try to replace the memory backup battery if the operating batteries are weak. Doing so may result in the loss of all data in the unit. If necessary, replace the operating batteries before replacing the memory backup battery.

1. Turn off the unit.
2. Set the battery replacement switch on the back of the unit to "REPLACE BATTERIES" (a red dot will be visible).
3. Remove the screw holding the memory backup battery cover in place.

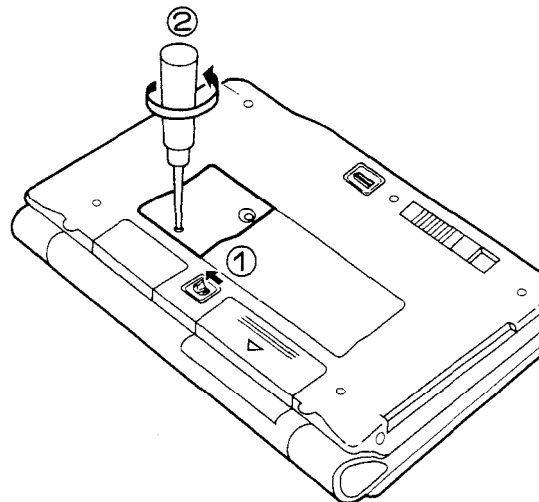

4. Remove the memory backup cover.

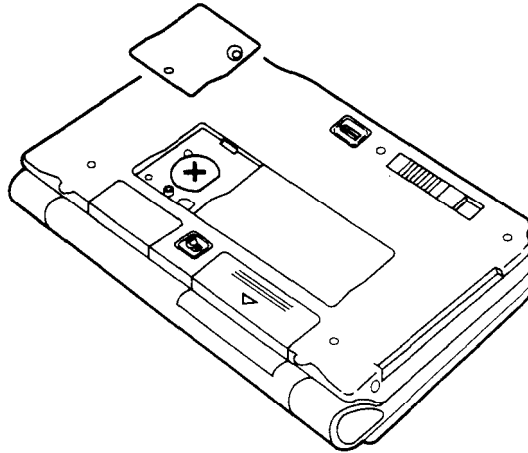

5. Remove the old battery using the touch pen or a similar object.

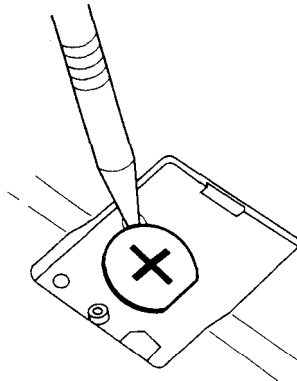

6. Insert a new battery with the plus (+) side up.

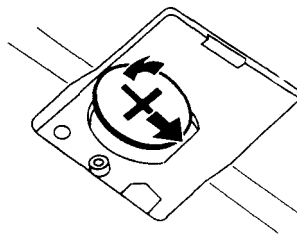

8. Replace the memory backup battery cover and secure it with the screw.
9. Set the battery replacement switch to "NORMAL OPERATION".

If nothing happens when you press **ON :**

- Setting the battery replacement switch to "REPLACE

BATTERIES” shuts off power to the unit. Check that the battery replacement switch is set to “NORMAL OPERATION.”

- Check that the card lock switch is set to LOCK,
- Repeat the above battery replacement procedure step by step.

F. Specifications

Model	IQ-8900/IQ-8920
Display	240 x 160 dot matrix liquid crystal display

Electronic unit section

Applications	Calendar, Schedule, To Do, Anniversary, Telephone, User File, Notebook, Outline, Scrapbook, Filer
--------------	---

Memory capacity	IQ-8900 256 Kbytes (User area: Approx. 135 Kbytes) Schedule application capacity: Approx. 2,130 entries Tel application capacity: Approx. 2,100 entries
	IQ-8920 512 Kbytes (User area: Approx. 391 Kbytes) Schedule application capacity: Approx. 6,900 entries Tel application capacity: Approx. 6,780 entries
	These capacities assume the following average entry sizes and only apply when all the available memory is committed to a single function. Schedule: 32 characters/entry

	Tel: 16 characters/entry in the name field 12 characters/entry in the number field
Maximum data size per entry	Notebook: 16 Kbytes Outline: 32 Kbytes for an entire outline 2 Kbytes for each topic Tel/User File: 2 Kbytes for text data 61.7 Kbytes for graphics data Other applications: 2 Kbytes
User interfaces	Touch panel, keyboard
Other features	Secret function, data transfer, search function, help function, etc.

Calculator

Digits	10
Functions	Addition, subtraction, multiplication, division; constant, square root, percent, memory calculation, date calculation, paperless printer.

Clock

Crystal oscillation frequency	32,768 Hz
Accuracy	Average variance per day, 1.5 seconds (at 25°C/77°F).
Display information	Year, month, day, day of the week, hours, minutes, AM/PM, city names.
Time system	12-hour or 24-hour
Other functions	Display of date and time for the world's cities. Enable/disable daylight saving time display function.

Peripherals and transfer interface

I R transfer	Up to a distance of approx. 80 cm.
Cable jack	15-pin
IC card slot	1

Common

Power	Battery: Main supply: 3 V --- DC, alkaline batteries (LR03 x 2) Memory backup: 3 V --- DC, lithium battery (CR2032 x 1)
Power consumption	0.29 W
Battery life	Battery life may vary depending on usage. Operating batteries: <ul style="list-style-type: none">• Approx. 70 hours (2 months of 1 hour continuous use per day) Continuous display at an ambient temperature of 23°C (73°F)• Approx. 50 hours (1.5 months of 1 hour continuous use per day) Searching data for 5 minutes and display on for 55 minutes per hour, at an ambient temperature of 23°C (73°F) Memory backup battery: Approx. 5 years (regardless of the condition of the operating batteries)
Operating temperature	0° to 40°C (32° to 104°F)

Dimensions	Open	155(W) x 177(D) x 20(H) mm 6-3/32"(W) x 6-31/32"(D) x 25/32"(H)
	Closed	155(W) x 97(D) x 23.9(H) mm 6-3/32"(W) x 3-13/16"(D) x 15/16"(H)
Weight	300 g (0.66 lb) (including batteries)	
Accessories	Alkaline batteries LR03 x 2, lithium battery CR2032 x 1 (installed), operation manual, protection card (installed), touch pen	



Index

A

- Accessing
 - Remote computer 260, 261
 - Secret entries 284
- Adding
 - Categories 115
 - Picture to an entry 130
 - Text to graphic entries 194
 - Topics 162
 - User's city 186
- Alarms
 - Daily 188
 - Disabling all alarm sounds 189
 - Schedule 102
- All reset 299
- Ann(iversary) application 119
- Application 55
 - Opening 62
- Application IC cards 220
- Application keys 47
- ASCII control code 298
- ASCII transfer protocol 264
- Assigning
 - Due date 106
 - Entries to Filer folders 199
 - Priority 105
- Auto log-on 268
- Automatic dialing 232
- Auto power off 51

B

- Backing up data 240
- Battery
 - Installing 48
 - Life 309
 - Memory backup 301, 304

Operating 301, 302

Replacement 301

BBS 253

Blocks

Copying/moving 207

Working with blocks of text 71

Break code 264

C

- Calc(ulator) application 174
 - Using with other applications 179
- Calculation
 - Changing part of 177
 - Examples 181
 - Inserting figures into 176
 - Performing 174
 - With dates 177
- Calendar application 86
 - Setting up the initial display 288
- Calendar view 86
 - Daily 89
 - Monthly 87
 - Selecting 86
 - Three-month 87
 - Weekly 88
 - Weekly Graph 88
- Call
 - Hanging up 261
 - Making 260
 - Receiving 262
- Cancelling indents 150
- Caring for the unit 42
- Categories 112
 - Adding 115
 - Assigning to entries 113

- Category list 113
- Deleting 116
- Editing 115
- Reviewing by category 114
- Changing
 - (see also Customizing)
 - Calendar format 288
 - Character size 145
 - Character/font styles 146
 - Dialing entry settings 260
 - Home city 182
 - Indents 150
- Checking
 - Current time/date 81
 - Intermediate results of a calculation 176
 - Memory 81
 - Time in a city 185
- Checking off To Do entries 111
- Clock application 182
- Collapsing outline families 168
- CompuServe 253
 - Auto log-on for 268
 - Data transfer via 267
- Connecting a fax/modem 228
- Copy 71, 130, 207, 209
- Copying
 - Blocks of text 71, 207
 - Entries 209
 - Graphics to picture fields 130
 - Sections of graphic entries 193
- Cover sheet 231
 - Preview display 235
 - Using 235
 - Sample 231
- Cursor 68
- Customizing
 - Index display 136
 - Tel/User File applications 133
- Cut 71, 130, 207, 209
- D
 - Daily alarms
 - Setting 188
 - Turning on/off 189
 - Daily view 89
 - Date calculation 177
 - Date format 68
 - Setting 288
 - Date stamp 211
 - Daylight saving time (DST) 187
 - Assigning to a city 187
 - Enabling/disabling 187
 - Deleting
 - All entries in an application 98, 122, 129, 144, 166, 195
 - All To Do entries in current view 117
 - All secret entries 287
 - Categories 116
 - Contents of picture fields 132
 - Filtered entries 215
 - Graphic entries 80
 - Line in a calculation 177
 - Schedules over a specific period 98
 - Single entries 75, 97, 122, 129, 144, 166, 195
 - Text 70
 - Topics 165
 - Using the application menu 76
 - Dialing directory
 - Setting 256
 - Display
 - Setting the LCD contrast 52
 - Symbols 57
 - Display modes 62
 - Edit mode 64
 - Index mode 62
 - Selecting 62
 - View mode 63

- Downloading 266
- Drawing tools 77
- E**
- Edit mode 64
- Editing techniques 67
- Editing
 - (see also Revising)
 - Categories 115
 - Contents of picture fields 131
 - Entries 96, 109, 122, 129, 144
 - Speed button information 237
- Emulation
 - Printer 223
 - Terminal 258, 270
- Entering
 - Monthly goals 106
 - Subtopics 167
- Error indicator 180
- Expanding families 169
- External power supply 273
- F**
- Families
 - Collapsing 168
 - Expanding 169
 - Restructuring 170
- Fax/modem 227
- Fields 67
 - Moving between 70
 - Picture 67, 130
- Filer application 198
- Filer Drawer 198
- Filter function 213
 - Deleting filtered entries 215
 - Turning off 215
 - Turning on 214
- Finding entries 72, 91, 95, 107, 121, 127, 142
 - (see also Search)
 - By date 74
 - By topic 74
 - Graphic entries 79
 - Using keywords 73, 96, 109, 121, 127, 143
 - Using the Calendar views 91, 96, 108, 121
 - Using the Index mode 95, 107, 121, 127, 142
- Folders
 - Assigning entries to 199
 - Deleting all entries in 206
 - IN 198
 - Merging 205
 - Naming/renaming 202
 - Sharing 206
 - Viewing the contents of 203
 - Unassigning entries from 204
- Font
 - Changing size 145
 - Changing styles 146
 - Selecting font type for printing 155
- H**
- Help 58
- Home city 49, 182
- I**
- IC cards 220, 274
 - Installing 220
- IN folder 198
- Indents
 - Changing/Canceling 150
 - Setting 148
- Index mode 62
- Infrared transfer
 - Setting up 246
 - Notes on 245

- Inserting
 - Page break 154
 - Text 70
 - Topic 162
- Installing
 - Batteries 48
 - IC cards 220
- J
 - Joining two topics into one 163
- K
 - Key beep 54
 - Keyboard 57
 - Function/notation list 292
- L
 - Line type 255
 - Locking the unit 286
 - Level converter CE-137T 228
- M
 - Manual
 - Construction 39
 - Conventions used 41
 - Dialing 233
 - Margins 152
 - Marking entries as secret 284
 - Memory check 81
 - Memory expansion 239
 - Menu 56
 - Application 92, 103, 118, 123, 132, 133, 157, 171, 196
 - Peripherals 220
 - Tools 82
 - MNP 255
 - Modem
 - Connecting to the unit 254
 - Hardware requirements 253
 - Null modem adaptor 253
 - Monthly goals 104
 - Entering 106
 - Monthly view 87
 - Setting the format of 288
 - Moving
 - Appointments 96
 - Between fields 70
 - Blocks of text 207
 - Entries 209
 - Sections of graphic entries 193
 - Topics 163
- N
 - New entries
 - Creating based on an existing one 210
 - Making 65, 78, 93, 104, 119, 127, 140, 191
 - Notebook application 140
 - Null modem adaptor 253
- O
 - Organizer Link 251, 274
 - Overwriting text 70
- P
 - Page break 154
 - Page header 231
 - Paper size 155
 - Paperless printer 175
 - Part names and functions 46
 - Password
 - Deleting/changing 286
 - Forgotten 287
 - Registering 283
 - Paste 71
 - PC link 252
 - Peripherals menu 220
 - Picture
 - Adding to an entry 130

- Picture field 130
 - Deleting the contents of 132
 - Editing the contents of 131
 - Viewing the contents of 131
- Power
 - Auto power off 51
 - Turning on and off 51
- Printing 222
 - All entries 227
 - Current display 224
 - Full-size document 152
 - Groups of entries 225
 - Selecting paper size/font type for 155
 - Setting up 223
 - Single entries 225
- R
- RAM cards 238
 - (see also IC cards)
 - Backup 240
 - Data sharing 241
 - Memory expansion 239
 - Restoring data from 240
 - Secret function 287
- Redial 256
- Reset 299
- Replacing
 - Memory backup batteries 304
 - Operating batteries 302
- Restoring data from RAM cards 240
- Revising
 - (see also Editing)
 - Graphic entries 79
 - Outlines 161
- S
- Schedule alarms 102
 - Clearing 103
 - Setting 102
- Schedule application 93
- Scrapbook application 190
- Search
 - (see also Finding)
 - By heading 128
 - By title 143, 160
 - For a specific word in an entry 146
- Search function 73, 96, 109, 121, 128, 143, 160, 285
- Secret function 282
 - When using RAM card 287
- Selecting
 - Calendar views 86
 - Date 91, 99
 - Display modes 62
 - Font type/paper size for printing 155
 - Topics 162
- Sending a fax
 - Automatic Dialing 232
 - Manual Dialing 233
- Setting
 - Clock 49, 184
 - Date format 288
 - Dialing directory 256
 - Fax/modem option 228
 - LCD contrast 52
 - Margins 152
 - Monthly format 288
 - Schedule alarms 102
 - Tabs 151
- Setting up
 - Calendar's initial display 288
 - For data transfer 242
 - For printing 223
 - The fax directory 230
- Speaker 256

- Special characters 216
- Specifications 306
- Speed buttons 235
- Splitting one topic into two 164
- Start-up display 280
 - Responses to 281
 - Setting 280
- Subtopics 167
 - Entering 167
- Symbols
 - On the display 57
 - Entering 216

T

- Setting 151
- Tel application 126
- Terminal emulation 258, 270
- Terminal mode 253
 - Hardware requirements 253
 - Opening 254
 - Troubleshooting 271
- Time stamp 211
- To Do application 104
- Tools menu 82
- Topics
 - Adding 162
 - Joining two into one 163
 - Moving 163
 - Splitting one into two 164
 - Subtopics 167
- Touch buttons 41, 45
- Touch panel 55
 - Calibrating 52
- Transferring data 242
 - Between two 9000 Series units 244
 - Filer folder 248
 - From an Organizer other than 9000 series 249
 - In Terminal mode 264
 - Points to remember when 274
 - Single entries 246
 - Via CompuServe 267
 - Via infrared 245
 - With a personal computer 251
 - With a RAM card 251
- Troubleshooting 300
 - In Terminal mode 271
- Turning on/off
 - Daily alarms 189
 - Key beep 54
 - Power 51
 - Welcome display 53
 - Word wrap 152
- Typing in text 68

U

- Unlocking the Unit 284
- Uploading 265
- User File application 126
- User's city 186

V

- View mode 63

W

- Wake up function 256
- Weekly Graph view 88
- Weekly view 88
- Welcome display 49
 - Turning off 53
- Wireless interface 223, 251
- Word key 211
 - Inserting words/phrases in an entry 213
 - Deleting words/phrases 213
 - Registering words/phrases 212
- Word wrap 152
- World city 185

X
XMODEM transfer protocol 264

— MEMO —

— MEMO —

This apparatus complies with the requirements of BS 800 (EN 55014): 1988 and BS 6527 (EN 55022): 1988.

Dieses Gerät stimmt mit den Bedingungen der EN 55014, 02. 1987 und der EN 55022, 04. 1987 überein.

Cet appareil répond aux spécifications de la EN 55014, 02. 1987 et EN 55022, 04. 1987.

Dit apparaat voldoet aan de vereiste EN 55014, 02. 1987 en EN 55022, 04. 1987.

Apparatet opfylder kravene i EN 55014, 02. 1987 og EN 55022, 04. 1987.

Questo apparecchio è stato prodotto in conformità alle EN 55014, 02. 1987 e EN 55022, 04. 1987.

Αύτή ή συσκευή τηοεί τίς προδιαγραφές τίς EN 55014, 02. 1987 κατ EN 55022, 04. 1987.

Este aparelho responde às especificações da EN 55014, 02. 1987 e EN 55022, 04. 1987.

Este aparato cumple las especificaciones de la EN 55014, 02. 1987 y EN 55022, 04. 1987.

SHARP CORPORATION

Free Manuals Download Website

<http://myh66.com>

<http://usermanuals.us>

<http://www.somanuals.com>

<http://www.4manuals.cc>

<http://www.manual-lib.com>

<http://www.404manual.com>

<http://www.luxmanual.com>

<http://aubethermostatmanual.com>

Golf course search by state

<http://golfingnear.com>

Email search by domain

<http://emailbydomain.com>

Auto manuals search

<http://auto.somanuals.com>

TV manuals search

<http://tv.somanuals.com>