

SHARP®

ENGLISH

FRANÇAIS

PN-455RU

**LCD MONITOR
MONITEUR LCD**

**OPERATION MANUAL
MODE D'EMPLOI**

ENGLISH E1
FRANÇAIS F1

PN-455RU

LCD MONITOR

ENGLISH

IMPORTANT:

To aid reporting in case of loss or theft, please record the product's model and serial numbers in the space provided. The numbers are located in the rear of the product.

Model No.:

Serial No.:

U.S.A. ONLY

IMPORTANT INFORMATION

WARNING: TO REDUCE THE RISK OF FIRE OR ELECTRIC SHOCK, DO NOT EXPOSE THIS PRODUCT TO RAIN OR MOISTURE.



CAUTION

RISK OF ELECTRIC SHOCK
DO NOT OPEN



CAUTION: TO REDUCE THE RISK OF ELECTRIC SHOCK, DO NOT REMOVE COVER. NO USER-SERVICEABLE PARTS INSIDE. REFER SERVICING TO QUALIFIED SERVICE PERSONNEL.



The lightning flash with arrowhead symbol, within an equilateral triangle, is intended to alert the user to the presence of uninsulated "dangerous voltage" within the product's enclosure that may be of sufficient magnitude to constitute a risk of electric shock to persons.



The exclamation point within a triangle is intended to alert the user to the presence of important operating and maintenance (servicing) instructions in the literature accompanying the product.

CAUTION: The AC outlet shall be installed near the equipment and shall be easily accessible.

IMPORTANT INFORMATION (Continued)

WARNING: FCC Regulations state that any unauthorized changes or modifications to this equipment not expressly approved by the manufacturer could void the user's authority to operate this equipment.

U.S.A. ONLY

CAUTION: Use the supplied power cord as it is.

NOTE:

This equipment has been tested and found to comply with the limits for Class A digital device, pursuant to Part 15 of the FCC Rules. These limits are designed to provide reasonable protection against harmful interference when the equipment is operated in a commercial environment. This equipment generates, uses, and can radiate radio frequency energy and, if not installed and used in accordance with the instruction manual, may cause harmful interference to radio communications. Operation of this equipment in a residential area is likely to cause harmful interference in which case the user will be required to correct the interference at his own expense.

U.S.A. ONLY

This product utilizes fluorescent tubes containing a small amount of mercury. Disposal of these materials may be regulated due to environmental considerations. For disposal or recycling information, please contact your local authorities or the Electronic Industries Alliance: www.eia.org

DEAR SHARP CUSTOMER

Thank you for your purchase of a SHARP LCD product. To ensure safety and many years of trouble-free operation of your product, please read the Safety Precautions carefully before using this product.

SAFETY PRECAUTIONS

Electricity is used to perform many useful functions, but it can also cause personal injuries and property damage if improperly handled. This product has been engineered and manufactured with the highest priority on safety. However, improper use can result in electric shock and/or fire. In order to prevent potential danger, please observe the following instructions when installing, operating and cleaning the product. To ensure your safety and prolong the service life of your LCD product, please read the following precautions carefully before using the product.

1. Read instructions — All operating instructions must be read and understood before the product is operated.
2. Keep this manual in a safe place — These safety and operating instructions must be kept in a safe place for future reference.
3. Observe warnings — All warnings on the product and in the instructions must be observed closely.
4. Follow instructions — All operating instructions must be followed.
5. Cleaning — Unplug the power cord from the AC outlet before cleaning the product. Use a dry cloth to clean the product. Do not use liquid cleaners or aerosol cleaners.
6. Attachments — Do not use attachments not recommended by the manufacturer. Use of inadequate attachments can result in accidents.
7. Water and moisture — Do not use the product near water, such as bathtub, washbasin, kitchen sink and laundry tub, swimming pool and in a wet basement.
8. Ventilation — The vents and other openings in the cabinet are designed for ventilation. Do not cover or block these vents and openings since insufficient ventilation can cause overheating and/or shorten the life of the product. Do not place the product on a bed, sofa, rug or other similar surface, since they can block ventilation openings. Do not place the product in an enclosed place such as a bookcase or rack, unless proper ventilation is provided or the manufacturer's instructions are followed.
9. Power cord protection — The power cords must be routed properly to prevent people from stepping on them or objects from resting on them.
10. The LCD panel used in this product is made of glass. Therefore, it can break when the product is dropped or applied with impact. Be careful not to be injured by broken glass pieces in case the LCD panel breaks.
11. Overloading — Do not overload AC outlets or extension cords. Overloading can cause fire or electric shock.
12. Entering of objects and liquids — Never insert an object into the product through vents or openings. High voltage flows in the product, and inserting an object can cause electric shock and/or short internal parts.
For the same reason, do not spill water or liquid on the product.
13. Servicing — Do not attempt to service the product yourself. Removing covers can expose you to high voltage and other dangerous conditions. Request a qualified service person to perform servicing.
14. Repair — If any of the following conditions occurs, unplug the power cord from the AC outlet, and request a qualified service person to perform repairs.
 - a. When the power cord or plug is damaged.
 - b. When a liquid was spilled on the product or when objects have fallen into the product.
 - c. When the product has been exposed to rain or water.
 - d. When the product does not operate properly as described in the operating instructions.
Do not touch the controls other than those described in the operating instructions. Improper adjustment of controls not described in the instructions can cause damage, which often requires extensive adjustment work by a qualified technician.
 - e. When the product has been dropped or damaged.
 - f. When the product displays an abnormal condition. Any noticeable abnormality in the product indicates that the product needs servicing.



SAFETY PRECAUTIONS (Continued)

15. Replacement parts — In case the product needs replacement parts, make sure that the service person uses replacement parts specified by the manufacturer, or those with the same characteristics and performance as the original parts. Use of unauthorized parts can result in fire, electric shock and/or other danger.
16. Safety checks — Upon completion of service or repair work, request the service technician to perform safety checks to ensure that the product is in proper operating condition.
17. Wall mounting — When mounting the product on a wall, be sure to install the product according to the method recommended by the manufacturer.
18. Heat sources — Keep the product away from heat sources such as radiators, heaters, stoves and other heat-generating products (including amplifiers).
19. Usage of the monitor must not be accompanied by fatal risks or dangers that, could lead directly to death, personal injury, severe physical damage or other loss, including nuclear reaction control in a nuclear facility, medical life support system, and missile launch control in a weapon system.

WARNING:

This is a class A product. In a domestic environment this product may cause radio interference in which case the user may be required to take adequate measures.

WARNING:

To reduce the risk of fire or electric shock, do not expose this product to rain or moisture.

TIPS AND SAFETY INSTRUCTIONS

- The TFT color LCD panel used in this monitor is made with the application of high precision technology. However, there may be minute points on the screen where pixels never light or are permanently lit. Also, if the screen is viewed from an acute angle there may be uneven colors or brightness. Please note that these are not malfunctions but common phenomena of LCDs and will not affect the performance of the monitor.
- Do not display a still picture for a long period, as this could cause a residual image.
- If the brightness is adjusted to the minimum setting, it may be difficult to see the screen.
- The quality of the video signal may influence the quality of the display. We recommend using an equipment able to perform high quality video signals.
- Never rub or tap the monitor with hard objects.
- Please understand that Sharp Corporation bears no responsibility for errors made during use by the customer or a third party, nor for any other malfunctions or damage to this product arising during use, except where indemnity liability is recognized under law.
- This monitor and its accessories may be upgraded without advance notice.
- Do not use the monitor where ventilation is poor, where there is a lot of dust, where humidity is high, or where the monitor may come into contact with oil or steam, as this could lead to fire.
- Ensure that the monitor does not come into contact with water or other fluids. Ensure that no objects such as paper clips or pins enter the monitor as this could lead to fire or electric shock.
- Do not place the monitor on top of unstable objects or in unsafe places. Do not allow the monitor to receive strong shocks or to strongly vibrate. Causing the monitor to fall or topple over may damage it.
- Do not use in places where the monitor will be subject to direct sunlight, near heating equipment or anywhere else where there is likelihood of high temperature, as this may lead to generation of excessive heat and outbreak of fire.

The Power Cord

- Do not damage the power cord nor place heavy objects on it, stretch it or over bend it. Also, do not add extension cords. Damage to the cord may result in fire or electric shock.
- Use only the power cord supplied with the monitor.
- Insert the power plug directly into the AC outlet. Adding an extension cord may lead to fire as a result of overheating.
- Do not remove or insert the power plug with wet hands. Doing so could result in electric shock.
- Unplug the power cord if it is not used for a long time.
- Do not attempt to repair the power cord if it is broken or malfunctioning. Refer the servicing to the service representative.

Manual Scope

- In this manual, Microsoft Windows XP will be referred to as "Windows XP", and Microsoft Windows 2000 as "Windows 2000". When there is no need to distinguish between programs, the term "Windows" will be used.
- Microsoft and Windows are registered trademarks of Microsoft Corporation.
- All other brand and product names are trademarks or registered trademarks of their respective holders.
- Language of OSD menu used in this manual is English by way of example.
- Illustrations in this manual may not exactly represent the actual product or display.
- This manual assumes use in horizontal orientation, except where specifically noted.

Fluorescent Tubes

- The fluorescent tubes in this product have a limited lifetime.
 - * If the screen gets dark, flashes, or does not turn on, change the fluorescent tubes with new exclusive ones.
 - * For more information, please contact your product dealer.
- Because of the property of fluorescent tubes, the screen may flash during the initial period of use. If this happens, please turn off the main power switch on the rear of the monitor and turn on again to confirm operation.

Contents

Introduction	
IMPORTANT INFORMATION	1
DEAR SHARP CUSTOMER	3
SAFETY PRECAUTIONS	3
TIPS AND SAFETY INSTRUCTIONS	5
Supplied Accessories	7
Part Names	8
Front view.....	8
Rear view	8
Connection and Installation	
How to install the monitor	10
Mounting precautions	10
Connecting Peripheral Equipment	11
Connection with a PC.....	11
Connection with AV equipment.....	12
Other terminals.....	13
Connecting External Speakers	14
Connecting the Power Cord	15
Connecting Multiple Monitors	16
Binding Cables	17
Attaching the Carrying Handles	17
Preparing the Remote Control Unit	18
Setting the batteries	18
Remote control operation range.....	18
Basic Operation	
Turning Power On/Off	19
Turning on the main power switch.....	19
Turning power on/off with the remote control unit	19
Basic Operation	20
Switching the screen size.....	21
Menu Items	23
Displaying the menu screen.....	23
Menu Option Reference Chart	25
Menu item details	28
Adjustments for PC screen display (ANALOG).....	33
Initialization (Reset)/Functional Restriction Setting	34
PC Operation	
Controlling the Monitor with a PC	35
PC connection	35
Communication conditions	36
Communication procedure	37
RS-232C command table.....	44
Troubleshooting and Specifications	
Troubleshooting	49
Specifications	51
Dimensional Drawings	54

Supplied Accessories

Make sure the following accessories are provided with the product.
If any component should be missing, please contact your dealer.

Liquid Crystal Display (1)



Power cord (1)

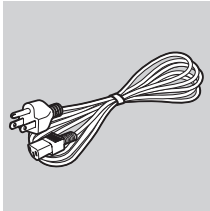

(Approx. 13.1 feet
(4 m))
(QACCU1029MPPZ)

CD-ROM (1)

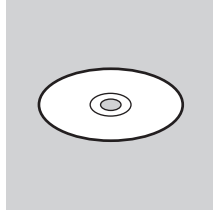

(Utility Disk for
Windows)

Logo sticker

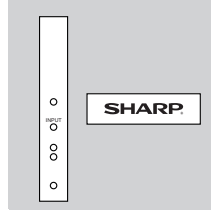

Cable clamp (2)

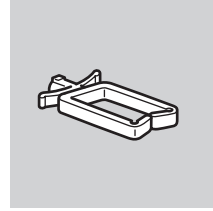

“AA” size battery (2)

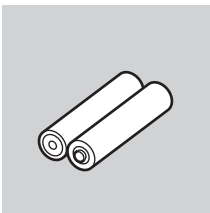

Remote control unit (1) Carrying handle (2)

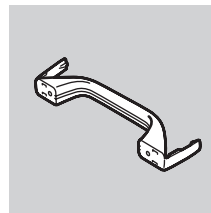
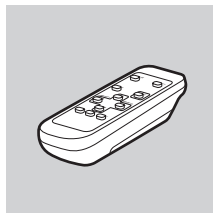

Carrying handle
mounting screw (4)
/ Spacer (4)

Power cord clamp (1)

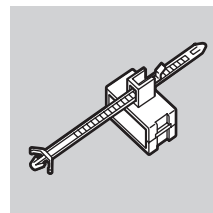

- Operation manual (1)

• Sharp Corporation holds authorship rights to the Utility Disk program. Do not reproduce it without permission.

Part Names

Front view

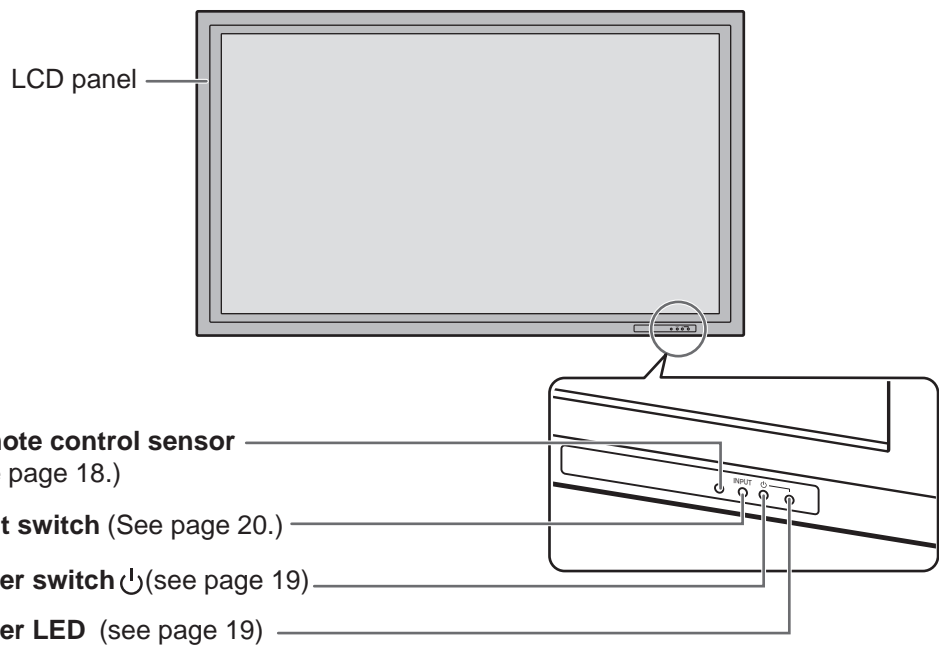

TIPS

Use a pointed object such as a pen tip to press the switches at the front of the monitor.

Rear view

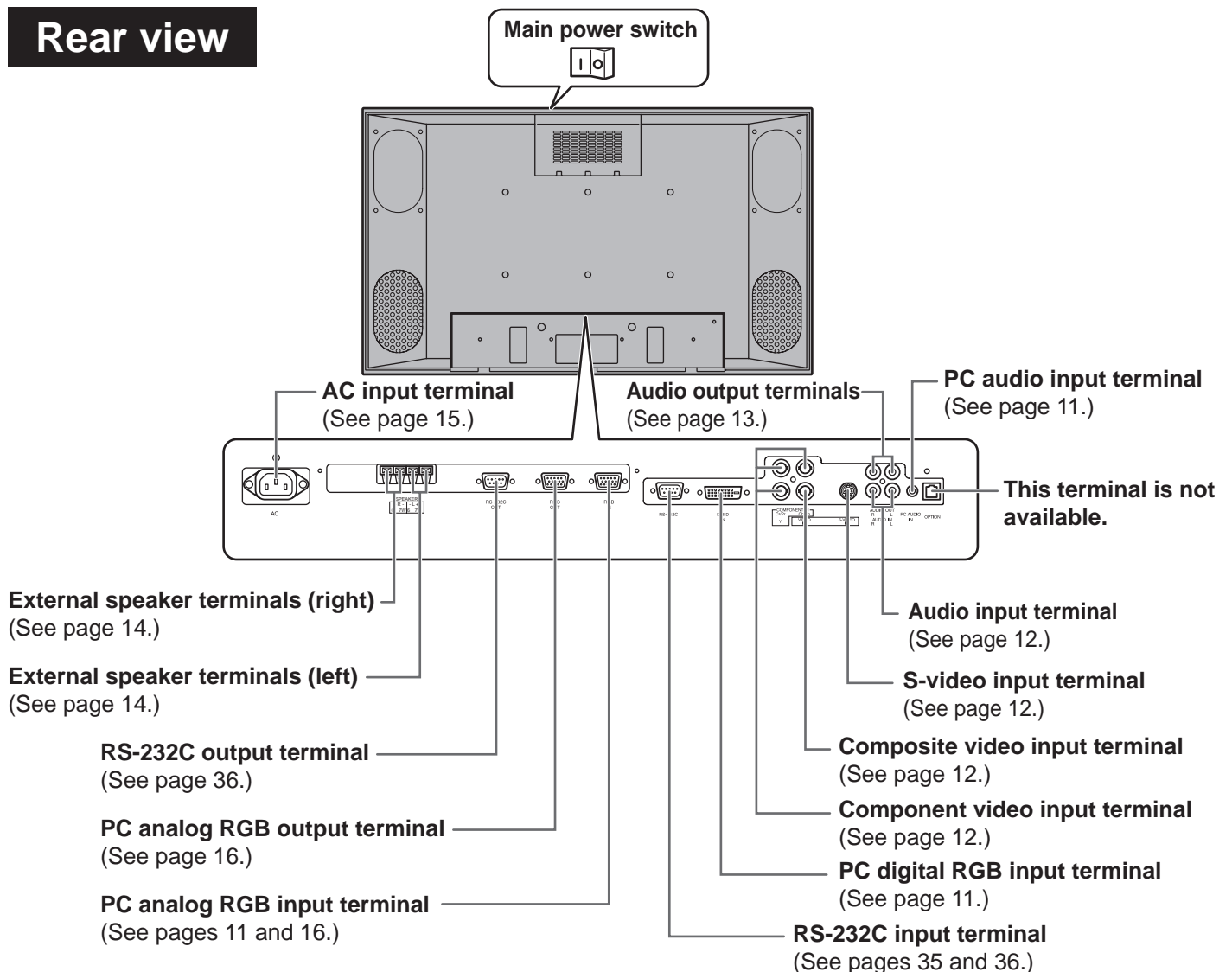

Signal transmitter

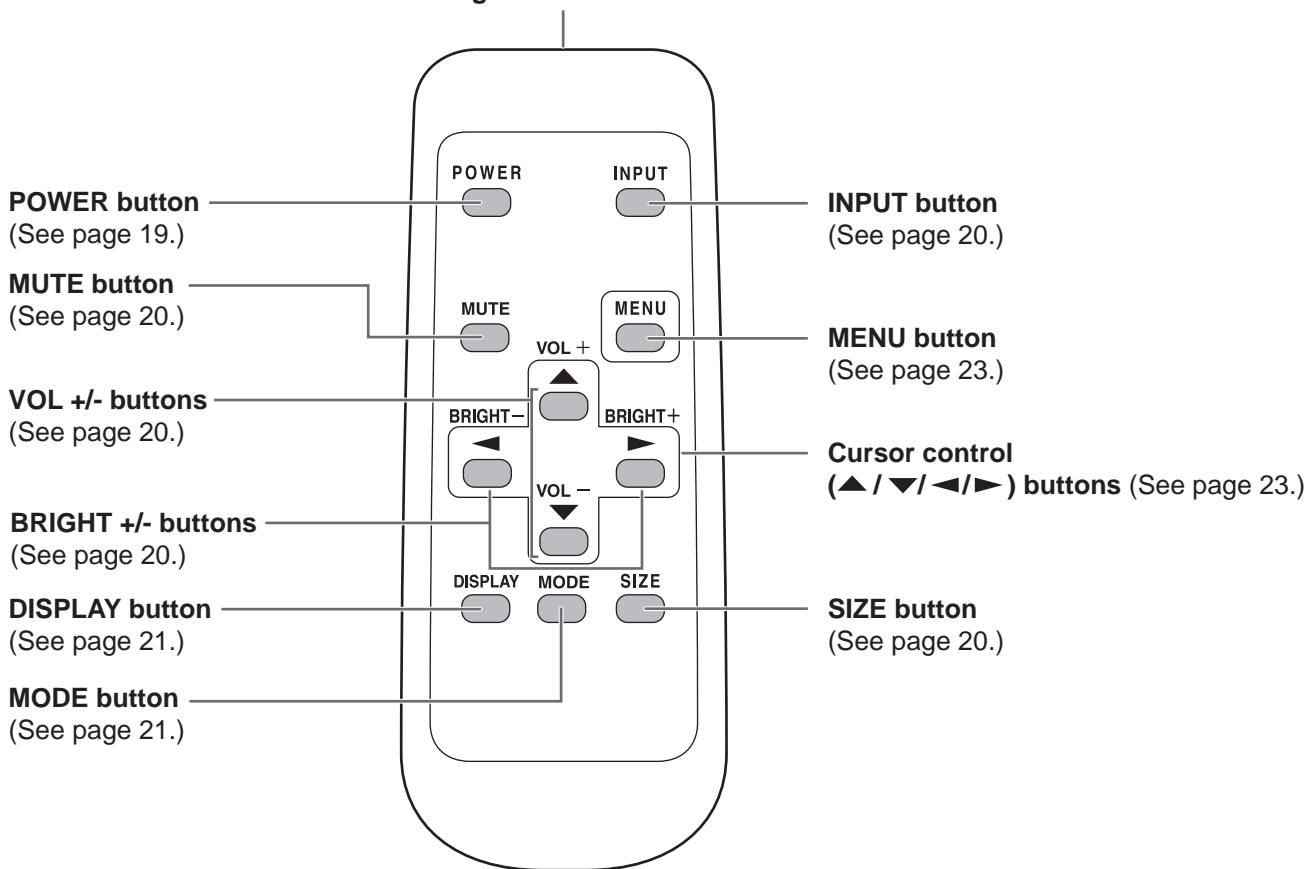

How to install the monitor

Mounting precautions

- Since the monitor is heavy, consult your dealer before installation.
- Installing or moving the monitor must be done by two or more people.
- Do not hold the LCD panel when moving the monitor. This may cause product damage, failure, or injury.
- Install the monitor with the surface perpendicular to a level surface. If necessary, limit the tilt between 0 and 20 degrees downward.
- Mounting the monitor on the wall requires special expertise and the work must be performed by an authorized SHARP dealer. You should never attempt to perform any of this work yourself. Our company will bear no responsibility for accidents or injuries caused by improper mounting or mishandling.
- This monitor should be used at an ambient temperature between 0°C and 40°C. Provide enough space around the monitor to prevent heat from accumulating inside.

For the monitor in horizontal orientation

Unit: inch[cm]

Front view

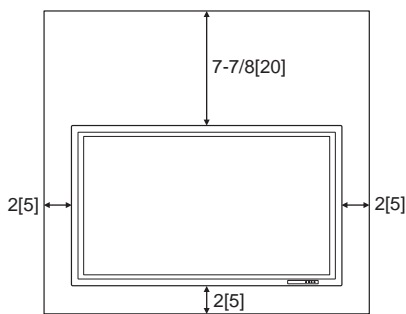

Side view

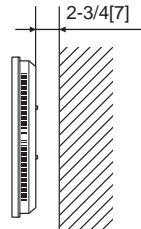

For the monitor in vertical orientation

Unit: inch[cm]

Front view

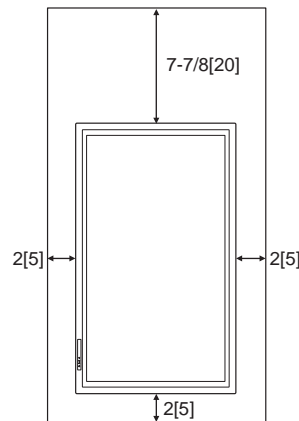

Side view

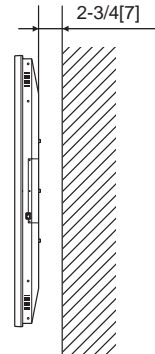

The Power LED must be on the lower side.

- If it is difficult to provide such space because the monitor is installed inside a housing or for other reasons, take other measures to keep the ambient temperature between 0°C and 40°C such as installing a fan in the housing.
- When using the monitor in vertical orientation, be sure to orient the power LED to the bottom of the monitor. Otherwise, a malfunction may result.
- Do not block any ventilation openings. If the temperature inside the monitor rises, this could lead to a malfunction.
- After mounting, it is recommended to take some measures to prevent the monitor from falling down.
- Do not place the monitor on a device which generates heat.
- Be sure to use a stand or a wall-mount/ceiling-mount bracket designed or designated for mounting the monitor.
- This monitor is designed to be installed on a concrete wall/ceiling or pillar. Reinforced work might be necessary for some materials such as plaster / thin plastic board / wood before starting installation. This monitor and bracket must be installed on a wall which can endure at least 4 times or more the weight of the monitor. Install by the most suitable method for the material and the structure.
- Use the supplied logo sticker when you install the monitor in vertical orientation.

* Do not remove the factory-affixed sticker but affix the logo sticker over it.
Be careful not to cover the remote control sensor or buttons.

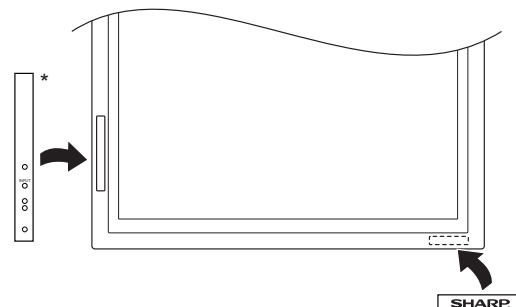



Connecting Peripheral Equipment

! Caution

Be sure to turn off the main power switch and disconnect the plug from the power outlet before connecting/disconnecting cables. Also, read the manual of the equipment to be connected.

Connection with a PC



Connection with a PC with digital RGB output

PC digital RGB input terminal	PC audio input terminal
 DVI-D IN	 PC AUDIO IN
Connect using a DVI cable (commercially available).	Connect using a PC audio cable (commercially available). Use a cable without resistance for the PC audio cable.

TIPS

- The monitor can be connected with a PC which has a DVI-compliant output terminal. (However, images may not be displayed properly depending on the computer to be connected.)
- For compatible signal timing, see page 52.

Connection with a PC with analog RGB output

PC analog RGB input terminal	PC audio input terminal
 RGB IN	 PC AUDIO IN
Connect using a PC analog signal cable (commercially available).	Connect using a PC audio cable (commercially available). Use a cable without resistance for the PC audio cable.



TIPS

- For compatible signal timing (see page 52).
- Use the automatic screen adjustment when a PC screen is displayed for the first time with this connection, or when the setting of the PC is changed (see page 33).
- The type of sync signal is automatically detected (Composite sync, Horizontal/Vertical separate, or Sync-on-green). With some video signals, however, the sync signal may not be detected and images may not be displayed properly.

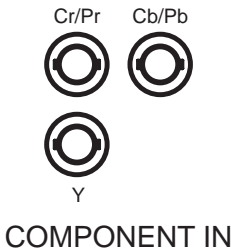

Connecting Peripheral Equipment (Continued)

Connection with AV equipment

Connection with AV equipment with component video output

<p>Component video input terminals</p>  <p>COMPONENT IN</p>	<p>Audio input terminals</p>  <p>AUDIO IN R L</p>
Connect using component (BNC) cables (commercially available).	Connect using audio (RCA pin) cables (commercially available).



Connection with AV equipment with S-video output

<p>S-video input terminal</p>  <p>S-VIDEO IN</p>	<p>Audio input terminals</p>  <p>AUDIO IN R L</p>
Connect using an S-video cable (commercially available).	Connect using audio (RCA pin) cables (commercially available).

TIPS

- The S-video input terminal is compatible with NTSC (3.58 MHz) video input.
- When using the S-video input terminal, do not connect the cable to the composite video input terminal.

Connection with AV equipment with video output

<p>Composite video input terminal</p>  <p>VIDEO IN</p>	<p>Audio input terminals</p>  <p>AUDIO IN R L</p>
Connect using a video (BNC) cable (commercially available).	Connect using audio (RCA pin) cables (commercially available).

TIPS

- The composite video input terminal is compatible with NTSC (3.58 MHz) video input.
- When using the composite video input terminal, do not connect the cable to the S-video input terminal.

Other terminals

Audio output terminals (See page 8.)

- Audio from the equipment connected to the audio input terminals or PC audio input terminal is output. Connect to the audio input terminals of the connected equipment using an audio (RCA) cable (commercially available) or a PC audio cable (commercially available).
- The audio output varies depending on the input mode selection:
 - When the input mode is "DIGITAL" or "ANALOG", the audio from the PC audio input terminal is output.
 - When the input mode is "COMPONENT" or "VIDEO", the audio from the audio input terminals is output.
- The volume of the sound output can be adjusted using the volume adjustment (see page 20).

PC analog RGB output terminal (See page 8.)

Video signals from the PC analog RGB input terminal can be output to an external device. Use this terminal when you connect multiple monitors in a daisy chain via PC analog signal cable (commercially available). (See page 16.)

RS-232C input/output terminals (See page 8.)

You can control the monitor from a PC by connecting an RS-232C straight cable (commercially available) between this terminal and the PC. (See pages 35 and 36.)

Connecting External Speakers

Be sure to use external speakers with an impedance of 6 to 8 ohms and a rated input of at least 7 W.

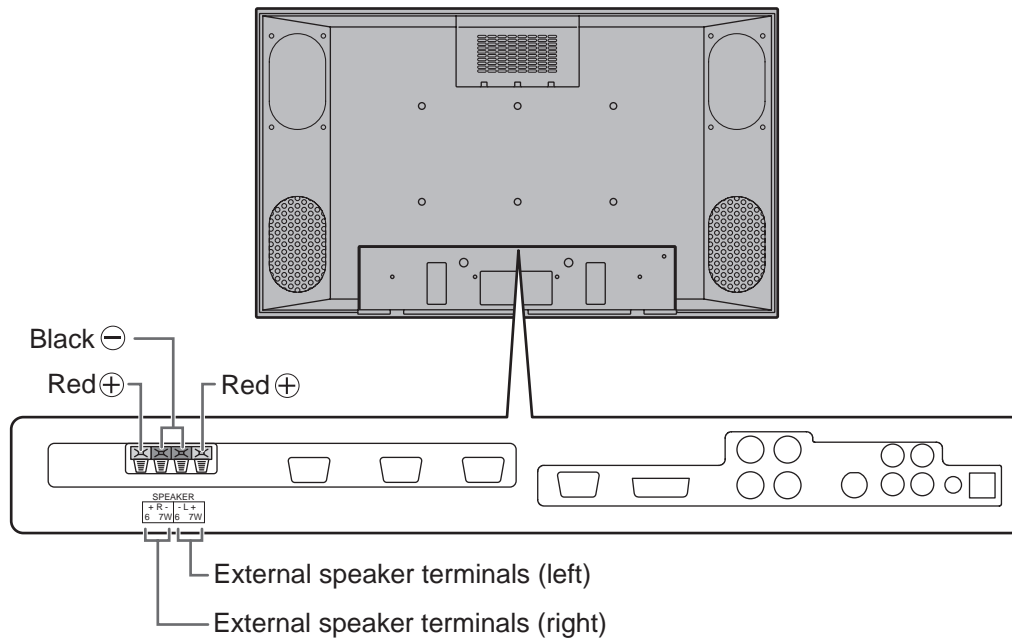

Connecting the speaker cables

1. While pushing the tab, insert the tip of the cable.
2. Release the tab.

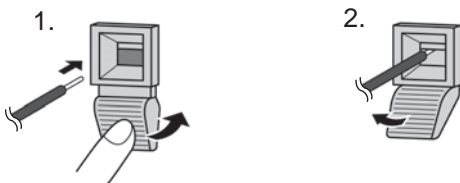

! Caution

Make sure to connect the speaker terminal and cable polarity (⊕, ⊖) properly.
The speaker terminals have plus ⊕ and minus ⊖ polarity. Plus is red and minus is black.
The speaker cables are also divided into plus and minus.
When connecting the left/right speakers, be sure to connect the plus/minus terminals with the correct cables.

Connecting the Power Cord

! Caution

Do not use a power cord other than the one supplied with the monitor.

1. Confirm that the main power switch is set to "OFF".
2. Plug the power cord (supplied) into the AC input terminal.
3. Plug the power cord (supplied) into the AC power outlet.

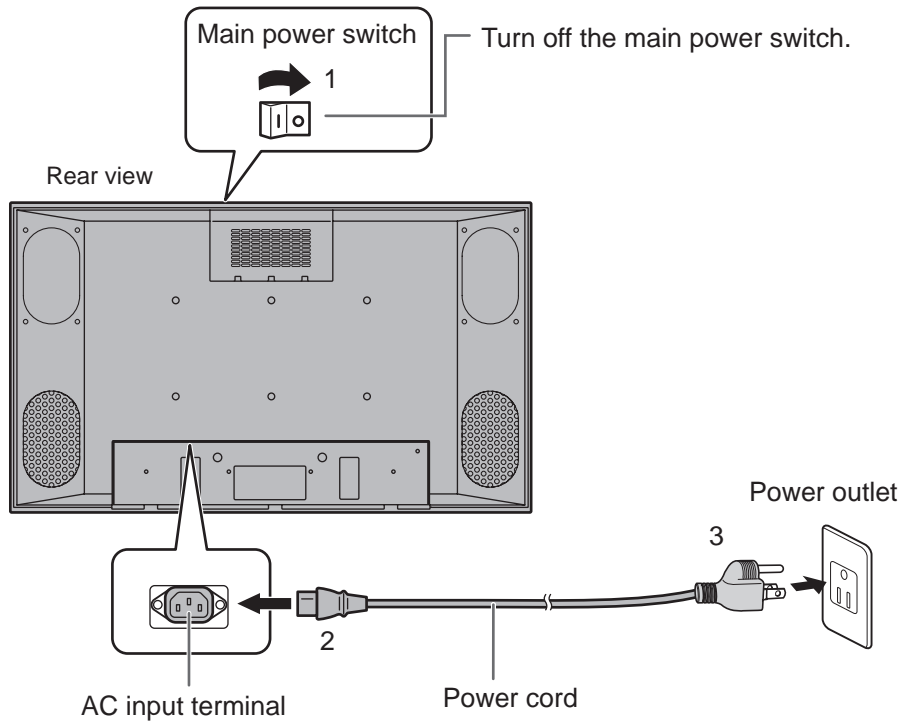

Disconnecting the power cord

1. Confirm that the main power switch is set to "OFF".
2. Unplug the power cord from the AC power outlet.

Connecting Multiple Monitors

You can connect multiple monitors (up to 4 monitors) in a daisy chain by using the PC analog RGB input/output terminals of this monitor.

Connection example

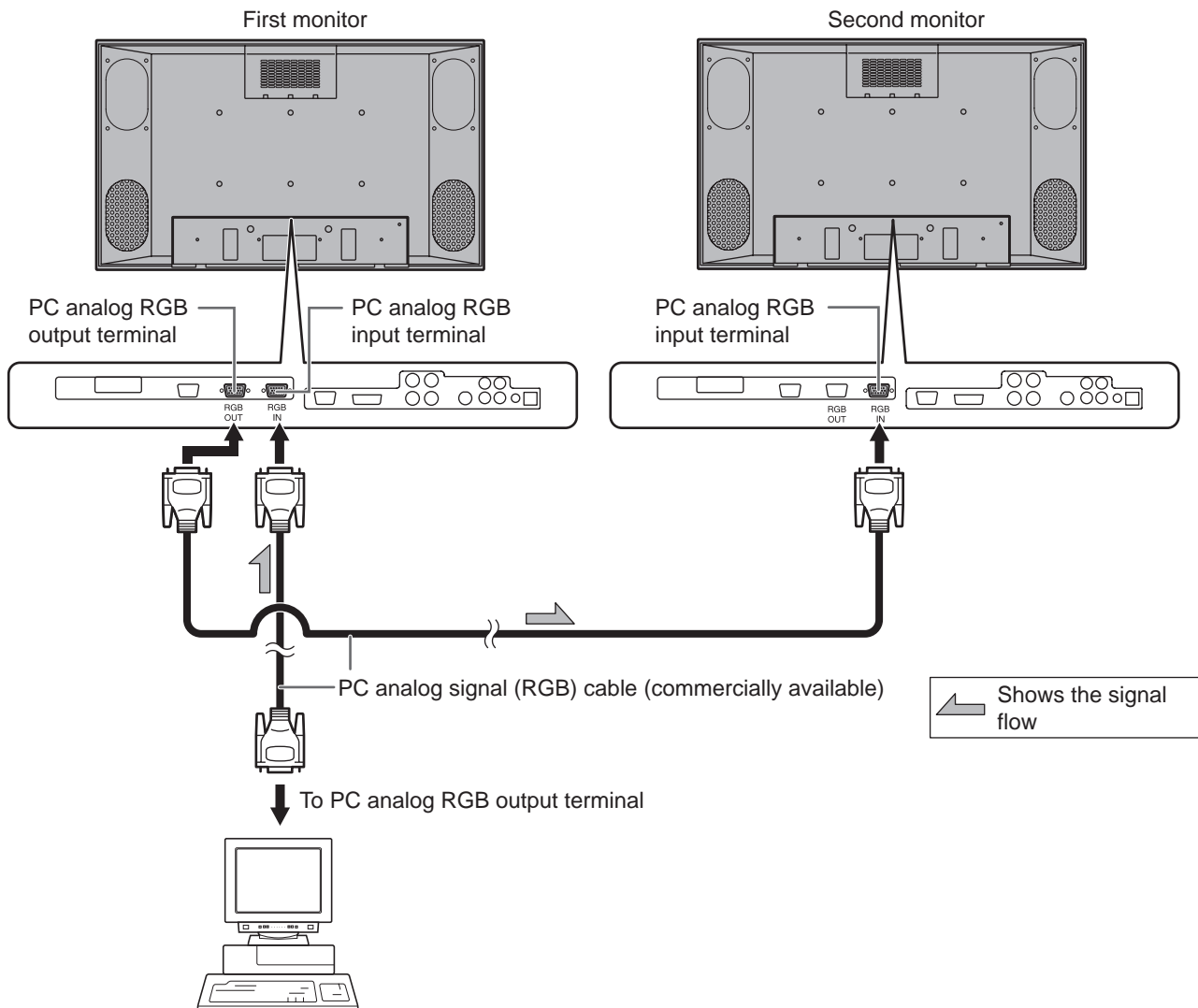

TIPS

- Multiple monitors cannot be connected in a daisy chain for audio. Connect the external audio amplifier (commercially available) to the audio output terminals.
- The length of the signal cables or surrounding environment may affect the image quality.

Binding Cables

The power cord can be fastened using the supplied power cord clamp. This will prevent the power cord from being disconnected accidentally.

Also, the cables connected to the terminals on the back of the monitor can be neatly bundled using the supplied cable clamps as shown in the illustration below.

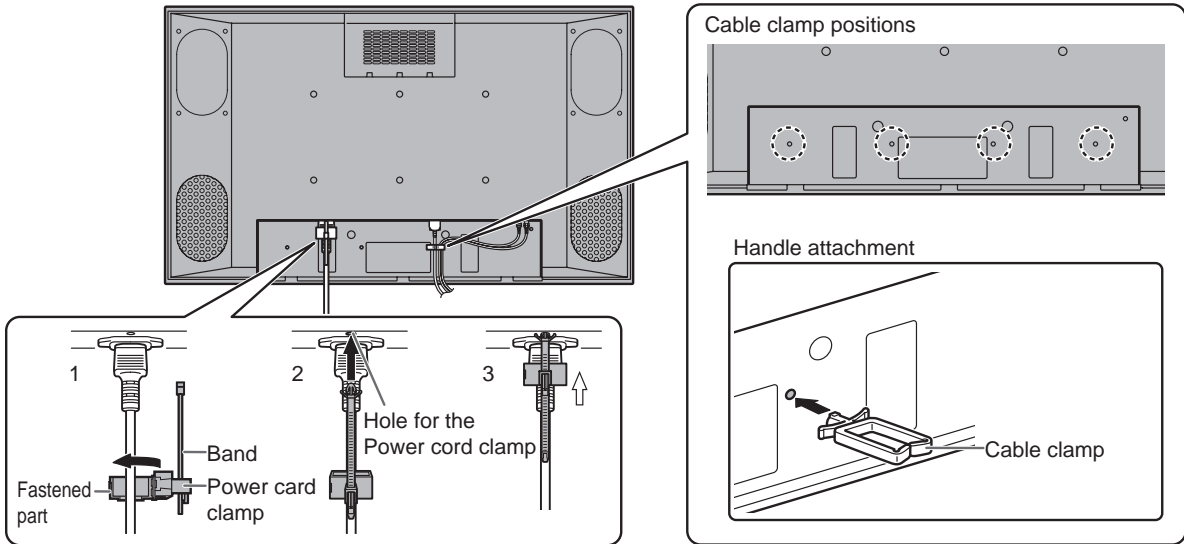

Fastening the power cord

1. Attach the supplied power cord clamp to the power cord, making sure the power cord clamp is circular hole-sided down.
2. Insert the tip of the band into the hole for the power cord clamp.
3. While holding the tail of the band, slide the fastened part toward the AC input terminal.

Attaching the Carrying Handles

When carrying the monitor, attach the two supplied carrying handles to the monitor as shown below. To attach the carrying handles, remove the existing screws from the monitor, and attach the handles with the supplied screws. Keep the removed screws and return them to the original positions on the monitor when the carrying handles are removed.

For the monitor in horizontal orientation
Attach the handles to the two positions on the top of the monitor.

For the monitor in vertical orientation
Attach the handles to the two convenient positions shown below.

Handle attachment

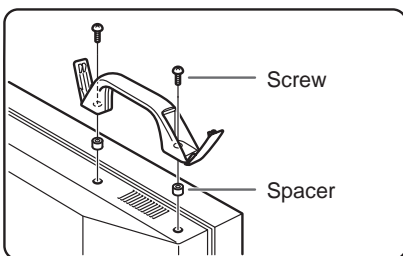

Rear view

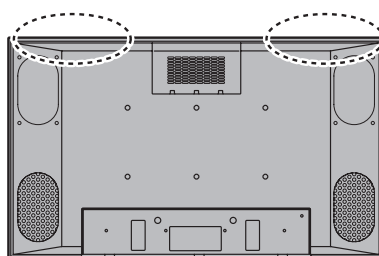

Rear view

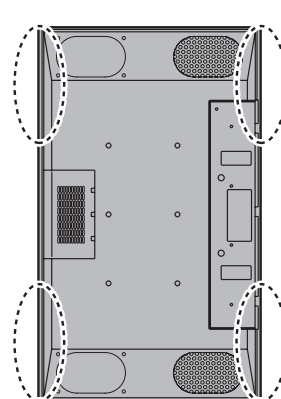

Preparing the Remote Control Unit

Setting the batteries

1. Press the cover gently and slide it in the direction of the arrow.
2. See the instructions in the compartment and put in the supplied batteries (2 "AA" size batteries) with their plus (+) and minus (-) sides oriented correctly.
3. Close the cover.

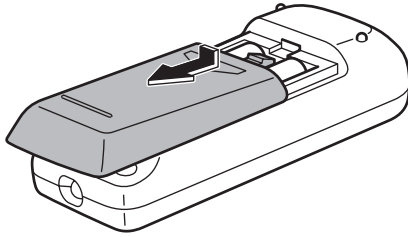

TIPS

- The supplied batteries (2 "AA" size batteries) may become exhausted faster depending on the storage condition. It is recommended that you replace them with new batteries (commercially available) earlier than specified.
- If you will not use the remote control for a long time, remove the batteries.
- If the remote control does not work, even with new batteries, take the batteries out, check whether they are facing the right way, then replace them.
- Do not use rechargeable (Nickel-metal-hydride) batteries.

Remote control operation range

The operation range of the remote control unit is approx. 16.4 feet (5 m) at an angle of approx 10° from the center to the top/bottom/right/left of the remote control sensor.

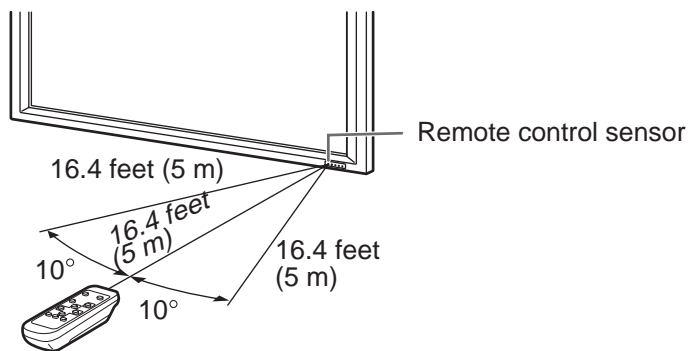

! Caution

- Do not expose the remote control unit to shock by dropping or stepping on it. This could lead to a malfunction.
- Do not expose the remote control unit to liquids, and do not place it in an area with high humidity.
- The remote control unit may not work properly if the remote control sensor is under direct sunlight or strong lighting. In such cases, change the angle of the lighting, or operate the remote control unit closer to the remote control sensor.
- Objects between the remote control unit and the remote control sensor may prevent proper operation.
- Replace the batteries when they run low as this may shorten the remote control's operation range.
- If a fluorescent light is illuminated near the remote control unit, it may interfere with proper operation.
- Do not use it with the remote control of other equipment such as air conditioner, stereo components, etc.

Turning Power On/Off

Before turning on power, make sure that peripherals, external speakers, and the power cord are connected properly.

! Caution

- If the monitor is connected to a PC or a playback device, turn on the monitor first before turning on the PC or playback device.

Turning on the main power switch

When the main power switch is off, the monitor cannot be turned on using the POWER button on the remote control unit.

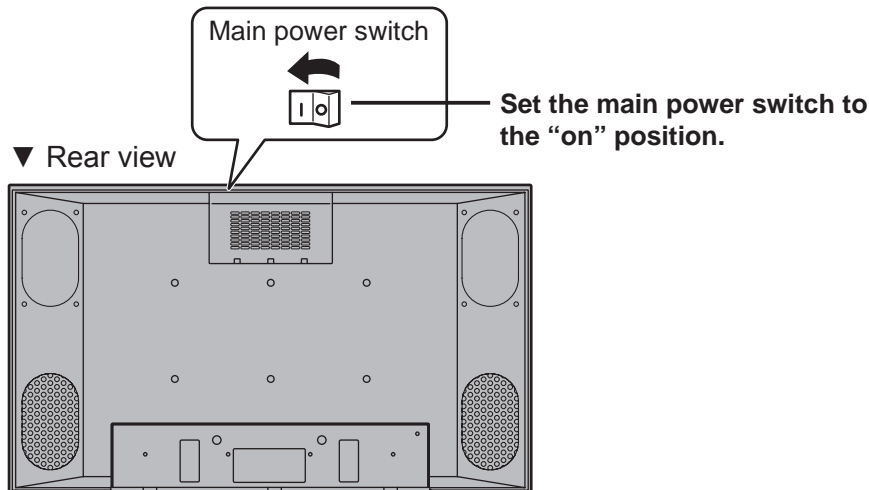

Turning power on/off with the remote control unit

▼ Remote control unit

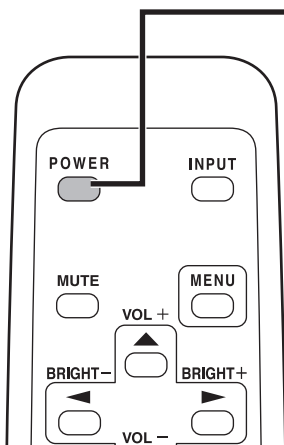

Press the **POWER** button to turn the power **ON/OFF**.
 Power "On": Power LED lights up green.
 Power "Off": Power LED lights up orange. (Standby mode)

▼ Front view

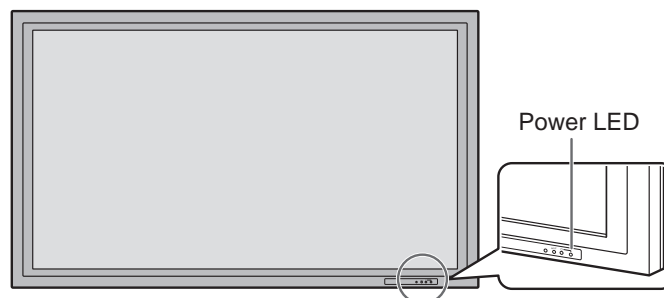

! Caution

- When switching the main power switch or the POWER button off and back on, always wait for at least 5 seconds. Rapid switching may result in a malfunction.

TIPS

- When the input mode (see page 20) is set to "DIGITAL" or "ANALOG" and there is no video signal input, the backlight of the monitor is turned off and the monitor enters input signal waiting mode. (The power LED flashes green.) If the monitor is in this mode and you press the POWER button on the remote control unit, the monitor enters standby mode.
- If the remote control unit is not available, you can turn on/off the monitor by pressing the ⏻ (power) switch beside the power LED with a pointed object. (See page 8)

Basic Operation

Generally the monitor is operated using the remote control unit.

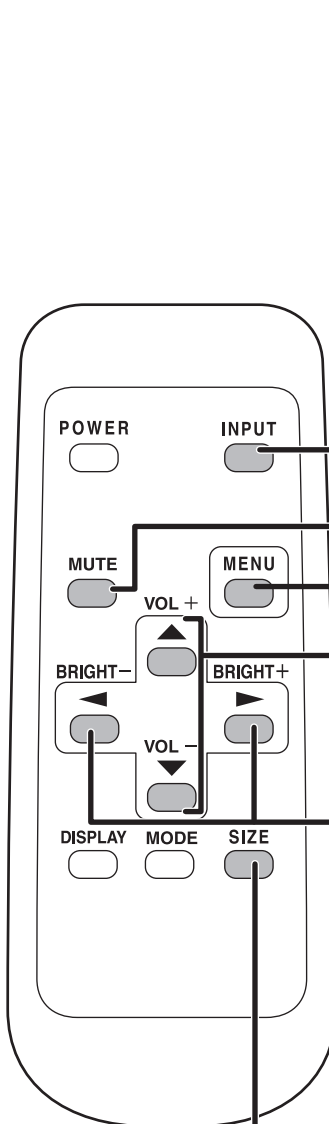

INPUT (Input mode selection)

The input mode selection menu is displayed.

Press or to select the input terminal, and press to change the terminal.

* If the remote control unit is not available, you can select the input terminal by pressing the input switch beside the remote control sensor with a pointed object. (See page 8.)

	Video input	Audio input
DIGITAL	PC digital RGB input terminal	PC audio input terminal
ANALOG	PC analog RGB input terminal	PC audio input terminal
COMPONENT	Component video input terminal	Audio input terminals
VIDEO	Composite video input or S-video input terminal	Audio input terminals

MUTE

Turns off the volume temporarily.

Press the MUTE button again to turn the sound back to the previous level.

MENU

Displays and turns off the menu screen (see page 23).

VOL +/- (Volume adjustment)

Pressing or displays the VOLUME menu when the menu screen is not displayed.



Press to increase the volume, and to decrease the volume.

* If you do not press any buttons for about 4 seconds, the VOLUME menu automatically disappears.

BRIGHT +/- (Backlight adjustment)

Pressing or displays the BRIGHT menu when the menu screen is not displayed.



Press to increase the brightness of the screen, and to decrease the brightness of the screen.

* If you do not press any buttons for about 4 seconds, the BRIGHT menu automatically disappears.

SIZE (Screen size selection)

Each time you press this button, the screen size changes in the following order (see pages 21 and 22):

- WIDE → ZOOM 1 → ZOOM 2 → NORMAL → DotbyDot → WIDE...

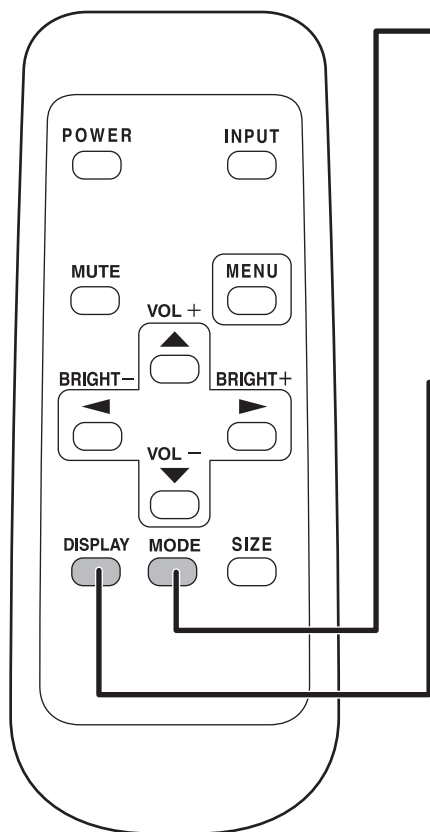

MODE (Screen mode selection)

Each time you press this button, the screen mode changes in the following order:

- STD (Standard) → OFFICE *1 → VIVID → sRGB *2 → STD...

*1 Display brightness is lowerde. (This mode saves power.)

*2 When the input mode is DIGITAL/ANALOG.

sRGB is international standard of color representation specified by IEC (International Electrotechnical Commission).

Color conversion is made in taking account of liquid crystal's characteristics and represents color tone close to its original image.

DISPLAY

Displays monitor information. The display disappears when this button is pressed again or disappears automatically after approximately 15 seconds.

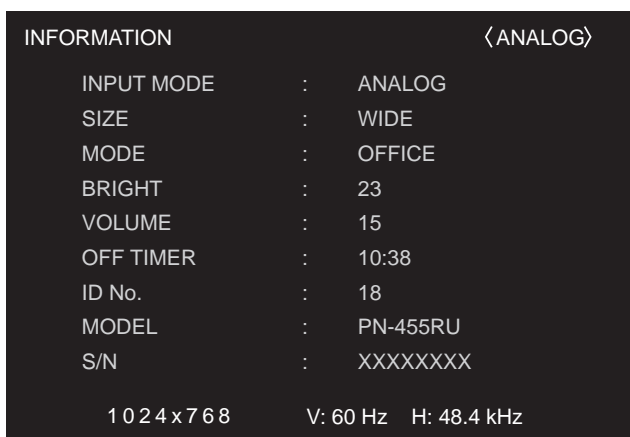

Switching the screen size

■ **Switching the screen size (When the input mode is DIGITAL/ANALOG)**

Even when the screen size is changed, the display may remain the same depending on the input signal.

WIDE	ZOOM 1	ZOOM 2
<p>Displays image so it fills the entire screen.</p>	<p>An image with a 4:3 aspect ratio is enlarged to fill the entire screen without changing the aspect ratio. The upper and lower portion of the image may be cut off.</p>	<p>Use this size if ZOOM 1 cuts off the subtitles.</p>
NORMAL	DotbyDot	<p>* With a monitor with a screen resolution of 1600 x 1200, selecting DotbyDot displays the WIDE screen.</p>
<p>Displays image so it fills the screen vertically, while maintaining the original aspect ratio.</p>	<p>Displays the dots of the signals input from the connected PC as the corresponding dots on the screen. *</p>	

Basic Operation (Continued)

■ Switching the screen size (When the input mode is COMPONENT/VIDEO)

Even when the screen size is changed, the display may remain the same depending on the input signal.

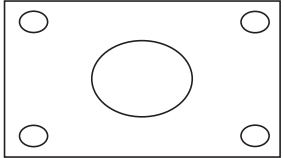
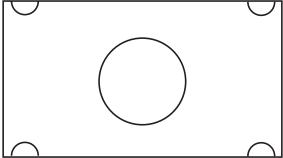
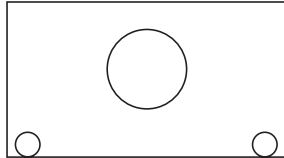
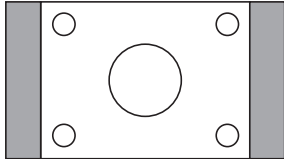
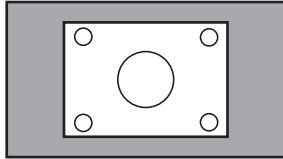
WIDE	ZOOM 1	ZOOM 2
 <p data-bbox="261 539 587 629">An image with a 4:3 aspect ratio is stretched to fill the entire screen.</p>	 <p data-bbox="628 539 963 696">An image with a 4:3 aspect ratio is enlarged to fill the entire screen without changing the aspect ratio. The upper and lower portion of the image may be cut off.</p>	 <p data-bbox="1002 539 1286 600">Use this size if ZOOM 1 cuts off the subtitles.</p>
NORMAL	DotbyDot	
 <p data-bbox="261 934 587 1055">Displays the entire image of the aspect ratio of 4:3 without changing the aspect ratio.</p>	 <p data-bbox="628 934 963 1055">Displays the dots of the input signals as the corresponding dots on the screen.*</p>	

* When you select "DotbyDot" on the COMPONENT and the 525i (525p) video signal is input, the image quality cannot be changed by adjusting the value of "SHARPNESS" from the VIDEO ADJUSTMENT menu.

TIPS

- Using this monitor's screen-size switching or dual-screen display functions to compress or expand the screen for commercial or public viewing in establishments like cafes or hotels may infringe on the rights of the creators, as protected by Copyright Law, so please be careful.
- When "Enlarge" is set, the screen size is fixed to "WIDE" mode.
- When dual-screen display is selected, the screen size cannot be changed.
- When using the screen-size switching function of this monitor, the appearance of the original video may change if you select a screen size with a different aspect ratio than the original image (e.g. TV broadcast or video input from external equipment). Please consider this point when selecting the screen size.
- When an ordinary non-wide image (4:3) is viewed with the whole screen using the screen-size switching function of this monitor, the edge of the image may be lost or appear distorted. If you wish to respect the creator's intentions, set the screen size to "NORMAL".
- When playing commercial software, parts of the image (like subtitles) may be cropped. In this case select the optimal screen size using the screen-size switching function of this monitor. With some software, there may be noise or distortion at the edges or top of the screen. This is due to the characteristics of the software, and is not a malfunction.
- Depending on the original image size (e.g. CinemaScope size), black bands may remain at the top and bottom of the screen.

Menu Items

Menus can be displayed on the screen to enable video and audio adjustment and the setting of various functions using the remote control unit. For more information, refer to the pages where each topic is explained.

Displaying the menu screen

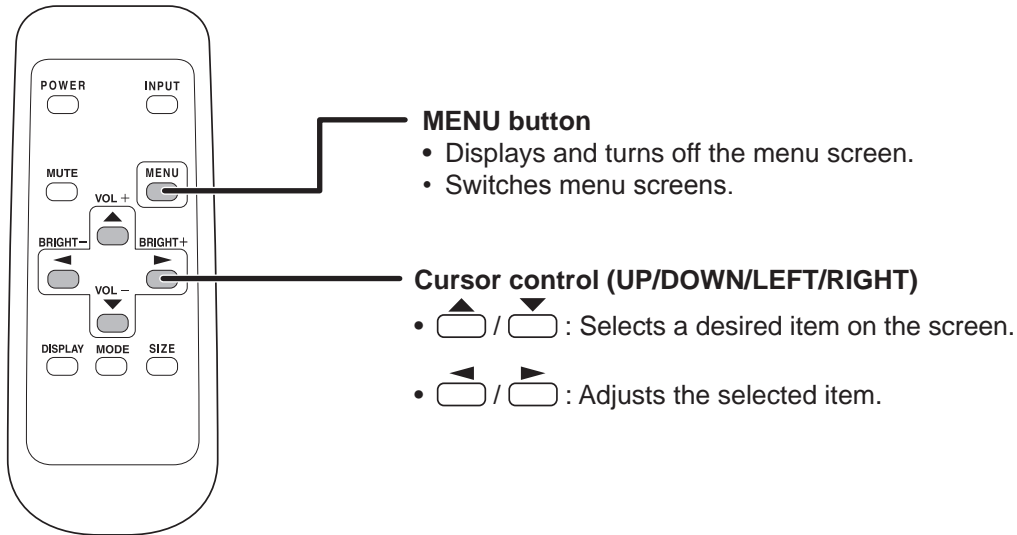

Example of menu operation: Adjusting CONTRAST in the GAIN CONTROL menu.

1. Press to display the menu screen.

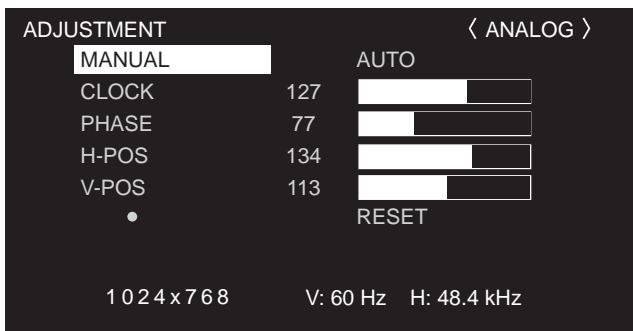

2. Press to display the GAIN CONTROL menu.

3. Press to select CONTRAST.

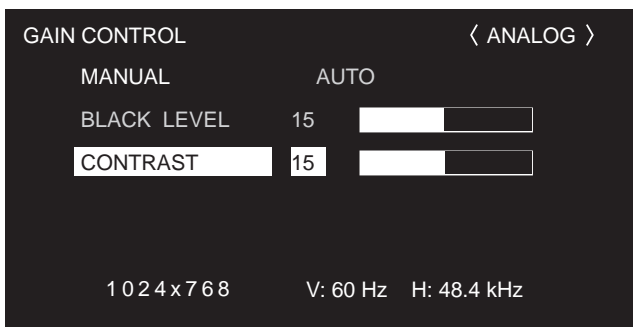

Menu Items (Continued)

4. Press  (or ) to adjust the setting.

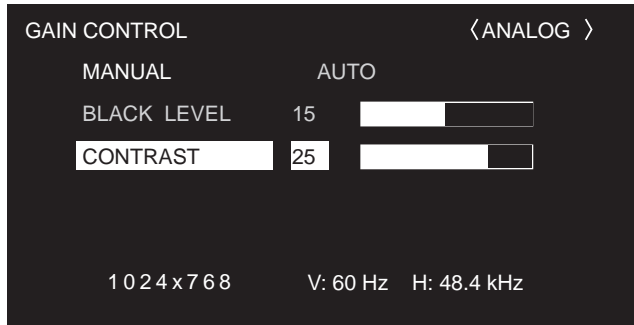

5. Press  to close the menu screen.

The menu screen will close automatically if no operation is performed for about 15 seconds.

TIPS

- The menu displayed when you press  will differ depending on the input mode selection. (See pages 25 to 27.)

The display and indication of the items on each menu screen are common as follows:

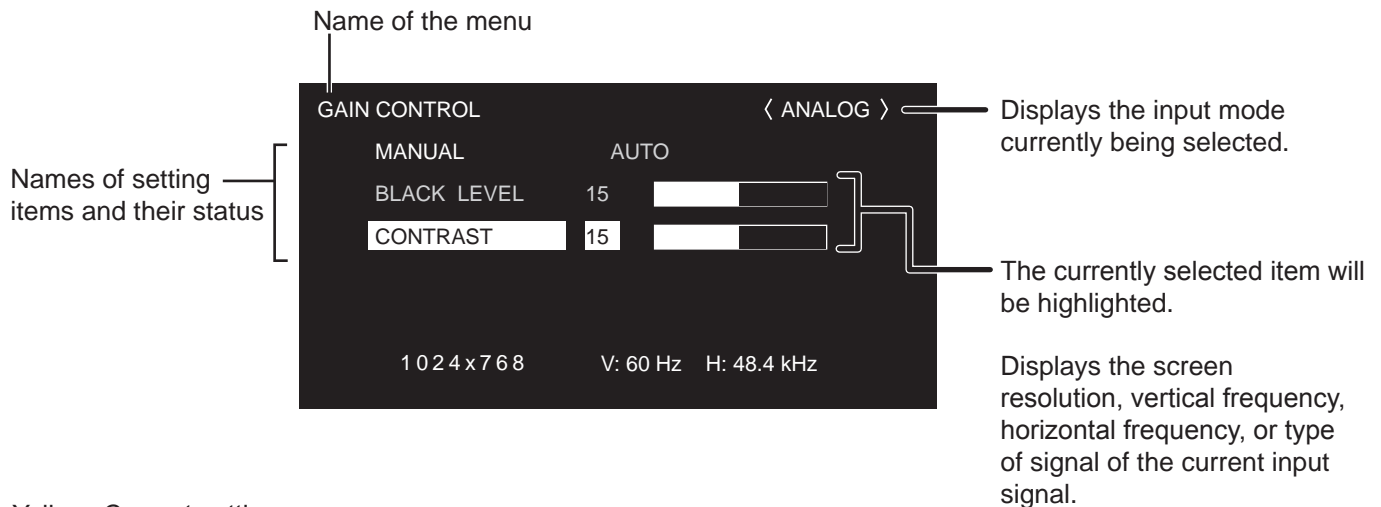

Yellow: Current setting

Blue: Selectable items

Gray: Item that cannot be selected (e.g. Function not supported by the current input signal)

Menu Option Reference Chart

■ DIGITAL

GAIN CONTROL (See page 28.)	BLACK LEVEL	0 to 31
	CONTRAST	0 to 31

COLOR CONTROL (See page 28.)	WHITE BALANCE	1.8, 2.2, 2.4	THRU	1 to 15	R-CONTRAST	0 to 255
	COPY TO USER		PRESET		G-CONTRAST	0 to 255
	GAMMA		USER		B-CONTRAST	0 to 255

MODE SELECT 1 (See page 29.)	BEZEL	V:0 to 100, H:0 to 100	
	ENLARGE	OFF, 2x2, 3x3, 4x4, 5x5	
	ENLARGE-POS	0 to 3 for 2 x 2, 0 to 8 for 3 x 3, 0 to 15 for 4 x 4, 0 to 24 for 5 x 5	
	MULTI ZOOM	IMAGE ZOOM	
	AUDIO		H-POS
			V-POS
		TREBLE	-10 to +10
		BASS	-10 to +10
		BALANCE	-10 to +10

MODE SELECT 2 (See page 29.)	OFF TIMER	0 to 23
	OSD H-POSITION	
	OSD V-POSITION	
	LANGUAGE	ENGLISH
	SCREEN MOTION	OFF, ON
	MOTION TIME 1	0 to 20
	MOTION TIME 2	10 to 990
	POWER ON DELAY	0 to 60
	OSD ROTATION	
	ID No. SET	0 to 255

MODE SELECT 3 (See page 30.)	PIP MODES	OFF, PIP, PbyP, PbyP2
	PIP SIZE	SMALL, MEDIUM, LARGE
	PIP H-POS	0 to 100
	PIP V-POS	0 to 100
	PIP BLEND	0 to 15
	PIP SOURCE	COMPONENT, VIDEO
	SOUND CHANGE	PC, AV
	MAIN POS	POS1, POS2
	PbyP2 POS	POS1, POS2, POS3
	AUTO OFF	MANUAL, AUTO

Menu Items (Continued)

ANALOG

ADJUSTMENT (See page 28.)	<table border="1"> <tr><td>MANUAL</td></tr> <tr><td>AUTO</td></tr> <tr><td>RESET</td></tr> </table>	MANUAL	AUTO	RESET	→	<table border="1"> <tr><td>CLOCK</td><td>0 to 255</td></tr> <tr><td>PHASE</td><td>0 to 255</td></tr> <tr><td>H-POS</td><td>0 to 255</td></tr> <tr><td>V-POS</td><td>0 to 255</td></tr> </table>	CLOCK	0 to 255	PHASE	0 to 255	H-POS	0 to 255	V-POS	0 to 255												
MANUAL																										
AUTO																										
RESET																										
CLOCK	0 to 255																									
PHASE	0 to 255																									
H-POS	0 to 255																									
V-POS	0 to 255																									
GAIN CONTROL (See page 28.)	<table border="1"> <tr><td>MANUAL</td></tr> <tr><td>AUTO</td></tr> </table>	MANUAL	AUTO	→	<table border="1"> <tr><td>BLACK LEVEL</td><td>0 to 31</td></tr> <tr><td>CONTRAST</td><td>0 to 31</td></tr> </table>	BLACK LEVEL	0 to 31	CONTRAST	0 to 31																	
MANUAL																										
AUTO																										
BLACK LEVEL	0 to 31																									
CONTRAST	0 to 31																									
COLOR CONTROL (See page 28.)	<table border="1"> <tr><td>WHITE BALANCE</td></tr> <tr><td>COPY TO USER</td></tr> <tr><td>GAMMA</td></tr> </table>	WHITE BALANCE	COPY TO USER	GAMMA	→	<table border="1"> <tr><td>PRESET</td><td>1 to 15</td></tr> <tr><td>USER</td><td>1.8, 2.2, 2.4</td></tr> </table>	PRESET	1 to 15	USER	1.8, 2.2, 2.4	→	<table border="1"> <tr><td>R-CONTRAST</td><td>0 to 255</td></tr> <tr><td>G-CONTRAST</td><td>0 to 255</td></tr> <tr><td>B-CONTRAST</td><td>0 to 255</td></tr> </table>	R-CONTRAST	0 to 255	G-CONTRAST	0 to 255	B-CONTRAST	0 to 255								
WHITE BALANCE																										
COPY TO USER																										
GAMMA																										
PRESET	1 to 15																									
USER	1.8, 2.2, 2.4																									
R-CONTRAST	0 to 255																									
G-CONTRAST	0 to 255																									
B-CONTRAST	0 to 255																									
MODE SELECT1 (See page 29.)	<table border="1"> <tr><td>480 LINES</td><td>848, 640</td></tr> <tr><td>768 LINES</td><td>1360, 1280, 1024</td></tr> <tr><td>BEZEL</td><td>V:0 to 100, H:0 to 100</td></tr> <tr><td>ENLARGE</td><td>OFF, 2x2, 3x3, 4x4, 5x5</td></tr> <tr><td>ENLARGE-POS</td><td>0 to 3 for 2 x 2, 0 to 8 for 3 x 3, 0 to 15 for 4 x 4, 0 to 24 for 5 x 5</td></tr> <tr><td>MULTI ZOOM</td></tr> <tr><td>AUDIO</td></tr> </table>	480 LINES	848, 640	768 LINES	1360, 1280, 1024	BEZEL	V:0 to 100, H:0 to 100	ENLARGE	OFF, 2x2, 3x3, 4x4, 5x5	ENLARGE-POS	0 to 3 for 2 x 2, 0 to 8 for 3 x 3, 0 to 15 for 4 x 4, 0 to 24 for 5 x 5	MULTI ZOOM	AUDIO	→	<table border="1"> <tr><td>IMAGE ZOOM</td></tr> <tr><td>H-POS</td></tr> <tr><td>V-POS</td></tr> </table>	IMAGE ZOOM	H-POS	V-POS	→	<table border="1"> <tr><td>TREBLE</td><td>-10 to +10</td></tr> <tr><td>BASS</td><td>-10 to +10</td></tr> <tr><td>BALANCE</td><td>-10 to +10</td></tr> </table>	TREBLE	-10 to +10	BASS	-10 to +10	BALANCE	-10 to +10
480 LINES	848, 640																									
768 LINES	1360, 1280, 1024																									
BEZEL	V:0 to 100, H:0 to 100																									
ENLARGE	OFF, 2x2, 3x3, 4x4, 5x5																									
ENLARGE-POS	0 to 3 for 2 x 2, 0 to 8 for 3 x 3, 0 to 15 for 4 x 4, 0 to 24 for 5 x 5																									
MULTI ZOOM																										
AUDIO																										
IMAGE ZOOM																										
H-POS																										
V-POS																										
TREBLE	-10 to +10																									
BASS	-10 to +10																									
BALANCE	-10 to +10																									
MODE SELECT 2 (See page 29.)	<table border="1"> <tr><td>OFF TIMER</td><td>0 to 23</td></tr> <tr><td>OSD H-POSITION</td></tr> <tr><td>OSD V-POSITION</td></tr> <tr><td>LANGUAGE</td></tr> <tr><td>SCREEN MOTION</td><td>OFF, ON</td></tr> <tr><td>MOTION TIME 1</td><td>0 to 20</td></tr> <tr><td>MOTION TIME 2</td><td>10 to 990</td></tr> <tr><td>POWER ON DELAY</td><td>0 to 60</td></tr> <tr><td>OSD ROTATION</td></tr> <tr><td>ID No. SET</td><td>0 to 255</td></tr> </table>	OFF TIMER	0 to 23	OSD H-POSITION	OSD V-POSITION	LANGUAGE	SCREEN MOTION	OFF, ON	MOTION TIME 1	0 to 20	MOTION TIME 2	10 to 990	POWER ON DELAY	0 to 60	OSD ROTATION	ID No. SET	0 to 255	→	<table border="1"> <tr><td>ENGLISH</td></tr> <tr><td>DEUTSCH</td></tr> <tr><td>FRANÇAIS</td></tr> <tr><td>ITALIANO</td></tr> <tr><td>ESPAÑOL</td></tr> </table>	ENGLISH	DEUTSCH	FRANÇAIS	ITALIANO	ESPAÑOL		
OFF TIMER	0 to 23																									
OSD H-POSITION																										
OSD V-POSITION																										
LANGUAGE																										
SCREEN MOTION	OFF, ON																									
MOTION TIME 1	0 to 20																									
MOTION TIME 2	10 to 990																									
POWER ON DELAY	0 to 60																									
OSD ROTATION																										
ID No. SET	0 to 255																									
ENGLISH																										
DEUTSCH																										
FRANÇAIS																										
ITALIANO																										
ESPAÑOL																										
MODE SELECT 3 (See page 30.)	<table border="1"> <tr><td>PIP MODES</td><td>OFF, PIP, PbyP, PbyP2</td></tr> <tr><td>PIP SIZE</td><td>SMALL, MEDIUM, LARGE</td></tr> <tr><td>PIP H-POS</td><td>0 to 100</td></tr> <tr><td>PIP V-POS</td><td>0 to 100</td></tr> <tr><td>PIP BLEND</td><td>0 to 15</td></tr> <tr><td>PIP SOURCE</td><td>COMPONENT, VIDEO</td></tr> <tr><td>SOUND CHANGE</td><td>PC, AV</td></tr> <tr><td>MAIN POS</td><td>POS1, POS2</td></tr> <tr><td>PbyP2 POS</td><td>POS1, POS2, POS3</td></tr> <tr><td>AUTO OFF</td><td>MANUAL, AUTO</td></tr> </table>	PIP MODES	OFF, PIP, PbyP, PbyP2	PIP SIZE	SMALL, MEDIUM, LARGE	PIP H-POS	0 to 100	PIP V-POS	0 to 100	PIP BLEND	0 to 15	PIP SOURCE	COMPONENT, VIDEO	SOUND CHANGE	PC, AV	MAIN POS	POS1, POS2	PbyP2 POS	POS1, POS2, POS3	AUTO OFF	MANUAL, AUTO					
PIP MODES	OFF, PIP, PbyP, PbyP2																									
PIP SIZE	SMALL, MEDIUM, LARGE																									
PIP H-POS	0 to 100																									
PIP V-POS	0 to 100																									
PIP BLEND	0 to 15																									
PIP SOURCE	COMPONENT, VIDEO																									
SOUND CHANGE	PC, AV																									
MAIN POS	POS1, POS2																									
PbyP2 POS	POS1, POS2, POS3																									
AUTO OFF	MANUAL, AUTO																									

■ COMPONENT/VIDEO

VIDEO ADJUSTMENT (See page 29.)	CONTRAST	0 to 31
	BLACK LEVEL	0 to 31
	TINT	0 to 31
	COLORS	0 to 31
	SHARPNESS	0 to 31
	WHITE BALANCE	1 to 15
	GAMMA	1.8, 2.2, 2.4

MODE SELECT 1 (See page 29.)	AUDIO	→	TREBLE	-10 to +10
			BASS	-10 to +10
			BALANCE	-10 to +10

MODE SELECT 2 (See page 29.)	OFF TIMER	0 to 23	
	OSD H-POSITION		
	OSD V-POSITION		
	LANGUAGE	→	ENGLISH
	SCREEN MOTION	OFF, ON	DEUTSCH
	MOTION TIME 1	0 to 20	FRANÇAIS
	MOTION TIME 2	10 to 990	ITALIANO
	POWER ON DELAY	0 to 60	ESPAÑOL
	OSD ROTATION		
	ID No. SET	0 to 255	

MODE SELECT 3 (See page 30.)	PIP MODES	OFF, PIP, PbyP, PbyP2
	PIP SIZE	SMALL, MEDIUM, LARGE
	PIP H-POS	0 to 100
	PIP V-POS	0 to 100
	PIP BLEND	0 to 15
	PIP SOURCE	DIGITAL, ANALOG
	SOUND CHANGE	PC, AV
	MAIN POS	POS1, POS2
	PbyP2 POS	POS1, POS2, POS3
	AUTO OFF	MANUAL, AUTO

Menu Items (Continued)

Menu item details

The menu will differ depending on the input mode.

■ ADJUSTMENT (ANALOG)

[MANUAL / AUTO]

Function	Adjusts CLOCK, PHASE, H-POS (horizontal positioning), and V-POS (vertical positioning).
MANUAL	The CLOCK, PHASE, H-POS, and V-POS are manually adjusted. You can use the adjustment pattern on the supplied CD-ROM to adjust each parameter. For more information, refer to "Adjustments for PC screen display" on page 33.
AUTO	The CLOCK, PHASE, H-POS, and V-POS are automatically adjusted. Use this automatic adjustment when you use the PC analog RGB input terminal to display a PC screen for the first time or when you change the setting of the PC. (See page 33.)

[MANUAL (CLOCK)]

Function	Adjusts frequency for sampling clock for applicable video. Adjust when there is flickering in the form of vertical stripes. When using the adjustment pattern (see page 33), make adjustments so that no vertical stripe noise appears in it.
+ direction	Clock frequency increases.
- direction	Clock frequency decreases.

[MANUAL (PHASE)]

Function	Adjusts sampling clock phase for applicable video. Useful when small characters appear with low contrast and/or there are flickers at corners. When using the adjustment pattern (see page 33), make adjustments so that no horizontal stripe noise appears in it.
+ direction	Advances clock phase.
- direction	Delays clock phase.

[MANUAL (H-POS)]

How to adjust	Adjust the horizontal position of the image with the RIGHT/LEFT cursor control button.
---------------	--

[MANUAL (V-POS)]

How to adjust	Adjust the vertical position of the image with the RIGHT/LEFT cursor control button.
---------------	--

[RESET]

RESET	Resets the values of the ADJUSTMENT menu items to the factory preset values. When  is pressed, the values are reset (initialized).
-------	---

■ GAIN CONTROL (DIGITAL/ANALOG)

[MANUAL / AUTO] (ANALOG)

Function	Adjusts BLACK LEVEL and CONTRAST.
MANUAL	The BLACK LEVEL and CONTRAST can be adjusted manually by checking the adjustment pattern. (See page 33.)
AUTO	The BLACK LEVEL and CONTRAST are automatically adjusted.

[MANUAL (BLACK LEVEL)]

+ direction	Brightens entire video signal.
- direction	Darkens entire video signal.

[MANUAL (CONTRAST)]

+ direction	For more contrast
- direction	For less contrast

■ COLOR CONTROL (DIGITAL/ANALOG)

[WHITE BALANCE (color temperature)]

THRU (through) PRESET	Displays the input signal level as is. (for DIGITAL only) Allows selection from the preadjusted settings. (For a guide to the color temperatures of the adjustment values, see page 31.)
USER	Used for adjustment by selecting R-CONTRAST (red contrast), G-CONTRAST (green contrast), and B-CONTRAST (blue contrast).

[USER (R-CONTRAST)]

+ direction	Brightens red component.
- direction	Darkens red component.

[USER (G-CONTRAST)]

+ direction	Brightens green component.
- direction	Darkens green component.

[USER (B-CONTRAST)]

+ direction	Brightens blue component.
- direction	Darkens blue component.

[COPY TO USER]

SET	Copies the value set for PRESET to the USER setting.
-----	--

[GAMMA]

Function	Select a gamma value.
----------	-----------------------

■ VIDEO ADJUSTMENT (COMPONENT/VIDEO)

[CONTRAST]	
+ direction	For more contrast
- direction	For less contrast
[BLACK LEVEL]	
+ direction	Brightens entire video signal.
- direction	Darkens entire video signal.
[TINT]	
+ direction	Adjust the hue in the required direction so that the color takes on a green tinge.
- direction	Adjust the hue in the required direction so that the color takes on a magenta tinge.
[COLORS]	
+ direction	For more color intensity
- direction	For less color intensity (Monochrome at "0")
[SHARPNESS]	
+ direction	For more sharpness
- direction	For less sharpness
[WHITE BALANCE]	
Function	Allows selection from the preadjusted settings. (For a guide to the color temperatures of the adjustment values, see page 31.)
[GAMMA]	
Function	Select a gamma value.





■ MODE SELECT 1

[480 LINES] (ANALOG)	
Function	Manually selects input resolution.
[768 LINES] (ANALOG)	
Function	Manually selects input resolution.
[BEZEL] (DIGITAL/ANALOG)	
Function	Sets the frame width of the LCD panel (V: Vertical width, H: Horizontal width) when the enlargement function is used. When the monitor is installed in vertical orientation, specify as "V: Horizontal, H: Vertical".
[ENLARGE] (DIGITAL/ANALOG)	
Function	Sets the image enlargement ratio to be enlarged.
[ENLARGE POS] (DIGITAL/ANALOG)	
Function	Sets the part of the original image to be enlarged.

[MULTI ZOOM] (DIGITAL/ANALOG)	
Function	Adjusts the enlarged screen. Pressing  displays the next menu.
IMAGE ZOOM	Adjusts the scale of enlargement.
H-POS	Adjusts the horizontal position. (Vertical position when the monitor is used in vertical orientation.)
V-POS	Adjusts the vertical position. (Horizontal position when the monitor is used in vertical orientation.)

[AUDIO]	
Function	Adjust the volume of the sound output from the speaker. Pressing  displays the next menu.
TREBLE	Adjusts the volume of treble-level sound.
BASS	Adjusts the volume of bass-level sound.
BALANCE	Adjusts the balance of the audio sound between right and left.

■ MODE SELECT 2



[OFF TIMER]	
Function	Set the time until the monitor turns off (enters standby mode) between 0 and 23 in units of one hour. This function is disabled when 0 is specified.
[OSD H-POSITION]	
Function	Adjusts the horizontal display position of menu screen.
How to adjust	Use  /  to move menu screen.
[OSD V-POSITION]	
Function	Adjusts the vertical display position of menu screen.
How to adjust	Use  /  to move menu screen.
[LANGUAGE]	
Function	Sets the display language for the menu screen. Pressing  displays the next menu.
[SCREEN MOTION]	
[MOTION TIME 1]	
[MOTION TIME 2]	
Function	Sets the monitor to reduce the residual image on the screen. (See page 33.)
[POWER ON DELAY]	
Function	You can delay the screen display after the monitor is turned on. The period can be set up to 60 seconds in units of one second. When this function is activated, the power LED flashes in orange. This function is disabled when 0 is specified.

Menu Items (Continued)

[OSD ROTATION]

Function	Rotates the menu screen 90 degrees for when the monitor is used in vertical orientation.
----------	--

[ID No. SET]

Function	Assigns ID numbers to monitors connected in a daisy chain (see page 38), using RS-232C cables.
Note	The numbers 1 to 255 are available for ID numbers. (If "0" is set, the system regards this as the state where no ID number is set.) Although numbers up to 255 can be used for monitor IDs, the number of connectable monitors varies depending on the length of RS-232C cables and the installation environment. Use  /  to increase or decrease values.

■ MODE SELECT 3

[PIP MODES] (See page 31)

Function	Sets the display method.
OFF	Displays one screen.
PIP	Displays a sub screen inside a main screen.
PbyP	Displays a main screen and a sub screen side by side.
PbyP2	Displays a main screen which measures 1280 in width and a sub screen side by side.

[PIP SIZE]

Function	Sets the size of the sub screen in PIP mode.
----------	--

[PIP H-POS]

Function	Adjusts the horizontal position of the sub screen in PIP mode.
----------	--

[PIP V-POS]

Function	Adjusts the vertical position of the sub screen in PIP mode.
----------	--

[PIP BLEND]

Function	Displays the sub screen transparently on the main screen in PIP mode.
----------	---

[PIP SOURCE]

Function	Selects the signal input of the sub screen in PIP (Picture in Picture), PbyP (Picture by Picture), or PbyP2 mode.
----------	---

[SOUND CHANGE]

Function	Outputs the specified sound in PIP, PbyP, or PbyP2 mode. If the main screen is displayed as a full screen by the AUTO OFF function, the sound for the main screen is output even when the sound for the sub screen is specified.
----------	--

[MAIN POS]

Function	Sets the position of the main screen in PbyP or PbyP2 mode.
----------	---

[PbyP2 POS]

Function	Sets the position of the sub screen in PbyP2 mode.
----------	--

[AUTO OFF]

Function	Sets whether to display the main screen as a full screen in PIP, PbyP, or PbyP2 mode when there is no signal input for the sub screen.
AUTO	Displays the main screen as a full screen when there is no signal input for the sub screen.
MANUAL	Displays the sub screen in black when there is no signal input for the sub screen.

TIPS

- When WHITE BALANCE is set to THRU, BLACK LEVEL, CONTRAST and GAMMA cannot be set.
- When MODE is set to sRGB or VIVID, COLOR CONTROL cannot be set. (DIGITAL/ANALOG)
- When MODE is VIVID, WHITE BALANCE and GAMMA cannot be set. (COMPONENT/VIDEO)

■ Guide to the color temperatures of the adjustment values

The following is a guide to the color temperatures of the respective adjustment values for WHITE BALANCE.

Factory-adjusted value is "13" (approx. 9,000K).

Adjustment value	Color temperature (K)	Adjustment value	Color temperature (K)	Adjustment value	Color temperature (K)
15	app. 10,000	10	app. 7,500	5	app. 5,000
14	app. 9,500	9	app. 7,000	4	app. 4,500
13	app. 9,000	8	app. 6,500	3	app. 4,000
12	app. 8,500	7	app. 6,000	2	app. 3,500
11	app. 8,000	6	app. 5,500	1	app. 3,000

■ Dual screen display

You can display the screens of the PC input signal (ANALOG/DIGITAL) and AV input signal (COMPONENT/VIDEO) simultaneously.

Set this function with "PIP MODES" in the MODE SELECT 3 menu. (See page 30.)

- The currently selected input signal is displayed on the main screen.
- You cannot simultaneously display the screens of signals of the same type, such as two types of PC input signals or two types of AV input signals.

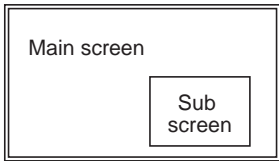
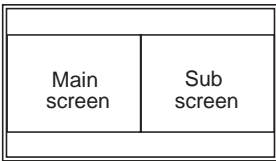
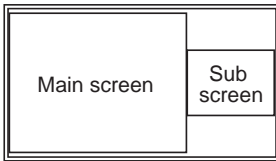
PIP	PbyP	PbyP2
<p>Example</p>  <p>A sub screen is displayed inside a main screen.</p>	<p>Example</p>  <p>A main screen and a sub screen are displayed side by side.*</p>	<p>Example</p>  <p>A main screen of 1280 width size and a sub screen are displayed side by side.</p>

* When you select "COMPONENT" on the PbyP main screen and the 1125i (1080i) video signal is input, the image quality cannot be changed even if you adjust the value for "SHARPNESS" on the VIDEO ADJUSTMENT menu.

TIPS

- You might infringe on a copyright of the author which is protected by copyright law when you display the images of the computer screen and television/VCR simultaneously for profit-making or to show the image to the public.
- The screen size for dual-screen display is the same as the screen size for single-screen display. The DotbyDot screen is displayed in NORMAL size except when it is set as the PIP main screen.
- When dual-screen display is selected, the SCREEN MOTION function is disabled.
- When dual-screen display is selected, the screen cannot be enlarged.
You cannot rotate the menu screen with OSD ROTATION.

Menu Items (Continued)

■ Enlarge

You can set up 4, 9, 16, or 25 monitors and integrate them into a single large screen to display video. Each monitor displays an enlargement of 1/4, 1/9, 1/16, or 1/25 of the original image.

TIPS

- AV input signals (COMPONENT/VIDEO) cannot be used for the Enlarge function.
- To integrate 9 or more monitors using ANALOG signals, a splitter for the video signal (commercially available) is required.
- To use signals other than ANALOG signals, a splitter for the video signal (commercially available) is required.
- When Enlarge is used, the SCREEN MOTION function is disabled.

For the monitor in horizontal orientation

• 4 screen monitor set-up

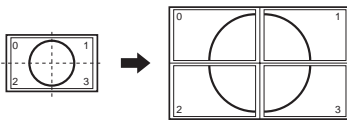

• 9 screen monitor set-up

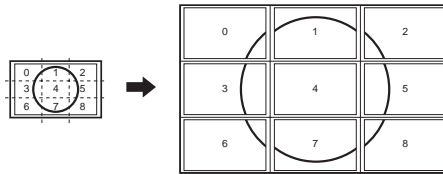

• 16 screen monitor set-up

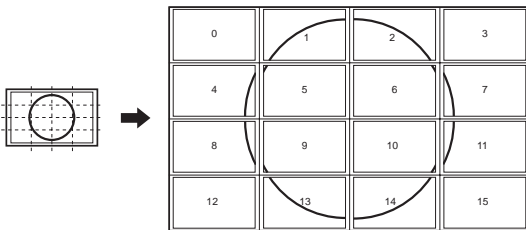

• 25 screen monitor set-up

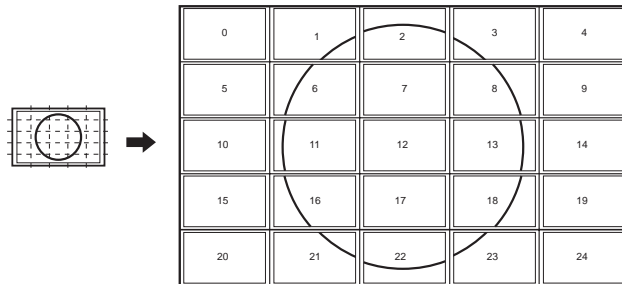

For the monitor in vertical orientation

• 4 screen monitor set-up

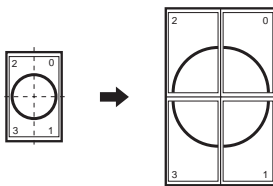

• 9 screen monitor set-up

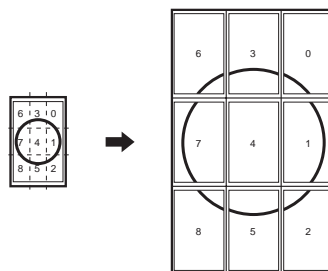

• 16 screen monitor set-up

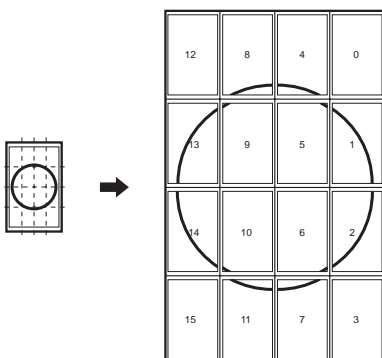

• 25 screen monitor set-up

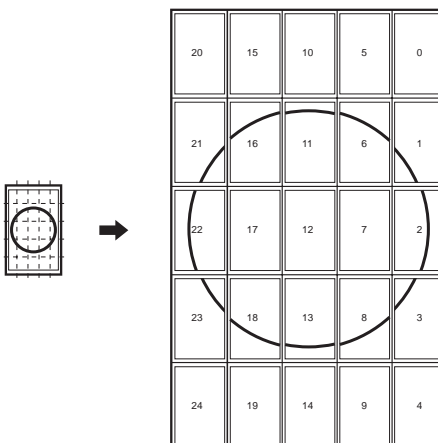

■ SCREEN MOTION function

- When SCREEN MOTION is set to ON, the screen image is moved vertically and horizontally to reduce the residual image on the screen.
When the time specified in MOTION TIME 1 elapses, the screen image is moved vertically and horizontally for a certain period of time at the interval specified in MOTION TIME 2. After the movement stops and the time specified in MOTION TIME 1 elapses again, SCREEN MOTION activates again.
- While the screen image is moving, the edges of the screen may be hidden.

Adjustments for PC screen display (ANALOG)

When you use the PC analog RGB input terminal to display a PC screen for the first time, or when you change the setting of the PC, you need to perform the automatic adjustment from the ADJUSTMENT menu. (See page 28.)

Before making adjustments in the ADJUSTMENT menu or GAIN CONTROL menu, display an image to brighten the entire screen.

If you are using a Windows PC, use the adjustment pattern on the supplied CD-ROM.

Retrieving the adjustment pattern

1. Connect the monitor and computer (see page 11).
2. Load the supplied CD-ROM into the computer's CD-ROM drive.
3. Open the CD-ROM in [My Computer].
4. Double-click [Adj_uty.exe] to start the adjustment program.
The adjustment pattern will appear. Adjust the screen automatically or manually.

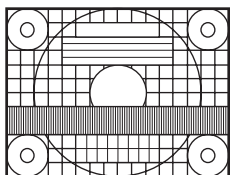



5. When adjustment is finished, press the [Esc] on the computer's keyboard to quit the adjustment program.
6. Eject the CD-ROM from the CD-ROM drive.

TIPS

- If the display mode on the computer you are using is 65,000 colors, the color levels in the color pattern may appear differently or grayscale may appear to be colored. (This is due to the specifications of the input signal and is not a malfunction.)

Automatic adjustment procedure

1. Set the input mode to "ANALOG" and display the adjustment pattern above.
2. Press  and display the ADJUSTMENT menu.
3. Press  and select "AUTO". The automatic adjustment is complete in several seconds.
4. Press  six times to close the menu screen.

TIPS

- If the screen cannot be adjusted properly with one automatic adjustment, repeat the automatic adjustment two or three times. Try manual adjustment if necessary. (See page 28.)

Initialization (Reset)/Functional Restriction Setting

You can return contrast, image quality, and other settings to their factory-preset values, specify whether power LEDs lights, and enable control via RS-232C (see page 35) among other functions.

1. After pressing ^{SIZE}  for about 5 seconds, press , , , and  in that order.
The FUNCTION 1 screen will appear.

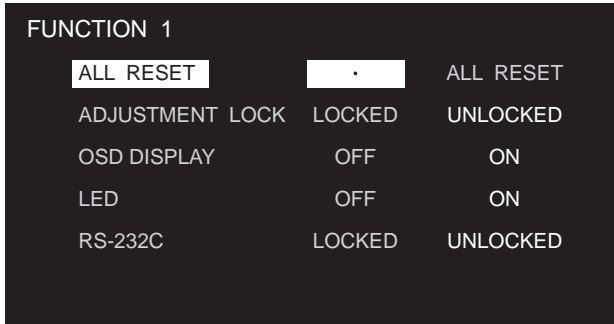

2. Select and set the items you want.

[ALL RESET]	
Function	Resets the monitor settings other than the OSD ROTATION and POWER ON DELAY settings to the factory default settings. After initialization (reset), turn the main power switch off and then back on.
[ADJUSTMENT LOCK]	
Function	Specifies whether to lock settings such as ADJUSTMENT and WHITE BALANCE. Locking it disables all operations other than turning power on/off and displaying the "FUNCTION 1" screen.
LOCKED	Locks the setting.
UNLOCKED	Unlocks the setting.
[OSD DISPLAY]	
Function	Hides/shows menus. The FUNCTION 1 screen cannot be hidden.
ON	Displays the menus.
OFF	Hides the menus.
[LED]	
Function	Specifies whether to light power LEDs.
ON	Lights power LEDs.
OFF	Does not light power LEDs.
[RS-232C]	
Function	Specifies whether to allow control via RS-232C (see page 35).
LOCKED	Disables control via RS-232C.
UNLOCKED	Enables control via RS-232C.

3. Press ^{MENU}  to return to the normal screen.

Controlling the Monitor with a PC

You can control this monitor from a PC via RS-232C (COM port) on the PC. You can also connect multiple monitors via a daisy chain by using a PC. By assigning ID numbers to each monitor (see page 38), you can make input mode selection/adjustment or can check the status of a specific monitor.

PC connection

One-to-one connection with a PC..... Basic operation

Connect with RS-232C straight cable between the PC's COM port (RS-232C connector) and the RS-232C input terminal on the rear of the monitor.

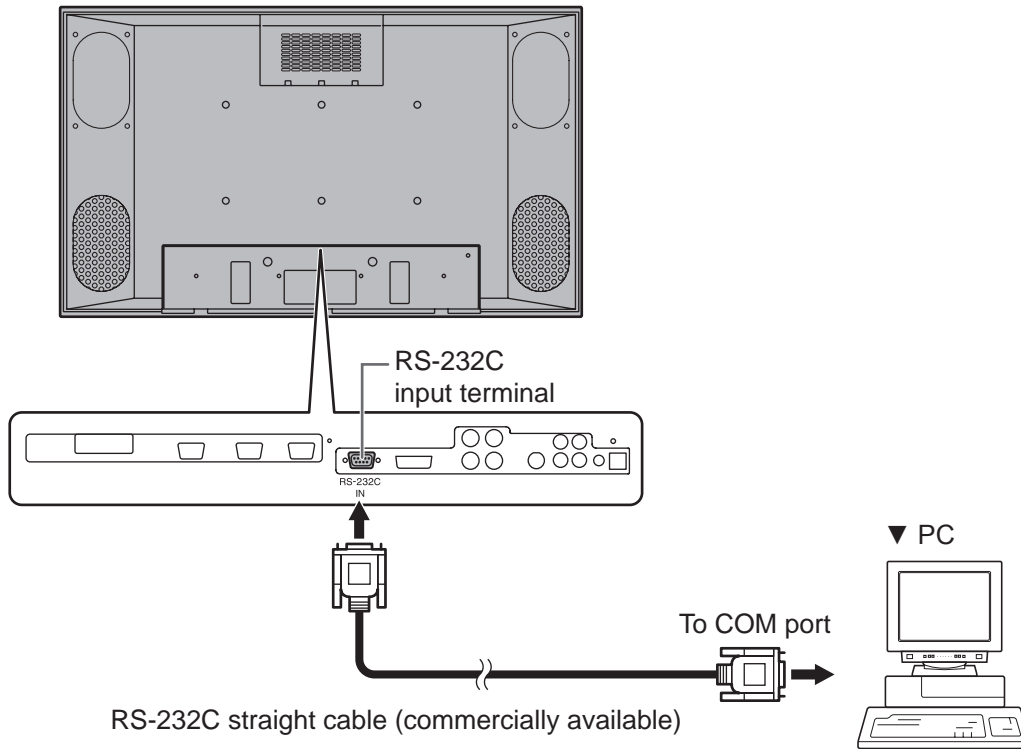

Controlling the Monitor with a PC (Continued)

Daisy chain connection from a single PC..... **Advanced operation**

Connect with RS-232C straight cable between the PC's COM port (RS-232C connector) and the RS-232C input terminal on the rear of the first monitor.

Next, connect RS-232C straight cable to the first monitor's RS-232C output terminal and to the second monitor's RS-232C input terminal. Connect in the same way to the third and subsequent monitors. The number of connectable monitors varies depending on the length of the cable used and the surrounding environment.

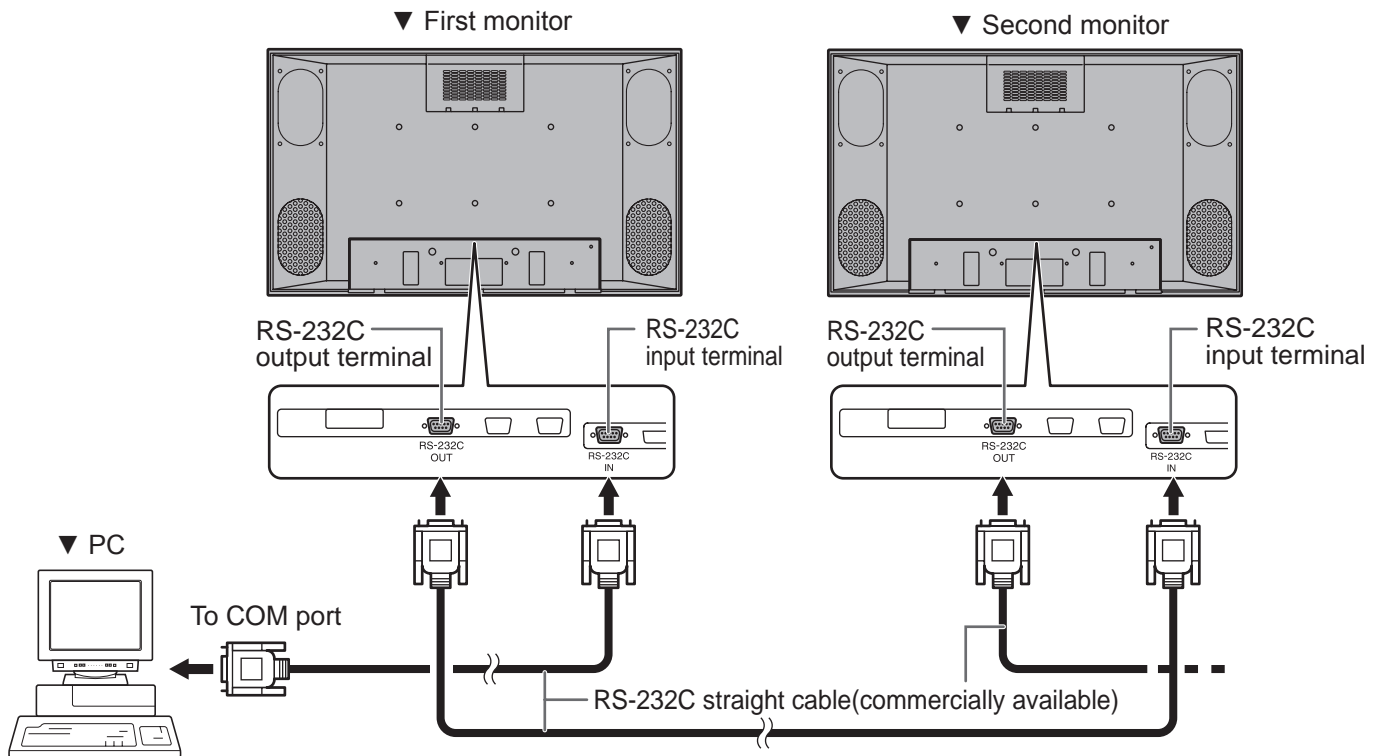

Communication conditions

Set the RS-232C communication settings on the PC to match the monitor's communication settings as follows:

Baud rate	9,600 bps
Data length	8 bits
Parity bit	None

Stop bit	1 bit
Flow control	None

Communication procedure

Basic operation

<Command format>

When a command is sent from the PC to the monitor, the monitor operates according to the received command and sends a response message to the PC.

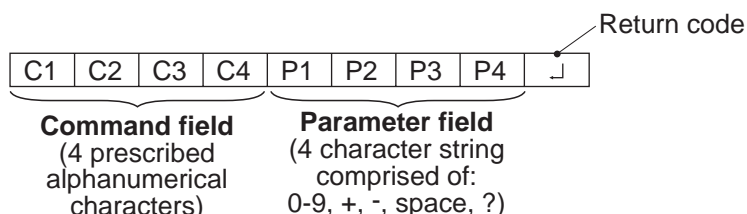

Example: VOLM0030

VOLM ␣␣30 ("␣" indicates a space.)

* Be sure to input 4 characters for the parameter. Pad with spaces if necessary.

Wrong: VOLM30 ↵

Right: VOLM ␣␣30 ↵ ("␣" indicates a space. "↵" is the return code (0DH, 0AH or 0DH).)

When inputting a negative value, specify a numerical value in three digits.

Example: AUTC-009

To use the six-digit command (MPOS), use a six-digit numerical value without spaces in between.

Example: MPOS010097

If a command has "R" listed for "DIRECTION" in the "RS-232C command table" on page 44, the current value can be returned by using "?" as the parameter.

Example: 1. If an ID number has not been set:

VOLM???? ← From PC to monitor (How much is current volume setting?)

30 ← From monitor to PC (Current volume setting: 30)

2. If an ID number has been assigned (For example, ID number = 1)

VOLM ␣␣␣? ← From PC to monitor ("␣" indicates a space.)

30 ␣001 ← From monitor to PC ("␣" indicates a space.)

<Response code format>

■ When a command has been executed correctly

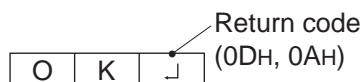

This is returned when execution of the command is finished.

■ When a command has not been executed correctly*



* This is returned when there is no such command, or when the command cannot be used in the current state of the monitor .

* If communication has not been established for reasons such as a bad connection between the PC and monitor, nothing is returned (not even ERR).

■ If execution of the command is taking some time



With some commands, "WAIT" is returned as a return value. Wait for a moment, and OK or ERR will be returned. New commands cannot be received during this time, even if they are sent.

■ If RS-232C is locked

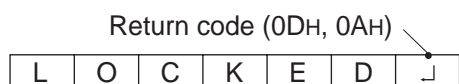

If RS-232C control has been locked with the operation lock (see page 34), LOCKED is returned as the returned value.

Controlling the Monitor with a PC (Continued)

Advanced operation

This section explains commands for daisy chain connection. The basic communication procedure is the same as in the “Basic operation” section.

<ID numbers>

You can assign a unique ID number to each monitor (see page 30). This allows you to control a particular monitor in a daisy chain of monitors.

Up to 25 monitors can be connected, depending on the length of RS-232C cables and installation environment.

You can assign ID numbers either from the menu screen (using the remote control) or from the PC using RS-232C cable.

[Example]

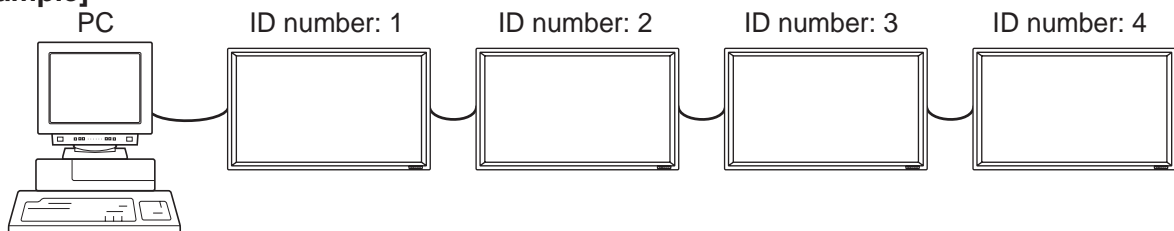

If monitors are connected as shown above, you can execute commands like “Set the volume of the monitor with ID 4 to 20”.

When controlling monitors linked in a daisy chain by designating ID numbers, you should basically avoid any duplication of ID numbers.

ID numbers do not have to be assigned in ascending order starting from the PC. They can also be connected as shown below.

[Example]

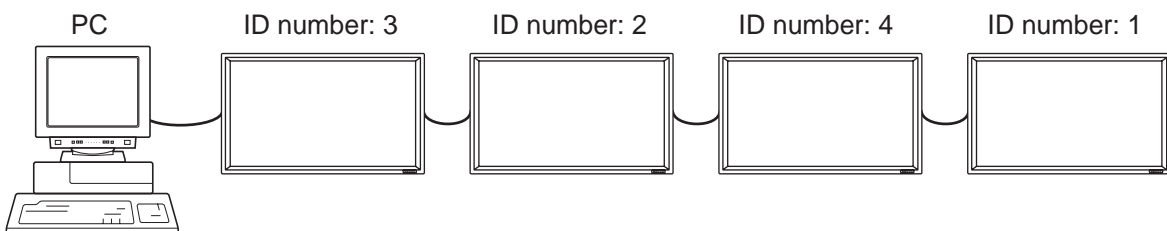

<Commands for ID control>

The command examples shown on this page assume the following connection and ID number set up.

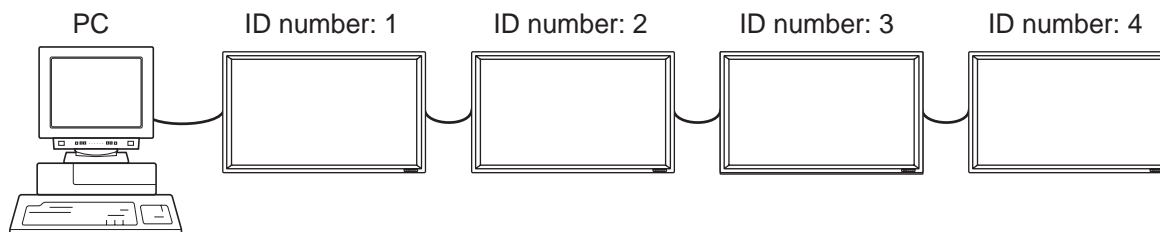

IDST.....A monitor receiving this command sets its own ID number in the parameter field.

Example: IDST001

OK 001 ← The ID number of this monitor is set to 1.

Note

After linking monitors, you can automatically assign ID numbers by using the IDST command with the Repeater control (see “Repeater control” on page 41).

[Example]

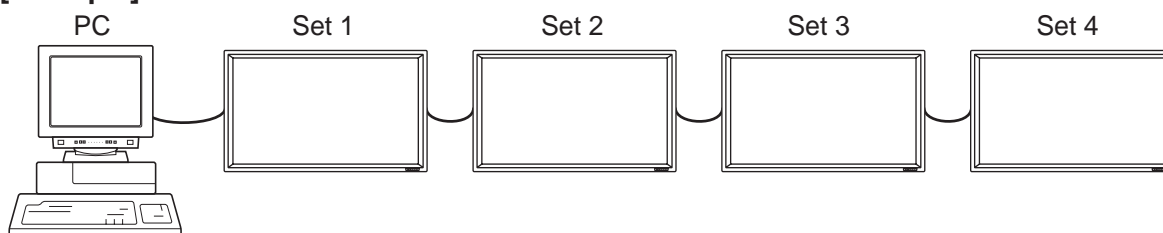

If you connect monitors as shown above, and use the command “IDST001+”, ID numbers will be set automatically, as shown below.

[Example]

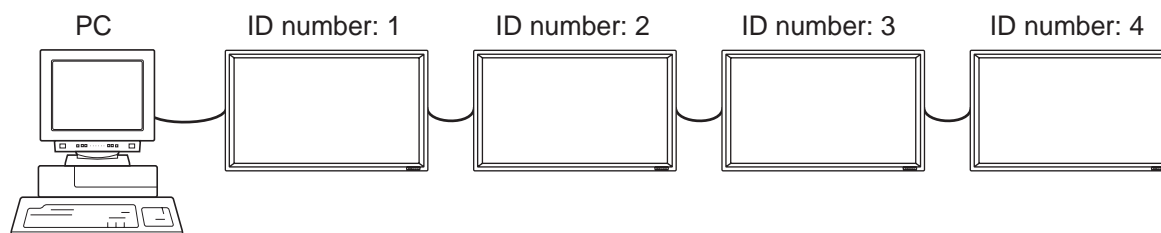

IDST001+ ← ID setting command with repeater control

WAIT

OK 001 ← “OK” response from ID number: 1

OK 002 ← “OK” response from ID number: 2

OK 003 ← “OK” response from ID number: 3

OK 004 ← “OK” response from ID number: 4 (End)

Controlling the Monitor with a PC (Continued)

IDSL..... The parameter of this command sets the ID number of the monitor.
The monitor is subject to the next command.

Example:

IDSL0002 ← The next command is for the monitor with ID number: 2.
WAIT ← Searching for monitor with ID number: 2
OK □ 002 ← Found monitor with ID number: 2
VOLM0030 ← Sets volume of monitor with ID number: 2 to 30.
WAIT ← Processing
OK □ 002 ← OK response from monitor with ID number: 2
VOLM0020 ← Sets volume to 20.
OK □ 001 ← The volume of the monitor with ID number=1
(the one directly connected to the PC) is set to 20.

The IDSL command is effective only once, for the immediately succeeding command.

IDLK..... The parameter of this command sets the ID number of the monitor.
The monitor is subject to all subsequent commands.

Example:

IDLK0002 ← Following commands are for the monitor with ID number: 2.
WAIT ← Searching for monitor with ID number: 2
OK □ 002 ← Found monitor with ID number: 2
VOLM0030 ← Sets volume of monitor with ID number: 2 to 30.
WAIT ← Processing
OK □ 002
VOLM0020 ← Sets volume of monitor with ID number: 2 to 20.
WAIT
OK □ 002
IDLK0000 ← Canceling fixed ID number setting
WAIT ← Canceling IDLK
OK □ 002 ← Cancelation complete
VOLM0010
OK □ 001 ← The volume of the monitor with ID number=1
(the one directly connected to the PC) is set to 10. (IDLK is canceled.)

The IDLK command remains effective until it is canceled, or power is shut off.

IDCK Provides screen display of the ID number currently assigned to a monitor, and the ID number currently set for IDLK (if any).

Example:

(After executing IDLK0002)

IDCK0000 ← (Parameter has no meaning.)
ID:001 IDLK:002 ← Returned response. The ID number is also displayed on the monitor screen.
IDCK000+ ← Repeater control
(If a command is used with repeater control, ID designation using IDSL or IDLK is canceled.)

WAIT
ID:001 IDLK:002
ID:002 IDLK:002
ID:003 IDLK:002
ID:004 IDLK:002

<Repeater control>

This system has a function to allow setting of multiple monitors connected in a daisy chain using a single command. This function is called repeater control.

The number of connectable monitors varies depending on the length of the cable used and the surrounding environment.

You can use Repeater control function without assigning ID numbers.

[Example]

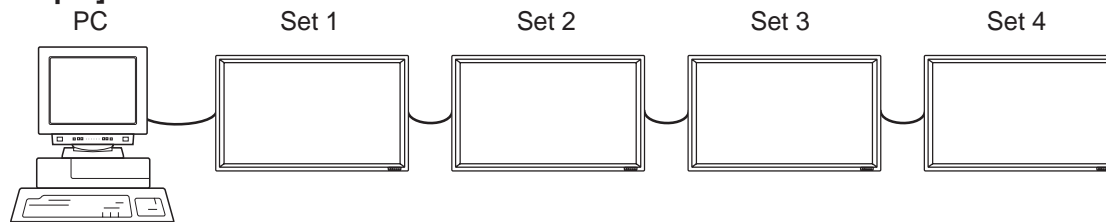

If monitors are connected as shown above, you can execute a command like “Set all monitors’ input settings to DVI: DIGITAL”.

<Repeater control command>

Repeater control is achieved by setting the FOURTH CHARACTER of the parameter to “+”.

Example:

VOLM030+ ← Sets volume of all monitors to 30.

In repeater control, responses are returned by all the connected monitors.

If you want to determine that a value has been returned by a specific set, assign ID numbers to each monitor in advance.

When some monitors do not return their responses, the probable cause is that the monitors could not receive the command or command processing is not complete. Do not send a new command.

Example:

(When 4 monitors are connected, and assigned ID numbers: 1 through 4)

VOLM030+

WAIT

OK □ 001

OK □ 002

OK □ 003

OK □ 004 ← If 4 monitors are connected in a chain, reliable operation can be ensured by sending a new command only after a reply has been returned by 4th (last) monitor.

Repeater control can also be used for reading settings.

Example:

VOLM??#+

WAIT

10 □ 001

20 □ 002

30 □ 003

30 □ 004

Volume settings for all monitors are returned.

TIPS

- If repeater control is used during ID designation (IDSL, IDLK), the ID designation is canceled.

Controlling the Monitor with a PC (Continued)

<Response format in **Advanced operation** >

■ When a command has been executed correctly

- Response when no ID number has been set

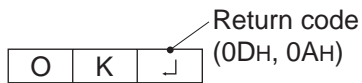

A response is returned when execution of the pertinent command is finished.

- Response when an ID number has been set

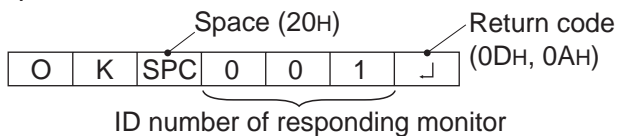

■ When a command has not been executed correctly*

- Response when no ID number has been set



- Response when an ID number has been set

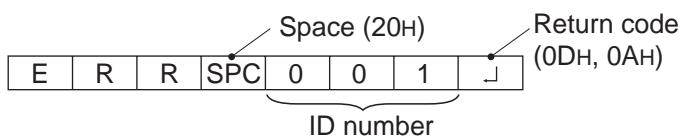

- * This is returned when there is no such command, or when the command cannot be used in the current state of the monitor.
- * If communication has not been established for reasons such as a bad connection between the PC and monitor, nothing is returned (not even ERR).
- * If no monitor has been assigned the designated ID number (e.g. if the command IDSL0002 ↵ is used, but no monitor with ID number: 2 is found), no response is returned.

■ If execution of the command is taking some time



When the following commands are used, "WAIT" is returned. In this case, a value will be returned if you wait a while. Do not send any command during this period.

No ID number is attached to WAIT response.

- Commands which return WAIT:
 - When repeater control is used
 - When an IDSL or IDLK command is used
 - When one of the following commands is used: RSET, INPS, ASNC, WIDE, EMAG, EPOS, PXSL, POWR, AGIN, MWIN, MWIP, MWPP.

■ When control via RS-232C is locked (to prevent use) using the operation lock function (see page 34)



■ If the current parameter is read out using "?" for the parameter (for numerical values etc.)

- Response when no ID number has been set

Example:

```
VOLM????  
10
```

- Response when an ID number has been set (In the example below: ID number = 1)

Example:

```
VOLM????  
10 001
```

<Communication interval>

- After OK or ERR is returned, you must send the following commands. To set a timeout for the command response, specify 10 seconds or longer.
- Provide an interval of 100 ms or more between the command response and the transmission of the next command.

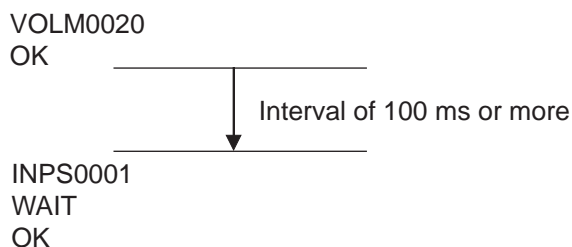

Controlling the Monitor with a PC (Continued)

RS-232C command table

<How to read the command table>

- Command: Command field (See page 37.)
- Direction: W When the "Parameter" is set in the parameter field (see page 37), the command functions as described under "Control/Response Contents".
- R The returned value indicated under "Reply" can be obtained by setting "????", "□□□□?" or "??#+?" (repeater control) in the parameter field (see page 37).
- Parameter: Parameter field (See page 37.)
- Reply: Response (Returned value)
- * "Yes" indicates commands which can be used in power standby mode.

TIPS

- To specify the horizontal/vertical positions for vertical orientation, specify the values for horizontal orientation.

Power control/Input mode selection

Control item	Command	Direction	Parameter	Reply	Control/Response contents	Can be used in standby mode
POWER CONTROL	POWR	W	0		Switches to standby mode.	Yes
			1		Returns from standby mode.	
		R	0		Standby mode	
			1		Normal mode	
			2		Input signal waiting mode	
INPUT MODE SELECTION	INPS	W	0		Toggle change for input mode	Yes
			1		PC digital RGB (DVI) (DIGITAL)	
			2		PC analog RGB (ANALOG)	
			3		Component (COMPONENT)	
			4		Video (S-Video • Video)	
		R	1		PC digital RGB (DVI) (DIGITAL)	
			2		PC analog RGB (ANALOG)	
			3		Component (COMPONENT)	
			4		Video (S-Video • Video)	

Picture Adjustment (DIGITAL)

Control item		Command	Direction	Parameter	Reply	Control/Response contents	Can be used in standby mode
WHITE BALANCE	THRU	CTMP	WR	0	0		Yes
	PRESET			1 - 15	1 - 15		
	USER			99	99		
	R-CONTRAST	CRTR	WR	0 - 255	0 - 255		
	G-CONTRAST	CRTG	WR	0 - 255	0 - 255		
	B-CONTRAST	CRTB	WR	0 - 255	0 - 255		
GAMMA		GAMM	WR	0 - 2	0 - 2	0:1.8, 1:2.2, 2:2.4	Yes
GAIN CONTROL	BLACK LEVEL	BLVL	WR	0 - 31	0 - 31		Yes
	CONTRAST	CONT	WR	0 - 31	0 - 31		
INPUT RESOLUTION	RESOLUTION CHECK	PXCK	R		-	Returns current resolution in the form of hhh, vvv.	No
ENLARGE	ENLARGE SETTING	EMAG	WR	0	0	ENLARGE OFF	No
				1	1	2 x 2	
				2	2	3 x 3	
				3	3	4 x 4	
				4	4	5 x 5	
	BEZEL WIDTH	BEZH	WR	0 - 100	0 - 100	Width of the right/left bezel	
	BEZEL HEIGHT	BEZV	WR	0 - 100	0 - 100	Height of the upper/lower bezel	
	IMAGE POSITION (2 x 2)	EPOS	WR	0 - 3	0 - 3	See page 32.	
	IMAGE POSITION (3 x 3)	EPOS	WR	0 - 8	0 - 8	See page 32.	
	IMAGE POSITION (4 x 4)	EPOS	WR	0 - 15	0 - 15	See page 32.	
IMAGE POSITION (5 x 5)	EPOS	WR	0 - 24	0 - 24	See page 32.		
SCREEN SIZE	WIDE	WR	1	1	WIDE	Yes	
			2	2	NORMAL		
			3	3	DotbyDot		
			4	4	ZOOM1		
			5	5	ZOOM2		

Controlling the Monitor with a PC (Continued)

Picture Adjustment (ANALOG)

Control item		Command	Direction	Parameter	Reply	Control/Response contents	Can be used in standby mode
ADJUSTMENT	AUTO	ASNC	W	1		Returns ERR (error) in case of DIGITAL, COMPONENT or VIDEO input mode.	No
	CLOCK	CLCK	WR	0 - 255	0 - 255		
	PHASE	PHSE	WR	0 - 255	0 - 255		
	H-POS	HPOS	WR	0 - 255	0 - 255		
	V-POS	VPOS	WR	0 - 255	0 - 255		
	RESET	ARST	W	1			
GAIN CONTROL	AUTO	AGIN	W	1		Returns ERR (error) in case of DIGITAL, COMPONENT or VIDEO input mode.	No
	BLACK LEVEL	BLVL	WR	0 - 31	0 - 31		Yes
	CONTRAST	CONT	WR	0 - 31	0 - 31		
WHITE BALANCE	PRESET	CTMP	WR	1-15	1-15		Yes
	USER			99	99		
	R-CONTRAST	CRTR	WR	0 - 255	0 - 255		
	G-CONTRAST	CRTG	WR	0 - 255	0 - 255		
	B-CONTRAST	CRTB	WR	0 - 255	0 - 255		
GAMMA		GAMM	WR	0 - 2	0 - 2	0:1.8, 1:2.2, 2:2.4	Yes
RESOLUTION	CHECK	PXCK	R		-	Returns current resolution in the form of xxx, xxx.	No
	PIXEL SETTING	PXSL	WR	0	0	V: 768) reserved (ERR)	
				1	1	V: 768) 1360 x 768	
				2	2	V: 768) 1280 x 768	
				3	3	V: 768) 1024 x 768	
				4	4	V: 480) reserved (ERR)	
				5	5	V: 480) 848 x 480	
6	6	V: 480) 640 x 480					
ENLARGE	ENLARGE SETTING	EMAG	WR	0	0	ENLARGE OFF	No
				1	1	2 x 2	
				2	2	3 x 3	
				3	3	4 x 4	
				4	4	5 x 5	
	BEZEL WIDTH	BEZH	WR	0 - 100	0 - 100	Width of the right/left bezel	
	BEZEL HEIGHT	BEZV	WR	0 - 100	0 - 100	Height of the upper/lower bezel	
	IMAGE POSITION (2 x 2)	EPOS	WR	0 - 3	0 - 3	See page 32.	
	IMAGE POSITION (3 x 3)	EPOS	WR	0 - 8	0 - 8	See page 32.	
IMAGE POSITION (4 x 4)	EPOS	WR	0 - 15	0 - 15	See page 32.		
IMAGE POSITION (5 x 5)	EPOS	WR	0 - 24	0 - 24	See page 32.		
SCREEN SIZE		WIDE	WR	1	1	WIDE	Yes
				2	2	NORMAL	
				3	3	DotbyDot	
				4	4	ZOOM1	
				5	5	ZOOM2	

Picture Adjustment (COMPONENT/VIDEO)

Control item		Command	Direction	Parameter	Reply	Control/Response contents	Can be used in standby mode
VIDEO ADJUSTMENT	CONTRAST	CONT	WR	0 - 31	0 - 31		Yes
	BLACK LEVEL	BLVL	WR	0 - 31	0 - 31		
	COLOR	COLR	WR	0 - 31	0 - 31		
	TINT	TINT	WR	0 - 31	0 - 31		
	SHARPNESS	SHRP	WR	0 - 31	0 - 31		
	WHITE BALANCE	CTMP	WR	1 - 15	1 - 15		
GAMMA		GAMM	WR	0 - 2	0 - 2	0:1.8, 1:2.2, 2:2.4	Yes
SCREEN SIZE		WIDE	WR	1	1	WIDE	Yes
				2	2	ZOOM1	
				3	3	ZOOM2	
				4	4	NORMAL	
				5	5	Dotby Dot	
RESOLUTION CHECK		RESO	R		Resolution	480i, 480p, 1080i, 720p	No

Common control to all input modes (INPUT)

Control item		Command	Direction	Parameter	Reply	Control/Response contents	Can be used in standby mode
PIP PbyP PbyP2	PIP MODES	MWIN	WR	0	0	OFF	Yes
				1	1	PIP	
				2	2	PbyP	
				3	3	PbyP2	
	PIP SIZE	MWSZ	WR	0	0	SMALL	Yes
				1	1	MEDIUM	
				2	2	LARGE	
	PIP H-POS	MHPS	WR	0 - 100	0 - 100		Yes
	PIP V-POS	MVPS	WR	0 - 100	0 - 100		Yes
	PIP V/H-POS	MPOS	WR	0 - 100, 0 - 100	0 - 100, 0 - 100	Specify the position in MPOSxxxxyy format (xxx: Horizontal position, yyy: Vertical position). The response is (xxx, yyy).	Yes
	PIP BLEND	MWBL	WR	0 - 15	0 - 15		Yes
	PIP SOURCE	MWIP	WR	1	1	PC digital RGB (DVI) (DIGITAL)	Yes
				2	2	PC analog RGB (ANALOG)	
				3	3	Component (COMPONENT)	
				4	4	Video (S-Video • Video)	
SOUND CHANGE	MWAD	WR	1	1	PC	Yes	
			2	2	AV		
MAIN POS (Main screen)	MWPP	WR	0	0	POS1	Yes	
			1	1	POS2		
PbyP2 POS (Sub screen)	MW2P	WR	0	0	POS1	Yes	
			1	1	POS2		
			2	2	POS3		
AUTO OFF	MOFF	WR	0	0	MANUAL	Yes	
			1	1	AUTO		
AUDIO	TREBLE	AUTR	WR	-10 - 10	-10 - 10		Yes
	BASS	AUBS	WR	-10 - 10	-10 - 10		
	BALANCE	AUBL	WR	-10 - 10	-10 - 10		
OFF TIMER	OFTM	WR	0	0	TIMER OFF	No	
			1 - 23	1 - 23	OFF TIMER		
					Value		Remaining time
ID NUMBER	ID NO. SETTING	IDST	W	0 - 255		Sets the monitor's ID number.	Yes
						0 - 255	
	ID NO. SETTING (ONCE)	IDSL	W	1 - 255		Sets a monitor ID number. This ID number is only effective for the command immediately after this command. Clears the ID number if one has been designated.	Yes
					0		
	ID NO. SETTING (SUBSEQUENT)	IDLK	W	1 - 255		Sets a monitor ID number. This ID number is effective for the next and all subsequent commands after this command. Clears the ID number if one has been designated.	Yes
0							
ID CHECK	IDCK	W	0	ID:XXX IDLK:YYY	Displays selected ID number and the monitor's own ID number on the screen.		
INFORMATION	MODEL	INF1	R		Value		Yes
	SERIAL No.	SRNO	R		Value		
SCREEN MODE	BMOD	WR	0	0	STD (standard)	Yes	
			1	1	OFFICE mode		
			2	2	VIVID mode		
			3	3	sRGB (When the input mode is DIGITAL/ANALOG)		
BRIGHTNESS	VLMP	WR	0 - 31	0 - 31	Brightness	Yes	
VOLUME	VOLM	WR	0 - 31	0 - 31	Volume	Yes	
MUTE	MUTE	WR	0	0	OFF	No	
			1	1	ON		
ALL RESET	RSET	W	0		ALL RESET	No	
OSD DISPLAY	LOSD	WR	0	0	OSD DISPLAY ON	Yes	
			1	1	OSD DISPLAY OFF		

Controlling the Monitor with a PC (Continued)

Control item	Command	Direction	Parameter	Reply	Control/Response contents	Can be used in standby mode
ADJUSTMENT LOCK	ALCK	WR	0	0	ADJUSTMENT UNLOCKED	Yes
			1	1	ADJUSTMENT LOCKED	
LED	OFLD	WR	0	0	LED ON	Yes
			1	1	LED OFF	
SCREEN MOTION	SCSV	WR	0	0	SCREEN MOTION OFF	Yes
			1	1	SCREEN MOTION ON	
MOTION TIME 1	MTIM	WR	0 - 20	0 - 20		Yes
MOTION TIME 2	MINT	WR	10 - 990	10 - 990	The time is set in units of 10 seconds.	
Power On Delay	PWOD	WR	0	0	Power On Delay OFF	Yes
			1 - 60	1 - 60	Power On Delay ON	
OSD ROTATION	OROT	WR	0	0	OSD ROTATION OFF	Yes
			1	1	OSD ROTATION ON	
LANGUAGE	LANG	WR	14	14	ENGLISH	Yes
			1	1	DEUTSCH	
			2	2	FRANÇAIS	
			3	3	ITALIANO	
TEMPERATURE SENSOR	DSTA	R		0	Internal temperature normal	Yes
				1	Internal temperature abnormal (Standby mode)	
				2	Internal temperature abnormal (Temperature is normal now, but it was abnormal during operation.)	
				3	Internal temperature abnormal (Brightness of the backlight decreases.)	
TEMPERATURE	ERRT	R		Value	The temperatures measured with sensor 1 and 2 are returned in the form of OOO, XXX respectively.	Yes
				4	Temperature sensor abnormal	
FAN SENSOR	ERRF	R		0	Fan normal	Yes
				1	Fan abnormal	
CAUSE OF LAST STANBY MODE	STCA	W	0		Initialization	Yes
		R		0	No detectable error has occurred	
				1	Standby mode by remote control	
				2	Standby mode by power switch on the monitor	
				3	Standby mode by RS-232C	
				4	Waiting mode by No Signal/Out of Timing (Incl: VESA DPMS/DMPM)	
				5	Standby mode by fan abnormal	
	6	Standby mode by abnormal temperature				
	7	Standby mode by OFF TIMER function				

Troubleshooting

Before calling for repair services, make sure following checks for possible remedies to the encountered symptoms.

Problem	Check item	Page
There is no picture or sound.	• Is the power cord disconnected?	15
	• Is the main power switch set to "OFF (O)"?	19
	• Is the monitor in standby mode (the power LED illuminating in orange)?	19
	• Make sure correct input mode is selected.	20
	• If any external equipment is connected, make sure the equipment is operating (playing back).	-
Remote control does not work.	• Are the batteries inserted with polarity (⊕, ⊖) aligned?	18
	• Are the batteries worn out?	18
	• Point the remote control unit toward the monitor's remote control sensor.	18
	• Is the menu display hidden or are settings locked?	34
Sound from left and right speakers is reversed. Sound is heard from only one side.	• Are audio cables connected properly?	11 to 14
	• Make sure audio cables for external speakers are connected properly: left and right cables may be reversed or one of the two cables may not be connected.	14
	• Check the setting of BALANCE for AUDIO.	29
There is a picture but no sound.	• Is the sound muted?	20
	• Make sure the volume is not set to minimum.	20
	• Is the PC audio cable (commercially available) connected?	11
	• Are audio cables connected properly?	12
	• Is the audio signal input properly to the audio input terminal corresponding to the selected video input terminal?	11 to 13, 20
Faint color or bad hue.	• Check "COLORS" and "TINT" adjustments.	29
	• Make sure the connection sequence is correct.	11 to 13
Unstable video	• The signal may be incompatible.	12, 52
	• Try the automatic screen adjustment when the PC analog RGB input terminal is used.	33
Power LED flashes red.	• Fan has a problem. Turn off the monitor and request repair from your SHARP dealer.	-
When "TEMPERATURE" is displayed	• When the internal temperature of the monitor rises excessively, the brightness of the backlight decreases in order to prevent high-temperature-related problems. Remove the cause of the excessive rise in temperature.	50

Troubleshooting (Continued)

■ Warning when temperature rises

- When the internal temperature of the monitor rises excessively, the brightness of the backlight decreases automatically in order to prevent high-temperature-related problems. When this occurs, "TEMPERATURE" is displayed on the screen and the Power LED flashes red and green alternately.
- If the internal temperature rises further, the monitor automatically enters standby mode. (The Power LED continues flashing red and green alternately.)

Solution:

- If the monitor enters standby mode due to a rise in temperature, you can reset the monitor to normal operation by turning it on again using the POWER button on the remote control unit or the power switch  on the front panel. The monitor, however, will enter standby mode again if the cause of the temperature rise is not eliminated.
- Check whether the monitor is placed at a location where a quick rise in temperature is likely. Internal temperature rises quickly if the vents on the monitor are blocked.
- Internal temperature rises quickly if dust accumulates inside the monitor or around the vents. Remove dust if possible. Ask Sharp dealer about removing internal dust.

Cracking sound

The monitor sometimes makes a cracking sound.

- You may hear cracking sound from the monitor. This happens when the cabinet slightly expands and contracts according to change in temperature. This does not affect the monitor's performance.

Specifications

■ Product Specifications

Model	PN-455RU		
LCD element	45" wide (113.1 cm diagonal) ASV low-reflection black TFT LCD		
Max. resolution (pixels)	1920 x 1080		
Max. colors	16.77 M colors (8 bits/color)		
Pixel pitch	0.5135mm (H) x 0.5135mm (V)		
Viewing angle	170° right/left/up/down (contrast ratio 10)		
Screen active area inch (mm)	38-7/8 x 21-7/8 (985.9 X 554.6)		
Computer input signal	Digital DVI 1.0 standard-compliant, analog RGB (0.7Vp-p) [75]		
	Sync signal	Horizontal/vertical separate (TTL: positive/negative), Sync-on-green, Composite sync (TTL: positive/negative)	
Video signal system	NTSC (3.58MHz)		
Plug and play	VESA DDC2B		
Power management	VESA DPMS, DVI DMPM		
Input terminals	Computer signal	Digital	DVI-D 24 pin x 1
		Analog	Mini D-sub 15 pin, 3 rows x 1
	Computer audio	3.5 mm mini stereo jack x 1	
	Serial (RS-232C)	D-sub 9 pin x 1	
	Composite video	BNC *1 x 1	
	S-video	4 pin DIN *1 x 1	
	Component	BNC(Y, Cb/Pb, Cr/Pr) x 1	
	Audio	RCA pin (L/R) x 1	
Output terminals	Computer signal	Analog *2	Mini D-sub 15 pin, 3 rows x 1
	Serial (RS-232C)	D-sub 9 pin x 1	
	Audio	RCA pin (L/R) x 1	
	Speaker	7 W + 7 W [6]	
Power requirement	100 VAC - 240 VAC, 50/60 Hz		
Operating temperature	32°F to 104°F(0°C to 40°C)		
Operating humidity	20% to 80% (no condensation)		
Power consumption	312 W (Input signal waiting mode: 18 W, Standby mode: 2.9 W (120 V), 4.0 W (240 V))		
Dimensions inch (mm)	Approx. 42-7/8 x 3-3/4 x 25-3/8 (1,089 x 96 x 645) (excluding protrusions)		
Weight lbs. (kg)	Approx. 59.5 (27)		

*1 Cannot be used simultaneously.

*2 Through output for the analog computer input signal. Does not support plug and play.

As a part of our policy of continuous improvement, SHARP reserves the right to make design and specification changes for product improvement without prior notice. The performance specification figures indicated are nominal values of production units. There may be some deviations from these values in individual units.

■ Power management

This monitor conforms to VESA DPMS and DVI DMPM. Both your video card and computer must support the same standard in order for the monitor's power management function to work.

DPMS: Display Power Management Signaling

DPMS	Screen	Power consumption	Hsync	Vsync
ON STATE	Display	312 W	Yes	Yes
STANDBY	No display	18 W	No	Yes
SUSPEND			Yes	No
OFF STATE			No	No

DMPM: Digital Monitor Power Management

DMPM	Screen	Power consumption
Monitor ON	Display	312 W
Active OFF	No display	18 W

Specifications (Continued)

■ DDC (plug and play)

The monitor supports the VESA DDC (Display Data Channel) standard.

DDC is a signal standard for plug and play between monitors and computers. Information about resolution and other parameters is exchanged between the two. This function can be used if the computer supports DDC and it has been configured to detect plug-and-play monitors.

There are several types of DDC, depending on the communication method used. This monitor supports DDC2B.

■ Compatible signal timing (PC)

Screen resolution		Hsync	Vsync	Dot frequency	Analog signal	Digital signal
VESA	640 x 480	31.5 kHz	60 Hz	25.175 MHz	Yes	Yes
		37.9 kHz	72 Hz	31.5 MHz	Yes	Yes
		37.5 kHz	75 Hz	31.5 MHz	Yes	Yes
	800 x 600	37.9 kHz	60 Hz	40.0 MHz	Yes	Yes
		48.1 kHz	72 Hz	50.0 MHz	Yes	Yes
		46.9 kHz	75 Hz	49.5 MHz	Yes	Yes
	848 x 480	31.0 kHz	60 Hz	33.75 MHz	Yes	Yes
	1024 x 768	48.4 kHz	60 Hz	65.0 MHz	Yes	Yes
		56.5 kHz	70 Hz	75.0 MHz	Yes	Yes
		60.0 kHz	75 Hz	78.75 MHz	Yes	Yes
	1152 x 864	67.5 kHz	75 Hz	108.0 MHz	Yes	Yes
	1280 x 768	47.8 kHz	60 Hz	79.5 MHz	Yes	Yes
		60.3 kHz	75 Hz	102.25 MHz	Yes	Yes
	1280 x 960	60.0 kHz	60 Hz	108.0 MHz	Yes	Yes
	1280 x 1024	64.0 kHz	60 Hz	108.0 MHz	Yes	Yes
		80.0 kHz	75 Hz	135.0 MHz	Yes	Yes
1360 x 768	47.7 kHz	60 Hz	85.5 MHz	Yes	Yes	
1600 x 1200*1	75.0 kHz	60 Hz	162.0 MHz	Yes	Yes	
Wide	1280 x 720	44.7 kHz	60 Hz	74.4 MHz	Yes	Yes
	1920 x 1080	66.3 kHz	60 Hz	148.5 MHz	Yes	Yes
US TEXT	720 x 400	31.5 kHz	70 Hz	28.3 MHz	Yes	Yes
Sun Ultra Series	1024 x 768	48.3 kHz	60 Hz	64.13 MHz	Yes	—
		53.6 kHz	66 Hz	70.4 MHz	Yes	—
		56.6 kHz	70 Hz	74.25 MHz	Yes	—
	1152 x 900	61.8 kHz	66 Hz	94.88 MHz	Yes	—
		71.8 kHz	76.2 Hz	108.23 MHz	Yes	—
	1280 x 1024	71.7 kHz	67.2 Hz	117.01 MHz	Yes	—
		81.1 kHz	76 Hz	134.99 MHz	Yes	—
1600 x 1000	68.6 kHz	66 Hz	135.76 MHz	Yes	—	

*1 Displays a reduced image.

* All are compliant only with non-interlaced.

* Depending on the connected PC, images may not be displayed properly even if the compatible signal described above is input.

* The frequency values for the Sun Ultra Series are reference values. A separate conversion adapter (commercially available) may be required for connecting the monitor to the Sun Ultra Series.

■ PC digital RGB input terminal pins

(DVI-D 24 pin)

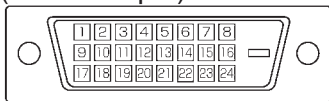

No.	Function	No.	Function
1	TMDS data 2-	13	N.C.
2	TMDS data 2+	14	+5 V
3	TMDS data 2/4 shield	15	GND
4	N.C.	16	Hot-plug detection
5	N.C.	17	TMDS data 0-
6	DDC clock	18	TMDS data 0+
7	DDC data	19	TMDS data 0/5 shield
8	N.C.	20	N.C.
9	TMDS data 1-	21	N.C.
10	TMDS data 1+	22	TMDS clock shield
11	TMDS data 1/3 shield	23	TMDS clock+
12	N.C.	24	TMDS clock-

■ PC analog RGB input terminal pins

(Mini D-sub 15 pin)

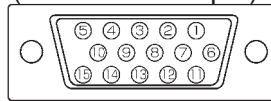

No.	Function	No.	Function
1	Red video signal input	9	+5 V
2	Green video signal input	10	GND
3	Blue video signal input	11	N.C.
4	N.C.	12	DDC data
5	GND	13	Hsync signal input
6	GND for red video signal	14	Vsync signal input
7	GND for green video signal	15	DDC clock
8	GND for blue video signal		

■ RS-232C input terminal pins

(D-sub 9 pin)

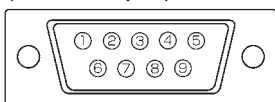

No.	Function	No.	Function
1	N.C.	6	Data set ready
2	Transmitted data	7	Request to send
3	Received data	8	Clear to send
4	Data terminal ready	9	N.C.
5	GND		

■ PC analog RGB output terminal pins

(Mini D-sub 15 pin)

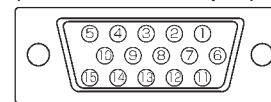

No.	Function	No.	Function
1	Red video signal input	9	+5 V
2	Green video signal input	10	GND
3	Blue video signal input	11	N.C.
4	N.C.	12	N.C.
5	GND	13	Hsync signal output
6	GND for red video signal	14	Vsync signal output
7	GND for green video signal	15	N.C.
8	GND for blue video signal		

■ RS-232C output terminal pins

(D-sub 9 pin)

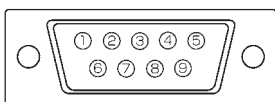

No.	Function	No.	Function
1	Carrier detect	6	Data set ready
2	Received data	7	Request to send
3	Transmitted data	8	Clear to send
4	Data terminal ready	9	Ring indicator (open)
5	GND		

Dimensional Drawings

Note that the values shown are approximate values.

Unit: inch [mm]

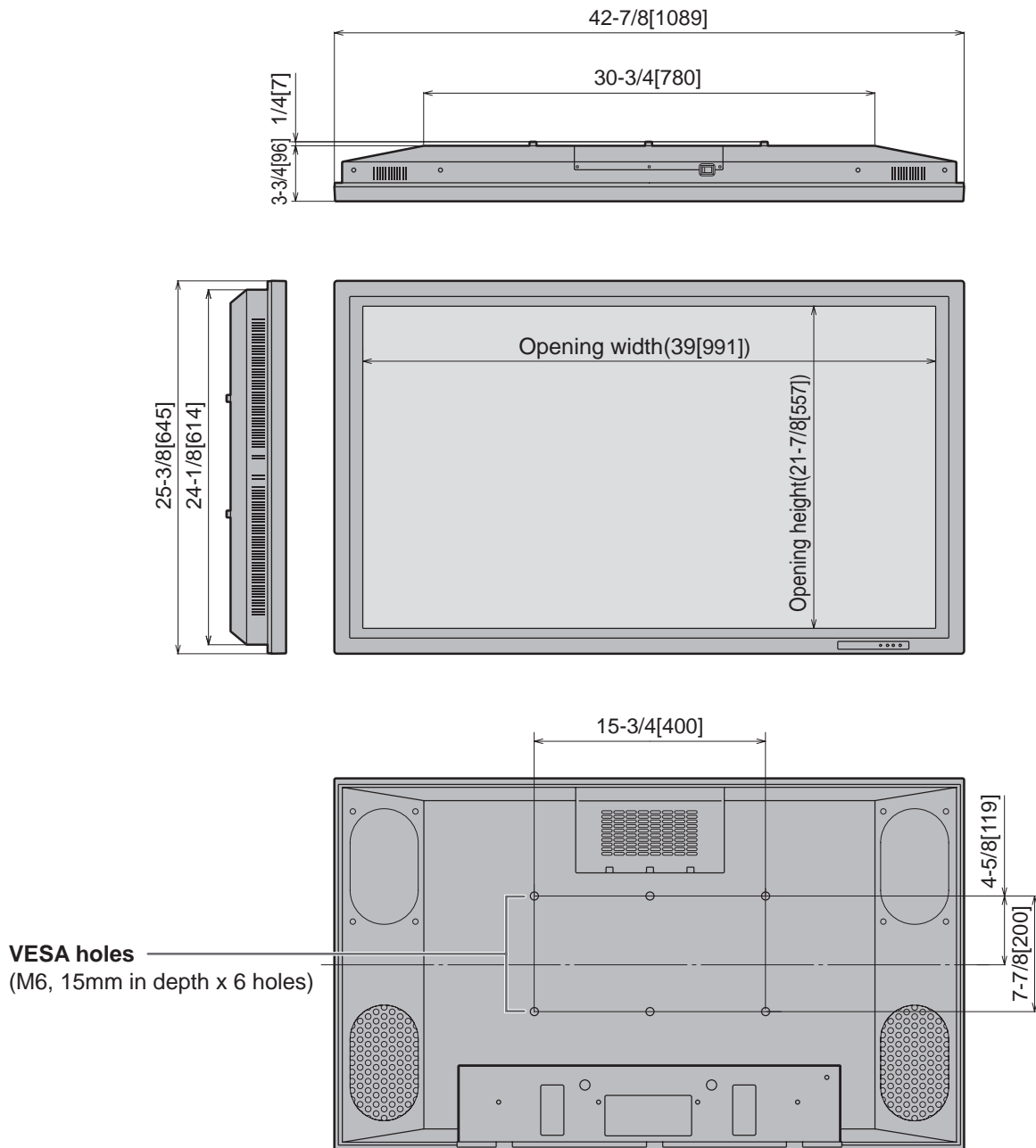

When mounting the monitor, be sure to use a wall-mount / ceiling-mount bracket they comply with the VESA-compatible mounting method. SHARP recommends using M6 screws and tighten the screws. Note that screw hole depth of the monitor is 15mm. Loose holding may cause the product to fall, resulting in serious personal injuries as well as damage to the product. The screw and hole should come together with over 5mm length of thread. SHARP recommends using mounting interface that comply with UL1678 standard.

When installing with 4 screws, use the following holes.

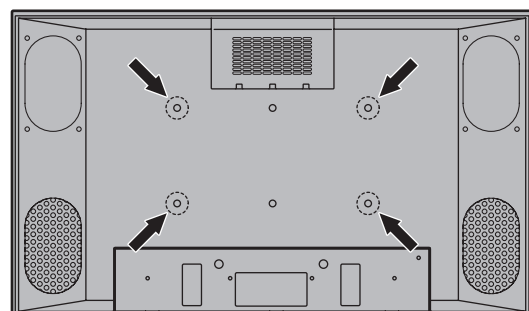

Free Manuals Download Website

<http://myh66.com>

<http://usermanuals.us>

<http://www.somanuals.com>

<http://www.4manuals.cc>

<http://www.manual-lib.com>

<http://www.404manual.com>

<http://www.luxmanual.com>

<http://aubethermostatmanual.com>

Golf course search by state

<http://golfingnear.com>

Email search by domain

<http://emailbydomain.com>

Auto manuals search

<http://auto.somanuals.com>

TV manuals search

<http://tv.somanuals.com>