

SHARP®

LC-32HT3U LC-37HT3U LC-42HT3U

AQUOS



LC-32HT3U
LC-37HT3U



LC-42HT3U

LIQUID CRYSTAL TELEVISION
TÉLÉVISEUR ACL
TELEVISOR CON PANTALLA
DE CRISTAL LÍQUIDO

OPERATION MANUAL
MODE D'EMPLOI
MANUAL DE OPERACIÓN

ENGLISH

FRANÇAIS

ESPAÑOL

HDTV
HIGH-DEFINITION TELEVISION

DOLBY
DIGITAL

HDMI™
HIGH-DEFINITION MULTIMEDIA INTERFACE

Pro:Idiom™

NOM 1245



IMPORTANT : Please read this operation manual before starting operating the equipment.
IMPORTANTE : Lea este manual de operación antes de comenzar a operar el equipo.

LC-32HT3U LC-37HT3U LC-42HT3U

LIQUID CRYSTAL TELEVISION

ENGLISH

OPERATION MANUAL

- These TV (LC-32HT3U, LC-37HT3U, LC-42HT3U models) are designed for hotel guest rooms. Each has two modes, PPV TV mode and Normal mode, and the factory preset is PPV TV mode.
- The TV is equipped with LODGENET, ONCOMMAND, NXTV, nSTREAMS and SeaChange Pay Per View interface.
- The examples used throughout this manual are based on the LC-37HT3U model.

IMPORTANT:



To aid reporting in case of loss or theft, please record the TV's model and serial numbers in the space provided. The numbers are located at the rear of the TV.

Model No.:

Serial No.:

IMPORTANT INFORMATION

WARNING: TO REDUCE THE RISK OF FIRE OR ELECTRIC SHOCK, DO NOT EXPOSE THIS PRODUCT TO RAIN OR MOISTURE.

	CAUTION RISK OF ELECTRIC SHOCK DO NOT OPEN	
CAUTION: TO REDUCE THE RISK OF ELECTRIC SHOCK, DO NOT REMOVE COVER (OR BACK). NO USER-SERVICEABLE PARTS INSIDE. REFER SERVICING TO QUALIFIED SERVICE PERSONNEL.		



The lightning flash with arrow-head symbol, within an equilateral triangle, is intended to alert the user to the presence of uninsulated "dangerous voltage" within the product's enclosure that may be of sufficient magnitude to constitute a risk of electric shock to persons.



The exclamation point within a triangle is intended to alert the user to the presence of important operating and maintenance (servicing) instructions in the literature accompanying the product.

CAUTION: TO PREVENT ELECTRIC SHOCK, MATCH WIDE BLADE OF PLUG TO WIDE SLOT, FULLY INSERT.

IMPORTANT INFORMATION

CAUTION:

DO NOT PLACE THIS PRODUCT ON AN UNSTABLE CART, STAND, TRIPOD, BRACKET, OR TABLE. THE PRODUCT MAY FALL CAUSING SERIOUS PERSONAL INJURY AND SERIOUS DAMAGE TO THE PRODUCT. USE ONLY WITH A CART, STAND, TRIPOD, BRACKET, OR TABLE RECOMMENDED BY THE MANUFACTURER OR SOLD WITH THE PRODUCT. FOLLOW THE MANUFACTURER'S INSTRUCTIONS WHEN INSTALLING THE PRODUCT AND USE MOUNTING ACCESSORIES RECOMMENDED BY THE MANUFACTURER. A PRODUCT AND CART COMBINATION SHOULD BE MOVED WITH CARE. QUICK STOPS, EXCESSIVE FORCE, AND UNEVEN SURFACES MAY CAUSE THE PRODUCT AND CART COMBINATION TO OVERTURN.



WARNING: FCC Regulations state that any unauthorized changes or modifications to this equipment not expressly approved by the manufacturer could void the user's authority to operate this equipment.

CAUTION:

This product satisfies FCC regulations when shielded cables and connectors are used to connect the unit to other equipment. To prevent electromagnetic interference with electric appliances such as radios and televisions, use shielded cables and connectors for connections.

DECLARATION OF CONFORMITY:

SHARP LIQUID CRYSTAL TELEVISION, MODEL LC-32HT3U/LC-37HT3U/LC-42HT3U

This device complies with Part 15 of the FCC Rules. Operation is subject to the following two conditions:

(1) This device may not cause harmful interference, and (2) this device must accept any interference received, including interference that may cause undesired operation.

RESPONSIBLE PARTY:

SHARP ELECTRONICS CORPORATION

Sharp Plaza, Mahwah, New Jersey 07430-2135

TEL: 1-800-BE-SHARP

For Business Customers: URL <http://www.sharppusa.com>

INFORMATION:

This equipment has been tested and found to comply with the limits for a Class B digital device, pursuant to Part 15 of the FCC Rules. These limits are designed to provide reasonable protection against harmful interference in a residential installation. This equipment generates, uses and can radiate radio frequency energy and, if not installed and used in accordance with the instructions, may cause harmful interference to radio communications. However, there is no guarantee that interference will not occur in a particular installation. If this equipment does cause harmful interference to radio or television reception, which can be determined by turning the equipment off and on, the user is encouraged to try to correct the interference by one or more of the following measures:

- Reorient or relocate the receiving antenna.
- Increase the separation between the equipment and receiver.
- Connect the equipment into an outlet on a circuit different from that to which the receiver is connected.
- Consult the dealer or an experienced radio/TV technician for help.

"Note to CATV system installer: This reminder is provided to call the CATV system installer's attention to Article 820-40 of the National Electrical Code that provides guidelines for proper grounding and, in particular, specifies that the cable ground shall be connected to the grounding system of the building, as close to the point of cable entry as practical."

This product utilizes tin-lead solder, and fluorescent lamp containing a small amount of mercury. Disposal of these materials may be regulated due to environmental considerations. For disposal or recycling information, please contact your local authorities, the Electronic Industries Alliance: www.eiae.org, the lamp recycling organization: www.lamprecycle.org or Sharp at 1-800-BE-SHARP (For U.S.A. Only)

Trademarks

- Manufactured under license from Dolby Laboratories. "Dolby" and the double-D symbol are trademarks of Dolby Laboratories.
- "HDMI, the HDMI logo and High-Definition Multimedia Interface are trademarks or registered trademarks of HDMI Licensing LLC."
- Pro:Idiom™ is a trademark of Zenith Electronics Corporation.

DEAR SHARP CUSTOMER

Thank you for your purchase of the Sharp Liquid Crystal Television. To ensure safety and many years of trouble-free operation of your product, please read the Important Safety Instructions carefully before using this product.

IMPORTANT SAFETY INSTRUCTIONS

Electricity is used to perform many useful functions, but it can also cause personal injuries and property damage if improperly handled. This product has been engineered and manufactured with the highest priority on safety. However, improper use can result in electric shock and/or fire. In order to prevent potential danger, please observe the following instructions when installing, operating and cleaning the product. To ensure your safety and prolong the service life of your Liquid Crystal Television, please read the following precautions carefully before using the product.

- 1) Read these instructions.
- 2) Keep these instructions.
- 3) Heed all warnings.
- 4) Follow all instructions.
- 5) Do not use this apparatus near water.
- 6) Clean only with dry cloth.
- 7) Do not block any ventilation openings. Install in accordance with the manufacturer's instructions.
- 8) Do not install near any heat sources such as radiators, heat registers, stoves, or other apparatus (including amplifiers) that produce heat.
- 9) Do not defeat the safety purpose of the polarized or grounding-type plug. A polarized plug has two blades with one wider than the other. A grounding type plug has two blades and a third grounding prong. The wide blade or the third prong are provided for your safety. If the provided plug does not fit into your outlet, consult an electrician for replacement of the obsolete outlet.
- 10) Protect the power cord from being walked on or pinched particularly at plugs, convenience receptacles, and the point where they exit from the apparatus.
- 11) Only use attachments/accessories specified by the manufacturer.
- 12) Use only with the cart, stand, tripod, bracket, or table specified by the manufacturer, or sold with the apparatus. When a cart is used, use caution when moving the cart/apparatus combination to avoid injury from tip-over.
- 13) Unplug this apparatus during lightning storms or when unused for long periods of time.
- 14) Refer all servicing to qualified service personnel. Servicing is required when the apparatus has been damaged in any way, such as power-supply cord or plug is damaged, liquid has been spilled or objects have fallen into the apparatus, the apparatus has been exposed to rain or moisture, does not operate normally, or has been dropped.



Additional Safety Information

- 15) Power Sources—This product should be operated only from the type of power source indicated on the marking label. If you are not sure of the type of power supply to your home, consult your product dealer or local power company. For products intended to operate from battery power, or other sources, refer to the operating instructions.
- 16) Overloading—Do not overload wall outlets, extension cords, or integral convenience receptacles as this can result in a risk of fire or electric shock.
- 17) Object and Liquid Entry—Never push objects of any kind into this product through openings as they may touch dangerous voltage points or short-out parts that could result in a fire or electric shock. Never spill liquid of any kind on the product.
- 18) Damage Requiring Service—Unplug this product from the wall outlet and refer servicing to qualified service personnel under the following conditions:
 - a) When the AC cord or plug is damaged,
 - b) If liquid has been spilled, or objects have fallen into the product,
 - c) If the product has been exposed to rain or water,
 - d) If the product does not operate normally by following the operating instructions.
Adjust only those controls that are covered by the operating instructions as an improper adjustment of other controls may result in damage and will often require extensive work by a qualified technician to restore the product to its normal operation,
 - e) If the product has been dropped or damaged in any way, and
 - f) When the product exhibits a distinct change in performance - this indicates a need for service.
- 19) Replacement Parts—When replacement parts are required, be sure the service technician has used replacement parts specified by the manufacturer or have the same characteristics as the original part. Unauthorized substitutions may result in fire, electric shock, or other hazards.
- 20) Safety Check—Upon completion of any service or repairs to this product, ask the service technician to perform safety checks to determine that the product is in proper operating condition.
- 21) Wall or ceiling mounting—When mounting the product on a wall or ceiling, be sure to install the product according to the method recommended by the manufacturer.

IMPORTANT SAFETY INSTRUCTIONS

- **Water and Moisture** — Do not use this product near water - for example, near a bath tub, wash bowl, kitchen sink, or laundry tub; in a wet basement; or near a swimming pool; and the like.



- **Stand** — Do not place the product on an unstable cart, stand, tripod or table. Placing the product on an unstable base can cause the product to fall, resulting in serious personal injuries as well as damage to the product. Use only a cart, stand, tripod, bracket or table recommended by the manufacturer or sold with the product. When mounting the product on a wall, be sure to follow the manufacturer's instructions. Use only the mounting hardware recommended by the manufacturer.

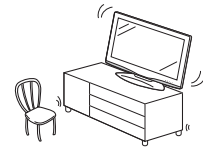

- **Selecting the location** — Select a place with no direct sunlight and good ventilation.

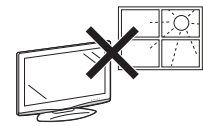

- **Ventilation** — The vents and other openings in the cabinet are designed for ventilation. Do not cover or block these vents and openings since insufficient ventilation can cause overheating and/or shorten the life of the product. Do not place the product on a bed, sofa, rug or other similar surface, since they can block ventilation openings. This product is not designed for built-in installation; do not place the product in an enclosed place such as a bookcase or rack, unless proper ventilation is provided or the manufacturer's instructions are followed.

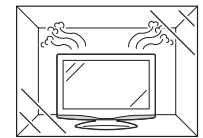

- **The Liquid Crystal panel used in this product is made of glass.** Therefore, it can break when the product is dropped or applied with impact. Be careful not to be injured by broken glass pieces in case the panel breaks.



- **Heat** — The product should be situated away from heat sources such as radiators, heat registers, stoves, or other products (including amplifiers) that produce heat.



- The Liquid Crystal panel is a very high technology product with 3,147,264 thin film transistors, giving you fine picture details. Occasionally, a few non-active pixels may appear on the screen as a fixed point of blue, green or red. Please note that this does not affect the performance of your product.

Precautions when transporting the TV

- Be sure to always carry the TV by two people holding it with two hands — one hand on each side of the TV.

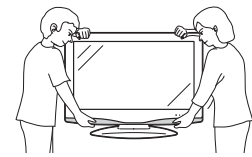

- **Lightning** — For added protection for this television equipment during a lightning storm, or when it is left unattended and unused for long periods of time, unplug it from the wall outlet and disconnect the antenna. This will prevent damage to the equipment due to lightning and power-line surges.

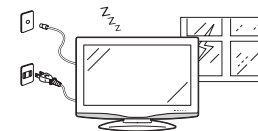

- **Power Lines** — An outside antenna system should not be located in the vicinity of overhead power lines or other electric light or power circuits, or where it can fall into such power lines or circuits. When installing an outside antenna system, extreme care should be taken to keep from touching such power lines or circuits as contact with them might be fatal.

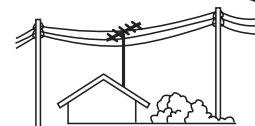

IMPORTANT SAFETY INSTRUCTIONS

- Outdoor Antenna Grounding — If an outside antenna is connected to the television equipment, be sure the antenna system is grounded so as to provide some protection against voltage surges and built-up static charges. Article 810 of the National Electrical Code, ANSI/NFPA 70, provides information with regard to proper grounding of the mast and supporting structure, grounding of the lead-in wire to an antenna discharge unit, size of grounding conductors, location of antenna-discharge unit, connection to grounding electrodes, and requirements for the grounding electrode.

EXAMPLE OF ANTENNA GROUNDING AS PER NATIONAL ELECTRICAL CODE, ANSI/NFPA 70

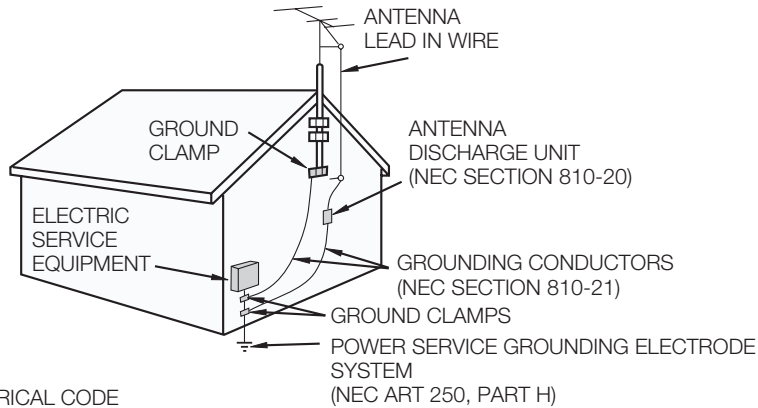

- To prevent fire, never place any type of candle or flames on the top or near the TV set.

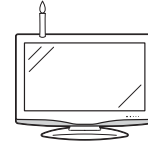

- To prevent fire or shock hazard, do not expose this product to dripping or splashing. No objects filled with liquids, such as vases, should be placed on the product.



- To prevent fire or shock hazard, do not place the AC cord under the TV set or other heavy items.

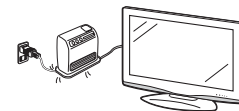

- Turn off the main power and unplug the AC cord from the wall outlet before handling.
- Use a soft cloth and gently wipe the surface of the display panel. Using a hard cloth may scratch the panel surface.
- Use a soft damp cloth to gently wipe the panel when it is really dirty. (It may scratch the panel surface when wiped strongly.)
- If the panel is dusty, use an anti-static brush, which is commercially available, to clean it.
- To protect the panel, do not use a dirty cloth, liquid cleaners or chemical cloth to clean it, such materials may damage the panel surface.
- To clean the outer cabinet, use the same method. Do not use liquid or aerosol cleaners.



- Do not display a still picture for a long time, as this could cause an afterimage to remain.

General notes

The Remote Replicator and the remote control unit are not supplied with this product.

The Remote Replicator (model number: AN-H06RCU) and the remote control unit (model number: AN-32HTRC) are available as optional accessories. Contact your nearest Sharp dealer for purchase. See the **OPERATION MANUAL FOR HOTEL OPERATOR** for details on the TV settings.

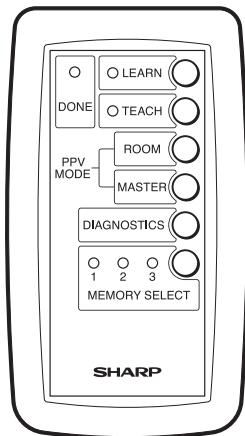

Remote Replicator
(AN-H06RCU)

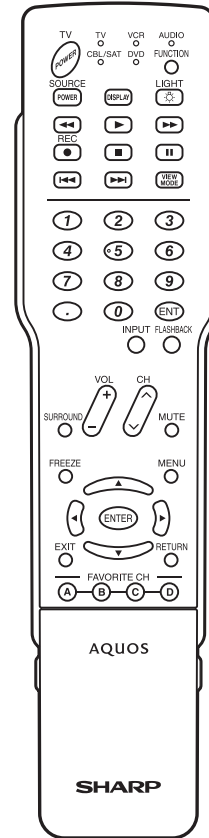

Remote control unit
(AN-32HTRC)

For hotel guests, use the remote control unit supplied by the Pay Per View provider to operate the TV.

Contents

Introduction

IMPORTANT INFORMATION	1
Trademarks	2
DEAR SHARP CUSTOMER	3
IMPORTANT SAFETY INSTRUCTIONS	3
General notes	6
Contents	7
Supplied accessories	8
Optional accessories.....	8
Part names	9
TV (Top/Front)	9
TV (Rear) (LC-32HT3U/37HT3U)	10
TV (Rear) (LC-42HT3U).....	11
Remote control unit (Optional accessory: AN-32HTRC).....	12
Remote Replicator (Optional accessory: AN-H06RCU)	13

Preparation

Attaching the stand (LC-32HT3U/37HT3U)	14
Attaching the stand (LC-42HT3U).....	15
Setting the TV.....	16
Connecting to the PPV terminal box.....	16
Antennas	17
Turning on the power	18
Turning off the power	18

Appendix

Removing the stand	19
Setting the TV on the wall	19
Troubleshooting	20
Troubleshooting-Digital broadcasting.....	20
Specifications.....	21
Optional accessory	21
Information on the software license for this product	22
Calling for Service	23
LIMITED WARRANTY	23



Dimensional drawings

- The dimensional drawings for the LCD TV set are shown on the inside back cover.

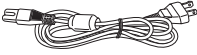
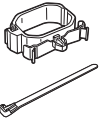

Supplied accessories

Make sure the following accessories are provided with the product.

LC-32HT3U/LC-37HT3U

			
AC cord (× 1) Page 16	Cable Clamp (× 1) Cable tie (× 1) Page 16	Stand unit (× 1) Page 14	Operation manual (× 1)

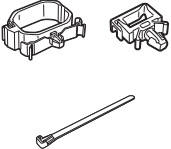
LC-42HT3U

			
AC cord (× 1) Page 16	Cable Clamp (× 2) Cable tie (× 1) Page 16	Stand unit (× 1) Page 15	Operation manual (× 1)

NOTE

- Always use the AC cord supplied with the TV.

Optional accessories

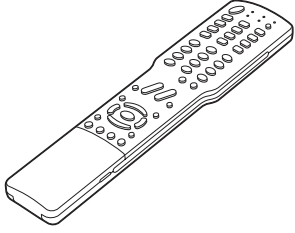
Remote Replicator with an RJ-11 cable	Remote control unit
 <p>AN-H06RCU</p>	 <p>AN-32HTRC</p>

Part names

TV (Top/Front)

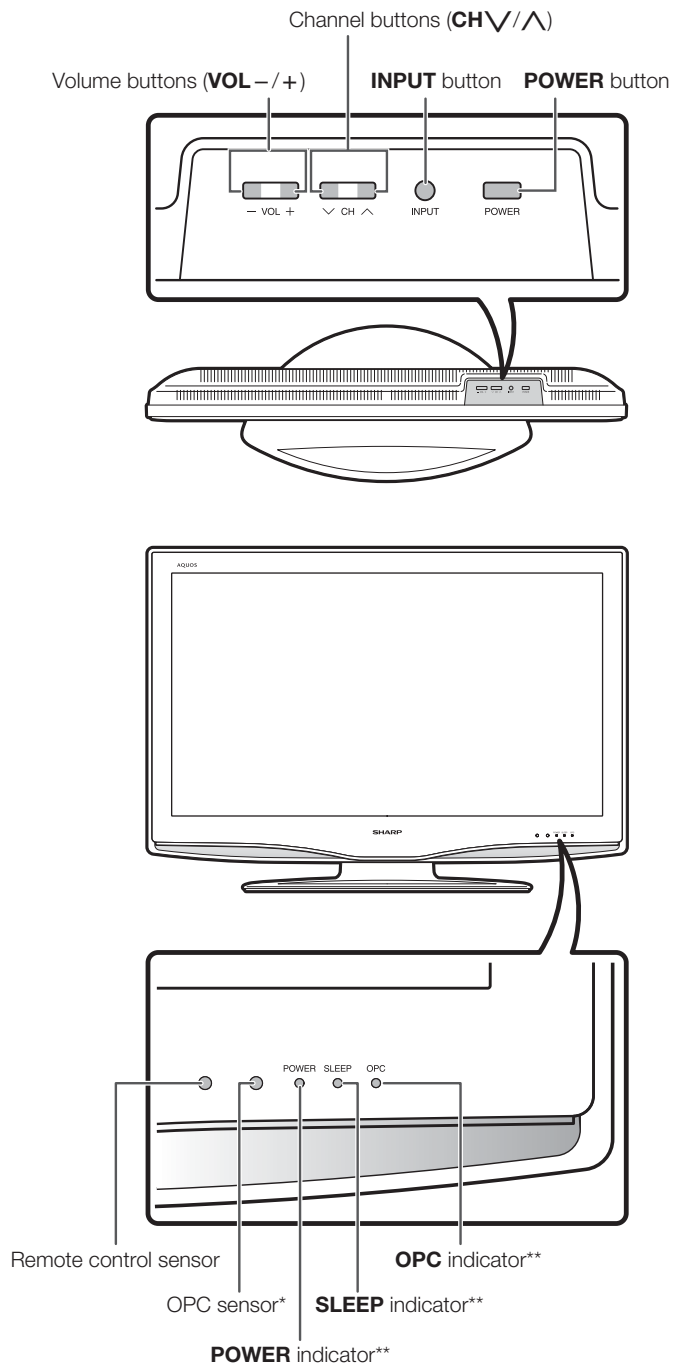

NOTE

* OPC: Optical Picture Control (See **OPERATION MANUAL FOR HOTEL OPERATOR.**)

** See page 18 for TV status indicator.

Part names

TV (Rear)

LC-32HT3U/LC-37HT3U

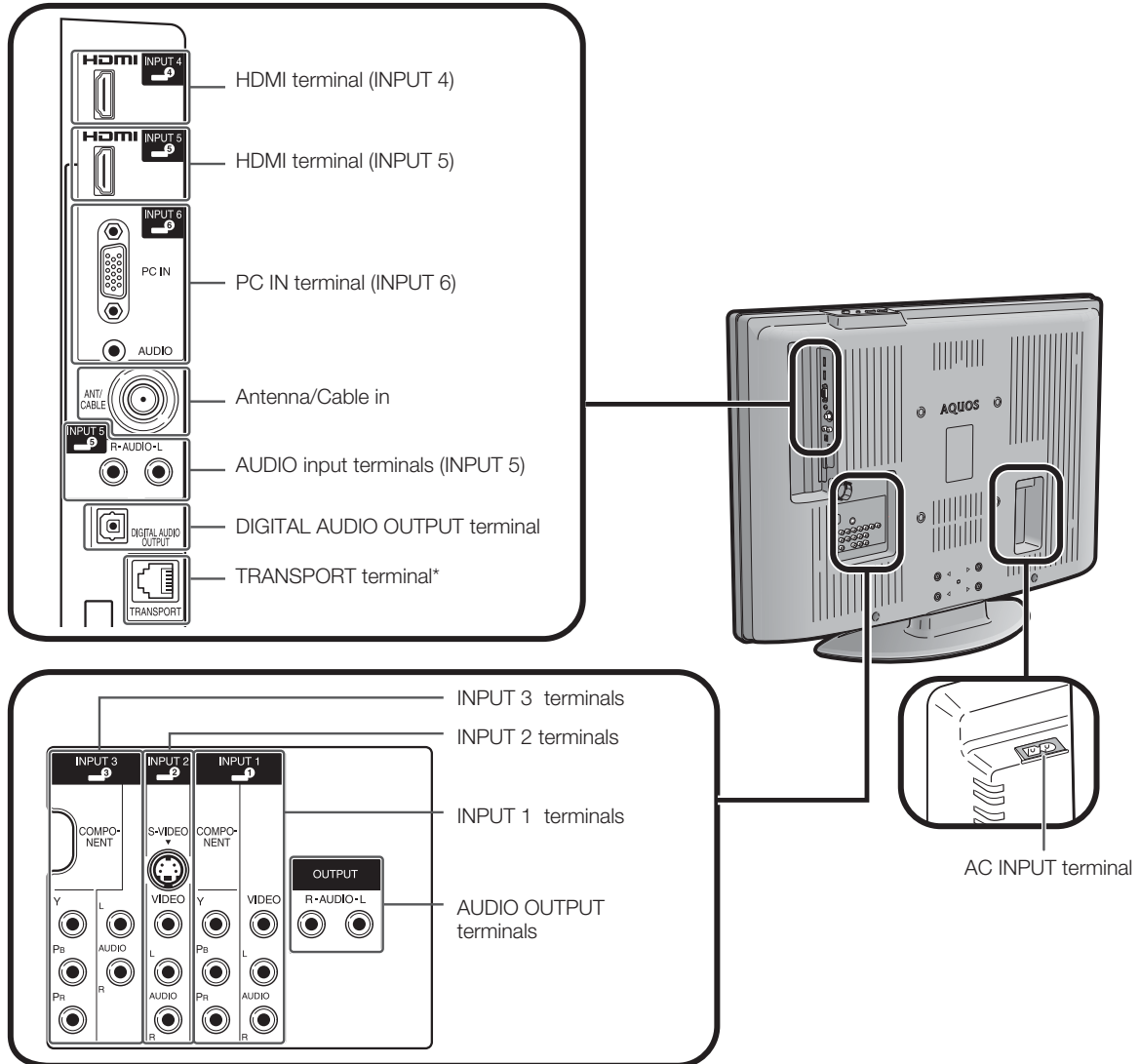

NOTE

* The TRANSPORT terminal is designed for hotel communication. Do not use it for other purposes.

Part names

TV (Rear)

LC-42HT3U

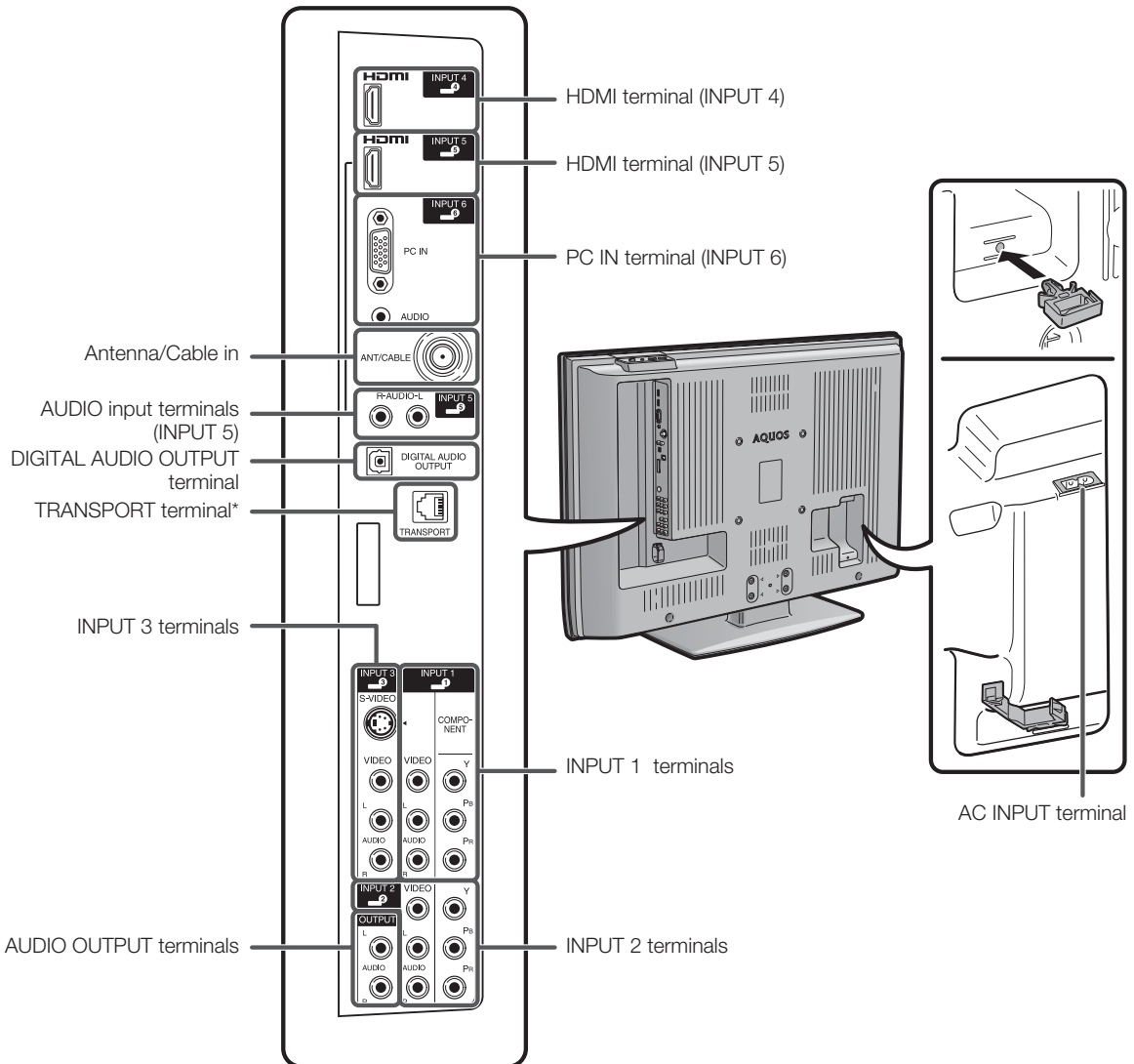

NOTE

* The TRANSPORT terminal is designed for hotel communication. Do not use it for other purposes.

Part names

Remote control unit (Optional accessory: AN-32HTRC)

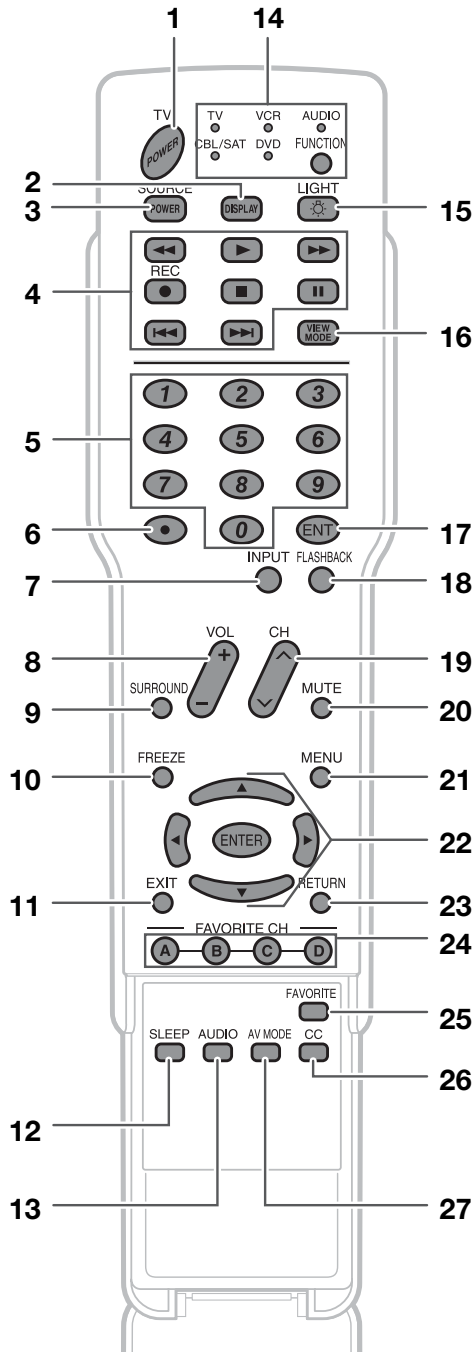

- 1 **TV POWER:** Switches the TV power on or enters standby.
- 2 **DISPLAY:** Displays the channel information.
- 3 **SOURCE POWER:** Turns the power of the external equipment on and off.
- 4 **External equipment operational buttons:** Operates the external equipment.
- 5 **0 – 9:** Sets the channel.
- 6 **• (DOT)**
- 7 **INPUT:** Selects a TV input source. (TV, INPUT 1, INPUT 2, INPUT 3, INPUT 4, INPUT 5, INPUT 6)
- 8 **VOL +/-:** Sets the volume.
- 9 **SURROUND:** Selects Surround settings.
- 10 **FREEZE:** Sets the still image. Press again to return to normal screen.
- 11 **EXIT:** Turns off the menu screen.
- 12 **SLEEP:** Sets the sleep timer.
- 13 **AUDIO:** Selects the MTS/SAP or the audio mode during multi-channel audio broadcasts.
- 14 **FUNCTION:** Switches the remote control for TV, CBL/SAT, VCR, DVD and AUDIO operation. Indicator lights up for the current mode.
* To enter the code registration mode, you need to press **FUNCTION** and **DISPLAY** at the same time.
- 15 **LIGHT** : When pressed all buttons on the remote control unit will light. The lighting will turn off if no operations are performed within about 5 seconds. This button is used for performing operations in low-light situations.
- 16 **VIEW MODE:** Selects the screen size.
- 17 **ENT:** Jumps to a channel after selecting with the **0-9** buttons.
- 18 **FLASHBACK:** Returns to the previous channel or external input mode.
- 19 **CH \wedge/\vee :** Selects the channel.
- 20 **MUTE:** Mutes the sound.
- 21 **MENU:** Displays the menu screen.
- 22 **$\blacktriangle/\blacktriangledown/\blacktriangleleft/\blacktriangleright$ /ENTER:** Selects a desired item on the screen.
- 23 **RETURN:** Returns to the previous menu screen.
- 24 **FAVORITE CH**
A, B, C, D: Selects four preset favorite channels in four different categories.
While watching, you can toggle the selected channels by pressing A, B, C and D.
- 25 **FAVORITE:** Set the favorite channels.
- 26 **CC:** Displays captions from a closed-caption source.
- 27 **AV MODE:** Selects an audio or video setting.
(When the input source is TV, INPUT 1, 2 or 3: STANDARD, MOVIE, GAME, USER, DYNAMIC (Fixed), DYNAMIC. When the input source is INPUT 4, 5 or 6: STANDARD, MOVIE, GAME, PC, USER, DYNAMIC (Fixed), DYNAMIC)

NOTE

- When using the remote control unit, point it at the TV.
- See the **OPERATION MANUAL FOR HOTEL OPERATOR** for details on the functions of each button.

Part names

Remote Replicator (Optional accessory: AN-H06RCU)

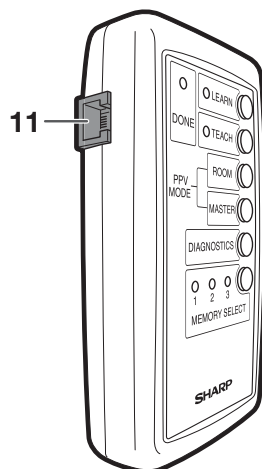
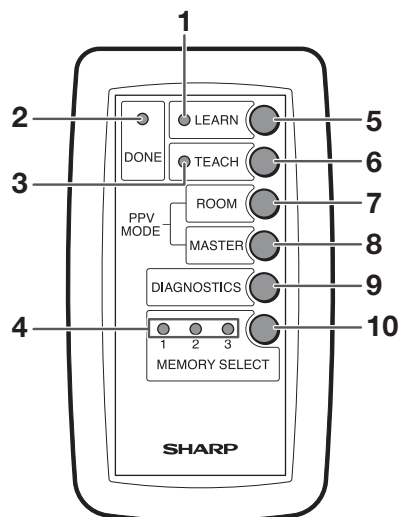

- 1 LEARN indicator:** Lights up while storing the TV settings from the TV to the Remote Replicator.
- 2 DONE indicator:** Lights up when storing or transferring is finished.
- 3 TEACH indicator:** Lights up while transferring the TV settings from the Remote Replicator to the TV.
- 4 MEMORY SELECT indicator:** Indicates which memory bank is selected.
- 5 LEARN button:** Store the TV settings from the TV to the Remote Replicator.
- 6 TEACH button:** Transfer the TV settings from the Remote Replicator to the TV.
- 7 ROOM button:** The TV turns off and enters the ROOM mode when the TV is in the MASTER mode. You can turn on or off the TV when the TV is in the ROOM mode.
- 8 MASTER button:** The TV is turned on and enters the MASTER mode when the TV is turned off. The menu screen displays when the TV is turned on in the MASTER mode or the ROOM mode. The TV is turned off and enters the PPV TV mode when the TV is in the Normal TV mode.
- 9 DIAGNOSTICS button:** Perform operational tests.
- 10 MEMORY SELECT button:** Select the memory bank to store or transfer data.
- 11 TRANSPORT (RJ-11) connector:** Connect to the TV when storing or transferring the data.

NOTE

- When using the Remote Replicator, point it at the TV.
- See the **OPERATION MANUAL FOR HOTEL OPERATOR** for details on the functions of each button.
- The TRANSPORT (RJ-11) connector is designed for hotel communication. Do not use it for other purposes.

The Remote Replicator is only for hotel operators.

Preparation

Attaching the stand

- Before attaching (or detaching) the stand, unplug the AC cord from the AC INPUT terminal.
- Before performing work spread cushioning over the base area to lay the TV on. This will prevent it from being damaged.

CAUTION

- **Attach the stand in the correct direction.**
- **Be sure to follow the instructions. Incorrect installation of the stand may result in the TV falling over.**

LC-32HT3U/37HT3U

- 1** Confirm that there are 9 screws (all the same size) supplied with the TV.



- 2**
- ① Set the post for the stand unit onto the box.
 - ② Attach the base to the post.
 - ③ Insert and tighten the 5 screws into the 5 holes on the bottom of the base.

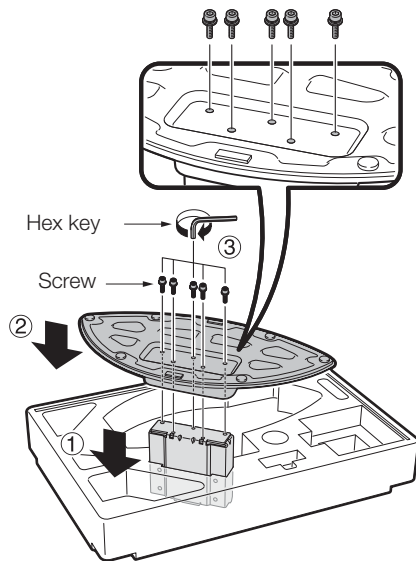

- 3**
- ① Insert the stand into the openings on the bottom of the TV.
 - ② Insert and tighten the 4 screws into the 4 holes on the rear of the TV.

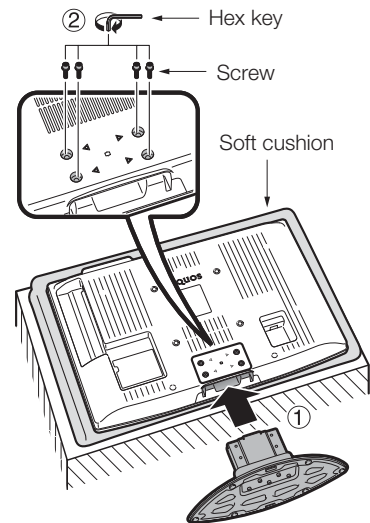

NOTE

- To detach the stand, perform the steps in reverse order.

Preparation

Attaching the stand

- Before attaching (or detaching) the stand, unplug the AC cord from the AC INPUT terminal.
- Before performing work spread cushioning over the base area to lay the TV on. This will prevent it from being damaged.

CAUTION

- **Attach the stand in the correct direction.**
- **Be sure to follow the instructions. Incorrect installation of the stand may result in the TV falling over.**

LC-42HT3U

- 1** Confirm that there are 8 screws supplied with the TV.

Short screws (×4) (Used in step 2) **Long screws (×4)** (Used in step 3)



- 2**
- ① Set the post for the stand unit onto the box.
 - ② Attach the base to the post.
 - ③ Insert and tighten the 4 short screws into the 4 holes on the bottom of the base.

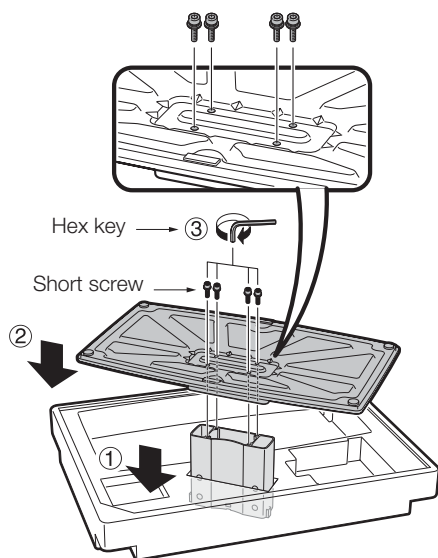

- 3**
- ① Insert the stand into the openings on the bottom of the TV.
 - ② Insert and tighten the 4 long screws into the 4 holes on the rear of the TV.

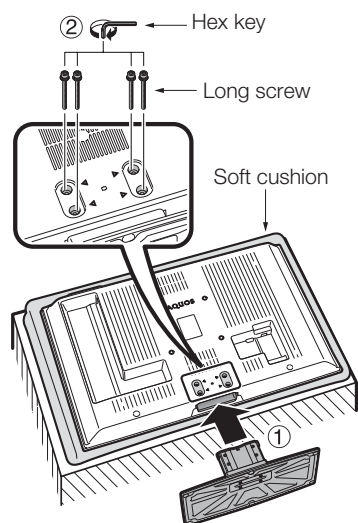

NOTE

- To detach the stand, perform the steps in reverse order.

Preparation

Setting the TV

1 Attach your antenna to the back of the TV. (See page 17.)

2 Connect the AC plug for the TV into the AC outlet.

- Place the TV close to the AC outlet, and keep the power plug within reach.

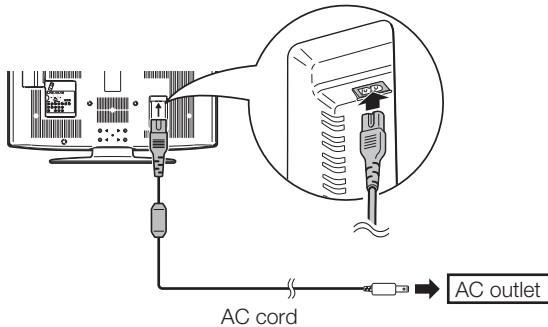

CAUTION

- TO PREVENT RISK OF ELECTRIC SHOCK, DO NOT TOUCH UN-INSULATED PARTS OF ANY CABLES WITH THE AC CORD CONNECTED.**

NOTE

- Speakers cannot be detached from the TV.
- TV angle cannot be adjusted.

3 Place the ferrite core in the space indicated in the below figure and bundle the cords properly with a cable clamp and cable tie.

LC-32HT3U/37HT3U

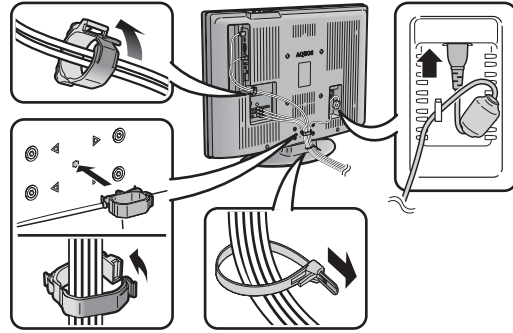

LC-42HT3U

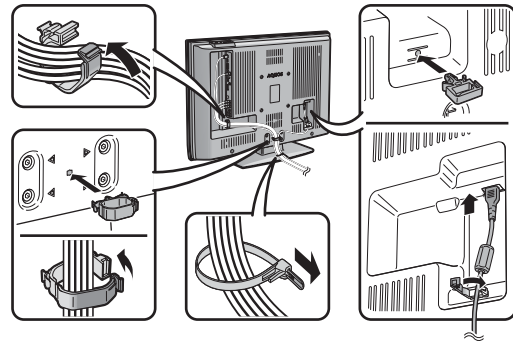

Connecting to the PPV terminal box

Connect the TV and the PPV terminal box as shown.

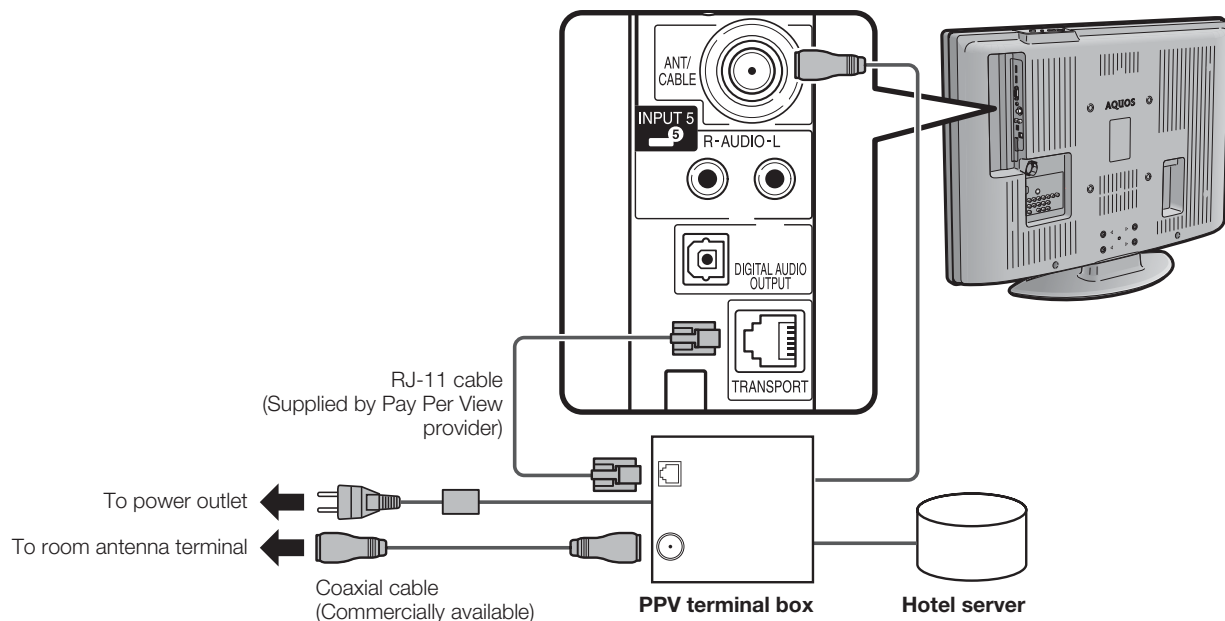

Preparation

Antennas

To enjoy a clearer picture, use an outdoor antenna. The following is a brief explanation of the types of connections that are used for a coaxial cable. If your outdoor antenna uses a 75-ohm coaxial cable with an F-type connector, plug it into the antenna terminal at the rear of the TV set.

1. A 75-ohm system is generally a round cable with F-type connector that can easily be attached to a terminal without tools (Commercially available).

F-type connector



2. A 300-ohm system is a flat "twin-lead" cable that can be attached to a 75-ohm terminal through a 300/75-ohm adapter (Commercially available).



NOTICE F-type connector should be finger-tightened only.

When connecting the RF cable to the TV set, do not tighten F-type connector with tools. If tools are used, it may cause damage to your TV set. (The breaking of internal circuit, etc.)

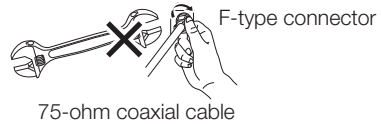

Connecting Antenna Cable

- ① Cable without a CATV converter

- ② VHF/UHF antenna

- ③ Combination VHF/UHF antenna

- ④ Separate VHF/UHF antenna

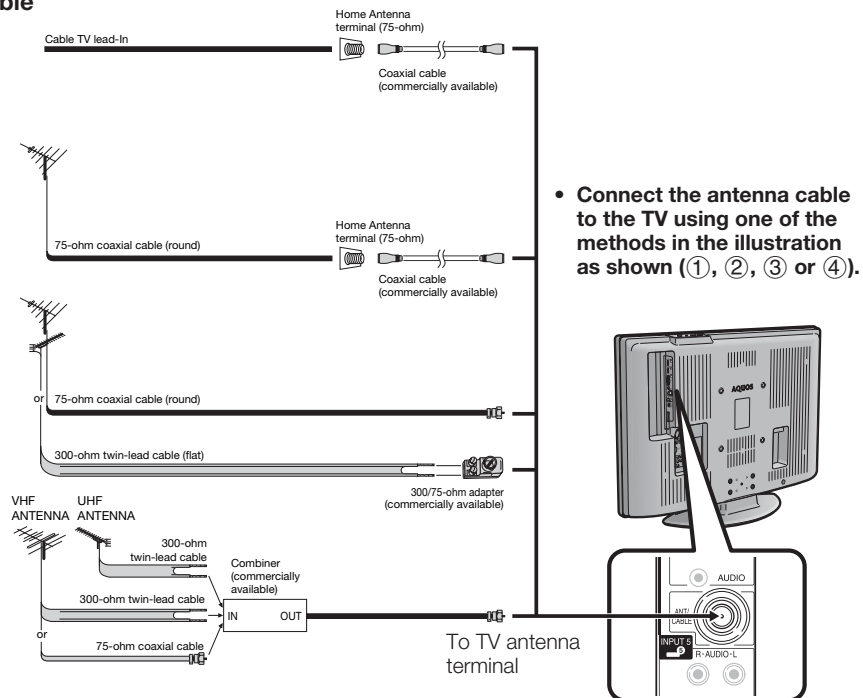

Preparation

Simple operations for watching a TV program

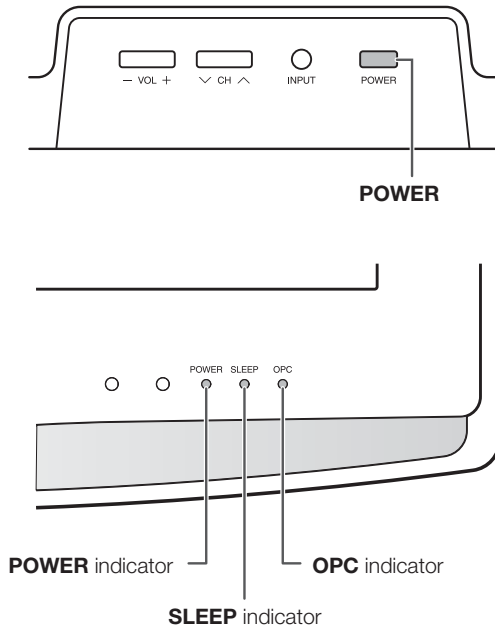

Turning on the power

Press **POWER** on the TV.

- **POWER** indicator (Green): The TV is on. (After a few seconds, a window appears with sound.)

Turning off the power

Press **POWER** on the TV.

- The TV enters standby and the image on the screen disappears.
- The **POWER** indicator on the TV turns off.

NOTE

- If you are not going to use this TV for a long period of time, be sure to remove the AC cord from the power outlet.
- Weak electric power is still consumed even when the TV is turned off.

TV status indicator (POWER)

ON	Lighting (Green)
Standby	Lights off

TV status indicator (OPC)

"Off" is selected in OPC setting	Lights off
"On" or "On: Display" is selected in OPC setting	Lighting (Green)

*OPC: Optical Picture Control

TV status indicator (SLEEP)

"Off" is selected in SLEEP setting	Lights off
"30", "60", "90" or "120" is selected in SLEEP setting	Lighting (Red)

IMPORTANT:

IF THE UNIT DOES NOT POWER ON - UNPLUG THE AQUOS TELEVISION FROM THE OUTLET AND REPEAT THE INSTALLATION STEPS.

IF YOU STILL ENCOUNTER NO POWER, PLEASE CONTACT US AT 1-800-BE-SHARP.

For hotel guests, use the remote control unit supplied by the Pay Per View provider to operate the TV.

Appendix

Removing the stand

Before detaching (or attaching) stand, unplug the AC cord from the AC INPUT terminal.

CAUTION

- Do not remove the stand from the TV unless using an optional wall mount bracket to mount it.

Before attaching/detaching stand

- Before performing work make sure to turn off the TV.
- Before performing work spread cushioning over the base area to lay the TV on. This will prevent it from being damaged.

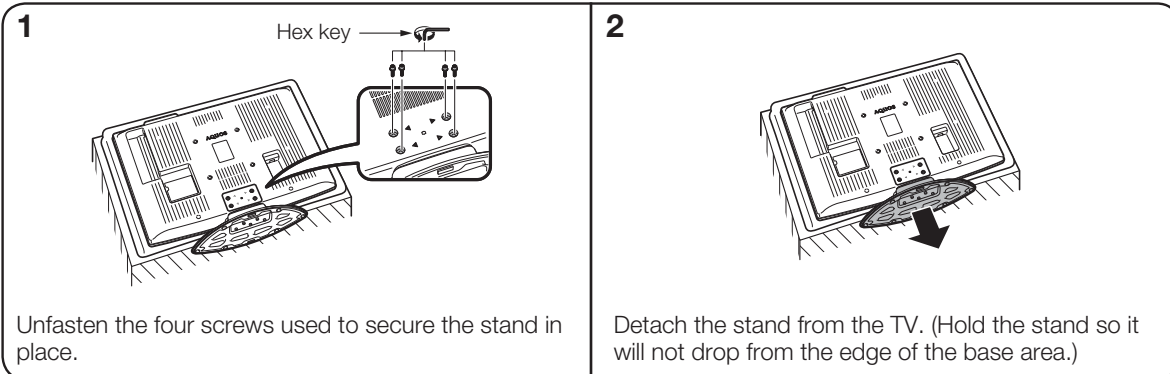

NOTE

- To attach the stand, perform the above steps in reverse order.

Setting the TV on the wall

CAUTION

- The model AN-52AG1 of the wall mount bracket can be used only with LC-42HT3U.
- This TV should be mounted on the wall only with the AN-37AG2/AN-52AG1 (SHARP) wall mount bracket. The use of other wall mount brackets may result in an unstable installation and may cause serious injuries.
- Installing the TV requires special skill that should only be performed by qualified service personnel. Customers should not attempt to do the work themselves. SHARP bears no responsibility for improper mounting or mounting that results in accident or injury.

Using an optional bracket to mount the TV

- You can ask a qualified service professional about using an optional AN-37AG2/AN-52AG1 bracket to mount the TV to the wall.
- Carefully read the instructions that come with the bracket before beginning work.

Hang on the wall

AN-37AG2/AN-52AG1 wall mount bracket.
(See the bracket instructions for details.)

Vertical mounting Angular mounting

About setting the TV angle and height adjustment

AN-37AG2

AN-52AG1

AN-37AG2	
Model	Angle of TV
LC-32HT3U	0/5/10°
LC-37HT3U/ LC-42HT3U	0/5°

AN-52AG1 (LC-42HT3U only)

①	0/5/10/15/20°
②	- 1 ⁶³ / ₆₄ (-5)/0/ + 1 ⁶³ / ₆₄ (+5) • can be moved 1 ⁶³ / ₆₄ (5) up or down Unit: inch (cm)

NOTE

- Detach the cable clamps on the rear of the TV when using the optional mount bracket.
- Due to the terminal configuration on this TV, when you wall-mount this model, make sure there is enough space between the wall and the TV for the cables.

Appendix

Troubleshooting

Problem	Possible Solution
<ul style="list-style-type: none"> No power 	<ul style="list-style-type: none"> Check if you pressed TV POWER on the remote control unit. (See page 12.) If the indicator on the TV does not light up, press POWER on the TV. Is the AC cord disconnected? (See page 16.) Has the power been turned on? (See page 18.)
<ul style="list-style-type: none"> Unit cannot be operated. 	<ul style="list-style-type: none"> External influences such as lightning, static electricity, may cause improper operation. In this case, operate the unit after first turning off the power of the TV or unplugging the AC cord and replugging it in after 1 or 2 minutes.
<ul style="list-style-type: none"> Remote control unit does not operate. 	<ul style="list-style-type: none"> Is the FUNCTION set correctly? Set it to the TV setting position. Are batteries inserted with polarity (+, -) aligned? * Are batteries worn out? (Replace with new batteries.) Are you using it under strong or fluorescent lighting? Is a fluorescent light illuminated near the remote control sensor?
<ul style="list-style-type: none"> Picture is cut off/with sidebar screen. 	<ul style="list-style-type: none"> Is the image position correct? * Are screen mode adjustments such as picture size made correctly? *
<ul style="list-style-type: none"> Strange color, light color, or color misalignment 	<ul style="list-style-type: none"> Adjust the picture tone. * Is the room too bright? The picture may look dark in a room that is too bright. Check the input signal setting. *
<ul style="list-style-type: none"> Power is suddenly turned off. 	<ul style="list-style-type: none"> Is the sleep timer set? * Check the power control settings. * The unit's internal temperature has increased. Remove any objects blocking vent or clean.
<ul style="list-style-type: none"> No picture 	<ul style="list-style-type: none"> Is connection to other components correct? * Is correct input signal source selected after connection? * Is the correct input selected? * Is picture adjustment correct? * Is "On" selected in "Audio Only"? * Is a non-compatible signal being input? *
<ul style="list-style-type: none"> No sound 	<ul style="list-style-type: none"> Is the volume too low? * Is "Variable" selected in "Output Select"? * Have you pressed MUTE on the remote control unit? *
<ul style="list-style-type: none"> The TV sometimes makes a cracking sound. 	<ul style="list-style-type: none"> This is not a malfunction. This happens when the cabinet slightly expands and contracts according to change in temperature. This does not affect the TV's performance.

- See the **OPERATION MANUAL FOR HOTEL OPERATOR** for the Possible Solutions marked with an asterisk (*).

Troubleshooting-Digital broadcasting

The error message about reception of broadcast

The example of an error message displayed on a screen	Error code	Possible Solution
<ul style="list-style-type: none"> Failed to receive broadcast. 	E202	<ul style="list-style-type: none"> Check the antenna cable. Check that the antenna is correctly setup.
<ul style="list-style-type: none"> No broadcast now. 	E203	<ul style="list-style-type: none"> Check the broadcast time in the program guide.

Cautions regarding use in high and low temperature environments

- When the unit is used in a low temperature space (e.g. room, office), the picture may leave trails or appear slightly delayed. This is not a malfunction, and the unit will recover when the temperature returns to normal.
- Do not leave the unit in a hot or cold location. Also, do not leave the unit in a location exposed to direct sunlight or near a heater, as this may cause the cabinet to deform and the Liquid Crystal panel to malfunction.
Storage temperature: -4°F to +140°F (-20°C to +60°C)

Appendix

Specifications

Item		Model: LC-32HT3U	Model: LC-37HT3U	Model: LC-42HT3U
LCD panel		32" Advanced Super View & BLACK TFT LCD (Screen size 31 1/2" measured diagonally)	37" Advanced Super View & BLACK TFT LCD (Screen size 37" measured diagonally)	42" Advanced Super View & BLACK TFT LCD (Screen size 42 1/64" measured diagonally)
Number of dots		3,147,264 dots (1366 × 768 × 3 dots)		
TV Function	TV-standard (CCIR)	American TV Standard ATSC/NTSC System		
	Receiving Channel	VHF/UHF	VHF 2-13ch, UHF 14-69ch	
		CATV	1-135ch	
		Digital Terrestrial Broadcast (8VSB)	2-69ch	
		Digital cable*1 (64/256 QAM)	1-135ch	
Audio multiplex	BTSC System			
Backlight		60,000 hours (at Backlight Standard position)		
Audio out		10W × 2		
Terminals	Rear	INPUT 1	AV in, COMPONENT in	
		INPUT 2	AV in, S-VIDEO in	AV in, COMPONENT in
		INPUT 3	Audio in, COMPONENT in	AV in, S-VIDEO in
		INPUT 4	HDMI in with HDCP	
		INPUT 5	Audio in, HDMI in with HDCP	
		INPUT 6	15 pin mini D-sub female connector, Audio in (Ø 3.5 mm jack)	
		ANTENNA	75 Ω Unbalance, F Type × 1 (VHF/UHF/CATV/ATSC/QAM)	
		DIGITAL AUDIO OUTPUT	Optical Digital audio output × 1 (PCM/Dolby Digital)	
		OUTPUT	Audio out	
		TRANSPORT	RJ-11	
OSD language		English/French/Spanish		
Power Requirement		AC 120 V, 60 Hz		
Power Consumption		152 W	185 W	235 W
Weight	TV + stand	40.8 lbs./18.5 kg	50.7 lbs./23.0 kg	67.2 lbs./30.5 kg
	TV only	35.3 lbs./16.0 kg	43.0 lbs./19.5 kg	59.5 lbs./27.0 kg
Dimension*2 (W × H × D)	TV + stand	31 ¹¹ / ₃₂ × 23 ¹³ / ₆₄ × 9 ³⁷ / ₆₄ inch	35 ⁶¹ / ₆₄ × 25 ²⁷ / ₃₂ × 11 ³⁵ / ₆₄ inch	40 ¹⁹ / ₃₂ × 28 ⁷ / ₈ × 11 ¹ / ₂ inch
	TV only	31 ¹¹ / ₃₂ × 20 ⁵⁹ / ₆₄ × 3 ⁵³ / ₆₄ inch	35 ⁶¹ / ₆₄ × 23 ³⁷ / ₆₄ × 3 ⁵³ / ₆₄ inch	40 ¹⁹ / ₃₂ × 26 ³⁷ / ₆₄ × 5 ⁹ / ₃₂ inch
Operating temperature		+ 32°F to + 104°F (0°C to + 40°C)		

*1 Emergency alert messages via Cable are unreceivable.

*2 The dimensional drawings are shown on the inside back cover.

- As part of policy of continuous improvement, SHARP reserves the right to make design and specification changes for product improvement without prior notice. The performance specification figures indicated are nominal values of production units. There may be some deviations from these values in individual units.

Optional accessory

The listed optional accessory is available for the Liquid Crystal Television. Please purchase it at your nearest shop.

- Additional optional accessories may be available in the near future. When purchasing, please read the newest catalogue for compatibility and check the availability.

Part name	Model number
Wall mount bracket	AN-37AG2 AN-52AG1 (LC-42HT3U only)

Appendix

Information on the software license for this product

Software composition

The software included in this product is comprised of various software components whose individual copyrights are held by SHARP or by third parties.

Software developed by SHARP and open source software

The copyrights for the software components and various relevant documents included with this product that were developed or written by SHARP are owned by SHARP and are protected by the Copyright Act, international treaties, and other relevant laws. This product also makes use of freely distributed software and software components whose copyrights are held by third parties. These include software components covered by a GNU General Public License (hereafter GPL), a GNU Lesser General Public License (hereafter LGPL) or other license agreement.

Obtaining source code

Some of the open source software licensors require the distributor to provide the source code with the executable software components. GPL and LGPL include similar requirements. For information on obtaining the source code for the open source software and for obtaining the GPL, LGPL, and other license agreement information, visit the following website:

<http://www.sharpusa.com/gpl>

We are unable to answer any questions about the source code for the open source software. The source code for the software components whose copyrights are held by SHARP is not distributed.

Acknowledgements

The following open source software components are included in this product:

- linux kernel
- busybox
- uClibc
- zlib
- libpng
- libjpeg

Calling for Service

For location of the nearest Sharp Authorized Service, or to obtain product literature, accessories, supplies, or customer assistance, please call 1-800-BE-SHARP.

LIMITED WARRANTY

HOSPITALITY/LODGING COMMERCIAL APPLICATION LIMITED WARRANTY

SHARP ELECTRONICS CORPORATION warrants to the first end user purchaser that this commercial application Sharp brand product (the "Product"), when shipped in its original container, will be free from defective workmanship and materials, and agrees that it will, at its option, either repair the defect or replace the defective Product or part thereof with a new or remanufactured equivalent at no charge to the purchaser for parts or labor for the period(s) set forth below.

This warranty does not apply to any cosmetic or consumable items of the Product or if the serial number or model number affixed to the Product has been removed, defaced, changed, altered or tampered with. This warranty does not cover installation or signal reception problems.

In order to enforce the rights under this limited warranty, the purchaser should follow the steps set forth below. The purchaser must be able to provide proof of purchase to the servicer, which proof must include the date of purchase.

To the extent permitted by applicable state law, the warranties set forth are in lieu of, and exclusive of, all other warranties, express or implied. Specifically ALL OTHER WARRANTIES OTHER THAN THOSE SET FORTH ABOVE ARE EXCLUDED, ALL EXPRESS AND IMPLIED WARRANTIES INCLUDING THE WARRANTIES OF MERCHANTABILITY, FITNESS FOR USE, AND FITNESS FOR A PARTICULAR PURPOSE ARE SPECIFICALLY EXCLUDED. IF, UNDER APPLICABLE STATE LAW, IMPLIED WARRANTIES MAY NOT VALIDLY BE DISCLAIMED OR EXCLUDED, THE DURATION OF SUCH IMPLIED WARRANTIES IS LIMITED TO THE PERIOD(S) FROM THE DATE OF PURCHASE SET FORTH BELOW.

The warranties given herein shall be the sole and exclusive warranties granted by Sharp and shall be the sole and exclusive remedy available to the purchaser and only for the time periods set forth herein. Correction of defects, in the manner and for the period of time described herein, shall constitute complete fulfillment of all liabilities and responsibilities of Sharp to the purchaser with respect to the Product, and shall constitute full satisfaction of all claims, whether based on contract, negligence, strict liability or otherwise. Sharp does not warrant nor shall Sharp be liable, or in any way responsible, for Products which have been subject to abuse (including, but not limited to, improper voltage), accident, misuse, negligence, lack of reasonable care, alteration, modification, tampering, misuse, improper operation or maintenance or any damages or defects in the Product which were caused by repairs or attempted repairs performed by anyone other than a Sharp authorized servicer. Nor shall Sharp be liable or in any way responsible for any incidental or consequential economic or property damage. Some states do not allow limits on warranties or on remedies for breach in certain transactions; in such states, the limits herein may not apply.

Model Specific Section (On-Site Service)

Your Product Model Number & Description:

LC-32HT3U, LC-37HT3U, LC-42HT3U Hospitality LCD TV

(Be sure to have this information available when you need service for your Product.)

Warranty Period for this Product:

Two (2) years parts and labor from date of purchase.

Additional Exclusions:

In order for the Product to be serviced, the Product must be readily available to the servicer, free and clear of any installation, mounting or other encumbrance which would interfere with servicing the Product. The servicer will not reinstall or remount the Product after service. Any labor and materials required to remove and/or reinstall a Product are the responsibility of the end-user. Image retention or burn-in resulting from fixed images displayed for long periods of time.

Where to Obtain Service:

From a Sharp Authorized Servicer located in the United States. To find the location of the nearest Sharp Authorized Servicer, call Sharp toll free at 1-800-BE-SHARP.

What to do to Obtain Service:

Contact your Sharp Authorized Servicer to obtain on-site service for this product. The Servicer will come to your location and if necessary remove the unit for repair at the Servicer's facility. Be sure to have **Proof of Purchase** available.

TO OBTAIN PRODUCT INFORMATION OR ACCESSORIES, CALL **1-800-BE-SHARP**
OR VISIT www.sharppusa.com

SHARP®

LIMITED WARRANTY

Consumer Electronics Products

Congratulations on your purchase!

END-USER LIMITED WARRANTY

Sharp Electronics Of Canada Limited warrants to the first end user purchaser that this Sharp brand product (the "Product") when shipped in its original container, will be free from defective workmanship and materials, and agrees that it will, at its option, either repair the defect or replace the defective Product or part thereof with a new or remanufactured equivalent at no charge to the purchaser for parts or labor for the period(s) set forth below.

This warranty does not apply to any appearance items of the Product nor to the additional excluded item(s) set forth below nor to any Product the exterior of which has been damaged or defaced, which has been subjected to improper voltage or other misuse, abnormal service or handling, or which has been altered or modified in design or construction. In order to enforce the rights under this limited warranty, the purchaser should follow the steps set forth below and provide proof of purchase to the servicer.

To the extent permitted by applicable provincial law, the warranties set forth herein are in lieu of, and exclusive of, all other warranties, express or implied. Specifically, ALL OTHER WARRANTIES OTHER THAN THOSE SET FORTH ABOVE ARE EXCLUDED. ALL EXPRESS AND IMPLIED WARRANTIES INCLUDING THE WARRANTIES OF MERCHANTABILITY, FITNESS FOR USE, AND FITNESS FOR A PARTICULAR PURPOSE ARE SPECIFICALLY EXCLUDED. If, under applicable provincial law, implied warranties may not validly be disclaimed or excluded, the duration of such implied warranties is limited to the period(s) from the date of purchase set forth below.

Neither the sales personnel of the seller nor any other person is authorized to make any warranties other than those described herein, or to extend the duration of any warranties beyond the time period described herein on behalf of Sharp.

The warranties described herein shall be the sole and exclusive warranties granted by Sharp and shall be the sole and exclusive remedy available to the purchaser. Correction of defects, in the manner and for the period of time described herein, shall constitute complete fulfillment of all liabilities and responsibilities of Sharp to the purchaser with respect to the Product, and shall constitute full satisfaction of all claims, whether based on contract, negligence, strict liability or otherwise. In no event shall Sharp be liable, or in any way responsible, for any damages or defects in the Product which were caused by repairs or attempted repairs performed by anyone other than an authorized servicer. Nor shall Sharp be liable or in any way responsible for any incidental or consequential economic or property damage. Some provinces do not allow limits on warranties or on remedies for breach in certain transactions; in such states, the limits herein may not apply.

Model Specific Section (On-Site Service)

Your Product Model Number & Description:

LC-32HT3U, LC-37HT3U, LC-42HT3U Hospitality LCD TV

Warranty Period for this Product:

Two (2) years parts & labor from date of purchase

Additional Item(s) Excluded from Warranty Coverage (if any):

Labor and materials required to remove and reinstall in custom enclosures, and TV's connected to third party control and automation systems.

What to do to Obtain Service:

Contact your Sharp Authorized Servicer to obtain on-site service for this Product.

To obtain the name and address of the nearest Authorized Sharp Service Centre or Dealer, please contact:
SHARP ELECTRONICS OF CANADA LTD. 335 Britannia Road East, Mississauga, Ontario L4Z 1W9

For more information on this Warranty, Sharp Extended Warranty Offers, Sharp Canada Products, Accessory Sales, Dealer or Service Locations, please call (905) 568-7140
Visit our Web site: www.sharp.ca



Dimensional drawings

LC-32HT3U

Unit: inch/(mm)

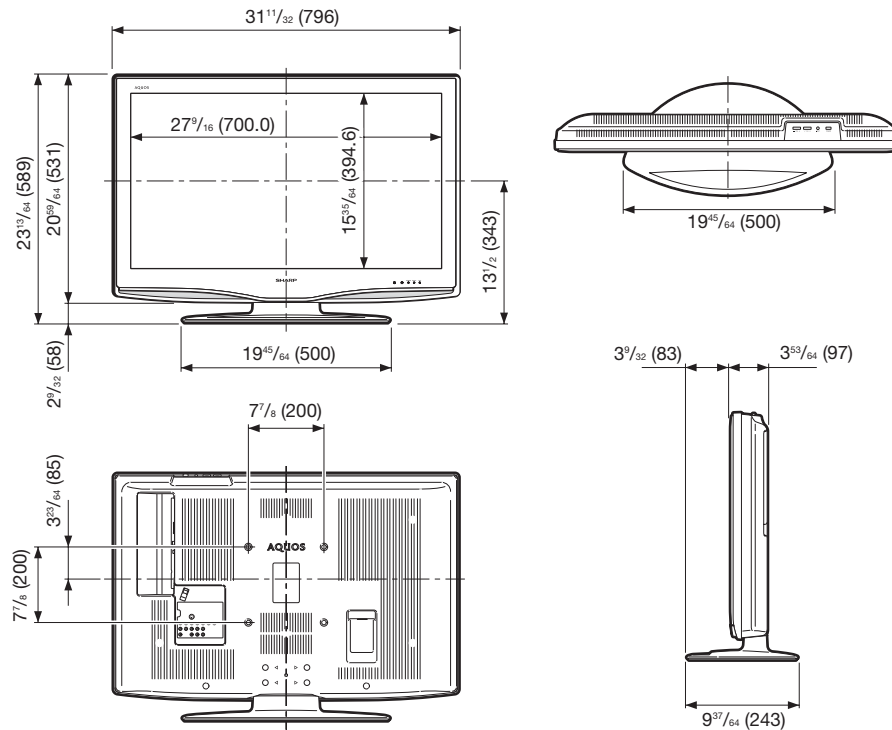

LC-37HT3U

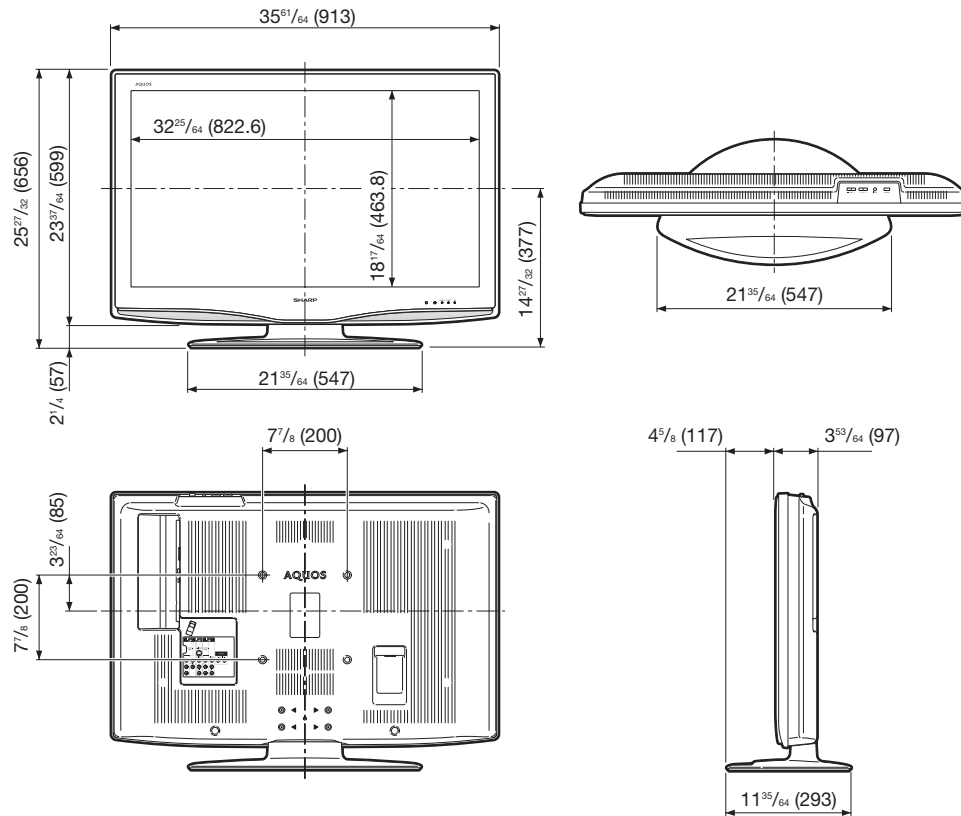

SHARP[®]

SHARP ELECTRONICS CORPORATION

Sharp Plaza, Mahwah, New Jersey 07430-2135

SHARP CORPORATION

Printed in Mexico
Imprimé au Mexique
Impreso en México
TINS-D139WJZZ
07P08-MX-NG

Free Manuals Download Website

<http://myh66.com>

<http://usermanuals.us>

<http://www.somanuals.com>

<http://www.4manuals.cc>

<http://www.manual-lib.com>

<http://www.404manual.com>

<http://www.luxmanual.com>

<http://aubethermostatmanual.com>

Golf course search by state

<http://golfingnear.com>

Email search by domain

<http://emailbydomain.com>

Auto manuals search

<http://auto.somanuals.com>

TV manuals search

<http://tv.somanuals.com>