

LC-20B1U

SHARP[®]



ENGLISH

FRANÇAIS

ESPAÑOL

PORTUGUÊS

SHARP[®]

SHARP ELECTRONICS CORPORATION

Sharp Plaza, Mahwah, New Jersey 07430-2135

SHARP CORPORATION

LIQUID CRYSTAL TELEVISION
TÉLÉVISEUR À CRISTAUX
LIQUIDES
TELEVISOR DE CRISTAL
LÍQUIDO
TELEVISOR DE CRISTAL
LÍQUIDO

AQUOS



SHARP[®]

OPERATION MANUAL
MODE D'EMPLOI
MANUAL DE MANEJO
MANUAL DE OPERAÇÃO

Printed on post-consumer recycled paper.
Imprimé sur du papier recyclé.
Impreso en papel reciclado.
Impresso em papel reciclado pós utilização.

Printed in Japan
Imprimé au Japon
Impreso en Japón
Impresso no Japão
TINS-A109WJZZ
02P04-JKK



LC-20B1U



LIQUID CRYSTAL TELEVISION

ENGLISH

OPERATION MANUAL

IMPORTANT INFORMATION

WARNING: TO REDUCE THE RISK OF FIRE OR ELECTRIC SHOCK, DO NOT EXPOSE THIS PRODUCT TO RAIN OR MOISTURE.

	CAUTION RISK OF ELECTRIC SHOCK. DO NOT OPEN.	
<p>CAUTION: TO REDUCE THE RISK OF ELECTRIC SHOCK, DO NOT REMOVE COVER (OR BACK). NO USER-SERVICEABLE PARTS INSIDE. REFER SERVICING TO QUALIFIED SERVICE PERSONNEL.</p>		



The lightning flash with arrow-head symbol, within an equilateral triangle, is intended to alert the user to the presence of uninsulated "dangerous voltage" within the product's enclosure that may be of sufficient magnitude to constitute a risk of electric shock to persons.



The exclamation point within a triangle is intended to alert the user to the presence of important operating and maintenance (servicing) instructions in the literature accompanying the product.

IMPORTANT INFORMATION

WARNING: FCC Regulations state that any unauthorized changes or modifications to this equipment not expressly approved by the manufacturer could void the user's authority to operate this equipment.

U.S.A. ONLY

CAUTION: TO PREVENT ELECTRIC SHOCK, MATCH WIDE BLADE OF PLUG TO WIDE SLOT, FULLY INSERT.

"Note to CATV system installer: This reminder is provided to call the CATV system installer's attention to Article 820-40 of the National Electrical Code that provides guidelines for proper grounding and, in particular, specifies that the cable ground shall be connected to the grounding system of the building, as close to the point of cable entry as practical."

This product utilizes tin-lead solder, and fluorescent lamp containing a small amount of mercury. Disposal of these materials may be regulated due to environmental considerations. For disposal or recycling information, please contact your local authorities or the Electronic Industries Alliance: www.eia.org

IMPORTANT:

To aid reporting in case of loss or theft, please record the TV's model and serial numbers in the space provided. The numbers are located at the rear of the TV.

Model No.:

Serial No.:

U.S.A. ONLY



DEAR SHARP CUSTOMER

Thank you for your purchase of the Sharp LCD Color TV product. To ensure safety and many years of trouble-free operation of your product, please read the Safety Precautions carefully before using this product.

IMPORTANT SAFETY PRECAUTIONS

Electricity is used to perform many useful functions, but it can also cause personal injuries and property damage if improperly handled. This product has been engineered and manufactured with the highest priority on safety. However, improper use can result in electric shock and/or fire. In order to prevent potential danger, please observe the following instructions when installing, operating and cleaning the product. To ensure your safety and prolong the service life of your LCD color TV product, please read the following precautions carefully before using the product.

- Read instructions—All operating instructions must be read and understood before the product is operated.
- Keep this manual in a safe place—These safety and operating instructions must be kept in a safe place for future reference.
- Observe warnings—All warnings on the product and in the instructions must be observed closely.
- Follow instructions—All operating instructions must be followed.
- Attachments—Do not use attachments not recommended by the manufacturer. Use of inadequate attachments can result in accidents.
- Power source—This product must operate on a power source specified on the specification label. If you are not sure of the type of power supply used in your home, consult your dealer or local power company. For units designed to operate on batteries or another power source, refer to the operating instructions.
- Power cord protection—The power cords must be routed properly to prevent people from stepping on them or objects from resting on them. Check the cords at the plugs and product.
- If the AC adapter is misplaced or needs to be replaced, obtain the same type of adapter from a SHARP service center or your dealer.
- Overloading—Do not overload AC outlets or extension cords. Overloading can cause fire or electric shock.
- Entering of objects and liquids—Never insert an object into the product through vents or openings. High voltage flows in the product, and inserting an object can cause electric shock and/or short internal parts. For the same reason, do not spill water or liquid on the product.
- Servicing—Do not attempt to service the product yourself. Removing covers can expose you to high voltage and other dangerous conditions. Request a qualified service person to perform servicing.
- Repair—If any of the following conditions occurs, unplug the power cord from the AC outlet, and request a qualified service person to perform repairs.
 - a. When the power cord or plug is damaged.
 - b. When a liquid was spilled on the product or when objects have fallen into the product.
 - c. When the product has been exposed to rain or water.
 - d. When the product does not operate properly as described in the operating instructions.

Do not touch the controls other than those described in the operating instructions. Improper adjustment of controls not described in the instructions can cause damage, which often requires extensive adjustment work by a qualified technician.
 - e. When the product has been dropped or damaged.
 - f. When the product displays an abnormal condition. Any noticeable abnormality in the product indicates that the product needs servicing.
- Replacement parts—In case the product needs replacement parts, make sure that the service person uses replacement parts specified by the manufacturer, or those with the same characteristics and performance as the original parts. Use of unauthorized parts can result in fire, electric shock and/or other danger.
- Safety checks—Upon completion of service or repair work, request the service technician to perform safety checks to ensure that the product is in proper operating condition.
- Wall or ceiling mounting—When mounting the product on a wall or ceiling, be sure to install the product according to the method recommended by the manufacturer.
- Polarization—This AC adapter may be equipped with a polarized alternating current line plug (a plug having one blade wider than the other). This plug will fit into the power outlet only one way. This is a safety feature. If you are unable to insert the plug fully into the outlet, try reversing the plug. If the plug should still fail to fit, contact your electrician to replace your obsolete outlet. Do not defeat the safety purpose of the polarized plug.



IMPORTANT SAFETY PRECAUTIONS (Continued)

- **Cleaning**—Unplug the power cord from the AC outlet before cleaning the product. Use a damp cloth to clean the product. Do not use liquid cleaners or aerosol cleaners.

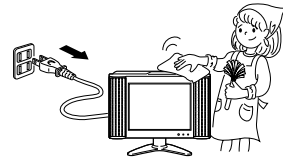

- **Water and moisture**—Do not use the product near water, such as bathtub, washbasin, kitchen sink and laundry tub, swimming pool and in a wet basement.

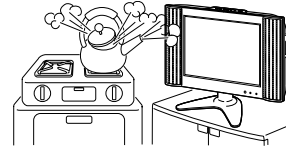

- **Stand**—Do not place the product on an unstable cart, stand, tripod or table. Placing the product on an unstable base can cause the product to fall, resulting in serious personal injuries as well as damage to the product. Use only a cart, stand, tripod, bracket or table recommended by the manufacturer or sold with the product. When mounting the product on a wall, be sure to follow the manufacturer's instructions. Use only the mounting hardware recommended by the manufacturer.



- When relocating the product placed on a cart, it must be moved with utmost care. Sudden stops, excessive force and uneven floor surface can cause the product to fall from the cart.



- **Ventilation**—The vents and other openings in the cabinet are designed for ventilation. Do not cover or block these vents and openings since insufficient ventilation can cause overheating and/or shorten the life of the product. Do not place the product on a bed, sofa, rug or other similar surface, since they can block ventilation openings. This product is not designed for built-in installation; do not place the product in an enclosed place such as a bookcase or rack, unless proper ventilation is provided or the manufacturer's instructions are followed.

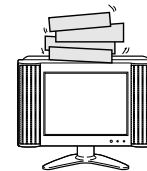

- The LCD panel used in this product is made of glass. Therefore, it can break when the product is dropped or applied with impact. Be careful not to be injured by broken glass pieces in case the LCD panel breaks.

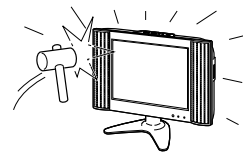

- **Heat sources**—Keep the product away from heat sources such as radiators, heaters, stoves and other heat-generating products (including amplifiers).

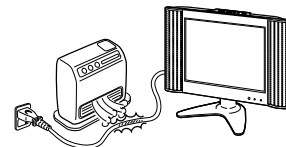

- The LCD panel is a very high technology product with 921,600 thin film transistors, giving you fine picture details. Occasionally, a few non-active pixels may appear on the screen as a fixed point of blue, green or red. Please note that this does not affect the performance of your product.

IMPORTANT SAFETY PRECAUTIONS (Continued)

- If an outside antenna is connected to the television equipment, be sure the antenna system is grounded so as to provide some protection against voltage surges and built-up static charges. Section 810 of the National Electrical Code provides information with respect to proper grounding of the mast and supporting structure, grounding of the lead-in wire to an antenna discharge unit, size of grounding conductors, location of antenna-discharge unit, connection to grounding electrodes, and requirements for the grounding electrode.

EXAMPLE OF ANTENNA GROUNDING AS PER
NATIONAL ELECTRICAL CODE

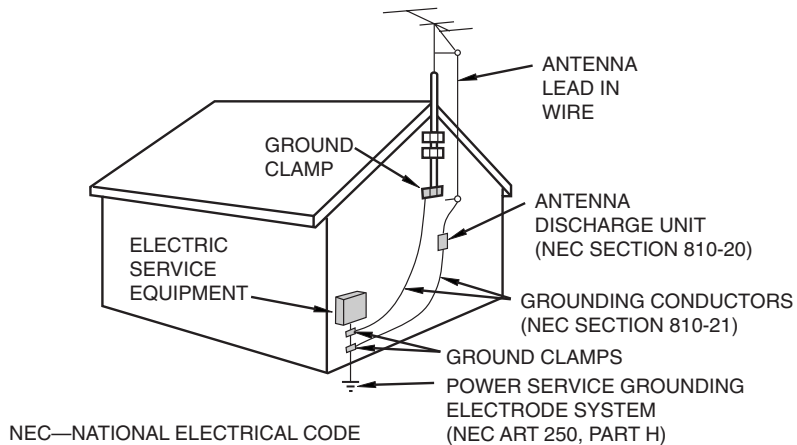

- For added protection for this television equipment during a lightning storm, or when it is left unattended and unused for long periods of time, unplug it from the wall outlet and disconnect the antenna. This will prevent damage to the equipment due to lightning and power-line surges.

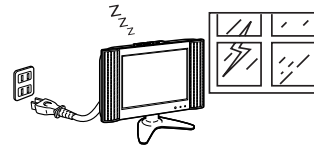

- An outside antenna system should not be located in the vicinity of overhead power lines or other electric light or power circuits, or where it can fall into such power lines or circuits. When installing an outside antenna system, extreme care should be taken to keep from touching such power lines or circuits as contact with them might be fatal.

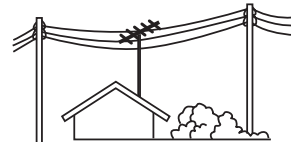







CONTENTS

	Page
DEAR SHARP CUSTOMER	3
IMPORTANT SAFETY PRECAUTIONS	3-5
SUPPLIED ACCESSORIES	7
PREPARATION	8-10
Using the Remote Control	8
Batteries for the Remote Control	8
Power Connection	9
Antenna Connection	9, 10
FRONT AND REAR CONTROL OPTIONS	11-13
Removing the Back Cover	13
Listening with Headphones	13
REMOTE CONTROL	14
BASIC OPERATION	14-17
Turning on POWER	15
Switching TV/VIDEO [AV1/AV2/COMPONENT/CARD/TV] Modes	15
Sound Volume	16
ON/OFF Standby	16
Changing the Channels	17
SELECTING MENU ITEMS	18
ADJUSTMENT	19-35
Adjusting the SLEEP TIMER Settings	19
Adjusting the BRIGHTNESS Settings	20
Adjusting the LANGUAGE Settings	21
Adjusting the VIDEO ADJUST Settings	22, 23
Adjusting the PRESET Settings	24
SET UP	25, 26
Adjusting the BLUE SCREEN Settings	27
Adjusting the CLOSED CAPTION Settings	28
Adjusting the V-CHIP Settings	29-35
MEMORY CARD PLAYBACK	36-41
Memory Cards	36
Card Precautions	37
Preparation	38
Pulling out the memory card	38
Turning on CARD Mode	39
Selecting the Playback Mode	40, 41
CARD ADJUSTMENT	42-47
Selecting CARD SETTING Items	42
Adjusting the SLIDE SHOW Settings	43
Adjusting the MY PROGRAM Settings	44, 45
Adjusting the ROTATE Settings	46
Adjusting the SOUND Settings	47
CONNECTING WITH EXTERNAL DEVICES	48-50
TROUBLESHOOTING	51-53
SPECIFICATIONS	54
DIMENSIONAL DRAWINGS	55

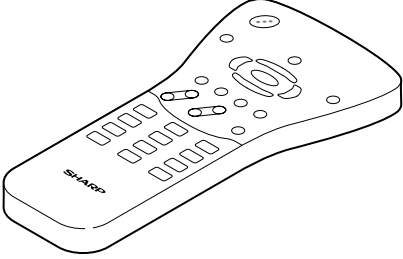
SUPPLIED ACCESSORIES

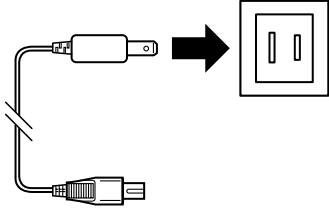
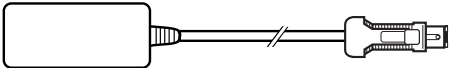
Make sure the following accessories are provided with the product.

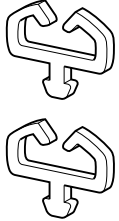
<p>Remote Control</p>  <p>RRMCGA051WJSA</p>	<p>"AAA" size (UM/SUM-4) Dry Battery (×2)</p>  <p>UBATU0038CEZZ</p>	
<p>Antenna Cable</p>  <p>QCNWG0003CEPA</p>	<p>AC Cord</p>  <p>QACCD3097CEPA</p>	
<p>AC Adapter</p>  <p>UADP-0243CEPZ</p>	<p>Operation Manual</p>  <p>TINS-A109WJZZ</p>	<p>Cable Clamp (×2)</p>  <p>LHLDW0109CESA</p>

PREPARATION

Using the Remote Control

- Use the remote control by pointing it towards the remote sensor window. Objects between the remote control and sensor window may prevent proper operation.

Cautions regarding use of remote control

- Do not expose the remote control to shock. In addition, do not expose the remote control to liquids, and do not place in an area with high humidity.
- Do not install or place the remote control under direct sunlight. The heat may cause deformation of the unit.
- The remote control may not work properly if the remote sensor window of the main unit is under direct sunlight or strong lighting. In such a case, change the angle of the lighting or LCD TV set, or operate the remote control closer to the remote sensor window.

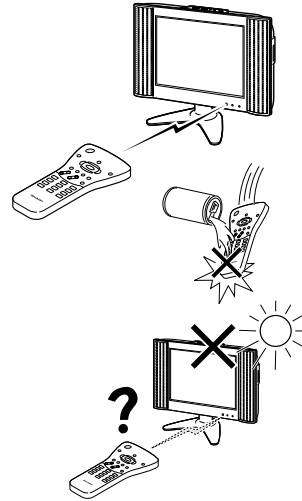

Batteries for the Remote Control

If the remote control fails to operate the LCD color TV functions, replace the batteries in the remote control.

- 1** Open the battery cover.

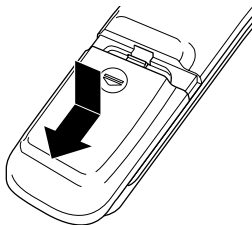

- Slide the cover while pressing down.

- 2** Insert batteries (two "AAA" (UM/SUM-4) size batteries, supplied with product).

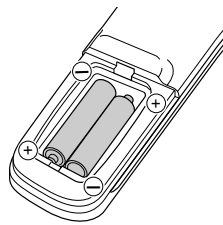

- Place the batteries with their terminals corresponding to the (+) and (-) indications in the battery compartment.

- 3** Close the battery cover.

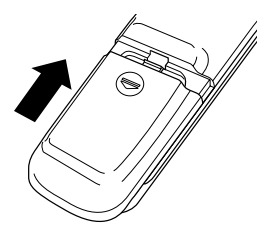

⚠ Caution!

Cautions regarding batteries

Improper use of batteries can result in a leakage of chemicals and/or explosion. Be sure to follow the instructions below.

- Place batteries with their terminals corresponding to the (+) and (-) indications.
- Different types of batteries have different characteristics. Do not mix batteries of different types.
- Do not mix old and new batteries. Mixing old and new batteries can shorten the life of new batteries and/or cause old batteries to leak chemicals.
- Remove batteries when they become weak. Chemicals that leak from batteries can cause a rash. If chemical leakage is found, wipe with a cloth.
- The batteries supplied with the product may have a shorter life expectancy due to storage conditions.
- If the remote control is not used for an extended period of time, remove the batteries from the remote control.

PREPARATION (Continued)

Power Connection

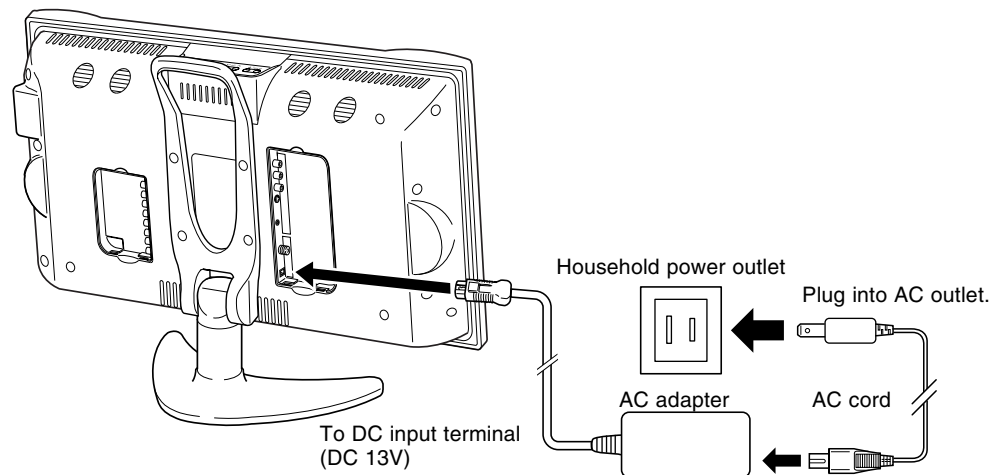

Note

- Use a commercially available AC plug adapter, if necessary, depending on the design of the wall outlet.
- Always turn the main **POWER** switch of the LCD TV set to off when connecting the AC adapter.
- Always unplug the AC adapter from the product and power outlet when not using for a long period of time.

Antenna Connection

CABLE TV (CATV) CONNECTION

- A 75-ohm coaxial cable connector is built into the set for easy hookup. When connecting the 75-ohm coaxial cable to the set, screw the 75-ohm cable to the ANT. terminal.
- Some cable TV companies offer "premium pay channels". Since the signals of these premium pay channels are scrambled, a cable TV converter/descrambler is generally provided to the subscriber by the cable TV company. This converter/descrambler is necessary for normal viewing of the scrambled channels. (Set your TV to channel 3 or 4, typically one of these channels is used. If this is unknown, consult your cable TV company.) For more specific instructions on installing cable TV, consult your cable TV company. One possible method of utilizing the converter/descrambler provided by your cable TV company is explained below.

Please note: An RF switch provided with two inputs (A and B) is required (not supplied).

"A" position on the RF switch (not supplied) : You can view all unscrambled channels by using the TV's channel keys.

"B" position on the RF switch (not supplied) : You can view the scrambled channels via the converter/descrambler by using the converter's channel keys.

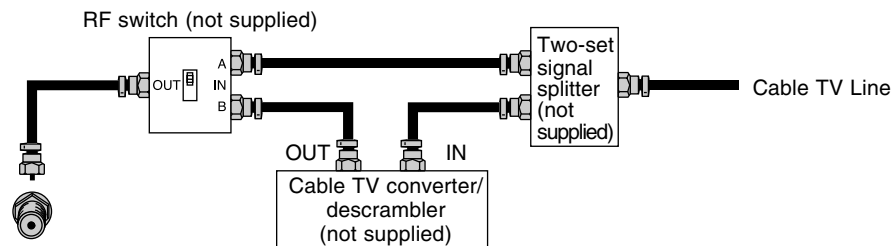

Note

- Consult your SHARP Dealer or Service Center for the type of splitter, RF switch or combiner that might be required.

PREPARATION (Continued)

Antenna Connection (Continued)

ANTENNAS

- The antenna requirements for good color television reception are more important than those for black & white television reception. For this reason, a good quality outdoor antenna is strongly recommended. The following is a brief explanation of the type of connections that are provided with the various antenna systems.

1. A 75-ohm system is generally a round cable with F-type connector that can easily be attached to a terminal without tools (not supplied).

F-type connector

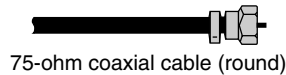

75-ohm coaxial cable (round)

2. A 300-ohm system is a flat "twin-lead" cable that can be attached to a 75-ohm terminal through a 300-75-ohm adapter (not supplied).



300-ohm twin-lead cable (flat)

OUTDOOR ANTENNA CONNECTION

- Use one of the following two diagrams if you connect an outdoor antenna.
 - A: Using a VHF/UHF combination outdoor antenna.
 - B: Using separate VHF and/or UHF outdoor antennas.
- Connect the outdoor antenna cable lead-in to the ANT. terminal on the rear of the TV set.

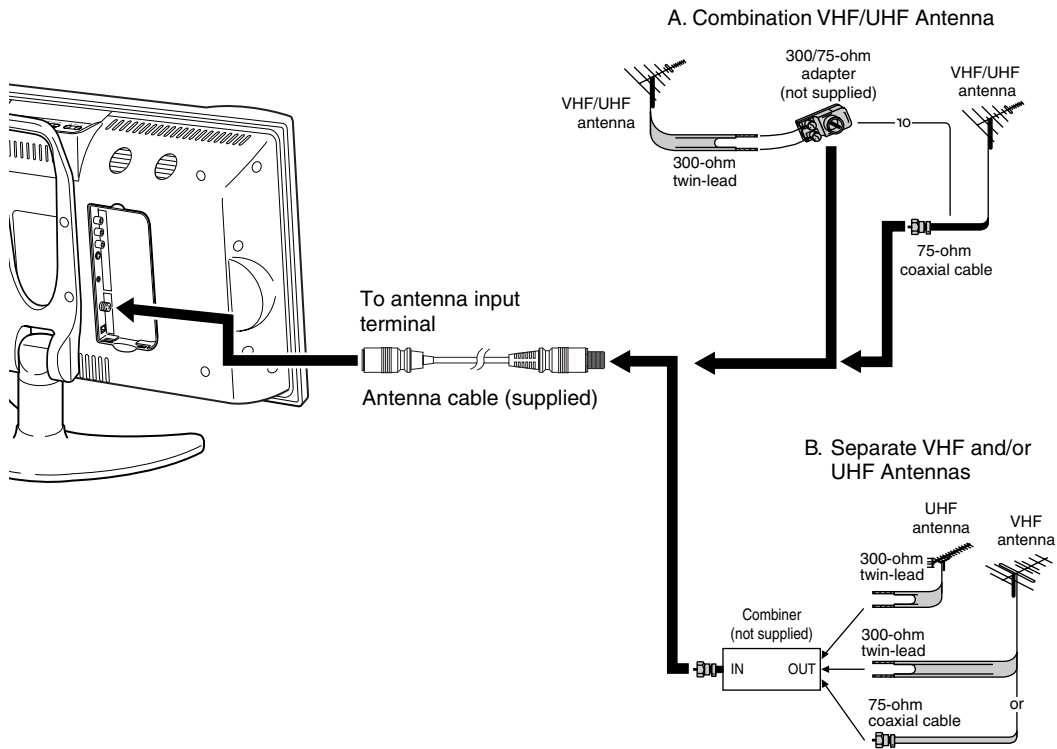

FRONT AND REAR CONTROL OPTIONS

Main unit (front view)

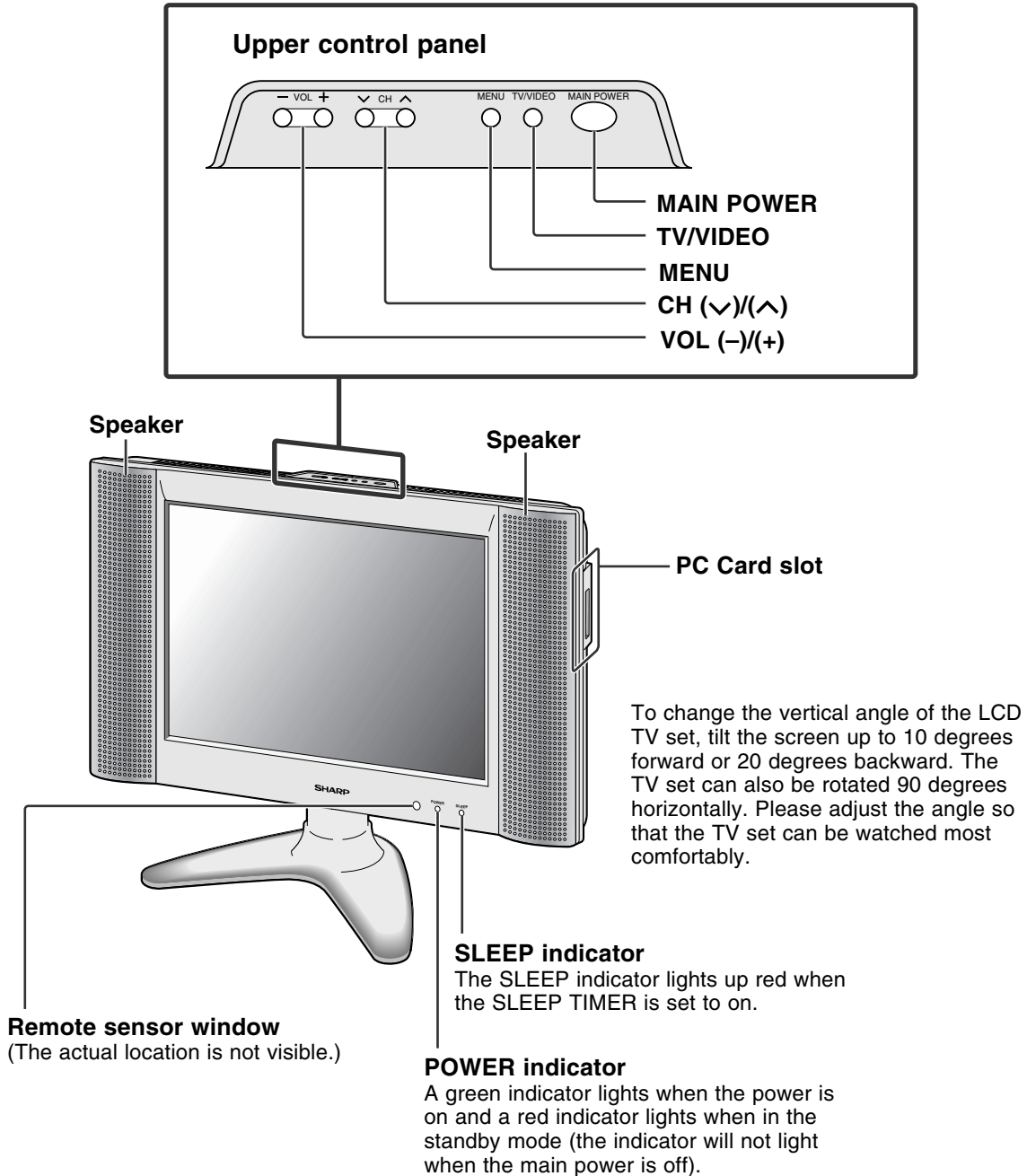

Note

- **TV/VIDEO**, **CH (∨)/(∧)**, **VOL (-)/(+)**, and **MENU** on the main unit have the same functions as the same buttons on the remote control. Fundamentally, this operation manual provides a description based on operation with the remote control.



FRONT AND REAR CONTROL OPTIONS (Continued)

Main unit (rear view)

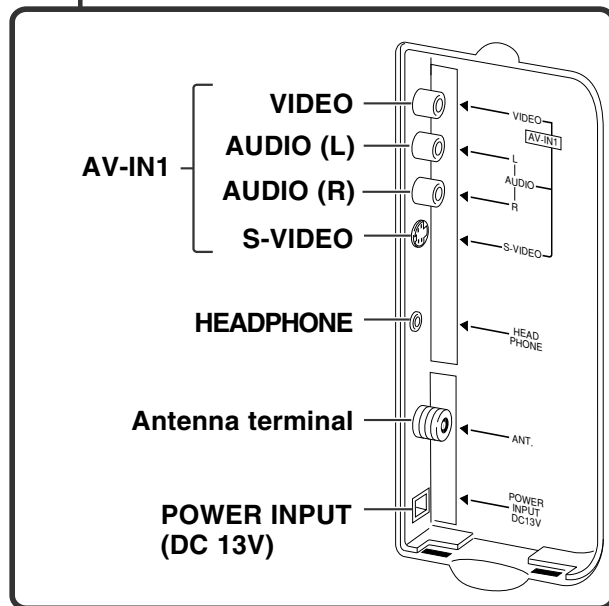
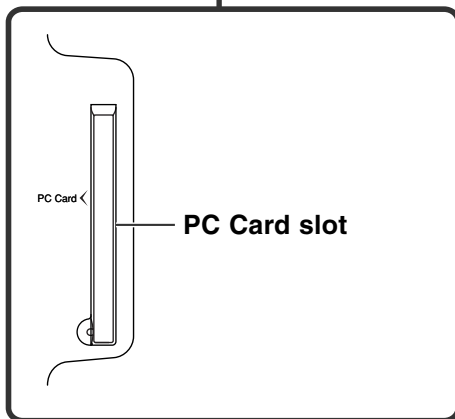
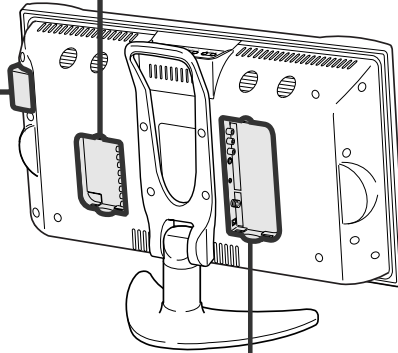
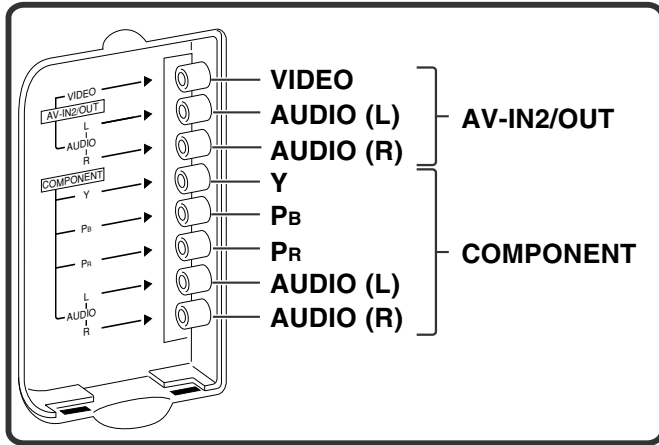



FRONT AND REAR CONTROL OPTIONS (Continued)

Removing the Back Cover

- Before connecting a connection cord into the rear terminal, remove the back cover. Push in the tab and pull out the back cover carefully.
- To mount the cover, insert the 2 hooks on the bottom of the cover into the cabinet and press on the upper part of the back cover until the tab locks in place with a click.

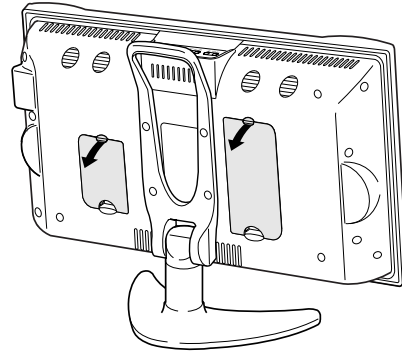

Listening with Headphones

- Plug the headphone mini-plug into the HEADPHONE jack located on the rear of the TV set.

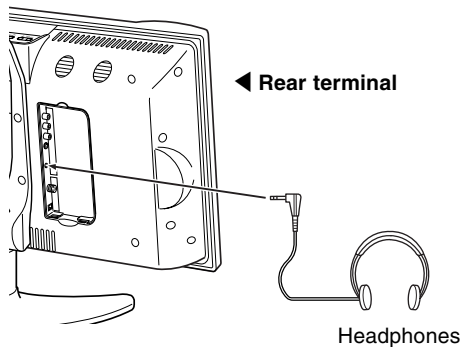

▼ On-screen display

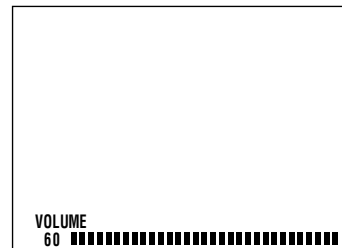

Note

- Headphones are not included in the supplied accessories.
- No sound will be heard from the main unit speakers when a headphone mini-plug is connected into the HEADPHONE jack.

REMOTE CONTROL

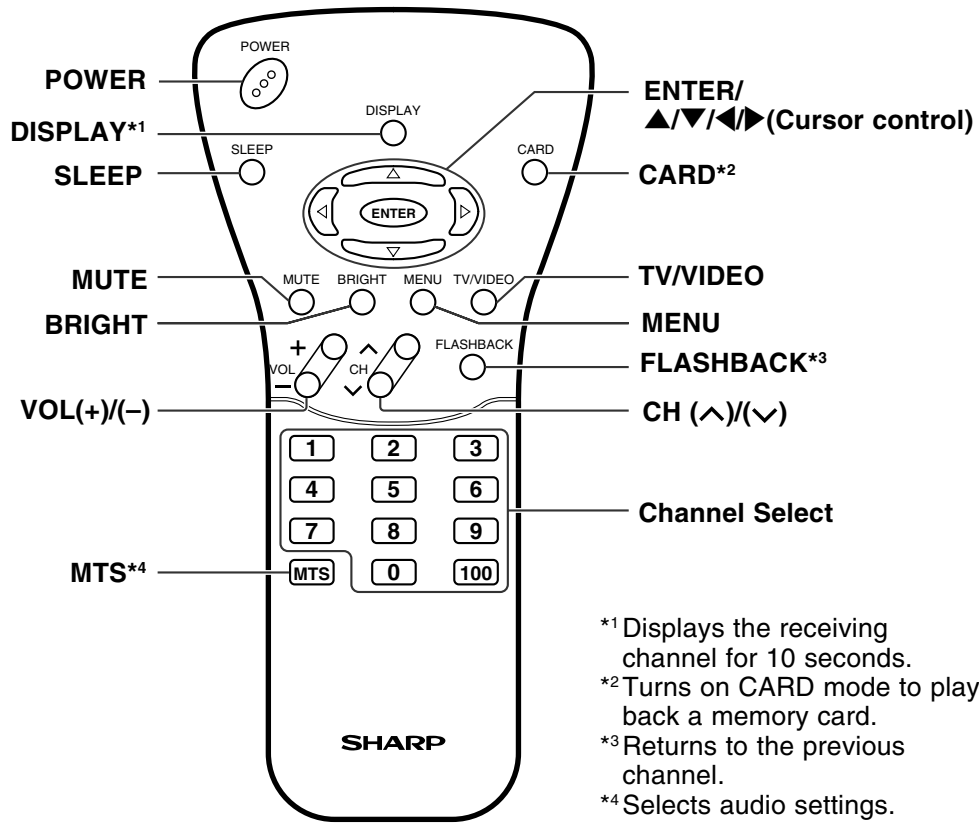

BASIC OPERATION

This product is factory set to comply with the TV broadcasting system in the United States. For Brazil, Argentina and Uruguay, set the color system according to the country before using this product by following the table below.

Country	TV broadcasting system	Factory setting of color system		User setting
		TV	Video	TV/Video
U.S.A.	Color: NTSC TV ch: US ch	NTSC (N358) US ch	NTSC (N358) US ch	Not required or N/A
Canada, Mexico, Latin America	Color: NTSC TV ch: US ch	NTSC (N358) US ch	NTSC (N358) US ch	Not required or N/A
Brazil	Color: PAL-M TV ch: US ch	NTSC (N358) US ch	NTSC (N358) US ch	Set color system to PAL-M (see page 23)
Argentina, Uruguay	Color: PAL-N TV ch: US ch	NTSC (N358) US ch	NTSC (N358) US ch	Set color system to PAL-N (see page 23)

Note

- The 3 Dimensional Y/C separation circuit* only works when the color system is set to N358 in TV mode and Video mode.
- *The 3 Dimensional Y/C separation circuit is used to remove flickering and color bleeding.

BASIC OPERATION (Continued)

Turning on POWER



- 1 Press **MAIN POWER**, located on the upper side of the main unit, to on.
- 2 The **POWER** indicator instantaneously changes from red to green and the main unit is turned on.

Note

- The input mode indication disappears after several seconds.

▼ **On-screen display**

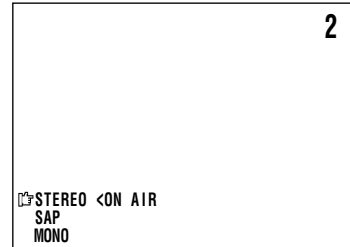

Switching TV/VIDEO [AV1/AV2/COMPONENT/CARD/TV] Modes

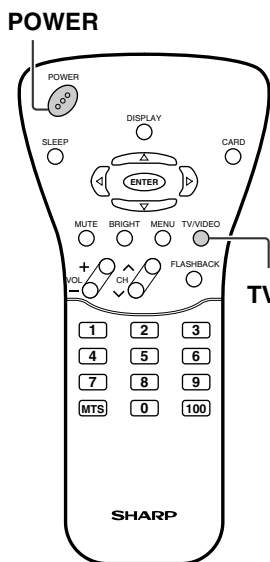

- 1 Turn on the power of the connected video equipment.
- 2 Press **TV/VIDEO** and select the applicable input source. The screen displays AV1, AV2, COMPONENT, CARD or TV mode each time **TV/VIDEO** is pressed.

Note

- The AV input mode indication remains for 3 seconds.
- AV1: Video equipment connected to the AV1 input terminals. An S-Video input terminal is additionally provided for the AV1 input. If both the S-Video terminal and normal video terminals are connected with cables, the S-Video input terminal takes priority.
- AV2: AV2 mode is used to adjust the preset settings and IN or OUT can be selected. AV2 indication is not displayed when OUT is selected. (For details on setting AV-OUT, see page 24.)
- COMPONENT: Video equipment connected to the COMPONENT input terminals.
- CARD: Switches to CARD mode. (For details on CARD mode, see pages 36-47.)

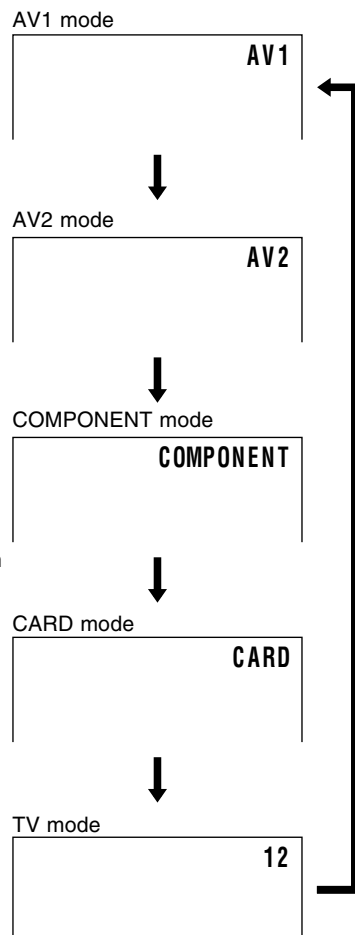

BASIC OPERATION (Continued)

Sound Volume

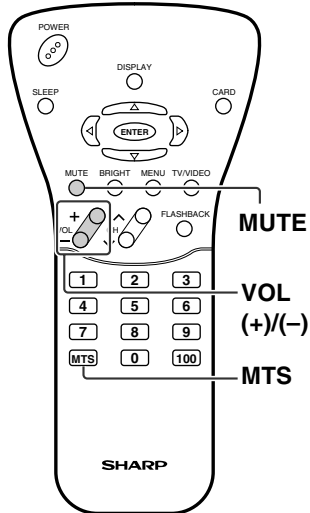

1 Press **VOL (+)** to increase the sound volume. The segment of the indicator increases.



2 Press **VOL (-)** to decrease the sound volume. The segment of the indicator decreases.



To mute the sound

1 Press **MUTE** to temporarily turn off the sound. The MUTE mark is displayed for 4 seconds.



2 Press **MUTE** or **VOL (+)/(-)** to turn the sound back to the previous level. The mute function is automatically turned off when any of the following buttons are pressed: **POWER**, **VOL (+)/(-)**, or **MTS**.

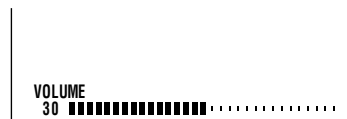

To select MTS (Multi ch TV Sound)

- Press **MTS** to display the **MTS** screen.
- Press **MTS** to select the **MTS** settings.
 [STEREO]: stereo audio
 [SAP]: second audio program
 [MONO]: monophonic audio

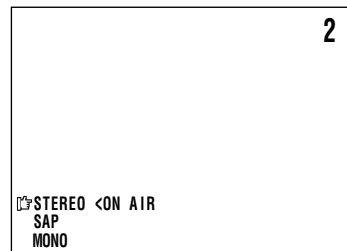

Note

- <ON AIR appears when a stereo or SAP broadcast is being aired.

ON/OFF Standby

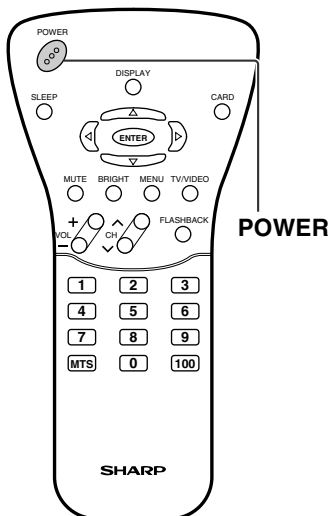

To turn off the LCD TV

Press **POWER** on the remote control. The **POWER** indicator will turn red.

To turn the LCD TV back on

Press **POWER** again. The **POWER** indicator will turn green.

BASIC OPERATION (Continued)

Changing the Channels

Changing channels by using **Channel Select** on the remote control

- This LCD TV set allows you to select up to 125 channels (1 to 125). To select a channel, enter a 2- or 3-digit number.

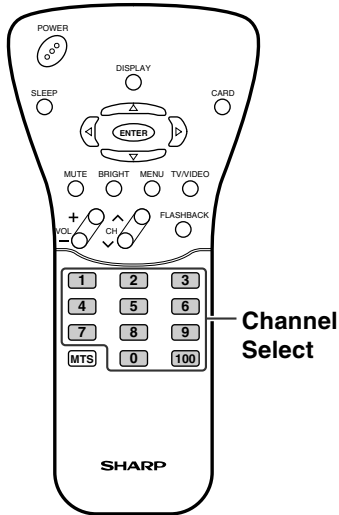

To select a 1- or 2-digit channel number (e.g., Channel 5):
Complete the following procedure within 4 seconds.

- 1 Press the **0** button.
- 2 Press the **5** button.

Note

- When selecting a 1-digit channel number, do not fail to press the **0** button first.

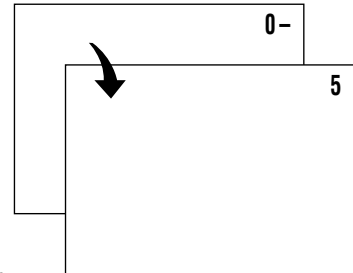

To select a 3-digit channel number (e.g., Channel 115):
Complete the following procedure within 4 seconds.

- 1 Press the **100** button.
- 2 Press the **0** button.
- 3 Press the **5** button.

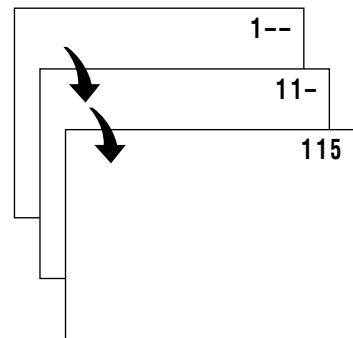

Changing channels with CH (^)/(v) on the remote control

Air Press **CH (^)** and the channels change in the order shown below:

2 → 3 → ... → 68 → 69 → 2 → 3 → ...

Press **CH (v)** and the channels change in the order shown below:

3 → 2 → 69 → 68 → ... → 3 → 2 → ...

Cable Press **CH (^)** and the channels change in the order shown below:

1 → 2 → 3 → ... → 125 → 1 → 2 → 3 → ...

Press **CH (v)** and the channels change in the order shown below:

3 → 2 → 1 → 125 → ... → 3 → 2 → 1 → ...

SELECTING MENU ITEMS

Selecting Menu Items

- This LCD TV set allows you to adjust the various settings using the menu screen. Select the desired menu item by following the steps below and then refer to the indicated page for details.

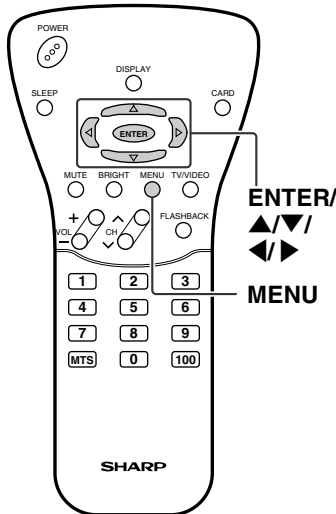

- 1 Press **MENU** to display the MENU screen.
- 2 Press **▲/▼** to select the desired menu item, and press **ENTER**.
- 3 Press **MENU** to exit.

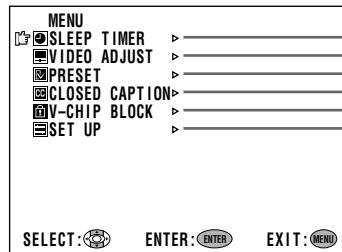

Note

- There are two sets of items displayed on the MENU screen depending on whether TV/VIDEO or CARD mode is selected. To display the MENU screen for CARD mode, press CARD to turn on CARD mode and then press MENU to display the MENU screen.
- The TINT display only appears when the color system is set to N358 or N443.
- The displayed items differ depending on the setting conditions.
- The selected item changes to yellow.
- Items in magenta cannot be selected.
- This product is factory set to comply with the color system in the United States (NTSC-N358). For Brazil (PAL-M), Argentina (PAL-N) and Uruguay (PAL-N), set the color system before using this product.
- To return to the previous screen, select RETURN.
- You can adjust some settings with the special buttons: SLEEP and BRIGHT (see page 19 and page 20).

(Page 19)

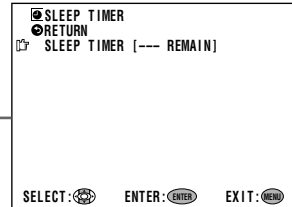

(Pages 22, 23)

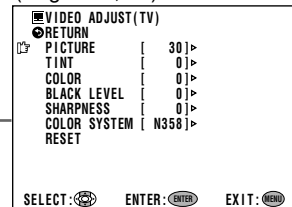

(Pages 20, 24)

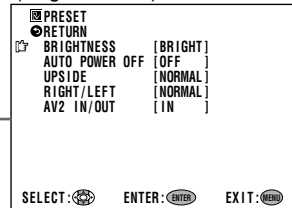

(Page 28)

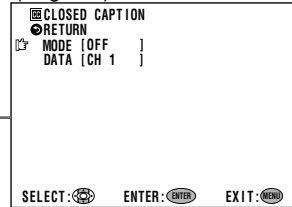

(Pages 31-35)

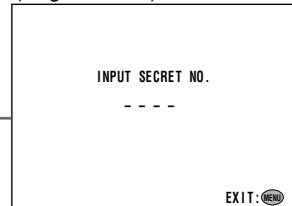

(Pages 21, 25-27)

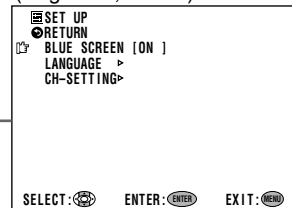

* The screen indications shown above are larger than actual for easy reading.

ADJUSTMENT

Adjusting the SLEEP TIMER Settings

You can set the SLEEP TIMER to automatically turn off the TV.

SLEEP

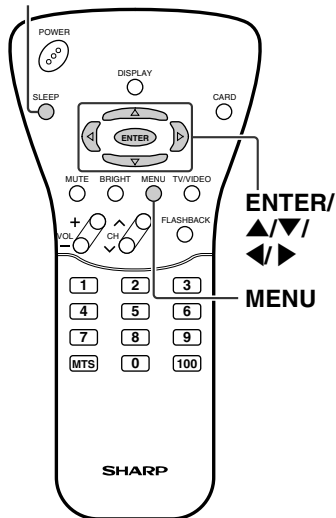

Directly setting the SLEEP TIMER

- 1 Press **SLEEP** to display the SLEEP TIMER screen.
- 2 Press **SLEEP** to set the sleep timer (in minutes).

The time can be set in increments of 30 minutes and in the range between 30 and 120 minutes.

The SLEEP TIMER is turned off when --- is displayed.

Note

- The SLEEP TIMER screen automatically disappears in 3 seconds.



Setting the SLEEP TIMER on the MENU screen

- 1 Press **MENU** to display the MENU screen.
- 2 Press **▲/▼** to move the cursor to SLEEP TIMER.

- 3 Press **ENTER** to display the SLEEP TIMER screen, and press **ENTER**.

- 4 Press **◀▶** to set the sleep timer (in minutes) and press **ENTER**.

The time can be set in increments of 30 minutes and in the range between 30 and 120 minutes.

The SLEEP TIMER is turned off when --- is displayed.

- 5 Press **MENU** to return to the main screen.

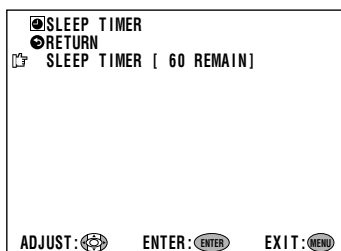
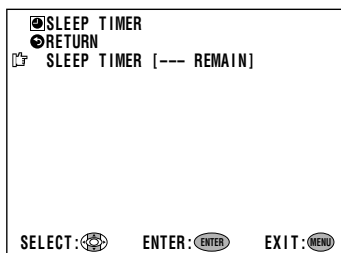
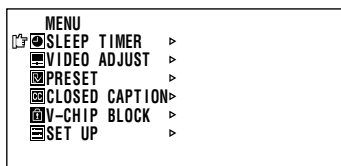

Note

- When you set the SLEEP TIMER, the SLEEP indicator lights.
- After you set the SLEEP TIMER, if you turn off the **MAIN POWER** on the TV set or press the **POWER** button on the remote control, the SLEEP TIMER setting is cancelled and the SLEEP indicator goes out.
- 5 minutes before the SLEEP TIMER turns off the TV, 5 REMAIN is displayed on the screen for 4 seconds. The SLEEP TIMER counts down and shows a similar 4-second display for each remaining minute until the timer turns off the TV.

ADJUSTMENT (Continued)

Adjusting the BRIGHTNESS Settings

You can set the brightness of the screen.

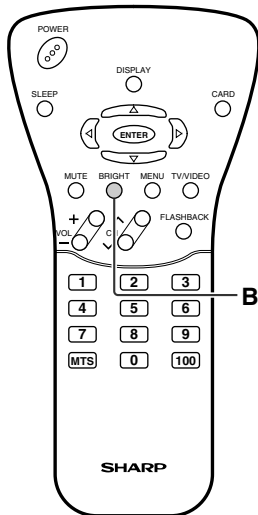

BRIGHT

Directly setting the BRIGHTNESS

- 1 Press **BRIGHT** to display the BRIGHTNESS screen.
- 2 Press **BRIGHT** to change the setting.



Note

- The BRIGHTNESS screen automatically disappears in 3 seconds.
- [BRIGHT]: maximum brightness
- [NORMAL]: 60% brightness (suitable for viewing in a well-lit area and saves energy)
- [DARK]: 20% brightness (sufficiently bright when viewing in a dimly lit area)

Setting the BRIGHTNESS on the MENU screen

- 1 Press **MENU** to display the MENU screen.
- 2 Press **▲/▼** to move the cursor to PRESET, and press **ENTER**.
- 3 Press **▲/▼** to move the cursor to BRIGHTNESS, and press **ENTER**.

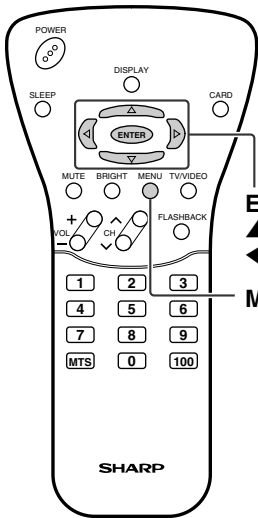

ENTER/▲/▼/◀/▶
MENU

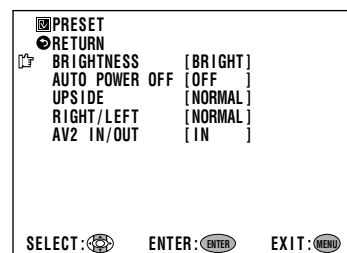
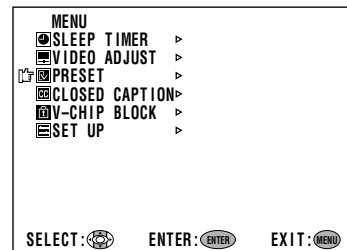

- 4 Press **◀/▶** to change the setting, and press **ENTER**.
- 5 Press **MENU** to return to the main screen.

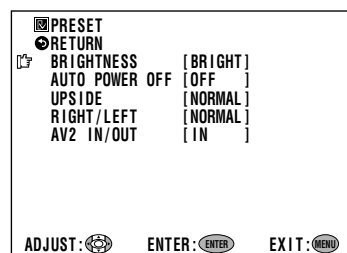



ADJUSTMENT (Continued)

Adjusting the LANGUAGE Settings

The language for the On-Screen Display can be ENGLISH, SPANISH or FRENCH.

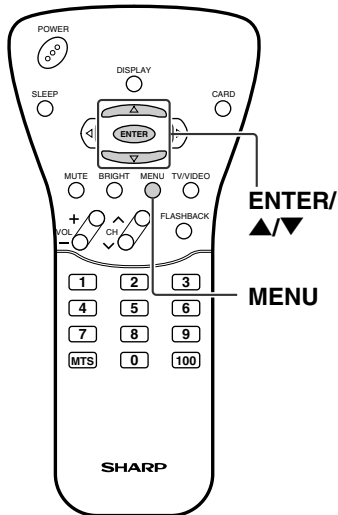

- 1 Press **MENU** to display the MENU screen.

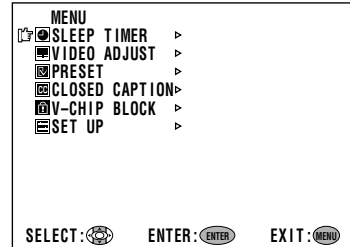

- 2 Press ▲/▼ to move the cursor to SET UP, and press **ENTER**.

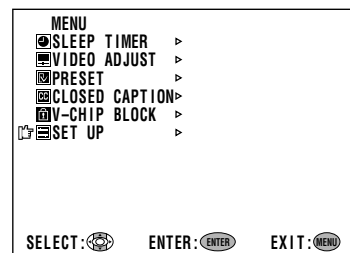

- 3 Press ▲/▼ to move the cursor to LANGUAGE, and press **ENTER**.

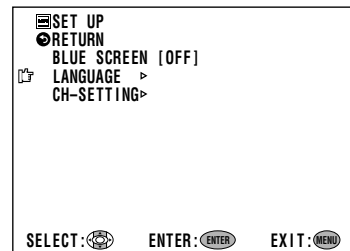

- 4 Press ▲/▼ to select the language.

- 5 Press **MENU** to return to the main screen.



ADJUSTMENT (Continued)

Adjusting the VIDEO ADJUST Settings

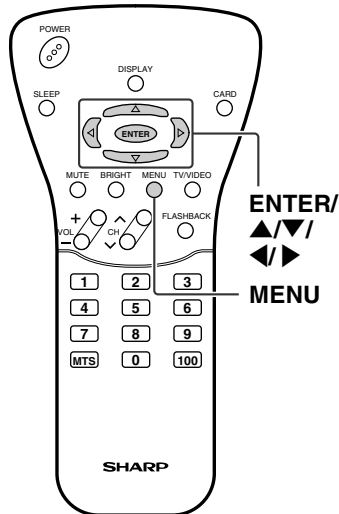

1 Press **MENU** to display the MENU screen.

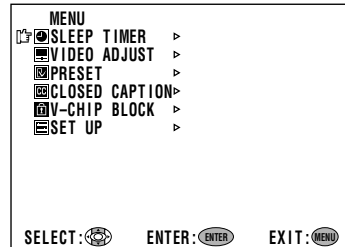

2 Press ▲/▼ to move the cursor to VIDEO ADJUST, and press ENTER.

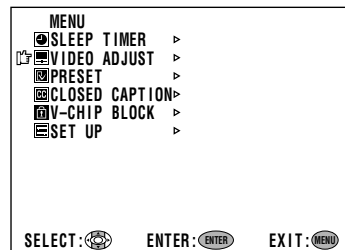

3 Press ▲/▼ to move the cursor to the desired item, and press ENTER.

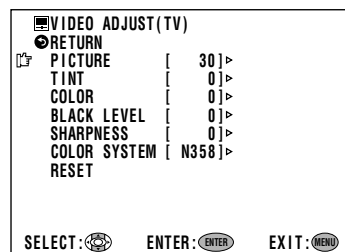

4 Press ◀▶ to change the setting.

Note

- See page 23 for the settings.

5 Press **MENU** to return to the main screen.

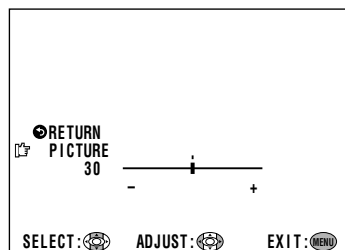









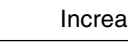
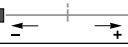
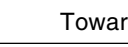

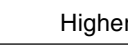

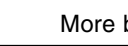

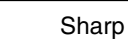

ADJUSTMENT (Continued)

Adjusting the VIDEO ADJUST Settings (Continued)

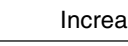
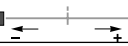
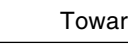
TV mode

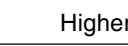
Selected item	Press ◀.	Press ▶.
PICTURE	Decrease contrast 	Increase contrast 
TINT	Toward purple 	Toward green 
COLOR	Lower color intensity 	Higher color intensity 
BLACK LEVEL	Less bright 	More bright 
SHARPNESS	Soft picture 	Sharp picture 
COLOR SYSTEM	◁ N358 ↔ PAL-M ↔ PAL-N ▷	

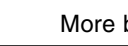
AV mode

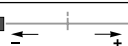
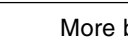
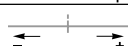
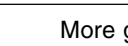
Selected item	Press ◀.	Press ▶.
PICTURE	Decrease contrast 	Increase contrast 
TINT	Toward purple 	Toward green 
COLOR	Lower color intensity 	Higher color intensity 
BLACK LEVEL	Less bright 	More bright 
SHARPNESS	Soft picture 	Hard picture 
RED-BLUE	More red level 	More blue level 
GREEN	Less green level 	More green level 
COLOR SYSTEM	Press ◀/▶ to select the COLOR SYSTEM. ▷ N358 ↔ N443 ↔ PAL ↔ PAL-M ↔ PAL-N ↔ SECAM ↔ PAL60 ◁ ■ When the COMPONENT mode is selected ▷ NTSC ↔ PAL ◁	

Note

- TINT is displayed only when N358 or N443 is selected.
- In BLUE SCREEN, PICTURE setting displayed in magenta cannot be selected.
- Selecting RESET will return all settings to the factory settings.
- This product is factory set to comply with the color system in the United States (NTSC-N358). For Brazil (PAL-M), Argentina (PAL-N) or Uruguay (PAL-N), adjust the color system before using this product.

CARD mode

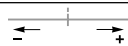
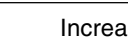
Selected item	Press ◀.	Press ▶.
PICTURE	Decrease contrast 	Increase contrast 
COLOR SYSTEM	The COLOR SYSTEM is always set to N358 and cannot be changed.	

Note

- It is possible to select PICTURE, RESET, and RETURN on the VIDEO ADJUST screen for CARD mode. All other items cannot be selected.



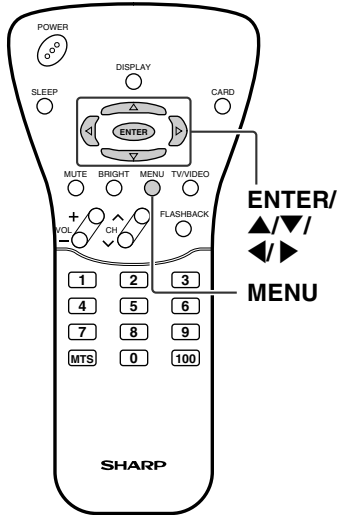

ADJUSTMENT (Continued)

Adjusting the PRESET Settings

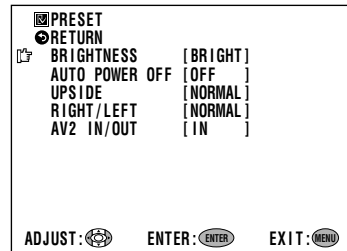
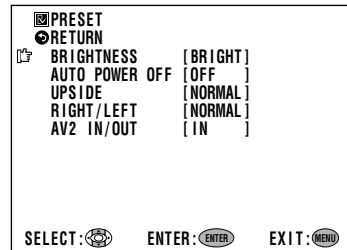
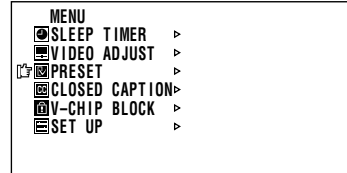

- 1 Press **MENU** to display the MENU screen.
- 2 Press **▲/▼** to move the cursor to PRESET, and press **ENTER**.
- 3 Press **▲/▼** to move the cursor to the desired item, and press **ENTER**.
- 4 Press **◀▶** to change the setting, and press **ENTER**.
- 5 Press **MENU** to return to the main screen.



Selected item	Factory setting	Setting change
BRIGHTNESS	[BRIGHT] Maximum brightness	[NORMAL] Brightness 60% → Suitable for viewing in a well-lit area. Saves energy. [DARK] Brightness 20% → Sufficiently bright when viewing in a dimly lit area.
AUTO POWER OFF (only TV mode)	[OFF]	[ON] The power of the LCD TV set is turned off when there is no signal for 5 minutes. [OFF] This feature is inactive.
UPSIDE	[NORMAL] Normal vertical image orientation	[DOWN] Inverted image → To display images upside down for special uses. 
RIGHT/LEFT	[NORMAL] Normal horizontal image orientation	[MIRROR] Mirror image → To display mirror images for special uses. 
AV2 IN/OUT	[IN]	[OUT ] Line Output is selected, Output volume is fixed, Speaker output is available. [OUT ] Line Output is selected, Output volume is variable, Speaker output is Mute.

Note

- When OUT has been selected as the AV2 IN/OUT setting, it is not possible to set AV2 to ON in SOUND SETTING for CARD mode. In order to set AV2 to ON, select IN as the AV2 IN/OUT setting.



ADJUSTMENT (Continued)

SET UP

■ CHANNEL SETTING

It is necessary to set the receiving mode to AIR or CABLE channels to receive locally broadcast TV programs.

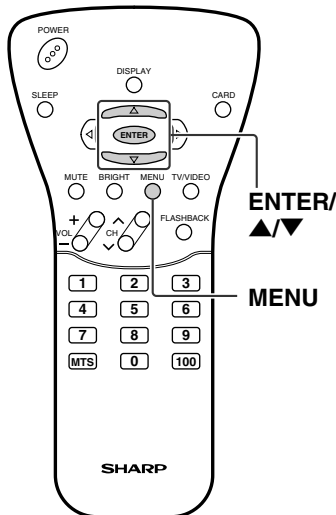

1 Press **MENU** to display the MENU screen.

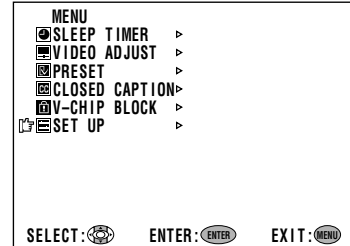

2 Press **▲/▼** to move the cursor to SET UP, and press **ENTER**.

3 Press **▲/▼** to move the cursor to CH-SETTING, and press **ENTER**.

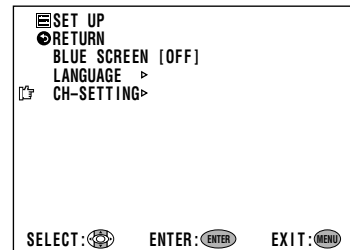

4 Press **▲/▼** to move the cursor to AIR/CABLE, and press **ENTER**.

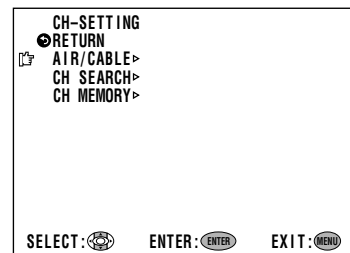

5 Press **▲/▼** to move the cursor to the desired mode.

6 Press **MENU** to return to the main screen.

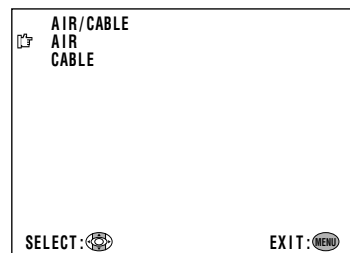

Note

- Receivable channels of your TV set are:
AIR channels:
VHF: 2 through 13.
UHF: 14 through 69.

- CABLE channels:
1 (HRC and IRC mode only)
2 through 125 (STD, HRC and IRC)



ADJUSTMENT (Continued)

SET UP (Continued)

■ Saving broadcast TV channels in the memory

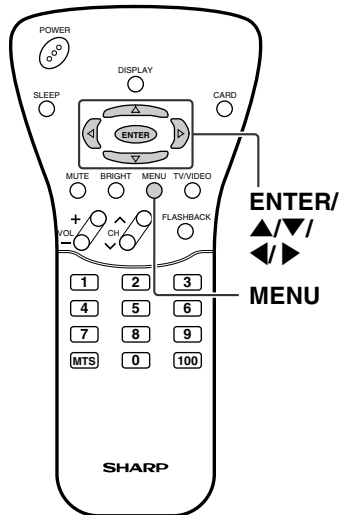

- 1 Press **MENU** to display the MENU screen, press **▲/▼** to move the cursor to SET UP, and press **ENTER**.
- 2 Press **▲/▼** to move the cursor to CH-SETTING, and press **ENTER**.
- 3 Press **▲/▼** to move the cursor to CH SEARCH, and press **ENTER**.
- 4 Press **▶**. The tuner will search through all available channels in your area and add them to the TV's memory.

Note

- To interrupt CH SEARCH, press **◀**. CH SEARCH will stop at the current channel and will not add any higher channels.

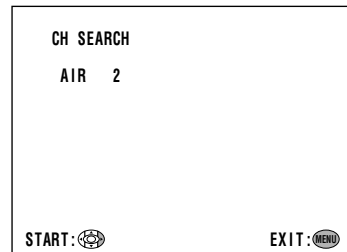
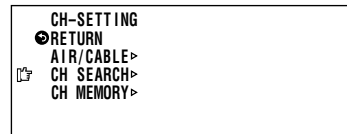

- 5 Press **MENU** to exit.

■ Adding weak or additional channels or erasing unwanted channels from TV memory

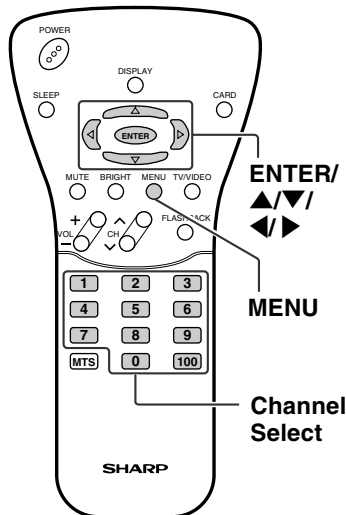

- 1 Press **MENU** to display the MENU screen, press **▲/▼** to move the cursor to SET UP, and press **ENTER**.
- 2 Press **▲/▼** to move the cursor to CH-SETTING, and press **ENTER**.
- 3 Press **▲/▼** to move the cursor to CH MEMORY, and press **ENTER**.
- 4 Use **▲/▼** or **Channel Select** to select each desired channel to add or erase.
- 5 Press **▶** to add the channel to the TV's memory or press **◀** to erase the channel from the TV's memory.
- 6 Press **MENU** to exit.

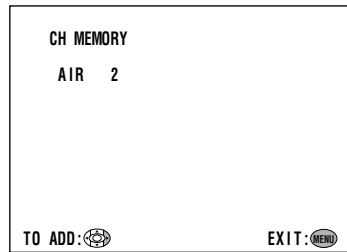
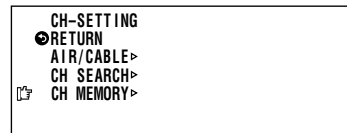

▶ to add channel 2 to the TV memory
 ◀ to erase channel 2 to the TV memory

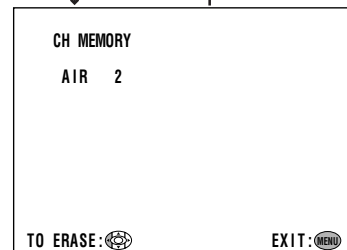

Note

- If CH SEARCH is performed again, the previously memorized channels will be lost.

ADJUSTMENT (Continued)

Adjusting the BLUE SCREEN Settings

■ BLUE SCREEN

Automatically turns the screen blue if a broadcast signal is not received.

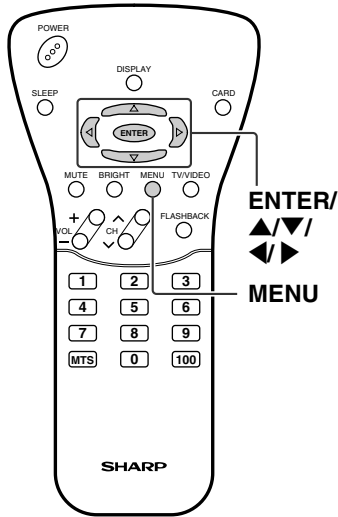

1 Press **MENU** to display the MENU screen.

2 Press **▲/▼** to move the cursor to SET UP, and press **ENTER**.

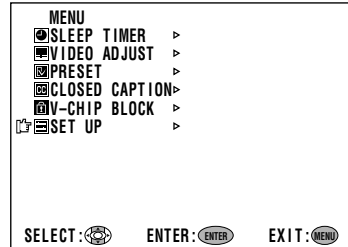

3 Press **▲/▼** to move the cursor to BLUE SCREEN, and press **ENTER**.

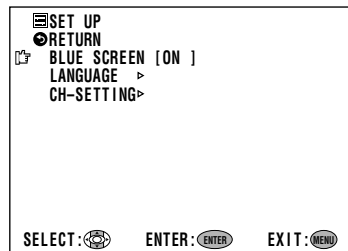

4 Press **◀▶** to select ON or OFF, and press **ENTER**.

5 Press **MENU** to return to the main screen.

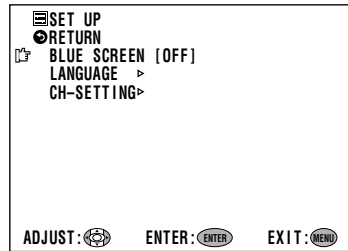

Note

- When received signals are weak or interfered with by some other signals, the BLUE SCREEN function may be activated. To watch the TV under such conditions, set BLUE SCREEN to OFF.
- When the AV-IN1, AV-IN2 or COMPONENT input mode is selected, if no signal is being input, the BLUE SCREEN function is activated.
- The BLUE SCREEN function is inactive in CARD mode.

ADJUSTMENT (Continued)

Adjusting the CLOSED CAPTION Settings

■ SETTING CLOSED CAPTION

- This TV set is equipped with an internal Closed Caption decoder. "Closed Caption" is a system which allows conversations, narration, and sound effects in TV programs and home videos to be viewed as captions on the TV screen (see the illustration).
- Not all the programs and videos will offer closed captioning. Please look for the "CC" symbol to ensure that captions will be shown.
- The Closed Caption broadcasts can be viewed in two modes: [CAPTION] and [TEXT]. For each mode, two channels are available: CH1 and CH2. The [CAPTION] mode shows subtitles of dialogs and commentaries of TV dramas and news programs while allowing a clear view of the picture. The [TEXT] mode displays various information over the picture (such as TV program schedules and weather forecasts, etc.) that is independent of the TV programs.

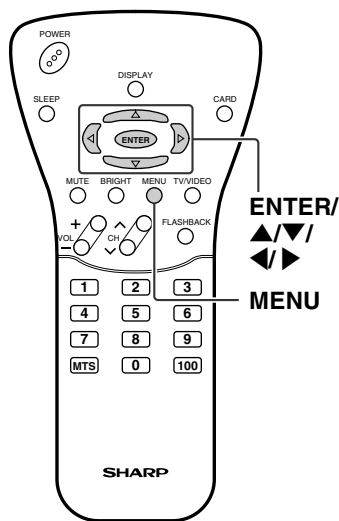

1 Press **MENU** to display the MENU screen.

2 Press **▲/▼** to move the cursor to **CLOSED CAPTION**, and press **ENTER**.

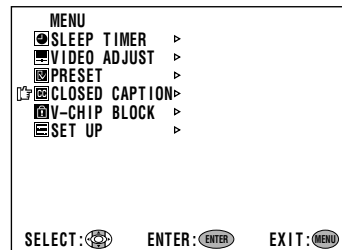

3 Press **▲/▼** to move the cursor to **MODE** or **DATA**, and press **ENTER**.

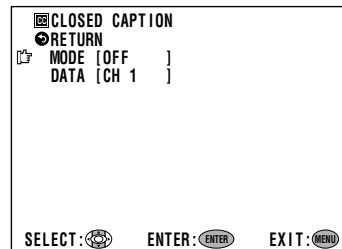

4 Press **◀/▶** to change the **CLOSED CAPTION** setting, and press **ENTER**.

5 Press **MENU** to return to the main screen.

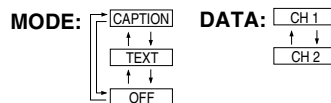
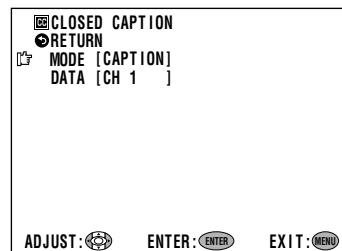

Note

- If a broadcast has **CLOSED CAPTION** and **MUTE** is pressed, the set enters [CAPTION] mode automatically. Pressing **MUTE** again will return the set to its previous condition.
- Closed Caption may malfunction (white blocks, strange characters, etc.) if signal conditions are poor or if there are problems at the broadcast source. This does not necessarily indicate a problem with your set.
- If any button is pressed to call up the On-Screen Display while viewing a Closed Caption broadcast, the closed captions will disappear momentarily.
- If no **TEXT** broadcast is being received while viewing in the [TEXT] mode, the screen may become dark and blank for some programs. Should this occur, switch the Closed Caption mode to **OFF**.

ADJUSTMENT (Continued)

Adjusting the V-CHIP Settings

■ V-CHIP

- This function allows TV programs to be restricted and TV usage to be controlled based on FCC data. It prevents children from watching violent or sexual scenes that may be harmful.
- Restriction of TV programs includes two ratings that contain information about the program: the MPAA rating and the TV Parental Guidelines. The MPAA rating is restricted by age and content.
- Since a TV program may use either the MPAA rating or the TV Guidelines, both should be adjusted for complete control.

[1] MPAA RATING

RATING		
age base	G	GENERAL AUDIENCES. All ages admitted.
	PG	PARENTAL GUIDANCE SUGGESTED. Some material may not be suitable for children.
	PG-13	PARENTAL STRONGLY CAUTIONED. Some material may be inappropriate for children under 13.
	R	RESTRICTED. Under 17 requires accompanying parent or adult guardian.
	NC-17	NO ONE 17 AND UNDER ADMITTED.
	X	X is an older rating that is unified with NC-17 but may be encoded in the data of older movies.

MPAA RATING (examples)

Example 1:

PG-13 in the age-based rating is blocked, this will also automatically block the higher ratings R, NC-17 and X.

1. User setting

G	----
PG	----
PG-13	BLOCK
R	BLOCK
NC-17	BLOCK
X	BLOCK

2. Block table

G	not to block
PG	not to block
PG-13	Select block
R	auto-block
NC-17	auto-block
X	auto-block

Example 2:

R in the age-based rating is blocked, this will also automatically block the higher ratings NC-17 and X.

1. User setting

G	----
PG	----
PG-13	----
R	BLOCK
NC-17	BLOCK
X	BLOCK

2. Block table

G	not to block
PG	not to block
PG-13	not to block
R	Select block
NC-17	auto-block
X	auto-block

Note

- The MPAA rating is only age-based.

ADJUSTMENT (Continued)

Adjusting the V-CHIP Settings (Continued)

[2] TV PARENTAL GUIDELINES

RATING		← content base →				
		FV (Fantasy Violence)	V (Violence)	S (Sexual Situation)	L (Adult Language)	D (Sexually Suggestive Dialog)
↑ age base ↓	TV-Y (All children)	☒	☒	☒	☒	☒
	TV-Y7 (Direct to Older Children)	×	☒	☒	☒	☒
	TV-G (General Audience)		☒	☒	☒	☒
	TV-PG (Parental Guidance Suggested)		×	×	×	×
	TV-14 (Parents Strongly Cautioned)		×	×	×	×
	TV-MA (Mature Audience Only)		×	×	×	

☒: The content rating can be set, but this rating is not normally broadcast by TV stations.
 X: The content rating can be set.

TV PARENTAL GUIDELINES (examples)

Example 1:

When TV-Y7 in the age-based rating is set to BLOCK, this will automatically block the higher ratings: TV-G, TV-PG, TV-14 and TV-MA. In addition, D, L, S, V and FV in CONTENT are automatically blocked unless you manually set BLOCK CONTENT.

1. User setting

TV-Y	----
TV-Y7	BLOCK
TV-G	BLOCK
TV-PG	BLOCK
TV-14	BLOCK
TV-MA	BLOCK

BLOCK CONTENT (D L S V FV)

2. Block table

		content base				
		FV	V	S	L	D
↑ age base ↓	TV-Y					
	TV-Y7					
	TV-G					
	TV-PG					
	TV-14					
	TV-MA					

TV-Y7 Select block auto-block

Example 2:

When no item in the age-based rating is blocked, D in the content-based rating will be automatically blocked.

1. User setting

TV-Y	----
TV-Y7	----
TV-G	----
TV-PG	----
TV-14	----
TV-MA	----

BLOCK CONTENT (D)

2. Block table

		content base				
		FV	V	S	L	D
↑ age base ↓	TV-Y					
	TV-Y7					
	TV-G					
	TV-PG					
	TV-14					
	TV-MA					

auto-block

Note

- Age-based ratings can be modified by the content-based ratings, but only in the combinations indicated by an X in the table above.
- Choosing a lower age-based rating blocks the higher age-based ratings regardless of content rating settings.
- If you set TV-Y and TV-Y7 to BLOCK, CONTENT will display all items.

ADJUSTMENT (Continued)

Adjusting the V-CHIP Settings (Continued)

■ SETTING V-CHIP

[1] MPAA RATING

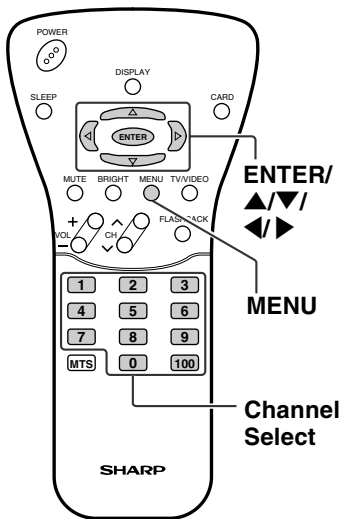

1 Press **MENU** to display the MENU screen.

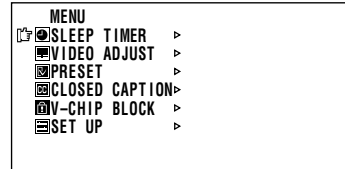

2 Press **▲/▼** to move the cursor to **V-CHIP BLOCK**, and press **ENTER**.

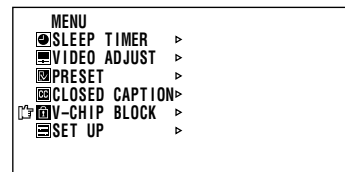

3 **INPUT SECRET NO.** will be displayed. Input the 4-digit secret number by using the channel select keys.

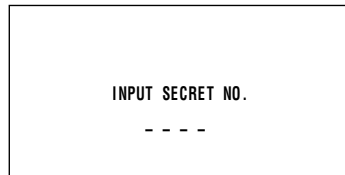

4 Press **▲/▼** to move the cursor to **MPAA**, and press **ENTER**.

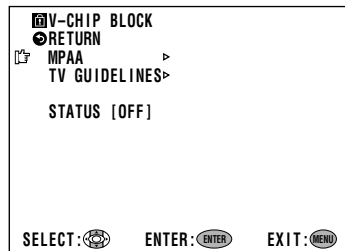

5 Press **▲/▼** to move the cursor to **PG**, and press **ENTER**.

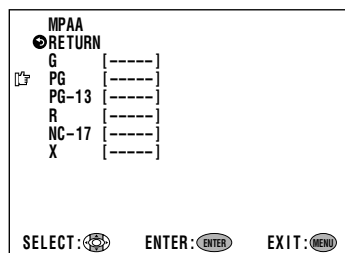

6 Press **◀/▶** to select **BLOCK**, and press **ENTER**.
If you set PG to BLOCK, PG-13, R, NC-17 and X are automatically blocked.

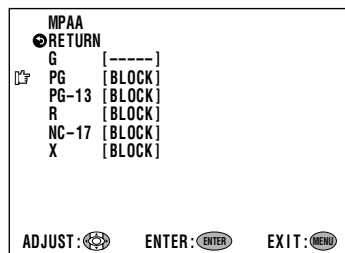

7 Press **MENU** to return to the main screen.

Note

- If you set G to BLOCK, all ratings are automatically blocked.
- If you set X to BLOCK, G, PG, PG-13, R and NC-17 are not blocked.

ADJUSTMENT (Continued)

Adjusting the V-CHIP Settings (Continued)

[2] TV GUIDELINES

■ Setting MPAA

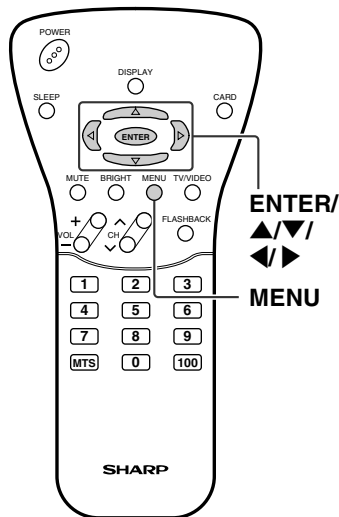

1 Repeat steps 1 to 3 of [1] MPAA RATING.

2 Press ▲/▼ to move the cursor to TV GUIDELINES, and press ENTER.

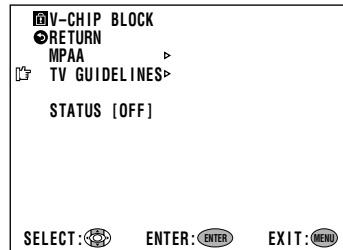

3 Press ▲/▼ to move the cursor to TV-Y7, and press ENTER.

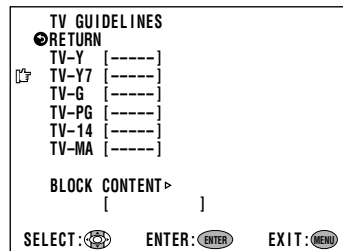

4 Press ◀▶ to select BLOCK, and press ENTER.
If you set TV-Y7 to BLOCK, TV-G, TV-PG, TV-14 and TV-MA are automatically blocked. In addition, D, L, S, V and FV in CONTENT are automatically blocked.

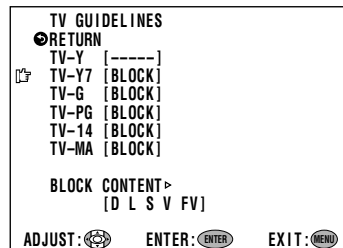

5 Press MENU to return to the main screen.

ADJUSTMENT (Continued)

Adjusting the V-CHIP Settings (Continued)

■ Setting BLOCK CONTENT

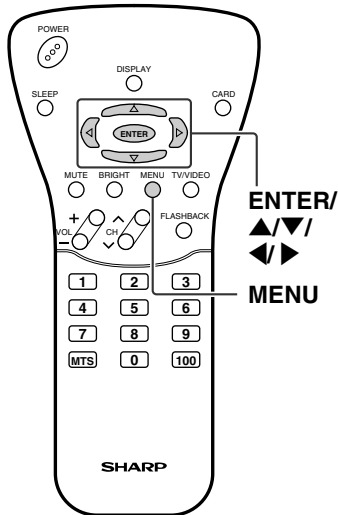

1 Repeat steps 1 to 3 of [1] MPAA RATING.

2 Press ▲/▼ to move the cursor to TV GUIDELINES, and press ENTER.

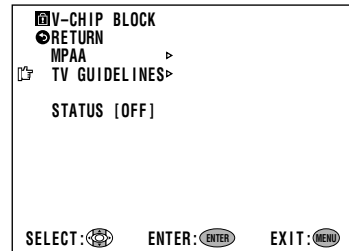

3 Press ▲/▼ to move the cursor to BLOCK CONTENT, and press ENTER.

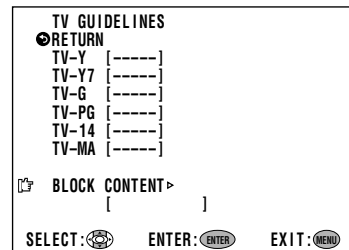

4 Press ▲/▼ to move the cursor to the desired item, and press ENTER.

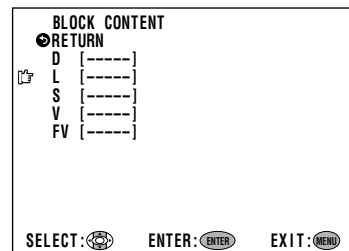

5 Press ◀▶ to select BLOCK or ----- (unblock), and press ENTER.

6 Press MENU to return to the main screen.

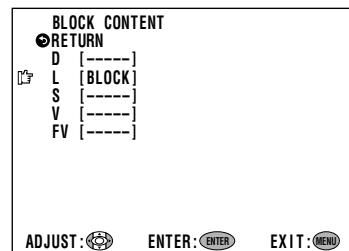

Note

- If you set TV-14 to BLOCK, TV-MA is automatically blocked. Contents D, L, S and V are automatically blocked by X in the table on page 30.

ADJUSTMENT (Continued)

Adjusting the V-CHIP Settings (Continued)

[3] ACTIVATE ON TO TURN ON V-CHIP BLOCK

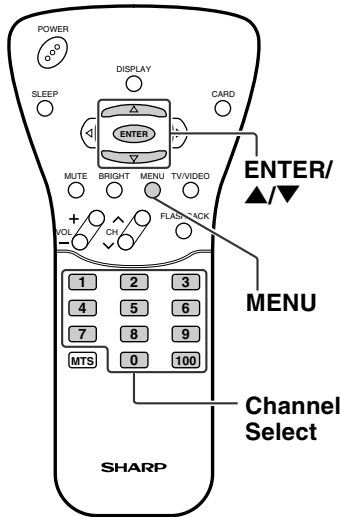

1 Press **MENU** to display the MENU screen.

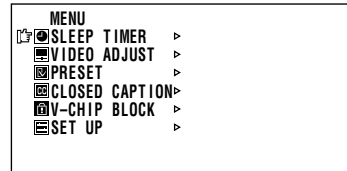

2 Press **▲/▼** to move the cursor to V-CHIP BLOCK, and press **ENTER**.

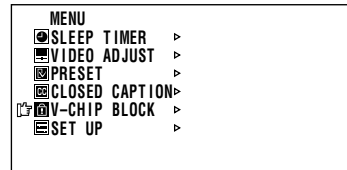

3 INPUT SECRET NO. will be displayed. Input the 4-digit secret number by using the channel select keys. (The secret number is not displayed on the screen.)

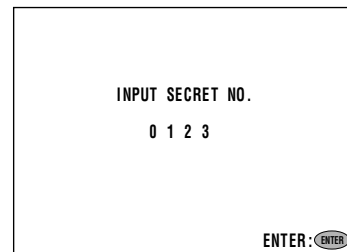

4 Press **ENTER** to register the secret number.

[4] CANCELING THE V-CHIP BLOCK SCREEN WHILE V-CHIP BLOCK IS ACTIVATED

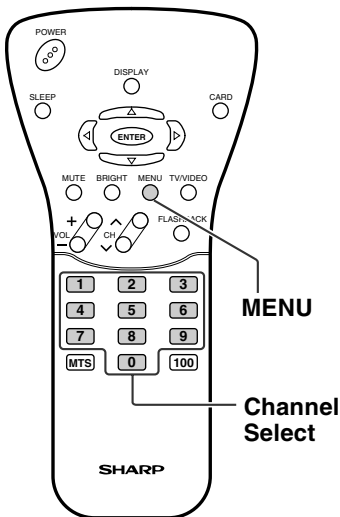

1 V-CHIP HAS BEEN ACTIVATED will be displayed if you watch the program with Program Rating data as same as you configured.



Note

- V-CHIP HAS BEEN ACTIVATED will not be displayed if STATUS is not configured to ON.

2 Press **MENU** to display INPUT SECRET NO.

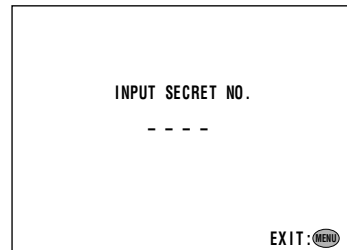

3 Input the 4-digit secret number by using the channel select keys; V-CHIP BLOCK is temporarily canceled. If you input an incorrect secret number, SECRET NO. IS INCORRECT is displayed. In this case, input the correct secret number.

Note

- If you turn the power on from off, V-CHIP BLOCK will be activated again.
If you select V-CHIP BLOCK again by using **MENU**, V-CHIP BLOCK will be turned on again.

ADJUSTMENT (Continued)

Adjusting the V-CHIP Settings (Continued)

[5] CHANGING THE V-CHIP BLOCK SETTINGS

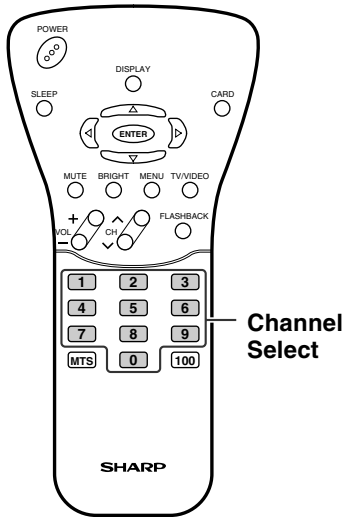

1 Repeat steps 1 to 3 of [1] **MPAA RATING**, then INPUT SECRET NO. will be displayed.

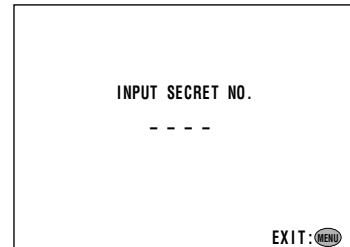

2 Input the 4-digit secret number by using the channel select keys; the V-CHIP select mode will be displayed. Set V-CHIP BLOCK again.

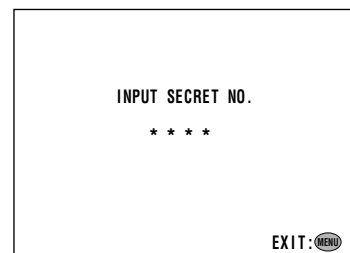

[6] CHANGING OR CLEARING THE SECRET NUMBER

If you forget the secret number, clear the secret number as follows.

Upper control panel of the main unit

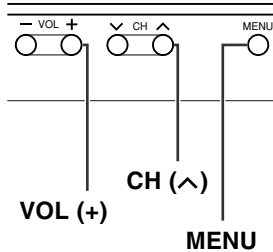

1 Repeat steps 1 to 3 of [1] **MPAA RATING**, or 1 to 2 of [4] **CANCELING THE V-CHIP BLOCK SCREEN WHILE V-CHIP BLOCK IS ACTIVATED**, then INPUT SECRET NO. will be displayed.

2 Press and hold both **CH (^)** and **VOL (+)** on the TV set simultaneously until the message INPUT SECRET NO. blinks.

3 Press **MENU** to exit.

MEMORY CARD PLAYBACK

Memory Cards

- Images that have been recorded on the memory card using a digital camera or other device and that conform to the DCF standard* can be played back in CARD mode.

* DCF (Design rule for Camera File system) is a standard of the Japan Electronics and Information Technology Industries Association (JEITA). This standard specifies the image file format used for images shot with a digital camera.

- Compatible memory cards (commercially available)

Memory card name	Storage capacity
SD Memory Card	128 MB or less
CompactFlash	128 MB or less
MultiMediaCard	64 MB or less
SmartMedia	128 MB or less
Memory Stick	128 MB or less

SD Memory Card is a trademark.

CompactFlash is a trademark of the SanDisk Corporation of the USA.

MultiMediaCard is a trademark of Infineon Technologies AG of Germany.

SmartMedia is a trademark of Toshiba Corporation.

Memory Stick is a trademark of Sony Corporation.

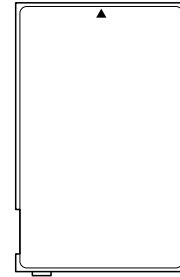

PC card adapter
(commercially available)

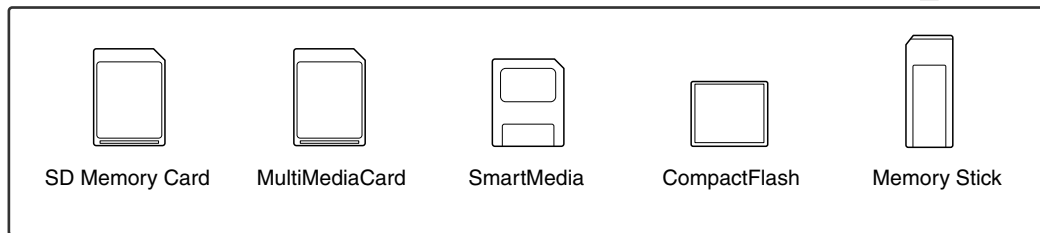

- * In order to play back images on a memory card, a PC card adapter (commercially available) intended for that memory card is required.

MEMORY CARD PLAYBACK (Continued)

Card Precautions

■ Precautions on Handling

Follow the precautions given below when handling the memory cards and PC card adapter as failure to do so may result in damage to data or malfunction.

- Playback of images stored on memory cards other than those listed in the table on page 36 is not guaranteed.
- Read the operation manuals for both the memory card and PC card adapter carefully as there may be restrictions on PC card adapter operations regarding memory card storage capacity.
- For details on the proper storage and handling of the memory card and PC card adapter being used, refer to the operation manuals supplied with both products.
- It may not be possible in some cases to play back images which have been created, modified, copied or otherwise edited using a PC.
- Always turn the LCD TV off before inserting or removing the PC card adapter or memory card loaded in the PC card adapter.
- Never turn off the LCD TV during memory card operations (such as when ACCESSING DATA is displayed or during a SLIDE SHOW playback) as this may result in loss of data recorded on the memory card.
- During CARD mode, do not subject the system to vibration or shock of impact, and never remove the PC card adapter or memory card loaded in the PC card adapter as this may result in loss of data recorded on the memory card.
- Do not bend, drop or subject the memory card or PC card adapter to shock of impact.
- Do not store the memory card or PC card adapter in hot, humid locations or locations subject to direct sunlight.
- Avoid use and storage in an environment where strong static electricity or electrical noise is generated.
- Do not disassemble or modify the memory card or PC card adapter.

■ Storing data

Recorded data may be lost in the following cases. Sharp bears absolutely no responsibility for recorded data that may be lost.

Data may be lost IF:

- * The user or third party uses the memory card incorrectly.
- * The memory card is subjected to the adverse effects of static electricity or electrical noise.
- * The PC card adapter or a memory card loaded in a PC card adapter is plugged in or unplugged while the power is turned on.
- * The LCD TV is turned off during memory card operations (such as when ACCESSING DATA is displayed or during a SLIDE SHOW playback).

We recommend that valuable data be backed up by copying to another media (such as MO disk, floppy disk, or hard disk) before accessing that image data with this system.

MEMORY CARD PLAYBACK (Continued)

Preparation

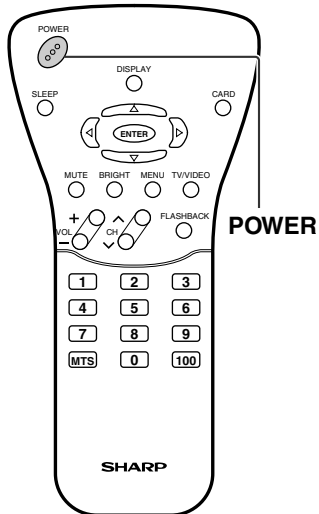

1 Insert the memory card (commercially available) on which images have been recorded into the PC card adapter (commercially available).

* Example of inserting a memory card into a PC card adapter.

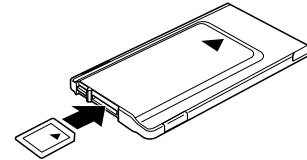

2 Press **POWER** to turn off the LCD TV.

CAUTION:

Always turn off the LCD TV before plugging in or unplugging the PC card adapter or memory card. (Never plug in or unplug the PC card adapter or memory card during card playback.)

3 Slowly insert the PC card adapter into the PC card slot on the main unit.

NOTE:

With its cutout positioned at the top right, insert the PC card adapter firmly.

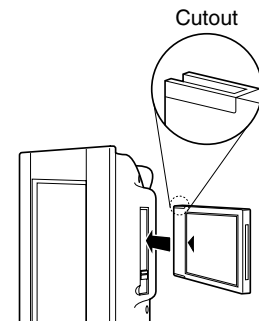

* Insert the PC card adapter correctly in the direction shown by the arrow.

Note

- Use the appropriate PC card adapter (commercially available) for the memory card.
- Use the PC card adapter recommended by the manufacturer of the memory card in question to load images from the recording media that have been shot using a digital camera. (The name differs depending on the manufacturer.)
- For details, refer to the operation manuals for the digital camera and PC card adapter.

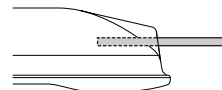

* Be sure to insert the card straight.

Pulling out the memory card

- 1** Press **POWER** to turn off the LCD TV.
- 2** Raise the card release lever horizontally.
- 3** Press the lever straight on.
- 4** Pull out the card and lower the lever.

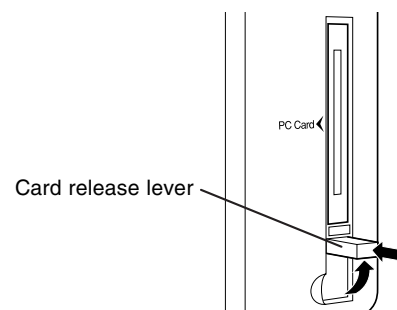

MEMORY CARD PLAYBACK (Continued)

Turning on CARD Mode

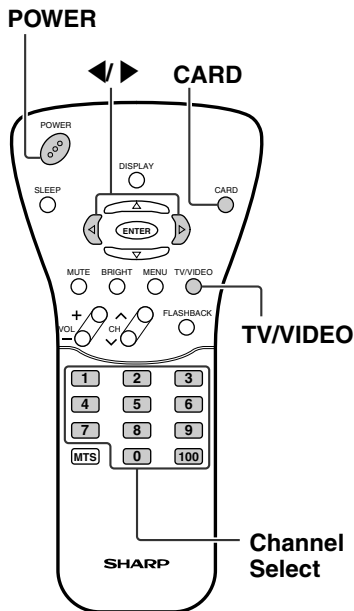

1 Press **POWER** to turn on the LCD TV.

2 Press **CARD** to change to CARD mode.

ACCESSING DATA is displayed on the screen.

After data from the card is loaded, **CARD** is displayed on the screen.

Note

- After purchasing the LCD TV, **CARD** playback mode is set as the factory settings. The next time the card is played back, the image is displayed in the last playback mode.

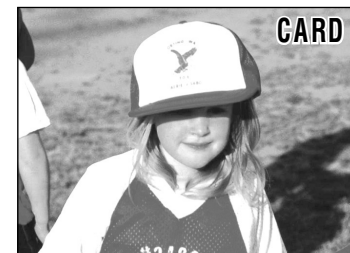

3 Press **CARD** to select a playback mode. Each time **CARD** is pressed, the playback mode changes as follows.

■ **CARD**

Images on the card are displayed one by one in full-screen, and the next and previous images can be displayed by selecting with **◀▶**.



■ **SLIDE SHOW**

Images are automatically displayed in sequence, one by one. The display interval for each image can be selected from: 5SEC, 10SEC, 1MIN, 15MIN, or 60MIN



■ **INDEX MODE**

Images recorded on the memory card are displayed nine images on the screen at a time.



Note

- If a card error message (red) appears on the screen and images cannot be played back, refer to TROUBLESHOOTING on page 53.
- Never turn off the LCD TV during memory card operations (such as when ACCESSING DATA is displayed or during a SLIDE SHOW playback) as this may result in loss of data recorded on the memory card.
- CARD** mode is selected when **CARD** is pressed while viewing the LCD TV.
- To switch **CARD** mode to TV mode, press any of the following buttons. **Channel Select, TV/VIDEO**
- Full size display may not be possible depending on the mode in which images were recorded using the digital still camera or other device.
- Turning on **CARD** mode and Page forwarding during **INDEX MODE** can only be performed using the remote control. **MY PROGRAM** settings for **CARD SETTING** can only be made using the remote control.

MEMORY CARD PLAYBACK (Continued)

Selecting the Playback Mode

■ CARD playback mode

Images on the card are displayed one by one. It is possible to forward or reverse through the images.

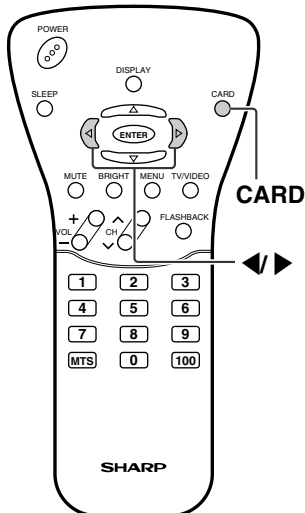

1 Press **CARD** to change to CARD playback mode.

2 Press ◀▶ to select the desired image to display. ▶ cycles images in forward sequence, while ◀ cycles images in reverse sequence. ACCESSING DATA is displayed until the next image is displayed.

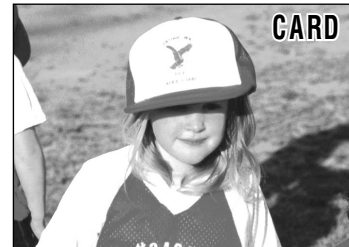

Note

- The size of the image being displayed differs depending on the settings used when the shot was taken.

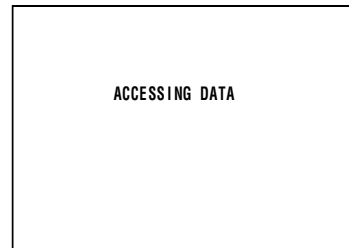

■ SLIDE SHOW playback mode

It is possible to automatically display the images registered for MY PROGRAM in sequence, one by one. (For details on registering MY PROGRAM images, see page 44 and page 45.)

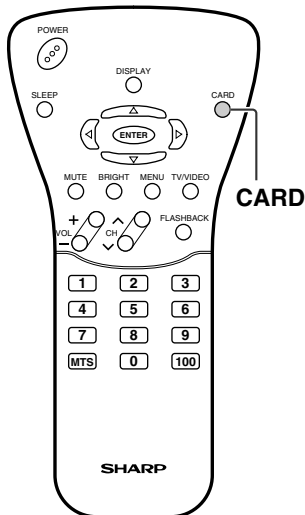

1 Press **CARD** to switch to SLIDE SHOW playback mode.

Note

- The first time SLIDE SHOW playback mode is selected after purchase, operations are performed according to default factory settings. Default factory settings are as follows.
INTERVAL: 5SEC
ORDER TO SHOW: NORMAL
REPEAT: ON
- Depending on the loading time required for the data to be displayed next, the current image may be displayed longer than the display time that has been set.
- Perform SLIDE SHOW settings to change default factory settings. (see page 43)



2 To stop SLIDE SHOW playback, press **CARD** to switch to other playback mode.

Note

- The SLIDE SHOW playback is paused while the MENU screen is displayed.

MEMORY CARD PLAYBACK (Continued)

Selecting the Playback Mode (Continued)

INDEX playback mode

It is possible to display nine images at a time.

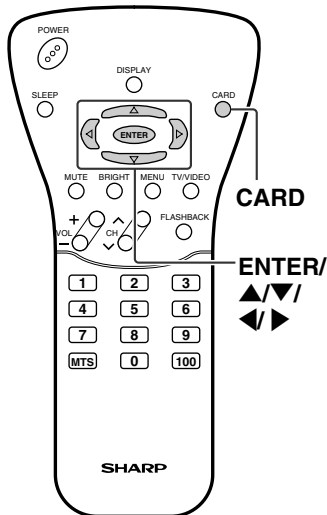

1 Press **CARD** to switch to INDEX MODE. Nine images are displayed on the screen at a time.

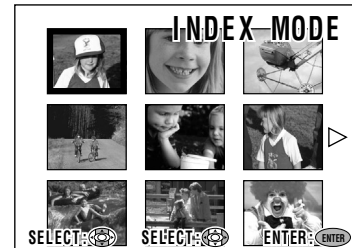

2 Select an image using $\blacktriangle/\blacktriangledown/\blacktriangleleft/\blacktriangleright$, and press **ENTER**. Only the selected image is displayed on the screen in CARD playback mode.



Note

- The DISPLAY button does not function on the INDEX MODE screen.
- In INDEX MODE, the contents displayed differ as described below depending on the ORDER TO SHOW setting made for SLIDE SHOW playback mode.
 NORMAL/RANDOM: All image files on the memory card are displayed nine at a time.
 MY PROGRAM: Only images registered for SET PROGRAM are displayed.

Page Forwarding

- 1** Press \blacktriangleright to move the selection marker to the image on the right side.
- 2** Press \blacktriangleright to move the selection marker to the triangular mark \blacktriangleright on the right end of the screen. The triangular mark \blacktriangleright turns yellow.
- 3** Press \blacktriangleright one more time. The display changes to that for the next page of index images. The selection marker is displayed on the center image on the left.

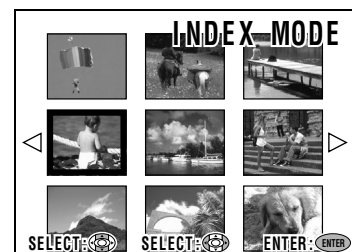
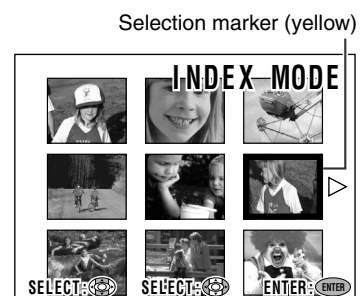

Page Reverse

To reverse through pages, use the same operation as described above pressing \blacktriangleleft .

Note

- It is impossible to switch the playback mode even by pressing **CARD** while the triangular mark $\blacktriangleleft/\blacktriangleright$ on the INDEX MODE screen is selected (yellow).
- If the Page Forwarding operation is used on the last page of images, the display returns to the first page.
- On the first page, a triangular mark \blacktriangleleft is not displayed on the left.

CARD ADJUSTMENT

Selecting CARD SETTING Items

CARD SETTING on the MENU screen can be used to make various settings such as SLIDE SHOW, MY PROGRAM, ROTATE and SOUND SETTING. Select the desired item by following the steps below and then refer to the indicated page for details.



- 1 Turn on CARD mode. (see page 39)
- 2 Press **MENU** to display the MENU screen.
- 3 Press **▲/▼** to move the cursor to CARD SETTING, and press **ENTER**.
- 4 Press **▲/▼** to select the desired setting item, and press **ENTER**.

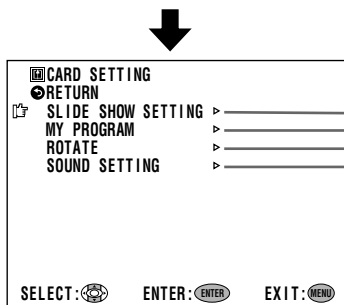
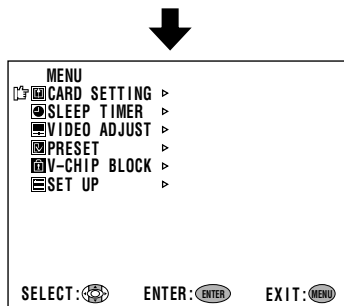

(Page 43)

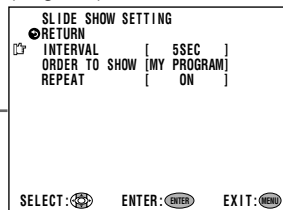

(Pages 44, 45)

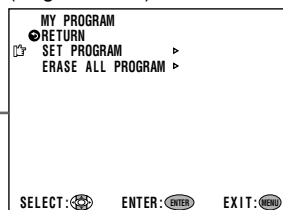

(Page 46)

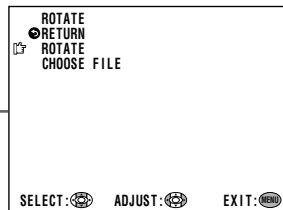

(Page 47)

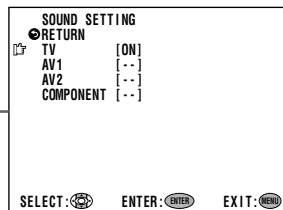

Note

- The displayed items differ depending on the setting conditions.
- The selected item changes to yellow.
- Items in magenta cannot be selected.
- To return to the previous screen, select RETURN.
- CARD SETTING is displayed on the MENU screen only during CARD mode.
- CARD SETTING cannot be selected until the system determines that the card can be used.
- CLOSED CAPTION is not displayed on the MENU screen during CARD mode. Select TV/VIDEO mode and then set the CLOSED CAPTION settings.
- The only VIDEO ADJUST settings available during CARD mode are PICTURE, RESET and RETURN.
- COLOR SYSTEM is always set to N358 and cannot be changed during CARD mode.
- The BLUE SCREEN, CH-SETTING, CLOSED CAPTION, V-CHIP BLOCK, AUTO POWER OFF functions and video output do not operate during CARD mode.
- If MY PROGRAM is set in ORDER TO SHOW for SLIDE SHOW settings, only registered images will be played back in INDEX MODE.
- The ROTATE settings cannot be selected in INDEX MODE.

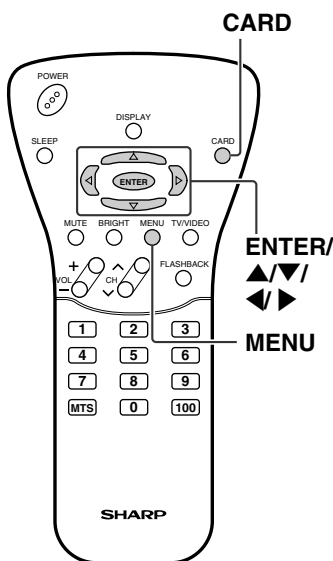

CARD ADJUSTMENT (Continued)

Adjusting the SLIDE SHOW Settings

You can set the desired display time and playback order. REPEAT setting is also available.

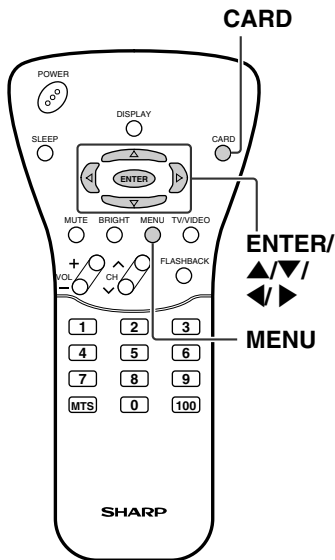

- 1 Press **CARD** to change to CARD mode.
- 2 Press **CARD** to switch to SLIDE SHOW as the playback mode.
- 3 Press **MENU** to display the MENU screen.
- 4 Press **▲/▼** to move the cursor to **CARD SETTING**, and press **ENTER**.

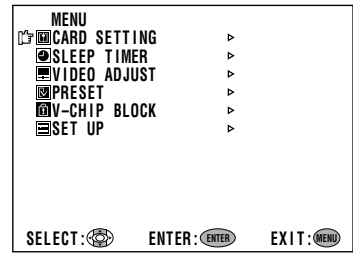

- 5 Press **▲/▼** to move the cursor to **SLIDE SHOW SETTING**, and press **ENTER**.

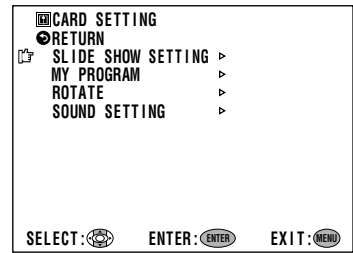

- 6 Press **▲/▼** to select the desired setting item, and press **ENTER**.
- 7 Press **◀/▶** to change the setting, and press **ENTER**.

■ The following SLIDE SHOW settings are available.

INTERVAL:

→ 5SEC ↔ 10SEC ↔ 1MIN ←
→ 60MIN ↔ 15MIN ←

ORDER TO SHOW:

→ NORMAL ↔ RANDOM ←
→ MY PROGRAM ←

REPEAT: ON ↔ OFF

- 8 Press **MENU** to exit.

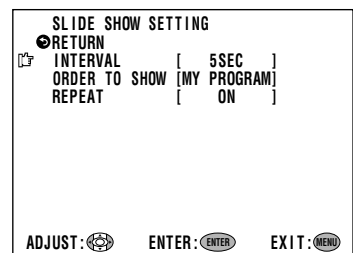
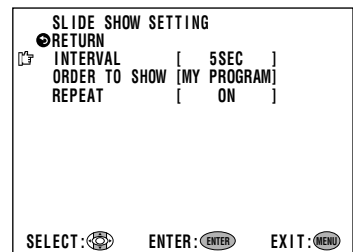

Note

- The above time setting for INTERVAL is the minimum display time per image. Actual playback time for an image may vary depending on the data size and the time required to load the image from the media.
- Although pressing **MENU** will pause the SLIDE SHOW playback, the SLIDE SHOW playback continues when you exit the MENU screen.

CARD ADJUSTMENT (Continued)

Adjusting the MY PROGRAM Settings

You can select and register any of up to nine images from a large number of images. Images registered for MY PROGRAM are displayed in the specified sequence in SLIDE SHOW playback mode.

■ Registering MY PROGRAM Images

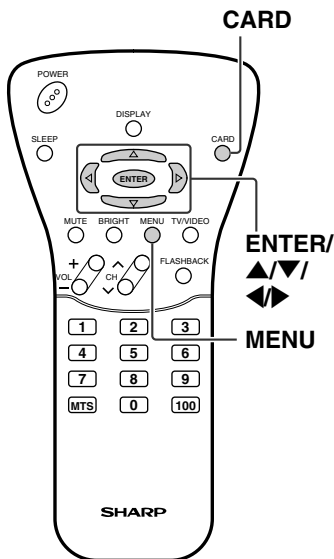

- 1** Press **CARD** to change to CARD mode.
- 2** Press **MENU** to display the MENU screen, press **▲/▼** to move the cursor to **CARD SETTING**, and press **ENTER** to display the **CARD SETTING** screen.
- 3** Press **▲/▼** to move the cursor to **MY PROGRAM**, and press **ENTER**.
- 4** Press **▲/▼** to move the cursor to **SET PROGRAM**, and press **ENTER**.

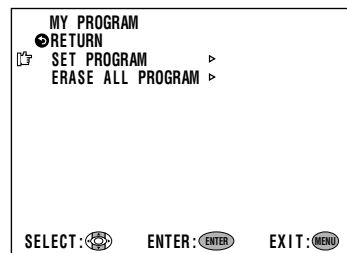
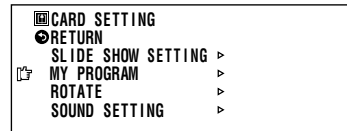
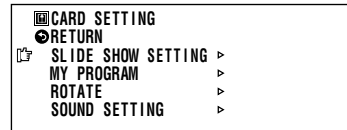

- 5** Press **◀▶** to select the location at which the image to be registered, moving the selection marker (red) in the registration area, and press **ENTER**.
The location to be registered can be selected from 1 through 9 in the specified number.

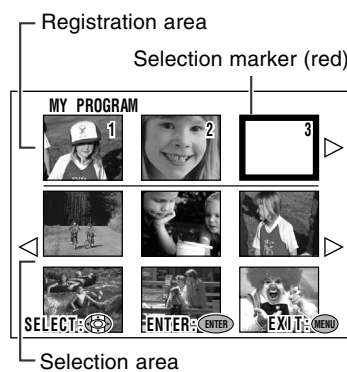

Note

- The previous three images are displayed by aligning the selection marker (red) with the triangular mark ◀ and pressing ◀.
- The next three images are displayed by aligning the selection marker (red) with the triangular mark ▶ and pressing ▶.
- The image registered for MY PROGRAM is erased when another card is inserted.
- The images that have been registered for MY PROGRAM are played back when MY PROGRAM is selected in ORDER TO SHOW for the SLIDE SHOW SETTING. (For details on the settings, see page 43.) Only registered images are displayed on the INDEX MODE screen at this time.

CARD ADJUSTMENT (Continued)

Adjusting the MY PROGRAM Settings (Continued)

- Press **▲/▼/◀/▶** to select the image to be registered, moving the selection marker (yellow) in the selection area, and press **ENTER**. The image is then registered in the registration area that was specified in step 4. (see page 44)
- Repeat steps 5 and 6 to register more images.

Selection marker (yellow)



Note

- The previous six images are displayed by aligning the selection marker (yellow) with the triangular mark ◀ and pressing ▲.
- The next six images are displayed by aligning the selection marker (yellow) with the triangular mark ▶ and pressing ▼.
- If an image is registered in a location number for which another image has already been registered, the previous image is dropped from the registered entries and overwritten by the new image.

Erasing the MY PROGRAM Settings

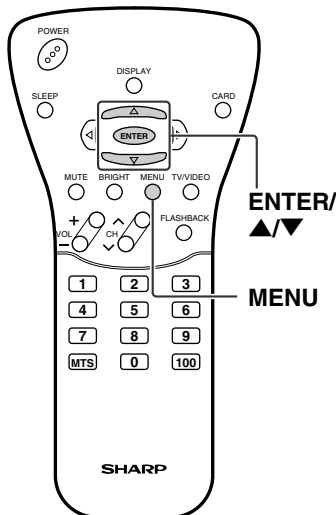

- Press **MENU** to display the MENU screen, press **▲/▼** to move the cursor to **CARD SETTING**, and press **ENTER** to display the **CARD SETTING** screen.
- Press **▲/▼** to move the cursor to **MY PROGRAM**, and press **ENTER**.
- Press **▲/▼** to move the cursor to **ERASE ALL PROGRAM**, and press **ENTER**. All images in the registration area will be erased.

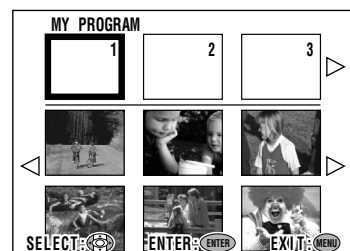
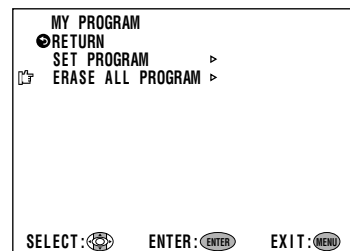
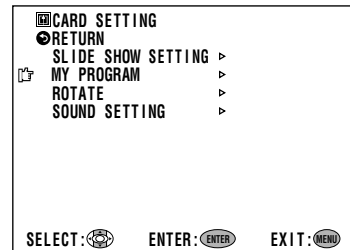

Note

- Repeat steps 4 and 5 given in "Registering MY PROGRAM Images" to register new images.

CARD ADJUSTMENT (Continued)

Adjusting the ROTATE Settings

- You can rotate a recorded image.
- You can move to the next or previous image by selecting CHOOSE FILE even if you have not exited the ROTATE screen.

Rotating Images

When the image that you want to rotate is displayed in CARD or SLIDE SHOW playback mode, follow the steps below to rotate the image.

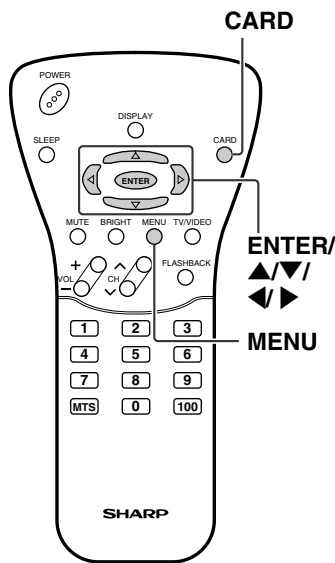

1 Press **MENU** to display the MENU screen, press **▲/▼** to move the cursor to **CARD SETTING**, and press **ENTER** to display the **CARD SETTING** screen.

2 Press **▲/▼** to move the cursor to **ROTATE**, and press **ENTER**.

3 Press **◀▶** to rotate the image.

Press **◀**: Rotates 90 degrees counterclockwise.
 Press **▶**: Rotates 90 degrees clockwise.

Note

- ROTATE settings are canceled if power is turned off without registering the rotated image in the MY PROGRAM setting.
- The ROTATE settings cannot be selected in INDEX MODE.

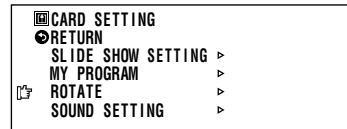

Selecting a file

Press **▲/▼** to move the cursor to **CHOOSE FILE** on the **ROTATE** screen and select an image by pressing **◀▶**.

Press **◀**: To the previous file

Press **▶**: To the next file

Note

- CHOOSE FILE is displayed in magenta and cannot be selected when RANDOM is selected for the SLIDE SHOW settings.(see page 43)
- CHOOSE FILE may turn magenta during ROTATE processing.



CARD ADJUSTMENT (Continued)

Adjusting the SOUND Settings

You can listen to the audio from TV or external devices such as VCR or DVD player, etc. through the TV set while card playback.

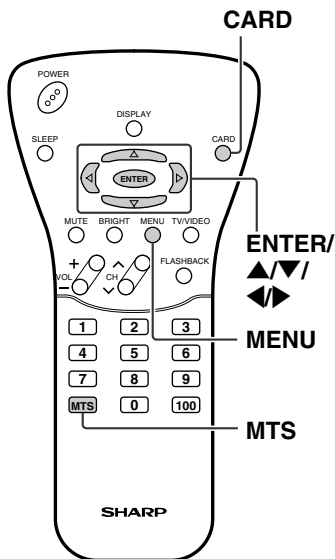

- 1 Press **CARD** to change to CARD mode.
- 2 Press **MENU** to display the MENU screen, press **▲/▼** to move the cursor to **CARD SETTING**, and press **ENTER** to display the **CARD SETTING** screen.
- 3 Press **▲/▼** to move the cursor to **SOUND SETTING**, and press **ENTER**.
- 4 Press **▲/▼** to select the desired setting item, and press **ENTER**.

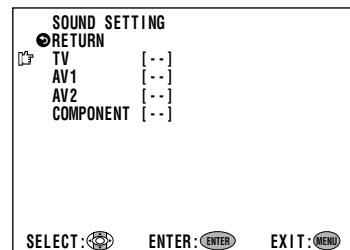
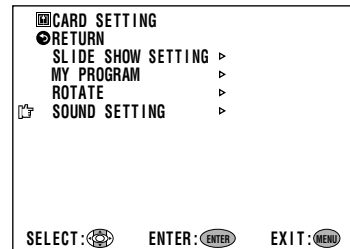

- 5 Press **◀/▶** to select **ON** or **-- (OFF)**, and press **ENTER**.
 - You can select only one of the following items for the **SOUND SETTING** during card playback.
 - **TV**: Outputs the audio from TV prior to switching to **CARD** mode. **STEREO** audio or **SAP** is set as the audio on the television screen.
 - **AV1**: Outputs the audio from **AV-IN1** terminal.
 - **AV2**: Outputs the audio from **AV-IN2** terminal.
 - **COMPONENT**: Outputs the audio from **COMPONENT** terminal.
 - During **CARD** mode, the **SOUND SETTING** can be changed by pressing **MTS** on the remote control. Each time **MTS** is pressed, the **SOUND SETTING** will be changed as follows.

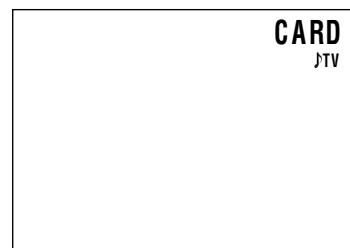
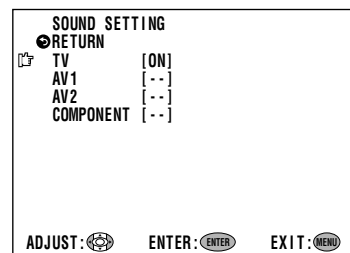
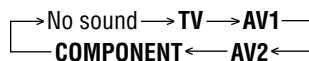

Note

- Audio recorded on the memory card cannot be played back.
- If any of the sound item is set to **ON**, all other sound item will be automatically set to **-- (OFF)**.
- When **OUT** has been selected as the **AV2 IN/OUT** setting, it is not possible to set **AV2** to **ON** in **SOUND SETTING** for **CARD** mode. In order to set **AV2** to **ON**, select **IN** as the **AV2 IN/OUT** setting.



CONNECTING WITH EXTERNAL DEVICES

You can enjoy picture and sound by connecting a VCR or a home video game system to the terminals located on the rear of the TV set.

When connecting an external device, turn off the power of the main unit first to prevent any possible damage.

Example of external devices that can be connected

External devices that can be connected to AV-IN2 terminal

<Example>

- VCR
- Laser disc player



* If your external device has an S-Video terminal, S-VIDEO connection is recommended.

External devices that can be connected to AV-IN1 terminal

<Example>

- Video camera
- Home video game system

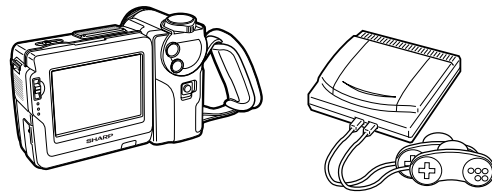

* If your external device has an S-Video terminal, S-VIDEO connection is recommended.

External devices that can be connected to COMPONENT terminal

<Example>

- DVD, etc.

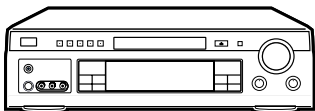

* If your external device has a component terminal, COMPONENT connection is recommended (you can view high-quality pictures). If your external device does not have a component terminal, S-VIDEO connection is recommended.

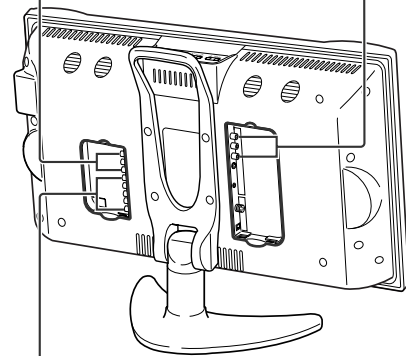

Note

- PC connection is not possible.
- For the cable, use a commercially available audio/video cord.
- Only connect audio/video signals to AV-IN1 and 2 terminals. Connecting other signals may result in a malfunction.
- AV-IN1 has 2 video input terminals: VIDEO and S-VIDEO. When you connect external devices to both terminals (and if you select AV-IN1), you can only view pictures from the S-VIDEO terminal. To view the picture from the VIDEO terminal, do not connect any external device to the S-VIDEO terminal.
- For more information about external device connections, see the manuals of your external devices.



CONNECTING WITH EXTERNAL DEVICES (Continued)

Connecting a VCR, DVD player or a video camera (AV-IN1/2/COMPONENT)

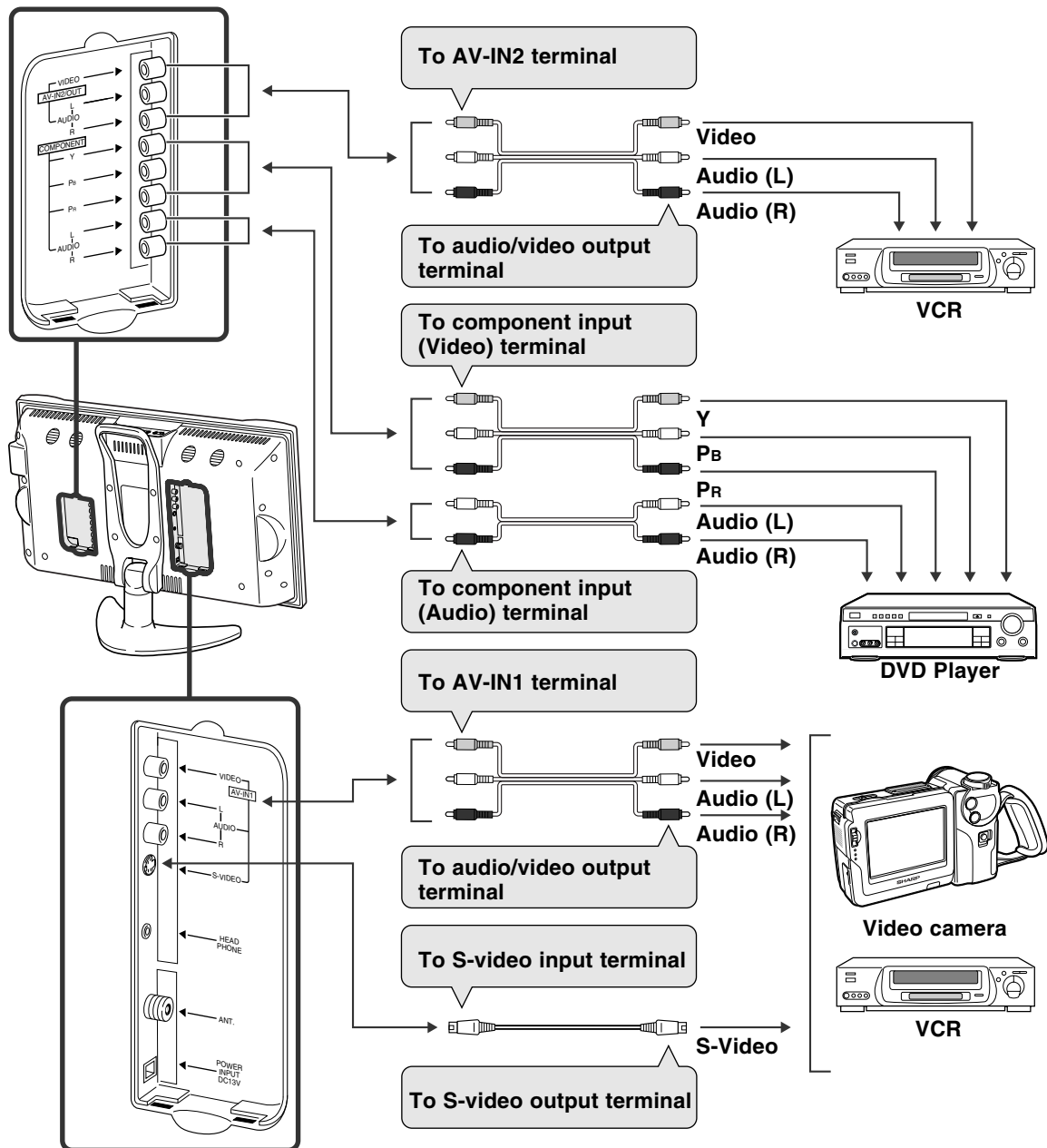

Note

- If your VCR (or other external devices) has an S-Video terminal, S-VIDEO connection is recommended. (Use an S-video cord.)
- When you connect external devices to both S-VIDEO and VIDEO terminals (and if you select AV-IN1), you can only view pictures from the S-VIDEO terminal.
- You cannot view multiple or synthesized pictures by connecting two or more external devices. When connecting an external device, use care to connect the video and audio cables to the corresponding terminals.
- Do not connect antennas or headphones to AV-IN2.

CONNECTING WITH EXTERNAL DEVICES (Continued)

Outputting video and audio (video output)

You can output video and audio data from the TV set through the AV output terminals (AV-OUT).

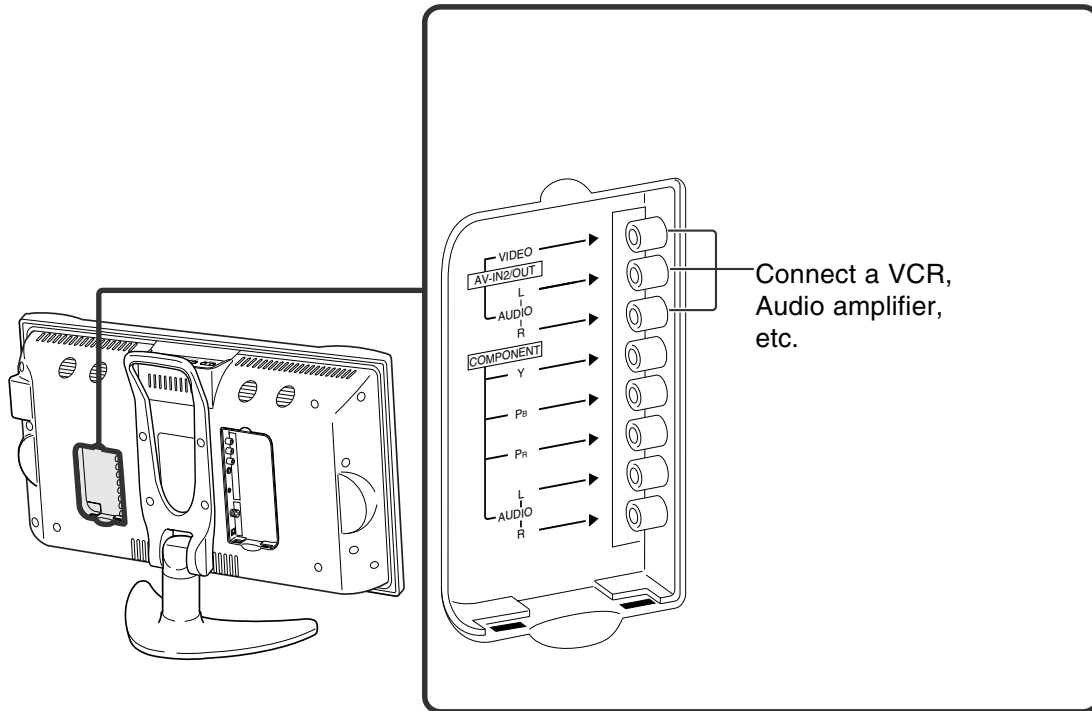

Note

- AV2 has 2 OUT modes (see page 24).
- When using the S-Video input for AV-IN1, no video output will be made to the AV output terminal, but audio output will be made for connection to external audio systems.
- It is impossible for card images to video output.

How to fix the cables



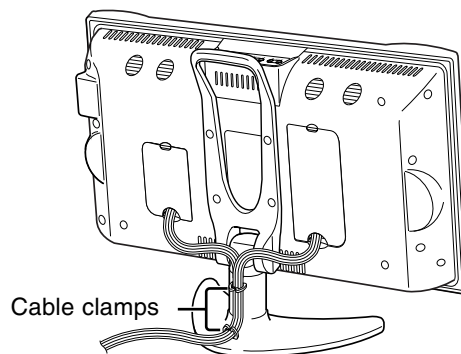



- Fix cables and cords with the attached cable clamps so that they do not get caught when mounting the cover.
- Connect the cables and cords after fixing the cable clamps (2 positions).

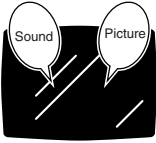
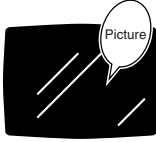

TROUBLESHOOTING

■ Before calling for repair service, check the following items for possible remedies to the encountered symptoms.





TV set

Problem	Check item	Reference Pages
 <p>There is no picture or sound.</p>	<ul style="list-style-type: none"> • Make sure the AC adapter is properly inserted in the power outlet. • Reception other than those of broadcasting stations can be considered. • Make sure the input mode is set to TV. • Make sure the main power switch of the main unit is on. 	<p>9</p> <p>15 15</p>
 <p>There is no picture. There is no picture from AV-IN 1.</p>	<ul style="list-style-type: none"> • Make sure the BLACK LEVEL is properly adjusted. • Fluorescent lamp may have reached the end of service life. • Make sure the S-Video terminal is free of connections. 	<p>22, 23 — 49</p>
 <p>There is no sound.</p>	<ul style="list-style-type: none"> • Make sure the volume is not set to minimum. • Make sure the sound is not set to mute. • Make sure that headphones are not connected. 	<p>16 16 13</p>
 <p>There is no picture or sound, just noise.</p>	<ul style="list-style-type: none"> • Make sure the antenna cable is properly connected. • Consider whether TV signals are being properly received. 	<p>9 —</p>
 <p>Picture is not clear.</p>	<ul style="list-style-type: none"> • Make sure the antenna cable is properly connected. • Consider whether TV signals are being properly received. 	<p>9 —</p>
 <p>Picture is light or improperly tinted.</p>	<ul style="list-style-type: none"> • Check color adjustment. • Check color system setting. 	<p>22, 23</p>
 <p>The picture is too dark.</p>	<ul style="list-style-type: none"> • Press the Brightness button. • Check PICTURE and BLACK LEVEL adjustment. • Fluorescent lamp may have reached the end of service life. 	<p>22, 23 54</p>
<p>Remote control does not work.</p>	<ul style="list-style-type: none"> • Check the batteries of the remote controller. • Make sure the remote sensor window is not under strong fluorescent lighting. 	<p>8 8</p>



TROUBLESHOOTING (Continued)

Antenna

Problem	Check item
 <p>The picture is not sharp.</p>	<ul style="list-style-type: none"> • The reception may be weak. • The state of the broadcast may also be bad. • Make sure the antenna is facing the right direction. • Make sure the outside antenna is not disconnected.
 <p>The picture moves.</p>	
 <p>The picture is doubled or tripled.</p>	<ul style="list-style-type: none"> • Make sure the antenna is facing the right direction. • There may be reflected electric waves from mountains or buildings.
 <p>The picture is spotted.</p>	<ul style="list-style-type: none"> • There may be interference from automobiles, trains, high voltage lines, neon lights, etc. • There may be interference between the antenna cable and power cable. Try positioning them further apart.
 <p>There are stripes on the screen or colors fade.</p>	<ul style="list-style-type: none"> • Is the unit receiving interference from other devices? Transmission antennas of radio broadcasting stations and transmission antennas of amateur radios and cellular phones may also cause interference. • Use the unit as far apart as possible from devices that may cause possible interference.

■ Use in hot and cold rooms (locations)

- When the unit is used in a low temperature rooms (location), the picture may leave trails or appear slightly delayed. This is not a malfunction, and the unit will recover when the temperature returns to normal.
- Do not leave the unit in a hot or cold location. Also, do not leave the unit in a location exposed to direct sunlight or near a heater, as this may cause the cabinet to deform and the LCD panel to malfunction.
(Storage temperature: -20°C to +60°C)

TROUBLESHOOTING (Continued)

Card

Problem	Check item	Reference Pages
Data on the card cannot be played back.	<ul style="list-style-type: none">• Check if data is recorded on the memory card.• Check if CARD mode is turned on as the input selection.• Images which have been processed by a PC sometimes cannot be played back by this equipment.	39
NO CARD INSERTED* ¹ is displayed.	<ul style="list-style-type: none">• Check that the memory card and/or PC card adapter are inserted.	38
NO IMAGE IN THE CARD* ¹ is displayed.	<ul style="list-style-type: none">• Use a memory card containing recorded image data.	–
ACCESSING DATA* ² is displayed.	<ul style="list-style-type: none">• This message disappears after data has finished loading.	–
PLEASE SET MY PROGRAM is displayed.	<ul style="list-style-type: none">• Register images for MY PROGRAM.	44, 45

*¹ CARD SETTING on the MENU screen is displayed in magenta and cannot be selected.

*² Desired operations may be selected after data has been loading from the card.

SPECIFICATIONS

Items	Model	LC-20B1U
LCD panel		19.7" Advanced Super View & BLACK TFT LCD
Number of dots		921,600 dots VGA
Video color systems		N358, N443, PAL, PAL-M, PAL-N, SECAM, PAL-60
TV function	Destination	USA/Latin A/Twn
	TV Standard (CCIR)	NTSC/PAL-M/PAL-N
	TV Tuning System	PLL 181 ch.
	STEREO	MTS+SAP
	CATV	125 ch.
3 Dimensional Y/C separation circuit		Yes (N358 only)
Digital comb filter		Yes
Brightness		430 cd/m ²
Lamp life		60,000 hours
Viewing angles		H: 170° V: 170°
Audio amplifier		2.5 W × 2
Speakers		ø 2 in. (5 cm), 2 pcs.
Terminals	AV1	AV-IN1, S-VIDEO-IN
	AV2	AV-IN2/AV-OUT
	COMPONENT	COMPONENT-IN, AUDIO-IN
	Antenna	F-Type
	Headphone	Mini-jack for stereo (3.5 ø)
	PC Card slot	PC Card Type II (PC card adapter)
Image File Format		JPEG files complying with DCF format.
OSD language		English/French/Spanish
Power supply		DC 13 V, AC 110–240 V, 50/60 Hz
Weight		19 lbs (8.6 kg), w/o accessories
Accessories		Remote control, Batteries, Antenna cable, AC adapter, AC cord, Cable clamps

As a part of policy of continuous improvement, SHARP reserves the right to make design and specification changes for product improvement without prior notice. The performance specification figures indicated are nominal values of production units. There may be some deviations from these values in individual units.



DIMENSIONAL DRAWINGS

Unit: inch/mm

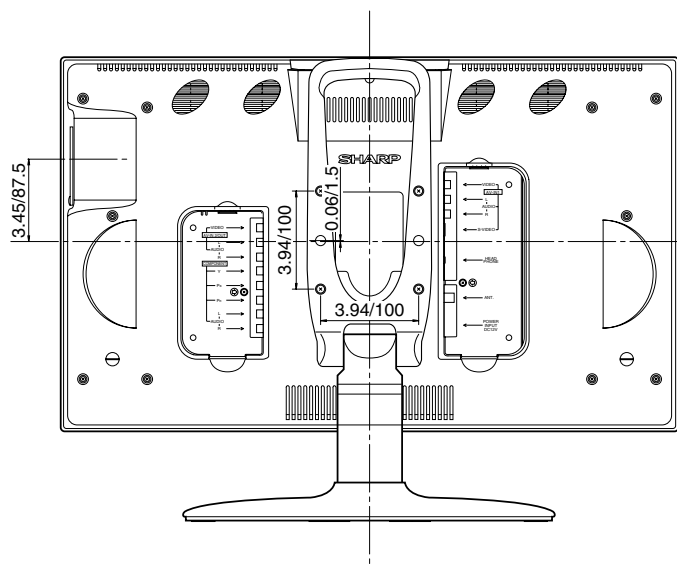
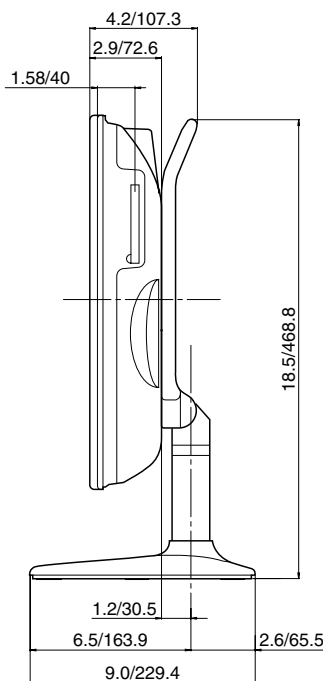
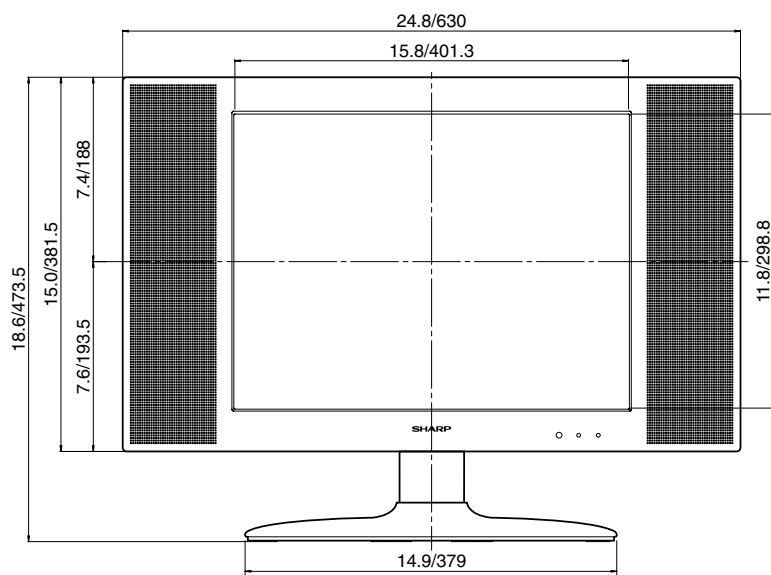
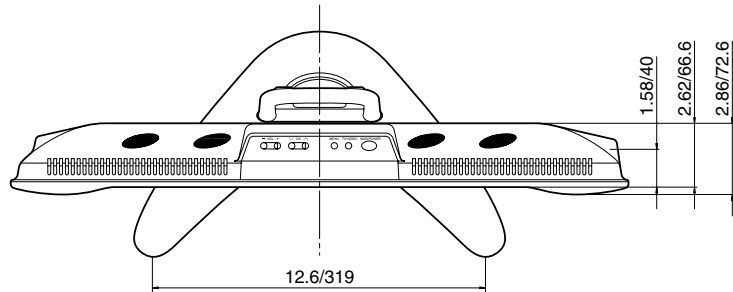

CALLING FOR SERVICE

For location of the nearest Sharp Authorized Service, or to obtain product literature, accessories, supplies, or customer assistance, please call 1-800-BE-SHARP.

LIMITED WARRANTY

END-USER LIMITED WARRANTY

SHARP ELECTRONICS CORPORATION warrants to the first end user purchaser that this Sharp brand product (the "Product"), when shipped in its original container, will be free from defective workmanship and materials, and agrees that it will, at its option, either repair the defect or replace the defective Product or part thereof with a new or remanufactured equivalent at no charge to the purchaser for parts or labor for the period(s) set forth below.

This warranty does not apply to any appearance items of the Product nor to the additional excluded item(s) set forth below nor to any Product the exterior of which has been damaged or defaced, which has been subjected to improper voltage or other misuse, abnormal service or handling, or which has been altered or modified in design or construction.

In order to enforce the rights under this limited warranty, the purchaser should follow the steps set forth below and provide proof of purchase to the servicer.

To the extent permitted by applicable state law, the warranties set forth herein are in lieu of, and exclusive of, all other warranties, express or implied. Specifically, ALL OTHER WARRANTIES OTHER THAN THOSE SET FORTH ABOVE ARE EXCLUDED. ALL EXPRESS AND IMPLIED WARRANTIES INCLUDING THE WARRANTIES OF MERCHANTABILITY, FITNESS FOR USE, AND FITNESS FOR A PARTICULAR PURPOSE ARE SPECIFICALLY EXCLUDED. If, under applicable state law, implied warranties may not validly be disclaimed or excluded, the duration of such implied warranties is limited to the period(s) from the date of purchase set forth below.

Neither the sales personnel of the seller nor any other person is authorized to make any warranties other than those described herein, or to extend the duration of any warranties beyond the time period described herein on behalf of Sharp.

The warranties described herein shall be the sole and exclusive warranties granted by Sharp and shall be the sole and exclusive remedy available to the purchaser. Correction of defects, in the manner and for the period of time described herein, shall constitute complete fulfillment of all liabilities and responsibilities of Sharp to the purchaser with respect to the Product, and shall constitute full satisfaction of all claims, whether based on contract, negligence, strict liability or otherwise. In no event shall Sharp be liable, or in any way responsible, for any damages or defects in the Product which were caused by repairs or attempted repairs performed by anyone other than an authorized servicer. Nor shall Sharp be liable or in any way responsible for any incidental or consequential economic or property damage. Some states do not allow limits on warranties or on remedies for breach in certain transactions; in such states, the limits herein may not apply.

Model Specific Section

<u>Your Product Model Number & Description:</u>	LC-20B1U LCD Color Television (Be sure to have this information available when you need service for your Product.)
<u>Warranty Period for this Product:</u>	One (1) year parts and labor from the date of purchase.
<u>Additional Item(s) Excluded from Warranty Coverage (if any):</u>	None
<u>Where to Obtain Service:</u>	From a Sharp Authorized Servicer located in the United States. To find the location of the nearest Sharp Authorized Servicer, call Sharp toll free at 1-800-BE-SHARP.
<u>What to do to Obtain Service:</u>	Ship prepaid or carry in your Product to a Sharp Authorized Servicer. Be sure to have Proof of Purchase available. If you ship the Product, be sure it is insured and packaged securely.

TO OBTAIN PRODUCT INFORMATION, CALL 1-888-LCD-SHARP.

SHARP[®]
SHARP ELECTRONICS CORPORATION
 Sharp Plaza, Mahwah, New Jersey 07430-2135
SHARP CORPORATION

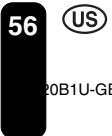

VALID IN CANADA ONLY

SHARP®

LIMITED WARRANTY

Consumer Electronics Products

Congratulations on your purchase!

Sharp Electronics of Canada Ltd. (hereinafter called "Sharp") gives the following express warranty to the first consumer purchaser for this Sharp brand product, when shipped in its original container and sold or distributed in Canada by Sharp or by an Authorized Sharp Dealer:

Sharp warrants that this product is free, under normal use and maintenance, from any defects in material and workmanship. If any such defects should be found in this product within the applicable warranty period, Sharp shall, at its option, repair or replace the product as specified herein.

This warranty shall not apply to:

- (a) Any defects caused or repairs required as a result of abusive operation, negligence, accident, improper installation or inappropriate use as outlined in the owner's manual.
- (b) Any Sharp product tampered with, modified, adjusted or repaired by any party other than Sharp, Sharp's Authorized Service Centres or Sharp's Authorized Servicing Dealers.
- (c) Damage caused or repairs required as a result of the use with items not specified or approved by Sharp, including but not limited to head cleaning tapes and chemical cleaning agents.
- (d) Any replacement of accessories, glassware, consumable or peripheral items required through normal use of the product including but not limited to earphones, remote controls, AC adapters, batteries, temperature probe, stylus, trays, filters, belts, ribbons, cables and paper.
- (e) Any cosmetic damage to the surface or exterior that has been defaced or caused by normal wear and tear.
- (f) Any damage caused by external or environmental conditions, including but not limited to transmission line/power line voltage or liquid spillage.
- (g) Any product received without appropriate model, serial number and CSA/cUL markings.
- (h) Any products used for rental or commercial purposes.
- (i) Any installation, setup and/or programming charges.

Should this Sharp product fail to operate during the warranty period, warranty service may be obtained upon delivery of the Sharp product together with proof of purchase and a copy of this LIMITED WARRANTY statement to an Authorized Sharp Service Centre or an Authorized Sharp Servicing Dealer. In home warranty service may be provided at Sharp's discretion on any Sharp television with the screen size of 27" or larger and on any Sharp Over-the-Range Microwave Oven.

This warranty constitutes the entire express warranty granted by Sharp and no other dealer, service centre or their agent or employee is authorized to extend, enlarge or transfer this warranty on behalf of Sharp. To the extent the law permits, Sharp disclaims any and all liability for direct or indirect damages or losses or for any incidental, special or consequential damages or loss of profits resulting from a defect in material or workmanship relating to the product, including damages for the loss of time or use of this Sharp product or the loss of information. The purchaser will be responsible for any removal, reinstallation, transportation and insurance costs incurred. Correction of defects, in the manner and period of time described herein, constitute complete fulfillment of all obligations and responsibilities of Sharp to the purchaser with respect to the product and shall constitute full satisfaction of all claims, whether based on contract, negligence, strict liability or otherwise.

WARRANTY PERIODS:

	Parts & Labour (exceptions noted)
Audio Products	1 year
Camcorder	1 year
DVD Products	1 year
LCD Projector	1 year (lamp 90 days)
LCD TV	1 year
Microwave Oven	2 years (magnetron component-3 additional years)
Television Products	1 year (picture tube component-1 additional year)
VCR Product	1 year
Vacuum Cleaner	1 year

To obtain the name and address of the nearest Authorized Sharp Service Centre or Dealer, please contact:
SHARP ELECTRONICS OF CANADA LTD. 335 Britannia Road East Mississauga, Ontario L4Z 1W9

For more information on this Warranty, Sharp Extended Warranty Offers, Sharp Canada Products, Accessory Sales, Dealer or Service Locations, Tronto please call (905) 568-7140
Visit our Web site: www.sharp.ca





Free Manuals Download Website

<http://myh66.com>

<http://usermanuals.us>

<http://www.somanuals.com>

<http://www.4manuals.cc>

<http://www.manual-lib.com>

<http://www.404manual.com>

<http://www.luxmanual.com>

<http://aubethermostatmanual.com>

Golf course search by state

<http://golfingnear.com>

Email search by domain

<http://emailbydomain.com>

Auto manuals search

<http://auto.somanuals.com>

TV manuals search

<http://tv.somanuals.com>