

# SHARP®

MODEL

# UX-600M

**MULTIFUNCTION  
FACSIMILE**

OPERATION MANUAL

1. Installation
2. Initial Settings
3. Sending Documents
4. Receiving Documents
5. Making Copies
6. Making Telephone Calls
7. Answering Machine Hookup
8. Special Functions
9. Optional Settings
10. Printing Reports and Lists
11. Maintenance
12. Troubleshooting

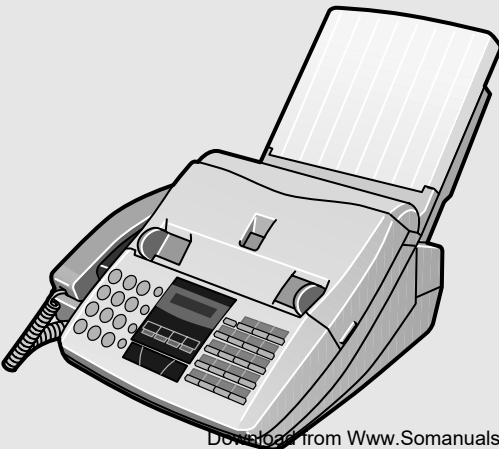

**WARNING** — FCC Regulations state that any unauthorized changes or modifications to this equipment not expressly approved by the manufacturer could void the user's authority to operate this equipment.

**Note:** This equipment has been tested and found to comply with the limits for a Class B digital device, pursuant to Part 15 of the FCC Rules.

These limits are designed to provide reasonable protection against harmful interference in a residential installation.

This equipment generates, uses and can radiate radio frequency energy and, if not installed and used in accordance with the instructions, may cause harmful interference to radio communications. However, there is no guarantee that interference will not occur in a particular installation. If this equipment does cause harmful interference to radio or television reception, which can be determined by turning the equipment off and on, the user is encouraged to try to correct the interference by one or more of the following measures:

- Reorient or relocate the receiving antenna.
- Increase the separation between the equipment and the receiver.
- Connect the equipment into an outlet on a circuit different from that to which the receiver is connected.

When connecting this facsimile equipment to a personal computer via the accompanying PC Interface Box, only the provided RS232C cable and modular jack cable are to be used.

## ABOUT THE TELEPHONE CONSUMER PROTECTION ACT OF 1991

"The Telephone Consumer Protection Act of 1991 makes it unlawful for any person to use a computer or other electronic device to send any message via a telephone facsimile machine unless such message clearly contains in a margin at the top or bottom of each transmitted page or on the first page of the transmission the following information:

- (1) The date and time of transmission.
- (2) Identification of either the business, business entity or individual sending the message.
- (3) Telephone number of either the sending machine, business, business entity or individual.

In order to program this information into your facsimile machine, please refer to the appropriate instructions in the operation manual."



As an ENERGY STAR<sup>®</sup> partner, SHARP has determined that this product meets the ENERGY STAR<sup>®</sup> guidelines for energy efficiency.

### FOR YOUR RECORDS

Please record the model number and serial number below, for easy reference, in case of loss or theft. These numbers are located on the rear side of the unit. Space is also provided for other relevant information.

Model Number \_\_\_\_\_

Serial Number \_\_\_\_\_

Date of Purchase \_\_\_\_\_

Place of Purchase \_\_\_\_\_

# Quick Reference Guide

## Installation

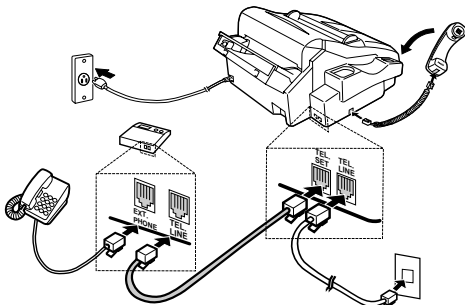

1. Connect the handset as shown.
2. Plug one end of the telephone line into the TEL. LINE jack on the rear of the fax, and the other end into your telephone wall jack.
3. Plug the power cord into a grounded, 120 V outlet.

### Installation with an answering machine and/or extension telephone

4. Remove the seal covering the TEL. SET jack on the rear of the fax. Connect an extension telephone or answering machine to the TEL. SET jack.
5. If desired, connect an extension phone to the answering machine.

## Entering your name and number

FCC regulations require your name and fax number to appear on all documents you send. To program your fax to do this automatically, follow the steps below:

1. Press the **FUNCTION** key and then press "3".



ENTRY MODE will appear in the display.

2. Press the "#" key twice: 

OWN NUMBER SET will appear in the display.

3. Press the **START** key: 

4. Enter your fax number (max. of 20 digits) by pressing the number keys.

◆ If you make a mistake, press the **HOLD/SEARCH** key to move the cursor back to the mistake, then enter the correct number or letter. (To move the cursor forward, press the **SPEAKER** key.)

5. Press the **START** key: 

6. Enter your name by pressing the appropriate number keys as shown below. Press each key one or more times until the desired letter appears in the display.

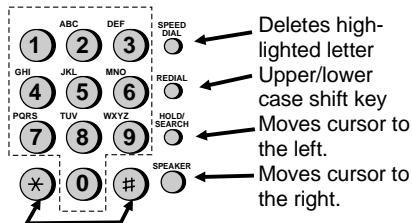

Press either key one or more times to select and enter a symbol.

- ◆ Enter a space with the "1" key.
- ◆ To enter two letters in succession which require using the same key, press the **SPEAKER** key after entering the first letter.

Example: To enter "ABZ Co.", press:

"2" twice for the letter A,

Press **SPEAKER** to move the cursor to the right,

"2" three times for the letter B,

"9" five times for the letter Z,

"1" twice for a space,

"2" four times for the letter C,

Press **REDIAL** for a lower case letter,

"6" four times for the letter o,

"#" once for a period.

7. When finished, press the **START** key and then the **STOP** key.

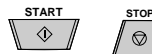

(See Pages 18-19 of your operation manual.)

# Quick Reference Guide

## Setting the date and time

To set the date and time, press the following keys:



DATE & TIME SET will appear in the display.

Press the **START** key:



Enter two digits for the Month (01 through 12).

Enter two digits for the Day (01 through 31).

Enter two digits for the Year (00 through 99).

Enter two digits for the Hour (01 through 12).

Enter two digits for the Minute (00 through 59).

Press the "\*" key for A.M. or the "#" key for P.M.

When finished, press the **START** key and then the **STOP** key:



(See Page 21 of your operation manual.)

## Storing and clearing numbers for automatic dialing

To store a new number or change an existing number, press the following sequence of keys:



FAX/TEL # MODE will appear in the display.

1. Press the "1" key:
2. Enter a 2-digit number (from "01" to "99") by pressing the number keys. This will be the Speed Dial number.
3. Enter the full telephone/fax number.
4. Press the **START** key:
5. Enter the name of the location by pressing number keys (max. of 20 characters).
6. Press the **START** key:
7. Return to Step 3 to store another number, or press **STOP** to exit.

To clear a Speed Dial number, press the following sequence of keys:



Press "2" and then enter the 2-digit Speed Dial number.

Press:

(See Pages 27-29 of your operation manual.)

## Sending documents



Place your document (up to 20 pages) face down in the document feeder.

### Normal Dialing

1. Lift the handset or press **SPEAKER**
2. Dial the fax number by pressing the number keys.
3. Wait for the reception tone (if a person answers, ask them to press their Start key).
4. Press your **START** key and then replace the handset.

### Rapid Key Dialing

Press the appropriate Rapid Key (if the Rapid Key is from 20 to 38, press the **SHIFT** key first). Transmission will begin.

### Speed Dialing

1. Press the **SPEED DIAL** key:
2. Enter the Speed Dial number by pressing the number keys.
3. Press:

### Direct Keypad Dialing

1. Enter the fax number by pressing the number keys.
2. Press:

(See Pages 37-39 of your operation manual.)

# Quick Reference Guide

## Receiving Documents

Press the **RECEPTION MODE** key until "AUTO" or "MANU" appears in the display.

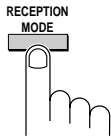

**AUTO reception:** The fax will automatically answer after four rings and receive the incoming document.

**MANUAL reception:** Lift the handset when the fax rings. If you hear a fax tone, wait until RECEIVING appears in the display, then hang up (if RECEIVING doesn't appear, press the **START** key). If the calling party talks to you, press your **START** key to begin reception.

(See Pages 42-43 of your manual.)

## Loading paper

1. Insert the paper tray into the fax if not yet installed.



2. Remove the paper cover if it is on the tray. (For legal paper, flip up the tray extender.)



3. Pull the paper release plate toward you.



◆ If any paper remains in the tray, take it out and combine it into a single stack with the new paper.

4. Insert the stack of paper into the tray. Replace the tray cover and then push the paper release plate back down.

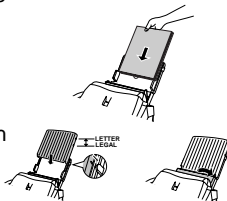

5. Press the following sequence of keys:



Press "1" if you loaded letter size paper, or "2" if you loaded legal size paper.

When finished, press:



(See pages 13-14 of your manual.)

## Installing the imaging film

1. Press the release marked **OPEN** and open the print compartment cover.



2. Insert two of the gears into the ends of the spool with film.



3. Hold the empty spool so that the end with only one slot is on the left, and lower the spools into the printing compartment so that the gears fit into the slots on each side of the compartment.

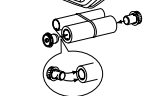

4. Cut the band holding the spools together with scissors, and remove it. Insert the remaining gear into the right end of the empty spool and the flange into the left end of the empty spool.



5. Pull the empty spool toward the back of the compartment, unwinding the leader from the spool with film. Insert the empty spool into the compartment so that the gear and spool fit into the slots on each side of the compartment.

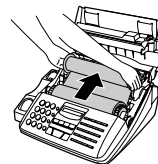

6. Wind the film slightly to remove slack and then close the printer compartment cover.



7. If you replaced the film, press the following sequence of keys (this is not necessary for the sample film included with the fax):



(See Pages 2-5 of your operation manual.)

# Quick Reference Guide

## FUNCTION key menu

The following chart shows the layout of the functions and settings accessed by pressing the **FUNCTION** key. First press the **FUNCTION** key, the appropriate numeric key as shown, and then "#" or "\*" until the desired item appears.

Instructions for making each setting appear in the display. If you have any difficulty, refer to the detailed instructions on the page shown below the setting.

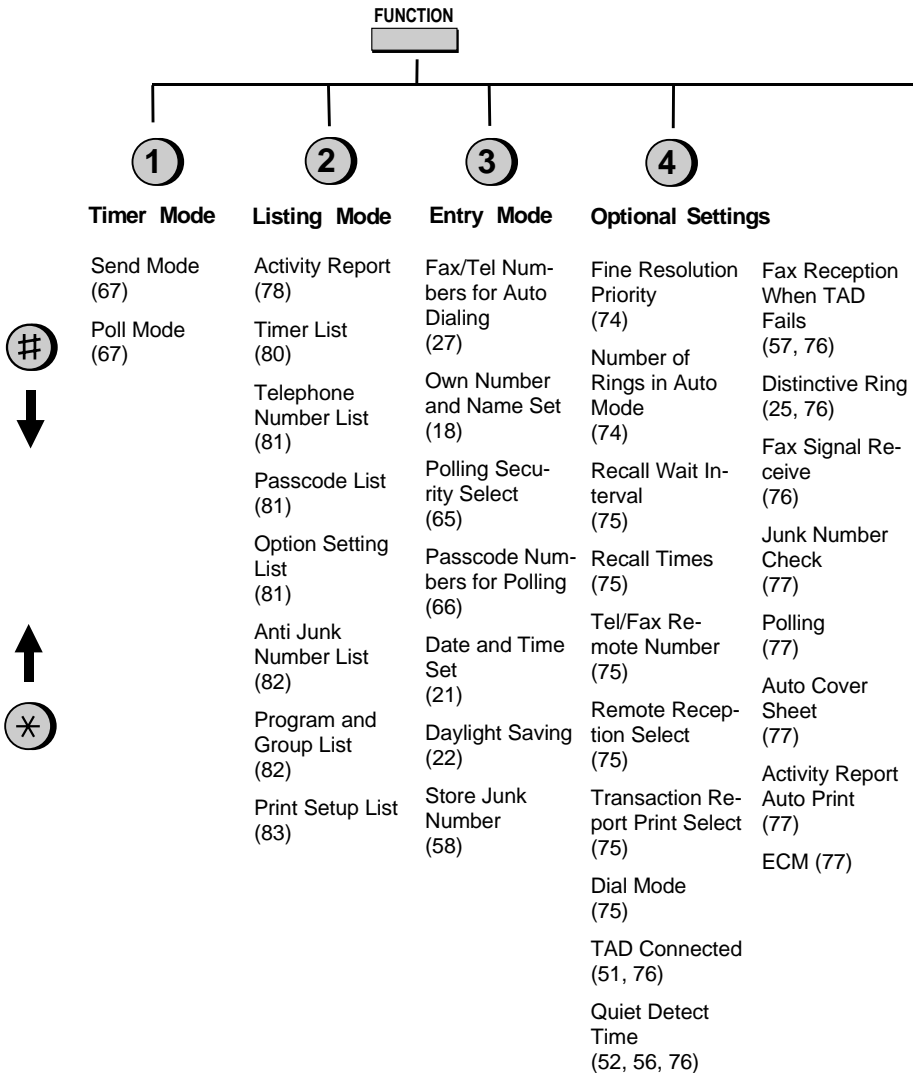

---

# Quick Reference Guide

5

## Cover Sheet

Cover Sheet  
Header  
(35)

6

## Print Set-up

Initialize Film  
(5)  
Reception Ratio  
(44)  
2 in 1 Print  
(44)  
Paper Type Set  
(14)  
Paper Size Set  
(14)  
Copy Cut-off  
(47)

7

## Program/Group

Program Entry  
Mode  
(69)  
Group Entry  
Mode  
(30)

---

# Introduction

Welcome to the UX-600M and thank you for choosing Sharp! The UX-600M is a multifunction facsimile machine that can also be used as convenience copier, scanner, and printer for your computer. Fax operations can be performed either from the operation panel of the UX-600M, or from your computer using the provided Multifunction Interface software.

This manual gives you easy-to-follow instructions for setting up the UX-600M, installing the Multifunction Interface software in your personal computer, and performing fax operations from the operation panel of the UX-600M. The Multifunction Interface operation manual on the CD-ROM gives you instructions for performing scan, print and fax operations from your computer.

If you have any questions or problems which cannot be solved by reading this manual, please contact Sharp's Customer Assistance Center. The number is 1-800-BE SHARP.

## **Important:**

- This facsimile machine is not designed for use on a line which has call waiting, call forwarding, or certain other special services offered by your telephone company. If you attempt to use the fax machine in conjunction with any of these services, you may experience errors during transmission and reception of facsimile messages.
- This fax machine is not compatible with digital telephone systems. No other fax machines may be connected to the same line.



## ***Important safety information***

- If your facsimile equipment is not operating properly, you should immediately remove it from your telephone line, as it may cause harm to the telephone network.
- The power outlet must be installed near the equipment and must be easily accessible.
- Never install telephone wiring during a lightning storm.
- Never install telephone jacks in wet locations unless the jack is specifically designed for wet locations.
- Never touch bare telephone wires or terminals unless the telephone line has been disconnected at the network interface.
- Use caution when installing or modifying telephone lines.
- Avoid using a telephone (other than a cordless type) during an electrical storm. There may be a remote risk of electric shock from lightning.
- Do not use a telephone to report a gas leak in the vicinity of the leak.
- Do not install or use the machine near water, or when you are wet. Take care not to spill any liquids on the machine.

### **Trademark acknowledgements:**

Microsoft, Windows, and Windows 95 are registered trademarks of Microsoft Corporation. TextBridge is a registered trademark of Xerox Corporation.

---

# **Table of Contents**

<b>1</b>	<b>Installation</b>	<b>1</b>
	Unpacking Checklist . . . . .	1
	Loading the Imaging Film . . . . .	2
	Connections . . . . .	6
	Installing the Multifunction Interface Software . . . . .	9
	Attachments . . . . .	12
	Loading Printing Paper . . . . .	13
<b>2</b>	<b>Initial Settings</b>	<b>15</b>
	Setup Guide . . . . .	15
	A Look at the Operation Panel . . . . .	16
	Entering Your Name and Fax Number . . . . .	18
	Entering Letters for Names . . . . .	19
	Setting the Date and Time . . . . .	21
	Selecting the Reception Mode . . . . .	23
	Distinctive Ring . . . . .	25
	Storing Numbers for Automatic Dialing . . . . .	27
	Volume Adjustment . . . . .	31
<b>3</b>	<b>Sending Documents</b>	<b>32</b>
	Transmittable Documents . . . . .	32
	Loading the Document . . . . .	33
	Optional Transmission Settings . . . . .	34
	Dialing and Transmission . . . . .	37
<b>4</b>	<b>Receiving Documents</b>	<b>42</b>
	Using Auto Mode . . . . .	42
	Using Manual Mode . . . . .	42
<b>5</b>	<b>Making Copies</b>	<b>45</b>
<b>6</b>	<b>Making Telephone Calls</b>	<b>48</b>

<b>7</b>	<b>Answering Machine Hookup</b>	<b>50</b>
	Using the Hookup . . . . .	50
	Optional Hookup Settings . . . . .	56
<b>8</b>	<b>Special Functions</b>	<b>58</b>
	Blocking Reception of Unwanted Faxes . . . . .	58
	Memory . . . . .	60
	Broadcasting . . . . .	62
	Polling (Requesting a Fax Transmission) . . . . .	64
	Timer Operations . . . . .	67
	Entering and Using Programs . . . . .	69
<b>9</b>	<b>Optional Settings</b>	<b>74</b>
<b>10</b>	<b>Printing Reports and Lists</b>	<b>78</b>
<b>11</b>	<b>Maintenance</b>	<b>84</b>
<b>12</b>	<b>Troubleshooting</b>	<b>86</b>
	Problems and Solutions . . . . .	86
	Messages and Signals . . . . .	89
	Clearing Paper Jams . . . . .	91
	<b>Specifications</b>	<b>93</b>
	<b>FCC Regulatory Information</b>	<b>97</b>
	<b>Guia de Consulta Rapida</b>	<b>98</b>
	<b>Index</b>	<b>101</b>



# Installation

## Unpacking Checklist

After unpacking your fax, make sure you have all the items shown below. If any are missing, contact your dealer or retailer.

Paper tray cover

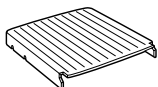

Paper tray

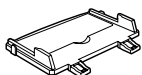

Handset



3 gears and  
1 flange



Original document support (located between box and packing case)



Sample imaging film

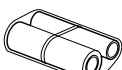

Rapid key labels



Operation manual



Handset cord



Telephone line cord

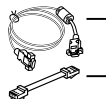

Multifunction Interface kit (two cables, PC Interface box, CD-ROM)

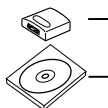

### Points to keep in mind when setting up

- ◆ The fax must be installed on a level surface.
- ◆ Keep the fax away from air conditioners, heaters, direct sunlight, and dust.
- ◆ Provide easy access to the front, back, and sides of the fax. In particular, keep the area in front of the fax clear, or the original document may jam as it comes out after scanning.
- ◆ If the fax is moved from a cold to a warm place, it is possible that condensation may form on the reading glass, preventing proper scanning of documents for transmission. To remove the condensation, turn on the power and wait approximately two hours before using the fax.
- ◆ If your area experiences a high incidence of lightning or power surges, we recommend that you install surge protectors for the power and telephone lines. Surge protectors can be purchased at most telephone specialty stores.

## Loading the Imaging Film

The printer unit in your fax creates printed text and images by applying heat to the imaging film, which causes ink to be transferred from the film to the page. Follow the steps below to install or replace the imaging film.

**1** Press the release marked **OPEN** and open the print compartment cover.

- **Caution!** The printing head (the strip of metal on the underside of the cover) applies heat to the imaging film. It may be hot if a document has just been printed.

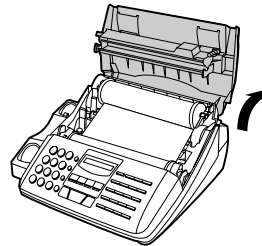
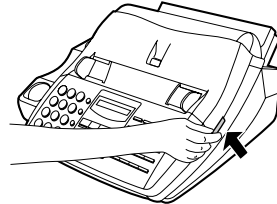

**2** If you are replacing the imaging film, take the old film out of the printing compartment and remove the three (3) green gears and the green flange from the ends of the spools.

**DO NOT DISCARD THE GREEN GEARS AND THE GREEN FLANGE!**

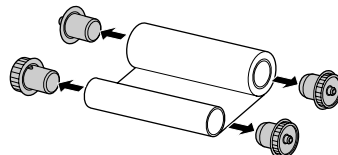
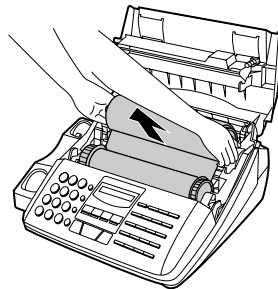

- 3** Take the new film out of its package, and insert two of the gears provided with the fax into the ends of the spool with film. Make sure that the two tabs on the gears fit properly into the slots in the ends of the spool.

- Do not yet remove the band which holds the spools together.

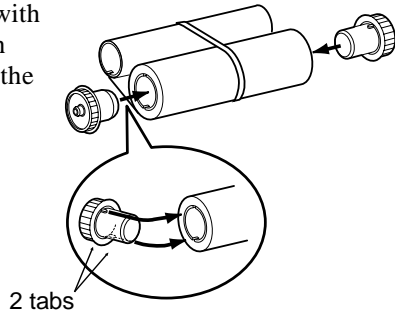

- 4** Hold the empty spool so that the end with only one slot is on the left, and lower the spools into the front of the printing compartment. The gears in the ends of the spool with film should fit into the slots on each side of the printing compartment.

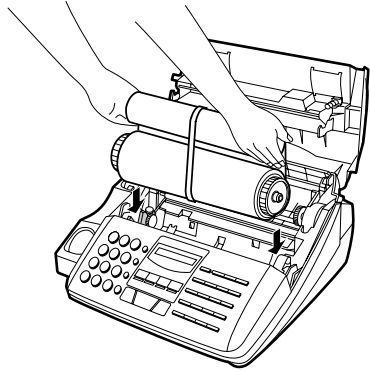

- 5** Cut the band which holds the spools together with scissors, and remove it. Insert the remaining gear into the right end of the empty spool and the flange into the left end of the empty spool. Make sure the tabs on the gear and the flange fit into the slots in the ends of the spool (the gear has two tabs and the flange has one tab).

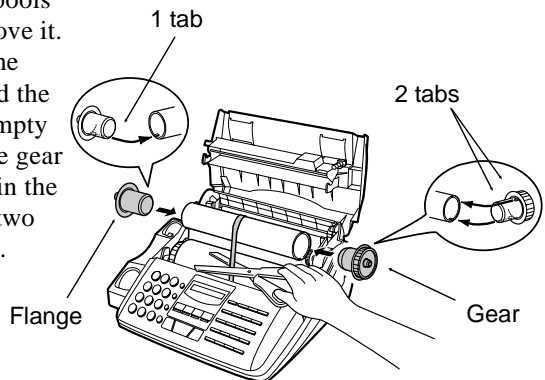

- 6** Pull the empty spool toward the back of the compartment, unwinding the film as you pull.

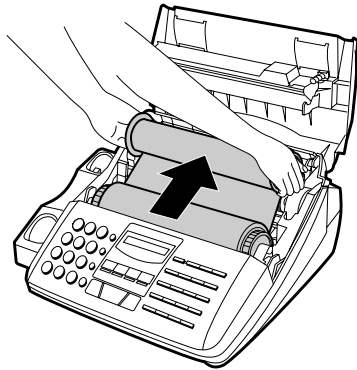

- 7** Insert the empty spool into the back of the compartment so that the gear and the flange fit into the slots on the sides of the compartment.

- Make sure that the gear engages with the gear below it.

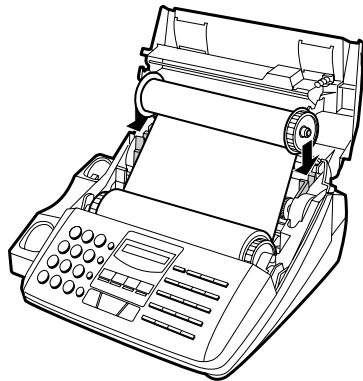

- 8** Wind the film slightly (rotate the gear on the right side of the empty spool) so that there is no slack in the film. Make sure that both edges of the film wind onto the spool evenly.

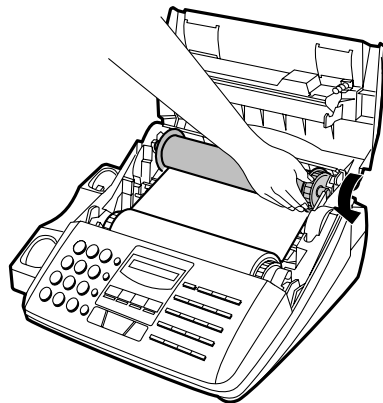



- 9** Close the print compartment cover, making sure it clicks into place.
- **Caution!** Close the cover slowly to make sure it doesn't pinch your fingers.

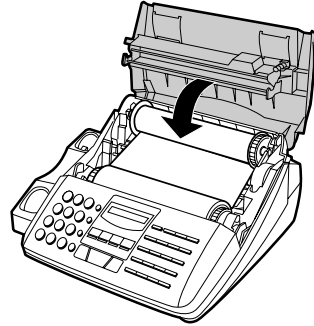

- 10** If you replaced the film, initialize the new film by pressing the **FUNCTION** key, the "6" key, and the "#" key on the operation panel. Make sure that INITIALIZE FILM appears in the display, and then press the **START** key. (Do not perform this step if you installed the initial sample roll of film.)

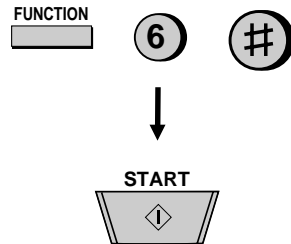

### ***When to replace the imaging film***

The sample roll of imaging film provided with your fax is capable of printing approximately 65 pages of letter size paper. When it is used up, FILM END will appear in the display. Replace it with the following imaging film, which is available at your dealer or retailer.

#### **UX-15CR Imaging Film**

One roll of UX-15CR imaging film is capable of printing approximately 500 pages of letter size paper when printed continuously.

#### ***Caution!***

The text of documents printed with the imaging film is visible on the used film. If confidential information has been printed, dispose of the film appropriately.

## Connections

Connect the power cord, telephone line cord, and handset as shown below. If desired, you can also connect an answering machine or an extension telephone to your fax.

- ◆ Connecting an answering machine to the fax will allow you to receive both voice and fax messages on the same line while you are out. For details on using this feature, see Chapter 7. (Note: Do not connect an answering machine to your fax if you will be using the distinctive ring feature described in Chapter 2.)
- ◆ You can connect an extension phone to the fax to make and receive calls like any other extension phone on your line. For details on receiving faxes from an extension phone, see Chapter 4, "Receiving Documents".

- 1** Plug the power cord into a 120 V, 60 Hz, grounded (3-prong) outlet.

**Caution:** Do not plug the power cord into any other kind of outlet. This will damage the machine and is not covered under the warranty.

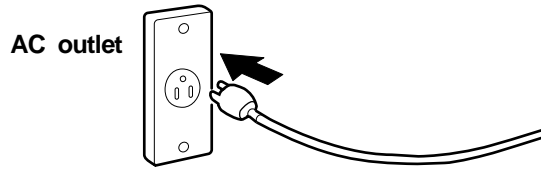

- 2** To connect an answering machine or extension phone to the fax, first remove the seal covering the **TEL. SET** jack on the fax, and then insert the line for the answering machine or the extension phone into the **TEL. SET** jack. For an answering machine, the other end of the line should be connected to the answering machine's telephone line jack, not its extension phone jack.

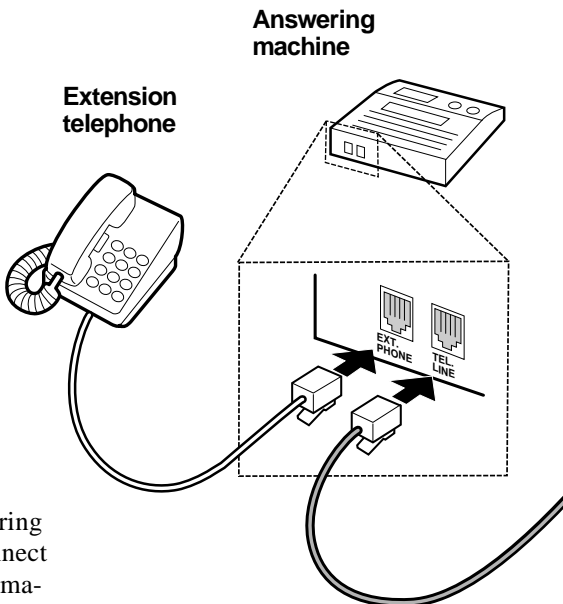

If desired, you can connect an answering machine to the fax first, and then connect an extension phone to the answering machine's extension phone jack.

- 3** Connect the handset as shown and place it on the handset rest.

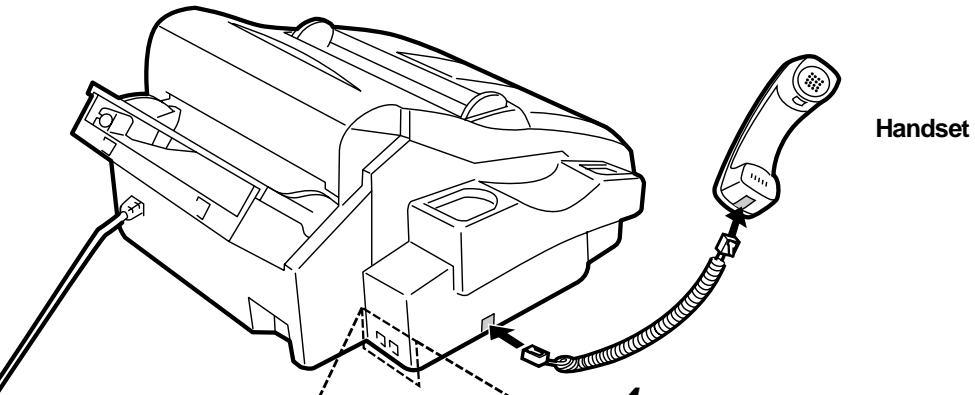

Handset

- 4** Insert one end of the telephone line cord into the **TEL. LINE** jack. Insert the other end into a standard (RJ11C) single-line telephone wall jack.

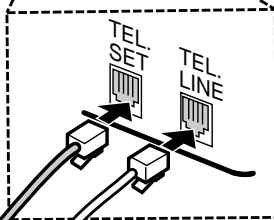

Be sure to insert the telephone line cord into the **TEL. LINE** jack. **Do not** insert it into the **TEL. SET** jack.



Wall jack

**Note:** Your fax is set for touch-tone dialing. If you are on a pulse dial (rotary) line, you must set the fax for pulse dialing by changing Option Setting 8. This procedure is described in Chapter 9, "Optional Settings".

## Connecting the fax to your computer

The Multifunction Interface kit which comes with your fax machine allows you to use your fax as a printer and scanner, and lets you perform fax operations from your computer via the fax modem in your fax machine. Follow the steps below to connect the PC Interface box and cables.

### Important:

Use only the provided interface cable and modular plug cable.

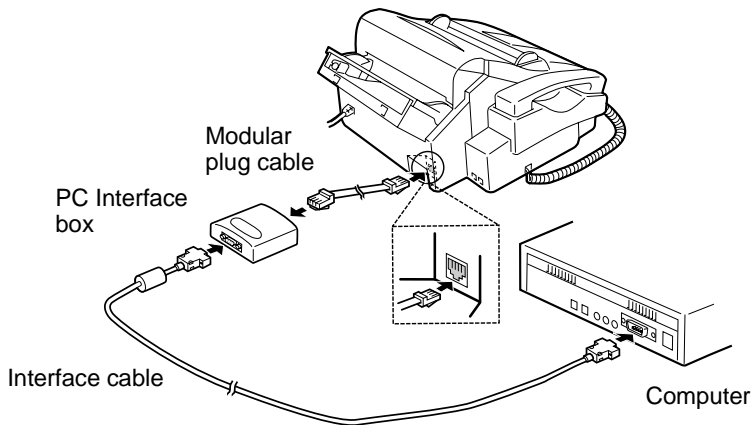

- 1** Make sure that your fax is unplugged and the power switch is turned off on your computer.
- 2** Insert the female end of the interface cable into the serial (RS232C) port on your computer. Tighten the screws with a screwdriver.
- 3** Insert the male end of the interface cable into the port on the PC Interface box. Tighten the screws with a screwdriver.
- 4** Insert one end of the modular plug cable into the jack on the PC Interface box, and the other end into the jack on your fax as shown (the ends of the cable are identical).

## ***Installing the Multifunction Interface Software***

The Multifunction Interface software allows you to perform fax operations from your computer and lets you use your fax as a scanner and printer. Install the software from your Sharp Multifunction Interface CD-ROM.

- ◆ You must be running Microsoft Windows<sup>(TM)</sup> 3.1 or higher, or Windows '95 to install the Sharp Multifunction Interface as a Windows application.
- ◆ For general information on installation and management of Windows' applications, refer to your Microsoft Windows User's Guide.

To install the Multifunction Interface software, follow these steps:

- 1** Make sure your fax is connected to your computer via the PC Interface box as described in "Connections" in this chapter.
- 2** Make sure your fax is powered on (plug in the power cord).
- 3** Run Windows<sup>(TM)</sup> 3.1 or higher, or Windows '95.
- 4** Close any other Windows applications which may be running.
- 5** Insert the Sharp Multifunction Interface CD in your computer's CD-ROM drive. (Note: Some systems automatically install the software when the CD is inserted in the CD-ROM drive. Advance to Step 7 if your system automatically installs the Multifunction Interface software.)
- 6 Windows 3.1 or higher users:**

Select the Windows Program Manager.

Select the *File* drop-down menu and select the *Run* command. The command screen will appear, displaying the command line. At the command line, type the letter of your CD-ROM drive followed by *Install.exe*, and click **OK**.

### **Windows '95 users:**

Select *Start*, and select *Run*. At the command line, type the letter of your CD-ROM drive and then click **OK**. Double click on the *Install.EXE* icon in the window that appears.

- ◆ If you have previously installed the Sharp Multifunction software, an opening screen will appear. Select the *Install Sharp* button.

- 7** From the Welcome screen, select *Next* to continue the installation process or *Cancel* to stop installation. Enter the Registration and Fax Cover Page information as requested, clicking *Next* until all information is complete.
- 8** The *Choose Destination Location* window will appear, displaying the *Destination Directory* dialog box. The *Destination Directory* text box contains the name of the system directory and the drive where program files will be stored. The default (and recommended) name for the directory is given as **Sharp**. If **Sharp** is used as the directory name, no action is required. The default drive is displayed as "C:\". However, you may select the Browse button to choose any other drive.
- 9** Select the *Next* button to advance or select *Back* to return to the previous screen. Selecting the *Cancel* button will stop the installation process.

  - A setup window will appear, and the name of the files being loaded and the percentage of completion will be displayed.
  - If a prompt appears stating "*Not Enough Disk Space Available*", it will be necessary to remove files so that the Multifunction Interface software can be properly installed.
- 10** A window will notify you that the *Autoexec.bat* and/or *Config.sys* and/or *Alacddm.ini*, and/or *Win.ini* have been modified. Select the **OK** button in each instance.
- 11** You will be prompted if you want your system to be ready to receive faxes when Windows is loaded. Respond by selecting **Yes** to have the *Inbox* automatically run when Windows is loaded.

After installation is complete, the *Sharp Multifunction Interface* group will be created.
- 12** The *Installation Complete* window will appear. Select **Yes** to restart your computer, and select *Finish* to complete the setup. (Note: You must reboot your system to run the Multifunction Interface software.)

All changes will now be in effect and you will be able to successfully run your Multifunction Interface software.

After your Sharp Multifunction Interface install is complete, you will return to the main installation screen. You now have the opportunity to try out the Xerox TextBridge<sup>®</sup> Pro enhanced OCR program included on your Sharp Multifunction Interface CD-ROM. Just click on the *Install TextBridge Pro* button for a 15-day free trial of this award winning software. If you would like to see a demo of this OCR software, click the *TB Pro Demo* button, or select the *TB Pro Info* button for more information on the OCR enhancements.

### ***Multifunction Interface software manual***

Instructions for using your Multifunction Interface software can be found in the Multifunction Interface Software Manual on the CD. Follow the steps below to access the manual:

- 1** Insert the Multifunction Interface CD in your computer's CD-ROM drive. (If the opening screen of the CD appears, click *EXIT* to close it.)
- 2** In the Sharp Multifunction Interface group on your Windows desktop, double click the *Operation Guide* icon.
- 3** When the Table of Contents appears, click on the chapter or section you wish to read. To turn pages, click the arrow buttons on the toolbar at the top of the screen.

## Attachments

Insert the paper tray into the back of the fax as shown.

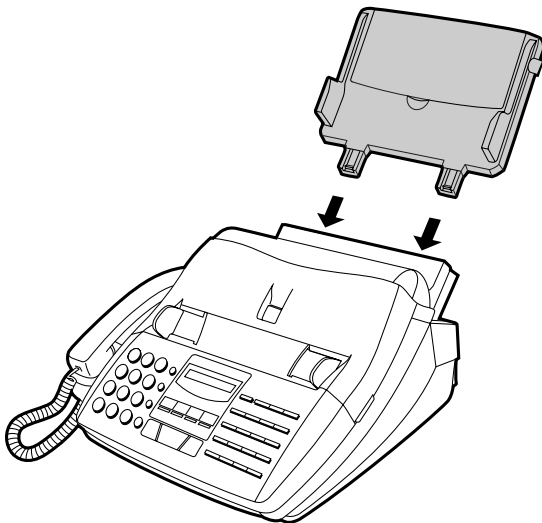

If desired, attach the original document support by inserting the ends into the holes in the bottom of the fax as shown.

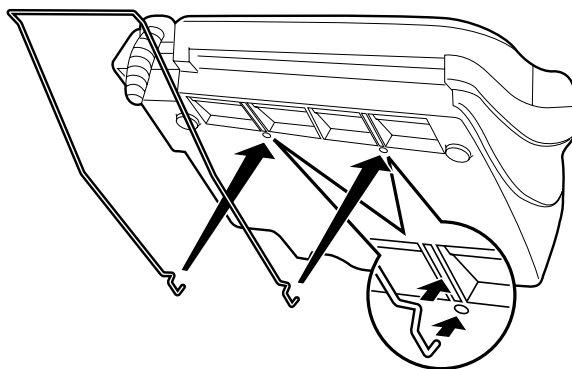



## Loading Printing Paper

The paper tray holds the paper on which received documents and copies are printed. Up to 200 sheets of letter or legal size paper from 16 to 20 lbs. (60 to 75 g/m<sup>2</sup>) can be loaded in the tray. Less sheets can be loaded when using heavier paper. The maximum allowed paper weight is 24 lbs. (90 g/m<sup>2</sup>).

**Note:** When receiving or copying documents, do not allow more than 100 pages to collect in the received document outlet. Otherwise, the outlet may become obstructed, causing paper jams.

- 1 Remove the paper cover if it is on the paper tray.

- If you are going to load legal size paper, flip up the paper tray extender.

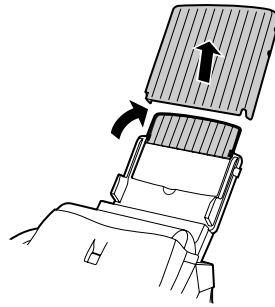

- 2 Fan the paper, and then tap the edge against a flat surface to even the stack.

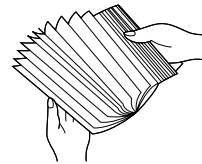

- 3 Pull the paper release plate toward you and insert the stack of paper into the tray, print side down.

- If paper remains in the tray, take it out and combine it into a single stack with the new paper before adding the new paper.

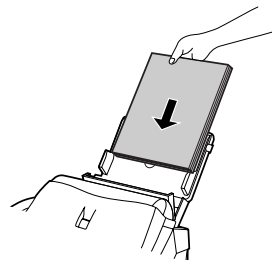
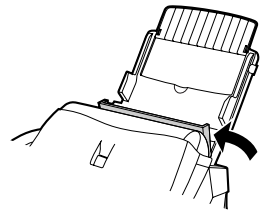

**4** Replace the paper cover on the paper tray and then push the paper release plate back down.

- **Important:** Be sure to replace the paper cover **before** you push the paper release plate down.

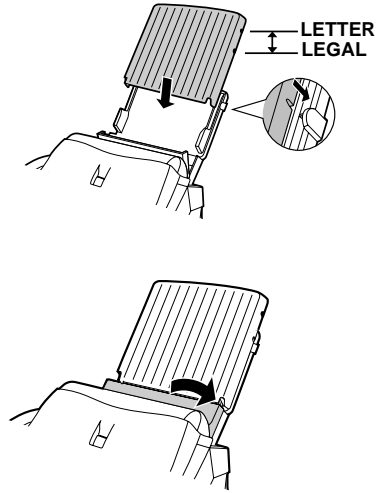

**5** Your fax has been set at the factory to scale the size of the printed image to letter size paper. If you have loaded legal paper, you must change this setting to legal. Press the **FUNCTION** key, the "**6**" key, the "**\***" key twice, and then press "**1**" to select letter, or "**2**" to select legal. When finished, press the **STOP** key. Be sure to change this setting every time you change the paper size.

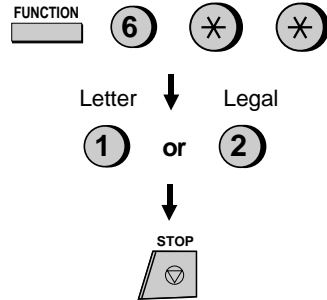

**6** Your fax has been set at the factory to print on regular paper. If you have loaded high quality thermal transfer paper, you must change this setting to **HIGH QUALITY**. Press the **FUNCTION** key, the "**6**" key, the "**\***" key three times, and then press "**1**" to select regular, or "**2**" to select high quality paper. When finished, press the **STOP** key. Be sure to change this setting again if you change back to regular paper.

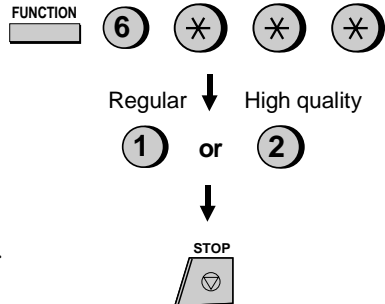

## Initial Settings

### Setup Guide

Before you can begin using your fax, there are some settings that must be made with the keys on the operation panel. Some of the settings are required for basic use of your fax, others may or may not be necessary depending on how you want to use the fax. The procedures for making the settings are described in this chapter in the order shown below.

#### **Required settings:**

- ◆ Entering your name and fax/telephone number in the fax
- ◆ Setting the fax to the current date and time
- ◆ Selecting the reception mode

#### **Settings which may be necessary:**

- ◆ **Distinctive ring:** If you subscribe to a distinctive ring service from your telephone company (this is a service which allows you to use several different devices, each with its own phone number and ring pattern, on one line), you will want to select a ring pattern for your fax.
- ◆ **Storing numbers for automatic dialing:** Automatic dialing allows you to dial a full fax or phone number by simply pressing a Rapid Key, or by pressing the **SPEED DIAL** key and entering a 2-digit number. To use automatic dialing, you must store the desired fax and phone numbers in the fax.
- ◆ **Volume:** Adjustment of the volume of the speaker, handset, and ringer.

## A Look at the Operation Panel

Before you make the settings, take a moment to familiarize yourself with the operation panel.

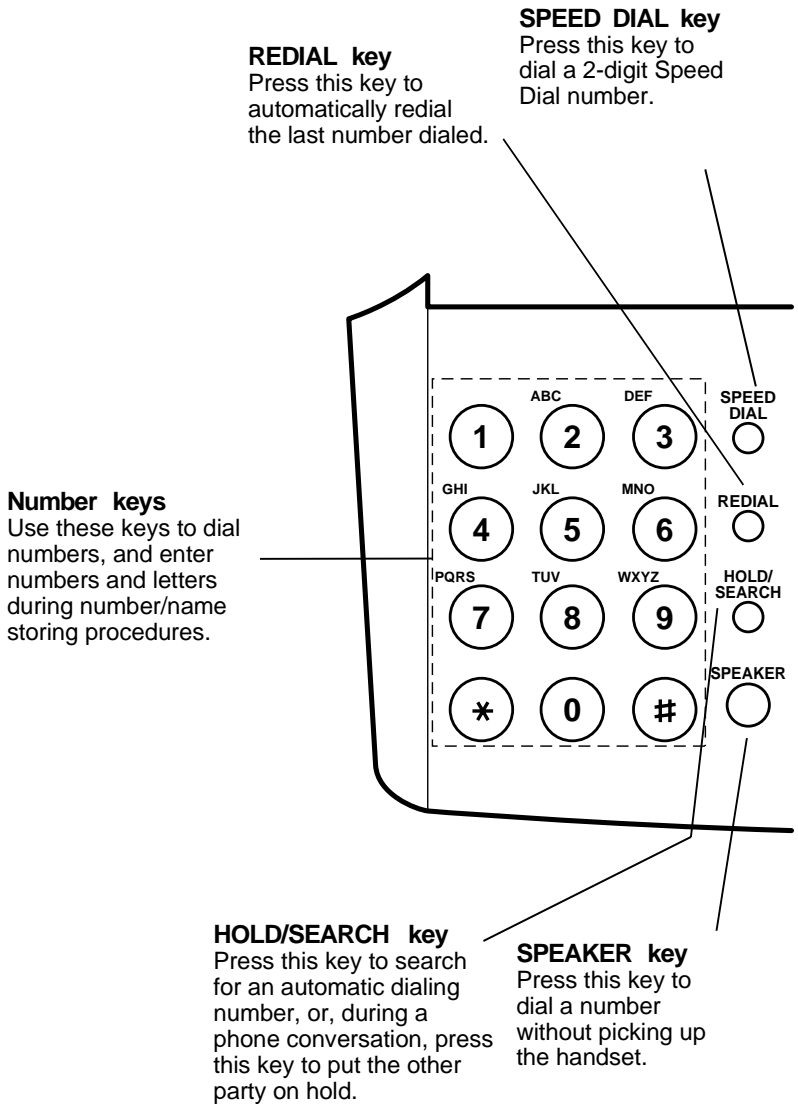

**VOLUME keys**

Press these keys to adjust the volume of the handset when the handset is lifted, the volume of the speaker when the **SPEAKER** key has been pressed, or the volume of the ringer at all other times.

**Display**

This displays various messages during operation and programming.

**FUNCTION key**

Press this key to select various special functions.

**RESOLUTION key**

Press this key to adjust the resolution and contrast before sending or copying a document.

**MEMORY key**

Press this key to scan a document into memory before transmitting it.

**Rapid Dial Keys**

Press one of these keys to dial a fax or voice number automatically. To dial the bottom number on a Rapid Key, press the **SHIFT** key before pressing the Rapid Key. (Note that you must attach the Rapid Key labels.)

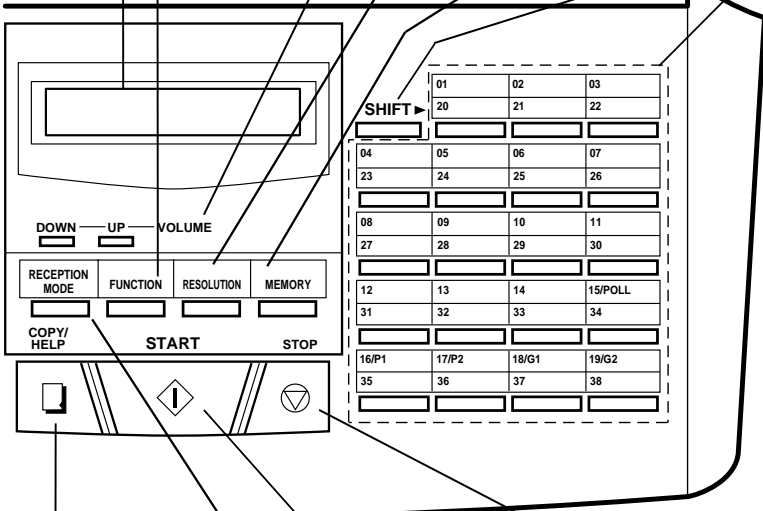

**COPY/HELP key**

When a document is in the feeder, press this key to make a copy. At any other time, press this key to print out the Help List, a quick reference guide to the operation of your fax.

**START key**

Press this key to send or receive a document.

**RECEPTION MODE key**

Press this key to select the mode of reception.

**STOP key**

Press this key to stop operations before they are completed.

## Entering Your Name and Fax Number

To have your name and fax/telephone number printed at the top of every page you transmit, program them by pressing the panel keys as shown below.

- ◆ You must program your name and fax number in order to comply with the Consumer Protection Act of 1991 (see inside of front cover).
- ◆ If you make a mistake, press the **HOLD/SEARCH** key to move the cursor back to the mistake, then enter the correct number or letter. (To move the cursor forward, press the **SPEAKER** key.)

- 
- 1** Press the **FUNCTION** key and then the "3" key. ENTRY MODE will appear in the display.



- 
- 2** Press the "#" key two times. OWN NUMBER SET will appear in the display.



- 
- 3** Press the **START** key.



- 
- 4** Enter your fax number (max. of 20 digits) by pressing the number keys. (To insert a space between digits, press the "#" key. To insert a "+", press the "\*" key.)



(Example)

- 
- 5** Press the **START** key.



- 
- 6** Note that there are letters marked above each of the number keys. Enter your name by pressing the appropriate number key for each letter several times until the letter appears in the display. (Max. of 24 characters.) For example, to enter "S" press "7" five times. See the following page for more details.

(Example: SHARP)

S: 7 7 7 7 7

H: 4 4 4

A: 2 2

R: 7 7 7 7

SPEAKER  
● (Move cursor)

P: 7 7

- 
- 7** Press the **START** key and then the **STOP** key.



## Entering Letters for Names

Names are programmed by pressing the number keys. You will notice that letters are marked above each of the number keys "2" through "9". To enter a letter (or number), press the appropriate key one or more times until the letter appears in the display (the number will appear first, followed by the letters in the order marked above the key). The keys used for entering letters and editing are shown below.

### Comments:

- To enter two letters in succession which require using the same key, press the **SPEAKER** key after entering the first letter to move the cursor to the right.
- To change a letter, move the cursor using the **HOLD/SEARCH** key or the **SPEAKER** key to the letter and enter the desired letter. The new letter will replace the old one.

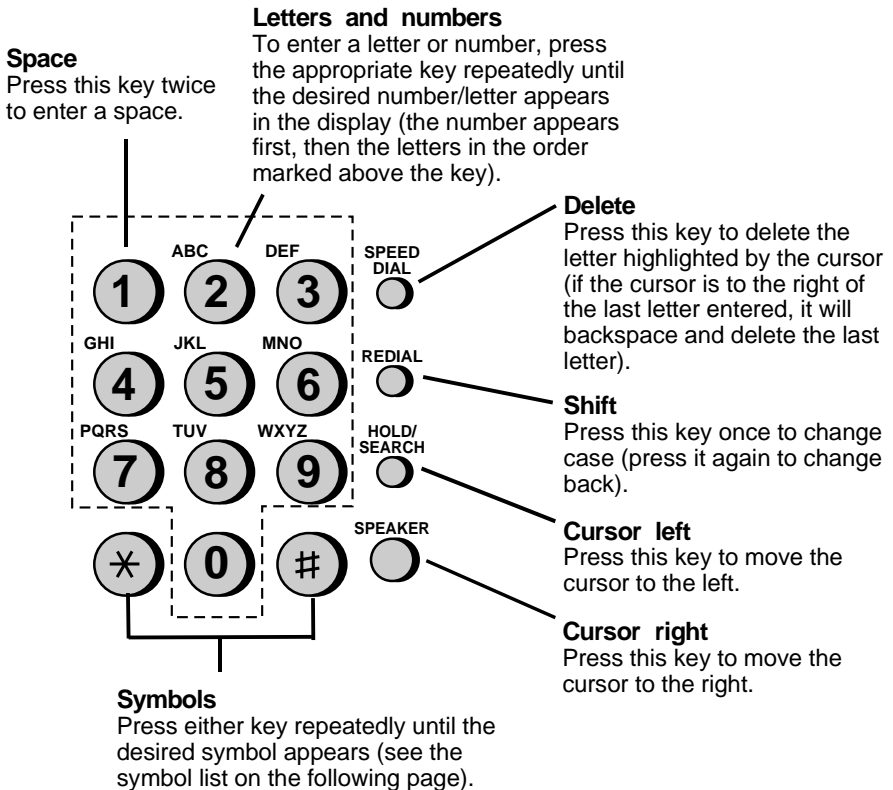

### Symbol list

































To enter a symbol from the list below, press the "#" key or the "\*" key repeatedly until the desired symbol appears.

# →	← *
. / ! " # \$ % & ' ( ) * + , - : ; < = > ? @ [ ¥ ] ^ _ ` {   } → ←	

### Example

The following is an example of entering the name "ABC Co. #1".

◆ The cursor in the display is indicated below by a rectangle:

Step	Press these keys:	Display
1	 	A <input type="text"/>
2		A <input type="text"/>
3	  	A B <input type="text"/>
4		A B <input type="text"/>
5	   	A B C <input type="text"/>
6	 	A B C <input type="text"/>
7	   	A B C <input type="text"/> C
8	    	A B C C <input type="text"/> o
9		A B C C o <input type="text"/> .
10	 	A B C C o . <input type="text"/>
11	    	A B C C o . <input type="text"/> #
12		A B C C o . # <input type="text"/> 1
13		



## Setting the Date and Time

The date and time appear in the display and reports, and are printed at the top of every page you transmit. Set the date and time by pressing the keys on the operation panel as shown below.

- ◆ To correct a mistake, press the **SPEED DIAL** key to move the cursor back to the mistake, and then enter the correct number.

- 1** Press the **FUNCTION** key and then the "3" key. ENTRY MODE will appear in the display.



- 2** Press the "\*" key three times. DATE & TIME SET will appear in the display.

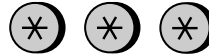

- 3** Press the **START** key.



- 4** Enter a two-digit number for the month ("01" for January, "02" for February, "12" for December, etc.).



(Example: January)

- 5** Enter a two-digit number for the day ("01" to "31").



(Example: the 5th)

- 6** Enter the last two digits of the year. (Note: In the year 2000, "00" will appear for the year.)



(Example: 1997)

- 7** Enter a two-digit number for the hour ("01" to "12") and a two-digit number for the minute ("00" to "59").



(Example: 9:25)

- 8** Press "\*" to select A.M., or "#" to select P.M.

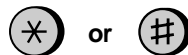

- 
- 9** Press the **START** key and then the **STOP** key.



### **Daylight Saving Time**

If desired, you can have the clock in your fax move forward and backward automatically at the beginning and end of Daylight Saving Time. To turn on this function, press the panel keys as follows:

- 
- 1** Press the **FUNCTION** key and then the "3" key. ENTRY MODE will appear in the display.



- 
- 2** Press the "\*" key two times. DAYLIGHT SAVING will appear in the display.



- 
- 3** Press "1" to turn on the Daylight Saving Time function, or "2" to turn it off.

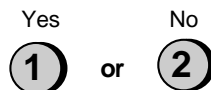

- 
- 4** Press the **STOP** key.



## Selecting the Reception Mode

Your fax has two modes for receiving incoming calls and faxes:

**AUTO mode:** In AUTO mode, the fax will automatically answer all calls after four rings and receive the incoming document.

**MANUAL mode:** In MANUAL mode, you must answer all calls, including fax messages, using the fax's handset or an extension phone connected to the same line.

If you only intend to receive fax messages on the line connected to your fax machine, select AUTO mode. In this case, you will probably want to change the number of rings your fax waits before answering to one or two rings. This is done by setting Option Setting 2 as described in Chapter 9, "Optional Settings".

If you intend to receive both fax messages and voice calls on the line connected to your fax machine, you can use either AUTO or MANUAL mode. In the case of AUTO mode, you must answer incoming calls before the fax does, but the fax will be able to receive fax messages at times when you are unable to answer personally. For more information on using AUTO and MANUAL modes, see Chapter 4, "Receiving Documents".

### Setting the reception mode

Set the mode of reception with the **RECEPTION MODE** key on the panel.

- To select AUTO, press the key until "AUTO" appears in the display.
- To select MANUAL, press the key until "MANU" appears in the display.

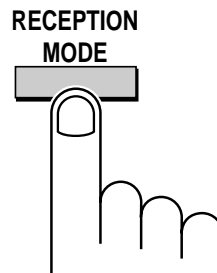

## Selecting the receiving unit

If you have connected the fax machine to a personal computer with the provided Multifunction Interface box, you can choose whether to have incoming faxes received to the fax machine or to your computer. The initial setting is FAX (reception to the fax machine). To change the setting, follow the steps below.

- 
- 1** Press the **FUNCTION** key and then the **"#"** key. **RECEIVE UNIT** will appear in the display.

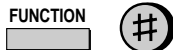

- 
- 2** Press **"1"** (FAX) to select the fax machine, or **"2"** (PC) to select your computer.

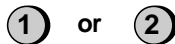

If you select reception to your computer, faxes will be received as follows depending on the reception mode of the fax machine:

- ◆ If the fax machine is set to **AUTO** reception mode, an incoming call will be automatically answered after the number of rings set in your fax software. The fax will be received by your computer (make sure your fax software is running). If your computer is turned off or the fax software is not running, the fax machine will receive the fax.
- ◆ If the fax machine is set to **MANUAL** reception mode, you must first answer a call by picking up the fax's handset. If the call is an auto-dialed fax transmission (you will hear a fax tone), your computer will automatically begin reception. If the other party speaks to you and then wants to send a fax, you must initiate fax reception manually with the fax software.

See the Multifunction Interface Software Manual for information on how to receive faxes with your fax software.

If you select reception to your fax machine, the reception modes will function as explained at the beginning of this section.

**Note:** Scanning, printing, and PC faxing can take place in all modes.

## ***Distinctive Ring***

Distinctive ring is a service offered by some local telephone companies which allows you to use up to four different telephone numbers, each with a different ring pattern, on your regular single line. If you subscribe to a distinctive ring service you can set your fax to automatically answer when it detects one of those ring patterns, allowing you to use the number corresponding to that pattern as an exclusive fax number.

### **Important:**

- To use distinctive ring, you must subscribe to a distinctive ring service from your local phone company. Do not make this setting if you do not subscribe to a distinctive ring service.
- Your fax may not be compatible with some distinctive ring services.

When using this feature, you must set the reception mode of your fax to AUTO as described in "Selecting the Reception Mode" in this chapter. When your designated fax number is dialed, your fax will automatically answer and begin reception after two rings. Note that other devices on the same line will also ring until your fax answers. If one of your other numbers is dialed, the fax will ring; however, it will not answer.

To use distinctive ring, select one of the ring patterns below for your fax by pressing the panel keys as shown on the following page. The selections are as follows:

1. RING PATTERN 1: Two short rings.
2. RING PATTERN 2: One short, one long, and one short ring.
3. RING PATTERN 3: Two short rings and one long ring.
4. STANDARD RING: Your standard (normal) ring pattern.
5. OFF SETTING: Answer all ring patterns (this turns distinctive ring off).

Your fax has been set to "5" at the factory.

---

**1** Press the keys shown at right.  
OPTION SETTING will appear in the display.



---

**2** Press the keys shown at right.  
DISTINCTIVE RING will appear in the display.

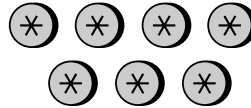

---

**3** Select a ring pattern by entering the appropriate number ("1" to "5" as shown in the list on the previous page).



(Example)

---

**4** Press the **STOP** key.



**Note:** If you are using an answering machine with your distinctive ring service, the answering machine must be connected to a separate wall jack. Do not connect it directly to your fax.

## Storing Numbers for Automatic Dialing

Automatic dialing is a quick and convenient way of dialing which is done by either pressing a Rapid Key (Rapid Key Dialing), or pressing the **SPEED DIAL** key and entering a 2-digit number (Speed Dialing). Automatic dialing can be used for both fax transmissions and voice calls.

To use automatic dialing, you must first store the full number in your fax and assign a 2-digit Speed Dial number to it. You can also enter a name which appears in the display when the number is dialed. Up to 99 numbers can be stored.

- ◆ Speed Dial numbers from "01" to "38" can be used for both Rapid Key Dialing and Speed Dialing; Speed Dial numbers from "39" to "99" can only be used for Speed Dialing.
- ◆ To allow easy identification of the Rapid Keys, attach each strip of Rapid Key labels above the appropriate row of Rapid Keys. The arrangement of the keys is shown in "A Look at the Operation Panel" in this chapter. Each time you store a number for Rapid Key Dialing, write the name of the party above the appropriate key.

### Storing numbers

#### Comments:

- You may need to add a pause between certain digits in the number to allow time for connection. For example, if you are on a PBX telephone system that requires an access number to be dialed (such as "9") to access an outside line, you will need to enter a pause between the access number and the telephone/fax number of the other party. Pauses are entered by pressing the **REDIAL** key (2 seconds per pause). Several pauses can be entered in a row.
- ◆ If you make a mistake, press the **HOLD/SEARCH** key to move the cursor back to the mistake, then enter the correct number or letter. (To move the cursor forward, press the **SPEAKER** key.)

- 
- 1** Press the keys shown at right.  
FAX/TEL. # MODE will appear in the display.

FUNCTION  

**3**

**#**

- 
- 2** Press "1" to select SET.

**1**

- 3** Enter a two-digit number (from "01" to "99") by pressing the number keys. This will be the Speed Dial number.



(Example)

- 4** Enter the fax or voice number by pressing the number keys (max. of 32 digits including pauses).



(Example)

- 5** Press the **START** key.



- 6** Enter the name of the location or party by pressing the appropriate number key for each letter several times until the letter appears in the display (max. of 20 characters). (See "Entering Letters for Names" in this chapter for more details.) If you don't want to enter a name, skip this step.

**S:** <sup>PQRS</sup> 7 <sup>PQRS</sup> 7 <sup>PQRS</sup> 7 <sup>PQRS</sup> 7 <sup>PQRS</sup> 7  
**H:** <sup>GHI</sup> 4 <sup>GHI</sup> 4 <sup>GHI</sup> 4  
**A:** <sup>ABC</sup> 2 <sup>ABC</sup> 2  
**R:** <sup>PQRS</sup> 7 <sup>PQRS</sup> 7 <sup>PQRS</sup> 7 <sup>PQRS</sup> 7  
**P:** <sup>PQRS</sup> 7 <sup>PQRS</sup> 7

 (Move cursor)  
 (Example: SHARP)

- 7** Press the **START** key.





- 8** Return to Step 3 to store another number, or press **STOP** to exit. If the number will be used for Rapid Key Dialing, you can write the name on the label above the appropriate Rapid Key.

**Step 3 or** 



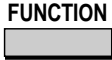

## Clearing numbers

- 1** Press the keys shown at right. FAX/TEL. # MODE will appear in the display.



- 2** Press "2" to select CLEAR.

- 3** Enter the Speed Dial number that you want to clear by pressing the number keys.



  
 (Example)
- 4** Press the **START** key.

- 5** Return to Step 3 to clear another number, or press **STOP** to exit.

Step 3 or 

## Making changes

To make changes in a number previously stored, repeat the storing procedure. Select the Speed Dial number for which you want to make changes in Step 3, and then change the number and/or name when they appear in the display (Steps 4 and 6, respectively).

Numbers and letters are changed as described in "Entering letters for names" in this chapter.

### ◆ A lithium battery keeps automatic dialing numbers in memory

Your fax uses a lithium battery to keep automatic dialing numbers and other programmed data in memory when the power is turned off. Battery power is consumed primarily when the power is off. With the power kept continuously off, the life of the battery is about 5 years. If the battery dies, have your dealer or retailer replace it. Do not try to replace it yourself.

## Storing numbers in Group Keys

Group Keys allow you to dial a group of fax numbers by simply pressing the appropriate Group Key once. They are convenient for the Broadcasting function, which is used to transmit a document to a group of fax machines.

Rapid Keys 18/G1 and 19/G2 can be programmed as Group Keys. To program or clear a Group Key, follow the steps below. Note that one key cannot be simultaneously programmed as both a Rapid Key and a Group Key.

- ◆ Up to 20 fax numbers can be stored in one Group Key.
- ◆ Only Speed Dial numbers can be stored in a Group Key. Full numbers cannot be stored.
- ◆ A Group Key cannot be cleared if it has been programmed into a Program Key. First clear the Program Key as described in "Entering and Using Programs" in Chapter 8, then clear the Group Key. If you need to check which Program Key the Group Key is used in, print out the Program and Group List as described in Chapter 10.

- 
- 1** Press the keys shown at right. GROUP ENTRY MODE will appear in the display.



- 
- 2** Press "1" to program a Group Key, or "2" to clear a Group Key.

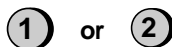

- 
- 3** Press a Group Key (Rapid Key 18/G1 or 19/G2) to select it. If you are clearing the key, go to Step 5.



- 
- 4** Enter the Speed Dial numbers of the receiving machines.

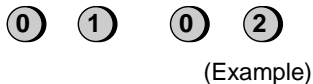

- 
- 5** Press the **START** key.



- 
- 6** Return to Step 3 to program or clear another Group Key, or press **STOP** to exit.

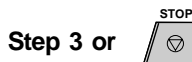

## ***Volume Adjustment***

You can adjust the volume of the speaker, handset, and ringer using the **UP** and **DOWN** keys on the operation panel.

### ***Speaker***

The speaker has three volume levels: **HIGH**, **MIDDLE**, and **LOW**. To adjust the volume of the speaker, press the **SPEAKER** key and then press the **UP** or **DOWN** key until the desired level appears in the display. Press the **SPEAKER** key again to turn the speaker off.

### ***Handset***

The handset receiver has two volume levels: **HIGH** and **MIDDLE**. To adjust the volume of the handset receiver, lift the handset and then press the **UP** or **DOWN** key until the desired level appears in the display.

### ***Ringer***

The ringer has four volume levels: **HIGH**, **MIDDLE**, **LOW**, and **OFF**. To adjust the volume of the ringer, press the **UP** or **DOWN** key until the desired level appears in the display (make sure the **SPEAKER** has not been pressed and the handset is not lifted). The fax will ring at the new volume level each time you change the level. If you select **OFF**, press the **START** key to confirm your selection.

## Sending Documents

### Transmittable Documents

Your fax can transmit most standard office documents. Specific guidelines are as follows:

#### Size and weight

The size and weight of documents which you can load in the document feeder depend on whether you load one sheet at a time or several sheets at once.

##### One sheet at a time:

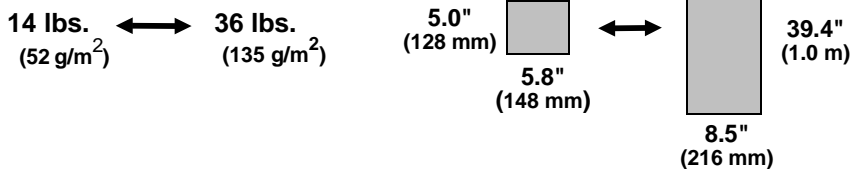

##### Several sheets at once:

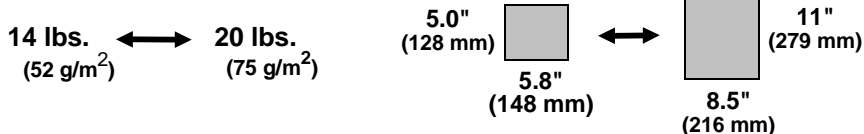

**Note:** The area of the document which is scanned by the fax is slightly smaller than the actual document size. The scanning width is 8.3 inches, and the scanning length is the length of the document minus 0.32 inches.

#### Other restrictions

- ◆ Documents written in yellow, greenish yellow, or light blue ink cannot be transmitted, as the scanner does not recognize these colors.
- ◆ Ink, glue, and correcting fluid on documents must be dry before they pass through the document feeder.
- ◆ All clips, staples, and pins must be removed from documents before transmission. If these are not removed, they may damage the fax.
- ◆ Documents which are patched, taped, torn, smaller than the minimum size, carbon backed, or easily smudged should be photocopied, and the copy used for transmission.

## Loading the Document

Up to 20 pages can be placed in the feeder at one time. The pages will be automatically fed into the fax starting from the page on the bottom.

- ◆ If you need to send or copy more than 20 pages, place the additional pages gently and carefully in the feeder just before the last page is scanned. Do not try to force them in, as this may cause double-feeding or jamming.
- ◆ If your document consists of several large or thick pages which must be loaded one at a time, insert each page into the feeder as the previous page is being scanned. Insert gently to prevent double-feeding.

- 
- 1** Adjust the document guides to the width of your document.

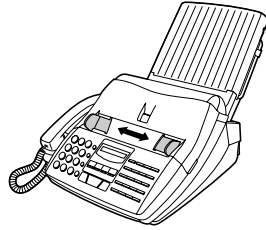

- 
- 2** Place the document face down and push it gently into the document feeder. The top edge of the document should enter the fax first.

- The feeder will draw the leading edge of the document into the fax. **READY TO SEND** will appear in the display.

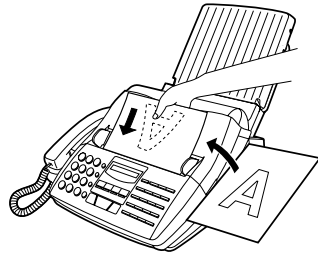

- 
- 3** You can now either make resolution and/or contrast settings as described in the following section, or dial the other party as described in the section, "Dialing and transmission".

### Important:

If you need to remove the document from the feeder before transmission or copying, first open the operation panel by pulling the front edge up (grasp it at the **PANEL RELEASE** mark), and then remove the document. If you try to pull the document out without opening the operation panel, you may damage the feeder mechanism.

## Optional Transmission Settings

If desired, there are several transmission settings which are possible before dialing and transmitting the document.

**Note:** To make the settings, the document must first be loaded in the feeder.

### Resolution

Your fax has 4 resolution settings. If you do not make a setting, the fax will automatically send the document in STANDARD resolution.

**STANDARD:** Use STANDARD for ordinary documents. This setting gives you the fastest and most economical transmission.

**FINE:** Use FINE for improved reproduction, especially with documents containing small letters or fine drawings.

**SUPER FINE:** Use SUPER FINE when you need the highest quality of reproduction.

**HALF TONE:** Use HALF TONE for photographs and illustrations. The original will be reproduced in 64 shades of gray.

**Note:** In order to transmit in SUPER FINE resolution, the receiving fax machine must also have that resolution. If it doesn't, your fax will automatically step down to the next best available setting.

### Contrast

The contrast is normally set to AUTO, which means that the fax automatically controls the contrast, but for faint documents you can change the setting to DARK.

### Setting the resolution and contrast

Press the **RESOLUTION** key one or more times until the desired resolution and contrast settings appear in the display.

- The first time you move through the list of resolution settings, the contrast setting AUTO will appear next to each resolution setting. The second time you move through the list, the contrast setting DARK will appear.

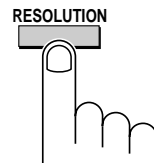

## Cover Sheet

You can have your fax generate a cover sheet and send it as the last page of the transmission. The cover sheet includes the date and time, the sender's name and number, and the receiver's name and number if an automatic dialing number is used. The total number of pages sent is indicated on the bottom.

- ◆ Your name and number must be programmed in order for them to appear on the cover sheet. (See "Entering Your Name and Fax Number" in Chapter 2.)

To include a cover sheet with each transmission, set Option Setting 16 to YES as described in Chapter 9, "Optional Settings". Note that once Option Setting 16 is set to YES, cover sheets will be automatically included with every transmission until you change the setting to NO.

When the cover sheet function is turned on, you can also select a message which will appear as a header at the top of the cover sheet. To do so, follow the steps below. Note that the message selection is only effective for one transmission.

- 1 Press the keys shown at right.  
COVER SHEET HEAD will appear in the display.

FUNCTION



5

- 2 Select a message by entering a number from "1" to "4" as shown below:  
"1": URGENT  
"2": IMPORTANT  
"3": CONFIDENTIAL  
"4": PLS. DISTRIBUTE

1

(Example)

### Example

```

URGENT
  AUTOMATIC COVER SHEET

DATE : MAY-22-96 01:12 PM
TO   : JONE SMITH
FAX # : 111-111-1111
FROM : John Doe Corp.
FAX # : 201 555 1234

  2 PAGES WERE SENT
<INCLUDING THIS COVER SHEET>
  
```

### **Batch Page Numbering**

This setting is used to change the page numbering of the transmitted document from simple numbering ("P.1", "P.2", etc.) to batch numbering, which means that a slash and the total number of pages being sent are added after each page number (for example, "P. 1/5", "P.2/5", etc.). This allows the receiver to check for any missing pages.

- ◆ If you are sending a cover sheet, **do not** include the cover sheet in the total number of pages. Your fax will adjust the number to include the cover sheet automatically.
- ◆ If you need to cancel a batch number entry, remove the document from the feeder or press the **STOP** key.
- ◆ If the number of pages actually transmitted does not coincide with the batch number entered, the alarm will sound and PAGE COUNT ERROR will appear in the display. "PAGE E." will also appear in the "NOTE" column of the Transaction Report if it has been set to print out.

---

**1** Press the keys shown at right.  
PAGE COUNTER SET will appear in the display.

FUNCTION



---

**2** Enter the total number of pages ("01" to "99") by pressing the number keys.



(Example)



## Dialing and Transmission

Once you have loaded the document and made any desired transmission settings, you are ready to dial the number of the receiving fax machine and transmit the document. There are several ways of dialing, and you can select the one which best suits your needs.

### Normal Dialing

With Normal Dialing, you pick up the handset (or press the **SPEAKER** key) and dial as you would to make a telephone call. If the receiving machine is set to receive faxes manually (this means that the receiving party answers your call by picking up the handset and speaking, and then presses their Start key to begin fax reception), you can talk with them before sending the fax.

- 1 Pick up the handset or press the **SPEAKER** key. Listen for the dial tone.

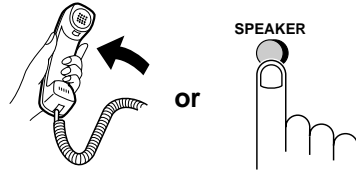

- 2 Dial the number of the receiving machine by pressing the number keys.

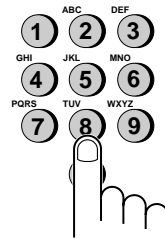

- 3 Wait for the connection. Depending on the setting of the receiving machine, you will either hear a facsimile reception tone or the other person will answer.

- If the other party answers, ask them to press their Start key (if you pressed the **SPEAKER** key, pick up the handset to speak with them). This causes the receiving machine to issue a reception tone.

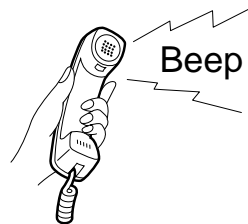

**4** When you hear the reception tone, press the **START** key. Replace the handset if you used it.

- When transmission is completed, the fax will beep.

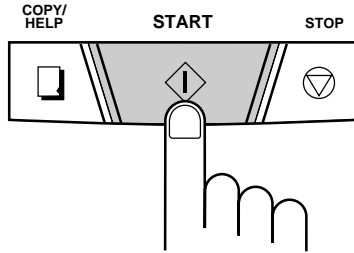

### Direct Keypad Dialing

If you do not need to talk with the other party before sending the fax, you can just dial; it isn't necessary to pick up the handset or press the **SPEAKER** key.

- ◆ Direct Keypad Dialing is a form of automatic dialing, so if you need to insert a pause between any digits of the number, press the **REDIAL** key. (For more information on pauses, see "Storing Numbers for Automatic Dialing" in Chapter 2.)

**1** Enter the number of the receiving machine by pressing the number keys.

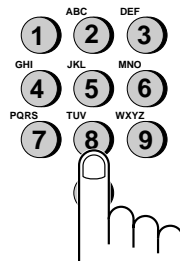

**2** Check the display. If the number of the receiving machine shown is correct, press the **START** key.

- If it is not correct, press the **STOP** key to backspace and clear one digit at a time, and then re-enter the correct digit(s).

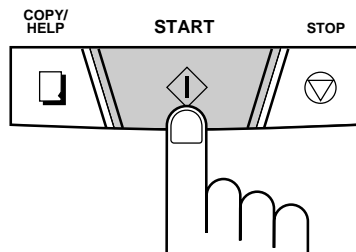

## Rapid Key Dialing

If the number you want to dial has been stored for automatic dialing as a Speed Dial number from 01 to 38 (see "Storing Numbers for Automatic Dialing" in Chapter 2), you can dial it by pressing the corresponding Rapid Key. (If the Speed Dial number is from 20 to 38, press the **SHIFT** key and then press the Rapid key.)

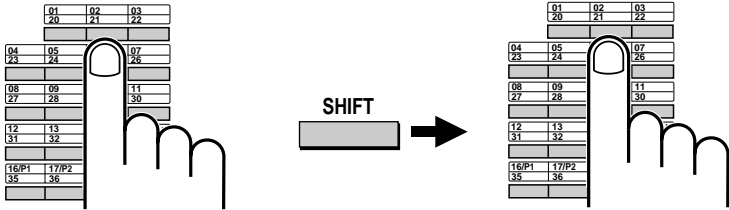

**Example:** To dial Speed Dial number "02", press Rapid Key 02/21.

**Example:** To dial Speed Dial number "21", press the **SHIFT** key and then press Rapid Key 02/21.

- ◆ The name of the receiving party will appear in the display. If no name was stored, the fax number will appear. (If the name or number is incorrect, press the **STOP** key.)
- ◆ The document will be automatically transmitted once the connection is made.

## Speed Dialing

Speed Dialing can be used to dial any number which has been stored for automatic dialing (see "Storing Numbers for Automatic Dialing" in Chapter 2).

- 1** Press the **SPEED DIAL** key and then enter the two digits of the Speed Dial number by pressing the number keys.

- To enter numbers 1 through 9, first enter 0 and then the number.

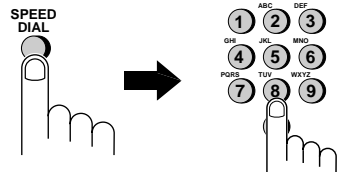

- 2** Check the display. If the name or number shown is correct, press the **START** key. (If not, press the **STOP** key and then repeat Step 1.)

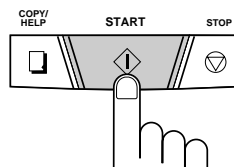

## Using the HOLD/SEARCH key

If you don't remember the Rapid Key or Speed Dial number in which you have stored a particular fax number, you can search for the number by following the steps below. Once you have found the number, you can dial it and transmit the loaded document by simply pressing the **START** key.

- 1** Press the **HOLD/SEARCH** key.

HOLD/  
SEARCH



- 2** Enter the first letter of the stored name by pressing the appropriate number key (the key below the marked letter) one or more times until the letter appears in the display. If the name begins with a special character or number, press "1".

- If you don't remember the first letter, go to Step 3 (you will scroll through the list from the beginning).
- If a name wasn't stored for the number, press "0". This will cause numbers, not names, to appear when you scroll.

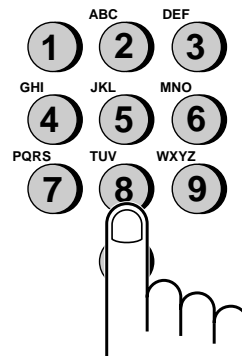

- 3** Press the **"#"** key or the **"\*"** key to scroll through the names (numbers if you pressed "0"). Stop when the desired name appears in the display.

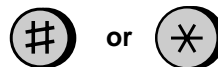

- If no names have been stored that begin with the entered letter, you will scroll from the next name, in alphabetical order, in the list. If no names/numbers have been stored at all, NO DATA will appear.

- 4** Press the **START** key. The document will be automatically transmitted once the connection is made.



### ***Automatic redialing***

If you use automatic dialing (including Direct Keypad Dialing) and the line is busy, your fax will automatically redial the number. Your fax was set at the factory to make 2 redialing attempts at intervals of 5 minutes.

- ◆ To stop automatic redialing, press the **STOP** key.
- ◆ If desired, you can change the number of times the fax redials to any number from 0 to 15 with Option Setting 4, and the interval at which redialing is done to any number of minutes from 1 to 15 with Option Setting 3. See Chapter 9, "Optional Settings".

### ***Using the REDIAL key***

You can press the **REDIAL** key to redial the last number dialed. To send a document, proceed from Step 3 of Normal Dialing. Note that the speaker will be automatically activated, so you do not need to pick up the handset immediately.

## Receiving Documents

### Using Auto Mode

When the reception mode is set to AUTO (press the **RECEPTION MODE** key until AUTO appears in the display), your fax automatically answers all calls on 4 rings and receives the incoming documents.

- ◆ You can change the number of rings on which the fax answers incoming calls by changing Option Setting 2 (see Chapter 9, "Optional Settings"). Any number from 1 to 5 can be selected. Note, however, that reception of auto-dialed faxes may not be possible from certain fax machines if you select a high number of rings.
- ◆ If you pick up the handset before your fax answers, you can talk to the other party and/or receive a document as described below in "Using Manual mode". For example, with the fax set to answer on 4 rings, you can receive both voice calls and fax messages in AUTO mode by answering before the fourth ring, but still have the fax answer calls automatically at times when you are unable to respond personally.

**Note:** If you are using distinctive ring, your fax will answer incoming calls after two rings regardless of the setting of Option Setting 2.

### Using Manual Mode

When the reception mode is set to MANUAL (press the **RECEPTION MODE** key until MANU appears in the display), you must answer all calls (including fax transmissions) using the fax's handset or an extension phone connected to the same line.

To receive a document on your fax machine, pick up the handset when it rings.

- If you hear a fax tone, wait until **RECEIVING** appears in the display, and then replace the handset.
- If the other party first talks to you and then wants to send a fax, press the **START** key after speaking (press your **START** key before the sender presses their Start key). Replace the handset.

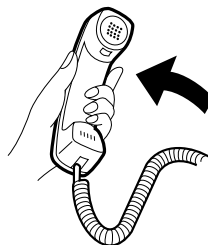

**Note:** If you have set Option Setting 13 (Fax Signal Receive) to NO and you hear a fax tone when you pick up the handset, you must press the **START** key to begin reception.

### ***Receiving documents on an extension phone***

If you hear a soft fax tone when you answer an extension phone, wait until your fax answers (the extension phone will go dead if it is connected to your fax, or you will hear pronounced high-pitched fax tones if the phone is connected to a separate wall jack), and then hang up. Your fax will automatically receive the document.

- ◆ If your fax does not respond within 5 seconds, noise on the line may be preventing it from detecting the fax tone. In this case, manually activate fax reception as described in the following paragraph.





If the other party first talks to you and then wants to send a document, press "5", "✳" and "✳" if you are on a touch tone phone. If you are on a pulse dial phone, set the handset down (do not hang up), walk over to the fax, pick up the handset, and press the **START** key.

#### **Comments:**



- Your fax will not accept the signal to begin reception ("5", "✳", and "✳") if a document is loaded in its feeder.
- If you have set Option Setting 13 to NO and hear a fax tone when you answer the extension phone, you must press "5", "✳", and "✳" if you are on a touch-tone phone, or walk over to the fax, pick up the handset, and press the **START** key if you are on a pulse dial phone.
- The code used to activate fax reception from a touch-tone extension phone ("5", "✳", and "✳") can be changed if desired. See Option Setting 5 ("Tel/Fax Remote Number") in Chapter 9, "Optional Settings".
- If you do not intend to use the code for activating fax reception, you can turn detection of the code off by resetting Option Setting 6. This will ensure that the fax never mistakenly attempts to begin reception if it detects a signal similar to "5", "✳", and "✳" while you are talking on an extension phone.

## 2 in 1 Print

To save paper, you can have the size of your incoming faxes reduced by 55%. This will allow you to receive, for example, a 2-page document on one page (note that this may not be possible if the document pages are longer than your printing paper). To turn on this function, follow the steps below.

- 
- 1 Press the keys shown at right.  
2 IN 1 PRINT will appear in the display.     

---

  - 2 Press "1" to turn on the function, or "2" to turn it off.  or 

---





  - 3 Press the **STOP** key. 

## Reception Ratio



Your fax has been set at the factory to automatically reduce the size of received documents to fit the size of the printing paper. This ensures that data on the edges of the document are not cut off. If desired, you can turn this function off and have received documents printed at full size.

**Note:** If a document is too long to fit on the printing paper, the remainder will be printed on a second page. In this case, the cut-off point may occur in the middle of a line.

**Note:** Automatic reduction may not be possible if the received document is too large, contains too many fine graphics or images, or is sent at high resolution. In this case, the remainder of the document will be printed on a second page.

- 
- 1 Press the keys shown at right.  
RECEPTION RATIO will appear in the display.    

---

  - 2 Press "1" to turn automatic reduction on, or "2" to turn it off.  or 

---

  - 3 Press the **STOP** key. 



## Making Copies

Your fax can also be used to make copies. Single and multiple copies (up to 99 per original) can be made, enabling your fax to double as an office copier.

- ◆ The default resolution for copying is SUPER FINE.
- ◆ If you are making multiple copies of more than one original, you can choose whether to have the copies sorted (SORT COPY) or not sorted (MULTI COPY). The following example shows how the copies are ordered in each case when 3 copies each of 3 originals are made.

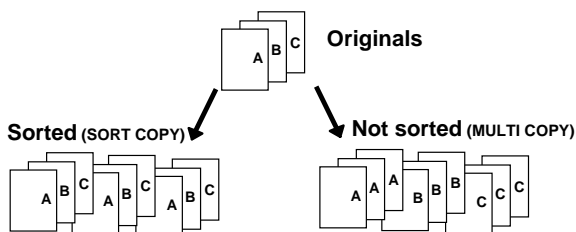

### 1 Load the document(s) face down.

- If desired, adjust the resolution and/or contrast with the **RESOLUTION** key.

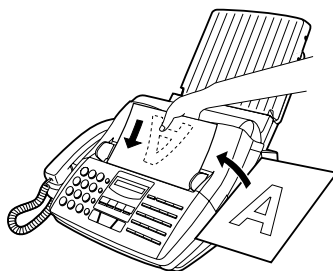

### 2 Press the **COPY/HELP** key.

- If you are only making one copy of the original (or of each original) and don't want to make a reduction or enlargement setting, press the **START** key twice. Copying will begin. If you are only making one copy and want to make a reduction or enlargement setting, press the **START** key once and go to Step 5.

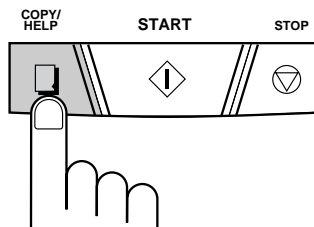

---

**3** Press "1" (MULTI COPY) if you don't want the copies sorted, or "2" (SORT COPY) if you want them sorted.

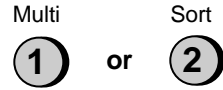

---

**4** Enter the desired number of copies with the number keys.

- If the desired number of copies is from 1 to 9, enter "0" first.
- If you don't want to make a reduction or enlargement setting, press the **START** key. Copying will begin.

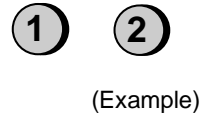

---

**5** Set the amount of reduction or enlargement by entering a number from "1" to "5" as shown below. Copying will begin.

- 1: AUTO (automatic size adjustment to match the size of the printing paper)
- 2: 50%
- 3: 100% (no reduction or enlargement)
- 4: 125%
- 5: 135%

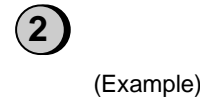

**Note:** If you place a large number of originals in the feeder, the memory may become full before all of them can be scanned (MEMORY IS FULL will appear in the display). If this happens, press the **START** key to copy the originals which have been scanned, and then repeat the copy procedure for the remaining originals, including the original which was being scanned when the memory became full.

## Copy Cut-off

When making a copy, your fax has been set at the factory to not print the remaining part of a document if the document is longer than the printing paper. If you want your fax to always print the remaining part of the document on a second page, follow the steps below.

- 
- 1** Press the keys shown at right.  
COPY CUT-OFF will appear in the display.

FUNCTION  

**6**



- 
- 2** Press "1" to turn copy cut-off on (the remaining part of the document will not be printed), or "2" to turn it off (the remaining part will be printed on a second page).

**1**

or

**2**

- 
- 3** Press the **STOP** key.



## Making Telephone Calls

Your fax can be used like a regular telephone to make and receive voice calls.

- ◆ To make or receive a phone call, the power must be on.
- ◆ The fax may interrupt a voice call received on an extension phone if there is a period of silence during the conversation, the fax's reception mode is set to AUTO, and Option Setting 9 (TAD CONNECTED) is set to YES. If you are on a touch-tone extension phone, you can prevent this by pressing any three keys on the phone immediately after you answer. (Note: Do not enter the code to activate fax reception: "5", "✳", and "✳".)

- 1** Pick up the handset or press the **SPEAKER** key. Listen for the dial tone.

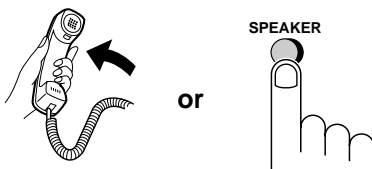

- 2** Dial the number using one of the following methods:

- **Normal Dialing:** Enter the full telephone number with the numeric keys.
- **Rapid Key Dialing:** Press the appropriate Rapid Key (if the Rapid Key number is from 20 to 38, press the **SHIFT** key first).
- **Speed Dialing:** Press the **SPEED DIAL** key, and enter the 2-digit Speed Dial number with the numeric keys.

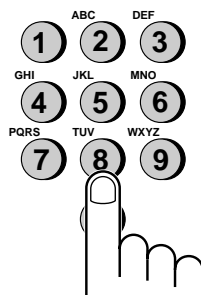

- 3** Speak with the other party when they answer.
- If you pressed the **SPEAKER** key, pick up the handset to talk.

**Note:** While the handset of the fax is lifted (off hook), an extension phone connected directly to the fax cannot be used to speak with the other party.

### ***Using the HOLD/SEARCH key***

You can use the **HOLD/SEARCH** key to search for a Rapid Key or Speed Dial number. First search for the number as described in "Using the HOLD/SEARCH key" in "Dialing and Transmission" in Chapter 3, then pick up the handset or press the **SPEAKER** key. The number will be dialed automatically (do not press the **START** key).

### ***Redial***

The last number called can be redialed by pressing the **REDIAL** key (it is not necessary to pick up the handset or press the **SPEAKER** key). When the other party answers, pick up the handset to talk.

### ***Hold***

You can put the other party on hold during a conversation by pressing the **HOLD/SEARCH** key. When this is done, they cannot hear you. You can put the handset back in the cradle without breaking the connection. When you are ready to speak with them again, pick up the handset. If you did not put the handset back in the cradle, press the **HOLD/SEARCH** key again to resume conversation.

## Answering Machine Hookup

### Using the Hookup

If you have connected an answering machine to your fax as described in "Connections" in Chapter 1, you can receive both voice messages and fax transmissions on the same line while you are out. To use the hook-up, change your answering machine's outgoing message and then activate the hookup before you go out as described on the following page.

**Note:** If you are using distinctive ringing with an answering machine, *do not* follow the instructions in this chapter. (Note that when distinctive ringing is used, the answering machine must be connected to a separate wall jack, not to your fax.)

### Changing the outgoing message

The outgoing message (OGM) of your answering machine should be changed to inform callers who want to send a fax to press their Start key. For example, your message might go as follows:

"Hello. You've reached the ABC company. No one is available to take your call right now. Please leave a message after the beep or press your facsimile Start key to send a fax. Thank you for calling."

#### Comments:

- Try to keep the length of the message under 10 seconds. If it is too long, you may have difficulty receiving faxes sent by automatic dialing.
- We recommend that you leave a pause of about four seconds at the beginning of the message. This will make it easier for your fax machine to detect fax tones.
- Your callers can even leave a voice message and send a fax message on the same call. Modify your outgoing message to explain that they can first leave a voice message, and then press their Start key to send a fax.

## Activating the hookup

Before you go out, activate the answering machine hookup as follows:

- 1 Set Option Setting 9, TAD CONNECTED, to YES:
  - Press the **FUNCTION** key and then the "4" key. OPTION SETTING will appear in the display.
  - Press the "#" key nine times. TAD CONNECTED will appear in the display.
  - Press "1" to select YES. (To deactivate the hookup, press "2" for NO.)
  - Press the **STOP** key to return to the date and time display.

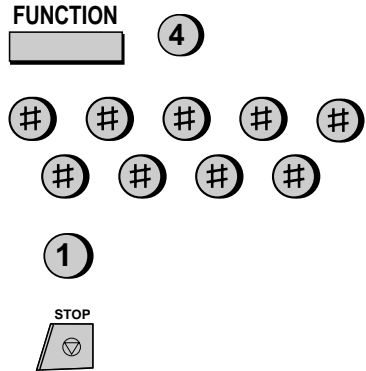

- 2 Set the reception mode of your fax to AUTO by pressing the **RECEPTION MODE** key.
  - Important: For the hook-up to operate properly, the reception mode of your fax must be set to AUTO.

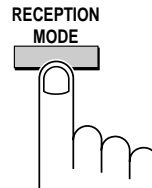

- 3 Set your answering machine to auto answer. It must answer on no more than two rings (if not, you may not be able to receive faxes sent by automatic dialing).
  - If your answering machine has a toll saver function, make sure that it will answer by the fourth ring.

- 4 When you return and turn off your answering machine, you must set TAD CONNECTED to NO (see Step 1 above) if you will be using your fax in AUTO reception mode. If you will only be using MANUAL reception mode, you can leave TAD CONNECTED set to YES.

**Note:** The call counter on your answering machine may indicate that voice messages were received, when only fax messages were received.

### **How the hookup operates**

While you are out, all of your incoming calls will be answered by your answering machine and its outgoing message will play. Voice callers can leave a message. During this time, your fax machine will quietly monitor the line. If your fax machine detects a fax tone or a duration of silence equal to four seconds (called "Quiet Detect Time"), it will take over the line and begin reception.

Your fax machine listens for a duration of silence because some transmitting machines do not send a fax tone when the fax is sent manually (this means that the person faxing uses the handset to dial and then presses their Start key after listening to your outgoing message). Pressing the Start key in this case causes the line to go silent. The timing for fax reception is shown below.

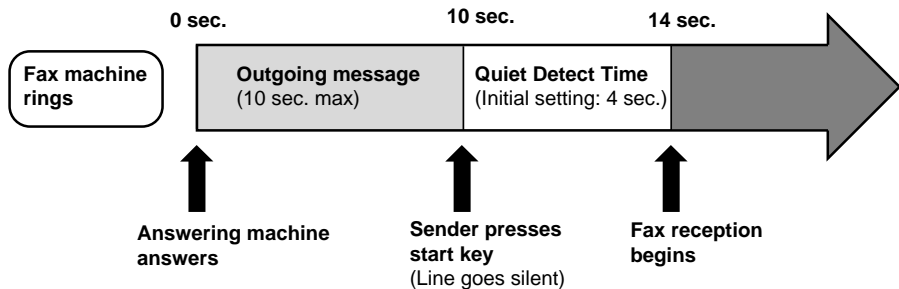

### **Testing for proper operation**

If needed, test the operation of the hookup as follows.

- 
- 1** Call your fax machine from an outside phone line. Cover the mouthpiece to ensure that no sounds are transmitted to the fax machine.

---

  - 2** You should hear your outgoing message, the beep to leave a message, and then a fax tone four seconds later (four seconds is the initial Quiet Detect Time setting). If you hear a fax tone, the hookup is operating properly.

---

  - 3** If the line is disconnected before you hear a fax tone, lower the Quiet Detect Time setting to three seconds and then call your fax machine again.



- 4** If you still do not hear a fax tone, turn off the Quiet Detect Time function and have callers send faxes by pressing "5", "\*", "\*" and then their Start key. For more information on this method, see "If it still doesn't work" in this chapter.

### ***If you have problems***

If you have problems with the hookup, first check the following:

- ◆ Is the answering machine connected properly to the fax? One end of the answering machine line should be inserted in the "**TEL. SET**" jack on the fax, and the other end in the answering machine's **telephone line** jack.
- ◆ Have you set Option Setting 9, TAD CONNECTED, to YES on your fax as described on the second page of this chapter, and is the reception mode set to **AUTO**?

If the above settings and connections are correct and the hookup still doesn't operate properly, the operation of the fax and the answering machine are probably not synchronized well. Some common problems and their solutions are described below.

- ◆ Are callers who want to leave a voice message being interrupted by the fax before they can do so?

The fax is set to take over the line and begin reception if it detects a set duration of silence (called "Quiet Detect Time"). If your outgoing message contains a pause or the caller pauses while leaving a message, and the pause is longer than the set duration, the fax will interrupt.

It is best to shorten or eliminate such pauses, but if necessary you can also try lengthening the Quiet Detect Time setting. This procedure is described in "Optional Hook-up Settings" at the end of this chapter.

- ◆ Are callers who want to send a fax manually having trouble doing so after your answering machine's outgoing message plays?

If so, the answering machine may be disconnecting the line (hanging up) before your fax has a chance to take over the line and begin reception. You can make your fax activate sooner by shortening the Quiet Detect Time setting. This procedure is described in "Optional Hook-up Settings" at the end of this chapter.

- ◆ Are you having trouble receiving documents sent by automatic dialing?

Make sure that your answering machine's outgoing message is less than 10 seconds long, and that your answering machine is set to answer on two rings. Inserting a short pause (about four seconds) at the beginning of your answering machine's outgoing message might also help, as this gives your fax a chance to clearly hear and detect the fax "calling" tone which the transmitting machine sends in the case of automatic dialing.

- ◆ Is the fax interrupting voice calls taken on an extension phone?

When Option Setting 9 (TAD CONNECTED) is set to YES and the reception mode is set to AUTO, the fax may interrupt voice calls received on an extension phone. If you want to use the answering machine hookup while you are in to monitor incoming calls, you can prevent fax interruption of voice calls by pressing any 3 keys on the extension phone after answering. (Note: Do not press "5", "✳", and "✳", the code to activate fax reception.)

- ◆ Is the fax interrupting when you enter your answering machine's code to retrieve voice messages from an outside telephone?

Make sure your answering machine's remote retrieve code is different from the code used to activate fax reception with an extension telephone ("5", "✳", and "✳"). If they are the same, entering the remote retrieve code will activate the fax machine.

### ***If it still doesn't work***

With certain answering machines, it may not be possible to find a Quiet Detect Time setting which will allow both fax reception and uninterrupted voice message recording. In this case, callers on tone dial lines can still send faxes by pressing "5", "✳", and "✳" on their fax. This is the code for activating fax reception (the code can be changed by changing Option Setting 5).

To use this method, set Quiet Detect Time to "00" to turn it off (see "Quiet Detect Time" in "Optional Hookup Settings" in this chapter), and then change your outgoing message to inform callers that they can send a fax by pressing "5", "✳", "✳", and then their Start key. Your message might go as follows:

"Hello. You've reached the ABC company. No one is available to take your call right now. After the beep, please leave a message, or, if you want to send a fax, press 'five' once, 'asterisk' twice, and then your facsimile Start key."

### ***How fax transmissions are detected:***

Your fax detects fax transmissions in two ways when an answering machine is connected, depending on whether the document is being sent automatically or manually:

**Automatic dialing:** If the document is sent using a form of automatic dialing, such as Rapid Key or Speed Dialing, the transmitting fax machine will send a "calling tone" at 3-second intervals for a period of about 30 to 40 seconds after dialing. When your fax detects this tone, it will disconnect the answering machine, send a "reception tone" in response, and begin receiving the transmission.

If the transmitting fax does not receive a reception tone from your fax within 30 to 40 seconds after dialing, it will usually hang up and automatically redial several minutes later.

Since your fax may not be able to detect the transmitting fax's calling tone until after the outgoing message ends, it is important that the answering machine answers the call within two rings and the outgoing message is less than 10 seconds. Otherwise, your fax may not be able to establish communication with the transmitting fax before the latter hangs up.

**Manual dialing:** If the document is being sent by normal (manual) dialing, the transmitting fax machine does not send a calling tone. Instead, the person faxing normally waits until they hear a reception tone and then presses their Start key. In the case of an answering machine hook-up, they will hear your outgoing message instead of a reception tone, and then press their Start key.

However, this does not signal a fax transmission to your fax. Instead, your fax must use a function called "Quiet Detect Time" to detect the transmission. This function causes your fax to disconnect the answering machine and begin reception if it detects a certain duration of silence.

Your fax is set to automatically begin fax reception if it detects a duration of silence of four seconds. When the person faxing presses their Start key, the line will go quiet, and the transmitting fax machine will wait for a reception tone from your fax. Your fax will disconnect the answering machine four seconds after the key is pressed, and send a reception tone to tell the other fax machine to begin transmission.

If your answering machine has a fast disconnect time and disconnects the line before four seconds elapses, fax reception will not be possible. In this case, you must shorten the Quiet Detect Time setting as described on the following page. On the other hand, if the Quiet Detect Time setting is too short, your fax may interrupt voice callers if they pause during their message or if there is a period of silence in your outgoing message.

## Optional Hookup Settings

If necessary, you can use the following settings to improve the response of the answering machine hookup to incoming calls.

### Quiet Detect Time

This function causes the fax machine to take over the line and begin reception if a certain duration of silence is detected after the answering machine answers.

Time selections for the period of silence are one to ten seconds. Quiet Detect Time has been set to four seconds at the factory. This gives the best performance with most answering machines; however, you may need to adjust this setting depending on the disconnect time of your answering machine.

- ◆ Some answering machines may have unusually fast disconnect times (equal to or very slightly less than four seconds), which means that the answering machine may disconnect the line before fax reception can begin. In this case, try a Quiet Detect Time setting of three seconds.
- ◆ If the fax machine is interrupting callers before they can leave a message, try a longer Quiet Detect Time setting. If your outgoing message includes a period of silence, make sure that the setting is longer than that period of silence, or re-record your outgoing message to shorten the silence.

To change the Quiet Detect Time setting, follow the steps below.

**Note:** Quiet Detect Time can be turned off by entering "00" for the time. Note, however, that the fax machine will not be able to receive manually dialed faxes.

- 
- 1** Press the **FUNCTION** key and then the "4" key. **OPTION SETTING** will appear in the display.



- 
- 2** Press the "\*" key nine times. **QUIET DETECT TM.** will appear in the display.

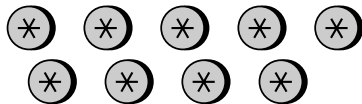

- 3** Set the time in seconds by entering a two-digit number from "01" to "10" (enter "01" for one second, "02" for two seconds, etc.). To turn off the function, enter "00".



(Example)

- Note: We recommend that you do not set Quiet Detect Time below three seconds.

- 4** Press the **STOP** key to return to the date and time display.



### ***Fax reception when the answering machine fails***

When this function is turned on, your fax will answer the call after five rings if the answering machine for some reason fails to answer before that time. This ensures that you will receive fax messages even if the answering machine's tape fills up or the answering machine is not turned on.

This function has been turned off at the factory. If you want to turn it on, following the steps below.

**Note:** When this function is turned on, make sure that the answering machine is set to answer on four rings or less. If it isn't, the fax will always answer first, preventing callers from leaving voice messages.

- 1** Press the **FUNCTION** key and then the "4" key. OPTION SETTING will appear in the display.

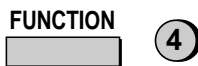

- 2** Press the "\*" key eight times. FAX RX TAD FAILS will appear in the display.

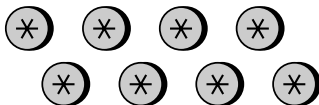

- 3** Press "1" to turn the function on, or "2" to turn it off.

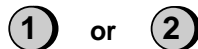

- 4** Press the **STOP** key to return to the date and time display.



## Special Functions

### Blocking Reception of Unwanted Faxes

The Anti Junk Fax function allows you to block reception of faxes from parties which you specify. This saves paper by not printing out unwanted "junk" faxes.

To use this function, first turn it on by setting Option Setting 14 to YES as described in Chapter 9, and then enter the fax numbers from which you do not want to receive faxes as shown below.

#### Comments:

- Up to 5 numbers can be entered in the Anti Junk Number List.
- To clear a number from the Anti Junk Number List, you need to know the 1-digit number which identifies it. If you have forgotten this number, print out the Anti Junk Number List as described in Chapter 10.

- 
- 1** Press the keys shown at right. STORE JUNK FAX # will appear in the display.

FUNCTION



- 
- 2** Press "1" to store a number in the Anti Junk Number List, or "2" to clear a number from the list.



or



- 
- 3** **Storing:** Enter a 1-digit number from "1" to "5". This number identifies the fax number you will store in the next step.

**Clearing:** Enter the number which identifies the fax number you want to clear, and go to Step 5.



(Example)

---

**4** Enter the fax number (max. of 20 digits).



(Example)

---

**5** Press the **START** key.

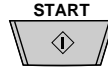

---

**6** Return to Step 3 to enter (or clear) another number, or press **STOP** to exit.

**Step 3 or**



## Memory

Your fax has a memory which can be used to temporarily store both incoming and outgoing documents.

- ◆ Approximately 37 pages of average content can be held in memory if they are all going to be transmitted (25 pages if Option Setting 18, Error Correction Mode, is set to YES), or 30 pages if they are all received (27 pages if Option Setting 18 is set to YES). Less can be held if any were scanned using fine or halftone resolution.

### Sending documents from memory

With this function, the original document is scanned immediately, stored in memory, and then transmitted once the connection to the receiving machine is made. This is convenient when transmitting to places where the line is often busy, as it saves you from waiting to pick up the original document and frees the feeder for other operations. After transmission, the document will be cleared from memory.

- ◆ Only one memory transmission can be set at a time.
- ◆ The amount of memory currently occupied appears as a percentage in the display while the document is being scanned.

---

#### 1 Load the document(s).

- Set the resolution and/or contrast if desired.

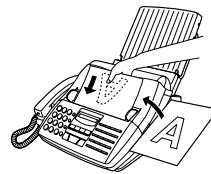

---

#### 2 Press the **MEMORY** key and then "1".

**MEMORY**



1

---

#### 3 Enter the number of the receiving machine using one of the following methods:

- Press a Rapid Key.
- Press the **SPEED DIAL** key and enter a Speed Dial number.
- Enter a full telephone number by pressing the number keys.

01
20

(Example)



**4** Press the **START** key if you entered a Speed Dial number or a full number.

- The document will be scanned and stored in memory. Your fax will then dial the receiving machine and transmit the document (redialling will be done automatically if necessary).

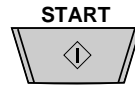

### ***If the memory becomes full...***

If the memory becomes full while the document is being scanned, MEMORY IS FULL will appear in the display.

- ◆ Press the **START** key if you want to transmit the pages which have been stored up to that point in memory. The remaining pages will be ejected from the feeder. After transmission, the memory will be cleared and you can transmit the remaining pages. You will also need to transmit the page which was being scanned when the memory filled up.
- ◆ Press the **STOP** key if you want to cancel the entire transmission.

### ***Substitute reception***

This is a back-up function which is automatically activated if your fax runs out of paper, the printing ribbon needs replacement, or the paper jams.

When you have received a document in memory, FAX RX IN MEMORY will appear in the display, alternating with OUT OF PAPER, FILM END, or PAPER JAM. When you add paper, replace the imaging film, or clear the jam, the stored documents will automatically print out.

- ◆ If you received documents in memory because the fax ran out of paper, be sure to add paper which is the same size as the paper previously used. If not, the document print-out size may not match the size of the printing paper.

### **Caution!**

- When documents are stored in memory, do not turn the power off. This will erase all of the contents.
- If documents received in memory are lost due to a power failure or other interruption in the power supply, a "CLEAR REPORT" will be printed out when the power is restored. This gives information about the receptions lost, including the fax numbers of the transmitting machines if they are available.

## Broadcasting

This function allows you to send the same document to as many as 20 different locations with just one operation. First store the document in memory, then enter the numbers of the receiving machines. The document will be transmitted to each location.

- ◆ You can only use Rapid Keys or Speed Dial numbers to dial the numbers of the receiving machines.

**1** Load the document(s).

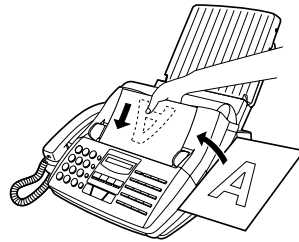

**2** Press the **MEMORY** key and then "2".



**3** Dial the receiving machines (maximum of 20) using one or both of the following methods:

- Enter one or more Speed Dial numbers by pressing the number keys.
- Press one or more Rapid Keys.



(Example)

**4** Press the **START** key.

- Set the resolution and/or contrast if desired.



**5** Press the **START** key. Transmission will begin.

- A Transaction Report is automatically printed out after Broadcasting is completed. Check the "Note" column of the report to see if any of the locations are marked "Busy" or have a communication error code. If so, send the document to those locations again.

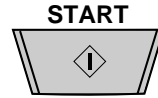

### ***Broadcasting using a Group Key***

If the fax machines to which you want to broadcast have all been programmed into one Group Key, you can perform the broadcasting operation using the following simplified procedure:

**1** Load the document(s).

- Make any desired transmission settings (resolution, contrast, etc.).

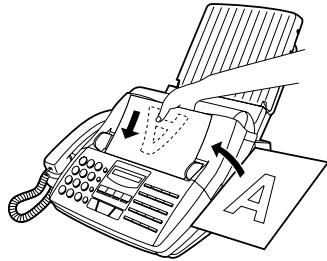

**2** Press the appropriate Group Key. Transmission will begin.

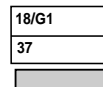

(Example)

## Polling (Requesting a Fax Transmission)

Polling allows you to request another fax machine to send a document to your fax machine. In other words, the receiving fax machine, not the transmitting fax machine, initiates the transmission. You can use your fax to both poll and be polled by others.

To use the polling function, you must first reset Rapid Key 15/POLL for use as a polling key. This is done by resetting Option Setting 15, as described in Chapter 9, "Optional Settings". (Note that when Rapid Key 15/POLL is set as a polling key, it cannot be used for Rapid Key Dialling.)

### Requesting transmission

**Note:** Rapid Dial Keys cannot be used for polling. To dial a Rapid Dial location, press the **SPEED DIAL** key and then enter the 2-digit number corresponding to the Rapid Key.

**1** Dial the fax machine you want to poll using one of the following methods:

- Pick up the handset (or press the **SPEAKER** key) and dial the full number. Wait for the fax answerback tone.
- Press the **SPEED DIAL** key and enter a 2-digit Speed Dial number.
- Enter the full number using the numeric keys.

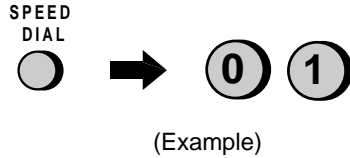

**2** Press Rapid Key 15/POLL.

- If you used the handset, replace it when POLLING appears in the display. Reception will begin.

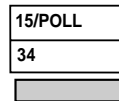

## Being polled (polling standby)





To let another fax machine poll your fax, simply set the reception mode to AUTO, and load the document(s) to be sent.

Transmission will take place when the other fax machine calls your fax and activates polling. Automatic reception is possible whilst your fax is on polling standby.

## Polling security

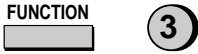

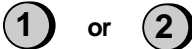















Polling Security allows you to prevent unauthorized polling of your fax. When this function is turned on, polling will only take place when the fax number of the polling fax machine has been entered in your fax's list of permitted fax numbers (called "passcode numbers"). The number of the polling fax must also be correctly programmed into itself for identification.

To use Polling Security, follow the steps below to turn the function on, and then enter permitted numbers as shown on the following page.

- 
- 1** Press the keys shown at right.  
ENTRY MODE will appear in the display.
- 
- 
- 2** Press the "#" key three times.  
SECURITY SELECT will appear in the display.
- 
- 
- 3** Press "1" to turn polling security on, or "2" to turn it off.
- 
- 
- 4** Press the **START** key and then the **STOP** key.
- 

## Storing and clearing fax numbers for polling permission

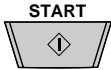
You can store up to 10 fax numbers in your fax's list of permitted numbers.

- 
- 1** Press the keys shown at right. ENTRY MODE will appear in the display.
-  
- 
- 2** Press the "#" key four times. PASSCODE # MODE will appear in the display.
-    
- 
- 3** Press "1" to store a number, or "2" to clear a number.
-  or 
- 
- 4** **Storing:** Enter a 2-digit number from "01" to "10". This number identifies the fax number you will store in the next step.
-  
- Clearing:** Enter the number which identifies the fax number you want to clear, and go to Step 6.
- (Example)
- 
- 5** Enter the fax number (max. of 20 digits).
-       
- (Example)
- 
- 6** Press the **START** key.
- 
- 
- 7** Return to Step 4 to enter (or clear) another number, or press **STOP** to exit.
- Step 4 or** 













## Timer Operations

The Timer function allows you to set a transmission and/or polling operation to be performed automatically at a time you specify. One transmission operation and one polling operation can be set at the same time, and the times they will be performed can be specified up to 24 hours in advance.

As an example, you can use this function to take advantage of off-peak telephone rates without having to be there when the operation is performed.

**Note:** Only a Speed Dial number can be used to dial the receiving machine.

### Setting a timer operation

- 
- 1** Press the keys shown at right. TIMER MODE will appear in the display.
- FUNCTION  
- 
- 2** Press "#" to set a transmission operation (SEND MODE), or "\*" to set a polling operation (POLLING MODE).
-  or 
- 
- 3** Press "1" to select SET.
- 
- 
- 4** Enter the time at which you want the operation to take place (2 digits for the hour and 2 digits for the minute).
-      
(Example: 9:25)
- 
- 5** Press "\*" to select A.M., or "#" to select P.M.
-  or 
- 
- 6** Press the **START** key.
- 

**7** Enter the Speed Dial number of the receiving fax machine.

- If this is a polling operation, go to Step 10.



(Example)

**8** Press the **START** key.

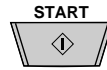

**9** Adjust the resolution and/or contrast (skip this step if you don't want to change settings).

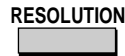

**10** Press the **START** key and then the **STOP** key. If this is a transmission operation, load the document in the feeder sometime before the specified time of transmission.



### ***To cancel an operation***

If you need to cancel an operation after it has been set, follow the steps below.

**1** Press the keys shown at right. **TIMER MODE** will appear in the display.

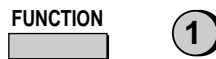

**2** Press "#" to cancel a transmission operation, or "\*" to cancel a polling operation.

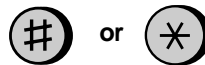

**3** Press "2" to select CLEAR.



**4** Press the **START** key and then the **STOP** key.





## Entering and Using Programs

If you frequently perform the same operation involving the same party, you can program all the steps of the operation into one Program Key. This allows you to perform the operation by simply pressing that key.

- ◆ Rapid Keys 16/P1 and 17/P2 can be used as Program Keys. However, a key cannot be used if it is already being used for Rapid Key Dialing.
- ◆ Only Speed Dial numbers can be used to enter fax numbers of receiving machines in the Program Keys. Full numbers cannot be entered.
- ◆ If the program is for a regular transmission or polling operation, a timer setting can be included to have the operation performed automatically at a selected time.
- ◆ To clear a mistake, press the *STOP* key.

### Initial procedure

To program an operation, first perform the following procedure. After you have completed it, go to the procedure for the specific operation you want to program.

- 
- 1** Press the keys shown at right. PRG. ENTRY MODE will appear in the display.
- FUNCTION

7

#
- 
- 2** Press "1" to select SET.
- 1
- 
- 3** Press a Program Key ("16/P1" or "17/P2") to select it.
- |       |
|-------|
| 16/P1 |
| 35    |
|       |

or

17/P2
36
- 
- 4** Enter a name for the program (max. of 20 characters). (See "Entering Letters for Names" in Chapter 2). Skip this step if you don't want to enter a name.
- ABC 2

DEF 3

GHI 4

...

JKL 5

MNO 6

PQR 7

STU 8

VWX 9
- (Example)

**5** Press the **START** key.

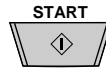

**6** Press the **"#"** key or the **"\*"** until the desired operation appears in the display. The operations will appear in the following order:

- Transmission ("SEND")
- Polling
- Broadcasting

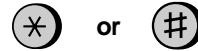

**7** Press the **START** key and then continue with the specific procedure for your operation (see the following pages).



## Transmission

(Continued from "Initial procedure".)

**8** Press **"1"** if you want the document to be scanned into memory and then transmitted, or **"2"** if you want the document to be transmitted directly from the feeder. (Note: If you select **"2"**, you can include a timer setting in the program.)

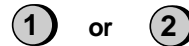

- If you pressed **"1"**, go to Step 12. If you pressed **"2"** and don't want to make a timer setting, go to Step 11.

**9** Enter the time at which you want the operation to take place (2 digits for the hour and 2 digits for the minute).

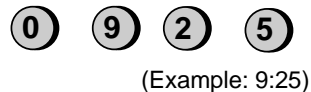

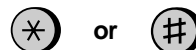

**10** Press **"\*"** to select A.M., or **"#"** to select P.M.





**11** Press the **START** key.



- 12** Enter the Speed Dial number of the receiving fax machine.   (Example)

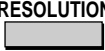



- 13** Press the **START** key. 



- 14** If desired, set the resolution and/or contrast by pressing the **RESOLUTION** key (otherwise, skip this step). 

- 15** Press the **START** key and then the **STOP** key.  



### Polling



(Continued from "Initial procedure".)

- 8** Enter the time at which you want the operation to take place (2 digits for the hour and 2 digits for the minute). If you don't want to make a timer setting, go to Step 10.     (Example: 9:25)

- 9** Press "\*" to select A.M., or "#" to select P.M.  or 



- 10** Press the **START** key. 

- 11** Enter the Speed Dial number of the receiving fax machine.   (Example)

- 12** Press the **START** key and then the **STOP** key.  



### Broadcasting

(Continued from "Initial procedure".)

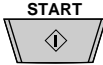
- 
- 8** Enter the Speed Dial numbers of the receiving machines.   (Example)

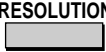

- 
- 9** Press the **START** key. 

- 
- 10** If desired, set the resolution and/or contrast by pressing the **RESOLUTION** key (otherwise, skip this step). 

- 
- 11** Press the **START** key and then the **STOP** key.  

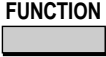

### Clearing a Program key

To clear a Program key, follow these steps:

- 
- 1** Press the keys shown at right. PRG. ENTRY MODE will appear in the display.   

- 
- 2** Press "2" to select CLEAR. 

- 
- 3** Press the Program Key you want to clear.  (Example)

- 
- 4** Press the **START** key and then the **STOP** key.  

## Using a Program key

A programmed operation is performed as follows:

- 1 Load the document.

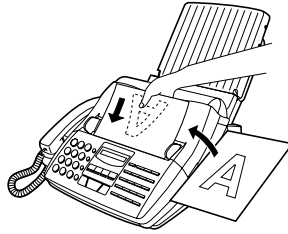

- 2 Press the appropriate Program Key.



(Example)

**Note:** A maximum of 2 timer operations can be set at any one time, including both timer operations set by pressing a Program Key and operations set as described in "Timer Operations" in this chapter.

## To cancel a programmed timer operation

If a Program Key has been pressed for a timer operation and you need to cancel the operation before it is performed, follow these steps:

- 1 Press the Program Key.

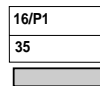

(Example)







- 2 Press the **START** key.

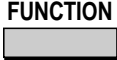

## Optional Settings

A variety of optional settings are available which you can use to customize your fax to better suit your needs. The settings are made by pressing the panel keys, and each setting is described in the list below.

### Accessing the Settings

- 
- 1** Press the keys shown at right. **FUNCTION**    
**OPTION SETTING** will appear in the display.
- 
- 2** Move through the list of settings by pressing **#** to move forward, or **\*** to move backward. The settings will appear in the order listed below.  or 
- 
- 3** When the desired setting appears in the display, make a selection as described below. Your selection will be automatically stored.  (Example)
- 
- 4** Press the **STOP** key. 

### Settings

#### Setting 1: FINE RESOLUTION PRIORITY

This sets the default resolution (the resolution used if a setting is not made with the **RESOLUTION** key) for transmitting documents. Press **"1"** (YES) to set it to FINE, or **"2"** (NO) to set it to STANDARD.

- Initial setting: **"2"**

#### Setting 2: NUMBER OF RINGS TO ANSWER

This sets the number of rings the fax machine waits before answering an incoming call in Auto reception mode. Enter any number from **"1"** to **"5"**.

- Initial setting: **"4"**

**Setting 3: RECALL INTERVAL**

This sets the amount of time your fax will wait between automatic redials when the line is busy. Enter "01" for 1 minute, "02" for 2 minutes, etc., up to a maximum of 15 minutes.

- Initial setting: "05"

**Setting 4: RECALL TIMES**

This sets the maximum number of times your fax will automatically redial if the line is busy. Enter any number from "00" to "15".

- Initial setting: "02"

**Setting 5: TEL/FAX REMOTE NUMBER**

This sets the 1-digit number for activating fax reception from an extension telephone. Enter any number from "0" to "9".

- Initial setting: "5"

**Setting 6: REMOTE RECEPTION SELECT**

This turns detection of the code for activating fax reception from an extension phone on or off. Press "1" to turn detection on, or "2" to turn detection off.

- Initial setting: "1"

**Setting 7: TRANSACTION REPORT PRINT SELECT**

This sets the condition for printing out a Transaction Report. Enter a number from "1" to "5" as follows:

"1" (ALWAYS PRINT): A report will be printed after each transmission, reception, or error.

"2" (ERR/TIMER/MEM): A report will be printed after an error, timer operation, or memory operation.

"3" (SEND ONLY): A report will be printed only after a transmission.

"4" (NEVER PRINT): A report will never be printed.

"5" (ERROR ONLY): A report will be printed only after an error occurs.

- Initial setting: "5"

**Setting 8: DIAL MODE**

This sets the mode of dialing. Press "1" if you are on a touch-tone line, or "2" if you are on a pulse dial line. (If you don't know which type of line you have, try making phone calls with both settings and see which one works.)

- Initial setting: "1"

**Setting 9: TAD CONNECTED**

Press "1" (YES) if an answering machine is connected to the fax and turned on, or "2" (NO) if not. See Chapter 7 for more details on using an answering machine hookup.

(Note: Select "NO" if you are using the distinctive ring function.)

- Initial setting: "2"

**Setting 10: QUIET DETECT TIME**

This sets the duration of silence (in seconds) after which the fax will take over the line and begin reception when an answering machine is connected. Enter a number from "01" to "10", or enter "00" to turn off the function. (This setting is described in more detail in "Optional Hookup Settings" in Chapter 7.)

(Note: We recommend that you do not set Quiet Detect Time below 3 seconds.)

- Initial setting: "04"

**Setting 11: FAX RECEPTION WHEN TAD FAILS**

Press "1" (YES) to have the fax answer a call if an answering machine connected to the fax does not answer within 5 rings. Press "2" (NO) to turn the function off. (This setting is described in more detail in "Optional Hookup Settings" in Chapter 7.)

- Initial setting: "2"

**Setting 12: DISTINCTIVE RING**

This sets the ring pattern to which your fax will answer if you subscribe to a distinctive ring service. Enter a number from "1" to "5" to select a pattern. See "Distinctive Ring" in Chapter 2 for more details.

- Initial setting: "5"

**Setting 13: FAX SIGNAL RECEIVE**

Your fax is set to automatically begin reception if you hear a high-pitched fax tone after answering a call on your fax or an extension phone. If you use a computer fax modem to send documents on the same line, you must turn this setting off in order to prevent your fax from mistakenly attempting to receive documents from the computer fax modem. Press "1" to turn the setting on, or "2" to turn it off.

- Initial setting: "1"



**Setting 14: JUNK FAX NUMBER CHECK**

Press "1" to prevent reception from fax numbers entered in the Anti Junk Fax List. Press "2" to allow reception from all numbers.

- Initial setting: "2"

**Setting 15: POLLING**

Press "1" if you want to use Rapid Key 15/POLL as a polling key. Press "2" if you want to use it as a regular Rapid Key.

- Initial setting: "2"

**Setting 16: AUTO COVER SHEET**

Press "1" (YES) to have the fax automatically generate a cover sheet and send it as the last page of each transmission. Press "2" (NO) to turn the function off.

- Initial setting: "2"

**Setting 17: ACTIVITY REPORT AUTO PRINT OUT**

Press "1" to have your fax automatically print out an Activity Report once every 30 operations. (The list can still be printed out on demand when desired.) Press "2" to turn automatic print-out off.

- Initial setting: "2"

**Setting 18: ERROR CORRECTION MODE (ECM)**

Press "1" (YES) to have any distortions in a transmission due to noise on the telephone line be corrected before the document is printed out. This is only effective when the other machine has ECM as well. Press "2" (NO) to turn the function off.

- Initial setting: "1"



### Explanation of headings

**SENDER/RECEIVER** The fax number of the other machine involved in the transaction. If this machine does not have an ID function, the communication mode will appear (for example, "G3").

**PAGES** Number of pages transmitted or received.

**NOTE** **OK** - Transmission/reception was normal.

**P.FAIL** - A power failure occurred.

**JAM** - A problem with the fax paper or document occurred.

**NO PAPER** - You ran out of fax paper during reception.

**CANCEL** - Transmission was cancelled because the **STOP** key was pressed, no document was in the feeder, or the other machine requested transmission using a function which your fax does not have.

**COME-0 to COME-14** - A telephone line error prevented the transaction. Explanations of the error numbers are given in the following tables, however, these are primarily for use by service engineers. In general, you will want to simply try the transaction again. If necessary, check with the other party to make sure their machine is functioning properly.

### Transmission errors

<b>E-0</b>	Able to recognize handshake signal, but it has errors.
<b>E-1</b>	Cannot recognize the handshake signal from the receiver side.
<b>E-2</b>	Line disconnected during transmission.
<b>E-3</b>	Line disconnected after modem speed fall-back.
<b>E-4</b>	Line disconnected during multi-page transmission.
<b>E-6</b>	Cannot recognize the handshake signal for next page at receiver side.
<b>E-7</b>	No response from receiver side or "disconnect signal" is received at transmitter side.
<b>E-8</b>	Error was not corrected after the predetermined number of retries because of an error in a part of a page.
<b>E-11</b>	Error occurred after or while reception by the remote (receiving) machine was revealed to be impossible.
<b>E-12</b>	Error occurred just after fall-back.
<b>E-13</b>	Error occurred after a response to a retransmission end command was received.

**Reception errors**

<b>E-0</b>	Able to recognize handshake signal, but it has errors.
<b>E-1</b>	Line disconnected during reception.
<b>E-2</b>	Cannot recognize the handshake signal from the transmitter side.
<b>E-3</b>	Cannot recognize the last handshake signal from the transmitter side.
<b>E-4</b>	Cannot recognize the handshake signal for next page from the transmitter side in the case of mode change.
<b>E-5</b>	Cannot recognize the handshake signal for next page from transmitter side.
<b>E-7</b>	No response from transmitter or "disconnect signal" is received at receiver side.
<b>E-8</b>	Error occurred upon completion of reception of all pages.
<b>E-9</b>	Error occurred when mode was changed or transmission/reception switching was performed.
<b>E-10</b>	Error occurred during partial page or physical page reception.
<b>E-11</b>	Error occurred after or during inquiry from the remote (transmitting) machine as to whether reception was possible or not.
<b>E-12</b>	Error occurred during or just after fallback.
<b>E-13</b>	Error occurred after retransmission end command was received.
<b>E-14</b>	Error occurred after voice communication command was received.

**Timer list**

This list shows the timer operations which are currently set.

TIMER LIST		JUL-07-97 02:46 PM
FOR: Johe Doe Corp.		201 555 1234
<hr/>		
TIMER SEND		
START	05:15 PM	
RECEIVER	N.Y.	
RESOLUTION	FINE	:AUTO
TIMER POLLING		
START	10:00 AM	
SENDER	JACK SMITH	
<hr/>		

## Telephone Number List

This list shows the fax and voice numbers which have been stored for automatic dialing.

TELEPHONE NUMBER LIST		
FOR: John Doe Corp.		JUL-07-97 02:41 PM
		201 555 1234
SPEED #	NAME	TELEPHONE #
01	N.Y.	123-785-6340
15		POLLING RESERVED
16		PROGRAM #1 STORED
18		GROUP #1 STORED
99	JACK SMITH	125-563-8462

## Passcode List

This list shows settings made for polling security, your name and fax/telephone number as entered in the machine, and a sample of the header printed at the top of every page you transmit (**HEADER PRINT**).

PASSCODE LIST	
FOR: John Doe Corp.	
JUL-07-97 02:45 PM	
201 555 1234	
POLLING MODE	SECURITY OFF
PASSCODE #	
01	1237856340
02	125563462
03	
04	
05	
06	
07	
08	
09	
10	
B.V. LIGHT SAVING TIME	YES
SENDER'S NAME	John Doe Corp.
SENDER'S TELEPHONE NUMBER	201 555 1234
HEADER PRINT	
JUL-07-97 02:45 PM	John Doe Corp.
201 555 1234	P.01

## Option Setting List

This list shows the current status of the optional settings.

OPTIONS SETTING LIST		
FOR: John Doe Corp.		JUL-07-97 02:53 PM
		201 555 1234
NO.	ITEM	SETTING
1	FINE PRIORITY	NO
2	NUMBER OF RINGS IN AUTO ANSWER MODE	4 RINGS
3	RECALL INTERVAL	35 MINUTES
4	RECALL TIMES	02 TIMES
5	TEL-FAX REMOTE #	(S)++
6	REMOTE RECEPTION	YES
7	TRANSACTION PRINT SELECT	EPKOR ONLY
8	DIAL MODE	TOUCH
9	TAD CONNECTED	NO
10	QUIET DETECT TIME	04 SECONDS
11	FAX ANSWER WHEN TAD FAILS	NO
12	DISTINCTIVE RINGING	OFF
13	FAX SIGNAL RECEIVE	YES
14	JUNK # CHECK	NO
15	POLLING	NO
16	COVER SHEET	NO
17	AUTO PRINT OUT	NO
18	ECN MODE	YES

### Anti Junk Number List

This list shows the fax numbers from which reception is not allowed.

ANTI JUNK NUMBER LIST		JUL-07-97 02:50 PM
ANTI JUNK #	CHECK	: NO
STORED LOCATION	JUNK FAX #	
1	2015546621	
2	2014573321	
3	1023570251	

### Program and Group List

The top part of this list shows the programs which have been entered. The bottom part shows the fax numbers which have been stored in each Group Key.

PROGRAM/GROUP LIST			JUL-07-97 03:20 PM
FOR: John Doe Corp.		201 555 1234	
PROGRAM 1	NAME	ABC Corp.	
	RESERVED TIME	03:00 PM	
	TYPE	TIMER POLLING	
	REMOTE STATION ID	S01	
GROUP 1	REMOTE STATION ID	S01,S99	

### ***Print Setup List***

This list shows the current status of the printing settings made by pressing the **FUNCTION** key and the "6" key.

PRINT SET UP LIST		
FOR: John Doe Corp.		JUL-07-97 02:47 PM
		201 555 1234
NO.	ITEM	SETTING
1	INITIALIZE FILM	JUL-07-97
2	RECEPTION RATIO	AUTO
3	2 IN 1 PRINT	NO
4	PAPER TYPE SET	REGULAR
5	PAPER SIZE SET	LETTER
6	COPY CUT OFF	YES

### ***Transaction Report***

This report is printed out automatically after an operation is completed to allow you to check the result. Your fax is set at the factory to print out the report only when an error occurs. If desired, you can change the setting to have it printed out under a variety of other conditions. This is done by changing Option Setting 7 as described in Chapter 9.

- ◆ The same headings appear in the Transaction Report as in the Activity Report. See "Activity Report" in this chapter for an explanation of the headings.
- ◆ The Transaction report cannot be printed on demand.

**Fax print head**

Clean the print head frequently to ensure optimum printing performance. To clean the print head, first unplug the power cord, open the print compartment cover (press the release marked **OPEN**), and remove the imaging film.

Wipe the print head, frame and roller with a soft cloth dampened with denatured alcohol.

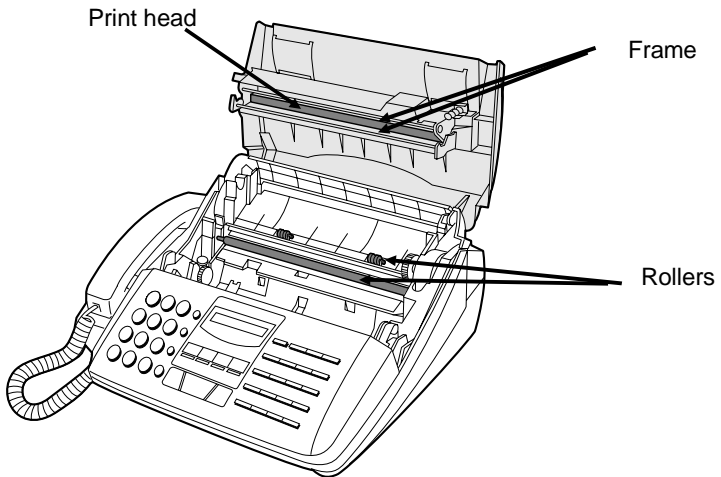
**Caution!**

- Do not use benzene or thinner. Avoid touching the print head with hard objects.
- The print head may be hot if your fax machine has just received a large number of documents. If this is the case, allow the print head to cool prior to cleaning.



## Scanning glass and rollers

Clean the scanning glass and rollers frequently to ensure the quality of transmitted images and copies. Open the operation panel by pulling the front edge up (grasp it at the **PANEL RELEASE** mark), and clean the scanning glass and rollers as shown below.

Wipe the scanning glass, white backplate, and rollers with a soft cloth.

- Make sure that all dirt and stains (such as correcting fluid) are removed, as these will cause vertical lines on transmitted images and copies.

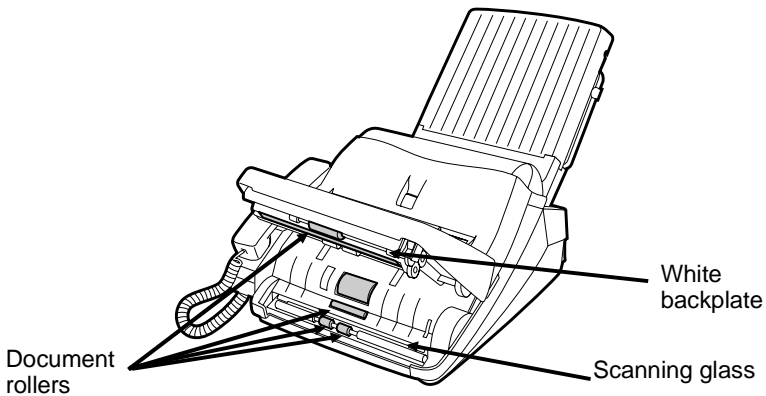

## The housing

Wipe the external parts and surface of the machine with a dry cloth.

### Caution!

- Do not use benzene or thinner. These solvents may damage or discolor the machine.

## Troubleshooting

### Problems and Solutions

**Note:** For problems with an answering machine hookup, see "If you have problems" in Chapter 7, "Answering Machine Hookup".

Problem	Check and remedy
Nothing appears in the display.	<ul style="list-style-type: none"><li>• Make sure the power cord is properly plugged into a power outlet.</li><li>• Connect another electrical appliance to the outlet to see if it has power.</li></ul>
The fax does not respond when you press any of its keys.	<ul style="list-style-type: none"><li>• If a beep sound is not made when you press the keys, unplug the power cord and then plug it back in several seconds later.</li></ul>
Dialing is not possible.	<ul style="list-style-type: none"><li>• Make sure the power cord is properly plugged into a power outlet.</li><li>• Make sure that the telephone line is properly connected to both the <b>TEL. LINE</b> jack and the wall jack.</li><li>• Make sure that the fax is set to the correct dialing mode for your telephone line. See Option Setting 8 in Chapter 9.</li></ul>
The power is on, but no transmission takes place.	<ul style="list-style-type: none"><li>• Make sure that the receiving machine has fax paper.</li><li>• Make sure that the telephone line cord is plugged into the <b>"TEL. LINE"</b> jack, and not the <b>"TEL. SET"</b> jack.</li><li>• If the receiving machine is in manual mode with no attendant, reception will not be possible.</li><li>• If the receiving machine is not a Sharp model, make sure it is G3 compatible.</li><li>• Check the display for error messages.</li><li>• Pick up the handset and check for a dial tone.</li></ul>

Automatic document feeding does not work for transmission or copying.	<ul style="list-style-type: none"> <li>● Check the size and weight of the document (see "Transmittable documents" in Chapter 3).</li> </ul>
Nothing is printed at the receiving end.	<ul style="list-style-type: none"> <li>● Make sure that the document for transmission is placed face down in the feeder.</li> <li>● Make sure that the fax paper is properly loaded in the receiving machine.</li> </ul>
A distorted image is received at the other end.	<ul style="list-style-type: none"> <li>● Noise on the telephone line may cause distortion. Try sending the document again.</li> <li>● Make a copy of the document on your fax. If the copy is also distorted, your fax may have a problem.</li> </ul>
The power is on, but no reception takes place.	<ul style="list-style-type: none"> <li>● Make sure that the telephone line cord is plugged into the "TEL. LINE" jack, and <b>not</b> the "TEL. SET" jack.</li> </ul>
The printing paper does not come out.	<ul style="list-style-type: none"> <li>● The printing paper may be jammed. See "Clearing Jammed Printing Paper" in this chapter.</li> <li>● Make sure that the printing paper is properly loaded in your machine.</li> </ul>
The printing paper comes out blank when you try to receive a document.	<ul style="list-style-type: none"> <li>● Make sure that the document is loaded properly in the feeder of the transmitting machine. Make a copy to confirm the printing ability of your machine.</li> </ul>
The received document is faint.	<ul style="list-style-type: none"> <li>● Ask the other party to send higher contrast documents. If the contrast is still too low, your fax may have a problem. Make a copy to check it.</li> </ul>
Received images are distorted.	<ul style="list-style-type: none"> <li>● Noise on the telephone line may cause distortion. Have the other party try sending the document again.</li> <li>● The print head may be dirty. See "Fax print head" in Chapter 11.</li> <li>● Make a copy of another document on your fax. If the copy is also distorted, your fax may have a problem.</li> </ul>

<p>Reception/copying is interrupted.</p>	<ul style="list-style-type: none"><li>• If reception or copying has been done continuously for a long time, the print head may have become overheated. Turn off the power and let it cool down.</li></ul>
<p>Voice calls taken on an extension phone are interrupted by the fax.</p>	<ul style="list-style-type: none"><li>• The fax may interrupt during a voice call if Option Setting 9 is set to YES and the reception mode is set to AUTO. To prevent interruption on a touch-tone extension phone, press any three keys on the extension phone after answering. (Note: Do not enter the code to activate fax reception.)</li></ul>
<p>No reception occurs when polling is attempted.</p>	<ul style="list-style-type: none"><li>• Make sure you have not run out of printing paper.</li><li>• Make sure the transmitting machine is in automatic reception mode.</li><li>• If the transmitting machine has polling security, make sure that your fax number has been entered both in your fax and in the transmitting machine.</li></ul>

## Messages and Signals

### Display messages

CHECK PAPER SIZE	The paper size setting is incorrect. Change the paper size setting as described in "Loading the Paper" in Chapter 1.
COVER OPEN	The printing compartment cover is open. Close it.
DOCUMENT JAM	The original document is jammed. See the following section, "Clearing Paper Jams".
FAX RX IN MEMORY	A fax has been received in memory because the imaging film needs replacement, you have run out of printing paper, or the paper is jammed. The fax will print out automatically when the problem is fixed.
FILM END	The imaging film may need replacement. Check the film and replace it if necessary.
FUNCTION MODE	The <b>FUNCTION</b> key has been pressed.
LINE ERROR	Transmission or reception was not successful. Press <b>STOP</b> to clear the message, and then try again.
LINE IS IN USE	An extension phone connected to the fax is being used. Do not lift the fax's handset or attempt transmission at this time, as this will interrupt the conversation on the extension phone.
MEMORY IS FULL	The memory is full. See "Memory" in Chapter 8.
MEMORY PRINTING	The fax is preparing to or printing out a document from memory.
ON HOOK DIAL	The <b>SPEAKER</b> key has been pressed and the fax is waiting for you to dial.
OUT OF PAPER	You are out of printing paper.
OVER HEAT	The print head has overheated. Operation can be continued once it cools.
PAPER JAMMED	The printing paper is jammed. See the following section, "Clearing Paper Jams".

***Audible signals***

Continuous tone	3 seconds	Indicates the end of transmission, reception, or copying.
Intermittent tone (3 beeps)	5 seconds (1 second on, 1 second off)	Indicates incomplete transmission, reception, or copying.
Rapid intermittent tone	35 seconds (0.7 seconds on, 0.3 seconds off)	Indicates that the handset is off hook.

## Clearing Paper Jams

### Clearing a jammed document

If a document doesn't feed properly during transmission or copying, or DOCUMENT JAMMED appears in the display, first try pressing the **START** key. If the document doesn't feed out, open the operation panel (grasp the front edge at the "PANEL RELEASE" mark and pull up) and pull it out gently.

### Clearing jammed fax paper

- 1 Press the release marked **OPEN** and open the print compartment cover.
  - **Caution!** The printing head (the strip of metal on the underside of the frame) applies heat to the imaging film. It may be hot if a document has just been printed.

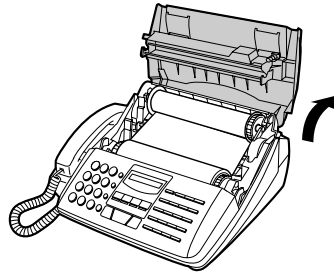

- 2 Remove the imaging film from the printing compartment and set it on a sheet of paper.

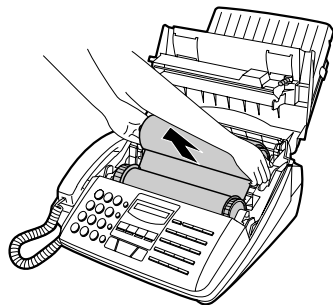

- 3** Gently pull the jammed paper out of the printing compartment.

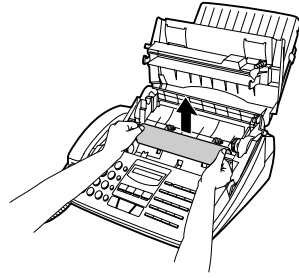

- 4** Replace the imaging film, making sure that the flange goes into the rear slot on the left side of the printing compartment. Also, make sure that the right, rear gear engages with the gear below it.

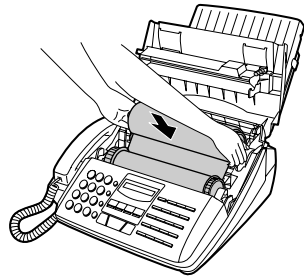

- 5** Wind the film slightly (rotate the gear on the right side of the rear spool) so that there is no slack in the film. Make sure that both edges of the film wind onto the spool evenly.

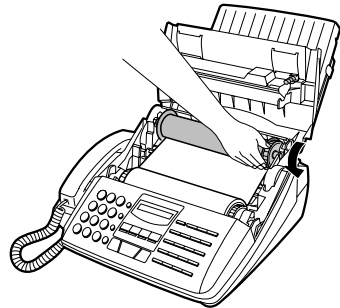

- 6** Close the print compartment cover, making sure it clicks into place.

- **Caution!** Close the cover slowly to make sure it doesn't pinch your fingers.

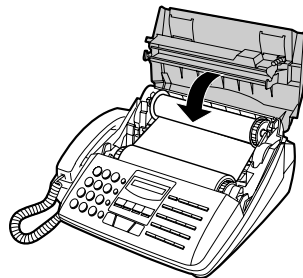



---

# Specifications

<b>Applicable telephone line:</b>	Public switched telephone network
<b>Compatibility:</b>	ITU-T (CCITT) G3 mode
<b>Configuration:</b>	Half-duplex, desktop transceiver
<b>Memory size*:</b>	512 KB (approx. 30 average pages with ECM function off)
<b>Compression scheme:</b>	MH, MR, MMR
<b>Scanning method:</b>	Flat-bed, solid-state CCD
<b>Resolution:</b>	Horizontal: 203 lines/inch (8 lines/mm) Vertical: Standard — 98 lines/inch (3.85 lines/mm) Fine /Halftone— 196 lines/inch (7.7 lines/mm) Super fine — 391 lines/inch (15.4 lines/mm)
<b>Recording system:</b>	Thermal transfer recording
<b>Display:</b>	7 x 5 dots, 1 line by 16-digit display
<b>Reception modes:</b>	Auto/Manual
<b>Modem speed:</b>	14400 bps with automatic fallback to 12000, 9600, 7200, 4800, or 2400 bps
<b>Transmission time*:</b>	Approx. 6 seconds
<b>Effective recording width:</b>	8.0" (203 mm) (average)
<b>Input document size:</b>	Automatic feeding: Width — 5.83 to 8.5" (148 to 216 mm) Length — 5.04 to 14" (128 to 356 mm) Manual feeding: Width — 5.83 to 8.5" (148 to 216 mm) Length — 5.04 to 39.4" (128 to 1000 mm)
<b>Effective scanning width:</b>	8.3" (210 mm) max.
<b>Automatic document feeder:</b>	20 sheets max.
<b>Halftone (gray scale):</b>	64 levels

\* Based on ITU-T Test Chart #1 at standard resolution in Sharp special mode, excluding time for protocol signals (i.e., ITU-T phase C time only).

---

## Specifications

<b>Contrast control:</b>	Automatic/Dark selectable
<b>Copy function:</b>	Single/Multi-copy/Sort-copy (99 copies/page)
<b>Telephone function:</b>	Standard (cannot be used if power fails)
<b>Power requirements:</b>	120 V AC, 60 Hz
<b>Operating environment:</b>	41 - 95°F (5 - 35°C), 20 to 80% RH
<b>Power consumption:</b>	Stand-by: 5 W Maximum: 100 W
<b>Dimensions:</b>	Width: 14.4" (365 mm) Depth: 13.9" (353 mm) Height: 7.6" (193 mm) (Without attachments)
<b>Weight:</b>	Approx. 10.4 lbs. (4.7 kg)

As a part of our policy of continuous improvement, SHARP reserves the right to make design and specification changes for product improvement without prior notice. The performance specification figures indicated are nominal values of production units. There may be some deviations from these values in individual units.

## MATERIAL SAFETY DATA SHEET

MSDS No. B-1006

### Section 1. Product Identification

Product Code: **UX-15CR Imaging Film**

### Section 2. Supplier's Name and Address

Sharp Corporation  
 22-22 Nagaïke-cho, Abeno-ku, Osaka, Japan  
 Local suppliers are listed below. Please contact the nearest supplier for additional information.

(Country)	(Name and Telephone Number)
U.S.A.	Sharp Electronics Corporation Telephone number for information : 201-529-8200 Emergency telephone number : 1-800-255-3924
Canada	Sharp Electronics of Canada Ltd. Telephone number for information : 416-890-2100 Emergency telephone number : 1-800-424-9300
United Kingdom	Sharp Electronics(U.K.)Ltd. Telephone number for information : 01923-474013

### Section 3. Ingredients

<u>Ingredients</u>	<u>CAS No.</u>	<u>Proportion</u>	<u>OSHA PEL</u>	<u>ACGIH TLV</u>	<u>Other Limits</u>
Polyethylene terephthalate	25038-59-9	51.0 %	-	-	-
Carbon black	1333-86-4	8.5 %	3.5mg/m <sup>3</sup>	3.5mg/m <sup>3</sup>	-
Ethylene-vinyl acetate copolymer	24937-78-8	3.1 %	-	-	-
Ester wax	8015-86-9	5.6 %	-	-	-
Parraffin wax	8002-74-2	12.5 %	-	2mg/m <sup>3</sup> (fume)	-
Microcrystalline wax	63231-60-7	15.2 %	-	-	-
Modified wax	8016-60-2	1.3 %	-	-	-
Polyester resin	27923-68-8	1.3 %	-	-	-
Others	-	1.5 %	-	-	-

### Section 4. Hazardous Identification (Emergency Overview)

This product is ink film for thermal transfer facsimile. "Ink film" is a thin film coated with ink. It is no special hazard under normal use condition.

### Section 5. Health Hazard Data

Route(s) of Entry:	Inhalation ?	Skin ?	Ingestion ?
	not applicable	not applicable	Possible but very unusual
Health Hazards:	The ingredients are not listed in ACGIH (1986) and OSHA (1989) except carbon black and paraffin wax		
Carcinogenicity:	In 1996 the IARC reevaluated carbon black as a Group 2B carcinogen (possible human carcinogen). This classification is given to chemicals for which there is inadequate human evidence, but sufficient animal evidence on which to base an opinion of carcinogenicity. The classification is based upon the development of lung tumors in rats receiving chronic inhalation exposures to free carbon black at levels that induce particle overload of the lung. Studies performed in animal models other than rats did not show any association between carbon black and lung tumors.		
Signs and Symptoms of Exposure:	not applicable		
Medical Conditions Generally Aggravated by Exposure:	not applicable		
Emergency and First Aid Procedures:	not applicable		

## MATERIAL SAFETY DATA SHEET

MSDS No. B-1006

### Section 6. Physical Chemical Characteristics

Boiling/Melting Point	m.p. about 70 °C for ink	Specific Gravity	about 1
Vapor Pressure	not applicable	Solubility	negligible (water)
Vapor Density	not applicable	PH	not applicable
Evaporation Rate	negligible	Viscosity	not applicable
Appearance	thin film coated with ink	Color	black
Odor	slight wax odor		

### Section 7. Fire and Explosion Data

Flash Point (Method Used):	about 250 °C for ink
Ignition Temperature:	not applicable
Flammable Limits:	not applicable (LEL); (UEL);
Extinguishing Media:	CO <sub>2</sub> , water, dry chemicals and form etc.
Special Fire Fighting Procedure:	none
Unusual Fire and Explosion Hazard:	none
Sensitivity to Mechanical Impact:	no hazardous effect by mechanical impact
Sensitivity to Static Charge:	not applicable

### Section 8. Reactivity Data

Stability:	Stable
Incompatibility (Materials to Avoid):	none
Hazardous Decomposition:	not applicable
Hazardous Polymerization:	not applicable

### Section 9. Precautions for Safe Handling and Use

Personal Protection Information (Respiratory, Eye Protection and Protective Glove):	not required
Engineering Control/Ventilation:	especially none
Work/Hygienic Practice:	especially none
Steps to be taken in case of Spill or Leak:	If rumple the product and wax layer peel off, sweep up or clean with vacuum cleaner. If it dirty skin, wash with water and soap. If it clothes, wash by suitable method.
Waste Disposal Method:	Dispose in an approved incinerator or contract with licensed chemical disposal agency. Ensure conformity with governmental disposal regulations. (Dispose by the same method of ordinary plastic products.)

### Section 10. Regulatory Information

NFPA Rating (U.S.A.):	no information
WHMIS Legislation (Canada):	not controlled
Transport Information:	no information
UN No.:	no information

### Section 11. Other information

Reference :	IARC (1996) Monographs on the Evaluation of the Carcinogenic Risk of Chemicals to Humans, Vol. 65, Printing Process and Printing inks, Carbon Black and Some Nitro Compounds, Lyon, pp-149-261 H. Muhle, B. Bellmann, O. Creutzenberg, C. Dasenbrock, H. Ernst, R. Kilpper, J. C. Mackenzie, P. Morrow, U. Mohr, S. Takenaka, and R. Mermelstein (1991) Pulmonary Response to Toner upon Chronic Inhalation Exposure in Rats. Fundamental and Applied Toxicology 17, pp. 280-299
-------------	--

---

## ***FCC Regulatory Information***

This equipment complies with FCC rules, Part 68. On this equipment is a label that contains, among other information, the FCC Registration Number and Ringer Equivalence Number (REN) for this equipment. If requested, this information must be provided to your telephone company.

An FCC compliant telephone cord and modular plug is provided with this equipment. This equipment is designed to be connected to the telephone network or premises wiring using a compatible modular jack which is Part 68 compliant. This equipment connects to the telephone network through a standard USOC RJ-11C network interface jack.

The REN is used to determine the quantity of devices which may be connected to your telephone line and still have all of those devices ring when your number is called. Too many devices on one line may result in the devices not ringing in response to an incoming call. In most, but not all, areas the sum of the RENs of all devices should not exceed five (5.0). To be certain of the number of devices that may be connected to your line, as determined by the total RENs, contact your local telephone company.

If this equipment causes harm to the telephone network, your telephone company may disconnect your service temporarily. If possible, they will notify you in advance. If advance notice is not practical, you will be notified as soon as possible. You will also be advised of your right to file a complaint with the FCC.

Your telephone company may make changes in its facilities, equipment, operations, or procedures that could affect the operation of your equipment. If this happens, the telephone company will provide advance notice in order for you to make necessary modifications to maintain uninterrupted service.

If you have any questions or problems which cannot be solved by reading this manual, please contact Sharp's Customer Information Center. The number is 1-800-BE SHARP. If the equipment is causing harm to the telephone network, your telephone company may ask you to disconnect the equipment until the problem resolved.

This equipment may not be used on coin service provided by the telephone company. Connection to party lines is subject to state tariffs. Contact your state's public utility commission, public service commission, or corporation commission for more information.

This equipment is hearing-aid compatible.

When programming and/or making test calls to emergency numbers:

- Remain on the line and briefly explain to the dispatcher the reason for the call.
- Perform such activities in the off-peak hours, such as early morning or late evening.

# Guía de Consulta Rápida

## Instalación

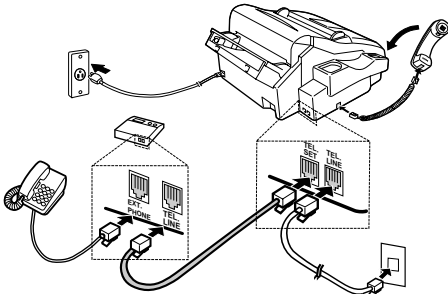

1. Conecte el microteléfono como se muestra.
2. Conecte la toma **TEL LINE** a su toma telefónica de la pared.
3. Enchufe la unidad en su toma de CA de la pared.

## Instalación con un telefono de extension

4. Remueva el sello que cubre la toma **TEL SET** del panel trasero del facsimile. Conecte el teléfono de extensión en la toma **TEL SET**.

## Instalación con un contestador automático y un telefono de extension

5. Conecte la toma **TEL LINE** del contestador automático a la toma **TEL SET** del facsimile.

## Introducción de su Nombre y Número

La ley exige que su nombre y número de fax aparezcan en todos los documentos que envíe. Para programar su fax de forma que haga esto automáticamente, siga los pasos siguientes:

1. Presione **FUNCTION** y luego presione "3":

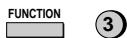

ENTRY MODE aparece en el visualizador.

2. Luego, presione dos veces la tecla #:



OWN NUMBER SET aparece en el visualizador.

3. Presione: **START** 
4. Introduzca su número de fax empleando el teclado. Se pueden introducir un máximo de 20 dígitos.

◆ Si se equivocó, presione la tecla **HOLD/SEARCH** para mover el cursor al error. Al introducir el dato correcto, se borra el error.

5. Presione la tecla de inicio: **START** 
6. Introduzca su nombre empleando el teclado.

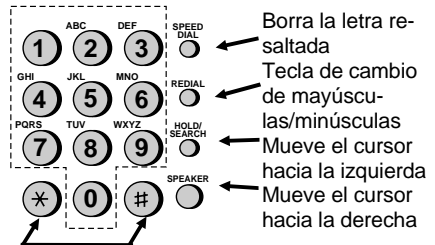

Para desplazarse a través del grupo de símbolos.

- ◆ Emplee "1" para dejar un espacio.
- ◆ Para introducir dos letras seguidas que requieren emplear la misma tecla, presione la tecla **SPEAKER** después de introducir la primera letra.

Ejemplo: Para escribir "ABZ Co.", presione: "2" dos veces para la letra A,

Presione **SPEAKER** para mover el cursor hacia la derecha.

"2" tres veces para la letra B,

"9" cinco veces para la letra Z,



"1" dos veces para un espacio,

"2" cuatro veces para la letra C,

Presione **REDIAL** para letras minúsculas,

"6" cuatro veces para la letra o,

"#" una vez para un punto.

7. Presione:  

# Guía de Consulta Rápida

## Inserción de Fecha y Hora

Para insertar la fecha y la hora, presione las teclas siguientes en el orden indicado:



El visualizador mostrará: DATE & TIME SET

Presione: **START**

Introducir dos dígitos para el mes (01 al 12)

Introducir dos dígitos para el día del mes (01 al 31)

Introducir dos dígitos para el año (00 al 99)

Introducir dos dígitos para la hora (01 al 12)

Introducir dos dígitos para el minuto (00 al 59)

Presionar: "\*" para AM o "#" para PM

Después de introducir todos los caracteres, presione: **START** y luego **STOP**:

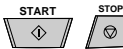

## Memorización y Borrado de Números de las Marcas Automáticas

Para memorizar números o cambiar números que ya no están vigentes, presione las teclas siguientes en el orden indicado:

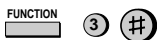

El visualizador mostrará: FAX/TEL # MODE

1. Presione : "1"
2. Introducir un número de dos dígitos ("01" a "99") para designar el número de discado rápido. Este será el número de dos dígitos que usted empleará para marcar el número deseado.
3. Introducir el número de fax/telefono.
4. Presione: **START**
5. Introducir el nombre del lugar o persona al que este número de ha sido asignado (un máximo de 20 caracteres).
6. Presione: **START**
7. Repita los pasos 1 al 3 para continuar insertando en memoria los números deseados. Para abandonar esta función, presione **STOP**.

Para borrar un número de discado automático, presione las teclas siguientes en el orden indicado



Presione "2" y luego introduzca un número de dos dígitos para asignar el número de discado rápido:

Presione:

## Envío de Documentos

Inserte su documento (hasta 20 páginas) con el lado impreso hacia abajo en el alimentador de documentos.

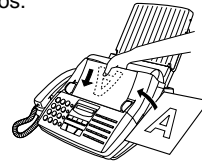

## Discado Normal

1. Levante el teléfono y presione
2. Marque el número de fax, empleando el teclado.
3. Espere a oír el tono (en caso de que alguna persona conteste, pedir que le dé tono) y entonces presionar **START**.
4. Presione **START** y cuelgue el teléfono.

## Discado con Teclas Rápidas

Para discar a través de teclas rápidas, presione la tecla correspondiente (si la tecla es de 20 a 38, pulse primero la tecla **SHIFT**). La transmisión comenzará de manera automática.

## Discado Veloz

1. Presione la tecla **SPEED DIAL**
2. Introduzca el número de discado rápido asignado presionando el teclado.
3. Presione **START**

## Discado directo - Usando el Teclado

1. Disque el número de fax correspondiente.
2. Presione **START**

# Guía de Consulta Rápida

## Recepción de documentos

Presione RECEPTION MODE hasta que AUTO o MANU aparezca en el visualizador.

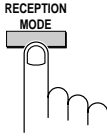

**Recepción AUTO:** El fax suena cuatro veces y comienza a recibir los documentos que entran.

**Recepción MANUAL:** Levante el teléfono cuando suena el fax. Cuando se oiga un tono de fax, presione **START** y cuelgue el receptor, o puede esperar a que aparezca RECEIVING en el visualizador, entonces cuelgue.

## Cargar el papel

1. Si todavía no está instalada, insertar la bandeja de papel en el fax.
  2. Retirar la cubierta, si se encuentra en la bandeja. (Para papel de tamaño folio, levantar la pieza de prolongación de la bandeja.)
  3. Tire hacia adelante de la placa de retención del papel.
- ◆ Si todavía queda papel en la bandeja, sáquelo y póngalo junto con la nueva pila de papel.

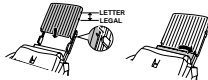
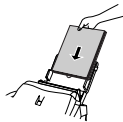

4. Coloque la pila de papel en la bandeja; coloque la tapa y empuje hacia abajo la placa de retención del papel.

5. Ahora pulse las teclas así:



Si ha cargado papel de tamaño estándar pulse "1"; si el papel es de tamaño folio, pulse "2".

Al terminar pulse:



## Instalar la película de impresión

1. Presione el dispositivo soltador marcado **OPEN** y abra la tapa del compartimiento de impresión.
2. Inserte dos de las ruedecillas en los extremos de la bobina de película.

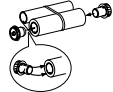

3. Tome la bobina vacía de tal forma que el extremo que tiene una sola ranura quede a la izquierda; introduzca las bobinas en el compartimiento de impresión de tal forma que las ruedecillas encajen en las ranuras que hay a cada lado del compartimiento.

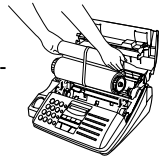

4. Con unas tijeras corte la cinta que retiene las bobinas juntas y retírela. Introduzca la ruedecilla restante en el extremo derecho de la bobina vacía y el saliente en el extremo izquierdo de la misma bobina.

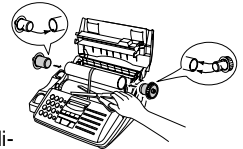

5. Tire de la bobina vacía hacia el fondo del compartimiento, desenrollando la parte anterior de la bobina de película. Inserte la bobina vacía en el compartimiento de forma que la ruedecilla y la bobina encajen en las ranuras que hay a ambos lados del compartimiento.

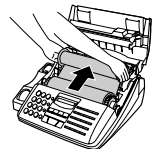

6. Enrolle la película ligeramente para templarla; cierre luego la tapa del compartimiento de impresión.

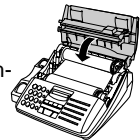

7. Si ha sustituido la película, pulse las teclas siguientes (procedimiento no necesario para la película de muestra incluida con el fax):





---

# Index

## A

- Activity Report, 78
  - Automatic printing, 77
- Answering machine hookup
  - Connecting, 6
  - Fax answer when TAD fails, 57
  - Problems, 53
  - Quiet Detect Time, 52, 56
  - TAD connection setting, 51
  - Touch-tone fax activation, 54
- Anti Junk Fax, 58, 77
- Anti Junk Number List, 82
- Audible signals, 90
- Auto cover sheet, 77
- Auto reception mode, 23, 42
- Automatic dialing, 27, 39

## B

- Batch Page Numbering, 36
- Broadcasting, 62

## C

- Cleaning, 84 - 85
- Computer, connecting to, 8
- Contrast, 34
- Copies, 45
- Copy Cut-off setting, 47
- Copy/Help key, 17, 45
- Cover sheet, 35, 77

## D

- Date, setting, 21
- Dial mode, 75
- Dialing
  - Direct Keypad, 38
  - Normal, 37, 48
  - Rapid Key, 39, 48
  - Search, 40, 49
  - Speed, 39, 48

- Direct Keypad Dialing, 38
- Display, 17
- Display messages, 89
- Distinctive Ring, 25
- Document feeder, 33
- Document guides, 33
- Document restrictions, 32
- Document rollers, 85
- Document sizes, 32
- Document, maximum scanning size, 32

## E

- Electrical outlet, 6
- Error Correction Mode, 77
- Extension telephone, connecting, 6
- Extension telephone, using, 43

## F

- Fine Resolution Priority, 74
- Function key, 17

## G

- Group Keys
  - Storing, 30
  - Using, 63

## H

- Halftone, 34
- Handset, 7
- Handset receiver volume, 31
- Hold, 49
- Hold/Search key, 16, 40, 49
- Housing, cleaning, 85

## I

- Imaging film
  - Loading, 2
  - Replacing, 5
- Initialize Film setting, 5

## J

- Jams, clearing, 91
- Junk fax number check, 77

## L

- Letters, entering, 19
- Loading the document, 33

## M

- Manual reception mode, 23, 42
- Memory, 60
  - Transmission, 60
- Memory key, 17, 60
- Multifunction Interface software, installing, 9
- Multifunction Interface, connecting, 8

## N

- Normal dialing, 37, 48
- Number keys, 16
- Number of rings in Auto reception mode, 74

## O

- Option Setting List, 81

## P

- Paper jams, clearing, 91
- Paper Size setting, 14
- Paper Type setting, 14
- Passcode List, 81
- Pauses, auto-dial, 27
- Polling, 64 - 66
- Power cord, 6
- Print head, cleaning, 84
- Print Setup List, 83
- Program and Group List, 82
- Programs, 69

## R

- Rapid Dial Keys, 17
- Rapid Key Dialing, 39, 48
- Recall Times, 75
- Recall Wait Interval, 75
- Receive Unit setting, 24
- Reception mode
  - Auto, 23, 42
  - Manual, 23, 42
  - Setting, 23
- Reception mode key, 17, 23
- Reception Ratio setting, 44
- Redial key, 16, 27, 41, 49
- Redialing, 41, 49
- Resolution, 34
- Resolution key, 17, 34
- Ringling volume, 31
- Rollers, cleaning, 85

## S

- Scanning glass, cleaning, 85
- Search Dialing, 40, 49
- Sender's name and number, entering, 18
- Speaker key, 16, 31, 37, 48
- Speaker volume, 31
- Speed Dial key, 16, 39, 48
- Speed Dialing, 39, 48
- Start key, 17
- Stop key, 17
- Storing numbers for automatic dialing, 27

## T

- TEL. LINE jack, 7
- TEL. SET jack, 6
- Tel/Fax Remote Number, 75
- Telephone line cord, 7
- Telephone Number List, 81
- Telephone, using as, 48
- Time, setting, 21

Timer List, 80  
Timer operations, 67  
Transaction Report, 83  
Transaction Report Print Select, 75  
Two-in-one printing, 44

## **V**

Volume keys, 31



# LIMITED WARRANTY

SHARP ELECTRONICS CORPORATION warrants to the first end user purchaser that this Sharp brand product (the "Product"), when shipped in its original container, will be free from defective workmanship and materials, and agrees that it will, at its option, either repair the defect or replace the defective Product or part thereof with a new or remanufactured equivalent at no charge to the purchaser for parts or labor for the period(s) set forth below.

This warranty does not apply to any appearance items of the Product nor to the additional excluded item(s) set forth below nor to any product the exterior of which has been damaged or defaced, which has been subjected to misuse, abnormal service or handling, or which has been altered or modified in design or construction.

In order to enforce the rights under this limited warranty, the purchaser should follow the steps set forth below and provided proof of purchase to the servicer.

To the extent permitted by applicable state law, the warranties set forth herein are in lieu of, and exclusive of, all other warranties, express or implied. Specifically, ALL OTHER WARRANTIES OTHER THAN THOSE SET FORTH ABOVE ARE EXCLUDED. ALL EXPRESS AND IMPLIED WARRANTIES INCLUDING THE WARRANTIES OF MERCHANTABILITY, FITNESS FOR USE, AND FITNESS FOR A PARTICULAR PURPOSE ARE SPECIFICALLY EXCLUDED. If, under applicable state law, implied warranties may not validly be disclaimed or excluded, the duration of such implied warranties is limited to the period(s) from the date of purchase set forth below.

Neither the sales personnel of the seller nor any other person is authorized to make any warranties other than those described above, or to extend the duration of any warranties beyond the time period described above on behalf of Sharp.

The warranties described herein shall be the sole and exclusive warranties granted by Sharp and shall be the sole and exclusive remedy available to the purchaser. Correction of defects, in the manner and for the period of time described herein, shall constitute complete fulfillment of all liabilities and responsibilities of Sharp to the purchaser with respect to the Product, and shall constitute full satisfaction of all claims, whether based on contract, negligence, strict liability or otherwise. In no event shall Sharp be liable, or in any way responsible, for any damages or defects in the Product which were caused by repairs or attempted repairs performed by anyone other than an authorized servicer. Nor shall Sharp be liable or in any way responsible for any incidental or consequential economic or property damage. Some states do not allow limits on warranties or on remedies for breach in certain transactions; in such state the limits herein may not apply.

Your Product:

Warranty Period for this Product:

Additional items excluded from warranty coverage:

Where to obtain service:

What to do to obtain service:

Personal Facsimile

Ninety (90) days parts and labor from date of purchase.

Any consumable items such as paper supplied with the Product.

At a Sharp Authorized Servicer located in the United States. To find out the location of the nearest Sharp Authorized Servicer, call Sharp toll free at 1--800-BE-SHARP.

Ship (prepaid) or carry in your Product to a Sharp Authorized Servicer. Be sure to have proof of purchase available. If you ship or mail the Product, be sure it is packaged carefully.

For product information or customer assistance, please visit <http://www.sharp-usa.com> on the World Wide Web or call **1-800-BE SHARP**.

## SHARP ELECTRONICS CORPORATION

Sharp Plaza,  
Mahwah, New Jersey 07430-2135

**SHARP®**

**SHARP ELECTRONICS CORPORATION**

**Sharp Plaza, Mahwah, New Jersey 07430-2135**

**SHARP CORPORATION**

PRINTED IN THAILAND  
(TINSE3728XH2B)

## Free Manuals Download Website

<http://myh66.com>

<http://usermanuals.us>

<http://www.somanuals.com>

<http://www.4manuals.cc>

<http://www.manual-lib.com>

<http://www.404manual.com>

<http://www.luxmanual.com>

<http://aubethermostatmanual.com>

Golf course search by state

<http://golfingnear.com>

Email search by domain

<http://emailbydomain.com>

Auto manuals search

<http://auto.somanuals.com>

TV manuals search

<http://tv.somanuals.com>