

MODEL
FO-5900

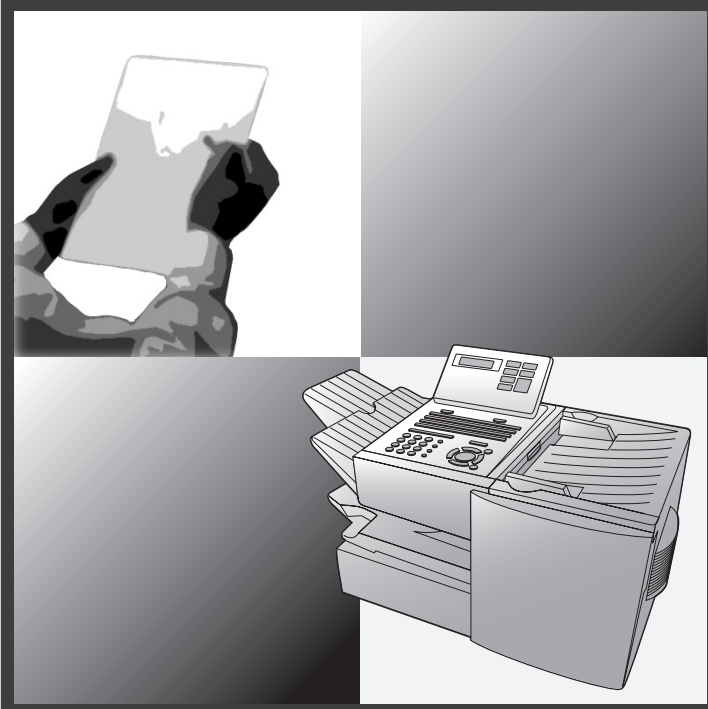

FACSIMILE
OPERATION MANUAL

1. Installation
2. Sending Documents
3. Receiving Documents
4. Making Copies
5. Special Functions
6. Optional Settings
7. Printing Lists
8. Maintenance
9. Troubleshooting

SHARP®

SHARP

WARRANTY

Facsimile Products

Congratulations on Your Purchase!

This Sharp product is warranted against manufacturing defects for a period of twelve (12) months from the date of original purchase.

In the event of any defect arising in the equipment during the warranty period, such repairs should only be carried out by the Dealer from which the unit was originally purchased or a Service Centre approved by Sharp to service this type of equipment. These repairs would be carried out at no charge to the owner, subject to the conditions specified herein.

The owner is responsible for any transportation and insurance costs if the product has to be returned for repair.

This warranty does not extend to accessories or defects or injuries caused by or resulting from causes not attributable to faulty parts or the manufacture of the product, including but not limited to, defect or injury caused by or resulting from misuse, abuse, neglect, accidental damage, improper voltage, liquid spillage, vermin infestation, software, use of consumables other than those approved by Sharp, or any alterations made to the product which are not authorised by Sharp.

Please retain your sales documentation, as this should be produced to validate a warranty claim.

This warranty is in addition to and in no way limits, varies or excludes any express and implied rights and remedies under any relevant legislation in the country of sale. However, to the extent permitted by such legislation, Sharp excludes any liability for any indirect or consequential damages arising from the purchase or use of the product.

To the extent permitted by law, Sharp excludes all implied warranties and conditions and where the product is one that is not normally required for personal, domestic or household use, Sharp limits its liability to the repair or replacement (at Sharp's option) of materials or workmanship which are found by Sharp to be defective.

For your reference, please enter the particulars of your purchase below and retain, with your purchase documentation.

Model No. _____

Serial No. _____

Date of Purchase _____

Place of Purchase _____

SPform046 (Dec2001)

FOR LOCATION ENQUIRIES WITHIN
AUSTRALIA
REGARDING YOUR LOCAL
SHARP APPROVED SERVICE CENTRE

CALL SHARP

LOCAL CALL: **1 300 135 022**
FACSIMILE: (02) 9672 1210

WEB: www.sharp.net.au

SHARP CORPORATION OF AUSTRALIA PTY. LIMITED
A.B.N. 40 003 039 405
1 Huntingwood Drive, Huntingwood NSW 2148

FOR THE SERVICING OF PRODUCTS
PURCHASED IN
NEW ZEALAND
CONTACT YOUR SELLING DEALER/RETAILER
OR FOR REFERRAL TO A
SERVICE CENTRE,
CALL SHARP CUSTOMER SERVICES
TELEPHONE: **09 573 0111**
FACSIMILE: 09 573 0113
WEB: www.sharpnz.co.nz

SHARP CORPORATION OF NEW ZEALAND LIMITED
59 Hugo Johnston Drive Penrose, Auckland

Introduction

Welcome, and thank you for choosing a Sharp facsimile machine. The features and specifications of your new Sharp fax machine are shown below.

Automatic dialling	Conventional Auto Dialling: Rapid Key Dialling: 59 numbers Speed Dialling: 75 numbers Personal Auto Dial Books: 10 books (59 Rapid Keys, 16 Speed Dial numbers per book)
Memory size*	2 MB (approx. 124 pages) Optional memory: FO-8MK (8 MB; approx. 500 pages)
Modem speed	33,600 bps (max.) with automatic fallback to lower speeds.
Transmission time*	Approx. 2 seconds
Toner cartridge yield (continuous printing, 4% page coverage, A4 paper)	Initial starter cartridge (included with fax machine): Approx. 3000 pages Replacement cartridge FO-59DC: Approx. 6000 pages
Drum cartridge yield	Initial starter cartridge (included with fax machine): 20,000 pages (ave.) Replacement cartridge (FO-47DR): 20,000 pages (ave.)
Resolution	Horizontal: 8 pels/mm Vertical: Standard: 3.85 lines/mm Fine/Halftone: 7.7 lines/mm Super fine: 15.4 lines mm
Automatic document feeder	A4 paper (80 g/m ²): Max. 50 pages
Paper capacity	250 sheets (80 g/m ²) (500-sheet cassette available as option)

*Based on ITU-T Test Chart #1 at standard resolution, excluding time for protocol signals (i.e., ITU-T phase C time only).

Compression scheme	MMR, MR, MH, Sharp (H2), JBIG
Halftone (grayscale)	64 levels
Applicable telephone line	Public switched telephone network
Compatibility	ITU-T (CCITT) G3 mode, Super G3 mode
Printing resolution	Horizontal: 16 lines/mm Vertical: 15.4 lines/mm
Input document size	Automatic feeding: Width: 148 to 256 mm Length: 128 to 364 mm Manual feeding: Width: 148 to 279 mm Length: 128 to 483 mm
Effective Scanning width	208 mm max.
Effective Printing width	203 mm max.
Reception modes	Auto/Manual
Instascan speed	1.3 sec/page (A4 paper; scan time only, excludes document feeding time)
Full Dual Access	Yes
Copy function	Single/Multi/Sort (99 copies/page)
Power requirements	230-240 V AC, 50 Hz
Operating temperature	10 - 30°C
Humidity	20 to 85% RH
Power consumption	Standby: 9 W Maximum: 760 W
Dimensions	Width: 546 mm Depth: 412 mm Height: 346 mm (Not including paper tray or attachments)
Weight	Approx. 14.2 kg (Not including supplies, paper tray or attachments)

As a part of our policy of continuous improvement, SHARP reserves the right to make design and specification changes for product improvement without prior notice. The performance specification figures indicated are nominal values of production units. There may be some deviations from these values in individual units.

Important safety information

Be sure to save these instructions!

For your safety, if any of your equipment is not operating properly or should any physical damage occur to the equipment where internal parts may become exposed, the equipment should be immediately disconnected from the phone line and then the power line and returned to a SHARP authorised Service Centre for inspection, repair, or disposal.

In Australia, installing or modifying telephone lines should only be done by an ACA licensed serviceman. In New Zealand, installing or modifying telephone lines should be done in accordance with Telecom wiring practices.

This facsimile machine is designed for use in Australia and New Zealand only.

When using your facsimile equipment, basic safety precautions should always be followed to reduce the risk of fire, electric shock and injury to persons, including the following:

- Do not disassemble this machine or attempt any procedures not described in this manual. Refer all servicing to qualified service personnel.
- This machine must only be connected to a 230-240 V, 50 Hz, earthed (3-prong) outlet. Connecting it to any other kind of outlet will damage the machine and invalidate the warranty.
- Do not install or use the machine near water, or when you are wet. For example, do not use the machine near a bath tub, wash bowl, kitchen sink or laundry tub, in a wet basement, or near a swimming pool. Take care not to spill any liquids on the machine.
- Use only the power cord provided with the facsimile machine. Do not use an AC extension cord.
- Unplug the machine from the telephone socket and then the power outlet and consult a qualified service representative if any of the following situations occur:
 - Liquid has been spilled into the machine or the machine has been exposed to rain or water.
 - The machine produces odors, smoke, or unusual noises.
 - The power cord is frayed or damaged.
 - The machine has been dropped or the housing damaged.

- Do not allow anything to rest on the power cord, and do not install the machine where people may walk on the power cord.
- Never insert objects of any kind into slots or openings on the machine. This could create a risk of fire or electric shock. If an object falls into the machine that you cannot safely remove, unplug the machine and consult a qualified service representative.
- Do not place this machine on an unstable cart, stand or table. The machine could be seriously damaged if it falls.
- Avoid using a telephone (other than a cordless type) during an electrical storm. There may be a remote risk of electric shock from lightning.
- Do not use a telephone to report a gas leak in the vicinity of the leak.
- The power outlet must be installed near the equipment and must be easily accessible.

Important:

- This facsimile machine is not designed for use on a line which has call waiting, call forwarding, or certain other special services offered by your telephone company. If you attempt to use the fax machine in conjunction with any of these services, you may experience errors during transmission and reception of facsimile messages.
- This machine is not compatible with digital telephone systems.

WARNING NOTICE:

NO calls can be made to or from this fax machine during a mains power failure.

WARNING: Australian Communications Authority (ACA) regulations state that no unauthorised changes or modifications to this equipment are permitted.

Note: Complies with ACA and NZ TELECOM standard AS/NZS3548 regarding emission of electromagnetic interference.

These limits are designed to provide reasonable protection against interference in an installation. This equipment generates, uses, and can radiate radio frequency energy and, if not installed and used in accordance with the instructions, may cause interference. However, there is no guarantee that interference will not occur in a particular installation.

If this equipment does cause interference to radio or television reception, which can be determined by turning the equipment off and on, the user is encouraged to try to correct the interference by one or more of the following measures:

- Reorient or relocate the receiving antenna.
- Increase the separation between the equipment and the receiver.
- Connect the equipment to an outlet on a different circuit to that which the receiver is connected.
- Consult the dealer or an experienced radio/TV technician for help.

For Australia: The Ringer Equivalence Number (REN) for this equipment is written on the back of the machine. The sum of all Ringer Equivalence Numbers (REN's) on your telephone line should not exceed 3 to assure correct service from your telephone company.

IMPORTANT NOTICE FOR NEW ZEALAND USERS

Please note:

The grant of a Telepermit for any item of terminal equipment indicates only that Telecom has accepted that the item complies with the minimum conditions for connection to its network. It indicates no endorsement of the product by Telecom, nor does it provide any sort of warranty. Above all, it provides no assurance that any item will work correctly in all respects with another item of Telepermitted equipment of a different make or model, nor does it imply that any product is compatible with all of Telecom's network services.

This equipment shall not be set up to make automatic calls to the Telecom `111' Emergency Service.

To avoid telephone charges for local calls, be sure to store numbers without area code in your auto-dial locations.

This equipment may not provide for the effective hand-over of a call to another device connected to the same line.

Table of Contents

Introduction	1
Important safety information	3
Table of Contents	6
A Look at the Operation Panel	8
1. Installation	13
Unpacking Checklist	13
Connections	14
Installing the Print Cartridges	17
Loading Printing Paper	21
Entering Your Name and Fax Number	24
Setting the Date and Time	26
Volume Adjustment	28
2. Sending Documents	30
Transmittable Documents	30
Loading the Document	32
Adjusting the Resolution and Contrast	33
Sending a Fax by Normal Dialling	35
Programming Auto-Dial Numbers	36
Sending a Fax by Automatic Dialling	41
Creating and Using Personal Books	50
Cover Sheet	55
Batch Page Numbering	57
3. Receiving Documents	58
Using AUTO Reception Mode	58
Using MANUAL Reception Mode	59
Substitute Reception to Memory	60
4. Making Copies	61

5. Special Functions	63
Broadcasting	63
Confidential Operations	67
Polling	71
Timer Operations	77
Batch Transmission	83
Entering and Using Programs	85
Duplex Scanning for Two-sided Documents	94
Department Control	95
Blocking Reception of Unwanted Faxes	97
Distinctive Ring (Requires Subscription to Service)	98
6. Optional Settings	99
7. Printing Lists and Reports	107
8. Maintenance	112
Cleaning the Scanning Glass and Rollers	112
The Housing	112
Replacing the Verification Stamp	113
9. Troubleshooting	114
Problems and Solutions	114
Messages and Signals	119
Clearing Paper Jams	122
QUICK REFERENCE GUIDE	125
Index	126

A Look at the Operation Panel

Upper panel

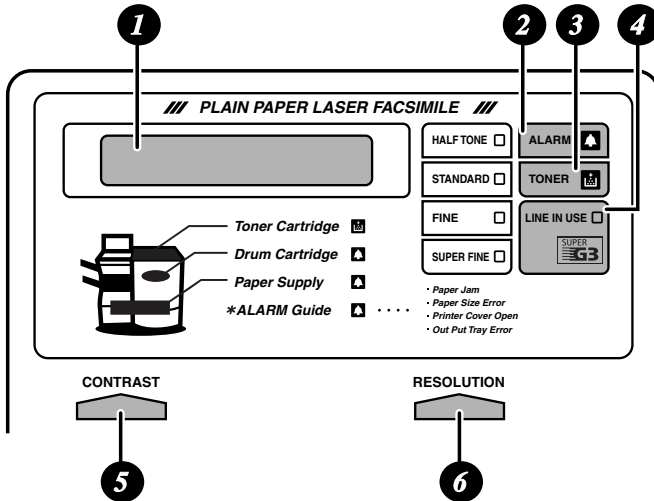

- 1 Display**
This displays messages and prompts to help you operate the machine.
- 2 ALARM indicator**
This blinks when one of the paper sources is empty or the drum cartridge is near the end of its life (printing is still possible). This lights steadily when the drum cartridge has reached the end of its life, all paper sources are empty, the print compartment cover is open, or a paper jam has occurred (printing is not possible). A message will appear in the display to indicate the problem.
- 3 TONER indicator**
This blinks when the toner cartridge nears empty, and lights steadily when the toner cartridge needs replacement.
- 4 LINE IN USE light**
This lights when the fax machine is using the telephone line.
- 5 CONTRAST key**
Press this key to adjust the contrast before sending or copying a document.
- 6 RESOLUTION key**
Press this key to adjust the resolution before sending or copying a document. An indicator will light next to the selected setting (HALFTONE, STANDARD, FINE or SUPER FINE).

Middle panel (Rapid Key pad)

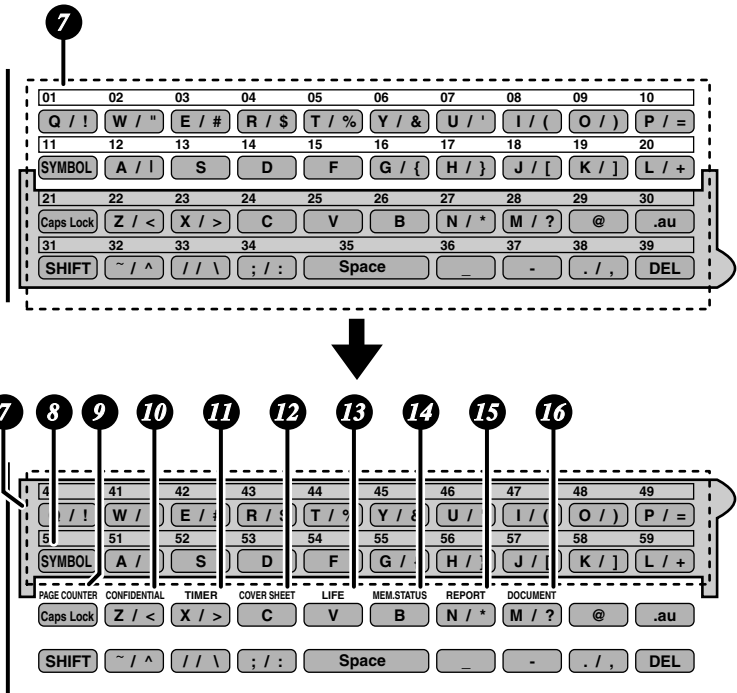

7 Rapid Dial Keys

Press one of these keys to dial a fax number automatically. (Note that you must attach the Rapid Key labels.) When navigating through the display menu, a Rapid Key can also be pressed in place of the numeric keys to enter a two-digit number (for example, you can press Rapid Key 01 to enter the number "01").

8 SYMBOL key

When entering a name, press this key to enter the symbol on a letter key (the character to the right of the slash). Press the key again to turn off symbol entry mode.

9 PAGE COUNTER key

Press this key to include a slash and the total number of pages after each page number on the pages of a transmitted document.

10 CONFIDENTIAL key

Press this key to send or print out a confidential document.

- 11** **TIMER key**
Press this key to set an operation to be performed automatically at a later time.
- 12** **COVER SHEET key**
Press this key to include a cover sheet when sending a fax.
- 13** **LIFE key**
Press this key, followed by **1**, to check the total number of pages printed by the fax machine.
- 14** **MEM. STATUS key**
Press this key to check the status of fax transmission jobs, copy jobs, and fax receptions. This key can also be used to cancel a job.
- 15** **REPORT key**
Press this key to print out a report on the most recently completed transmission or reception.
- 16** **DOCUMENT key**
Press this key to transmit a document directly from the feeder without reading it into memory.

Lower panel

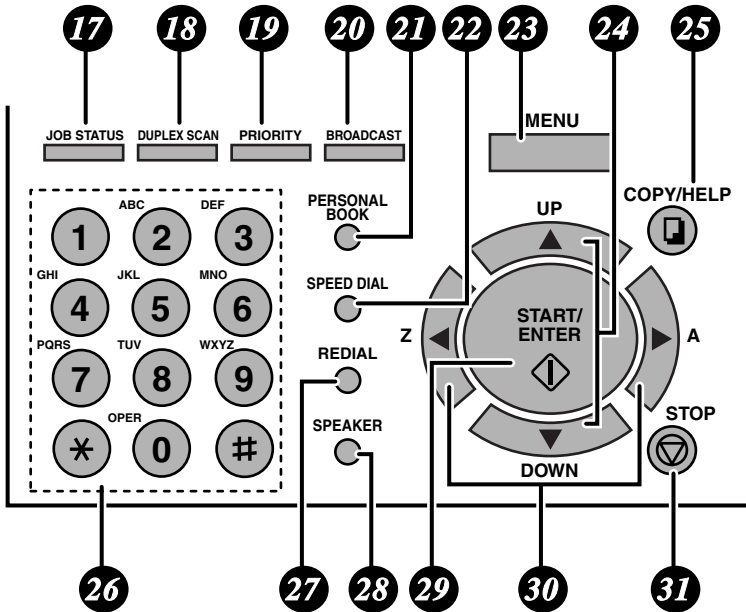

- 17** **JOB STATUS key**
Two types of information appear in the display: prompts related to operations you are performing, and information about how the fax machine is using the telephone line (transmitting, receiving, etc.). Press this key to change between the two types of information.
- 18** **DUPLEX SCAN key**
Press this key to transmit or copy a two-sided document.
- 19** **PRIORITY key**
Press this key when you need to transmit a document ahead of other documents waiting in memory for transmission.
- 20** **BROADCAST key**
Press this key to send a fax to a group of receiving fax machines.

21

PERSONAL BOOK

Press this key to use or store an auto-dial number in a personal book. If the book has a passcode, enter the passcode; otherwise, select the book with

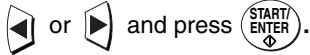

22

SPEED DIAL key

Press this key to dial a Speed Dial number.

23

MENU key

Press this key to select special functions and settings.

24

UP and DOWN arrow keys

Volume setting: Press these keys to change the speaker volume when the **SPEAKER** key has been pressed, or the ringer volume at any other time.

25

COPY/HELP key

When a document is in the feeder, press this key to make a copy of a document. At any other time, press this key to print out the Help List, a quick reference guide to the operation of your fax machine.

26

Dial keypad (numeric keys)

Use these keys to dial and program fax numbers.

27

REDIAL key

Press this key to automatically redial the last number dialed.

28

SPEAKER key

Press this key when transmitting a document by Normal Dialling to listen to the line and verify the response of the receiving fax machine.

29

START/ENTER key

Press this key to begin fax transmission when using Speed Dialling, Direct Keypad Dialling, or Normal Dialling. This key is also used to select settings and complete entries when storing names and numbers.

30

Left and right arrow keys

Auto-dial numbers: Press these keys to search for an auto-dial number when sending a fax.

MENU key settings: Press these keys after pressing the **MENU** key to scroll through the **MENU** key settings.

31

STOP key

Press this key to cancel an operation before it is completed.

1. Installation

Unpacking Checklist

Before setting up, make sure you have all of the following items. If any are missing, contact your dealer.

Power cord



Telephone line cord



Toner cartridge

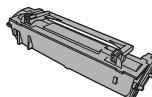

Drum cartridge

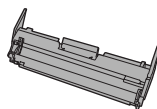

ADF exit tray

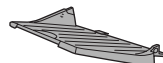

Received document tray



Rapid Key labels



Paper size labels



Adaptor (for Australia)

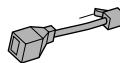

Adaptor (for New Zealand)

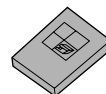

Operation manual

Points to keep in mind when setting up

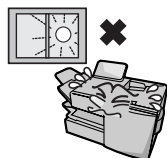

Do not place the machine in direct sunlight.

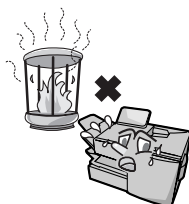

Do not place the machine near heaters or air conditioners.

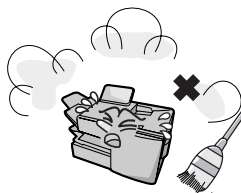

Keep dust away from the machine.

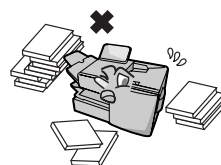

Keep the area around the machine clear.

About condensation

If the machine is moved from a cold to a warm place, it is possible that condensation may form on the scanning glass, preventing proper scanning of documents for transmission. To remove the condensation, turn on the power and wait approximately two hours before using the machine.

Connections

Connecting the power cord

Connect the female end of the power cord to the fax machine as shown. Insert the male end into a 230-240 V, 50 Hz, earthed (3-prong) AC outlet.

Important!

The fax machine requires its own dedicated power outlet. The power outlet must not be shared with any other devices. In particular, do not use an extension cord to connect multiple devices to the outlet.

- ◆ The power outlet must be installed near the machine and must be easily accessible.
- ◆ When disconnecting the machine, unplug the telephone line cord before unplugging the power cord.

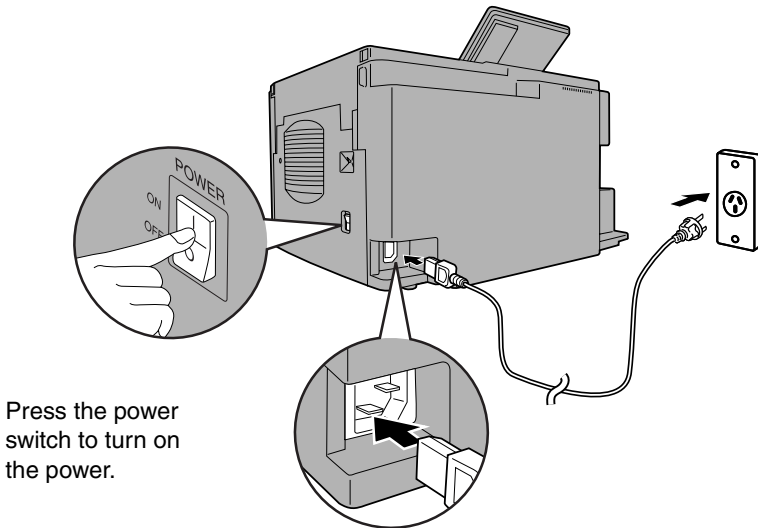

Note: If your area experiences a high incidence of lightning or power surges, we recommend that you install surge protectors for the power and telephone lines. Surge protectors can be purchased at most telephone specialty stores.

Connecting the telephone line cord

Insert one end of the telephone line cord into the adaptor. Insert the other end of the line cord into the socket on the back of the machine marked **TEL. LINE**. Plug the adaptor into the telephone socket on the wall.

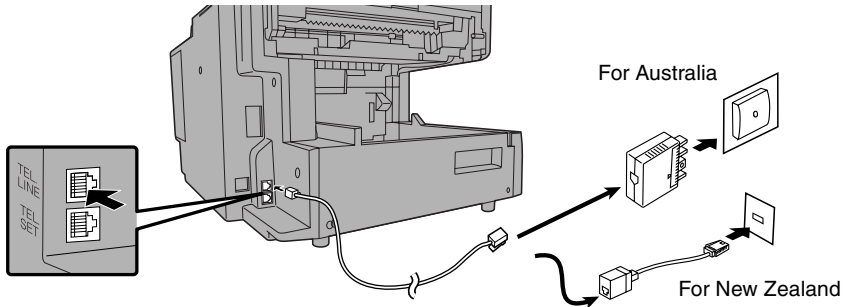

Note for Australia: The fax machine is set for touch-tone dialling. If you are on a pulse dial (rotary) line, you must set the fax machine for pulse dialling by changing Option Setting 22. See page 104. (In New Zealand, only tone dialling is used.)

Moving your fax and reconnecting

Should it be necessary to move your fax to a new location, first disconnect the telephone line cord before disconnecting the power lead. When reconnecting, it is necessary to connect the power lead before connecting the telephone line cord.

Connecting a telephone (optional)

If desired, you can connect a telephone to the **TEL. SET** socket on the back of the machine.

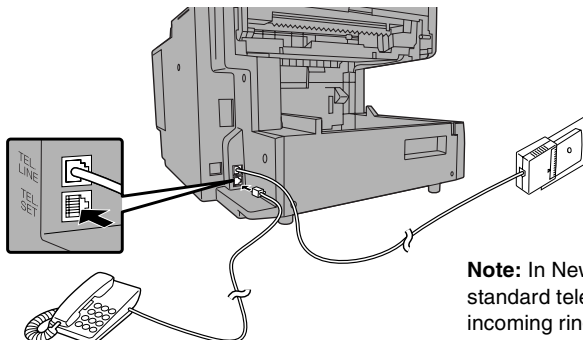

Note: In New Zealand, not all standard telephones will respond to incoming ringing when connected to the **TEL. SET** socket on the machine.

Attaching the ADF exit tray

Insert the protrusion on the right side of the machine into the hole in the right side of the ADF exit tray **1**, then bend the tray slightly and insert so that the protrusion on the left side of the machine goes into the hole on the left side of the ADF exit tray **2**. Pull out the tray extension **3**.

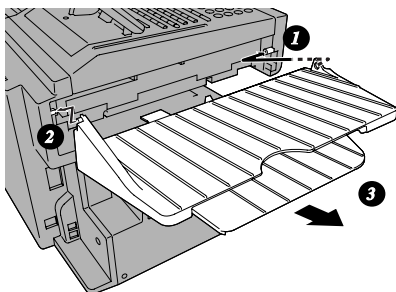

Attaching the received document tray

Slide the received document tray into the machine as shown. When it stops, lift the end slightly and push in so that the tray locks into place.

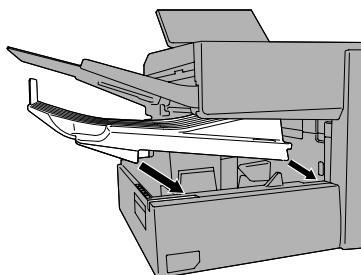

Important!

The received document tray must be attached for the fax machine to operate properly.

Verification Stamp option

Note: This feature is available as an option. Consult your dealer if you wish to use this feature.

When transmitting a document, you can have the fax machine stamp each document page as it is scanned. After scanning, you can check to see if all documents have been stamped to verify that no double feeds occurred. (A double feed occurs when two pages are fed through the scanner at once, which means that one of the pages is not scanned.)

To use this function, have your dealer install the Verification Stamp option, and then set Option Setting 29 to ON as explained on page 105.

Installing the Print Cartridges

Follow the steps below to install or replace the toner and drum cartridges.

- ◆ The initial starter toner cartridge included with the fax machine can print approximately 3000 A4-size pages (4% coverage of each page; continuous printing).
- ◆ The replacement toner cartridge (FO-59DC) can print approximately 6000 A4-size pages.
- ◆ The drum cartridge (FO-47DR) can print approximately 20,000 A4-size pages.

1 Press the cover release to open the print compartment cover.

• Caution!

The fusing unit inside the print compartment becomes very hot during operation. Be careful not to touch the inside of the compartment.

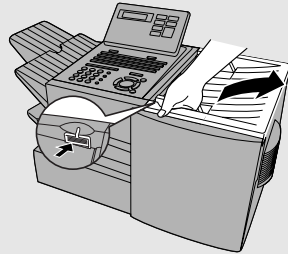

2 If you are replacing the toner cartridge, remove the old cartridge and dispose of it according to local regulations.

Go directly to Step 6 if you are only replacing the toner cartridge and not the drum cartridge.

- If you are replacing the drum cartridge but not the toner cartridge, remove the toner cartridge and place it on a sheet of paper.

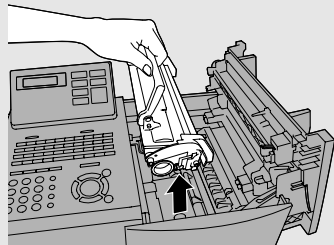

To make the cartridge more compact for disposal, press the buttons on the ends of the handle and fold the handle down.

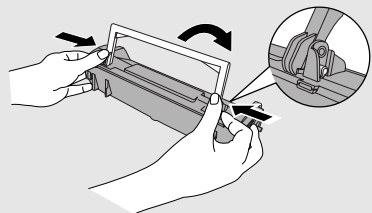

- 3** If you are replacing the drum cartridge, remove the old cartridge and dispose of it according to local regulations.

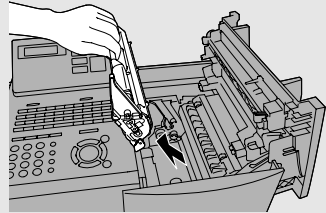

- 4** Remove the new drum cartridge from its packaging. Insert the drum cartridge into the print compartment.

- **Caution!** Excessive exposure to light will damage the drum cartridge. Install the cartridge promptly after removing it from its packaging.
- Make sure the drum cartridge is inserted in as far as it will go.

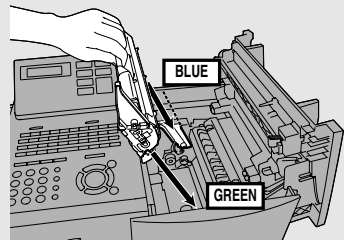

- 5** If you are installing a new toner cartridge, remove the new toner cartridge from its packaging. Remove the tape from the cartridge and then open the cartridge handle so that it stands straight up.

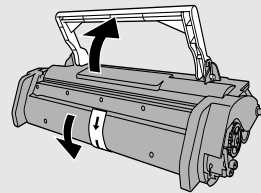

- 6** Shake as indicated by the arrows to distribute the toner evenly within the cartridge.

- If the toner is still lumpy after shaking, the gears in the cartridge may make a noticeable sound when the print compartment cover is closed after installing the cartridge. This is normal and does not indicate a problem.

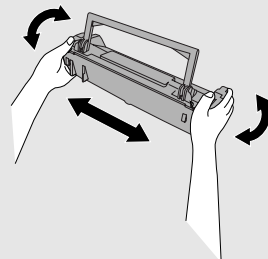

7 Hold the toner cartridge by the handle and insert it into the print compartment.

- Make sure the toner cartridge clicks into place.
- The handle can be left standing up.

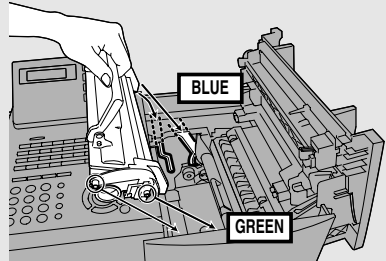

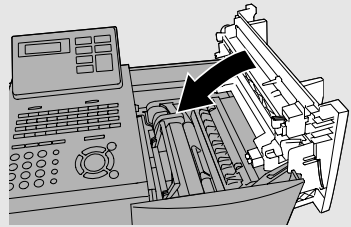

8 Close the print compartment cover.



9 Reset the drum counter by pressing (flip up the Rapid Key overlay), , and .

- **Note:** The toner counter automatically resets each time you replace the toner cartridge. There is normally no need to reset the toner counter manually. Should you find it necessary to manually reset the toner counter,

press  (flip up the Rapid Key overlay), , and .

Note: The print compartment cover may become noticeably warm if a large number of pages are successively printed. This is normal and does not indicate a problem in the machine.

When to replace the toner cartridge

When the toner cartridge nears empty (about 100 pages can still be printed), the toner cartridge indicator on the operation panel will blink. When the toner cartridge is empty, the toner cartridge indicator will light steadily and REPLACE TONER will appear in the display. Printing will no longer be possible. Use the following replacement toner cartridge:

Sharp FO-59DC toner cartridge

Hint:

When the toner cartridge nears empty, try taking it out of the machine and shaking it. This may increase the number of pages that can be printed before the toner runs out.

When to replace the drum cartridge

When the drum cartridge nears the end of its life, the ALARM indicator on the operation panel will blink and DRUM LIFE REACHED will appear in the display (this message appears when approximately 1000 pages can still be printed). Use the following replacement drum cartridge:

Sharp FO-47DR drum cartridge

Loading Printing Paper

You can load up to 250 sheets of A4 paper (80 g/m²) in the paper tray.

- ◆ A paper cassette is available as an option. Up to 500 sheets of A4 paper can be loaded in the paper cassette. To have the cassette installed, consult your dealer.

Important: Do not use the back side of paper that has already been printed on.

Note: If you need to add paper to the tray or cassette while paper still remains, remove the remaining paper and combine it into a single stack with the new paper.

Loading paper in the paper tray

- 1** Remove the received document tray.

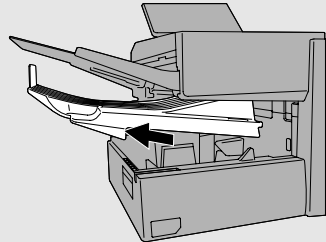

- 2** Insert a stack of paper into the tray, print side up.

- **Important!** The stack of paper must not be higher than the red line on the paper tray.

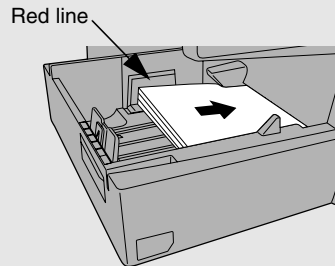

- 3** Squeeze the paper guide and move it to match the length of the paper you are loading.

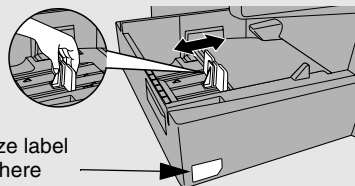

4 Replace the received document tray.

- The received document tray must be attached for the fax machine to operate properly.

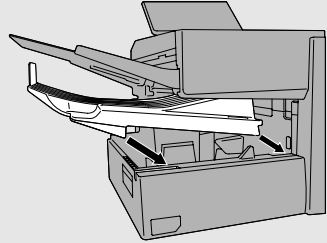

Loading paper in the paper cassette (if installed)

- 1** Grasp the hand-hold on the cassette and pull the cassette out until it stops.

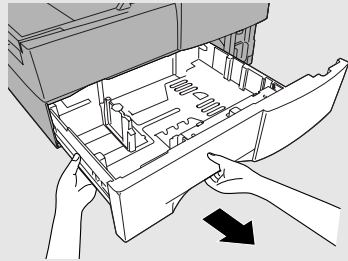

- 2** Push the pressure plate down until it locks into position.

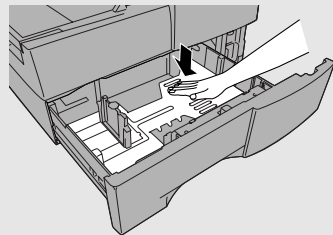

- 3** Squeeze the paper guide and pull up to move it to the appropriate holes for the length of the paper. Push the guide down into the holes.

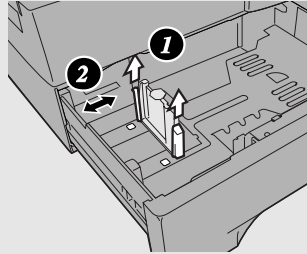

- 4** Place a stack of paper in the cassette, print side up.

- Make sure the stack of paper is not higher than the two tabs on the paper guide and the two metal tabs. If it is, remove some of the paper.
- If you find it difficult to load the paper, remove the cassette from the machine. (Pull the cassette out as far as it will go, grasp the left side of the cassette with your left hand, and then lift it up and out with both hands.)

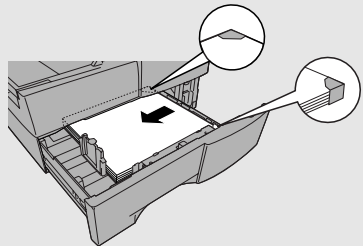

- 5** Push the cassette back into the machine, making sure it clicks into place.

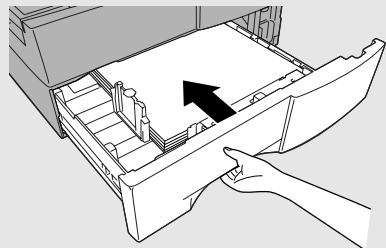

Entering Your Name and Fax Number

To have your name and fax number automatically appear at the top of each fax page you send, follow the steps below to program this information.

1 Press **MENU** and **3**.

Display:

3:ENTRY MODE
ENTER #(01-10, ◀, ▶)

2 Press **0** and **3**.

03:OWN PASSCODE SET
ENTER FAX #

3 Enter your fax number (max. of 20 digits) by pressing the numeric keys.

- To insert a space between digits, press **#**. To enter a "+", press *****.
- To clear a mistake, press **STOP**.



4 Press **START/ENTER**.

ENTER SENDER'S NAME

5 Flip the Rapid Key overlay down (if it is up), and enter your name by pressing the appropriate letter keys as shown below. (Max. of 24 characters.)

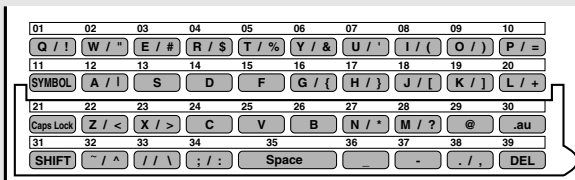
Example: SHARP = **Caps Lock** **S** **H / }** **A / I** **R / \$** **P / =**



- To enter a space, press **Space** .
- To change case, press **Caps Lock** .
- To clear a mistake, press **DEL** .
- To enter a number as part of a name, press the appropriate numeric key. To enter the symbol on a letter key (the character to the right of the slash), press **SYMBOL** ("SYM" will appear in the display) and then the letter key (press **SYMBOL** again to turn off symbol entry mode).
- To move the cursor, press  or  . To switch between letter insertion and letter replacement mode when the cursor is in the middle of a sequence of letters, press **MENU**  .

6 Press  .

04: DATE & TIME SET
PRESS START KEY

7 Press  twice to return to the date and time display.

Setting the Date and Time

The date and time appear in the display, in reports, and at the top of each page you transmit. Set the date and time by pressing the keys on the operation panel as shown below.

1 Press **MENU** and **3**.

Display:

3:ENTRY MODE
ENTER #(01-10, ◀, ▶)

2 Press **0** and **4**.

04:DATE&TIME SET
DATE 08-06-2003

(The currently set date will appear to the right of "DATE")

3 Enter a two-digit number for the day ("01" to "31").

Example: The 5th **0** **5**

- To correct a mistake, press  to move the cursor back to the mistake and then enter the correct number.

4 Enter a two-digit number for the month ("01" for January, "02" for February, "12" for December, etc.).

Example: March **0** **3**

5 Enter the year (four digits).

Example: 2003 **2** **0** **0** **3**

6 Enter a two-digit number for the hour ("00" to "23") and a two-digit number for the minute ("00" to "59").

Example: 9:25 **0** **9** **2** **5**

7 Press  to start the clock.



8 Press  twice to return to the date and time display.

Volume Adjustment

You can adjust the volume of the speaker and ringer using  and .

Speaker

1 Press  .

2 Press  or  to select the desired volume level.

Display:

SPEAKER VOLUME
HIGH





SPEAKER VOLUME
MIDDLE



SPEAKER VOLUME
LOW

3 Press  to turn off the speaker.

Ringer

- 1** Press the  or  to select the desired volume level. (Make sure **SPEAKER**  has not been pressed.)

- The ringer will ring once at the selected level, and then the date and time will reappear in the display.

Display:

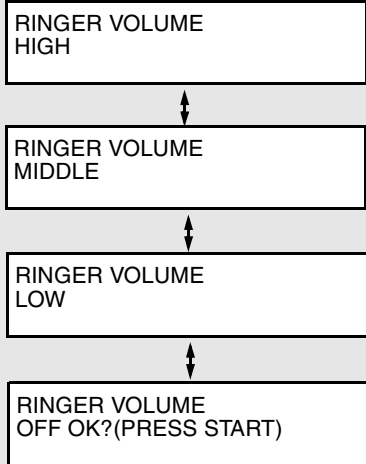

- 2** If you selected “RINGER VOLUME OFF: OK?” to turn off the ringer, press  to confirm your selection.

2. Sending Documents

Transmittable Documents

Size and weight

The size and weight of documents that you can load in the document feeder depend on whether you load one page at a time or several pages at once.

Loading one page at a time:

Minimum size

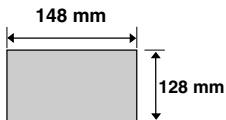

Maximum size

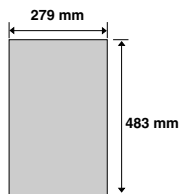

Minimum weight

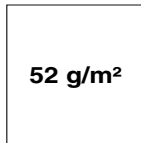

Maximum weight

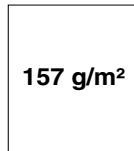

Loading multiple pages at once (A4 size: max. 50 pages):

Minimum size

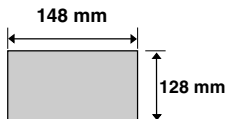

Maximum size

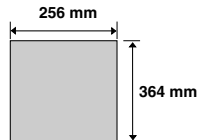

Minimum weight

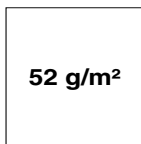

Maximum weight

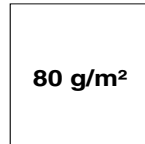

Maximum scanning area

The area of the document that the fax machine can scan is slightly smaller than the actual document size. Any letters or graphics outside this area will not be scanned.

Maximum scanning width: 208 mm

Maximum scanning length: The length of the document minus 4 mm from the top and bottom of the document.

Other restrictions

- ◆ The scanner cannot recognise yellow, greenish yellow, or light blue ink.
- ◆ Ink, glue, and correcting fluid on documents must be dry before they pass through the document feeder.
- ◆ All clips, staples, and pins must be removed from documents before loading in the feeder. If these are not removed, they may damage the machine.
- ◆ Documents which are patched, taped, torn, smaller than the minimum size, carbon backed, easily smudged, or have a slick, coated surface should be photocopied, and the copy loaded in the feeder.

Loading the Document

Up to 50 A4-size pages can be placed in the feeder at one time. The pages will automatically feed into the machine starting from the bottom page.

- ◆ If you need to send or copy more than 50 pages, place the additional pages gently and carefully in the feeder just before the last page is scanned. Do not try to force them in, as this may cause double-feeding or jamming.
- ◆ If your document consists of several large or thick pages which must be loaded one at a time, insert each page into the feeder as the previous page is being scanned. Insert gently to prevent double-feeding.

- 1 Adjust the document guides to the width of your document.**

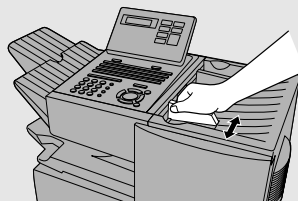

- 2 Place the document face down and push it gently into the document feeder. The top edge of the document should enter the machine first.**

- The feeder will draw the leading edge of the document into the machine. SEND READY will appear in the display.

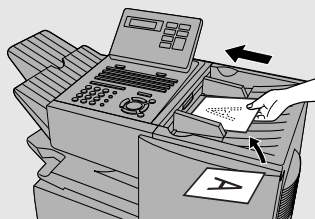

Note: When inserting a large number of pages in the feeder, slant the front end of the stack so that the bottom pages enter first.

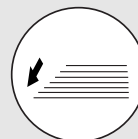

- 3** Adjust the resolution and/or contrast settings (if desired) and then dial the receiving machine as explained in the following sections.

Adjusting the Resolution and Contrast

If desired, you can adjust the resolution and contrast before sending a document.

Resolution

The fax machine has four resolution settings:

STANDARD	Use STANDARD for ordinary documents. This setting gives you the fastest and most economical transmission.
FINE	Use FINE for documents containing small letters or fine drawings.
SUPER FINE	Use SUPER FINE for documents containing very small letters or very fine drawings.
HALF TONE	Use HALF TONE for photographs and illustrations. The original will be reproduced in 64 shades of gray.

The default resolution setting is STANDARD. If you don't adjust the resolution before sending a document, the fax machine will automatically use STANDARD resolution.

- ◆ In order to transmit in FINE or SUPER FINE resolution, the receiving fax machine must also have that resolution. If it doesn't, the next best available setting will be used.
- ◆ The resolution settings are only effective for transmitting and copying a document. They are not effective for receiving a document.

Adjusting the Resolution and Contrast

To adjust the resolution setting, press **RESOLUTION**  one or more times until the indicator light next to the desired setting comes on.

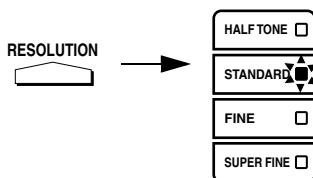

Contrast

The fax machine has three contrast settings:

- | | |
|-------|---|
| AUTO | Use AUTO for normal documents. |
| DARK | Use DARK for faint documents. |
| LIGHT | Use LIGHT for documents with a dark background. |

The default setting is AUTO.

To adjust the contrast, press **CONTRAST**  until the desired setting appears in the display.

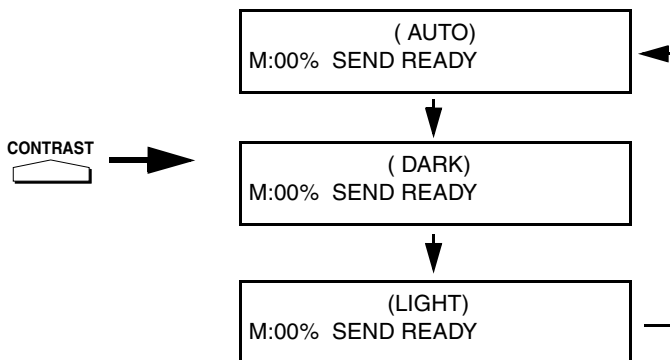



Sending a Fax by Normal Dialling

With Normal Dialling, you press  and then dial by pressing the numeric keys.

- ◆ Normal Dialling allows you to listen to the line through the speaker to make sure the other fax machine is responding. (Note that the speaker is not a speakerphone; it cannot be used for talking.)
- ◆ If you have connected an extension telephone to the fax machine, you can also pick up the extension phone and dial using the extension phone (do not press  on the fax machine). If a person answers, you will be able to speak to them through the phone before sending a fax.

Note: If you press  to dial, you will not be able to speak using an extension phone connected to the fax machine in the event that a person answers.

1 Load the document(s). (Note: If desired, you can load the document after dialling in Step 3, below.)

- SEND READY will appear in the display.
- Press  and/or  to set the resolution and contrast if needed.

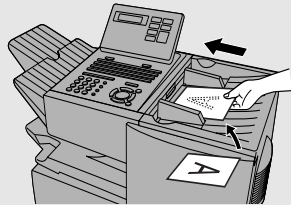

2 Press or pick up an extension phone connected to the fax machine. Listen for the dial tone.



3 If you pressed , dial the number of the receiving machine by pressing the numeric keys on the fax machine.

If you are using an extension phone, dial using the keypad on the extension phone.

4 Wait for the connection. When you hear a fax tone, press  on the fax machine.

- If a person answers and you are using an extension phone, ask them to press their Start key. When you hear the fax tone, press  on your fax machine.

Using the REDIAL key

You can press  to redial the last number dialed. To send a document, press  when you hear the fax tone after the connection is established.

Note that the speaker is automatically activated when you press .

Programming Auto-Dial Numbers

You can dial a fax number by simply pressing a Rapid Key, or by pressing  and entering an abbreviated Speed Dial number.

To use a Rapid Key or Speed Dial number, you must first program the full fax number in the Rapid Key or Speed Dial number. It is usually convenient to program your most frequently dialed numbers in Rapid Keys.

- ◆ Up to 59 Rapid Keys can be programmed for shared use.
- ◆ Up to 75 Speed Dial numbers can be programmed for shared use.

You can also create personal books for auto-dial numbers. Up to 59 Rapid Keys and 16 Speed Dial numbers can be stored in each personal book. For information on creating and using personal books, see page 50.

1 Press **MENU** and **3** .

Display:

3:ENTRY MODE
ENTER #(01-10, ◀, ▶)

2 Press **0** and **1** .

01: DESTINATION
1=SET, 2=CLEAR

3 Press **1** to select SET.

1: DESTINATION SET
ENTER RAPID OR SPEED

4 To program a Rapid Key number, press the Rapid Key that you wish to use. (To select Rapid Keys 40 through 59, flip up the Rapid Key overlay.)

To program a Speed Dial number, press **SPEED DIAL** and then enter the number from “1” to “75” that you wish to use. (If you enter less than two digits, press **START/ENTER** to complete the entry.)

5 Enter the fax number by pressing the numeric keys (max. of 60 digits including pauses).

- To clear a mistake, press **DEL** .
- If a pause is required between any of the digits to access a special service or an outside line, press **REDIAL** (two seconds per pause). The pause will appear as a hyphen. Several pauses can be entered in a row.

6 Press **START/ENTER** .

7 Enter the name of the party by pressing the letter entry keys (max. of 20 characters). (Make sure the Rapid Key overlay is flipped down.)

Example: SHARP = **Caps Lock** **S** **H / }** **A / I** **R / \$** **P / =**

- If you don't want to enter a name, go directly to Step 8.

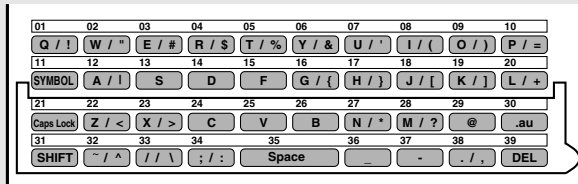

- To enter a space, press **Space** .
- To change case, press **Caps Lock** .
- To clear a mistake, press **DEL** .
- To enter a number as part of a name, press the appropriate numeric key. To enter the symbol on a letter key (the character to the right of the slash), press **SYMBOL** (“SYM” will appear in the display) and then the letter key (press **SYMBOL** again to turn off symbol entry mode).
- To move the cursor, press or . To switch between letter insertion and letter replacement mode when the cursor is in the middle of a sequence of letters, press **MENU** .

8 Press .

CHAIN DIAL
1=SET, 2=CANCEL

9 Press **1** if the number programmed is an area code or access code to be used for Chain Dialling (see *Chain Dialling* at the end of this procedure). Press **2** (or) if the number is a regular fax number.

10 Return to Step 4 to program another number, or press repeatedly to return to the date and time display.

- If you programmed a Rapid Key number, you can write the name of the party on the label above the Rapid Key.

Chain Dialling for area and access codes

You can also program an area code or access code in a Rapid Key or Speed Dial number using the above programming procedure. In Step 9, press **1** to set the number as a Chain Dialling number.

After you dial an area code or access code using a Rapid Key or Speed Dial number set for Chain Dialling, the fax machine will wait for you to dial the remainder of the number (you can dial the remainder of the number by pressing a Rapid Key, by pressing the Speed Dial key and entering a Speed Dial number, or by pressing numeric keys). Note that the remainder of the number should **not be set** as a Chain Dial number if programmed in a Rapid Key or Speed Dial number.

- ◆ The maximum number of digits that can be dialed at one time by Chain Dialling is 60.

Editing auto-dial numbers

To make changes in a number previously stored, repeat the programming procedure. Select the Rapid Key or Speed Dial number for which you want to make changes in Step 4, and then change the number(s) and/or name(s) when they appear in the display (Steps 5 and 7).

Clearing auto-dial numbers

Note: You cannot clear a number if it is used in a program or timer operation, or if it is included in a Group Key. First clear the number from the operation or group, then perform the following clearing procedure. To check where the number is used, print out the Program/Group List or the Timer List as explained on page 107.

1 Press **MENU** and **3** .

Display:

3:ENTRY MODE
ENTER #(01-10, ◀, ▶)

2 Press **0** and **1** .

01: DESTINATION
1=SET, 2=CLEAR

3 Press **2** to select CLEAR.

2: DESTINATION CLEAR
ENTER RAPID OR SPEED

4 To clear a Rapid Key, press the Rapid Key.

To clear a Speed Dial number, press  and then enter the number with the numeric keys. (If you enter less than two digits, press  to complete the entry.)

5 Press .

6 Return to Step 4 to clear another number, or press  repeatedly to return to the date and time display.

Sending a Fax by Automatic Dialling

Dual Access

The fax machine features full dual access, which means that you can load a document and dial by automatic dialling even when the fax machine is occupied with another job. After you dial, your document will be immediately scanned into memory and then transmitted once all previously stored jobs have been completed.

If more than one document has been scanned into memory for transmission, the documents (jobs) will be transmitted in the order in which they were scanned. If you have an urgent transmission and do not want to wait until previously stored jobs are completed, you can press **PRIORITY** after loading your document. Your document will be transmitted immediately after the current job is finished.

If you don't want the document to be transmitted from memory, you can press **DOCUMENT M/?** after loading the document. Your machine will call the receiving fax machine immediately after the current job is finished (ahead of any previously stored jobs in memory), and the document will be scanned as soon as the connection is established.

- ◆ Approximately 124 pages of average content can be held in memory. Less pages can be held if any were scanned using fine or halftone resolution.
- ◆ The amount of memory currently occupied appears as a percentage ("M:00%") in the display.

Rapid Key Dialling

If the number you want to dial has been programmed in a Rapid Key, you can dial it by pressing the Rapid Key.

1 Load the document(s).

SEND READY will appear in the display.

- Press **RESOLUTION** and/or **CONTRAST** to set the resolution and contrast if needed.
- To send the document ahead of other documents waiting for transmission, press **PRIORITY**.
- To send the document directly from the feeder (not through memory), press **DOCUMENT M/?**. (Flip up the Rapid Key overlay if it is down.)

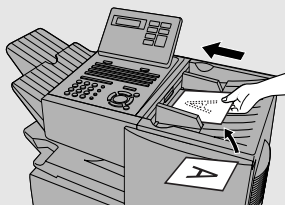

2 Press the appropriate Rapid Key.





- The name of the receiving party will appear in the display. If no name was stored, the fax number will appear. (If the name or number is incorrect, press **STOP**.)
- The document will be automatically transmitted once the connection is established.

Speed Dialling

If the number you want to dial has been programmed in a Speed Dial number, you can dial it by pressing  and then entering the Speed Dial number.

1 Load the document(s).

SEND READY will appear in the display.

- Press  and/or  to set the resolution and contrast if needed.
- To send the document ahead of other documents waiting for transmission, press .
- To send the document directly from the feeder (not through memory), press . (Flip up the Rapid Key overlay if it is down.)

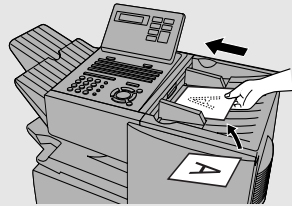

2 Press and then enter the Speed Dial number by pressing the numeric keys.

- If you enter less than 2 digits for the Speed Dial number, press  to complete the entry.

3 Check the display. If the name or number shown is correct, press .

(If not, press  and then repeat Step 2.)

Direct Keypad Dialling

You can also enter a full number with the number keys and then press



to begin dialling.

- 1 Load the document(s). (Note: If desired, you can load the document after dialling in Step 2, below.)**

SEND READY will appear in the display.

- Press **RESOLUTION** and/or **CONTRAST** to set the resolution and contrast if needed.
- To send the document ahead of other documents waiting for transmission, press **PRIORITY**.
- To send the document directly from the feeder (not through memory), press **DOCUMENT M/?**. (Flip up the Rapid Key overlay if it is down.)

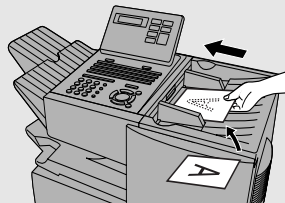

- 2 Enter the number of the receiving machine by pressing the numeric keys.**

- If a pause is required between any of the digits to access a special service or an outside line, press **REDIAL** (two seconds per pause). The pause will appear as a hyphen. Several pauses can be entered in a row.

- 3 Check the display. If the number of the receiving machine shown is correct, press** **START/ENTER**.

- If it is not correct, press **STOP** to backspace and clear one digit at a time, and then re-enter the correct digit(s).

Searching for an auto-dial number



If you don't remember the Rapid Key or Speed Dial number in which you have programmed a particular fax number, you can search for the number by following the steps below. Once you have found the number, you can dial it

and transmit the loaded document by simply pressing .

- ◆ You can also use this procedure to search for Group Keys and Program Keys (the name you programmed for the Group or Program key will appear). This can be done at any point in a transmission or polling procedure where you need to press a Group Key or a Program Key.

1 Load the document(s).

SEND READY will appear in the display.

- Press  and/or  to set the resolution and contrast if needed.

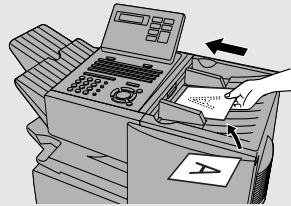

- ### 2 Press A to search from the beginning of the alphabet, or Z to search from the end.

Display:

SEARCH DIAL

- ### 3 Enter the first character of the stored name by pressing the appropriate letter entry key.

- If you don't remember the first letter, go to Step 4 (you will scroll through the list from the beginning).

- ### 4 Press or to scroll through the names. Stop when the desired name appears in the display.

- If no numbers have been stored under the entered letter, NOT FOUND will appear.

5 Press  . The document will be automatically transmitted once the connection is established.

Chain Dialling

An auto-dial number set for Chain Dialling can be combined with another auto-dial number or digits entered manually with the numeric keys to dial one phone number up to 60 digits long. The following are some examples of how this can be done:

- ◆ Press appropriate Rapid Keys in the proper order. For example, press Rapid Key 01 (set for Chain Dialling), then Rapid Key 02 (not set for Chain Dialling).
- ◆ Press a Rapid Key (set for Chain Dialling) and then manually enter a number by pressing appropriate numeric keys. Press  after the final numeric key to begin transmission.



If the memory becomes full...

If the memory becomes full while a document is being scanned, MEMORY FULL will appear in the display. If Option Setting 23 (Quick On-line) is set to ON, scanning will automatically resume when memory becomes free again as pages are transmitted. (Note: Quick On-Line is initially set to ON at the factory. To change the setting, see page 104.)

If Quick On-Line is set to OFF the transmission will be cancelled and MEMORY FULL ERROR will appear in the display. Press  to clear the message. Try the transmission again later when memory is free.



Checking the status of the current job

The display normally shows the date and time and prompts related to operations you are performing. To check and see what number the fax machine is currently calling or transmitting to, or what number the fax machine is currently receiving a document from (if this information is available), press

JOB STATUS . Information on the current job will appear in the display. To switch back to the date and time display, press **JOB STATUS**  again.

To cancel a fax transmission or reception

To cancel a fax transmission or reception that is currently in progress, press

JOB STATUS  so that the status of the transmission or reception appears in the display, and then press **STOP** .

Checking and canceling stored transmission jobs



To display information on jobs that are waiting in memory for transmission, follow the steps below. You can also cancel a transmission job with this procedure.

- 1** Press **MEM.STATUS**  (flip up the Rapid Key overlay) and then **2**.

Display:



TX STATUS (005)
PRESS ◀ OR ▶

The number of stored transmission jobs appears here

- 2** Press  or  to scroll through the list of transmission jobs. The name (or number) of each receiving party will appear in the display, together with the 3-digit memory number assigned to the transmission.



To cancel a transmission, press **DEL**  and then **START/ENTER**  while the transmission appears in the display.

- 3** When you have finished checking the list, press  twice to return to the date and time display.

Note: To print out a list of the documents waiting in memory for transmission, press  and then .

Canceling a memory transmission by number

If you know the memory number assigned to a memory transmission, you can cancel it with the following procedure. (If you don't know the memory number, use the preceding procedure.)

- 1** Press  (flip up the Rapid Key overlay) and then .

Display:

4: MESSAGE CLEAR
ENTER MESSAGE #

- 2** Enter the 3-digit memory number assigned to the transmission you wish to cancel.

- 3** Press .

Automatic redialling

If you use automatic dialling (including Direct Keypad Dialling) and the line is busy, the fax machine will automatically redial the number. The fax machine will make 2 redialling attempts at intervals of 5 minutes.

To cancel automatic redialling, press  to show the job status in the display (make sure that RECALL MODE appears on the top line of the display and the number of the receiving party appears on the bottom line to the right),



and then press .

- ◆ Under certain conditions (for example if a person answers the call on a telephone), automatic redialling may stop before two redialling attempts are made.

Memory Retransmission

If a line error occurs during any type of memory transmission, the fax machine will automatically redial the number and attempt to complete the transmission. Retransmission will begin from the page which was being transmitted when the error occurred.





The fax machine will make 2 retransmission attempts at intervals of 2.5 minutes.

- ◆ The numbering of pages retransmitted will begin from "1" again.
- ◆ If an error or power failure occurs during transmission of a cover sheet, retransmission will not take place.
- ◆ To cancel retransmission, press  to show the job status in the display (make sure that RETRY MODE appears on the top line of the display and the number of the receiving party appears on the bottom line to the right), and then press .

Creating and Using Personal Books

Up to 10 personal books can be created that allow individuals to program Rapid Key and Speed Dial numbers for their own personal use.

- ◆ Up to 59 Rapid Key numbers and 16 Speed Dial numbers can be programmed in each personal book.
- ◆ If desired, you can program a 4-digit passcode for a personal book. When this is done, the passcode must be entered to use or edit the book.

You can open a personal book by pressing  and then entering the book's 4-digit passcode if it has a passcode, or by selecting the book with  or  and pressing . After opening the book, simply follow the desired procedure for programming or using a Rapid Key or Speed Dial number as explained elsewhere in this manual.

Creating a personal directory book

To create a new personal directory book, follow the steps below:

1 Press **MENU** , and **3** .

Display:

3:ENTRY MODE
ENTER #(01-10, ◀, ▶)

2 Press **1** and **0** .

10: BOOK ENTRY MODE
1=SET, 2=CLEAR

3 Press **1** to select SET.

1:BOOK SET MODE
ENTER # (01 - 10)

4 Enter a 2-digit number from 01 to 10.

- This number will identify the personal directory book.

5 Enter a name for the personal directory book by pressing the letter entry keys. (Make sure the Rapid Key overlay is down.)

Example: SHARP =      

- For more information on entering letters, see Step 5 on page 24.

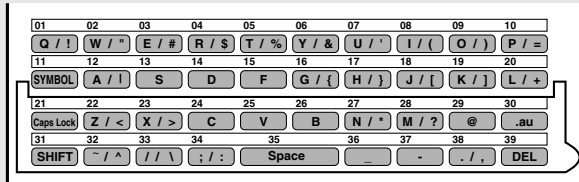

6 Press .

ENTER PASSCODE
OR START TO SKIP

7 Enter a four-digit passcode for the personal directory book (this can be any four-digit number you like).
If you do not wish to use a passcode,

USE NAME AS FAX HDR
1=YES, 2=NO

press  to skip this step.

8 Press **1** if you wish to use the book name in the header of faxes sent using the book.

Press **2** to use the sender's name entered on page 24.

9 Return to Step 4 to create another book, or press  repeatedly to return to the date and time display.

Using a personal book

To program or use a Rapid Key or Speed Dial number in a personal book, you must first open the book. Follow these steps:



1 Press  .

Display:

SELECT PERSONAL BOOK
BY ► KEY OR PASSCODE

2 Enter the 4-digit passcode of your book.

The display briefly shows the following and then reverts to the date and time:

If the book doesn't have a passcode, press  or  until the name of the book appears in the display and then

press .

** PERSONAL BOOK **
SUSAN

The name of your book appears on the bottom line.

3 When your book is open, all of the Rapid Keys on the operation panel automatically convert to keys for use in your book. Speed Dial numbers 1 through 16 are also available for use in your book.

You can perform the following operations in a book:

- ◆ Program any Rapid Key, or a Speed Dial number from 1 to 16, as explained on page 36.
- ◆ Use a Rapid Key to fax a document as explained on page 42.
- ◆ Use a Speed Dial number to fax a document as explained on page 43.
- ◆ Program a Group Key in your book using Rapid Key and Speed Dial numbers from your book (see page 65).
- ◆ Broadcast a fax to multiple destinations using Rapid Keys, Speed Dial numbers, or a Group Key in your book (see page 63).
- ◆ Set up a Program Key in your book (see page 85). (Note: Only Rapid Keys and Speed Dial numbers from your book can be used.)

- ◆ Poll one or more fax machines using Rapid Keys and Speed Dial numbers from your book (see page 71).
- ◆ Set up a timer operation using a Rapid Key or Speed Dial number from your book (see page 77).
- ◆ Print out the Destination List, Program/Group List, or Timer List (see page 107). When printed from your book, these lists will show the corresponding information in your book.
- ◆ Press  to redial the last number dialed from your book.

Closing a book

A book will automatically close when the operation performed from the book is completed. If you need to close a book before performing an operation, press



The display shows:

CANCEL BOOK?
1=YES, 2=NO

Press  to confirm that you want to close the book. Note that a book will also close automatically after one minute if no operation is performed.

Canceling an operation performed from a book

To cancel an operation that was set up from a book, you must first open the book (as explained on page 52) and then cancel the operation.

For example, if you need to cancel a fax transmission that was performed from a book, open your book and then cancel the operation as explained on page 47 or 48. Note that the job status of the fax can be checked without opening your book.

To clear a Rapid Key or Speed Dial number in a book, open the book and then clear the key or number.

Clearing a book

Note: Before you can clear a personal book, you must clear all Rapid Keys, Speed Dial numbers, Group Keys, and Program Keys that are in the book. If a transmission or timer operation is pending that uses a number in a book, the book cannot be cleared until the operation is completed or cancelled.

1 Press **MENU** , and **3** .

Display:

3:ENTRY MODE
ENTER #(01-10, ◀, ▶)

2 Press **1** and **0** .

10: BOOK ENTRY MODE
1=SET, 2=CLEAR

3 Press **2** to select **CLEAR**.

2: BOOK CLEAR MODE
ENTER # (01 - 10)

4 Enter the 2-digit number of the book you wish to clear.

5 If the book has a passcode, enter the passcode.

6 Press  .

7 Press  repeatedly to return to the date and time display.

Cover Sheet

You can have the fax machine generate a cover sheet and send it as the last page of your fax transmission. The cover sheet includes the date and time, the receiver's name and number if a Rapid Key or Speed Dial number is used, the sender's name and number, and the total number of pages.

- ◆ Your name and number must be programmed in order for them to appear on the cover sheet (see page 24).
- ◆ To have the recipient's name appear, you must dial using a Rapid Key or Speed Dial number with the name programmed.

AUTOMATIC COVER SHEET	
DATE:	08-AUG-2002 THU 11:48
TO:	N. T. BANK
FAX #:	4525558885
FROM:	John Doe Corp.
FAX #:	2015551254
02 PAGES WERE SENT (INCLUDING THIS COVER PAGE)	

(Example)

1 Load the document(s).

- SEND READY will appear in the display.
- Press **RESOLUTION** and/or **CONTRAST** to set the resolution and contrast if needed.

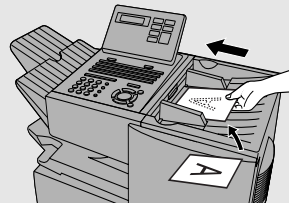

2 Press . (Flip up the Rapid Key overlay if it is down.)

- The display will briefly show COVER SHEET MODE ENTERED and then revert to SEND READY.
- To cancel the cover sheet selection, press  .

3 Dial the receiving party and transmit the fax.

If desired, you can set your fax to automatically send a cover sheet with every transmission (you do not have to press  each time). This is accomplished by setting Option Setting 10 (Auto Cover Sheet) to YES as explained on page 102.

Batch Page Numbering

You can change the page numbering of the transmitted document from simple numbering ("P.01", "P.02", etc.) to batch numbering, which means that a slash and the total number of pages being sent are added after each page number (for example, "P. 01/05", "P.02/05", etc.). This allows the receiver to check for missing pages.

1 Load the document(s).

- SEND READY will appear in the display.
- Press **RESOLUTION** and/or **CONTRAST** to set the resolution and contrast if needed.

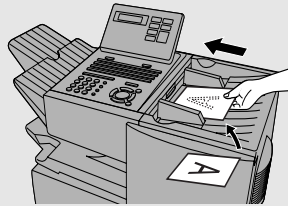

2 Press **PAGE COUNTER** (Caps Lock) . (Flip up the Rapid Key overlay if it is down.)

Display:

ENTER # OF PAGE(S)
ENTER # (01-99)

3 Enter the total number of pages ("01" to "99") by pressing the numeric keys.

Example: 5 pages **0** **5**

- If you are sending a cover sheet, do not include it in the total number of pages (the number will be adjusted automatically).

4 Dial the receiving machine and transmit the document.

- ◆ If you need to cancel a batch number entry, remove the document from the feeder or press **STOP** .
- ◆ If the number of pages actually transmitted does not coincide with the batch number entered, the alarm will sound and PAGE COUNT ERROR will appear in the display. PAGE E. will also appear in the NOTE column of the Transaction Report if printed.

3. Receiving Documents

The fax machine has two modes for receiving calls:

AUTO mode:

Select this mode when you only want to receive faxes on the line connected to the fax machine. The fax machine will answer all calls automatically and receive incoming faxes.

MANUAL mode:

Select this mode when you have an extension phone connected to the same line as the fax machine and you want to receive both faxes and voice calls. **All calls, including faxes, must be answered by picking up the extension phone.**

Setting the reception mode

The reception mode is initially set to AUTO. To change the reception mode, follow these steps:

1 Press and **1** .

1:RECEIVE MODE 1=AUTO, 2=MANUAL

2 Press **1** to select **AUTO**, or **2** to select **MANUAL**.

Using AUTO Reception Mode

In AUTO reception mode, the fax machine automatically answers all calls on 2 rings and receives incoming faxes.

- ◆ You can change the number of rings on which the machine answers calls by changing Option Setting 2 (see page 100).
- ◆ If you pick up an extension phone before the fax machine answers, you can talk to the other party and/or receive a fax as explained in the following section, *Using MANUAL Reception Mode*.

Using MANUAL Reception Mode

- 1** When the fax machine rings, answer the call on an extension phone connected to the same line.

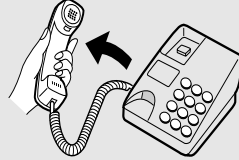

- 2** If you hear a fax tone, press **5** once and ***** twice on the keypad of the extension phone, or press **START/ENTER** on the fax machine.

- If the other party first speaks with you, perform Step 2 after speaking. (Perform Step 2 before the sender presses their Start key to begin fax transmission.)
- If there is a document in the feeder, remove the document before performing Step 2 (otherwise the document will be transmitted).

- 3** When **RECEIVING** appears in the display, hang up.

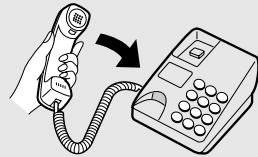

Note: In New Zealand, not all standard telephones will respond to incoming ringing when connected to the **TEL. SET** socket on the machine.

Substitute Reception to Memory

In situations where printing is not possible, such as when the fax machine runs out of paper or toner, or a paper jam occurs, incoming faxes will be received to memory.

When you have received a fax to memory, FAX RCVD IN MEMORY will appear in the display, alternating with NO PAPER, REPLACE TONER, or PAPER JAM. When you add paper, replace the toner cartridge, or clear the jam, the stored faxes will automatically print out.

You can display information on faxes received to memory by following these steps:

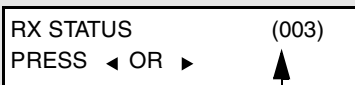

- 1** Press  (flip up the Rapid Key overlay) and .

Display:



RX STATUS (003)
PRESS ◀ OR ▶

The number of received faxes appears here

- 2** Press  or  to scroll through the list of received faxes. The name (or number) of the sender of each document will successively appear in the display.
- 3** When you have finished checking the list, press  twice to return to the date and time display.

4. Making Copies

Your fax machine can also be used to make copies. Single and multiple copies (up to 99 per original) can be made, enabling the fax machine to double as an office copier.

- ◆ You can perform all steps of a copy job even when the fax machine is busy printing other copy jobs, or when it is printing a received fax after the line has been disconnected. Your copy job will be automatically stored in memory and then printed when all previous printing jobs are completed.
- ◆ The default resolution for copying is FINE. If desired, you can change the default resolution to SUPER FINE by changing Option Setting 30 (see page 106).

1 Load the document.

- SEND READY will appear in the display.
- Press **RESOLUTION** and/or **CONTRAST** to set the resolution and contrast if needed.

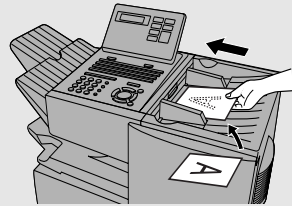

2 Press **COPY/HELP** .

- If you are only making a single copy of the original (or of each original), press



. Copying will begin.

Display:

COPY MODE	
ENTER #(01-99)	01

3 Enter the desired number of copies per original with the numeric keys.

- If the desired number of copies is from 1 to 9, enter "0" first.

MULTI/SORT COPY MODE
1=MULTI, 2=SORT

- 4** Press **1** (MULTI) if you do not want the copies sorted, or **2** (SORT) if you want the copies sorted.

Example of three copies each of three originals

- Copying will begin.

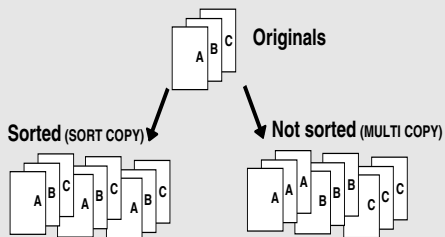

Checking and canceling copy jobs in memory

You can display the status of copy jobs in memory by following the steps below. You can also cancel a copy job with this procedure.

- 1** Press **MEM.STATUS** **B** (flip up the Rapid Key overlay) and then **1** .

Display:

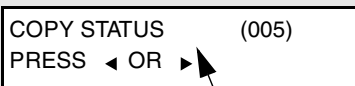

The number of stored copy jobs appears here

- 2** Press **◀** or **▶** to scroll through the list of copy jobs. The time the original was scanned into memory will appear in the display, together with the 3-digit memory number assigned to the job. To cancel a copy job, press **DEL** and then **START/ENTER** while the copy job appears in the display.

- 3** When you have finished checking the list, press **STOP** **⏹** twice to return to the date and time display.

5. Special Functions

Broadcasting

The Broadcasting function allows you to send the same fax to as many as 154 destinations in a single operation. First load the document, then enter the numbers of the receiving machines. The document will be automatically transmitted to each destination.

1 Load the document (s).

- SEND READY will appear in the display.

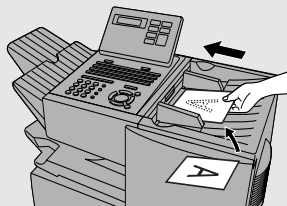



2 Press **BROADCAST**.

Display:

BROADCAST MODE
ENTER STATION #



3 Dial the receiving machines using one or more of the following methods:

- Press one or more Rapid Keys.
- Enter one or more Speed Dial numbers, pressing **SPEED DIAL** before each number. (If you enter less than 2 digits for a number, press **START/ENTER** to complete the entry.)
- Enter one or more full fax numbers with the numeric keys (max. 60 digits per full number), pressing **START/ENTER** after each full number. (Maximum of 20 full numbers; less if a large number of programs, timer operations, and/or group keys have been stored.)
- Press one or more Group Keys. (See *Storing numbers in Group Keys* on page 65.)

Note: If you need to delete a number, press  or  until the destination appears in the display and then press .

4 Press .

BROADCAST MODE
SELECT THE MODE

5 If desired, press  and/or  to set the resolution and contrast.



6 Press  twice. Transmission will begin.

- A Transaction Report is automatically printed out after Broadcasting is completed. Check the "Note" column of the report to see if any of the locations are marked "Busy" or have a communication error code. If so, send the document to those locations again.

Broadcasting using a Group Key

If the fax machines to which you want to broadcast have all been programmed into one Group Key (see *Storing numbers in Group Keys* which follows), you can perform the broadcasting operation using the following simplified procedure:

1 Load the document(s).

- SEND READY will appear in the display.
- Press  and/or  to set the resolution and contrast if needed.

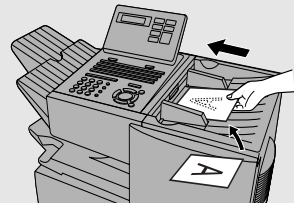

2 Press the appropriate Group Key. Transmission will begin.



Storing numbers in Group Keys

Group Keys allow you to dial a group of fax numbers by simply pressing the appropriate Group Key once. To store a group of numbers in a Group Key, follow the steps below.

- ◆ Any Rapid Key that is not already programmed as a Rapid Key or a Program Key can be used as a Group Key.
- ◆ Up to 133 numbers can be stored in one Group Key.
- ◆ Only Rapid Key and Speed Dial numbers (excluding numbers set for Chain Dialling) can be stored in a Group Key. Full numbers cannot be stored.

1 Press **MENU** , **5** and then **2** .

Display:

2:GROUP ENTRY MODE
1=SET, 2=CLEAR

2 Press **1** to program a Group Key.

(Press **2** to clear a Group Key.)

1:GROUP SET
PRESS GROUP KEY

3 Press any Rapid Key not already programmed to select it as a Group Key.

(If you are clearing a Group Key, press it and go to Step 5.)

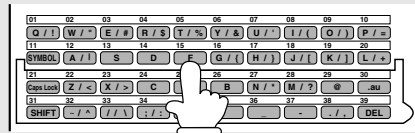



ENTER GROUP NAME



4 Enter a name for the Group Key by pressing the letter entry keys (see Step 5 on page 24). (Maximum of 20 characters.)
If you don't want to enter a name, go directly to Step 5.

5 Press **START/ENTER** .

STATION # =
ENTER STATION #

6 Enter fax numbers using one or both of the following methods:





- Press one or more Rapid Keys.
- Enter one or more Speed Dial numbers with the numeric keys, pressing  before each number (if you enter less than 2 digits for a number, press  to complete the entry).

Note: If you need to delete a number, press  or  until the destination appears in the display and then press .

7 Press .

8 Return to Step 3 to program another Group Key, or press  repeatedly until you return to the date and time display.

Editing a group

If necessary, you can add numbers to or delete numbers from a group by repeating the programming procedure for the Group Key. Press  for SET in Step 2 and select the Group Key in Step 3. Add or delete numbers in Step 6. To add a number, press a Rapid Key or enter a Speed Dial number. To delete a number, move the cursor to the number with  or  and then press .

Confidential Operations



The Confidential function can be used to transmit and receive confidential documents.

Confidential transmission

When you send a document using the Confidential function, the receiving machine holds it in memory instead of immediately printing it out. When the receiving party enters the correct passcode, the document is printed out.

- ◆ Confidential transmission is only possible when the receiving machine is a Sharp model with confidential reception capability.
- ◆ To use this function, your name and fax number (OWN PASSCODE) must be entered in your fax machine as explained on page 24.
- ◆ Some fax machines have multiple mailboxes for receiving confidential faxes. If you are sending to a machine with multiple confidential mailboxes, contact the receiving party in advance for the appropriate mailbox number.

1 Load the document (s).

- SEND READY will appear in the display.
- Press **RESOLUTION**  and/or **CONTRAST**  to set the resolution and contrast if needed.

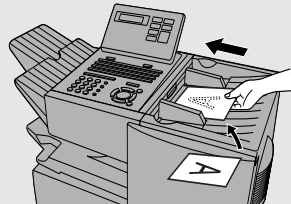

- ### 2 Press **CONFIDENTIAL** (flip up the Rapid Key overlay if it is down) and then **1**.

Display:





1:CONF. TX
ENTER BOX # OR START

- 3** If the receiving machine has multiple confidential mailboxes, enter the appropriate mailbox number with the numeric keys (this step is required for machines with multiple mailboxes).

If the receiving machine doesn't have multiple mailboxes, go directly to Step 4.

- 4** Press  .

- 5** Dial the receiving machine using one of the following methods:

- Press a Rapid Key.
- Press  and enter a Speed Dial number (if you enter less than 2 digits, press  to complete the entry). Check the name or number that appears, and then press .
- Enter a full telephone number with the numeric keys, and press .

Transmission will take place once the connection is established.

Confidential reception

When another fax machine sends you a document by confidential transmission, your fax machine holds it in memory instead of immediately printing it out. The document cannot be printed out until you enter the correct passcode.

Your fax has 10 "mailboxes" in which confidential documents can be received. Each mailbox has its own passcode, allowing up to 10 different people or groups to each receive their own confidential documents. The mailboxes are identified by 2-digit numbers.

Programming the confidential passcode

To receive a confidential document, you must first program a 2-digit mailbox number and a 4-digit passcode.

Note: Be sure to inform the transmitting party of your 2-digit mailbox number in advance. The transmitting party will need this number to send you confidential faxes.

- 1** Press  (flip up the Rapid Key overlay if it is down) and then .

Display:

3:CONF. CODE SET
ENTER BOX # (00-99)

- 2** Enter a 2-digit number (from "00" to "99") by pressing the numeric keys. This number identifies the mailbox.

- 3** Enter a 4-digit passcode for the mailbox with the numeric keys.

- 4** Press .

- 5** Enter a name for the mailbox (max. of 20 characters) by pressing the letter entry keys (make sure the Rapid Key overlay is down).

Example: SHARP =      

- For more information on entering letters, see Step 5 on page 24.

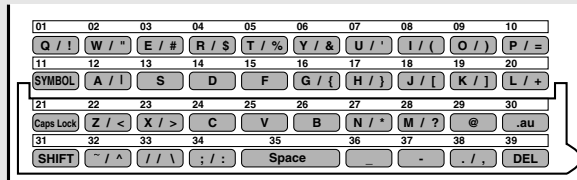

- 6** Press .

Note: After entering the passcode, the fax machine will print it out for your records. If you forget the passcode and have kept no record, contact your Sharp dealer.

Clearing a passcode

- 1** Press  (flip up the Rapid Key overlay if it is down) and then .

Display:

4:CONF. CODE CLEAR
ENTER BOX # (00-99)

- 2** Enter the 2-digit number that identifies the mailbox you want to clear.
- 3** Enter the 4-digit passcode of the mailbox with the numeric keys.
- 4** Press .

Printing out received documents

When you have received a confidential document, RCVD CONF. FAX will appear in the display. Print out the Confidential Reception List as explained on page 107 to see which mailbox has received the document, and then follow the steps below to print out the document.

- 1** Press  (flip up the Rapid Key overlay if it is down) and .

Display:

2:CONF. DATA PRINT
ENTER BOX # (00-99)

- 2** Enter your mailbox number.
- 3** Enter your confidential passcode.
- 4** Press .

- Printing will begin. After printing, the document will be erased from memory.

Polling

Polling allows you to call another fax machine and have it send a document to your machine without operator assistance. In other words, the receiving fax machine, not the transmitting fax machine, initiates the transmission. You can use your fax machine to both poll and be polled by others.

Polling others

To poll another fax machine, follow the steps below.



- ◆ If desired, you can dial more than one fax number to receive documents consecutively from a group of fax machines (this is called "Serial Polling"; a maximum of 154 fax machines can be polled in one operation).



1 Press **MENU** and then **6**.

Display:

6: SERIAL POLL. MODE
ENTER STATION #

2 Dial the number(s) of the fax machine(s) you want to poll using one (or more) of the following methods:

- Press one or more Rapid Keys.
- Enter one or more Speed Dial numbers, pressing **SPEED DIAL**  before each number. (If you enter less than 2 digits, press **START/ENTER**  to complete the entry.)
- Press one or more Group Keys.
- Enter one or more full fax numbers with the numeric keys, pressing **START/ENTER**  after each full number.

Note: If you need to delete a number, press  or  until the destination appears in the display and then press **STOP** .

3 Press **START/ENTER** . Reception will begin.

Serial Polling using a Group Key

If the fax machines you want to poll have all been programmed into one Group Key, you can poll them by simply pressing that Group Key. (The procedure for programming Group Keys is explained on page 65.)

- ◆ Make sure no documents are in the feeder before you press the Group Key.

Being polled (Memory polling)

To let another fax machine poll your fax machine, you must first store the document(s) in memory using the following procedure. Transmission will take place when the other fax machine calls your fax machine and activates polling. You can choose whether to allow polling only once, or an unlimited number of times. In the latter case, your fax machine can be used as an electronic "bulletin board".

- ◆ Multiple documents can be stored for memory polling. To add a document to others already stored, simply repeating the storing procedure (note that if Department Control is activated, documents cannot be added by a department other than that which stored the first document). When polling is initiated, the polling machine will receive all documents stored.
- ◆ If you allow polling only once, the document(s) will be automatically cleared from memory after polling. If you allow polling an unlimited number of times, the document will remain in memory until you clear it as explained in the following section, *Clearing a document*.

1 Load the document.

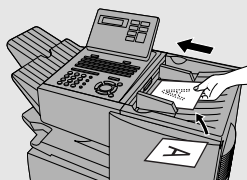

2 Set the reception mode to AUTO (press , ① and ①).

3 Press and then ⑦ .

Display:

7:MEMORY POLL MODE
ENTER #(1-2, ◀, ▶)

4 Press **1** to select SET.

1:MEMORY POLL SET 1=1 TIME, 2=REPEAT

- If another document has already been stored, press **1** to select APPEND, and go to Step 6.

5 Press **1** to allow polling only once, or **2** to allow polling an unlimited number of times.**6** Press **RESOLUTION** and/or **CONTRAST** to adjust the resolution and contrast if desired, and then press **START/ENTER**.**7** Press **START/ENTER**.

- The document will be scanned into memory, and your fax will go on polling standby.

Clearing a document

To clear a memory poll document from memory, follow the steps below:

1 Press **MENU** and then **7**.

Display:

7:MEMORY POLL MODE ENTER #(1-2, ◀, ▶)
--

2 Press **2** to select CLEAR.

2:MEMORY POLL CLEAR PRESS START TO CLEAR

3 Press **START/ENTER** to clear the documents.

Polling Security

Polling Security allows you to prevent unauthorized polling of your fax. When this function is activated, polling will only take place when one of the following conditions is met:

- ◆ The fax number of the polling fax machine has been stored in your fax's list of permitted fax numbers (called "passcode numbers"). The polling fax must also have its fax number programmed in itself, as explained in *Entering Your Name and Fax Number* in Chapter 1.
- ◆ A System number has been programmed in the polling fax machine which matches your fax's System number or one of your ID numbers.
- ◆ An ID number has been programmed in the polling fax machine which matches your fax's System number.

System and ID numbers are 4-digit numbers which provide you with an alternate means of giving and receiving polling permission when you don't want to use fax numbers. The steps for programming these numbers are described in the following pages.

Note: System and ID numbers can only be used if the other fax machine is also a Sharp machine.

Turning Polling Security on and off

Polling Security is turned on or off with Option Setting 8 as explained on page 101.

Storing and clearing fax numbers for polling permission

You can store up to 10 fax numbers in your fax's list of permitted numbers.

1 Press **MENU** , **3** , **0** , **2** .

Display:

02:PASSCODE # MODE
1=SET, 2=CLEAR

2 Press **1** to set a number.
(Press **2** to clear a number.)

1:PASSCODE SETTING
ENTER # (01-10)

3 Storing: Enter a 2-digit number (from 01 to 10). This number identifies the fax number you will enter in the next step.

Clearing: Enter the 2-digit number which identifies the fax number you want to clear, and go to Step 5.

4 Enter the fax number (max. 20 digits) by pressing the numeric keys.

5 Press  .

6 Return to Step 3 to enter (or clear) another number, or press  repeatedly to return to the date and time display.

Programming and clearing a System number

One 4-digit System number can be programmed in your fax machine for giving and receiving polling permission. Polling will take place if your System number matches the other fax machine's System number or one of its ID numbers.

1 Press **MENU** , **3** , **0** , **7** .

Display:

07:SYSTEM # MODE
1=SET, 2=CLEAR

2 Press **1** to program the System number.

(To clear the System number, press **2** and go to Step 4.)

1:SYSTEM # SET
ENTER 4 DIGITS

3 Enter the number (4 digits) with the numeric keys.

4 Press  .

5 Press  repeatedly to return to the date and time display.

Storing and clearing ID numbers for polling permission

Up to five 4-digit ID numbers can be programmed in your fax machine for giving and receiving polling permission. Polling will take place if one of your ID numbers matches the other fax machine's System number.

1 Press , **3**, **0**, **6**.

Display:

06:ID # MODE
1=SET, 2=CLEAR

2 Press **1** to program an ID number.
(Press **2** to clear an ID number.)

1:ID CODE # SET
ENTER # (1-5)

3 **Storing:** Enter a number from 1 to 5. This number identifies the ID number you will enter in the next step.

Clearing: Enter the number which identifies the ID number you want to clear, and go to Step 5.

4 Enter the ID number (4 digits) by pressing the numeric keys.

5 Press .

6 Return to Step 3 to enter (or clear) another number, or press  repeatedly to return to the date and time display.

Timer Operations

The Timer function allows you to store a job to be performed automatically at a specified time. Up to 59 timer jobs can be stored at any one time, and the time of each can be specified up to a week in advance.

You can use this function to take advantage of lower off-peak rates without having to be there when the operation is performed.

Note:  cannot be used for a timer transmission.

Initial procedure



To store a timer job, first perform the following procedure. After you have completed this procedure, go to the procedure for the specific job you want to store (see the following pages).





- 1** Press  . (Flip up the Rapid Key overlay if it is down.)

Display:

TIMER MODE
1=SET, 2=CLEAR

- 2** Press  to select SET.

- 3** Enter a number as follows to select the desired operation (or scroll to the desired operation with  or  and press .

-  **Transmission (SEND MODE)**
-  **Confidential transmission**
-  **Polling**
-  **Serial Polling**
-  **Broadcasting**

- 4** Enter a two-digit number for the hour (“00” to “23”) and a two-digit number for the minute (“00” to “59”).

5 Enter a number as follows to select the day of the operation (skip this step if the operation will be performed within the next 24 hours):



- ① Sunday
- ② Monday
- ③ Tuesday
- ④ Wednesday
- ⑤ Thursday
- ⑥ Friday
- ⑦ Saturday

6 Press  and go to the specific procedure for your operation (see the following pages).



Transmission

(Continued from *Initial procedure.*)

7 Dial the receiving machine using one of the following methods:

- Press a Rapid Key.
- Press  and enter a Speed Dial number (if you enter less than 2 digits, press  to complete the entry).
- Enter a full fax number with the numeric keys.

8 Press  .

9 Press  and/or  to adjust the resolution and contrast if desired, and then press .

10 Load the document and then press .

- The document will be scanned into memory.



Confidential transmission

(Continued from *Initial procedure.*)

7 Enter the mailbox number (2 digits). (Go directly to Step 8 if the receiving machine does not have mailboxes.)

8 Press .

9 Dial the receiving machine using one of the following methods:

- Press a Rapid Key.
- Press  and enter a Speed Dial number (if you enter less than 2 digits, press  to complete the entry).
- Enter a full fax number with the numeric keys.

10 Press .

11 Press  and/or  to adjust the resolution and contrast if desired, and then press .



12 Load the document and then press .

- The document will be scanned into memory.

Polling

(Continued from *Initial procedure.*)

7 Dial the machine to be polled using one of the following methods:

- Press a Rapid Key.
 - Press  and enter a Speed Dial number (if you enter less than 2 digits, press  to complete the entry).
 - Enter a full fax number with the numeric keys.
-

8 Press .

Serial Polling

(Continued from *Initial procedure.*)

7 Dial the machines to be polled using one or more of the following methods:



- Press one or more Rapid Keys.

- Enter one or more Speed Dial numbers, pressing  before each number. (If you enter less than 2 digits for a Speed Dial number, press



to complete the entry.)

- Enter one or more full fax numbers with the numeric keys, pressing  after each full number.
- Press one or more Group Keys.

Note: If you need to delete a number, press  or  until the destination appears in the display and then press .

8 Press .

Broadcasting

(Continued from *Initial procedure.*)



7 Dial the receiving machines using one or more of the following methods:

- Press one or more Rapid Keys.
- Enter one or more Speed Dial numbers, pressing  before each number. (If you enter less than 2 digits for a Speed Dial number, press



to complete the entry.)

- Enter one or more full fax numbers with the numeric keys, pressing  after each full number.
- Press one or more Group Keys.

Note: If you need to delete a number, press  or  until the destination appears in the display and then press .

8 Press .

9 Press  and/or  to adjust the resolution and contrast if desired, and then press .

10 Load the document and then press .

- The document will be scanned into memory.

Canceling a timer operation

If you need to cancel a timer operation before it is performed, follow the steps below.

- ◆ You will need to know the number assigned to the operation in order to cancel it. If you don't remember the number (it appears in the display when you set the operation), print out the Timer List. (See page 107.)

1 Press  (flip up the Rapid Key overlay if it is down) and then **2**.

Display:

2:TIMER COMM. CLEAR
ENTER #(01-59)

2 Enter the 2-digit number assigned to the operation.

3 Press .

4 Press  repeatedly until you return to the date and time display.

Batch Transmission

Batch transmission allows you to store multiple fax jobs in memory for automatic transmission to one destination at a set time. If you often send faxes to a particular destination, this function helps reduce telephone costs by allowing you to conveniently send multiple faxes on one connection.

Programming a Batch Key

To perform a batch transmission, you must first program the number of the receiving machine and the time of transmission into a Batch Key. Any Rapid Key which has not already been programmed can be used as a Batch Key.

If you specify a day-of-the-week in your program, the transmission will be performed every week on that day. If you do not specify a day-of-the-week, the transmission will be performed every day.

To program a Batch Key, follow the procedure for entering programs explained in *Entering and Using Programs* on page 85. In Step 10 of the initial procedure, select "Batch transmission".

Clearing a Batch Key

To clear a Batch Key, follow the procedure on page 92.

Storing documents for transmission

Follow the steps below to store a document under a Batch Key for transmission. When you store the document, it is given a message number to distinguish it from other jobs stored in the same batch.

- ◆ If no jobs have been stored under a Batch Key when the time for transmission arrives, transmission will not take place.

1 Load the document (s).

- SEND READY will appear in the display.

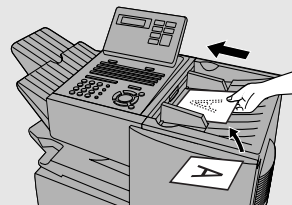

2 Press the appropriate Batch Key.

- After scanning, the message number assigned to your document will appear in the display.

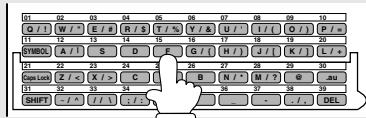

3 Press .

- The document will be transmitted at the designated time along with any other jobs stored under the same key. After transmission, all jobs in the batch will be cleared from memory.

Canceling a document stored for batch transmission

If necessary, you can cancel a document stored for a batch transmission before transmission takes place. To do so, you will need to know the message number assigned to the document.

- ◆ If you don't remember the message number, print out the Batch Transmission List (see page 107).

1 Press the Batch Key in which the document you want to clear has been stored.

- Make sure no documents are in the feeder.

2 Enter the 3-digit message number assigned to the document.

3 Press .

Entering and Using Programs

If you frequently perform the same operation involving the same party, you can program all the steps of the operation into one Program Key. This allows you to perform the operation by simply pressing that key.

- ◆ Any Rapid Key which is not already programmed as a Rapid Key or a Group Key can be used as a Program Key.
- ◆ You can include a timer setting in the program to have the operation performed automatically at a selected time.
- ◆ To clear a mistake in the procedures that follow, press .

Initial procedure

To program a Program Key, first perform the following procedure. After you have completed this procedure, go to the procedure for the specific operation you want to program (see the following pages).

1 Press **MENU**, **5** and **1**.

Display:

1:PROGRAM ENTRY MODE
1=SET, 2=CLEAR

2 Press **1** to select SET.

1:PROGRAM SET
PRESS PROGRAM KEY

3 Select a Program Key by pressing any Rapid Key that has not yet been programmed.

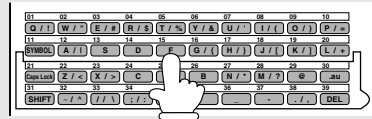

4 Enter a name for the program by pressing the letter entry keys (see Step 5 on page 24). (Maximum of 20 characters.)
If you don't want to enter a name, go directly to Step 5.



5 Press .

6 If you want to include a timer setting, enter a two-digit number for the hour (“00” to “23”) and a two-digit number for the minute (“00” to “59”). (If not, go directly to Step 8.)

7 Enter a number as follows to select the day of the operation (skip this step if the operation will be performed within the next 24 hours):

- ① Sunday
 - ① Monday
 - ② Tuesday
 - ③ Wednesday
 - ④ Thursday
 - ⑤ Friday
 - ⑥ Saturday
-

8 Press .

9 Enter a number as follows to select the desired operation (or scroll to the desired operation with  or  and press .



- ① Transmission (SEND MODE)
 - ② Confidential transmission
 - ③ Polling
 - ④ Serial Polling
 - ⑤ Broadcasting
 - ⑥ Batch transmission (only possible if a timer setting was made)
 - ⑥ Memory Polling (only possible if a timer setting was not made)
-

10 Go to the specific procedure for your operation (see the following pages).

Transmission

(Continued from *Initial procedure.*)

11 Dial the receiving machine using one of the following methods:

- Press a Rapid Key.
- Press  and enter a Speed Dial number (if you enter less than 2 digits, press  to complete the entry).
- Enter a full fax number with the numeric keys.

12 Press .

13 Press and/or to adjust the resolution and contrast if desired, and then press .

14 If you want the document to be sent through memory, press .

If you want the document to be sent directly from the feeder, press



. (This is not possible if you included a timer setting.)

15 Press repeatedly until you return to the date and time display.



Confidential transmission

(Continued from *Initial procedure.*)

11 Enter the mailbox number (2 digits). (Go directly to Step 12 if the receiving machine does not have mailboxes.)

12 Press  .

13 Dial the receiving machine using one of the following methods:

- Press a Rapid Key.
 - Press  and enter a Speed Dial number (if you enter less than 2 digits, press  to complete the entry).
 - Enter a full fax number with the numeric keys.
-

14 Press  .

15 Press  and/or  to adjust the resolution and contrast if desired, and then press  .

16 If you want the document to be sent through memory, press  .

If you want the document to be sent directly from the feeder, press



 . (This is not possible if you included a timer setting.)

17 Press  repeatedly until you return to the date and time display.

Polling

(Continued from *Initial procedure.*)

11 Dial the machine to be polled using one of the following methods:

- Press a Rapid Key.
- Press  and enter a Speed Dial number (if you enter less than 2 digits, press  to complete the entry).
- Enter a full fax number with the numeric keys.



12 Press .



13 Press repeatedly until you return to the date and time display.

Serial Polling

(Continued from *Initial procedure.*)

11 Dial the machines to be polled using one or more of the following methods:

- Press one or more Rapid Keys.
- Enter one or more Speed Dial numbers, pressing  before each number. (If you enter less than 2 digits for a Speed Dial number, press  to complete the entry.)
- Enter one or more full fax numbers with the numeric keys, pressing  after each full number.
- Press one or more Group Keys.

Note: If you need to delete a number, press  or  until the destination appears in the display and then press .



12 Press .

13 Press  repeatedly until you return to the date and time display.



Broadcasting

(Continued from *Initial procedure.*)



11 Dial the receiving machines using one or more of the following methods:

- Press one or more Rapid Keys.
- Enter one or more Speed Dial numbers, pressing  before each number. (If you enter less than 2 digits for a Speed Dial number, press  to complete the entry.)

- Enter one or more full fax numbers with the numeric keys, pressing  after each full number.
- Press one or more Group Keys.

Note: If you need to delete a number, press  or  until the destination appears in the display and then press .

12 Press .

13 Press  and/or  to adjust the resolution and contrast if desired, and then press .



14 Press .

15 Press  repeatedly until you return to the date and time display.



Batch transmission

(Continued from *Initial procedure*.)

11 Dial the receiving machine using one of the following methods:

- Press a Rapid Key.
- Press  and enter a Speed Dial number (if you enter less than 2 digits, press  to complete the entry).
- Enter a full fax number with the numeric keys.

12 Press .

13 Press  and/or  to adjust the resolution and contrast if desired, and then press .

14 Press .

15 Press  repeatedly to return to the date and time display.

Being Polled (Memory polling)

(Continued from *Initial procedure.*)

11 Press **1** to allow polling only once, or **2** to allow polling an unlimited number of times.

12 Press .

13 Press  and/or  to adjust the resolution and contrast if desired, and then press .

14 Press .

15 Press  repeatedly until you return to the date and time display.

Clearing a Program Key

To clear a Program Key, follow these steps:

1 Press , **5** and **1**.

Display:

1:PROGRAM ENTRY MODE
1=SET, 2=CLEAR

2 Press **2** to select CLEAR.

2:PROGRAM CLEAR
PRESS PROGRAM KEY

3 Press the Program Key you want to clear.



4 Press  .

5 Press  repeatedly until you return to the date and time display.

Using a Program Key

Follow the steps below to perform a programmed operation.

1 If this is a transmission operation or memory polling operation, load the document.

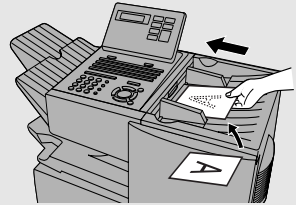

2 Press the appropriate Program Key.

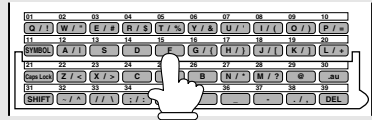

5. Special Functions

Canceling a programmed timer operation

If a Program Key has been pressed for a timer operation and you need to cancel the operation before it is performed, follow the steps below.

Note: This procedure will not work for a document stored for a batch transmission. To cancel a batch transmission operation, see *Canceling a document stored for batch transmission* on page 84.

1 Press the Program Key.

2 Press  .

Duplex Scanning for Two-sided Documents

To transmit or copy documents which have printing or graphics on both sides of the page or pages, use Duplex Scanning. With this function, you simply feed the document (all pages) through the machine once, turn the stack of pages over, and feed it through again.

- ◆ The machine will automatically sort the pages into the correct order (front of 1st page, back of 1st page, front of 2nd page, back of 2nd page, etc.).
- ◆ Duplex Scanning can be used for copying (single copies and sorted multiple copies only) and any type of transmission from memory.
- ◆ Note that any blank sides must be included when scanning the pages (if the number of pages is not equal each time the machine scans the stack, an error will result). The blank sides will not, however, be printed out.

1 Load the document (s).

- Make sure the page(s) are front face down, with the first page on the bottom.
- SEND READY will appear in the display.

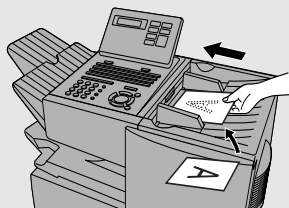

2 Press **DUPLEX SCAN** and then **START/ENTER** .

3 Perform all steps of the desired copy or memory transmission.

4 When all pages of the document have been scanned, turn the stack over (do not change the page order) and load it again.

5 Press **START/ENTER** .

Department Control

Department Control is used to limit use of the fax machine to authorized users. When it is activated, a department code must be entered before an operation can be performed.

- ◆ Department Control can only be activated by your Sharp dealer. If you want to use this function, contact your dealer.
- ◆ Department Control allows you to track the number of pages transmitted as well as the transmission time for each authorized department or person. See *Department Usage List* on page 110.

Entering Department Codes

Up to 30 different Department Codes can be entered to allow access to the fax machine. Transmitted pages and transmission time will be kept track of separately for each code. After you enter a code, inform the appropriate group or individual.

- ◆ A name must be entered for each code. Only the name, not the code, will appear on the Department Usage List.
- ◆ Be sure to keep a record of each code and name. If you misplace the record, contact your dealer.

1 Press **MENU** and **3**.

Display:

3:ENTRY MODE
ENTER #(01-10, ◀, ▶)

2 Press **0** and **9**.

09:DEPT. CODE MODE
1=SET, 2=CLEAR

3 Press **1** to program a Department Code, or **2** to clear a Department Code.

4 Entering: Enter a 2-digit number from "01" to "30" with the numeric keys. This number identifies the Department Code that you will enter in the next step.

Clearing: Enter the 2-digit number that identifies the Department Code you want to clear.

Note: It is not possible to clear the Department Code that you currently used to access the fax machine. It is also not possible clear a Department Code if only one code is programmed.

5 Entering: Enter a Department Code (4 digits or the number of digits set by Option Setting 27 as explained on page 105).

Clearing: Enter the Department Code you want to clear, and go to Step 8.

6 Press  .

7 Press the letter entry keys to enter a name for the Department Code.

8 Press  .

9 Return to Step 4 to enter (or clear) another Department Code, or press  repeatedly to return to the date and time display.

Accessing the machine

When Department Control is activated, you must enter your Department Code before performing an operation.

- ◆ If you do not begin the operation within one minute after entering the code, the fax will return to controlled access mode.

Note: You do not have to enter a Department Code to receive faxes manually (by picking up an extension phone connected to the same line and pressing  on the fax machine).

Blocking Reception of Unwanted Faxes

The Anti Junk Fax function allows you to block reception of faxes from parties that you specify. This saves paper by not printing out unwanted "junk" faxes.

To use this function, first turn it on by setting Option Setting 20 (Anti-Junk Fax) to ON as explained on page 104, and then enter the fax numbers from which you do not want to receive faxes as explained below.

- ◆ Up to 50 numbers can be entered in the Anti Junk Number List.
- ◆ To clear a number from the Anti Junk Number List, you need to know the 2-digit number that identifies it. If you have forgotten this number, print out the Anti Junk Number List as explained on page 107.

1 Press **MENU**, **3**, **0**, **8**.

Display:

08:STORE JUNK FAX #
1=SET, 2=CLEAR

2 Press **1** to enter a number in the Anti Junk Number List.
(Press **2** to clear a number from the list.)

1:JUNK FAX # SET
ENTER # (01-50)

3 **Entering:** Enter a 2-digit number from "01" to "50" with the numeric keys. This number identifies the fax number that you will enter in the next step.

Clearing: Enter the 2-digit number that identifies the fax number you want to clear, and go to Step 5.

4 Enter the fax number.

5 Press **START/ENTER**.

6 Return to Step 3 to enter (or clear) another fax number, or press **STOP** repeatedly to return to the date and time display.

Distinctive Ring (Requires Subscription to Service)

If you subscribe to a distinctive ring service from your telephone company, you will need to turn on the distinctive ring function. When this is done, your fax will signal voice calls by the normal ring pattern, and fax transmissions by a special ring pattern. In the case of a fax transmission, your fax machine will automatically answer the call and receive the fax.

The distinctive ring function is used with the reception mode set to AUTO. When your fax number is dialed, your fax machine will signal the call with a special ringing sound, then answer automatically and begin reception after the number of rings set with the NUMBER OF RINGS AUTO RECEPTION setting (the initial setting is 2 rings—refer to page 100). When your voice number is dialed, the fax machine will signal the call with the normal ringing sound to let you know that you must answer on a telephone connected to the same line.

The initial setting for distinctive ring is NO. If set to YES, both Australian (Fax Duet) and New Zealand (FaxAbility) distinctive ring are supported.

Important:

The distinctive ring function can only be used if you subscribe to a distinctive ring service from your telephone company. Do not turn on distinctive ring if you are on a normal line, as the fax machine will not operate properly.

1 Press **MENU** , and **4** .

Display:

4:OPTIONAL SETTING
ENTER #(01-36, ◀, ▶)

2 Press **2** and **8** .

28: DISTINCTIVE RING
1=YES, 2=NO

3 Press **1** to turn on distinctive ring.
(Press **2** to turn off distinctive ring.)

4 Press **STOP** repeatedly to return to the date and time display.

5 Make sure that the reception mode is set to **AUTO** (see page 58).

6. Optional Settings

The optional settings allow you to customize the fax machine to better suit your needs.

An initial setting has been made for each optional setting at the factory. To change a setting, follow the steps below to access it, and then change the setting as explained in the list that follows.

1 Press **MENU** and **4**.

Display:

4:OPTIONAL SETTING
ENTER #(01-36, ◀, ▶)



2 Press the numeric keys to enter the 2-digit number ("01" to "31") of the optional setting that you wish to change.

Example: Optional Setting 01 **0** **1**

Example: Option Setting 01 selected

01: DEFAULT FAX RES.
ENTER # (1-3) (1)

OR

Press  or  to scroll through the optional settings. When the desired optional setting appears, press .

3 Enter a selection for the optional setting by pressing the numeric keys. See the list that follows for an explanation of each of the optional settings.

4 After entering a selection, the subsequent optional setting will appear in the display. To return to the date and time display, press  twice.

Optional Settings

Setting 01: DEFAULT FAX RESOLUTION

This option sets the default resolution (the resolution used if a setting is not selected with ) for transmitting documents. Press **1** for STANDARD, **2** for FINE, or **3** for SUPER-FINE.

◆ Initial setting: 1

Setting 02: NUMBER OF RINGS AUTO RECEPTION

This sets the number of rings the fax machine waits before answering an incoming call in AUTO receive mode. Enter a number from **2** to **4**. To have the machine answer without ringing, press **0**.

◆ Initial setting: 2

Setting 03: NUMBER OF RINGS MANUAL RECEPTION

You can also have the fax machine automatically answer a call after a certain number of rings in MANUAL reception mode. To turn on this function, enter the desired number of rings (any number from **2** to **4**). To turn off the function, enter **0**.

◆ Initial setting: 0 (off)

Setting 04: AUTO LISTING

Press **1** (YES) to have the fax machine automatically print an Activity Report once every 30 send/receive operations. (The report can still be printed on demand at any time.) Press **2** (NO) to turn the function off.

◆ Initial setting: 2

Setting 05: TRANSACTION REPORT PRINT SELECTION

This sets the condition for printing out a Transaction Report. Enter a number from ① to ⑤ as follows:

- | | |
|-------------------------|---|
| ① (ERROR/TIMER MEMORY): | A report will be printed after an error, timer operation, or memory operation |
| ② (SEND ONLY) | A report will be printed only after a transmission |
| ③ (ALWAYS PRINTS) | A report will be printed after each transmission, reception, or error |
| ④ (NEVER PRINTS) | A report will never be printed. |
| ⑤ (ERROR ONLY) | A report will be printed only after an error occurs |

◆ Initial setting: 5

Note: Settings 06 and 07 are not used.

Setting 08: SECURITY SELECTION

Press ① (ON) to turn polling security on, or ② (OFF) to turn it off.

◆ Initial setting: 1

Setting 09: ERROR CORRECTION MODE (ECM)

Press ① (YES) to have any distortions in a transmission due to noise on the telephone line corrected before print-out at the receiving end. This is only effective when the other machine has ECM as well. Press ② (NO) to turn the function off.

Note: If the transmission or reception is taking place in Super G3 mode, ECM will operate regardless of the ECM setting.

◆ Initial setting: 1

Setting 10: AUTO COVER SHEET

Press **1** (YES) to have the fax automatically generate a cover sheet and send it as the last page of each transmission. Press **2** (NO) to turn the function off.

◆ Initial setting: 2

Note: Setting 11 is not used.

Setting 12: COPY SCANNING

This setting is used to reduce copies slightly before printing to ensure that data on the edges are not cut off. Press **1** (AUTO) for automatic reduction, or **2** (100%) for no reduction.

◆ Initial setting: 2

Setting 13: COPY CUT-OFF

This setting determines how the fax machine will copy documents that are longer than the printing paper. Press **1** (CONTINUE) to have the remainder of the document printed on a second page, or **2** (CUT-OFF) to cut off (not print) the remainder.

◆ Initial setting: 2

Setting 14: RECEIVE REDUCE

This setting is used to reduce received documents slightly before printing to ensure that data on the edges are not cut off. Press **1** (AUTO) for automatic reduction, or **2** (100%) for no reduction.

◆ Initial setting: 1

Setting 15: IMAGE MEMORY PRINT

Press **1** (YES) to include a copy of part of the first page of the transmitted document on the Transaction Report. Press **2** (NO) to turn the function off. This setting is only effective when transmitting from memory.

◆ Initial setting: 1

Setting 16: CASSETTE SELECTION

Press **1** (AUTO SELECTION) if you want the fax machine to automatically select the printing paper source (tray or cassette) according to the size of each page received or copied. (If a document consists of multiple pages of different sizes, each page will be printed on the paper that best matches its size.)

Press **2** (AUTO SELECTION 2) if you want the fax machine to automatically select the printing paper source (tray or cassette) according to the size of the first page of the document received or copied. (If the document consists of multiple pages of different sizes, all pages will be printed on the same size of paper based on the size of the first page.)

Press **3** (MANUAL SELECTION) if you want to set a fixed order of priority for the paper sources. When the 1ST PRIORITY setting appears, press **1** to have paper always drawn from the tray regardless of the size of the received or copied document, or **2** to have paper always drawn from the cassette. When the 2ND PRIORITY setting appears, press **1** to have paper drawn from the other source in the event that the "1st priority" source runs out of paper, or **2** (NONE) to have the incoming fax received to memory.

Note: This setting will only appear if your dealer has installed the paper cassette option and Option Setting 31 (Seperate Mode) is turned off.

◆ Initial setting: 1

Note: Settings 17 and 18 are not used.

Setting 19: POWER SAVE MODE

To conserve power, you can have the laser printer heater in your fax machine turn off when not in use. When this is done, the heater will turn on automatically when you receive a document (there will be a slight delay before printing while the heater warms up) and turn off when printing is completed.

Press **1** to turn on Power Save mode, or **2** to turn it off.

◆ Initial setting: 1

Setting 20: ANTI-JUNK FAX

Press **1** to block reception from fax numbers entered in the Anti Junk Fax List. Press **2** to allow reception from all numbers.

◆ Initial setting: 2

Setting 21: ALARM VOLUME

This sets the volume of the beep sound that alerts you to error conditions and informs you that operations have been completed. Press **1** for HIGH, **2** for LOW, or **3** for OFF.

◆ Initial setting: 2

Setting 22: DIAL MODE

This sets the dial mode. Press **1** if you are on a touch-tone line, or **2** if you are on a pulse dial (rotary) line.

◆ Initial setting: 1

Note: For all units installed in New Zealand, select "1" for tone dialling. The pulse setting "2" will not operate correctly and must not be used.

Setting 23: QUICK ON-LINE

When you transmit a multi-page document, this setting determines whether the fax machine will dial the receiving party and begin transmitting while scanning is still in progress, or wait until all pages have been scanned before dialling. Press **1** to have the fax machine dial and begin transmission while scanning is still in progress, or **2** to have the fax machine wait until all pages have been scanned.

◆ Initial setting: 1

Setting 24: MULTI TTI

If you are using Department Control, you can press **1** to have the department name (the name associated with the department code entered by an operator to access the fax) appear at the top of each transmitted document. This will appear in place of the name entered in *Entering Your Name and Fax Number* in Chapter 1. Press **2** to turn Multi TTI off (the sender's name entered in Chapter 1 will appear).

◆ Initial setting: 2

Setting 25: BEEP LENGTH

This sets the duration of the beep that signals the end of transmission, reception, or copying. Press **1** for 3 seconds, **2** for 1 second, or **3** for no beep.

◆ Initial setting: 1

Note: Setting 26 is not used.

Setting 27: DEPARTMENT CODE DIGITS

This setting allows you to change the number of digits used for Department Codes. Enter any number from **3** to **9**.

◆ Initial setting: 4

Setting 28: DISTINCTIVE RING

Use this setting if you subscribe to a distinctive ring service from your phone company and wish to have the machine automatically answer and receive faxes when your fax number is dialed. Press **1** to turn on distinctive ring or **2** to turn it off. See page 98 for detailed information on this feature.

◆ Initial setting: 2

Setting 29: VERIFICATION STAMP

Press **1** if you want the fax machine to stamp each original document page as it is scanned. After scanning, you can check to see if all pages have been stamped to verify that no double feeds occurred. Press **2** to turn the function off.

Note: To use this function, your dealer must install the Verification Stamp option.

◆ Initial setting: 2

Setting 30: COPY RESOLUTION

Use this setting to select the default copying resolution (the resolution used for copying if a setting is not made with ). Press **1** for STANDARD, **2** for FINE, or **3** for SUPER-FINE.

◆ Initial setting: 2

Setting 31: SEPARATE MODE

If desired, you can have the fax draw a sheet of paper from one of the paper sources after each fax reception. By loading coloured (or large) paper in that source, each coloured sheet drawn will act as a separator that makes it easy to distinguish where one multi-page document ends and another begins. A Transaction Report printed after a reception will also be printed from that paper source to act as a separator sheet. To turn on this function, press **1** and then select the paper source for the separator paper by pressing **1** for the paper tray or **2** for the paper cassette. After turning on the function, be sure to load appropriate paper in the selected paper source. To turn off Separate mode, press **2**. (Note that the function will turn off automatically if the selected paper source runs out of paper.)

Note: This setting is only available if your dealer has installed the paper cassette option.

◆ Initial setting: 2

Note: If you turn off the Separate Mode setting, Option Setting 16 will subsequently appear in the display to allow you make an appropriate setting for cassette selection. If you don't make a selection, 1:AUTO SELECTION will be automatically selected.

Note: Settings 32 through 36 are not used.

7. Printing Lists and Reports

You can print lists showing settings and information entered in the fax machine. You can also print out reports on recent activity and individual operations after they are completed. The lists and reports are described on the following pages.

To print a list, follow the steps below.

1 Press **MENU** , and **2** .

Display:

2:LISTING MODE
ENTER #(01-11, ◀, ▶)

2 Press the numeric keys to enter the 2-digit number (“01” to “11”) of the list you want to print.

Example: Activity Report **0** **1**

OR

Press  or  to scroll through the lists. When the desired list

appears, press .

Activity Report (List 01)

This report shows information on your most recently performed send and receive operations (a combined maximum of 30 operations can appear). The report is divided into two parts: the SEND REPORT, which shows information on transmissions, and the RECEIVE REPORT, which shows information on receptions.

- ◆ If Option Setting 4 (Auto Listing) is set to YES, a report will be automatically printed out whenever information on 30 operations has accumulated. (A report can still be printed on demand at any time.)
- ◆ All information is erased after a report is printed out. If automatic print-out is turned off and the report is not printed manually for 30 operations, the information on the oldest operation will be overwritten each time a new operation is performed.

```

XXXXXXXXXXXXXXXXXXXXXXXXXXXXXXXXXXXXXXXXXXXXXXXXXXXXXXXXXXXXXXXXXXXXXXXXXXXX
X                                                                 P. 01 X
X              SEND REPORT X
X                                                                 25-MAY-2003 TUE 05:16 X
X                                                                 X
X      FOR: John Doe Corp.      201 555 1234 X
X-----X-----X-----X-----X-----X-----X-----X-----X-----X
X # DATE START RECEIVER TX TIME PAGES TYPE NOTE M# DP X
X-----X-----X-----X-----X-----X-----X-----X-----X-----X
X 01 25-MAY 08:23 AL xx' xx" 0 FAX TX P.FAIL 001 X
X-----X-----X-----X-----X-----X-----X-----X-----X-----X
X              TOTAL: 0" 0 X
X              GRAND TOTAL TIME: 05 PAGES: 0 X
XXXXXXXXXXXXXXXXXXXXXXXXXXXXXXXXXXXXXXXXXXXXXXXXXXXXXXXXXXXXXXXXXXXXXXXXXXXX

```

Explanation of headings

SENDER/RECEIVER The name or fax number of the other machine involved in the transaction.

START The time at which transmission/reception started.

TX/RX TIME Total time taken for transmission/reception.

PAGES Number of pages transmitted/received.

TYPE **CONF. TX** - A confidential operation was performed.

(T) - A timer operation was performed.

(D) - The document was sent directly from the feeder, not from memory.

NOTE (One of the following notes will appear under **NOTE** in the report to indicate whether the transaction was successful, and if not, the reason for the failure.)

OK - Transmission/reception was successful.

P.FAIL - A power failure prevented the transaction.

JAM - The printing paper or document jammed, preventing the transaction.

BUSY - The fax was not sent because the line was busy.

COM.E-0 to COM.E-31 - A telephone line error prevented the transaction. See *Line Error in Problems and Solutions* in Chapter 9.

CANCEL - The transaction was cancelled because the **STOP** key was pressed, no document was in the feeder, or the other machine requested transmission using a function which your fax machine does not have.

CANCEL 3 - (Used for confidential transmission only)
A confidential transmission was cancelled because the receiving machine does not have a confidential function, a confidential passcode is not programmed in the receiving machine, its memory is full, or it is not a Sharp model.

CANCEL 4 - (Used for confidential transmission only)
A confidential transmission was cancelled because an incorrect mailbox number was entered for a fax machine with confidential mailboxes, or the other machine's memory is full.

Timer List (List 02)

This list shows the timer operations that are currently set.

Destination List (List 03)

This list shows the fax numbers that have been programmed for automatic dialling.

Passcode List (List 04)

This list shows your settings for polling security, your name and fax number as programmed in the fax machine, and a sample of the header printed at the top of every page you fax (HEADER PRINT).

Optional Setting List (List 05)

This list shows the current status of the option settings.

Program and Group List (List 06)

The top part of this list shows the programs that have been entered. The bottom part shows the fax numbers that have been programmed into Group Keys.

Batch Transmission List (List 07)

The Batch Transmission List shows the documents that are currently stored for batch transmission.

Department Usage List (List 08)

This list shows total transmission time and pages transmitted (including polling time and pages polled) for each department during the period indicated on the list. The information is only available if Department Control has been activated.

- ◆ Each time you print out the report, the data is cleared and a new period begins.

Confidential Reception List (List 09)

This list shows which mailboxes have received confidential documents and the total number of pages received. Print this list out whenever RCVD CONF. FAX appears in the display.

Anti Junk Number List (List 10)

This list shows the fax numbers from which reception is not allowed.

Personal Book List (List 11)

This list shows the personal books that have been created.

Transaction Report

This report is printed out automatically after an operation is completed to allow you to check the result. The fax machine is set at the factory to print out the report only when an error occurs. If desired, you can change the setting to have it printed out under a variety of other conditions. See Option Setting 5 (Print Selection) in Chapter 6.

- ◆ You can also print out the Transaction Report on demand by pressing



(flip up the Rapid Key overlay if it is down) after the operation is completed.

- ◆ The same headings appear in the Transaction Report as in the Activity Report. See *Activity Report* in this chapter for an explanation of the headings.
- ◆ The top part of the first page of the document will also appear below the report if the document was sent from memory. If confidentiality is required, you can prevent printing of the top part of the document by setting Option Setting 15 (Image Memory Print) to NO.

8. Maintenance

Cleaning the Scanning Glass and Rollers

Clean the reading glass and rollers frequently to ensure the quality of your transmitted images and copies.

1 Open the operation panel.

- Squeeze the release marked **PANEL RELEASE** and pull up.

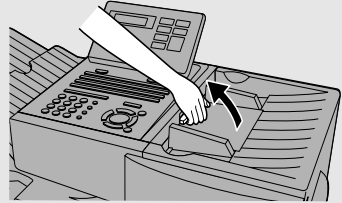

2 Wipe the scanning glass, white backplate, and rollers with a soft cloth.

- Make sure that all dirt and stains (such as correcting fluid) are removed, as dirt will cause vertical lines on transmitted images and copies. (If necessary, wipe with denatured alcohol.)

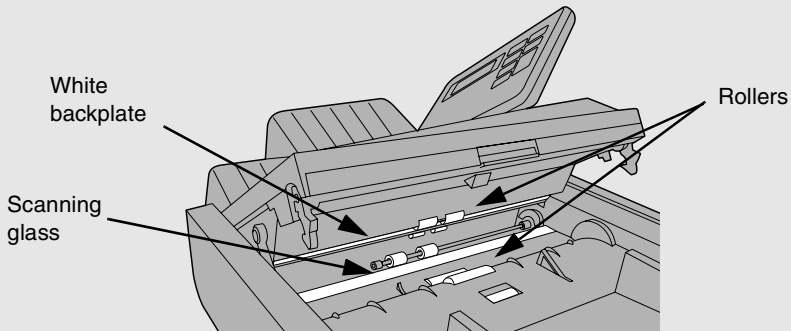

The Housing

Wipe the external parts and surface of the machine with a dry cloth.

Caution!

Do not use benzene or thinner. These solvents may damage or discolor the machine.

Replacing the Verification Stamp

If you are using the Verification Stamp function, you will need to replace the ink cartridge in the stamp unit when it runs out of ink (when the stamped mark on original documents becomes faint). A new ink cartridge can be obtained from your dealer.

- 1 Remove the ADF exit tray.**

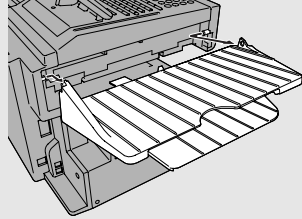

- 2 Press down on the protruding tab of the green ink cartridge and pull the cartridge out with your fingers.**

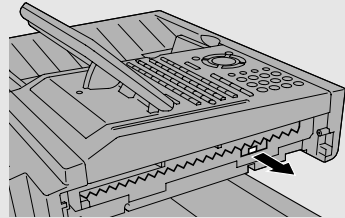

- 3 Insert the new ink cartridge into the machine (make sure that the tab is facing out).**

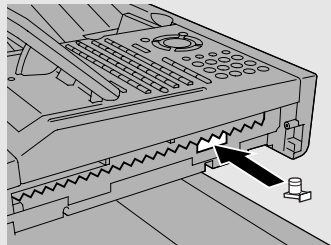

- 4 Replace the ADF exit tray.**

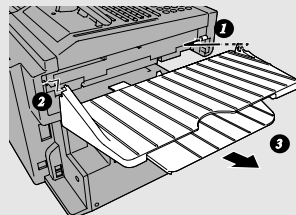

9. Troubleshooting

Problems and Solutions

Line error

Problem	Solution
<p>LINE ERROR appears in the display, and/or a transaction report is printed out with COM. E- and a number from 0 to 31 in the NOTE column.</p>	<p>Try the transaction again. If the error persists, check the following:</p> <ul style="list-style-type: none">• Check the connection. The cord from the TEL. LINE socket to the wall socket should be no longer than two meters.• Make sure there are no modem devices sharing the same telephone line.• Check with the other party to make sure their fax machine is functioning properly.• Have your telephone line checked for line noise.• Try connecting the fax machine to a different telephone line.• If the problem still occurs, your fax machine may need service.

Dialling and transmission problems

Problem	Solution
Dialling is not possible.	<ul style="list-style-type: none"> • Make sure the power cord is properly plugged into a power outlet. • Make sure that the telephone line is properly connected to both the TEL. LINE socket and the wall socket. • Make sure that the fax machine is set to the correct dialling mode for your telephone line. See Option Setting 22 in Chapter 6.
The power is on, but no transmission takes place.	<ul style="list-style-type: none"> • Make sure that the receiving machine has paper. • Make sure that the telephone line cord is plugged into the TEL. LINE socket, and not the TEL. SET socket. • If the receiving machine is in manual mode with no attendant, reception will not be possible. • If the receiving machine is not a Sharp model, make sure it is G3 compatible. • Check the display for error messages. • Press the SPEAKER key and check for a dial tone.
Nothing is printed at the receiving end.	<ul style="list-style-type: none"> • Make sure that the document for transmission is placed face down in the feeder.
A distorted image is received at the other end.	<ul style="list-style-type: none"> • If ECM mode (Option Setting 9) is turned off, noise on the telephone line may cause distortion. Try sending the document again. • Make a copy of the document on your fax machine. If the copy is also distorted, your fax machine may need service.

Reception and copying problems

Problem	Solution
The fax machine doesn't receive documents automatically.	<ul style="list-style-type: none"> • Make sure that the reception mode is set to AUTO (see page 58).
The received document is faint.	<ul style="list-style-type: none"> • Ask the other party to send higher contrast documents. If the contrast is still too low, your fax machine may need service. Make a copy or print a report to check your machine's printing ability. • The toner cartridge may need replacement.
The printed image appears dirty and/or the paper jams frequently.	<ul style="list-style-type: none"> • Have a service technician clean the print compartment.
The power is on, but no reception takes place.	<ul style="list-style-type: none"> • Make sure that the wall socket is connected to the TEL. LINE socket, and not the TEL. SET socket.
Received images are distorted.	<ul style="list-style-type: none"> • If ECM mode (Option Setting 9) is turned off, noise on the telephone line may cause distortion. Have the other party try sending the document again. • If the other machine has ECM mode, make sure this feature is turned on in both fax machines (see Option Setting 9). • Make a copy or print a report on your fax machine. If the copy or report is also distorted, your fax machine may need service. • The drum cartridge may be damaged. Try a new drum cartridge. • The fusing unit and transfer roller may need to be replaced during the life of the machine if print quality begins to deteriorate. This must be done by a service technician.

The quality of copies is poor and/or black lines appear.	<ul style="list-style-type: none"> Any dirt or material on the scanning glass will cause lines to appear on copies and transmitted faxes. Clean the scanning glass as explained in Chapter 8.
Dots appear at regular intervals on received documents and copies.	<ul style="list-style-type: none"> The drum cartridge may be damaged. Replace the drum cartridge.
The printing paper comes out blank when you try to receive a document.	<ul style="list-style-type: none"> Make sure that the document is loaded properly in the feeder of the transmitting machine. Make a copy or print a report to confirm the printing ability of your machine.

General problems

Problem	Solution
Nothing appears in the display.	<ul style="list-style-type: none"> Make sure the power cord is properly plugged into a power outlet and the power switch is turned on. Connect another electrical appliance to the outlet to see if it has power.
The machine does not respond when you press any of its keys.	<ul style="list-style-type: none"> If a beep sound is not made when you press the keys, turn off the power switch and then turn it on again several seconds later.
Automatic document feeding does not work for transmission or copying.	<ul style="list-style-type: none"> Check the size and weight of the document (see <i>Transmittable Documents</i> in Chapter 2).
No reception occurs when polling is attempted.	<ul style="list-style-type: none"> Make sure you have not run out of paper. Make sure the transmitting machine is in automatic reception mode. If the transmitting machine has polling security, make sure that your fax number has been entered both in your machine and in the transmitting machine.

<p>Bell tinkle (New Zealand)</p>	<ul style="list-style-type: none">• The operation of this equipment on the same line as the telephone or other equipment with audible warning devices or automatic ring detectors will give rise to bell tinkle or noise and may cause false tripping of the ring detector. Should such a problem occur, contact your authorised Sharp Service Centre for information.
--------------------------------------	--

Messages and Signals

Display messages

CHECK CASSETTE	This indicates that the cassette is not installed properly.
CONF. REFUSED	A confidential transmission has been denied because you entered an incorrect mailbox number for a machine with mailboxes.
CONF. RX ERROR	Confidential reception was cancelled because the mailbox number specified by the transmitting machine is not programmed in your fax machine.
CHECK COVER OR DRUM	The print compartment cover is open or the drum cartridge has not been installed. Close the cover or install the drum cartridge.
DRUM LIFE REACHED	The drum cartridge must be replaced soon (this message appears when approximately 1000 pages can still be printed).
FAX RCVD IN MEMORY	A fax has been received in memory because the toner cartridge needs replacement, you have run out of printing paper, or the paper is jammed. The fax will automatically print out when the problem is fixed.
LINE ERROR	Transmission or reception was not successful. Press STOP to clear the message and then try again. If the error persists, see <i>Line Error in Problems and Solutions</i> in this chapter.
MEMORY FULL ERROR	An internal memory error occurred. You may need to resend one or more pages of the document being transmitted when the error occurred.
MEMORY FULL ERROR PRESS STOP KEY	The memory is full and the transmission has been cancelled (this message appears when Option Setting 23, Quick On-line, is set to NO). Press the STOP key to clear the message .
MENU MODE	The MENU key has been pressed.

Messages and Signals

NO CONF. FUNCTION	Confidential transmission was cancelled because the receiving machine does not have a confidential function, a confidential passcode is not programmed in it, its memory is full, or it is not a Sharp model.
NO PAPER	This message will be followed by one of the paper sources in parentheses, and informs you that the paper source is out of paper. If no paper source is indicated, both paper sources are out of paper.
ONHOOK DIAL MODE	The SPEAKER key has been pressed and the fax machine is waiting for you to dial.
OUTPUT TRAY OFF	The received document tray is not attached. Attach it as explained in <i>Connections</i> in Chapter 1 (the tray must be attached for the fax machine to operate properly.)
PAPER JAM	The printing paper is jammed. See the following section, <i>Clearing Paper Jams</i> .
RCVD CONF. FAX	A confidential fax has been received in memory. Print the fax as explained in <i>Confidential Operations</i> in Chapter 5.
REMOVE ORIGINAL(S)	The original document is jammed. See the following section, <i>Clearing Paper Jams</i> .
SIZE ERROR	This message will be followed by one of the paper sources in parentheses, and informs you that the paper loaded in that source is not all the same size.
REPLACE TONER	The toner cartridge must be replaced.
WAITING<MEMORY FULL>	The memory has become full and scanning has stopped during scanning of a multi-page document. Scanning will automatically resume when sufficient memory becomes free (for example, after several pages are transmitted).

Audible signals

Continuous tone	3 seconds	Indicates the end of transmission, reception, or copying.
Intermittent tone (3 beeps)	5 seconds (1 second on, 1 second off)	Indicates incomplete transmission, reception, or copying.
Rapid intermittent tone	35 seconds (0.7 seconds on, 0.3 seconds off)	Indicates that an extension phone connected to the fax is off hook.

Clearing Paper Jams

Clearing a jammed document

If the original document doesn't feed properly during transmission or copying, or REMOVE ORIGINAL(S) appears in the display, first try pressing . If the document doesn't feed out, open the operation panel and remove it.

Important:

Do not try to remove a document without opening the operation panel. This may damage the feeder mechanism.

1 Open the operation panel.

- Squeeze the release marked **PANEL RELEASE** and pull up.



2 Remove the document.



3 Close the operation panel, making sure it clicks into place.

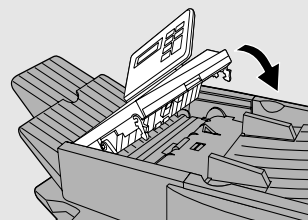

Clearing jammed printing paper

If the printing paper jams, PAPER JAM will appear in the display. Follow the steps below to clear the jam.

1 Press the green release and open the print compartment cover.

- **Caution!**

The fusing unit inside the print compartment becomes very hot during operation. Be careful not to touch the inside of the compartment.

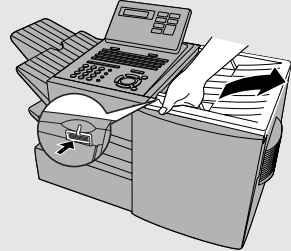

2 Remove the toner cartridge and place it on a sheet of paper.

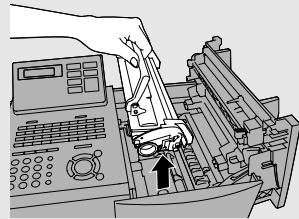

3 Remove the drum cartridge.

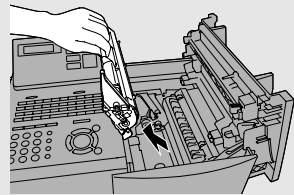

4 Remove the jammed paper.

- Make sure no torn pieces of paper remain in the print compartment and rollers.

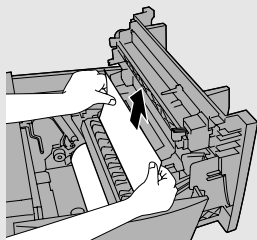

OR

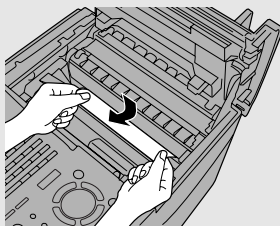

5 Replace the drum cartridge.

- Make sure the drum cartridge is inserted in as far as it will go.

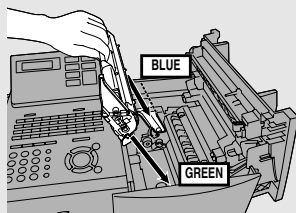

6 Replace the toner cartridge and then close the print compartment cover.

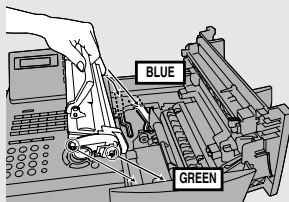

7 If you have a paper cassette and the display still indicates that paper is jammed, pull out the cassette and remove the jammed paper.

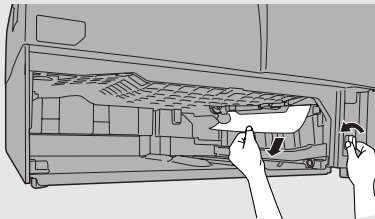

8 Replace the paper cassette.

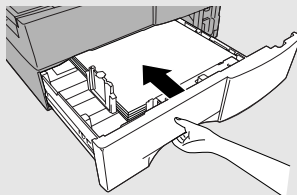

QUICK REFERENCE GUIDE

SENDING FAXES

Place the document (up to 50 A4-size pages) face down in the document feeder.



(Note: For Normal Dialling and Direct Keypad Dialling, you can also load the document after dialling the number.)

Press **RESOLUTION** or **CONTRAST** if needed.

Normal Dialling

1. Lift extension phone or press **SPEAKER**.
2. Dial the fax number (if using an extension phone, dial on the extension phone keypad).
3. Wait for the reception tone (if a person answers, ask them to press their Start key).
4. Press **START/ENTER**.

Rapid Key Dialling

Press the desired Rapid Key.

Speed Dialling

1. Press **SPEED DIAL** and enter the desired Speed Dial number (press **START/ENTER** if you entered a 1-digit number).
2. Press **START/ENTER**.

Direct Keypad Dialling

1. Dial the fax number.
2. Press **START/ENTER**.

BROADCASTING

1. Load the document and press **BROADCAST**.
2. Dial destination numbers:
Press a Rapid Key.

Press a Group Key.

Press **SPEED DIAL** and enter a Speed Dial number (press **START/ENTER** to complete entry if only one digit is entered).

Enter a full number and press **START/ENTER**.

3. When finished, press **START/ENTER**.

4. Press **RESOLUTION** or **CONTRAST** if needed.

5. Press **START/ENTER**.

STORING AUTO DIAL NUMBERS

1. Press **MENU**, **3**, **0**, **1**.

2. Press **1** to store a number.
(Press **2** to clear a number.)

3. To store a Rapid Key number, press the desired Rapid Key.

To store a Speed Dial number, press **SPEED DIAL** and enter a number from 1 to 75 (press **START/ENTER** if you entered a 1-digit number).

(If clearing a number, select it as explained above and then perform Steps 7 and 9.)

4. Enter the full fax number.

5. Press **START/ENTER**.

6. Enter a name by pressing the letter keys.

7. Press **START/ENTER**.

8. Press **1** if this is a Chain Dial number.
Press **2** if this is a regular number.

9. Press **STOP** repeatedly to exit.

Index

A

Activity Report, 107
 Auto Listing, 100
Alarm volume, 104
Anti Junk Fax, 97, 104
Anti Junk Number List, 110
Audible signals, 121
Auto Cover Sheet, 102
Auto reception mode, 58
Auto-dial numbers, programming, 36

B

Batch page numbering, 57
Batch transmission, 83-84
Batch Transmission List, 109
Beep length, 105
Broadcasting, 63-64

C

Cancelling a fax, 47, 48
Cassette Selection, 103
Chain Dialling, 39, 46
Confidential operations, 67-70
Confidential Reception List, 110
Contrast, 34
Copies, making, 61
Copy Cut-off, 102
Copy resolution, 106
Copying Scanning, 102
Cover Sheet, 55
 Auto Cover Sheet, 102

D

Date, setting, 26
Department Code Digits, 105
Department Control, 95-96
Department Usage List, 110
Destination List, 109
Dial mode, 104

Dialling

 Chain, 39, 46
 Direct Keypad, 44
 Normal, 35
 Rapid Key, 42
 Speed, 43
Direct Keypad Dialling, 44
Distinctive ring, 98
Document feeder, 32
Document guides, 32
Document restrictions, 31
Document sizes, 30
Document, maximum scanning area, 31
Drum cartridge
 Installing and replacing, 17-20
Duplex Scanning, 94

E

Error Correction Mode (ECM), 101

F

Fax Ability (distinctive ring), 98
Fax Duet (distinctive ring), 98
Fine Resolution Priority, 100

G

Group Keys, 65-66

H

Halftone setting, 33
Housing, cleaning, 112

I

Image Memory Print, 102

J

Jams, clearing, 122-124
Job status, checking, 47

L

Letters, entering, 24
 Line error, 114
 Loading the document, 32

M

Manual reception mode, 58, 59
 Memory
 Checking documents in, 47, 60
 Sending faxes from, 41
 Substitute reception to, 60
 Memory retransmission, 49
 Multi TTI, 104

N

Normal Dialling, 35
 Number of rings in auto reception, 100
 Number of rings in manual reception, 100

O

Optional Setting List, 109

P

Page numbering, batch, 57
 Paper jams, clearing, 122-124
 Paper, loading, 21
 Passcode List, 109
 Pauses in automatic dialling, 37
 Personal Book List, 110
 Personal books, 50-54
 Polling, 71-76
 Security Selection, 101
 Power Save mode, 103
 Program and Group List, 109
 Programs, 85-93

Q

Quick On-line, 104

R

Rapid Key Dialling, 42
 Receive Reduce, 102
 Reception mode
 Auto, 58
 Manual, 58, 59
 Setting, 58
 Redialling, 36, 49
 Resolution, 33
 Ringing volume, 29

S

Scanning glass, cleaning, 112
 Search Dial, 45
 Separate Mode, 106
 Speaker volume, 28
 Speed Dialling, 43

T

TEL. LINE socket, 15
 TEL. SET socket, 15
 Telephone line cord, 15
 Telephone, connecting, 15
 Time, setting, 26
 Timer, 77
 Timer List, 109
 Toner cartridge
 Installing and replacing, 17-20
 Toner cartridge indicator, 20
 Transaction Report, 111
 Print Selection, 101
 Troubleshooting, 114-118

V

Verification Stamp, 16, 105
 Replacing, 113

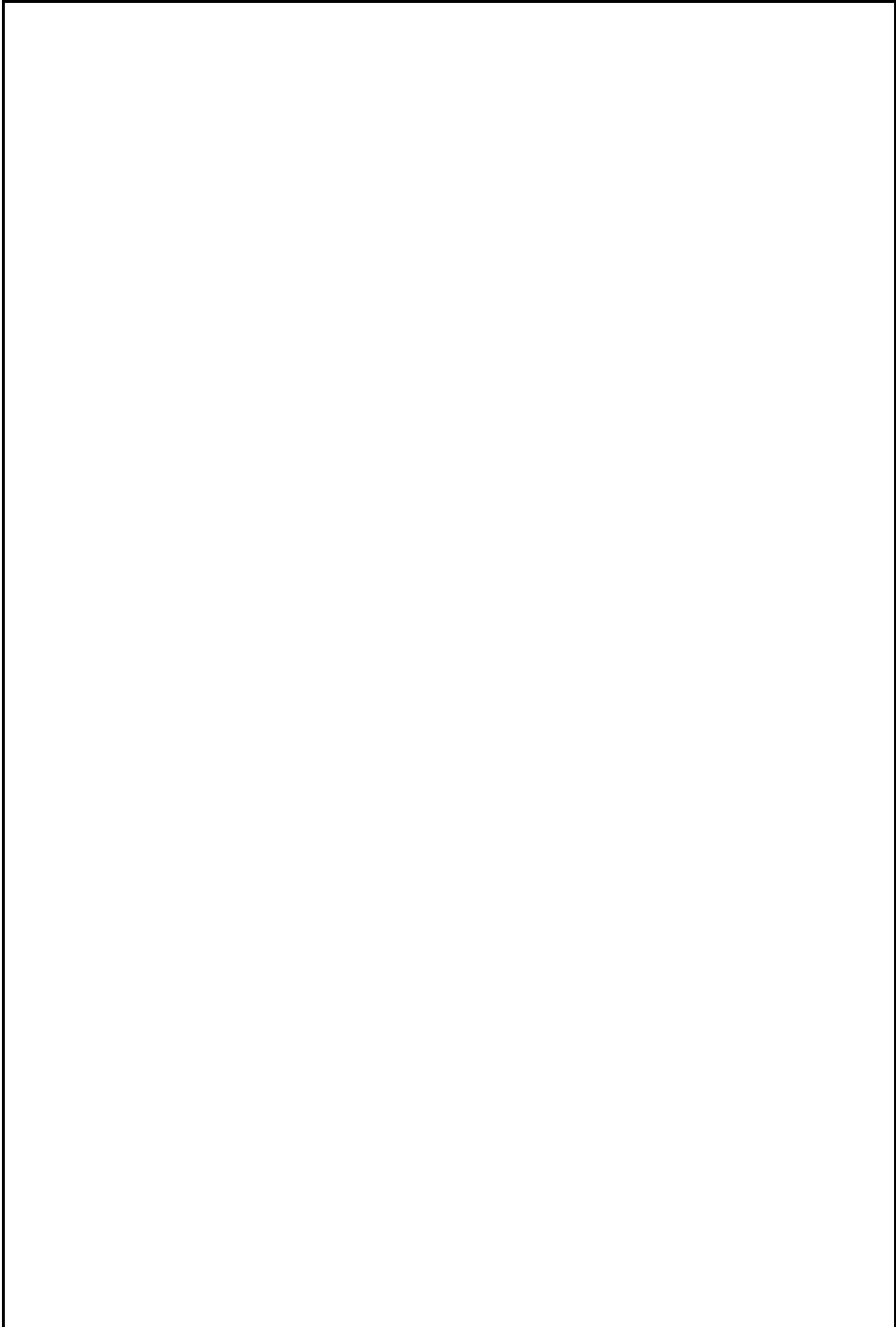

SHARP®

SHARP CORPORATION OF AUSTRALIA PTY.LTD.

A.C.N. 003 039 405

1 Huntingwood Drive, Huntingwood, Blacktown, N.S.W., 2148

SHARP CORPORATION OF NEW ZEALAND LIMITED.

59 Hugo Johnston Drive Penrose, Auckland New Zealand

SHARP CORPORATION

PRINTED IN THAILAND
(TINSE4339XHTZ)

Free Manuals Download Website

<http://myh66.com>

<http://usermanuals.us>

<http://www.somanuals.com>

<http://www.4manuals.cc>

<http://www.manual-lib.com>

<http://www.404manual.com>

<http://www.luxmanual.com>

<http://aubethermostatmanual.com>

Golf course search by state

<http://golfingnear.com>

Email search by domain

<http://emailbydomain.com>

Auto manuals search

<http://auto.somanuals.com>

TV manuals search

<http://tv.somanuals.com>