

# SHARP®

**AR-153E N**  
**AR-152E N**  
**AR-122E N**

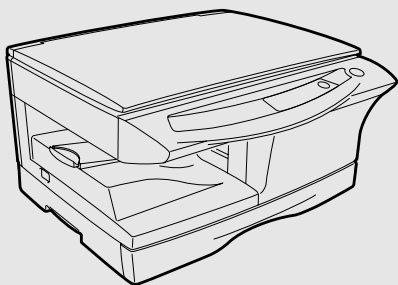

**DIGITAL LASER COPIER**  
OPERATION MANUAL

GB

**DIGITALER LASERKOPIERER**  
BEDIENUNGSANLEITUNG

D

**COPIEUR LASER NUMERIQUE**  
MODE D'EMPLOI

F

**COPIADORA LÁSER DIGITAL**  
MANUAL DE INSTRUCCIONES

E

**COPIATRICE LASER DIGITALE**  
MANUALE DI ISTRUZIONI

I

CLASS 1 LASER PRODUCT

LASER KLASSE 1

LUKOAN 1 LASERLAITE

KLASS 1 LASERAPPARAT

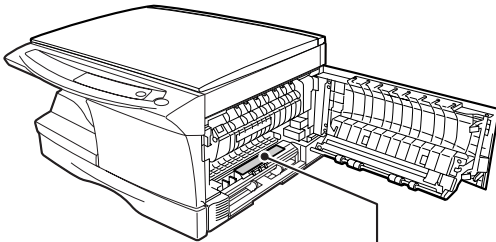

**VAROITUS!**  
LAITTEEN KÄYTTÄMINEN  
MUULLA KUIN TÄSSÄ  
KÄYTTÖOHJEESSA MAINITULLA  
TAVALLA SAATAA ALTISTAA  
KÄYTTÄJÄN  
TURVALLISUUSLUOKAN 1  
YLITTÄVÄLLE  
NÄKYMÄTTÖMÄLLE  
LASERSÄTEILYLLE.

**VARNING**  
OM APPARATEN ANVÄNDS PÅ  
ANNAT SÄTT ÄN I DENNA  
BRUKSANVISNING  
SPECIFICERATS, KAN  
ANVÄNDAREN UTSÄTTAS FÖR  
OSYNLIG LASERSTRÅLNING,  
SOM ÖVERSKRIDER GRÄNSEN  
FÖR LASERKLASS 1.



Laserstrahl

**CAUTION**  
**VORSICHT**  
**ADVARSEL**

INVISIBLE LASER RADIATION WHEN OPEN AND INTERLOCKS DEFEATED.  
AVOID EXPOSURE TO BEAM.  
USICHTBARE LASERSTRÅLNING VÄNN ABDECKNING ÖPPNAT OCH  
SÄKERHETSVERREGLING ÖBERÜCKT, NICHT DEM STRAHL AUSSETZEN.  
USYNLIG LASERSTRÅLNING VED ÅBNING, NÅR SIKKERHEDSÅFBRYDNERE ER  
UDG AF FUNKTION. UNDA UDSETTELSE FOR STRÅLING.

**ADVERSEL**  
**VARNING**  
**VARO!**

USYNLIG LASERSTRÅLNING NÄR OENSKL ÅPNES OG SIKKERHEDSLÅS BRYTES.  
UNNGÅ EKSPOSERING FOR STRÅLEN.  
OSYNLIG LASERSTRÅLNING NÄR DENNA DEL ÄR ÖPPNAD OCH SPÄRRAR ÄR  
URKOPPLADE. STRÅLEN ÄR FARLIG. BETRÄKTA EJ STRÅLEN.  
AVATTENNA JA SUOJALUKITUS OHTETTASSA OLET ALTIINA NÄKYMÄTTÖMÄ  
LASERSÄTEILYLLE. ÄLÄ KATSO SÄTTEEN.

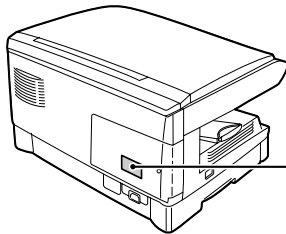

**CLASS 1  
LASER PRODUCT  
LASER KLASSE 1**

#### Caution

This product contains a low power laser device. To ensure continued safety do not remove any cover or attempt to gain access to the inside of the product. Refer all servicing to qualified personnel.

#### Vorsicht

Dieses Produkt ist mit einem Niederleistungs Laserabtaster ausgestattet. Aus Sicherheitsgründen keine Abdeckung entfernen und nicht inneenteile zu berühren versuchen. Warungsarbeiten dürfen nur von geschultem Fachpersonal durchgeführt werden.

#### Attention

Ce produit contient un dispositif émettant un laser à faible puissance. Pour assurer la sécurité, ne pas enlever le couvercle, ni accéder à l'intérieur du produit. Pour toute réparation, s'adresser à une personne qualifiée.

#### Precaución

Este producto viene provisto de un dispositivo laser de baja potencia. Para garantizar su seguridad en todo momento, no quite ninguna tapa ni intente acceder al interior del aparato. Consulte con el personal técnico calificado cualquier problema de servicio.

#### Attenzione

Questo prodotto contiene un dispositivo al laser a bassa potenza. Per motivi di sicurezza non si deve smonare il mobile per l'accesso all'interno. Per qualsiasi riparazione rivolgersi a personale qualificato.

# CAUTIONS

## Caution label on the unit

The label (   ) in the fusing area of the unit indicates the following:

 : Caution, risk of danger

 : Caution, hot surface

## Cautions on using

Follow the cautions below when using this unit.

### **Warning:**

- The fusing area is hot. Exercise care in this area when removing misfed paper.
- Do not look directly at the light source. Doing so may damage your eyes.
- Do not switch the unit rapidly on and off. After turning the unit off, wait 10 to 15 seconds before turning it back on.
- Unit power must be turned off before installing any supplies.

### **Caution:**

- Place the unit on a firm, level surface.
- Do not install the unit in a humid or dusty location.
- When the unit is not used for a long time, for example for consecutive holidays, turn the power switch off and remove the power cord from the outlet.
- When moving the unit, be sure to turn the power switch off and remove the power cord from the outlet.
- Do not cover the unit with a dust cover, cloth or plastic film while the power is on. Doing so may prevent heat radiation, damaging the unit.
- Use of controls or adjustments or performance of procedures other than those specified herein may result in hazardous radiation exposure.
- The socket-outlet shall be installed near the equipment and shall be easily accessible.

## Important points when selecting an installation site

**Do not install your unit in areas that are:**

- damp, humid, or very dusty
- exposed to direct sunlight
- poorly ventilated
- subject to extreme temperature or humidity changes, e.g., near an air conditioner or heater.

**Be sure to connect the power cord only to a power outlet that meets the specified voltage and current requirements. Also make certain the outlet is properly grounded.**



Note

*Connect the unit to a power outlet which is not used for other electric appliances. If a lighting fixture is connected to the same outlet, the light may flicker.*

**Be sure to allow the required space around the machine for servicing and proper ventilation.**

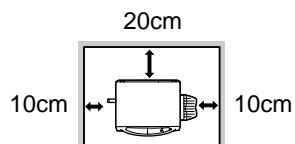

## Cautions on handling

Be careful in handling the unit as follows to maintain the performance of this unit.

**Do not drop the unit, subject it to shock or strike it against any object.**

**Store spare toner cartridges in a cool dry place without removing from the package before use.**

- If they are exposed to direct sunlight or excessive heat, poor copies may result.

**Do not touch the photoconductive drum (green portion).**

- Scratches or smudges on the drum will cause dirty copies.

## Cautions on laser

Wave length	770 nm – 795 nm
Pulse times	11.82 $\mu$ s / 7 mm
Output power	0.17 mW $\pm$ 0.01 mW

## Proper storage for supplies

**Store the supplies (paper and toner cartridges) in a location that is:**

- clean and dry
- at a stable temperature
- not exposed to direct sunlight.

**Store paper in the wrapper and lying flat.**

- Paper stored out of the wrapper or in packages standing on end may curl or get damp, resulting in paper misfeeds.

## Trademark acknowledgements

- Microsoft and Windows are trademarks of Microsoft Corporation in the U.S.A. and other countries.
- IBM and PC/AT are trademarks of International Business Machines Corporation.
- Adobe and Acrobat are trademarks of Adobe Systems Incorporated.
- All other trademarks and copyrights are the property of their respective owners.



As an ENERGY STAR® Partner, SHARP has determined that this product meets the ENERGY STAR® guidelines for energy efficiency.

In some areas, the "POWER" switch positions are marked "I" and "O" on the copier instead of "ON" and "OFF".

The symbol "O" denotes the copier is not completely de-energized but in a stand-by condition at this "POWER" switch position.

If your copier is so marked, please read "I" for "ON" and "O" for "OFF".

**Caution!**

**For a complete electrical disconnection, pull out the main plug.**

**The socket-outlet shall be installed near the equipment and shall be easily accessible.**

# CONTENTS

## 1 INTRODUCTION

USING THE MANUAL .....	4
PART NAMES .....	5
OPERATION PANEL .....	6

## 2 LOADING PAPER

PAPER .....	7
LOADING THE PAPER TRAY .....	8
BYPASS FEED (including special paper) .....	10

## 3 MAKING COPIES

COPY FLOW .....	13
CONNECTING THE POWER CORD .....	14
ORIGINAL PLACEMENT .....	16
SET THE COPY QUANTITY .....	18
EXPOSURE ADJUSTMENT/ PHOTO COPYING .....	18
REDUCTION/ENLARGEMENT/ ZOOM .....	20

## 4 SPECIAL FUNCTIONS

DESCRIPTION OF SPECIAL FUNCTIONS .....	21
TONER SAVE MODE .....	21
USER PROGRAMS .....	22
DISPLAYING TOTAL NUMBER OF COPIES .....	23

## 5 MAINTENANCE

TONER CARTRIDGE REPLACEMENT .....	24
TONER CARTRIDGE LIFE .....	26
CLEANING THE UNIT .....	27

## 6 TROUBLESHOOTING THE UNIT

TROUBLESHOOTING .....	29
STATUS INDICATORS .....	30
MISFEED REMOVAL .....	31
DEVELOPER REQUIRED .....	35
MAINTENANCE REQUIRED .....	35
SCAN HEAD LOCKING SWITCH .....	36

## 7 OPTIONAL EQUIPMENT (AL-12PKM)

SOFTWARE FOR THE SHARP PERSONAL MFP SERIES .....	37
HARDWARE AND SOFTWARE REQUIREMENTS .....	38
BEFORE INSTALLATION .....	38
INSTALLING THE SOFTWARE .....	40
INDICATORS ON THE OPERATION PANEL .....	50
USING THE PRINTER MODE .....	51
USING THE SCANNER MODE .....	53
HOW TO USE THE ONLINE MANUAL .....	61
USING OTHER INSTALLED DRIVERS .....	63
CONNECTING THE INTERFACE CABLE .....	64

## 8 OPTIONS FOR AR-153EN

SYSTEM CONFIGURATION .....	66
SINGLE PASS FEEDER (AR-SP5) .....	66
250-SHEET PAPER FEED UNIT (AR-D16) .....	67

## 9 APPENDIX

SPECIFICATIONS .....	68
ABOUT SUPPLIES AND OPTIONS .....	71
INDEX .....	72
SOFTWARE LICENSE .....	75

1

2

3

4

5

6

7

8

9

This chapter provides basic information for using the unit.

## USING THE MANUAL

The operation manual contains explanations of how to operate the unit, important considerations, and maintenance procedures. To get the most out of the unit, please read the operation manual. Please keep the operation manuals in a suitable location that will allow for convenient future reference.

### Conventions used in the manual

This operation manual explains the operation of the AR-series models. In cases where the operation is the same, AR-153EN is used. The differences between AR-122EN/AR-152EN and AR-153EN are shown below.

AR-153EN	AR-122EN/AR-152EN
<p>Copier with multi-bypass</p> <p>Printer *1 (AL-12PKM)</p> <p>Scanner *1 (AL-12PKM)</p> <p>SPF *2 (AR-SP5)</p> <p>250-sheet paper feed unit *3 (AR-D16)</p>	<p>Copier with single bypass</p> <p>Printer *1 (AL-12PKM)</p> <p>Scanner *1 (AL-12PKM)</p>

 : Standard functions and equipment

 : Optional functions and equipment

\*1 Can be used when the optional Printer/Scanner Expansion Kit (AL-12PKM) is installed.

\*2 The optional single pass feeder (AR-SP5) can be installed.

\*3 The optional 250-sheet paper feed unit (AR-D16) can be installed.

- Some models may not be available in some countries.
- This operation manual refers to the Single Pass Feeder as the "SPF".
- In this manual, the following icons are used to provide the user with information pertinent to the use of the unit.



Warning

Warns the user that injury may result if the contents of the warning are not properly followed.



Caution

Cautions the user that damage to the unit or one of its components may result if the contents of the caution are not properly followed.



Note

Notes provide information relevant to the unit regarding specifications, functions, performance, operation and such, that may be useful to the user.



Indicates a letter displayed in the display.

# PART NAMES

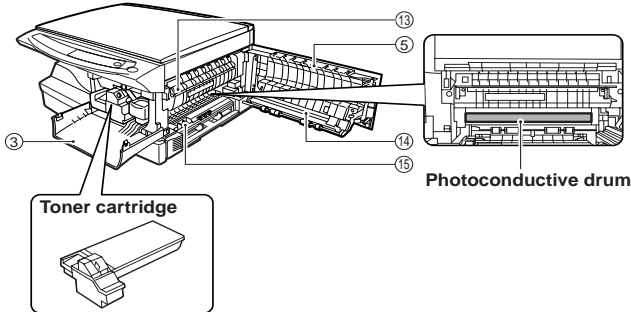
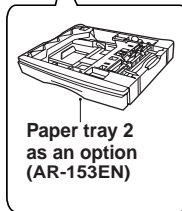
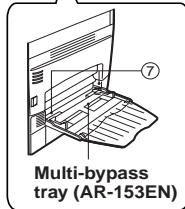
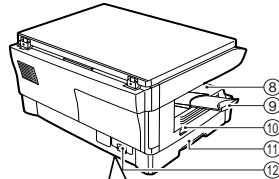
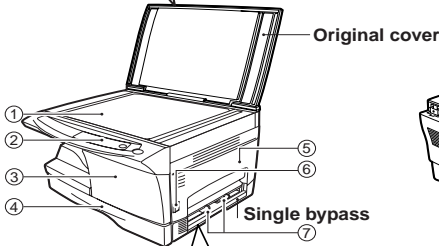
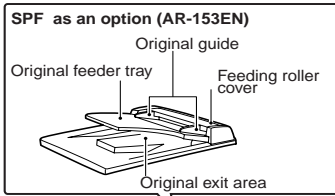

- ① Original table
- ② Operation panel
- ③ Front cover
- ④ Paper tray
- ⑤ Side cover
- ⑥ Side cover open button
- ⑦ Bypass paper guides
- ⑧ Paper output tray
- ⑨ Paper output tray extension
- ⑩ Power switch
- ⑪ Handle
- ⑫ Power cord socket
- ⑬ Fusing unit release lever
- ⑭ Transfer charger
- ⑮ Charger cleaner

# OPERATION PANEL

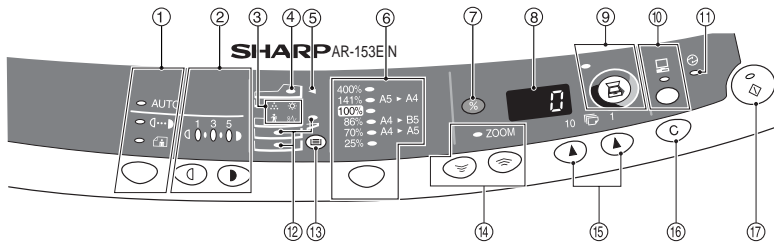

## ① Exposure mode selector key and indicators

Use to sequentially select the exposure modes: AUTO, MANUAL or PHOTO. Selected mode is shown by a lit indicator. (p.18)

## ② Light and dark keys and indicators

Use to adjust the MANUAL or PHOTO exposure level. Selected exposure level is shown by a lit indicator. (p.18) Use to start and terminate user program setting. (p.22)

## ③ Alarm indicators

- ⊙ Developer replacement required indicator (p.35)
- ⊘ Misfeed indicator (p.31)
- ⊙ Toner cartridge replacement required indicator (p.24)
- ⊙ Maintenance indicator (p.35)

## ④ SPF indicator (p.17) (AR-153EN)

Can be used when your unit has the SPF.

## ⑤ SPF misfeed indicator (p.34)(AR-153EN)

Can be used only when your unit has the SPF.

## ⑥ Copy ratio selector key and indicators

Use to sequentially select preset reduction/enlargement copy ratios. Selected copy ratio is shown by a lit indicator. (p.20)

## ⑦ Copy ratio display (%) key (p.20)

## ⑧ Display

Displays the specified copy quantity, zoom copy ratio, user program code, and error code.

## ⑨ SCANNER key and indicator (p.50, p.57)

Can be used when the Printer/Scanner Expansion Kit (AL-12PKM) is installed.

## ⑩ ONLINE key and indicator (p.50)

Can be used when the Printer/Scanner Expansion Kit (AL-12PKM) is installed.

## ⑪ Power save indicator

Lights up when the unit is in a power save mode. (p.21, p.22)

## ⑫ Paper feed location indicators

Light up to show the selected paper feed station.

## ⑬ Tray select key (AR-153EN)

Use to select a paper feed station (paper tray 1, paper tray 2 or multi-bypass tray) (p.20)

## ⑭ ZOOM keys and indicator

Use to select any reduction or enlargement copy ratio from 25% to 400% in 1% increments. (p.20)

## ⑮ Copy quantity keys

- Use to select the desired copy quantity (1 to 99). (p.18)
- Use to make user program entries. (p.22)

## ⑯ Clear key

- Press to clear the display, or press during a copy run to terminate copying. (p.18)
- Press and hold down during standby to display the total number of copies made to date. (p.23)

## ⑰ Start key and indicator

- Copying is possible when the indicator is on.
- Press to start copying.
- Use to set a user program. (p.22)



Follow the steps below to load paper into the tray.

## PAPER

For best results, use only paper recommended by SHARP.

Type of paper feeding	Type of media		Size	Weight
Paper tray	Standard paper		A4 A5 B5 Letter Legal Invoice	56g/m <sup>2</sup> to 80g/m <sup>2</sup>
Single bypass/ Multi-bypass tray	Standard paper and thick paper		A4 A5 A6 B5 B6 Letter** Legal Invoice	52g/m <sup>2</sup> to 128g/m <sup>2**</sup>
	Special media	Transparency film	A4 Letter	
		Envelope*	International DL International C5 Commercial 10 Monarch	

\* Do not use non-standard envelopes, and envelopes that have metal clasps, plastic snappers, string closures, windows, linings, self-adhesive, patches or synthetic materials. Do not use envelopes that are filled with air or envelopes that have labels or stamps attached. These will cause physical damage to the unit.

\*\* For paper weighing from 104g/m<sup>2</sup> to 128g/m<sup>2</sup>, A4 is the maximum size that can be fed through the single bypass or through the multi-bypass tray.

- Special papers such as transparency film, labels and envelope must be fed one sheet at a time through the single bypass or through the multi-bypass tray.

# LOADING THE PAPER TRAY

- 1** Raise the handle of the paper tray and pull the paper tray out until it stops.

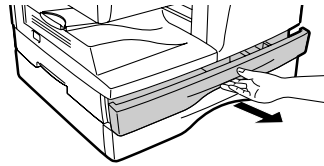

- 2** Adjust the paper guides on the paper tray to the copy paper width and length. Squeeze the lever of paper guide (A) and slide the guide to match with the width of the paper. Move paper guide (B) to the appropriate slot as marked on the tray.

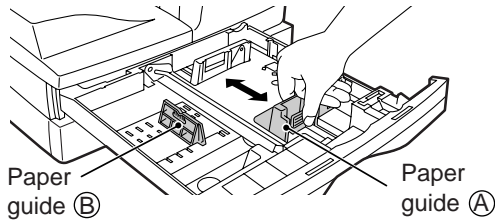

- 3** Fan the paper and insert it into the tray. Make sure the edges go under the corner hooks.



Note

*Do not load paper above the maximum height line (  ). Exceeding the line will cause a paper misfeed.*

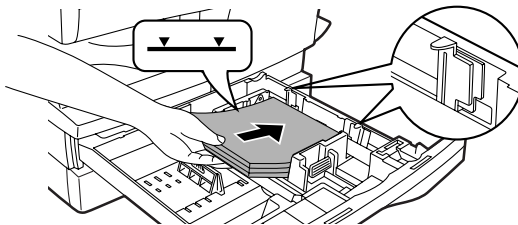



Note

- After loading paper, to cancel the blinking **P** without restarting copying, press the clear (C) key. The **P** in the display will go out and the start (S) indicator will light up.
- Be sure that paper is free of rips, dust, wrinkles, and curled or bent edges.
- Make sure all the paper in the stack is the same size and type.
- When loading paper, ensure there is no space between the paper and the guide, and check if the guide is not set too narrow causing the paper to bend. Loading paper in these ways will result in document skew or a paper jam.
- When not using the unit for an extended period, remove all paper from the paper tray and store it in a dry place. If paper is left in the unit for an extended period, the paper will absorb moisture from the air, resulting in paper jams.
- When adding new paper to the paper tray, remove the old paper already contained in the tray. Placing new paper on top of the paper already contained in the tray may result in feeding two sheets at one time.

## BYPASS FEED (including special paper)

The multi-bypass tray (AR-153EN) or the single bypass (AR-122EN/AR-152EN) can be used to feed standard paper, transparency film, labels, envelopes, and other special purpose paper. Paper measuring from A6 to A4 and in the weight range of 52 to 128g/m<sup>2</sup> can be used in this tray. (For paper weighing from 104 to 128g/m<sup>2</sup>, A4 is the maximum size.)



Note

- The multi-bypass tray (AR-153EN) can hold maximum of 50 sheets of paper. (Capacity will vary depending on the type of paper loaded.) The single bypass (AR-122EN/AR-152EN) can hold one sheet of paper.
- The original image must be smaller than the paper or media for copying. If the original image is bigger than the paper or media, this may cause smudges on the edges of the copies.

### The multi-bypass tray (AR-153EN)

#### 1 Open the multi-bypass tray and extend the tray.

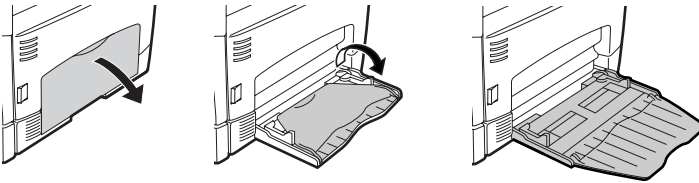

Nota

To close the multi-bypass tray, perform step 1 and then step 2 in the illustration and push the round projections at the right of the tray until they click.

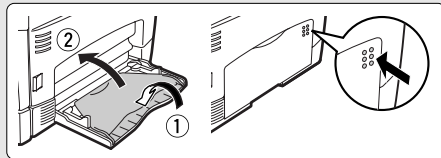

#### 2 Set the paper guides to the paper width. Insert the paper (print face down) all the way into the multi-bypass tray.

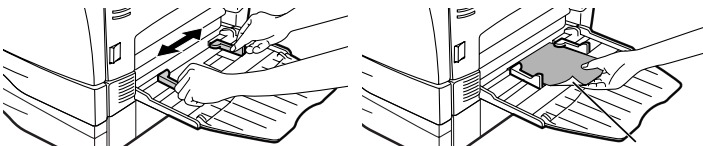

Cara de impresión



- Paper must be fed narrow side into the feed slot.
- Transparency film, labels, and other special purpose papers must be fed individually.
- When copying onto transparency film, remove each copy promptly. Do not let copies stack up. When loading an envelope, make sure that it is straight and flat.

### 3 Press the tray select ( ) key to select the multi-bypass tray.

2

## The single bypass (AR-122EN/AR-152EN)



If you insert a sheet of paper into the single bypass when multiple copies have been set with the copy quantity setting (p.18), the copy quantity setting will change to "0" and only one copy will be made.

### 1 Select copy and print settings before you begin the copy job.

For information on the copy settings, see "MAKING COPIES" (p.13)". For information on the print settings, see the online manual or the Help file for the printer driver, and then begin printing from the single bypass.

### 2 Set the paper guides to the paper width. Insert a single sheet of copy or print paper (print face down) into the feed slot of the single bypass.

#### Using copy mode

When you insert the paper, the machine will automatically draw in the paper and begin copying.

#### Using printer mode

After  appears in the display, wait until the Paper feed location indicator for the single bypass illuminates and insert the paper. The machine will automatically draw in the paper and begin printing.

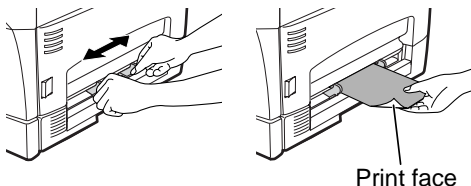

---

### **Note for loading envelopes**

- Envelopes must be fed narrow side into the feed slot one at a time.
- Do not use non-standard envelopes, and envelopes that have metal clasps, plastic snappers, string closures, windows, linings, self-adhesive, patches or synthetic materials. Do not use envelopes that are filled with air or envelopes that have labels or stamps attached.
- Envelopes of which the surface is not flat because of embossing may cause the copies/prints to become smudged.
- Under high humidity and temperature conditions the glue flaps on some envelopes may become sticky and be sealed closed when copied/printed.
- Use only envelopes which are flat and crisply folded. Curled or poorly formed envelopes may be poorly copied/printed or may cause misfeeds.
- It is recommended that you perform a test copy before performing the actual copied/printed job.
- Be sure to select either Com 10, DL, C5 or Monarch on the paper size setting of the printer driver. (For detailed information on printer driver, refer to the online manual.)

This chapter explains basic and other copying functions.

The unit is equipped with a one-page memory buffer. This memory allows the unit to scan an original once only and make up to 99 copies. This feature improves workflow, reduces operation noise from the copier, and provides higher reliability by reducing wear and tear on the scanning mechanism.



Note

*If the unit does not function properly during use, or if a function cannot be used, see "TROUBLESHOOTING THE UNIT" (p.29).*

## COPY FLOW

- 1 Make sure that paper has been loaded in the paper tray (p.8) or multi-bypass tray (p.10), and check the paper size (p.7).**

If paper is not loaded, see page 8. If you are using the single bypass, check the paper size and then proceed to the next step without loading paper.

- 2 Turn on the unit (p.14).**

- 3 Place the original.**

If you are using the original table, see "Using the original table" (p.16).

If you are using the SPF, see "Using the SPF" (p.17).

When copying onto paper larger than A4, pull out the paper output tray extension.

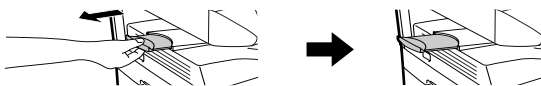

- 4 Select the copy settings.**

If you wish to copy using the initial settings (p.15), proceed to the next step.

To set the number of copies, see page 18.

To adjust the resolution and contrast settings, see page 18.

To enlarge or reduce the copy, see page 20.

AR-153EN model

To change the tray used, see page 20.

- 5 Start copying.**

Press the start (⏻) key.



### **If you are using the single bypass**

Do not press the start (⏻) key. Insert a sheet of paper into the single bypass. (Page 11)



Note

*Multiple copies are not possible using the single bypass.*



*Do not insert paper in the single bypass when a copy job from the paper tray is in progress. This will cause a misfeed.*

## CONNECTING THE POWER CORD



Warning

*If you use the unit in a country other than the country where the unit was purchased, you will need to make sure that your local power supply is compatible with your model. If you plug the unit into an incompatible power supply, irreparable damage to the unit will result.*

- 1** Ensure that the power switch of the unit is in the OFF position. Insert the attached power cord into the power cord socket at the rear of the unit.

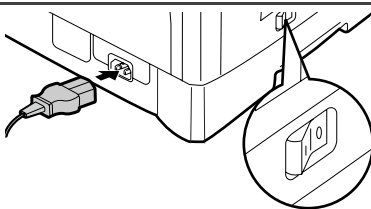

- 2** Plug the other end of the power cord into the nearest outlet.



Caution

*Only insert the power cord into a properly grounded wall socket. Do not use extension cords or power strips.*

### Power on

Ensure that the power switch of the unit is in the OFF position. Plug the other end of the power cord into the nearest outlet. Turn the power switch on the left side of the unit to the "ON" position. The start (⊕) indicator will light up and other indicators which show the initial settings of the operation panel will also light up to indicate the ready condition. For the initial settings, see the "Initial settings of operation panel" described on the next page.

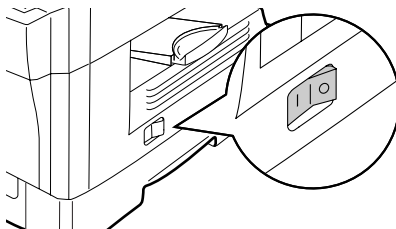

Note

- *The unit will enter a power save mode once the set time has elapsed without any unit operation. The settings of the power save modes can be modified. See "USER PROGRAMS" (p.22).*
- *The unit will return to the initial settings a preset amount of time after the end of copy or scanning job. The preset amount of time (auto clear time) can be changed. See "USER PROGRAMS" (p.22).*



## About the scan head

The scan head lamp remains on constantly when the unit is in the ready condition (when the start (Ⓢ) indicator is illuminated).

The unit adjusts the scan head lamp periodically to maintain copying quality. At this time, the scan head moves automatically. This is normal and does not indicate unit trouble.

## Initial settings of operation panel

When the unit power is on, the operation panel will revert to the initial settings when the time set with the "Auto clear time" setting (p.21) elapses after a copy or scanner job is finished, or when the clear (Ⓢ) key is pressed twice.

The initial settings of the operation panel are shown below.

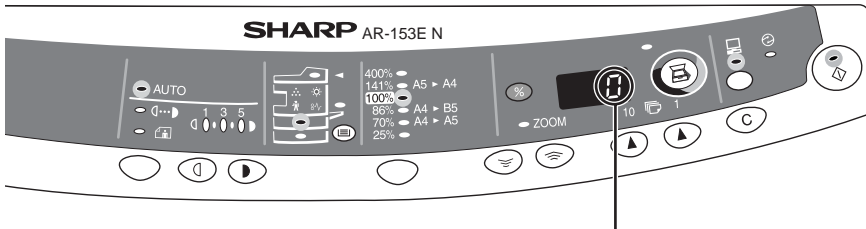

"0" is displayed in the display.

When copying is begun in this state, the settings in the following table are used.

Copy quantity	1 copy
Exposure adjustment	AUTO
Zoom	100%
Tray	Paper tray 1

## Power off methods

If not used for a certain period of time, the unit will automatically enter auto power shut-off mode (p.22) in order to minimise power consumption. In cases where the machine will not be used for a long time, turn off the power switch and remove the power cord from the outlet.

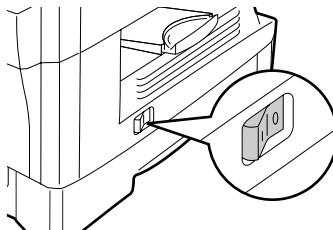

3

# ORIGINAL PLACEMENT



- *The original table can read up to A4 original.*
- *Image loss 4mm can occur at the leading and trailing edges of the copies. Also image loss 4.5mm in total can occur along the other edges of the copies.*
- *When copying a book or an original which has been folded or a crumpled original, press down the original cover lightly. If the original cover is not securely closed, the copies may be striped or blurred.*

**1** Open the original cover, and place the original.

**2** Place an original face down on the original table. Align it with the original scale and the centring (▶) mark. Gently close the original cover.

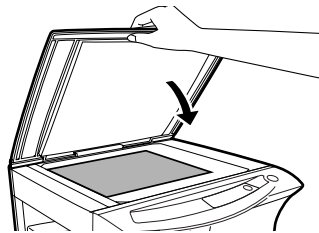
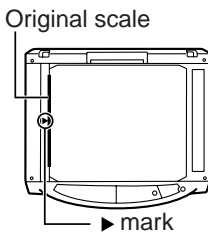

## Setting a large original

The original cover can be removed to allow copying of bulky objects.

**1** Simply lift the original cover straight up.

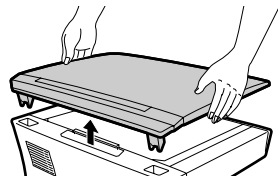

**2** To reattach the original cover, reverse the above procedure.

## Using the SPF

The SPF is designed to hold up to 30 originals measuring from A5 to A4 and weighting from 52 to 90 g/m<sup>2</sup>. weighting from 52 to 90 g/m<sup>2</sup>.



Note

- Before feeding originals in the original feeder tray, be sure to remove any staples or paper clips from them.
- Before placing curled or wavy originals into the original feeder tray, be sure to flatten them. If not, original misfeeds may result.
- The SPF (○) indicator on the operation panel will light up. If this indicator does not light up, the originals are not properly set or the SPF is not properly closed.
- Badly damaged originals may misfeed in the SPF. It is recommended that such originals be copied from the original table.
- Special originals such as transparency film should not be fed through the SPF, but should be placed directly on the original table.
- Image loss (max. 4 mm) can occur at the leading and trailing edges of the copies. Also image loss (max. 4.5 mm in total) can occur along the other edges of the copies.
- To stop continuous copying using the SPF, press the clear (⊙) key.

**1** Make sure that no original is left on the original table.

**2** Adjust the original guides to the size of originals.

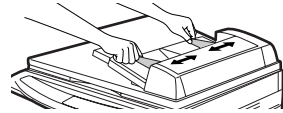

**3** Set the originals face up in the original feeder tray.

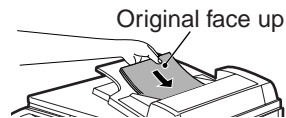

### Stream feeding mode

The stream feeding mode allows easy operation of continuous copying from the SPF. If the stream feeding mode has been enabled using user program No.4, the SPF (○) indicator will blink approximately 5 seconds after the last original has been fed by the SPF. While this indicator is blinking, any new originals placed in the original feeder tray will be fed and copied automatically. If the stream feeding mode has been disabled, the start (⊙) key must be pressed each time the originals are set even immediately after completion of a copy run from the SPF. The default setting of the stream feeding mode is "ON". See "USER PROGRAMS" (p.22).

## SET THE COPY QUANTITY

Set the number of copies using the two copy quantity ( $\odot$ ,  $\odot$ ) keys when copying from the original table or from the SPF if installed.



Note

- Press the clear ( $\odot$ ) key to clear an entry if a mistake is made.
- A single copy can be made with the initial setting, i.e., when "0" is displayed.

- Press the right copy quantity key to set the unit digit from 0 to 9. This key will not change the tens digit.
- Press the left copy quantity key to set the tens digit from 1 to 9.

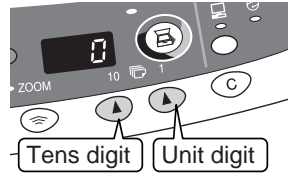

## EXPOSURE ADJUSTMENT/PHOTO COPYING

### Exposure adjustment

Copy density adjustment is not required for most originals in the automatic exposure mode. To adjust the copy density manually or to copy photographs, the exposure level can be adjusted in 2 steps manually.



Note

The copy resolution used for AUTO and MANUAL ( $\odot \dots \odot$ ) mode can be changed. (p.22)

- 1** Press the exposure mode selector key to select the MANUAL ( $\odot \dots \odot$ ) mode or PHOTO ( $\odot$ ) mode.

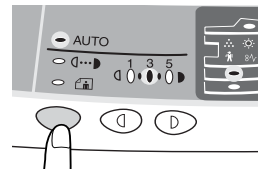

- 2** Use the light ( $\odot$ ) and dark ( $\odot$ ) keys to adjust the exposure level. If exposure level 2 is selected, the two left-handmost indicators for that level will light up simultaneously. Also, if level 4 is selected, the two right-handmost indicators for that level will light up simultaneously.

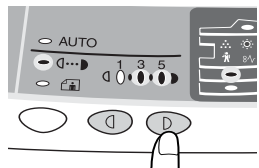

# Automatic exposure adjustment



This automatic exposure level will remain in effect until you change it again by this procedure.

The automatic exposure level can be adjusted to suit your copying needs. This level is set for copying from the original table and copying from the SPF respectively.

- 1** When adjusting the automatic exposure level for copying from the SPF, place an original in the original feeder tray and make sure that the SPF (○) indicator lights up. When adjusting the level for copying from the original table, make sure that no original is left in the original feeder tray.
- 2** Press the exposure mode selector key to select the PHOTO (📷) mode.

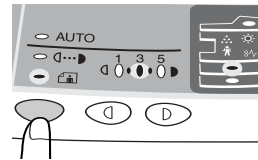

- 3** Press and hold down the exposure mode selector key for approximately 5 seconds. The PHOTO (📷) indicator will go out and the AUTO indicator will begin to blink. One or two light and dark indicators corresponding to the automatic exposure level which has been selected will light up.

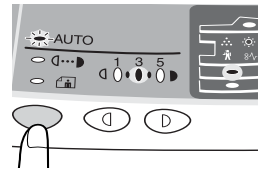

- 4** Press the light (◀) or dark (▶) key to lighten or darken the automatic exposure level as desired. If exposure level 2 is selected, the two left-handmost indicators for that level will light up simultaneously. Also, if level 4 is selected, the two right-handmost indicators for that level will light up simultaneously.

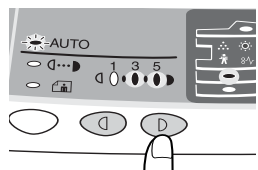

- 5** Press the exposure selector key. The AUTO indicator will stop blinking and light up steadily.

3

# REDUCTION/ENLARGEMENT/ZOOM

Three preset reduction ratios and two enlargement ratios can be selected. The zoom function enables copy ratio selection from 25% to 400% in 1% increments.

## 1 Set the original and check the paper size.

## 2 Use the copy ratio selector key and/or ZOOM ( , ) keys to select the desired copy ratio.





Note

- To verify a zoom setting without changing the zoom ratio, press and hold down the copy ratio display (%) key. When the key is released, the display will return to the copy quantity display.
- To reset the ratio to 100%, press the copy ratio selector key repeatedly until the 100% indicator lights up.

## 3 Set the reduction/enlargement ratio.



Note



To decrease or increase the zoom ratio rapidly, press and hold down the ZOOM (  ) or (  ) key. However the value will stop at the preset reduction or enlargement ratios. To move beyond these ratios, release the key and then press and hold it down again.

### To select a preset copy ratio:

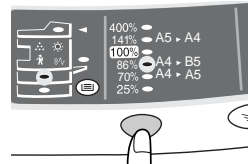
Preset reduction and enlargement ratios are: 25%, 70%, 86%, 141%, and 400%.



### To select a zoom ratio:

When a ZOOM (  ) or (  ) key is pressed, the ZOOM indicator will light up and the zoom ratio will be displayed in the display.

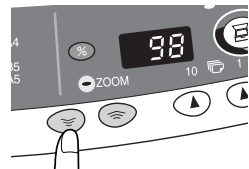

## Selecting the tray

### Press the tray select ( ) key.

Each time you press the tray select (  ) key, the location indicated by the paper feed location indicator changes in the following order: paper tray 1, paper tray 2 if installed, multi-bypass tray.

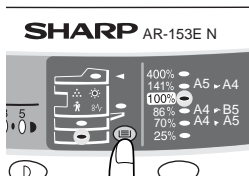

This chapter describes the special functions of this unit. Use these functions as needed.

## DESCRIPTION OF SPECIAL FUNCTIONS

### Toner save mode (page 21)

Reduces toner consumption by approximately 10%.

### Power save modes (page 22)

The unit has two power save modes of operation: preheat mode and auto power shut-off mode.

#### Preheat mode

When the unit enters the preheat mode, the power save (☺) indicator will light up and other indicators will remain on or off as before. In this condition, the fuser in the unit is maintained at a lower heat level, thereby saving power. To copy from the preheat mode, make desired copier selections and press the start (⊞) key using the normal copying procedure.

#### Auto power shut-off mode

When the unit enters the auto power shut-off mode, the power save (☺) indicator will light up and other indicators will go out. The auto power shut-off mode saves more power than the preheat mode but requires a longer time before starting copying. To copy from the auto power shut-off mode, press the start (⊞) key. Then make desired copier selections and press the start (⊞) key using the normal copying procedure.

### Auto clear (page 22)

The unit returns to the initial settings a preset amount of time after the end of copy, or scanner job. This preset amount of time (auto clear time) can be changed.

### Resolution of AUTO & MANUAL mode (page 22)

You can set the copy resolution used for AUTO and MANUAL (◀...▶) exposure mode.

## TONER SAVE MODE

- 1 Press the exposure mode selector key to select the MANUAL (◀...▶) mode.

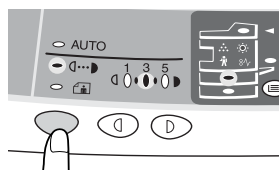

- 2 Press and hold down the exposure mode selector key for approximately 5 seconds. The MANUAL (◁⋯▷) indicator will go out and the PHOTO (📷) indicator will begin to blink. The light and dark indicator marked "5" will light up, indicating the standard toner mode is active.

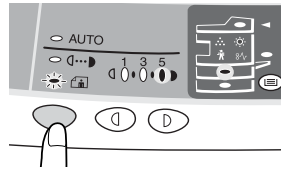

- 3 To enter the toner save mode, press the light (◁) key. The light and dark indicator marked "1" will light up, indicating the toner save mode is selected.

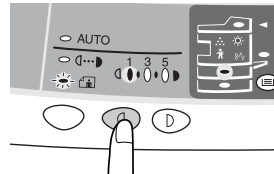

- 4 Press the exposure mode selector key. The PHOTO (📷) indicator will stop blinking and will light up steadily. The light and dark indicator marked "3" will light up. The toner save mode is now active.



Note

To return to the standard mode, repeat the procedure but use the dark (▷) key to select exposure level "5" in step 3.

## USER PROGRAMS

The user programs allow the parameters of certain functions to be set, changed, or cancelled as desired.

### Setting the power save modes, auto clear time, stream feeding mode and resolution of AUTO & MANUAL mode

- 1 Press and hold down the light (◁) and dark (▷) keys simultaneously for more than 5 seconds until all the alarm indicators (🔴, ⚠, 🚫, 🚫) blink and " -- " appears in the display.
- 2 Use the left copy quantity (◁) key to select a user program number (1: auto clear time, 2: preheat mode, 3: auto power shut-off timer, 5: auto power shut-off mode 6: resolution of AUTO & MANUAL mode). The selected number will blink in the left side of the display.
- 3 Press the start (⏻) key. The entered program number will be steadily lit and the currently selected parameter number for the program will blink on the right side of the display.
- 4 Select the desired parameter using the right copy quantity (▷) key. The entered parameter number will blink on the right of the display.



Program No.	Mode	Parameters
1	Auto clear time	0 → OFF, 1 → 10sec., 2 → 30sec. *3 → 60sec., 4 → 90sec., 5 → 120sec.
2	Preheat mode	*0 → 30sec., 1 → 60sec., 2 → 90sec.
3	Auto power shut-off timer	0 → 2min., *1 → 5min., 2 → 15min., 3 → 30min., 4 → 60 min., 5 → 120min.
4	Stream feeding mode	0 → OFF, *1 → ON
5	Auto power shut-off mode	0 → OFF, *1 → ON
6	Resolution of AUTO & MANUAL mode	*0 → 300dpi, 1 → 600dpi

\* Factory default settings are indicated with an asterisk (\*).



Note

Program No. 4 can be selected when your unit has the SPF.

4

- 5** Press the start () key. The right-hand number in the display will be steadily lit and the entered value will be stored.



Note

To change the setting or to set another mode, press the clear () key. The unit will return to step 2.

- 6** Press the light () or dark () key to return to the normal copy mode.

## DISPLAYING TOTAL NUMBER OF COPIES

Use the following procedure to display the total number of copies.

Press and hold down the clear () key for approximately 5 seconds. The total number of copies will appear in two steps, each with three digits.

Example: Total number of copies is 1,234.



# 5

## MAINTENANCE

This chapter describes how to replace the toner cartridge and how to clean unit.



Note

*Be sure to use only genuine SHARP parts and supplies.*



*For best copying results, be sure to use only SHARP Genuine Supplies which are designed, engineered, and tested to maximise the life and performance of SHARP copiers. Look for the Genuine Supplies label on the toner package.*

### TONER CARTRIDGE REPLACEMENT

When the toner cartridge replacement required (⋯) indicator lights up, replacement of the toner cartridge will be needed soon. Obtain a new cartridge. When the toner cartridge replacement required (⋯) indicator blinks, the toner cartridge must be replaced before copying can be resumed. Replace the toner cartridge by following the procedure below.



Note

*During long copy run of a dark original, the start (⊕) indicator may blink, the indicator light up, and the unit stop, even though toner is left. The unit will feed toner up to 2 minutes and then the start (⊕) indicator will light up. Press the start (⊕) key to restart copying.*

- 1** Open the side cover while pressing the side cover open button.

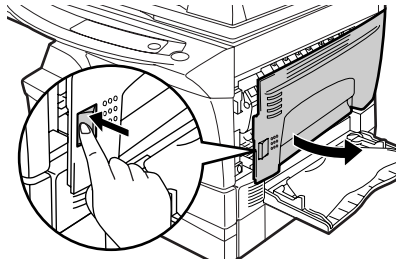

- 2** Push gently on both sides of the front cover to open the cover.

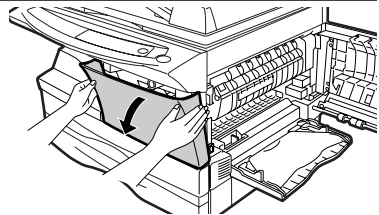

**3 Gently pull the toner cartridge out while pressing the lock release lever.**

Toner cartridge lock release lever

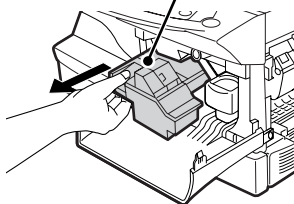

Note

- After removing the toner cartridge, do not shake it or tap on it. Doing so may cause toner to leak from the cartridge. Put the old cartridge immediately in the bag contained in the box of the new cartridge.
- Dispose of the old toner cartridge in accordance with local regulations.

**4 Remove the toner cartridge from the bag. Grasp the cartridge on both sides and shake it horizontally four or five times. After shaking the cartridge, remove the toner seal.**

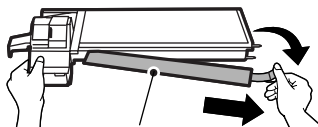
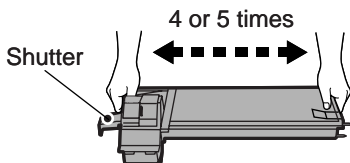

Toner seal





Note

Grasp the toner cartridge as shown in the illustration. Do not hold the cartridge by the shutter. Be sure to only shake the cartridge before the toner seal is removed.

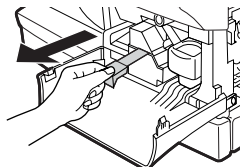
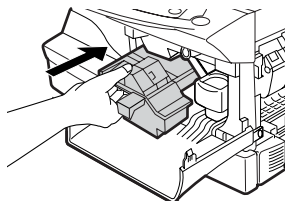
**5 Gently insert the toner cartridge along the guides until it locks in place while pushing the lock release lever. Remove the tape from the shutter. Pull the shutter out of the toner cartridge as shown in the illustration. Discard the shutter.**



5

- 6** Close the front cover and then the side cover by pressing the round projections near the side cover open button. The indicator (  ) will go out and the start (  ) indicator will light up.

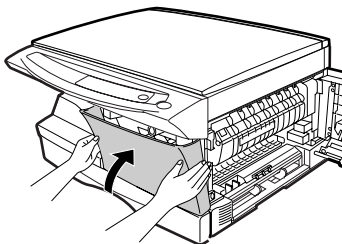

Caution

When closing the covers, be sure to close the front cover securely and then close the side cover. If the covers are closed in the wrong order, the covers may be damaged.

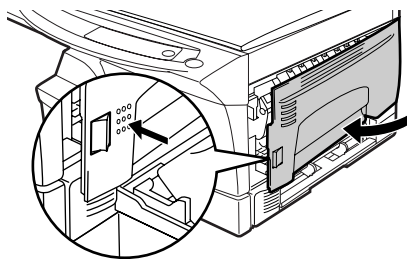











Note

Even after a new toner cartridge is installed, the start (  ) indicator may not light up, indicating copying cannot be restarted (toner is not sufficiently fed). In this case, open and close the side cover. The copier will feed toner again approximately 2 minutes and then copying can be restarted.

## TONER CARTRIDGE LIFE

To find out the approximate quantity of toner remaining, follow the procedure described below.

- 1** Press and hold down the light (  ) and dark (  ) keys simultaneously for more than 5 seconds until all the alarm indicators ( , , ,  ) blink and "  " appears in the display.
- 2** Press and hold down the copy ratio display (%) key for more than 5 seconds.  
The approximate quantity of toner remaining will be indicated in the display as a percentage ("100", "75", "50", "25" or "10" is displayed). When the percentage is less than 10%, (  ) will be displayed.
- 3** Press the light (  ) or dark (  ) key.  
All alarm indicators will go out.

## CLEANING THE UNIT

Proper care is essential in order to get clean, sharp copies. Be sure to take a few minutes to regularly clean the unit.



Warning

- Before cleaning, be sure to turn the power switch off and remove the power cord from the outlet.
- Do not use thinner, benzene or other volatile cleaning agents. Doing so may cause deformation, discoloration, deterioration or malfunction.

### Cabinet

Wipe the cabinet with a soft, clean cloth.

### Original table and the back side of the original cover and SPF (if installed)

Stains on the glass, scanning window, cover or SPF roller will also be copied. Wipe the glass, scanning window, cover or SPF roller with a soft, clean cloth. If necessary, dampen the cloth with a glass cleaner.

Original table/scanning window

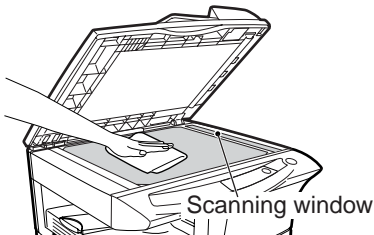

Original cover/SPF

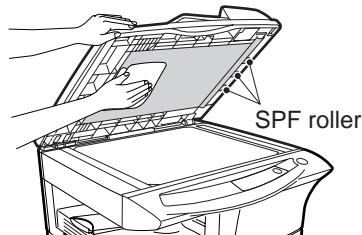

## Transfer charger

If copies start becoming streaky or blotchy, the transfer charger may be dirty. Clean the charger using the following procedure.

- 1 Turn the power switch off. (p.15)**
- 2 Open the side cover while pressing the side cover open button.**
- 3 Take the charger cleaner out by holding the tab. Set the charger cleaner onto the right end of the transfer charger, gently slide the cleaner to the left end, and then remove it. Repeat this operation two or three times.**



Note

*Slide the charger cleaner from the right end to the left end along the groove of the transfer charger. If the cleaner is stopped on the way, smudges on copies may occur.*

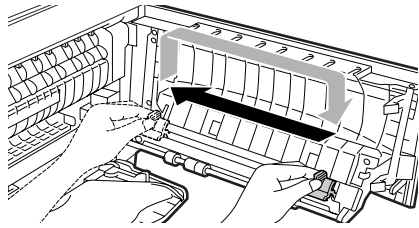
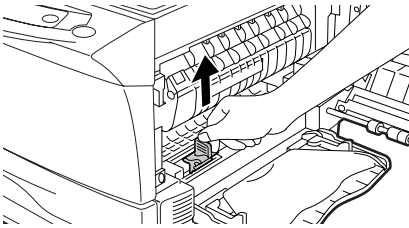

- 4 Return the charger cleaner to its original position. Close the side cover by pressing the round projections near the side cover open button.**

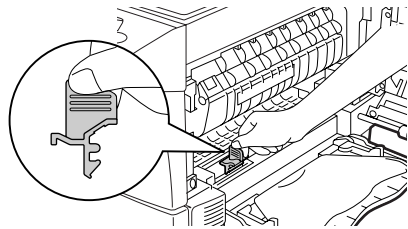

- 5 Turn the power switch on. (p.14)**

This chapter describes misfeed removal and troubleshooting.

## TROUBLESHOOTING

If any problem occurs, check the list below before contacting your authorised service representative.

Problem	Possible cause	Solution	Page
Unit does not operate.	Unit plugged in?	Plug the unit into a grounded outlet.	14
	Power switch on?	Turn the power switch on.	14
	Side cover closed securely?	Gently close the side cover.	26
	Front cover closed?	Gently close the front cover and then close the side cover.	26
Blank copies	Is the original placed face down on the original table or face up on the SPF?	Place the original face down on the original table or face up on the SPF.	16
Copies are too dark or too light.	Is original image too dark or too light?	Adjust the exposure manually.	18
	Is the unit in the automatic exposure mode?	Adjust the automatic exposure level.	19
	Is the unit in the photo exposure mode?	Cancel the photo exposure mode.	18
Dust, dirt, smudges appear on copies.	Original table or original cover dirty?	Clean regularly.	27
	Original smudged or blotchy?	Use a clean original.	–
Striped copies	Is transfer charger clean?	Clean the transfer charger.	28
Paper misfeeds frequently.	Non-standard paper used?	Use standard paper. If using special papers, feed the paper through the single bypass.	7
	Paper curled or damp?	Store paper flat in the wrapper in a dry location.	–
	Pieces of paper inside unit?	Remove all pieces of misfed paper.	31
	Paper guides in the paper tray not set properly?	Set the guides properly depending on the paper size.	8
	Too much paper in the paper tray or multi-bypass tray?	Remove excessive paper from the tray.	8
Images rub off the copy easily.	Is the paper too heavy?	Use paper within the specified range.	7
	Paper damp?	Replace with dry paper. If the unit is not used for long time, remove the paper from the paper tray and store it in its wrapper in a dry location.	2

# STATUS INDICATORS

When the following indicators light up or blink on the operation panel or the following alphanumeric codes appear in the display, solve the problem immediately referring to both the table below and the relevant page.



Note

*Be sure to use only genuine SHARP parts and supplies.*

Indication		Cause and remedy		Page
	Developer replacement required indicator	Steadily lit	Developer is required. contact your authorised service representative.	35
	Toner cartridge replacement required indicator	Steadily lit	Replacement of Toner cartridge will be needed soon. Prepare a new cartridge. (AR-152T)	24
		Blinking	Toner cartridge must be replaced. Replace it with a new one. (AR-152T)	24
	Misfeed indicator	Blinking	A misfeed has occurred. Remove the misfed paper referring to the description of "MISFEED REMOVAL".	31
			The lower side cover may be open. If so, close it.	34
	Maintenance indicator	Steadily lit	Service by an authorised SHARP service technician is required.	35
	SPF misfeed indicator	Blinking	An original misfeed has occurred in the SPF. Remove the misfed originals referring to the description of "E: Misfeed in the SPF (AR-153EN)".	34
	Power save indicator is steadily lit.		The unit is in the preheat mode. Press any key to cancel the preheat mode.	21
			The unit is in the auto power shut-off mode. Press the start (⊕) key to cancel the auto power shut-off mode.	21
	The paper tray indicator is blinking.		The paper tray is not installed properly. Push the tray into the unit securely.	-
	"CH" is blinking in the display.		The toner cartridge is not installed. Check if the cartridge is installed. If "CH" is blinking even if a cartridge is installed properly, contact your SHARP service centre immediately.	-
	"CH" is steadily lit in the display.		Side cover is open. Close the side cover securely by pressing the round projections near the side cover open button.	-
	"P" is blinking in the display.		The paper tray or multi-bypass tray is empty. Load paper.	8
			A misfeed has occurred in the paper tray, single bypass or multi-bypass tray. Remove the misfed paper.	31
			Paper tray is not securely installed. Push the tray in securely.	-
	A letter and a number appear alternately.		The scan head locking switch is locked. Unlock the scan head locking switch and turn the power switch off/on.	36
		The unit will not function. Turn the power switch off and then switch it on, and if there is again an error, remove the power cord from the outlet, and contact your authorized service representative.	-	



# MISFEED REMOVAL

When the misfeed ( ⚡ ) indicator blinks or  blinks in the display, the unit will stop because of a misfeed. If a misfeed occurs when using the SPF, a number may appear in the display after a minus sign. This indicates the number of the originals that must be returned to the original feeder tray after a misfeed. Return the required number of originals. Then this number will disappear when copying is resumed or the clear ( Ⓞ ) key is pressed. When the SPF misfeeds an original sheet, the unit will stop and the SPF misfeed ( < ) indicator will blink, while the misfeed ( ⚡ ) indicator will remain off. For a misfeed of originals in the SPF, see "E: Misfeed in the SPF (AR-153EN)" (p.34).



Note

*If the unit is turned on with the lower side cover open, the misfeed ( ⚡ ) indicator will blink. In this case, close the lower side cover. The misfeed ( ⚡ ) indicator will go out.*

## 1 Open the multi-bypass tray (AR-153EN), and side cover, in that order.

To open the multi-bypass tray, see "The multi-bypass tray (AR-153EN)" (p.10). To open the side cover, see "TONER CARTRIDGE REPLACEMENT" (p.24).

## 2 Check the misfeed location. Remove the misfed paper following the instructions for each location in the illustration below. If the misfeed ( ⚡ ) indicator blinks, proceed to "A: Misfeed in the paper feed area" (p.32).

### AR-153EN

If the misfed paper is seen from this side, proceed to "**C: Misfeed in the transport area**". (p.33)

If paper is misfed here, proceed to "**B: Misfeed in the fusing area**". (p.32)

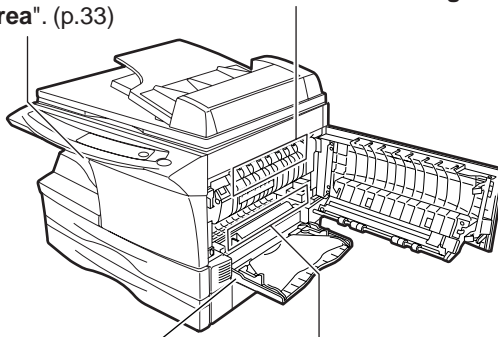

If paper is misfed here, proceed to "**D: Misfeed in the lower paper feed area**". (p.34)

If paper is misfed here, proceed to "**A: Misfeed in the paper feed area**". (p.32)

## A: Misfeed in the paper feed area

- 1** Gently remove the misfed paper from the paper feed area as shown in the illustration. When the misfeed (⊂∨) indicator blinks, and the misfed paper is not seen from the paper feed area, pull out the paper tray and remove the misfed paper. If the paper cannot be removed, proceed to "B: Misfeed in the fusing area".



*The fusing unit is hot. Do not touch the fusing unit when removing misfed paper. Doing so may cause a burn or other injury.*



*Do not touch the photoconductive drum (green portion) when removing the misfed paper. Doing so may cause smudges on copies.*

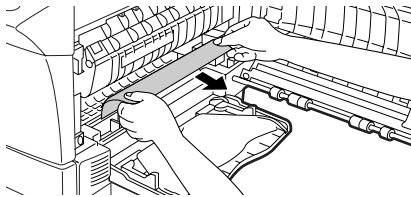

- 2** Close the side cover by pressing the round projections near the side cover open button. The misfeed (⊂∨) indicator will go out and the start (⊂⊃) indicator will light up.

## B: Misfeed in the fusing area

- 1** Lower the fusing unit release lever.

Fusing unit release lever

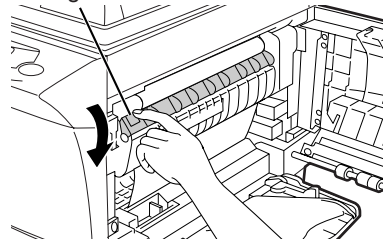

- 2 Gently remove the misfed paper from under the fusing unit as shown in the illustration. If the paper cannot be removed, proceed to "C: Misfeed in the transport area".**

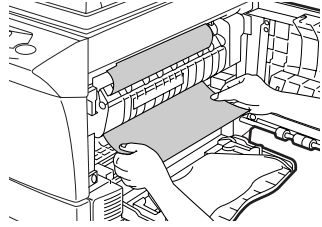

Warning

*The fusing unit is hot. Do not touch the fusing unit when removing misfed paper. Doing so may cause a burn or other injury.*



Caution

- *Do not touch the photoconductive drum (green portion) when removing the misfed paper. Doing so may cause smudges on copies.*
- *Do not remove the misfed paper from above the fusing unit. Unfixed toner on the paper may stain the paper transport area, resulting in smudges on copies.*

- 3 Raise the fusing unit release lever and then close the side cover by pressing the round projections near the side cover open button. The misfeed (⊗) indicator will go out and the start (⊕) indicator will light up.**

## C: Misfeed in the transport area

- 1 Lower the fusing unit release lever.**

See "B: Misfeed in the fusing area" (p.32).

- 2 Open the front cover.**

To open the front cover, see "TONER CARTRIDGE REPLACEMENT" (p.24).

- 3 Rotate the feeding roller in the direction of the arrow and gently remove the misfed paper from the exit area.**

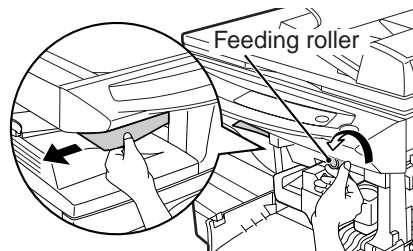

- 4 Raise the fusing unit release lever, close the front cover and then close the side cover by pressing the round projections near the side cover open button. The misfeed (⌘) indicator will go out and the start (⊕) indicator will light up.



Note

Raise the fusing unit release lever, close the front cover and then close the side cover by pressing the round projections near the side cover open button. The misfeed (⌘) indicator will go out and the start (⊕) indicator will light up.

## D: Misfeed in the lower paper feed area (AR-153EN)

- 1 Open the lower side cover (under the manual tray) and remove the misfed paper. If  blinks and the misfed paper is not seen from the area of the lower side cover, pull out the lower paper tray and remove the misfed paper. Then close the lower paper tray.

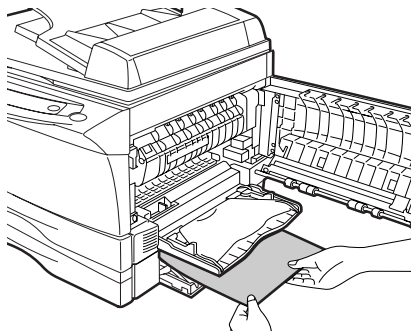

- 2 Close the lower side cover.

- 3 Close the side cover by pressing the round projections near the side cover open button. The misfeed (⌘) indicator will go out and the start (⊕) indicator will light up.

## E: Misfeed in the SPF (AR-153EN)

An original misfeed may occur at one of three locations: if the misfed original is seen from the original feeder tray, (A) in the original feeder tray; if the misfed original is not seen from the original feeder tray, (B) in the exit area or (C) under the feeding roller. Remove the misfed original following the instructions for each location.

- (A) Open the feeding roller cover and pull the original gently to the left and out from the original feeder tray. Close the feeding roller cover. Open and close the original cover to clear the SPF misfeed (◁) indicator. If the misfed original cannot be easily removed, proceed to (C).

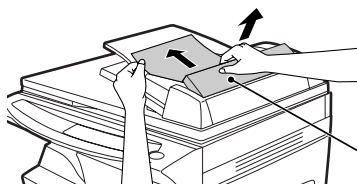

Feeding roller cover

**(B) Open the original cover and rotate the roller rotating knob to remove the misfed original from the exit area. If the misfed original cannot be easily removed, proceed to (C).**

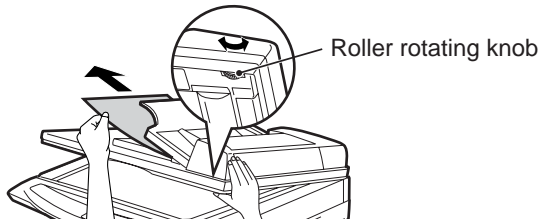

**(C) If the original does not move easily into the exit area, remove it in the direction of the arrow while rotating the knob.**

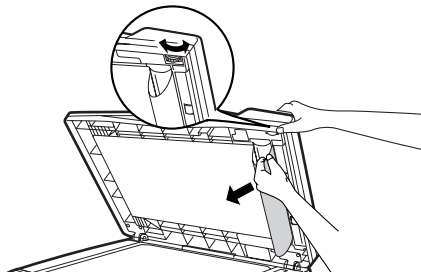

*A number may appear in the display after a minus sign, indicating the number of the originals that must be returned to the original feeder tray. Open and close the SPF to clear the SPF misfeed ( ◁ ) indicator and then clear the misfeed and return the required number of originals. Then press the start ( ⏻ ) key to resume copying.*

6



## DEVELOPER REQUIRED

When the developer replacement required ( ⚙️ ) indicator lights up, the developer should be replaced. DEVELOPER REPLACEMENT SHOULD ONLY BE DONE BY AN AUTHORIZED SHARP SERVICE TECHNICIAN. Contact your service centre as soon as possible.

## MAINTENANCE REQUIRED

When maintenance ( 🛠️ ) indicator lights up, service by an authorised SHARP service technician is required. Contact your service centre as soon as possible.

# SCAN HEAD LOCKING SWITCH

The scan head locking switch is under the original table. If the switch is locked (  ), the unit will not operate. Unlock the switch (  ) as shown below.

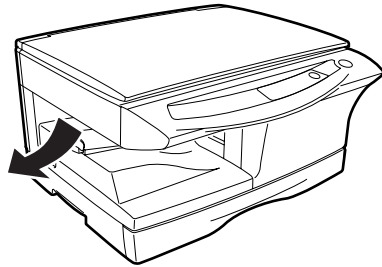
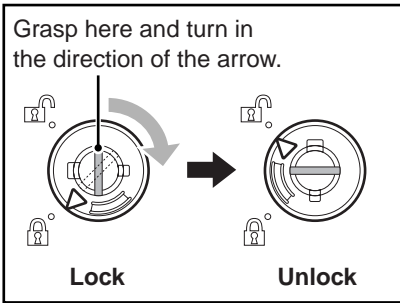

# 7 OPTIONAL EQUIPMENT (AL-12PKM)

The procedure for installing the software for the optional Printer/Scanner Expansion Kit (AL-12PKM) and the operation of the printer/scanner is explained here.

Information on how to use the online manual is also provided. For the procedure for installing the AL-12PKM, see the setup guide that accompanies the AL-12PKM. Illustrations of driver screens and other computer screens show the screens that appear in Windows XP Home Edition. Some of the names that appear in these illustrations may differ slightly from the screens that appear in other operating systems.

The following term is used in this chapter.

## CD-ROM

Means the supplied CD-ROM with the SHARP Personal MFP series software.



Note

*The screens shown in this manual are the screens that appear when "English (United Kingdom)" is selected for the language during installation. These screens may be slightly different than the screens that appear when "English (United States)" is selected.*

## SOFTWARE FOR THE SHARP PERSONAL MFP SERIES

The supplied CD-ROM includes software for this unit.

### MFP driver

#### Scanner driver

Permits you to operate scanning function of this unit with TWAIN-compliant and WIA-compliant application.

#### Printer driver

Enables you to use the printer function of this unit with your computer.

#### Print Status Window

The print state and information on current printing are displayed on the status monitor window.

### Sharpdesk

An integrated software environment that makes it easy to manage document and image files and launch applications.

### Button Manager

Button Manager enabling the SCANNER (Ⓢ) key located on the unit.



Note

*The scanning feature is only available with Windows 98/Me/2000/XP using a USB connection. For users running Windows 95/NT 4.0 or using a parallel connection, only printing is available.*

# HARDWARE AND SOFTWARE REQUIREMENTS

Check the following hardware and software requirements in order to install the software.

Computer type	IBM PC/AT or compatible computer equipped with a USB1.1* <sup>1</sup> or bi-directional parallel interface (IEEE 1284)
Operating system* <sup>2</sup>	Windows 95, Windows 98, Windows Me, Windows NT Workstation 4.0 (ServicePack 5 or later)* <sup>3</sup> , Windows 2000 Professional, Windows XP Professional* <sup>3</sup> , Windows XP Home Edition* <sup>3</sup>
Display	800 x 600dots (SVGA) display with 256 colours (or better)
Hard disk free space	150MB or more
Other requirement for hardware	An environment on which any of the operating systems listed above can fully operate

\*<sup>1</sup> Compatible with Windows 98, Windows Me, Windows 2000 Professional, Windows XP Professional or Windows XP Home Edition preinstalled model with USB interface equipped as standard.

\*<sup>2</sup> Printing is unavailable in MS-DOS mode.

\*<sup>3</sup> The administrator's authorisation is required to install this software using this installer.

## BEFORE INSTALLATION

The following table shows the drivers and software that can be installed for each version of Windows and interface connection method.

	MFP Driver		Button Manager	Sharpdesk
	Printer driver/ Print Status Window	Scanner driver		
Users of Windows 98/Me/2000/XP who will use the USB interface connection	Available* <sup>1</sup>	Available	Available	Available
Users of Windows 98/Me/2000/XP who will use the parallel interface connection		Not Available	Not Available	Available* <sup>2</sup>
Windows 95/NT 4.0 users				

\*<sup>1</sup> When the unit is connected through the parallel port, the Print Status Window can only be used when the parallel port is set to ECP mode. To set the parallel port mode, refer to your computer manual or ask the manufacturer of your computer.

\*<sup>2</sup> Sharpdesk can be installed when using a parallel interface connection, however, the unit's scanner function cannot be used.



Caution

*Is there another GDI printer driver or a Windows Printing System printer driver already installed? If installed, change the printer port setting. For the change of the printer port setting, see "USING OTHER INSTALLED DRIVERS" (p.63).*



## Flow of installation

Refer to the following table and then begin installation.

<b>Operating system</b>	<b>Interface</b>	<b>Reference pages for how to install</b>
Windows XP	USB/ Parallel	Installing onto Windows XP (USB/parallel interface) (p.40)
Windows 98	USB	Installing onto Windows 98/Me/2000 (USB interface) (p.44)
	Parallel	Installing onto Windows 95/98/Me/NT4.0/2000 (Parallel interface) (p.47)
Windows Me	USB	Installing onto Windows 98/Me/2000 (USB interface) (p.44)
	Parallel	Installing onto Windows 95/98/Me/NT4.0/2000 (Parallel interface) (p.47)
Windows 2000	USB	Installing onto Windows 98/Me/2000 (USB interface) (p.44)
	Parallel	Installing onto Windows 95/98/Me/NT4.0/2000 (Parallel interface) (p.47)
Windows 95/ NT 4.0	Parallel	Installing onto Windows 95/98/Me/NT4.0/2000 (Parallel interface) (p.47)

# INSTALLING THE SOFTWARE

The following term is used in this section.

## MFP

Means the unit as a printer and scanner.



Note

- For this description, it is assumed that the mouse is configured for right hand operation.
- To print or scan, the MFP must be in the online state.
- The scanner feature only works when using a USB interface cable.
- If any error message appears, solve the problem following the instructions on the screen. After your problem is solved, the installing procedure will be continued. Depending on your problem, you may have to exit the installer. In this case, click the "Cancel" button to exit the installer. After solving your problem, reinstall the software from the beginning.

## Installing onto Windows XP (USB/parallel interface)

Before starting the installation, make sure the USB or parallel interface cable is not connected to the MFP.

**1** Insert the supplied CD-ROM into your CD-ROM drive.

**2** Click the "start" button, click "My Computer" (  ), and then double-click the CD-ROM (  ) icon.



Note

When any of "Found New Hardware Wizard" messages appear during the software installation, be sure to click the "Cancel" button.

**3** Double-click the "setup" (  ) icon.



Note

If the language selection screen appears after you double click the "setup" icon, select the language you wish to use and click the "Next" button. (Normally, the correct language is selected automatically.)

**4** Select the software packages to be installed, and then click the "Next" button.

The software packages with checkmark (  ) on the list on the screen will be installed.

Click the "Display README" button to show the information on the selected package.

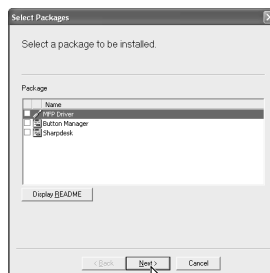



Note

- If you are using the parallel interface connection, do not select the Button Manager checkbox because this feature is not supported with the parallel interface.
- If the following screen appears, click the "OK" button. Review the contents in "BEFORE INSTALLATION" (p.38), and then select only appropriate the software packages to be installed.



## 5 Review the software packages to be installed on the screen, and then click the "Start" button.

The software packages to be installed will be displayed on the screen. If inappropriate packages are displayed, click the "Back" button to select appropriate packages again.



## 6 Copying files for MFP driver installation and parallel interface setup (This step will start if it was selected in step 4).

- 1 After confirming the message in the "Welcome" window, click the "Next" button.
- 2 A dialog box appears asking you to verify that the USB or parallel interface cable is not connected to the MFP. Make sure that the interface cable is not connected and click the "Next" button.
- 3 Click the "Next" button in the dialog box to install the MFP driver or Cancel to quit the installation.

The setup program will start to copy the files. If the following screen appears while the files are being copied (the message may appear more than once), click "Continue Anyway".



- 4 When the "The MFP driver installation is complete." dialog box appears, click the "OK" button.

The Button Manager installer will start.

7

## 7 Begin installation of the Button Manager (This step will start if it was selected in step 4).

- 1 After confirming the message in the "Welcome" window, click the "Next" button.
- 2 Read the message in the "Please read the following information." window, and then click the "Next" button.
- 3 When a message appears that lets you specify the location for the software to be installed, click the "Next" button.
- 4 If the program displays "Do you want the Button Manager added to Windows Startup?", check "Yes" and click the "OK" button.  
The setup program will start to copy the files.
- 5 Click the "Finish" button when the message informs you that setup is successful.  
The Sharpdesk installer will start.

## 8 Begin installation of the Sharpdesk (This step will start if it was selected in step 4).

- 1 After confirming the message in the "Welcome to Sharpdesk installation" window, click the "Next" button.
- 2 Read the message in the "Information" window, and then click the "Next" button.
- 3 When the "Choose Destination Location" window appears, click the "Next" button.
- 4 When the "Select Program Folder" window appears, click the "Next" button.  
The setup program will start to copy the files.
- 5 Click the "Finish" button when the message informs you that Setup is complete.

## 9 Click the "Close" button when the message informs you that "Setup has finished". When the "Now connect the MFP interface cable to the PC" dialog box appears, click the "OK" button.



Note

*After the installation, a message to restart your computer may be displayed. In this case, click the "Yes" button to restart your computer.*

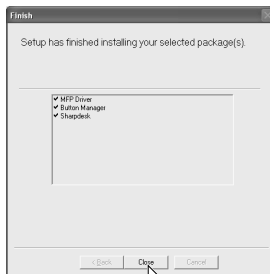

---

**10** Make sure that the power of the MFP is turned on, and then connect the USB interface cable or parallel interface cable. (p.64)

Windows will detect the MFP and the Plug and Play screen will appear. If you are using Windows XP with the parallel interface, go to step 12.

---

**11** Begin installation of the scanner driver.

- 1 "SHARP AR-xxxx" (where xxxx is the model name of your MFP) will appear in the "Found New Hardware Wizard" dialog box. Select "Install the software automatically (Recommended)" and click the "Next" button.
- 2 The "Install hardware" dialog box will appear. Click the "Continue Anyway" button.
- 3 When installation of the driver is completed, click the "Finish" button to finish the scanner driver installation.

---

**12** Begin installation of the printer driver.

- 1 "SHARP AR-xxxx" (where xxxx is the model name of your MFP) will appear in the "Found New Hardware Wizard" dialog box. Select "Install the software automatically (Recommended)" and click the "Next" button.
- 2 The "Hardware Installation" dialog box will appear. Click the "Continue Anyway" button.
- 3 When installation of the driver is completed, click the "Finish" button to finish the printer driver installation.

You have completed the installation of all the software.

## Installing onto Windows 98/Me/2000 (USB interface)

Before starting the installation, make sure the USB interface cable is not connected to the MFP.

**1** Insert the supplied CD-ROM into your CD-ROM drive.

**2** Double-click "My Computer" (🖥️), and then double-click the CD-ROM (💿) icon.



Note

*When any of "Hardware Found", or "Found New Hardware Wizard" messages appear during the software installation, be sure to click the "Cancel" button.*

**3** Double-click the "setup" (🔧) icon.



Note

*If the language selection screen appears after you double click the "setup" icon, select the language you wish to use and click the "Next" button. (Normally, the correct language is selected automatically.)*

**4** Select the software packages to be installed, and then click the "Next" button.

The software packages with checkmark (☑️) on the list on the screen will be installed. Click the "Display README" button to show the information on the selected package.

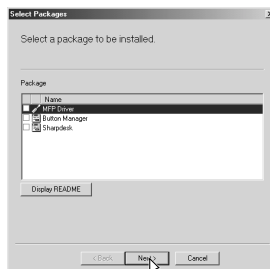

Note

*If the following screen appears, click the "OK" button. Review the contents in "BEFORE INSTALLATION" (p.38), and then select the appropriate driver software packages to be installed.*

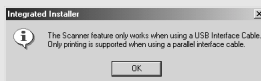

**5** Review the software packages to be installed on the screen, and then click the "Start" button.

The software packages to be installed will be displayed on the screen. If inappropriate packages are displayed, click the "Back" button to select appropriate packages again.

## 6 Copying files for MFP driver installation.

- 1 After confirming the message in the "Welcome" window, click the "Next" button.
- 2 A dialog box appears asking you to verify that the interface cable is not connected to the MFP. Make sure that the interface cable is not connected and click the "Next" button.
- 3 Click the "Next" button in the dialog box showing the files to be copied for installation of the MFP driver.

The setup program will start to copy the files. In Windows 2000, if the following screen appears while the files are being copied (the message may appear more than once), click "Yes" in Windows 2000.



- 4 The following screen appears when all of the files for the USB interface connection have been copied. If you are not using a parallel interface cable for connection to the MFP, please click the "No" button.



- 5 When the "The MFP driver installation is complete." dialog box appears, click the "OK" button. The Button Manager installer will start.

## 7 Begin installation of the Button Manager (This step will start if it was selected in step 4).

- 1 After confirming the message in the "Welcome" window, click the "Next" button.
- 2 Read the message in the "Please read the following information." window, and then click the "Next" button.
- 3 When a message appears that lets you specify the location for the software to be installed, click the "Next" button.
- 4 If the program displays "Do you want the Button Manager added to Windows Startup ?", check "Yes" and click the "OK" button.

The setup program will start to copy the files.

- 5 Click the "Finish" button when the message to inform you of the completion of the installation appears.

The Sharpdesk installer will start.

7

---

## 8 Begin installation of the Sharpdesk (This step will start if it was selected in step 4).

- 1 After confirming the message in the "Welcome to Sharpdesk installation" window, click the "Next" button.
- 2 Read the message in the "Information" window, and then click the "Next" button.
- 3 When the "Choose Destination Location" window appears, click the "Next" button.
- 4 When the "Select Program Folder" window appears, click the "Next" button.

The setup program will start to copy the files.

If the dialog box asking "This program is about to install Sharpdesk imaging, which does not support LZW compression." appears, answer the question to continue the Sharpdesk installation.



- 5 Click the "Finish" button when the message to inform you of the completion of the installation appears.

---

## 9 Click the "Close" button when the message to inform you of the completion of the installation appears. When the "Now connect the MFP interface cable to the PC." dialog box or "After Windows system restarts..." dialog box appears, click the "OK" button.



Note

*After the installation, a message to restart your computer may be displayed. In this case, click the "Yes" button to restart your computer.*

---

## 10 Make sure that the power of the MFP is turned on, and then connect the USB interface cable. (p.64)

Windows will detect the MFP and the Plug and Play screen will appear.

---

## 11 Follow the instructions in the Plug and Play screen that appears in your version of Windows to begin the installation. You have completed the installation of the software.



## Installing onto Windows 95/98/Me/NT4.0/2000 (Parallel interface)

Before starting the installation, make sure the USB or parallel interface cable is not connected to the MFP.

**1** Insert the supplied CD-ROM into your CD-ROM drive.

**2** Double-click "My Computer" (🖥️), and then double-click the CD-ROM (💿) icon.



Note

*When any of "Hardware Found", or "Found New Hardware Wizard" messages appear during the software installation, be sure to click the "Cancel" button.*

**3** Double-click the "setup" (🔧) icon.



Note

*If the language selection screen appears after you double click the "setup" icon, select the language you wish to use and click the "Next" button. (Normally, the correct language is selected automatically.)*

**4** Select the software packages to be installed, and then click the "Next" button.

The software packages with checkmark (☑️) on the list on the screen will be installed.

Click the "Display README" button to show the information on the selected package.

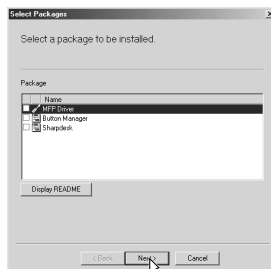

Note

*In Windows 95/NT 4.0, "Button Manager" does not appear. In Windows 98/Me/2000, do not select the "Button Manager" checkbox, because this is not supported when using the parallel interface.*

**5** The next screen appears. Make sure that the parallel interface cable is not connected, and click "OK".

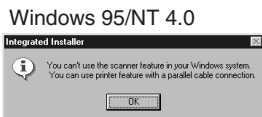

**6** Check the contents of the package on the screen, and then click the "Start" button.

The software packages to be installed will be displayed on the screen. If inappropriate packages are displayed, click the "Back" button to select only appropriate software packages.

7

## 7 Copying files for MFP driver installation and parallel interface setup (This step will start if it was selected in step 4).

- 1 After confirming the message in the "Welcome" window, click the "Next" button.
- 2 A dialog box appears asking you to verify that the USB or parallel interface cable is not connected to the MFP. Make sure that the interface cable is not connected and click the "Next" button.
- 3 Click the "Next" button in the dialog box to install the MFP driver or Cancel to quit the installation.

The setup program will start to copy the files. In Windows 2000, if the following screen appears while the files are being copied (the message may appear more than once), click "Yes" in Windows 2000.



- 4 The following screen appears. Click the "Yes" button, and then the Model screen will appear. Select the model number that is the same as the model name of your MFP and click the "Next" button. Be sure to select the displayed model number that is the same as the MFP's model name. If they are not the same, the driver will not be installed correctly.

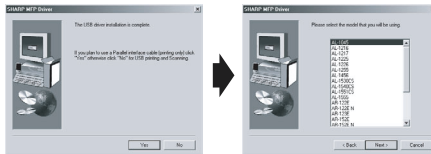

- 5 Establish the printer settings and click the "Next" button.

Select "LPT1" for the port to be used. If "LPT1" does not appear, it is likely that another printer or peripheral device is using "LPT1". Check your other printers and peripheral devices, and change the port setting as needed so no device is using "LPT1". If you wish the MFP to be your default printer, select "Yes". If not, select "No".



- 6 When the "Setup has completed gathering all necessary installation information" dialog box appears, click the "Yes" button. The parallel interface driver is installed.
- 7 When the "The MFP driver installation is complete." dialog box appears, click the "OK" button. The Sharpdesk installer will start.

## 8 Begin installation of the Sharpdesk (This step will start if it was selected in step 4).

- 1 After confirming the message in the "Welcome to Sharpdesk installation" window, click the "Next" button.
- 2 Read the message in the "Information" window, and then click the "Next" button.
- 3 When the "Choose Destination Location" window appears, click the "Next" button.
- 4 When the "Select Program Folder" window appears, click the "Next" button.

The setup program will start to copy the files.

If the dialog box asking "This program is about to install Sharpdesk imaging, which does not support LZW compression." appears, answer the question to continue the Sharpdesk installation.

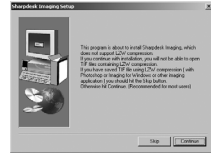

- 5 Click the "Finish" button when the message to inform you of the completion of the installation appears.

## 9 Click the "Close" button when the message to inform you of the completion of the installation appears. When the "Now connect the MFP interface cable to the PC." dialog box or "After Windows system restarts..." dialog box appears, click the "OK" button.



Note

*After the installation, a message to restart your computer may be displayed. In this case, click the "Yes" button to restart your computer.*

## 10 Make sure that the power of the MFP is turned on, and then connect the USB interface cable or parallel interface cable.

You have completed the installation of all the software.

7

## INDICATORS ON THE OPERATION PANEL

The ONLINE indicator and the start (  ) indicator indicate the state of the printer or scanner.

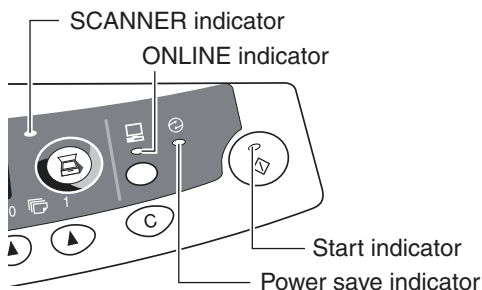

### Start indicator

**On:** Indicates the unit is ready for copying or scanning is being performed.

**Blinking:** The indicator blinks in the following situations:

- When a print job is interrupted.
- When a copy job is stored.
- When toner is being replenished during a copy or print job.

**Off:** The indicator is off in the following situations:

- During copying or scanning.
- The unit is in the auto power shut-off mode.
- When a misfeed or error has occurred.

### ONLINE indicator

The ONLINE key is pressed and on line and off line are changed.

**On:** Indicates the unit is ready for printing or scanning is being performed. (On line)

**Blinking:** Printing or data is being received from a computer.

**Off:** Copying is being performed. (Off line)

### Power save indicator

**On:** Indicates the unit is in a power save mode.

**Blinking:** Indicates that the unit is initialising (when the side cover is opened and closed or the power turned off and on.)

### Scanner indicator

**On:** The SCANNER (  ) key has been pressed and the unit is in scanner mode.

**Blinking:** A scan job is being executed from the computer, or scan data is stored in the unit's memory.

**Off:** The unit is in the copy mode.

# USING THE PRINTER MODE



*For problems with the printer function, see the online manual or the help file for the driver.*

## Opening the printer driver from the start menu

Open the printer driver setup screen by the method shown below.

**1** Click the "start" button.

**2** Click "Control Panel", select "Printers and Other Hardware", and then click "Printers and Faxes".

On Windows 95/98/Me/NT4.0/2000, select "Settings" and click "Printers".

**3** Click the "SHARP AR-xxxx" (where xxxx is the model name of your unit) printer driver icon and from the "File" menu select "Properties".



*On windows NT 4.0, select "Document Defaults" to open the printer driver setup screen.*

**4** Click "Printing Preferences" button in the "General" tab.

On Windows 95/98/Me, click the "Setup" tab.

The printer driver setup screen will appear.



*Refer to the Windows manual or help file for more information on the "General" tab, "Details" tab, "Color Management" tab and "Sharing" tab.*

## How to print

**1** Make sure that the paper of the desired size and type is loaded in the tray.

The procedure for loading paper is the same as for loading copy paper. See "LOADING PAPER" (p.7).



*When printing from the single bypass, configure the settings in the printer driver first, execute printing, and then load the paper.*

**2** Open the document you intend to print, and select "Print" from the application's "File" menu.

**3** Make sure that "SHARP AR-xxxx" (where xxxx is the model name of your unit) is selected as the current printer. If you intend to change any print setting, click the "Preferences" button to open the setting dialog.

On Windows 95/98/Me/NT 4.0, click the "Properties" button.

On Windows 2000, the "Properties" button does not appear. Set your preferences by switching the tab in the "Print" dialog box.

7

## 4

### Specify the print settings including the number of copies, media type, and print quality, and then click the "Print" button to start printing.

On Windows 95/98/Me/NT 4.0, click the "OK" button to start printing. For details on print settings, see the online manual or the help file for the printer driver.

#### When using the single bypass

After  appears in the display, wait until the Paper feed location indicator for the single bypass illuminates and insert the paper. The machine will automatically draw in the paper and begin printing.



Note

- *If copying is being performed when printing is started, copying will continue. After copying is complete, printing will be executed when the clear (C) key is pressed twice, the ONLINE key is pressed to switch the unit to the online state or approximately 60 seconds (auto clear time)\* elapse.*
  - \* *The auto clear time varies with a user program setting. See "USER PROGRAMS" (p.22).*
- *Preheat mode and auto power shut-off mode will be cancelled when printing is started.*
- *If the paper size specified from the software application is larger than the paper size in the printer, part of the image that is not transferred to the paper may remain on the surface of the drum. In this case, the backside of the paper may become dirty. If this occurs, change to the correct size paper and print two or three pages to clean the image.*
- *If you start a print job while a scan job is in progress, the print data will be stored in the unit's memory. When the scan job is completed, printing will begin.*

#### About interrupt copying

If you press the start (S) key to begin a copy job while a print job using the paper tray is in progress, the copy job will begin automatically after the print data in the unit's memory is printed (interrupt copying). When this is done, the print data remaining in the computer is not sent to the unit. When the copy job ends, press the clear (C) key twice, or press the ONLINE key once to change the unit to the online state (p.50), or wait until the set auto clear time (p.21) elapses. The remaining print data will be sent to the unit and printing will resume. Interrupt copying is not possible during a print job using the single bypass.

# USING THE SCANNER MODE



For problems with the scanner function, see the online manual or the help file for the driver.

## Using the Button Manager

### Setting up the Button Manager

The scanner driver for this unit includes an STI (Still image) driver and WIA (Windows Image Acquisition) driver. You can install software that supports the STI driver and WIA driver to enable scanning using the operation panel of the unit. The Button Manager accessory software supports the STI driver and WIA driver. Setup that is required in Windows to use the Button Manager is explained in the following.

### Windows XP

**1** Click the "start" button, select "Control Panel" and click "Printers and Other Hardware", and then click "Scanners and Cameras" in the start menu. Right click the "SHARP AR-xxxx" (where xxxx is the model name of your unit) icon and click "Properties" in the menu that appears.

**2** In the "Properties" screen, click the "Events" tab.

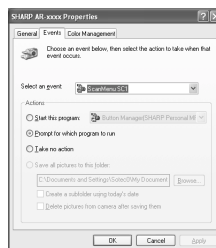

**3** Click the "Select an event" button and select "ScanMenu SC1" from the pull-down menu. Select "Button Manager (SHARP Personal MFP series)" in "Start this program" and click "Apply".

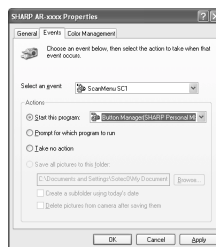

**4** Repeat Step3 to set "ScanMenu SC2" through "ScanMenu SC6". Click the "Select an event" button and select "ScanMenu SC2" from the pull-down menu. Select "Button Manager (SHARP Personal MFP series)" in "Start this program" and click "Apply". Do the same for each ScanMenu through "ScanMenu SC6".

When the settings have been completed, click the "OK" button to close the screen. When the settings have been completed in Windows, start the Button Manager. Adjust detailed settings and then scan an image from the unit. For the procedures for starting Button Manager and adjusting settings, see "Scan Parameter Setting Dialog Box" (p.55).



## Windows 98/Me/2000

To scan directly into an application using the Button Manager on Windows 98, Windows Me and Windows 2000. Set the Event Manager properties to send only to Button Manager as shown below.

- 1 Click the "Start" button, select "Control Panel" from "Settings", and open "Scanners and Cameras" in start menu.**



Note

*In Windows Me, it occasionally happens that the "Scanners and Cameras" icon does not appear immediately after installation of the MFP driver is completed. If the icon does not appear, click "View all Control Panel options" in the Control Panel and display the "Scanner and Cameras" icon.*

- 2 Select "AR-xxxx" (where "xxxx" is the model name of your unit), and click the "Properties" button.**

In Windows Me, right click "AR-xxxx" (where "xxxx" is model name of your unit) and click "Properties" in the menu that appears.

- 3 In the "Properties" screen, click the "Events" tab.**

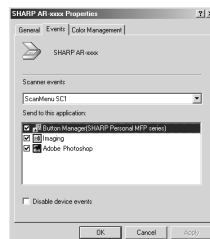

- 4 Click the "Scanner events" button and select "ScanMenu SC1" from the pull-down menu. Select "Button Manager (SHARP Personal MFP series)" in "Send to this application" and click "Apply".**



Note

*If other application are shown, deselect the checkboxes for the other applications and leave only the Button Manager checkbox selected.*

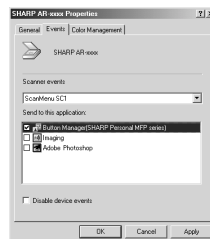

- 5 Repeat Step4 to set "ScanMenu SC2" through "ScanMenu SC6".**

Click the "Scanner events" and select "ScanMenu SC2" from the pull-down menu. Select "Button Manager (SHARP Personal MFP series)" in "Start this program" and click "Apply". Do the same for each ScanMenu through "ScanMenu SC6".

When the settings have been completed, click the "OK" button to close the screen. When the settings have been completed in Windows, start the Button Manager. Adjust detailed settings and then scan an image from the unit. For the procedures for starting Button Manager and adjusting settings, see "Scan Parameter Setting Dialog Box" (Next page).



## Scan Parameter Setting Dialog Box

After you have completed the Button Manager settings in Windows, configure the scan settings in Button Manager. To configure the scan settings in Button Manager, right click the (  ) icon in the Taskbar and select "Setting" from the menu that appears.

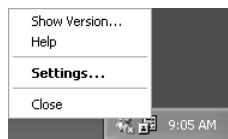

For details on configuring the scan settings in Button Manager, see the online manual or the help file.

This is the corresponding setting in the Button Manager to automatically send multiple images in full colour at 75 dpi to Sharpdesk using the operation panel "SC1" SCANNER (  ) key selection.

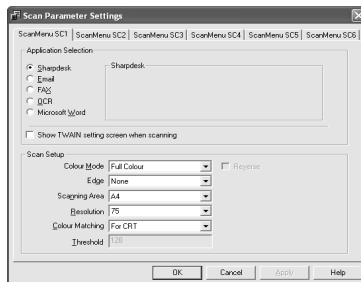

Note

*This dialog shows the SC1 event set to go directly to Button Manager. With the Button Manager set to send the image to Sharpdesk. (factory default setting) Sharpdesk will open after acquiring the image automatically.*

## Flow of the Button Manager setting

The Button Manager can directly handle a AR-xxxx (where xxxx is the model name of your unit) series device event and start your selected application according to the scan setting made on the AR-xxxx (where xxxx is the model name of your unit) operation panel (SC1, SC2, SC3, SC4, SC5, SC6).

This will scan directly into your application from the device.

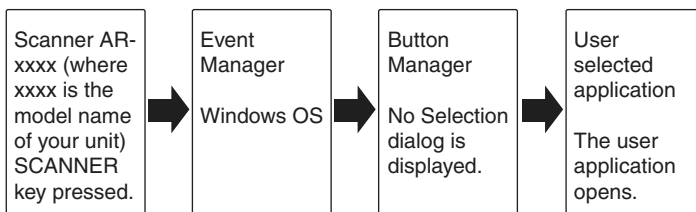

The settings for the Windows Event Manager for the SHARP AR-xxxx (where xxxx is the model name of your unit) device allow the user to take advantage of the Sharp Button Manager to take the control of the events from Windows and send scanned images to any application that can be selected in Button Manager.

This can be done with the Windows OS showing the Event Manager selection dialog or directly into a selected application if the Button Manager is the only allowed handler for device events from the SHARP AR-xxxx (where xxxx is the model name of your unit).

This is done by changing the Windows device settings for the AR-xxxx (where xxxx is the model name of your unit) in the Scanner and Camera device settings in the Control Panel.

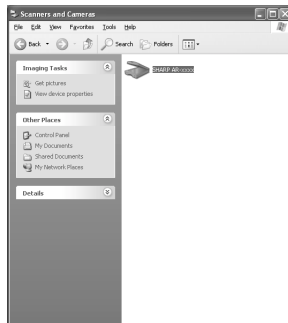

This is the Control Panel Properties dialog for "Scanners and Cameras".

### All About The Windows Event Manager and scanner events in Windows 98, Windows Me, Windows 2000 and Windows XP.

Windows Platforms provide a mechanism for software to handle external events for a scanner device like the SHARP AR-xxxx (where xxxx is the model name of your unit) series products. This mechanism is controlled by the device manager on a device basis. Applications that can handle events from a scanner/camera device register with the Windows Event Manager and shown as available in the registered applications. The path an event takes to get to the user's selected application depends upon the event settings for the device.

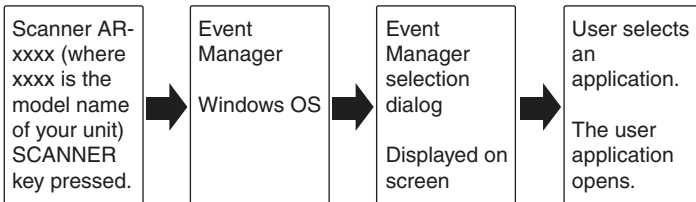

This is the Windows Event Manager Selection Dialog. Shown are two applications registered to handle the scanner event from the AR-xxxx (where xxxx is the model name of your unit) device.

## Using the SCANNER key to begin scanning



Note

- Scanning is not possible during a copy job.
- If the SCANNER (  ) key is pressed during a print job, the scan job will be stored.
- When placing an original that has been placed in the SPF, only one original can be placed unless you are using Sharpdesk.

### 1 Press the SCANNER ( ) key.

The unit enters scan mode.

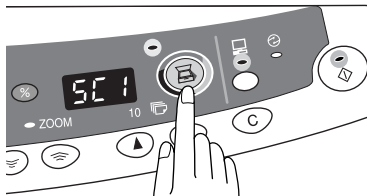

### 2 Place the original you wish to scan on the original table/SPF.

For the procedure for placing the original, see "ORIGINAL PLACEMENT" (p.16).

### 3 Press the right copy quantity key to display the number of the application that you wish to use for scanning.

The application numbers are initially as follows.

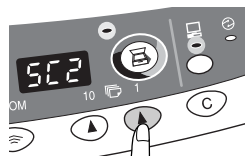

Application number	Application launched
SC1	Sharpdesk (Full color) (if installed)
SC2	Sharpdesk (Monochrome) (if installed)
SC3	E-mail (your standard e-mail program in the Windows OS you are using)
SC4	Fax (if a fax program is installed)
SC5	OCR (if an OCR program is installed)
SC6	Microsoft Word (if installed)

To check the settings, see "Scan Parameter Setting Dialog Box" (p.55) and then open the settings window of the Button Manager.

## 4 Press the start ( ) key.

The selected application launches and scanning begins.



Note

- If the following screen appears, select **Button Manager** and click "OK". **Button Manager** starts and the application associated with **Button Manager** starts. If you want only **Button Manager** to start in this case, set up **Button Manager** for use in **Windows** as explained in "Setting up the **Button Manager**" (p.53).
- If step 4 is performed with the "Show TWAIN setting screen when scanning" checkbox selected in the **Scan Parameter Setting Dialog Box** (p.55), the TWAIN settings screen will automatically appear. Check the settings, and then press the start (  ) key again or click the "Scan" button in the TWAIN setting screen to start scanning. The scanned data will be transferred to the application.



## Opening the scanner driver and scanning from your computer

Follow the steps below to open the scanner driver setup screen. As an example, this instruction is given using Sharpdesk as an image capture application.



Note

- Scanning is not possible during a copy and print job.
- The method for starting the scanner driver differs depending on the type of application. Refer to the manual or the help file of your application.
- When using the scanner driver to scan an original that has been placed in the SPF. If you perform a pre-scan (see the online manual or the help file for the scanner driver), the original in the SPF will be output to the exit area after scanning. To scan the original after the pre-scan, place the original in the SPF once again.

## Using the SHARP TWAIN

### 1 Place the original you wish to scan on the original table/SPF.

For the procedure for placing the original, see "ORIGINAL PLACEMENT" (p.16).

### 2 After starting Sharpdesk, click the "File" menu and select "Select Scanner".

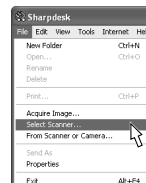

Click here

- 3** Select "SHARP Personal MFP series", and click the "Select" button.



Note

*If you use more than one scanning device, select the scanner you want to use through the application. The method for accessing the "Select Scanner" option, depends upon the application. For more information, see the online manual or the help file of your application.*

- 4** Select "Acquire Image" from the "File" menu, or click the "Acquire" button (  ).

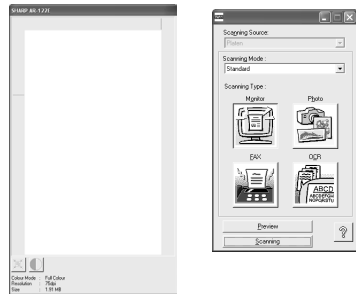

- 5** Set the configuration for scanning (refer to the online manual and help file), and click the "Scan" button.  
Scan is started.

7

## Scanning with the "Scanner and Camera Wizard" in Windows XP

Windows XP includes as a standard feature an image scanning function. The procedure for scanning with the "Scanner and Camera Wizard" is explained here.



Note

To cancel scanning, click the "Cancel" button in the screen that is displayed.

### 1 Place the original you wish to scan on the original table/SPF.

For the procedure for placing the original, see "ORIGINAL PLACEMENT" (p.16).

### 2 Click the "start" button , select "Control Panel", and click "Printers and Other Hardware", and then click "Scanners and Cameras" in the start menu. Click the "SHARP AR-xxxx" (where xxxx is the model name of your unit) icon and click "Get picture" in "Imaging Tasks".

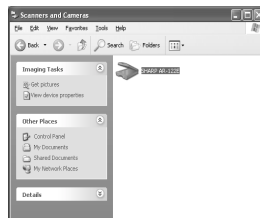

### 3 The "Scanner and Camera Wizard" appears. Click "Next" and establish the basic settings for scanning.

For information on the settings, see the Windows XP help file. After completing each setting, click "Next".

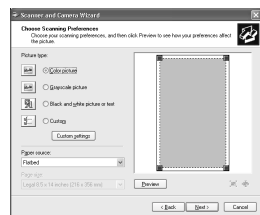

### 4 Select a name, format, and folder for the scanned image.

For information on the image name, file format, and folder, see the Windows XP help file.

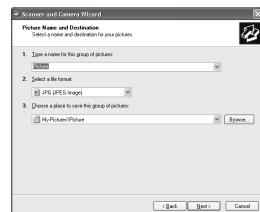

### 5 Scanning begins. When scanning ends, select the next task you wish to perform.

For information on each selection, see the Windows XP help file. To quit the "Scanner and Camera Wizard", select "Nothing. I'm finished working with these pictures." and click "Next".

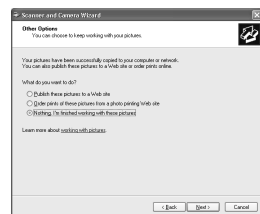

### 6 Click "Finish" in the screen that appears.

The "Scanner and Camera Wizard" closes and the scanned image is saved.

# HOW TO USE THE ONLINE MANUAL

The online manual provides detailed instructions for operating the unit as the printer or scanner and a list of methods for dealing with printing or scanner problems. To access the online manual, your computer must have Acrobat Reader 5.0 or a later version. If it is not installed, refer to "Installing Acrobat Reader" (Next page).

## Contents of the online manual

The contents of the online manual are as follows. Check the online manual when you use this unit after all the initial setup is completed.

### How to use the online manual

Explains how to use the online manual.

### Print

Provides information on how to print a document.

### Scan

Explains how to scan using the scanner driver and how to adjust the settings for the Button Manager.

### Troubleshooting

Provides instructions on how to solve driver or software problems.

---



**1** Turn on your computer.

---

**2** Insert the supplied CD-ROM into your CD-ROM drive.

---

**3** Click the "start" button, click "My Computer" (  ), and then double-click the CD-ROM (  ) icon.

On Windows 95/98/Me/NT 4.0/2000, double-click "My Computer" (  ), and then double-click the CD-ROM (  ) icon.

---

**4** Double-click the "Manual" folder, double-click "English" folder, and then double-click the "AR\_153EN\_152EN\_122EN.pdf" icon.

The following window will appear.

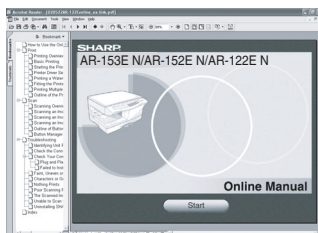

7

---

## 5 Click the to read the online manual.

To close the online manual, click the (✕) button located at the top-right of the window.



- *The online manual can be printed out using Acrobat Reader. SHARP recommends printing out the sections which you refer to regularly.*
- *Refer to "Help" of Acrobat Reader for more details on the operation and function of Acrobat Reader.*



## Installing Acrobat Reader

---

### 1 Turn on your computer.

### 2 Insert the CD-ROM into the CD-ROM drive.

### 3 Click the "start" button, click "My Computer" () , and then double-click the CD-ROM () icon.

Windows95/98/Me/NT4.0/2000, double-click "My Computer" () , and then double-click the CD-ROM () icon.

### 4 Double-click the "Acrobat" folder, and then double-click the "ar500enu.exe" icon.

Follow the on-screen instructions to install Acrobat Reader.



## USING OTHER INSTALLED DRIVERS

If you use another GDI printer or a Windows Printing System printer, interference between printers may occur and printing may not be performed properly. To use another GDI printer or a Windows Printing System printer, you must change the port setting of the printer driver using the following procedure.



Note

*If another printer does not operate properly when the SHARP Personal MFP series printer driver is set to "FILE" as described below, uninstall the SHARP Personal MFP series printer driver. To uninstall the printer driver, see the online manual.*

- 1** Click the "start" button.
- 2** Click "Control Panel", click "Printer and Other Hardware" and then click "Printer and Faxes".  
On Windows 95/98/Me/NT4.0/2000, select "Settings" and then click "Printers".
- 3** Right-click the "SHARP AR-xxxx" (where xxxx is the model name of your unit) icon in the printer dialog box and then click "Properties".



- 4** Click the "Port" tab ("Details" tab - on Windows 95/98/Me) in the "Properties" dialog box, select "FILE": in the "Print to the following port" list box, and click the "OK".
- 5** Right-click the icon of the printer to be used and click "Properties".
- 6** Click the "Port" tab ("Details" tab - on Windows 95/98/Me) in the "Properties" window, select "LPT1" (or the currently used port), and click the "OK" button.



Note

*To use the SHARP Personal MFP series again, perform the same procedure but select the port to be used (for example, LPT1) in step 4.*

7

# CONNECTING THE INTERFACE CABLE

This unit includes both USB and parallel interface connectors. Interface cables for connecting the unit to your computer are not included with this unit. Please purchase the appropriate cable for your computer.

## Interface cable

### Parallel interface cable

IEEE 1284-Shielded type bi-directional parallel interface cable (2 m Max.)

### USB interface cable

Shielded twisted pair cable, high-speed transmission equivalent (2 m Max.)



Caution

- *If you intend to use the unit as a scanner, it must be connected to your computer with a USB interface cable. The scanner function cannot be used if the unit is connected with a parallel cable.*
- *USB is available with a PC/AT compatible computer that was originally equipped with USB and had Windows 98, Windows Me, Windows 2000 Professional, Windows XP Professional or Windows XP Home Edition preinstalled.*
- *Do not connect the interface cable before installing the MFP driver. The interface cable should be connected during installation of the MFP driver. (p.43)*

## Connecting the USB interface cable

**1** Obtain a shielded USB interface cable.

**2** Insert the cable into the USB interface connector located on the rear of the unit.

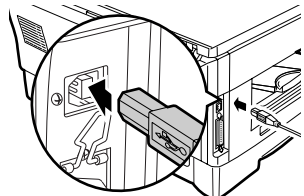

**3** Insert the other end of the cable into the interface connector of your computer, or the USB hub connected to your computer.

---

## Connecting the parallel interface cable

---

**1** Obtain an IEEE1284 shielded parallel interface cable.

---

**2** Ensure that your computer and unit are turned off.

---

**3** Insert the cable into the parallel interface connector located on the rear of the unit, and fasten with clasps.

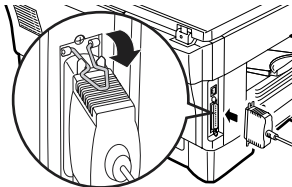

---

**4** Insert the other end of the cable into the interface connector of your computer.

## SYSTEM CONFIGURATION

A number of options are available for the unit which allow you to configure a system to meet your particular needs. The options include the following.

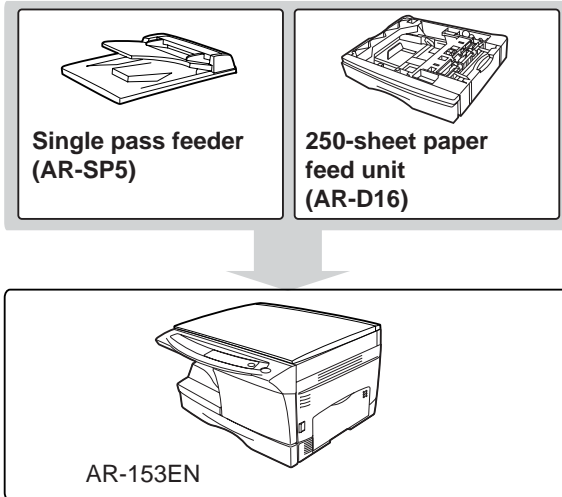

## SINGLE PASS FEEDER (AR-SP5)

The single pass feeder (SPF) holds up to 30 originals for automatic feeding.

The procedures for placing originals in the SPF, cleaning the SPF, and removing a misfeed are explained in the following sections. See "Using the SPF" (p.17), "CLEANING THE UNIT" (p.27) and "E: Misfeed in the SPF (AR-153EN)" (p.34).

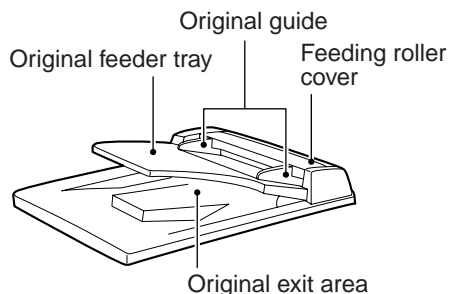

## 250-SHEET PAPER FEED UNIT (AR-D16)

The paper feed unit provide the convenience of increased paper capacity for the unit and a greater choice of paper size readily available for copying.

The procedures for loading paper in the paper tray of paper feed unit, changing the paper size, and selecting the paper tray are same as for the paper tray in the unit. See "LOADING THE PAPER TRAY" (p.8) and "Selecting the tray" (p.20).

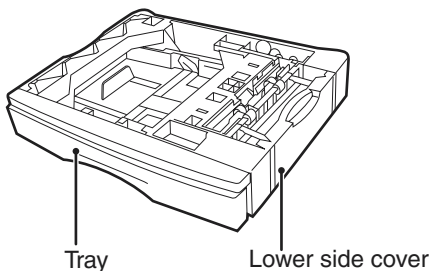

### Using the paper feed unit with the printer function (when the AL-12PKM is installed)

When the printer/scanner expansion kit is installed on the unit, the AR-D16 can also be used with the printer function. To use the AR-D16 with the printer function, follow these steps to adjust the settings in the printer driver.



Note

*The printer driver cannot be set for use with the AR-D16 when opened from the application.*

- 1 Click the "start" button.**
- 2 Click "Control Panel", select "Printer and Other Hardware", and then click "Printer and Faxes".**  
On Windows 95/98/Me/NT 4.0/2000, select "Setting" and click "Printers".
- 3 Click the "SHARP AR-153EN" printer driver icon and from the "File" menu select "Properties".**  
On Windows 95/98/Me, click the "SHARP AR-153EN" printer driver icon, select "Properties" from the "File" menu, and then click the "Setup" tab.
- 4 Click the "Utility" tab.**
- 5 Select "Two trays" for "Input tray option", and click "OK".**  
The printer driver closes. This completes the settings needed to use the AR-D16.

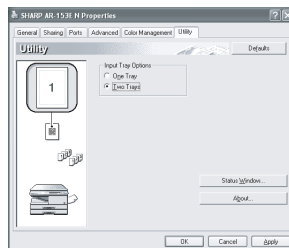

## SPECIFICATIONS

Model		AR-153EN	AR-152EN	AR-122EN
Type		Digital laser copier, desk-top type		
Copy system		Dry, electrostatic transfer		
Originals		Sheets, bound documents		
Paper tray		250 sheets		
Single bypass		/	1 sheet	
Multi-bypass tray		50 sheets	/	
Paper output tray		100 sheets		
Original sizes		Max. A4		
Original feed	Original table	1 sheet		
	SPF	Up to 30 sheets	/	
Copy size		A6 to A4 * <sup>1</sup>		
Image loss		Max. 4mm * <sup>2</sup> Max. 4.5mm * <sup>3</sup>		
Copy speed		15 pages/min.	12 pages/min.	
Continuous copying		Max. 99 pages subtractive counter		
First-copy time (Approximately)		9.6 seconds (paper:A4, exposure mode:AUTO, copy ratio:100% )		
Copy ratio		Variable:25% to 400% in 1% increments (total 376 steps) Fixed: 25%, 70% 86%, 100%, 141%, 400%		
Exposure system		Moving optical source, slit exposure (stationary platen) with automatic exposure		
Fusing system		Heat rollers		
Development system		Magnetic brush development		
Light source		Cold cathode fluorescent lamp		
Resolution		600 x 300dpi (Auto/Manual mode) 600 x 600dpi (Photo mode)		
Gradation		2 levels		
Bit depth		1 bit or 8 bit/pixel		
Sensor		Colour CCD		
Memory		8 MB		
Power supply		Local voltage $\pm 10\%$ (For this copier power supply, see the name plate located on the back of the unit)		
Power consumption		1000 W		
Overall dimensions	Width	809mm	607.6mm	
	Depth	492.5mm	462.5mm	
Weight (Approximately) * <sup>4</sup>		16kg		

Model		AR-153EN	AR-152EN	AR-122EN
Unit dimensions	Width	518mm		
	Depth	492.5mm	462.5mm	
	Height	295.6mm		
Operating conditions		Temperature: 10°C to 30°C Humidity: 20% to 85%		
Noise level		Sound Power Level L <sub>WA</sub> (1B=10dB) Copying: 6.0 [B], Standby: 3.7 [B] Sound Pressure Level L <sub>pA</sub> (bystander positions) Copying: 46 [dB (A)], Standby: 23 [dB (A)] Noise emission measurement in accordance with ISO 7779.		
Emission concentration (measurement according to RAL-UZ 62)		Ozone: less than 0.02 mg/m <sup>3</sup> Dust: less than 0.075 mg/m <sup>3</sup> Styrene: less than 0.07 mg/m <sup>3</sup>		
Optional equipment		Printer/Scanner Expansion Kit (AL-12PKM)		
		250-sheet paper feed unit (AR-D16)	/	
		Single Pass Feeder (AR-SP5)	/	

\*1 Feed paper lengthwise only.

\*2 Leading and trailing edges.

\*3 Along the other edges in totals.

\*4 Not including toner and drum cartridges.

## Optional equipment

### Printer/Scanner Expansion Kit (AL-12PKM)

Printing system		Dry, electrostatic transfer
Printing size		A6 to A4 *1
Print speed		Max. 12 pages/min. (A4)
Continuous printing		Max. 99 pages subtractive counter
First-print time (Approximately)		9.6 seconds (Paper: A4) *2
Resolution	Printer	600 dpi
	Scanner	600 x 1200 dpi
Emulation		SHARP GDI
Page orientation		Portrait or landscape
Interface port		USB interface (USB1.1 Standard) / IEEE1284-compliant bi-directional parallel interface (Only for printer)

\*1 Feed paper lengthwise only.

\*2 Data transmission time is not included.

## Single pass feeder (AR-SP5)

Acceptable originals	Weight: 52g/m <sup>2</sup> to 90g/m <sup>2</sup> Size: A5 to A4 Capacity: Up to 30 sheets
Power supply	Drawn from the unit.
Weight	Approx. 3kg
Dimensions	498mm (W) x 380mm (D) x 110mm (H)

## 250-sheet paper feed unit (AR-D16)

Paper size	A5 to A4
Paper weight	56g/m <sup>2</sup> to 80g/m <sup>2</sup>
Paper capacity	One paper tray with capacity for 250 sheets of 80g/m <sup>2</sup> bond paper
Weight	3kg
Dimensions	498mm (W) x 395mm (D) x 88mm (H)
Power supply	Drawn from the unit



Note

*As a part of our policy of continuous improvement, SHARP reserves the right to make design and specification changes for product improvement without prior notice. The performance specification figures indicated are nominal values of production units. There may be some deviations from these values in individual units.*



# ABOUT SUPPLIES AND OPTIONS

When ordering supplies, please use the correct part numbers as listed below.



Note

*Be sure to use only genuine SHARP parts and supplies.*



*For best copying results, be sure to use only SHARP Genuine Supplies which are designed, engineered, and tested to maximize the life and performance of SHARP copiers. Look for the Genuine Supplies label on the toner package.*

## Supply list

Supply	Part number	Usable life
Toner cartridge	AR-152T	Approx. 8,000 sheets*

\*Based on copying onto A4-type paper at 5% toned area.

# INDEX

## 2

250-sheet paper feed unit .....67

## A

About supplies .....71

Acrobat Reader .....62

Alarm indicator

- Developer replacement required

indicator .....6, 30, 35

- Maintenance indicator .....6, 30, 35

- Misfeed indicator .....6, 30, 32

- Toner cartridge replacement required

indicator .....6, 24, 30

Appendix .....68

Auto clear time .....22

Auto power shut-off mode .....22

Automatic exposure adjustment .....19

## B

Before installation .....38

Button Manager .....37, 53

Bypass feed .....10

Bypass paper guides .....5, 10

## C

Cautions

- Handling .....2

- Label .....1

- Laser .....2

- Using .....1

Charger cleaner .....5, 28

CLEANING .....27

Cleaning the unit

- Cabinet .....27

- Original cover .....27

- Original table .....27

- SPF .....27

- SPF scanning window .....27

- Transfer charger .....28

Clear key .....6, 18, 23

Connecting the interface cable

- Parallel interface cable .....65

- USB interface cable .....64

Conventions used in this manual .....4

Copy flow .....13

Copy quantity .....18

Copy quantity key .....6, 15, 18

Copy ratio display key .....6, 18

Copy ratio selector indicator .....6, 18

Copy ratio selector key .....6, 18

## D

Dark key .....6, 18

Developer replacement required

indicator .....6, 30, 35

Developer required .....35

Display .....6

Displaying total number of copies .....23

## E

Exposure adjustment .....18

Exposure mode indicator .....6, 18

Exposure mode selector key .....6, 18

## F

Flow of installation .....39

Front cover .....5

Fusing unit release lever .....5, 32

## H

Handle .....5

Hardware and software

requirements .....38

How to print .....51

How to use the online manual .....61

## I

Indicators on the operation panel .....50

Initial settings of operation panel .....15

Installing the software .....40

Interface

- Parallel interface .....65

- USB interface .....64

Interrupt copying .....52

Introduction .....4

## L

Light and dark indicator .....6, 18

Light key .....6, 18

Loading paper .....7

Loading the paper tray .....8

## M

Maintenance indicator .....6, 30, 35

Making copies .....13

MFP driver

- Print Status Window .....37

- Printer driver.....37
- Scanner driver.....37
- Misfeed indicator.....6, 30, 32
- Misfeed removal
  - Fusing area .....32
  - Lower paper feed area .....34
  - Paper feed area.....32
  - SPF .....34
  - Transport area.....33
- Multi-bypass tray.....10

## N

- Name
  - Operation panel.....6
  - Part names.....5

## O

- ONLINE indicator.....6, 50
- ONLINE key.....6, 50
- Online manual.....61
- Opening the printer driver .....50
- Opening the scanner driver.....58
- Operation panel .....5
- Optional equipment.....37
- Original placement.....16
  - Original table .....16
  - SPF .....17
- Original table.....5
- Original to copy indicator .....6
- Original to copy key .....6, 13

## P

- Paper .....7
- Paper feed location indicator .....6
- Paper output tray .....5
- Paper output tray extension.....5
- Paper tray .....5, 8
- Parallel interface cable.....63, 64
- Photo copying .....15
- Photoconductive drum .....5, 33, 34
- Power cord socket .....5
- Power off.....15
- Power on.....14
- Power save indicator.....6, 50
- Power save mode indicator.....22
- Power switch.....5, 14
- Preheat mode .....22
- Printer driver .....41
- Proper storage .....2

## R

- Reduction/enlargement/zoom.....20

## S

- Scan head locking switch .....36
- Scanner driver .....37
- Scanner indicator.....6, 50
- SCANNER key .....6, 57
- Scanning from your computer .....58
- Scanning with the "Scanner and Camera Wizard" .....60
- Sharpdesk .....37
- Side cover.....5
- Side cover open button.....5
- Single bypass .....11
- Software for the SHARP Personal MFP series .....37
- Specifications .....68
- SPF.....17
- SPF indicator .....6, 17
- SPF misfed indicator .....6, 31, 34
- Start indicator .....6, 50
- Start key .....6, 13, 23
- Status indicators .....30
- Stream feeding mode .....17, 23
- System configuration.....66

## T

- Toner cartridge .....24
- Toner cartridge life.....26
- Toner cartridge replacement .....24
- Toner cartridge replacement indicator .....6, 24, 30
- Transfer charger .....5, 28
- Tray select key .....6, 20
- Troubleshooting.....29
- Troubleshooting the unit .....29

## U

- USB interface cable.....64
- Using other installed drivers .....63
- Using the manual.....4
- Using the printer mode .....51
- Using the scanner mode.....53
- Using the SHARP TWAIN .....58

## Z

- ZOOM indicator .....6, 20
- ZOOM key .....6, 20

---

## INDEX BY PURPOSE

---

Cleaning the unit		Removing paper jams	
- Cabinet.....	27	- Fusing area .....	32
- Original cover .....	27	- Lower paper feed area .....	34
- Original table .....	27	- Paper feed area .....	32
- SPF .....	27	- SPF .....	34
- Transfer changer .....	28	- Transport area.....	33
Connecting the interface cable		Replacing the toner cartridge .....	24
- Parallel interface cable .....	65	Scanning	
- USB interface cable.....	64	- Button Manager.....	57
Copying.....	13	- Scanner and Camera Wizard.....	60
Displaying total number of copies.....	23	- SHARP TWAIN .....	58
Enlarging/reducing copies.....	20	Selecting the tray.....	20
Installing the software		Setting the copy quality	
- Acrobat .....	62	- AUTO .....	18
- Button Manager.....	37	- MANUAL .....	18
- MFP driver .....	37	- PHOTO .....	19
- Sharpdesk .....	37	Setting the copy quantity .....	18
Loading paper		Setting the toner save mode.....	21
- Multi-bypass tray .....	10	Setting the user program .....	22
- Paper tray .....	7	Setting up the Button Manager.....	53
- Single bypass .....	10	Storing the supplies .....	1
Loading the original.....	16	Using other installed drivers .....	63
- Original table .....	14	Using the online manual .....	61
- SPF .....	15		
Opening the printer driver .....	51		
Power off .....	15		
Power on.....	14		
Printing.....	51		

# SOFTWARE LICENSE

**PLEASE READ THIS LICENSE CAREFULLY BEFORE USING THE SOFTWARE. BY USING THE SOFTWARE, YOU ARE AGREEING TO BE BOUND BY THE TERMS OF THIS LICENSE.**

## **1. License.**

The application, demonstration, system and other software accompanying this License, whether on disk, in read only memory, or on any other media (the "Software") and related documentation are licensed to you by SHARP. You own the disk on which the Software is recorded but SHARP and/or SHARP's Licensors retain title to the Software and related documentation. This License allows you to use the Software on one or more computers connected to a single printer and make one copy of the Software in machine-readable form for backup purposes only. You must reproduce on such copy the SHARP copyright notice, the copyright notice of SHARP's Licensors and any other proprietary legends of SHARP and/or its Licensors that were on the original copy of the Software. You may also transfer all your license rights in the Software, the backup copy of the Software, the related documentation and a copy of this License to another party, provided the other party reads and agrees to the terms and conditions of this License.

## **2. Restrictions.**

The Software contains copyrighted material, trade secrets and other proprietary material which is owned by SHARP and/or its Licensors and in order to protect them you may not decompile, reverse engineer, disassemble or otherwise reduce the Software to a human-perceivable form. You may not modify, network, rent, lease, loan, distribute or create derivative works based upon the Software in whole or in part. You may not electronically transmit the Software from one computer to another or over a network.

## **3. Termination.**

This license is effective until terminated. You may terminate this License at any time by destroying the Software and related documentation and all copies thereof. This License will terminate immediately without notice from SHARP and/or SHARP's Licensors if you fail to comply with any provision of this License. Upon termination you must destroy the Software and related documentation and all copies thereof.

## **4. Export Law Assurances.**

You agree and certify that neither the Software nor any other technical data received from SHARP, nor the direct product thereof, will be exported outside the United States except as authorized and as permitted by the laws and regulations of the United States. If the Software has been rightfully obtained by you outside of the United States, you agree that you will not re-export the Software nor any other technical data received from SHARP, nor the direct product thereof, except as permitted by the laws and regulations of the United States and the laws and the regulation of the jurisdiction in which you obtained the Software.

## **5. Government End Users.**

If you are acquiring the Software on behalf of any unit or agency of the United States Government, the following provisions apply. The Government agrees:

- (i) if the Software is supplied to the Department of Defense (DoD), the Software is classified as "Commercial Computer Software" and the Government is acquiring only "restricted rights" in the Software and its documentation as that term is defined in Clause 252.227-7013 (c)(1) (Oct. 1988) of the DFARS; and
- (ii) if the Software is supplied to any unit or agency of the United States Government other than DoD, the Government's rights in the Software and its documentation will be as defined in Clause 52.227-19 (c)(2) of the FAR or, in the case of NASA, in Clause 18-52.227-86 (d) of the NASA Supplement to the FAR.

## **6. Limited Warranty on Media.**

SHARP warrants the disks on which the Software is recorded to be free from defects in materials and workmanship under normal use for a period of ninety (90) days from the date of purchase as evidenced by a copy of the receipt. The entire liability of SHARP and/or its Licensors and your exclusive remedy will be replacement of the disk which fails to meet the limited warranty provided by this Clause 6. A disk will be replaced when it is returned to SHARP or a SHARP authorized representative with a copy of the receipt. SHARP will have no responsibility to replace a disk damaged by accident, abuse or misapplication.

ANY IMPLIED WARRANTIES ON THE DISKS, INCLUDING THE IMPLIED WARRANTIES OF MERCHANTABILITY AND FITNESS FOR A PARTICULAR PURPOSE, ARE LIMITED IN DURATION TO NINETY (90) DAYS FROM THE DATE OF DELIVERY. THIS WARRANTY GIVES YOU SPECIFIC LEGAL RIGHTS, AND YOU MAY ALSO HAVE OTHER RIGHTS WHICH VARY FROM JURISDICTION TO JURISDICTION.

## **7. Disclaimer of Warranty on Software.**

You expressly acknowledge and agree that use of the Software is at your sole risk. The Software and related documentation are provided "AS IS" and without warranty of any kind and SHARP and SHARP's Licensor(s) (for the purpose of provisions 7 and 8, SHARP and SHARP's Licensor(s) shall be collectively referred to as "SHARP") EXPRESSLY DISCLAIM ALL WARRANTIES, EXPRESS OR IMPLIED, INCLUDING, BUT NOT LIMITED TO, THE IMPLIED WARRANTIES OF MERCHANTABILITY AND FITNESS FOR A PARTICULAR PURPOSE. SHARP DOES NOT WARRANT THAT THE FUNCTIONS CONTAINED IN THE SOFTWARE WILL MEET YOUR REQUIREMENTS, OR THAT THE OPERATION OF THE SOFTWARE WILL BE UNINTERRUPTED OR ERROR-FREE, OR THAT DEFECTS IN THE SOFTWARE WILL BE CORRECTED. FURTHERMORE, SHARP DOES NOT WARRANT OR MAKE ANY REPRESENTATIONS REGARDING THE USE OR THE RESULTS OF THE USE OF THE SOFTWARE OR RELATED DOCUMENTATION IN TERMS OF THEIR CORRECTNESS, ACCURACY, RELIABILITY, OR OTHERWISE. NO ORAL OR WRITTEN INFORMATION OR ADVICE GIVEN BY SHARP OR A SHARP AUTHORIZED REPRESENTATIVE SHALL CREATE A WARRANTY OR IN ANY WAY INCREASE THE SCOPE OF THIS WARRANTY. SHOULD THE SOFTWARE PROVE DEFECTIVE, YOU (AND NOT SHARP OR A SHARP AUTHORIZED REPRESENTATIVE) ASSUME THE ENTIRE COST OF ALL NECESSARY SERVICING, REPAIR OR CORRECTION, SOME JURISDICTIONS DO NOT ALLOW THE EXCLUSION OF IMPLIED WARRANTIES, SO THE ABOVE EXCLUSION MAY NOT APPLY TO YOU.

## **8. Limitation of Liability.**

UNDER NO CIRCUMSTANCES INCLUDING NEGLIGENCE, SHALL SHARP BE LIABLE FOR ANY INCIDENTAL, SPECIAL OR CONSEQUENTIAL DAMAGES THAT RESULT FROM THE USE OR INABILITY TO USE THE SOFTWARE OR RELATED DOCUMENTATION, EVEN IF SHARP OR A SHARP AUTHORIZED REPRESENTATIVE HAS BEEN ADVISED OF THE POSSIBILITY OF SUCH DAMAGES. SOME JURISDICTIONS DO NOT ALLOW THE LIMITATION OR EXCLUSION OF LIABILITY FOR INCIDENTAL OR CONSEQUENTIAL DAMAGES SO THE ABOVE LIMITATION OR EXCLUSION MAY NOT APPLY TO YOU.

In no event shall SHARP's total liability to you for all damages, losses, and causes of action (whether in contract, tort (including negligence) or otherwise) exceed the amount paid by you for the Software.

## **9. Controlling Law and Severability.**

For a portion of the Software related with Apple Macintosh and Microsoft Windows, this license shall be governed by and construed in accordance with the laws of the state of California and Washington, respectively. For a portion of the Software and for the documentation relating thereto which has been licensed to SHARP by Software 2000 International Limited, this license should be governed by and constructed in accordance with the laws in England. If for any reason a court of competent jurisdiction finds any provision of this License, or portion thereof, to be unenforceable, that provision of the License shall be enforced to the maximum extent permissible so as to effect the intent of the parties, and the remainder of this License shall continue in full force and effect.

## **10. Complete Agreement.**

This License constitutes the entire agreement between the parties with respect to the use of the Software and related documentation, and supersedes all prior or contemporaneous understandings or agreements, written or oral, regarding such subject matter. No amendment to or modification of this License will be binding unless in writing and signed by a duly authorized representative of SHARP.

This equipment complies with the requirements of Directives 89/336/EEC and 73/23/EEC as amended by 93/68/EEC.

Dieses Gerät entspricht den Anforderungen der EG-Richtlinien 89/336/EWG und 73/23/EWG mit Änderung 93/68/EWG.

Ce matériel répond aux exigences contenues dans les directives 89/336/CEE et 73/23/CEE modifiées par la directive 93/68/CEE.

Dit apparaat voldoet aan de eisen van de richtlijnen 89/336/EEG en 73/23/EEG, gewijzigd door 93/68/EEG.

Dette udstyr overholder kravene i direktiv nr. 89/336/EEC og 73/23/EEC med tillæg nr. 93/68/EEC.

Quest' apparecchio è conforme ai requisiti delle direttive 89/336/EEC e 73/23/EEC, come emendata dalla direttiva 93/68/EEC.

Η εγκατάσταση αυτή ανταποκρίνεται στις απαιτήσεις των οδηγιών της Ευρωπαϊκής Ένωσης 89/336/ΕΟΚ και 73/23/ΕΟΚ, όπως οι κανονισμοί αυτοί συμπληρώθηκαν από την οδηγία 93/68/ΕΟΚ.

Este equipamento obedece às exigências das directivas 89/336/CEE e 73/23/CEE, na sua versão corrigida pela directiva 93/68/CEE.

Este aparato satisface las exigencias de las Directivas 89/336/CEE y 73/23/CEE, modificadas por medio de la 93/68/CEE.

Denna utrustning uppfyller kraven enligt riktlinjerna 89/336/EEC och 73/23/EEC så som kompletteras av 93/68/EEC.

Dette produktet oppfyller betingelsene i direktivene 89/336/EEC og 73/23/EEC i endringen 93/68/EEC.

Tämä laite täyttää direktiivien 89/336/EEC ja 73/23/EEC vaatimukset, joita on muutettu direktiivillä 93/68/EEC.

The CE mark logo label is affixed on an equipment in case that the directives described in the above sentence are applicable to the product. (This sentence is not applicable in any country where the above directives are not required.)

Das CE-Label wird nur dann auf einem Gerät, einer Einrichtung oder Anlage aufgebracht, wenn die in dem vorstehenden Satz beschriebenen Richtlinien auf das Produkt anwendbar sind. (Dieser Satz ist nicht für Länder bestimmt, in denen die vorgenannten Richtlinien nicht Bedingung sind.)

Le logo CE est inscrit sur l'appareil dans le cas où les directives ci-dessus sont applicables au produit. (Ce commentaire n'est pas applicable dans aucun pays où les directives ci-dessus ne sont pas nécessaires.)

L'etichetta con il logo del marchio CE è applicata su un apparecchio nel caso in cui le direttive descritte nella frase di cui sopra sono applicabili al prodotto. (Questa frase non è applicabile in qualsiasi Paese, nel quale le direttive di cui sopra non sono richieste.)

En caso que las directrices descritas en la anterior frase sean aplicables al producto, se fijará al aparato el adhesivo con el logotipo CE. (Esta frase no es aplicable en los países en los cuales no se requieren las directrices arriba citadas.)

**SHARP®**

**SHARP CORPORATION**

Printed in France  
TINSZ0997TSZZ



## Free Manuals Download Website

<http://myh66.com>

<http://usermanuals.us>

<http://www.somanuals.com>

<http://www.4manuals.cc>

<http://www.manual-lib.com>

<http://www.404manual.com>

<http://www.luxmanual.com>

<http://aubethermostatmanual.com>

Golf course search by state

<http://golfingnear.com>

Email search by domain

<http://emailbydomain.com>

Auto manuals search

<http://auto.somanuals.com>

TV manuals search

<http://tv.somanuals.com>