

**SHARP**®

# PN-T322B

LCD MONITOR

OPERATION MANUAL

**HDMI**™  
HIGH-DEFINITION MULTIMEDIA INTERFACE

**IMPORTANT:**

To aid reporting in case of loss or theft, please record the product's model and serial numbers in the space provided. The numbers are located in the rear of the product.



Model No.:

Serial No.:

U.S.A. ONLY

# IMPORTANT INFORMATION

**WARNING:** TO REDUCE THE RISK OF FIRE OR ELECTRIC SHOCK, DO NOT EXPOSE THIS PRODUCT TO RAIN OR MOISTURE.

	<b>CAUTION</b> RISK OF ELECTRIC SHOCK DO NOT OPEN	
<b>CAUTION:</b> TO REDUCE THE RISK OF ELECTRIC SHOCK, DO NOT REMOVE COVER. NO USER-SERVICEABLE PARTS INSIDE. REFER SERVICING TO QUALIFIED SERVICE PERSONNEL.		



The lightning flash with arrowhead symbol, within an equilateral triangle, is intended to alert the user to the presence of uninsulated “dangerous voltage” within the product’s enclosure that may be of sufficient magnitude to constitute a risk of electric shock to persons.



The exclamation point within a triangle is intended to alert the user to the presence of important operating and maintenance (servicing) instructions in the literature accompanying the product.

**WARNING:**

FCC Regulations state that any unauthorized changes or modifications to this equipment not expressly approved by the manufacturer could void the user’s authority to operate this equipment.

**NOTE:**

This equipment has been tested and found to comply with the limits for Class A digital device, pursuant to Part 15 of the FCC Rules. These limits are designed to provide reasonable protection against harmful interference when the equipment is operated in a commercial environment. This equipment generates, uses, and can radiate radio frequency energy and, if not installed and used in accordance with the instruction manual, may cause harmful interference to radio communications. Operation of this equipment in a residential area is likely to cause harmful interference in which case the user will be required to correct the interference at his own expense.

This product utilizes a CR coin Lithium battery which contains a Perchlorate material. Special handling for this material may apply, California residents, See [www.dtsc.ca.gov/hazardouswaste/perchlorate/](http://www.dtsc.ca.gov/hazardouswaste/perchlorate/) Others, consult local environmental officers.

U.S.A. ONLY

# DEAR SHARP CUSTOMER

---

Thank you for your purchase of a SHARP LCD product. To ensure safety and many years of trouble-free operation of your product, please read the Safety Precautions carefully before using this product.

## SAFETY PRECAUTIONS

---

Electricity is used to perform many useful functions, but it can also cause personal injuries and property damage if improperly handled. This product has been engineered and manufactured with the highest priority on safety. However, improper use can result in electric shock and/or fire. In order to prevent potential danger, please observe the following instructions when installing, operating and cleaning the product. To ensure your safety and prolong the service life of your LCD product, please read the following precautions carefully before using the product.

1. Read instructions — All operating instructions must be read and understood before the product is operated.
2. Keep this manual in a safe place — These safety and operating instructions must be kept in a safe place for future reference.
3. Observe warnings — All warnings on the product and in the instructions must be observed closely.
4. Follow instructions — All operating instructions must be followed.
5. Cleaning — Unplug the power cord from the AC outlet before cleaning the product. Also turn off the power of the connected computer. Use a dry cloth to clean the product. Do not use liquid cleaners or aerosol cleaners.
6. Attachments — Do not use attachments not recommended by the manufacturer. Use of inadequate attachments can result in accidents.
7. Water and moisture — Do not use the product near water. Do not install the product in a place where water may splash onto it. Be careful of equipment which drains water such as an air-conditioner.
8. Ventilation — The vents and other openings in the cabinet are designed for ventilation. Do not cover or block these vents and openings since insufficient ventilation can cause overheating and/or shorten the life of the product. Do not place the product on a sofa, rug or other similar surface, since they can block ventilation openings. Do not place the product in an enclosed place such as a bookcase or rack, unless proper ventilation is provided or the manufacturer's instructions are followed.
9. Power cord protection — The power cords must be routed properly to prevent people from stepping on them or objects from resting on them.
10. The screen used in this product is made of glass. Therefore, it can break when the product is dropped or applied with impact. Be careful not to be injured by broken glass pieces in case the screen breaks.
11. Overloading — Do not overload AC outlets or extension cords. Overloading can cause fire or electric shock.
12. Entering of objects and liquids — Never insert an object into the product through vents or openings. High voltage flows in the product, and inserting an object can cause electric shock and/or short internal parts. For the same reason, do not spill water or liquid on the product.
13. Servicing — Do not attempt to service the product yourself. Do not remove any screws other than the USB flash drive cover screw (black). Removing covers can expose you to high voltage and other dangerous conditions. Request a qualified service person to perform servicing.
14. Repair — If any of the following conditions occurs, unplug the power cord from the AC outlet, and request a qualified service person to perform repairs.
  - a. When the power cord or plug is damaged.
  - b. When a liquid was spilled on the product or when objects have fallen into the product.
  - c. When the product has been exposed to rain or water.
  - d. When the product does not operate properly as described in the operating instructions.

Do not touch the controls other than those described in the operating instructions. Improper adjustment of controls not described in the instructions can cause damage, which often requires extensive adjustment work by a qualified technician.
  - e. When the product has been dropped or damaged.
  - f. When the product displays an abnormal condition. Any noticeable abnormality in the product indicates that the product needs servicing.
15. Replacement parts — In case the product needs replacement parts, make sure that the service person uses replacement parts specified by the manufacturer, or those with the same characteristics and performance as the original parts. Use of unauthorized parts can result in fire, electric shock and/or other danger.
16. Safety checks — Upon completion of service or repair work, request the service technician to perform safety checks to ensure that the product is in proper operating condition.
17. Wall mounting — When mounting the product on a wall, be sure to install the product according to the method recommended by the manufacturer.
18. Heat sources — Keep the product away from heat sources such as radiators, heaters, stoves and other heat-generating products (including amplifiers).

# SAFETY PRECAUTIONS (Continued)

19. Batteries — Incorrect use of batteries may cause the batteries to burst or ignite. A leaky battery may corrode the equipment, dirty your hands or spoil your clothing. In order to avoid these problems, make sure to observe the precautions below:
- Install the batteries with due attention to the plus (+) and minus (-) sides of the batteries according to the instructions in the compartment.
  - Replace an exhausted battery with a new one promptly.
  - Do not short the terminals.
  - Do not throw into water or fire. Do not disassemble.
  - Use the specified batteries only.
  - If you will not use the remote control for a long time, remove the batteries.
  - If leaked battery fluid gets on your skin or clothing, rinse immediately and thoroughly. If it gets into your eye, bathe your eye well rather than rubbing and seek medical treatment immediately. Leaked battery fluid that gets into your eye or your clothing may cause a skin irritation or damage your eye.
- Store lithium batteries outside the reach of small children. In the event that a battery is swallowed, seek the advice of a physician immediately.
20. Usage of the monitor must not be accompanied by fatal risks or dangers that, could lead directly to death, personal injury, severe physical damage or other loss, including nuclear reaction control in nuclear facility, medical life support system, and missile launch control in a weapon system.
21. Do not stay in contact with the parts of the product that become hot for long periods of time. Doing so may result in low-temperature burns.

## **WARNING:**

This is a class A product. In a domestic environment this product may cause radio interference in which case the user may be required to take adequate counter measures.

To maintain compliance with EMC regulations, use shielded cables to connect to the following terminals: PC/AV DVI-D input terminal, PC/AV HDMI input terminal, PC D-sub input terminal, AV COMPONENT input terminal, AV video/AV audio input terminal, and RS-232C input terminal.

If a monitor is not positioned in a sufficiently stable location, it can be potentially hazardous due to falling. Many injuries, particularly to children, can be avoided by taking simple precautions such as:

- Using fixing devices like wall mount brackets recommended by the manufacturer.
- Only using furniture that can safely support the monitor.
- Ensuring the monitor is not overhanging the edge of the supporting furniture.
- Not placing the monitor on tall furniture (for example, cupboards or bookcases) without anchoring both the furniture and the monitor to a suitable support.
- Not standing the monitors on cloth or other materials placed between the monitor and supporting furniture.
- Educating children about the dangers of climbing on furniture to reach the monitor or its controls.

## **Especially for child safety**

- Don't allow children to climb on or play with the monitor.
- Don't place the monitor on furniture that can easily be used as steps, such as a chest of drawers.
- Remember that children can become excited while watching a program, especially on a "larger than life" monitor. Care should be taken to place or install the monitor where it cannot be pushed, pulled over, or knocked down.
- Care should be taken to route all cords and cables connected to the monitor so that they cannot be pulled or grabbed by curious children.

# TIPS AND SAFETY INSTRUCTIONS

- The TFT color LCD panel used in this monitor is made with the application of high precision technology. However, there may be minute points on the screen where pixels never light or are permanently lit. Also, if the screen is viewed from an acute angle there may be uneven colors or brightness. Please note that these are not malfunctions but common phenomena of LCDs and will not affect the performance of the monitor.
- Do not display a still picture for a long period, as this could cause a residual image.
- Never rub or tap the monitor with hard objects.
- Please understand that SHARP CORPORATION bears no responsibility for errors made during use by the customer or a third party, nor for any other malfunctions or damage to this product arising during use, except where indemnity liability is recognized under law.
- This monitor and its accessories may be upgraded without advance notice.
- Do not use the monitor where there is a lot of dust, where humidity is high, or where the monitor may come into contact with oil or steam, as this could lead to fire.
- Ensure that the monitor does not come into contact with water or other fluids. Ensure that no objects such as paper clips or pins enter the monitor as this could lead to fire or electric shock.
- Do not place the monitor on top of unstable objects or in unsafe places. Do not allow the monitor to receive strong shocks or to strongly vibrate. Causing the monitor to fall or topple over may damage it.
- Do not use the monitor near heating equipment or in places where there is likelihood of high temperature, as this may lead to generation of excessive heat and outbreak of fire.
- Do not use the monitor in places where it may be exposed to direct sunlight.
- Images cannot be rotated on this monitor. When using in vertical orientation, you will need to prepare appropriately orientated content in advance.
- The AC outlet shall be installed near the equipment and shall be easily accessible.
- Do not touch the screen while the PC is starting up.
- Do not operate the screen with a hard or pointed object such as a fingernail, pen, or pencil.
- If another USB device is connected to the computer to which the touch panel is connected, do not operate the USB device during touch panel input. Input may not take place correctly.
- If the reflective surface becomes dirty, malfunctioning may result. Use a soft cloth to gently wipe dirt off the reflective surface.  
When wiping the reflective surface, wipe from the sensor downward (if the monitor is in the vertical orientation, wipe to the right). Wiping toward the sensor may cause dust to enter the sensor.
- Incorrect operation may result if dust enters the sensor. If any dust enters the sensor area (groove), blow off with the provided air blower.  
To clean dust that cannot be removed with the air blower, contact an authorized Sharp servicing dealer or service center (extra charge required).
- Do not use near devices that use infrared. Malfunctioning may result. Use the monitor away from other devices.

## The Power Cord

- Use only the power cord supplied with the monitor.
- Do not damage the power cord nor place heavy objects on it, stretch it or over bend it. Also, do not add extension cords. Damage to the cord may result in fire or electric shock.
- Do not use the power cord with a power tap. Adding an extension cord may lead to fire as a result of overheating.
- Do not remove or insert the power plug with wet hands. Doing so could result in electric shock.
- Unplug the power cord if it is not used for a long time.
- Do not attempt to repair the power cord if it is broken or malfunctioning. Refer the servicing to the service representative.

## Manual Scope

- Microsoft, Windows, Windows Vista, PowerPoint and Internet Explorer are registered trademarks of Microsoft Corporation.
- HDMI, the HDMI Logo and High-Definition Multimedia Interface are trademarks or registered trademarks of HDMI Licensing LLC.
- Adobe, Acrobat, and Reader are either registered trademarks or trademarks of Adobe Systems Incorporated in the United States and/or other countries.
- This product comes with RICOH Bitmap Fonts produced and sold by RICOH COMPANY, LTD.
- All other brand and product names are trademarks or registered trademarks of their respective holders.
- Language of OSD menu used in this manual is English by way of example.
- Illustrations in this manual may not exactly represent the actual product or display.
- This manual assumes use in horizontal orientation, except where specifically noted.

## LED Backlight

- The LED backlight in this product has a limited lifetime. If the screen becomes dark or does not illuminate, contact an authorized Sharp servicing dealer or service center.

# MOUNTING PRECAUTIONS

- This product is for use indoors.
- A mounting bracket compliant with VESA specifications is required.
- Consult your dealer before installing, removing or moving the monitor.
- Mounting the monitor on the wall requires special expertise and the work must be performed by an authorized SHARP dealer. You should never attempt to perform any of this work yourself. Our company will bear no responsibility for accidents or injuries caused by improper mounting or mishandling.
- When moving the monitor, grasp both corners at the bottom of monitor. Do not grasp the screen or sensor. This may cause product damage, failure, or injury.
- Use the monitor in a state that is perpendicular to the horizontal plane. If you tilt the monitor, do not tilt upward more than 45° or downward more than 20°.
- If tilted upward 20° or more, set "BRIGHT" to "20" or less to prevent internal temperature abnormalities.
- This monitor should be used at an ambient temperature between 41°F (5°C) and 95°F (35°C). Provide enough space around the monitor to prevent heat from accumulating inside.

## For the monitor in horizontal orientation

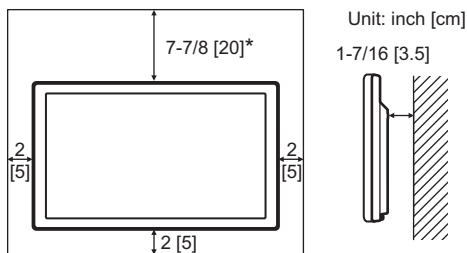

## For the monitor in vertical orientation

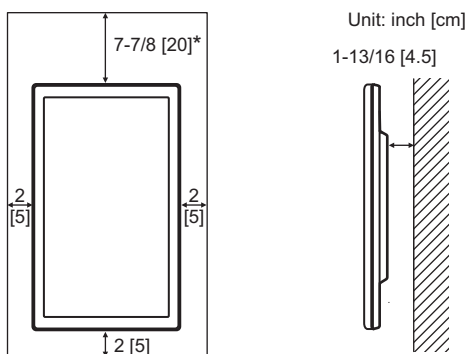

\* If the monitor will be tilted, maintain a clearance of 15-3/4 inch (40 cm).

- If it is difficult to provide sufficient space because the monitor is used inside a housing or otherwise, or if the ambient temperature is above the range 41°F (5°C) to 95°F (35°C), install a fan or take other measures to keep the ambient temperature within the required range.
- Temperature condition may change when using the monitor together with the optional equipments recommended by SHARP. In such cases, please check the temperature condition specified by the optional equipments.
- Do not block any ventilation openings. If the temperature inside the monitor rises, this could lead to a malfunction.
- Do not place the monitor on a device which generates heat.
- Do not use the product in locations where the unit is exposed to direct sunlight or other strong light. Since this product operates with infrared rays, such light may cause a malfunction.

- Adhere to the following when installing the monitor in its vertical orientation. Failing to adhere to the following may cause malfunctions.
  - Install the monitor such that the power LED is located on the bottom side.
  - Mount so that the  $\triangle$  mark on the back points up.
  - Set the THERMAL SENSOR SETTING in the SETUP menu to PORTRAIT. (See page 21.)
- Use the supplied vertical sticker when you install the monitor in vertical orientation.

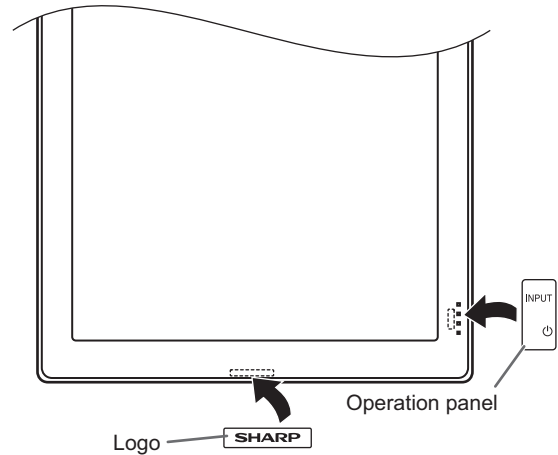

- Be careful not to cover the remote control sensor or buttons.

## Mounting precautions (for SHARP dealers and service engineers)

- Be sure to use a wall-mount bracket designed or designated for mounting the monitor.
- To attach a VESA-compliant mounting bracket, use M6 screws that are 5/16 inch (8 mm) to 3/8 inch (10 mm) longer than the thickness of the mounting bracket.
- This monitor is designed to be installed on a concrete wall or pillar. Reinforced work might be necessary for some materials such as plaster / thin plastic board / wood before starting installation. This monitor and bracket must be installed on a wall which can endure at least 4 times or more the weight of the monitor. Install by the most suitable method for the material and the structure.
- After mounting, please carefully ensure the monitor is secure, and not able to come loose from the wall or mount.
- Do not use any screw holes other than VESA holes for installation.

# Contents

<b>IMPORTANT INFORMATION</b> .....	<b>1</b>	<b>Touch Action</b> .....	<b>14</b>
<b>DEAR SHARP CUSTOMER</b> .....	<b>2</b>	Other functions.....	15
<b>SAFETY PRECAUTIONS</b> .....	<b>2</b>	Cautionary points .....	15
<b>TIPS AND SAFETY INSTRUCTIONS</b> .....	<b>4</b>	<b>Basic Operation</b> .....	<b>16</b>
<b>MOUNTING PRECAUTIONS</b> .....	<b>5</b>	Auto playback of image and audio files (Slideshow) ..	18
Mounting precautions		<b>Menu Items</b> .....	<b>19</b>
(for SHARP dealers and service engineers) .....	5	Displaying the menu screen.....	19
<b>Supplied Components</b> .....	<b>6</b>	Menu item details .....	20
<b>System Requirements</b> .....	<b>6</b>	List screen .....	21
<b>Part Names</b> .....	<b>7</b>	Adjustments for PC screen display .....	22
<b>Connecting Peripheral Equipment</b> .....	<b>9</b>	<b>Initialization/Functional Restriction Setting</b>	
Connection with a PC or AV equipment .....	9	<b>(FUNCTION Menu)</b> .....	<b>23</b>
USB flash drive connection .....	9	<b>Controlling the Monitor with a PC (RS-232C)</b> .....	<b>24</b>
<b>Connecting the Power Cord</b> .....	<b>10</b>	PC connection.....	24
<b>Binding Cables</b> .....	<b>11</b>	Communication conditions .....	24
<b>Setting the USB flash drive cover</b> .....	<b>11</b>	Communication procedure .....	24
<b>Preparing the Remote Control Unit</b> .....	<b>12</b>	RS-232C command table.....	26
Changing the battery.....	12	<b>Troubleshooting</b> .....	<b>28</b>
Remote control operation range.....	12	<b>Specifications</b> .....	<b>29</b>
<b>Turning Power On/Off</b> .....	<b>13</b>		
Turning on the main power.....	13		
Turning power on/off .....	13		
Disabling power on/off operations.....	13		

## Supplied Components

If any component should be missing, please contact your dealer.

- |   |  |  |
|---|--|--|
| <input type="checkbox"/> Liquid Crystal Display Monitor: 1                          | <input type="checkbox"/> Conversion cable (for AV video): 1    | <input type="checkbox"/> Air blower: 1                       |
| <input type="checkbox"/> Remote control unit: 1<br>(Battery preinstalled)           | (red/white/yellow)   | <input type="checkbox"/> USB flash drive cover: 1            |
| <input type="checkbox"/> Cable clamp: 1   | <input type="checkbox"/> CD-ROM (Utility Disk for Windows): 1  | <input type="checkbox"/> USB flash drive cover screw: 1      |
| <input type="checkbox"/> Power cord: 1  | <input type="checkbox"/> Setup Manual: 1                       | <input type="checkbox"/> Cover Sharp logo: 1                 |
| <input type="checkbox"/> Conversion cable (for AV component): 1<br>(green/blue/red) | <input type="checkbox"/> Vertical sticker (Operation panel): 1 | Place this sticker onto the SHARP logo<br>to cover the logo. |
|   | <input type="checkbox"/> Vertical sticker (Logo): 1            |  |

\* The utility in the CD-ROM is protected by copyright. Do not reproduce.

\* For environmental protection!

Do not dispose of batteries in household waste. Follow the disposal instructions for your area.

## System Requirements

To use the touch panel, the touch panel must be connected to a computer, and the touch panel driver must be installed on the computer from the supplied CD-ROM. System requirements for the software program are as follows.

Computer	PC/AT compatible computer with a USB 1.1 port and able to output a resolution of 1366 x 768. (CD-ROM drive required for software installation.)
OS	Windows XP (32-bit or 64-bit version), Windows Vista (32-bit or 64-bit version), Windows 7 (32-bit or 64-bit version)

To connect the touch panel and install the touch panel driver, see the Touch Panel Driver Operation Manual.



# Part Names

## ■ Front view

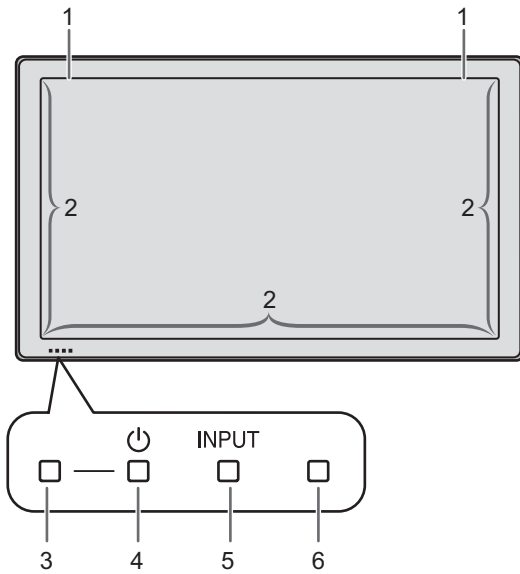

1. Sensor
2. Reflective surface
3. Power LED (See page 13.)
4. Power switch (See page 13.)
5. Input switch (See page 16.)
6. Remote control sensor (See page 12.)

### TIPS

- Use a pointed object such as a pen tip to press the switches at the operation panel.

## ■ Rear view

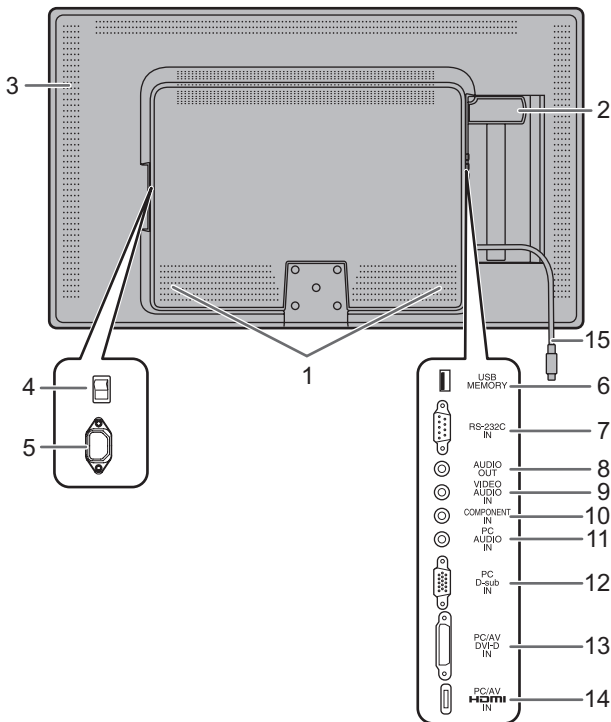

1. Speakers
2. USB flash drive cover
3. Vents
4. Main power switch (See page 13.)
5. AC input terminal (See page 10.)
6. USB port (See page 9.)
7. RS-232C input terminal (See page 9.)
8. Audio output terminal (See page 9.)
9. AV video/AV audio input terminal (See page 9.)
10. AV COMPONENT input terminal (See page 9.)
11. PC audio input terminal (See page 9.)
12. PC D-sub input terminal (See page 9.)
13. PC/AV DVI-D input terminal (See page 9.)
14. PC/AV HDMI input terminal (See page 9.)
15. USB cable (for touch panel)

### ■ Remote control unit

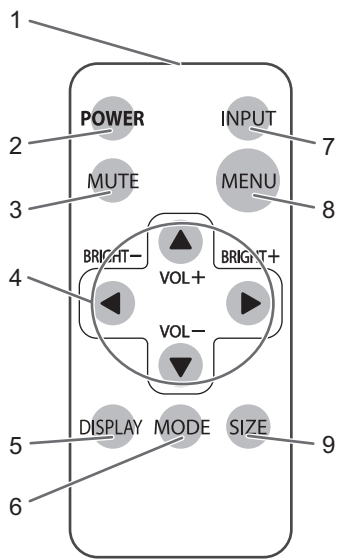

1. **Signal transmitter**
2. **POWER button** (See page 13.)
3. **MUTE button** (See page 16.)
4. **VOL +/- buttons** (See page 16.)  
**BRIGHT +/- buttons** (See page 16.)  
**Cursor control (▲ / ▼ / ◀ / ▶) buttons**
5. **DISPLAY button** (See page 16.)
6. **MODE button** (See page 16.)
7. **INPUT button** (See page 16.)
8. **MENU button** (See page 16.)
9. **SIZE button** (See page 16.)

# Connecting Peripheral Equipment

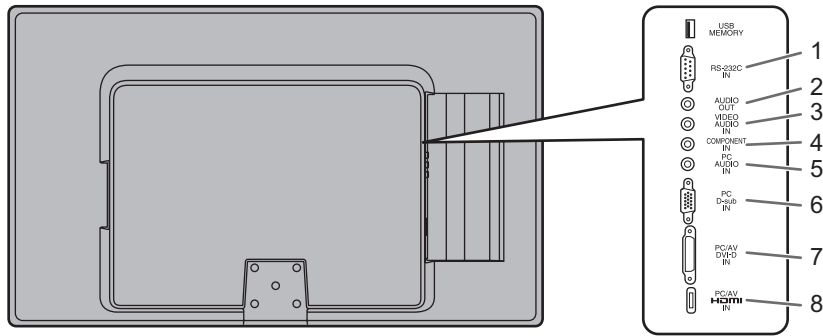

## ! Caution

- Be sure to turn off the main power switch and disconnect the plug from the power outlet before connecting/disconnecting cables. Also, read the manual of the equipment to be connected.
- Be careful not to confuse the input terminal with the output terminal when connecting cables. Accidentally reversing cables connected to the input and output terminals may cause malfunctions and the other problems.

## TIPS

- When using the touch panel, connect the USB cable to the computer. For details, see the Touch Panel Driver Operation Manual.
- Images may not be displayed properly depending on the computer (video card) to be connected.
- Use the automatic screen adjustment when a PC screen is displayed for the first time using D-SUB or when the setting of the PC is changed.
- If the audio output from the playback device is connected directly to speakers or other devices, the video on the monitor may appear delayed from the audio portion. Audio should be played through this monitor by connecting the playback device to the monitor's audio input, and connecting the monitor's audio output to the speakers or other devices.
- Connect the audio used in each input mode to the audio input terminals below.

Input mode	Audio input terminal
D-SUB, DVI-D	PC audio input terminal
COMPONENT, VIDEO	AV audio input terminal
HDMI	PC/AV HDMI input terminal, PC audio input terminal *
USB	-

\* If audio will not be input by HDMI cable.

## Connection with a PC or AV equipment

### 1. RS-232C input terminal

- You can control the monitor from a PC by connecting a commercially available RS-232 straight cable between these terminals and the PC.

### 2. Audio output terminal

- Audio input into the monitor is output.
- Connect using a commercially available 3.5 mm mini stereo jack cable or a 3.5 mm mini stereo jack and RCA conversion cable.
- The output sound varies depending on the input mode.
- The volume can be adjusted with the volume adjustment.

- The volume of the output sound can be fixed by setting AUDIO OUTPUT on the OPTION menu.
- It is not possible to control the sound output from the audio output terminal with the AUDIO menu.

### 3. AV video/AV audio input terminal

- Connect with the provided conversion cable (for AV video), and then connect the end to a commercially available video / audio cable (RCA).

### 4. AV COMPONENT input terminal

- Connect with the provided conversion cable (for AV component), and then connect the end to a commercially available component cable (RCA).

### 5. PC audio input terminal

- Use an audio cable without resistance.

### 6. PC D-sub input terminal

- Connect using a commercially available signal cable (Mini D-sub 15 pin).

### 7. PC/AV DVI-D input terminal

- Connect using a commercially available signal cable (DVI-D 24 pin).

### 8. PC/AV HDMI input terminal

- Use a commercially available HDMI cable (conforming to the HDMI standard).
- If connecting by HDMI cable, connection to the audio input terminal is unnecessary.
- If audio will not be input using an HDMI cable, connect the audio to the PC audio input terminal.

## USB flash drive connection

- Connect a USB flash drive to the USB port.
- Do not connect a USB device other than a USB flash drive.
- Turn off the power of the monitor when connecting or removing a USB flash drive.
- Do not use a USB extension cable.
- Do not use a USB flash drive with a security function.
- Use a USB flash drive with a shape that can be inserted in the USB port. Some USB flash drives with special shapes cannot be inserted.
- A USB flash drive that has a thickness of more than 1/8 inch (3.6 mm) below the connector cannot be connected.

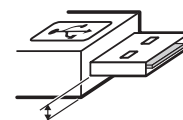

1/8 inch [3.6 mm]

# Connecting the Power Cord

## ! Caution

- Do not use a power cord other than the one supplied with the monitor.
1. Turn off the main power switch.
  2. Plug the power cord (supplied) into the AC input terminal.
  3. Plug the power cord (supplied) into the AC power outlet.

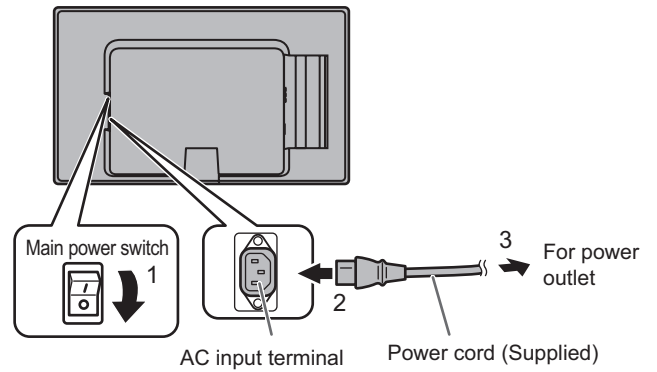

## TIPS

- Insert the power cord through the claw at the bottom of the monitor (left side of the monitor if oriented vertically).

### For the monitor in horizontal orientation

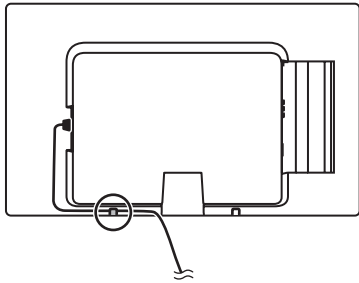

### For the monitor in vertical orientation

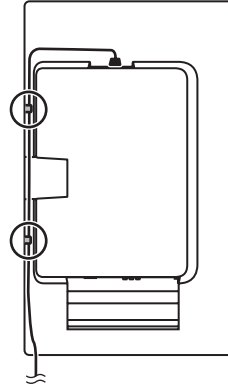

# Binding Cables

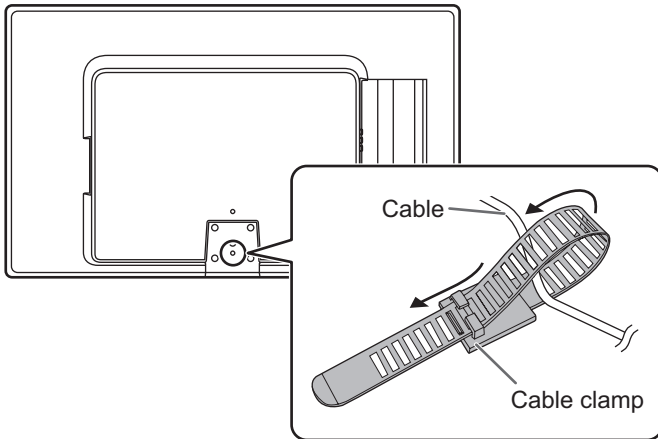

The cables connected to the terminals on the rear of the monitor can be fastened with the cable clamp.

Attach the cable clamp to the back of the monitor, and fasten the cables.

# Setting the USB flash drive cover

**1. Insert the USB flash drive into the USB port.**

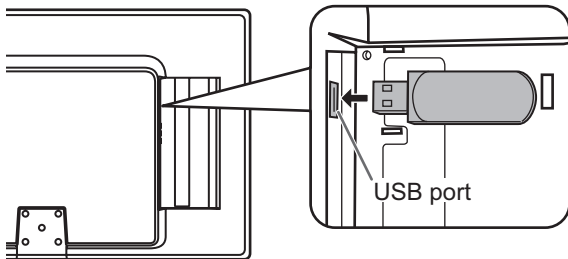

**2. Attach the USB flash drive cover and secure with the provided screw.**

Insert the claw (1) into the monitor, and while pressing in the direction of (2), insert the claw (3) into the monitor.

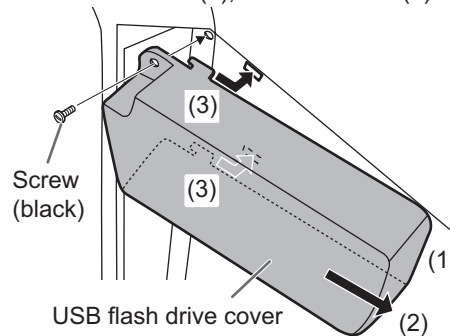

## ! Caution

- Do not touch any screws other than the black screw.  
Danger of fire or electrical shock if a screw other than the black screw is removed.

## TIPS

- If the USB flash drive will be attached, use a USB flash drive with dimensions no greater than 3-1/8 inch (80 mm) (L) × 15/16 inch (25 mm) (W) × 7/16 inch (12 mm) (H).
- To remove the USB flash drive cover, reverse the procedure. Using excessive force may break the claws. Exercise caution.

# Preparing the Remote Control Unit

Batteries and an insulation sheet are preinstalled in the remote control at the factory. Before using the remote control, be sure to remove the insulation sheet.

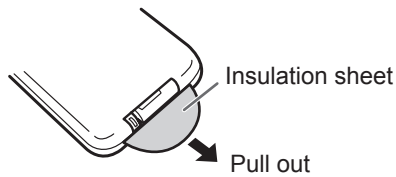

## Changing the battery

### 1. Pull out the battery case.

Press the catch on the battery case while pulling out the case.

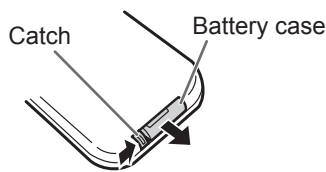

### 2. Insert the battery.

Make sure the polarities (+ and -) of the battery are oriented correctly.



### 3. Insert the battery case into the remote control.

Insert until you hear a click.

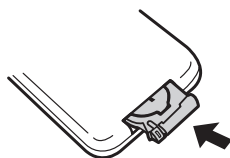

#### TIPS

- Do not use a battery other than a CR2025 battery.
- The preinstalled batteries in the remote control were installed at the factory, and therefore may become depleted before the specified usage time is reached.
- When the batteries become exhausted, replace them with new (commercially available) batteries.
- If you will not be using the remote control for a long time, remove the batteries.

## Remote control operation range

The operation range of the remote control unit is approx. 16.4 feet (5 m) at an angle of approx 10° from the center to the top/bottom/right/left of the remote control sensor.

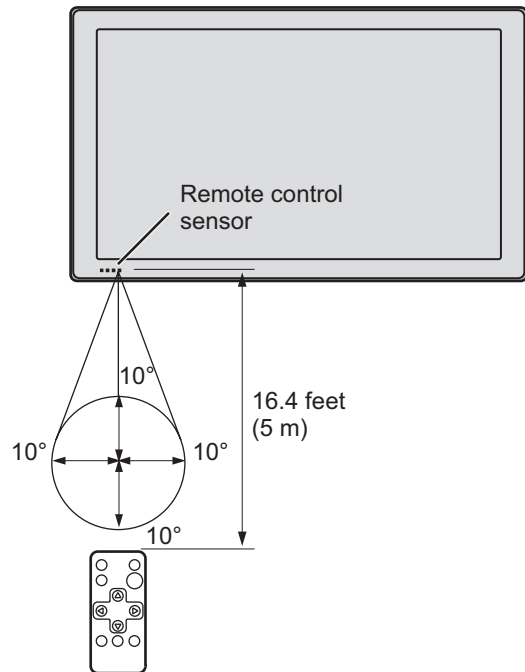

#### TIPS

- Do not expose the remote control unit to shock by dropping or stepping on it. This could lead to a malfunction.
- Do not sit with the remote control in your pants pocket. This may break the remote control.
- Do not expose the remote control unit to liquids, and do not place it in an area with high humidity.
- The remote control unit may not work properly if the remote control sensor is under direct sunlight or strong lighting.
- Objects between the remote control unit and the remote control sensor may prevent proper operation.
- Replace the batteries when they run low as this may shorten the remote control's operation range.
- If a fluorescent light is illuminated near the remote control unit, it may interfere with proper operation.
- Do not use it with the remote control of other equipment such as air conditioner, stereo components, etc.

# Turning Power On/Off

## ! Caution

- Turn on the monitor first before turning on the PC or playback device.

## Turning on the main power

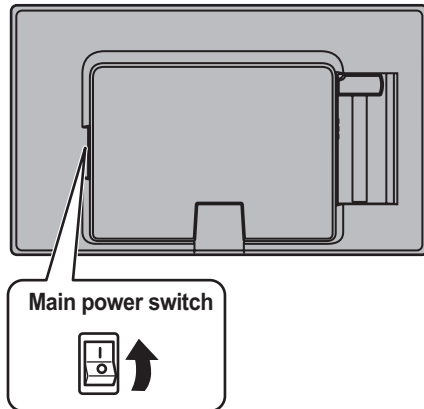

## ! Caution

- The main power must be turned on/off with the main power switch. Do not connect/disconnect the power cord or turn the breaker on/off while the main power switch is on.
- When switching the main power switch or the POWER button off and back on, always wait for at least 5 seconds.
- For a complete electrical disconnection, pull out the main plug.

## Turning power on/off

Press the POWER button or POWER switch to turn the power ON/OFF. When the main power is off, the power cannot be turned on with the POWER button.

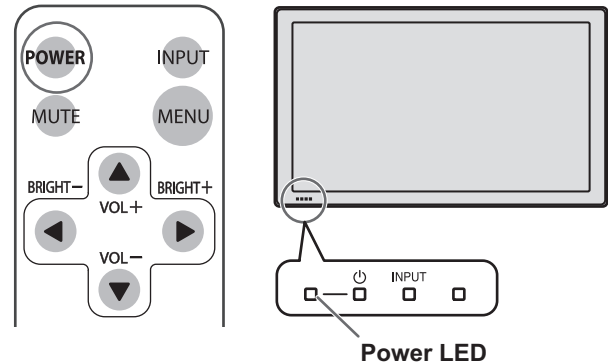

- Status of the power LED

Status	Status of the monitor
Green lit	Power on
Orange lit	Power off (Standby mode)
Green flashing	Input signal waiting mode (DVI-D or D-SUB)

## ! Caution

- When switching the main power switch or the POWER button off and back on, always wait for at least 5 seconds. A short interval may result in a malfunction.

## TIPS

- If the monitor is in the input signal standby mode and you press the POWER button on the remote control unit, the monitor enters standby mode.

## Disabling power on/off operations

Power on/power off operations can be disabled in order to protect the monitor from an accidental power off. Set the ADJUSTMENT LOCK in FUNCTION menu to "2". (See page 23.)

# Touch Action

Operations that can be performed vary depending on the OS.

	Windows XP/ Windows Vista	Windows 7
Single-tap	Yes	Yes
Double-tap	Yes	Yes
Drag-and-drop	Yes	Yes
Flicks	No	Yes
Press-and-hold	No	Yes
Pan	No	Yes
Zoom	No	Yes
Press-and-tap	No	Yes
Rotation	No	Yes

## TIPS

- In Windows 7, please make sure the checkmark for “Enable multi-touch gestures” is selected in the Control Panel.
- In Windows XP/Vista, press and hold can be set to act like a right-click in Touch Screen Calibration Utility. For details, see the Touch Panel Driver Operation Manual.

### Single-tap

Same action as left-clicking a mouse.

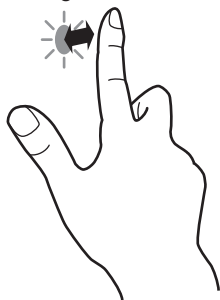

### Double-tap

Same action as double-clicking a mouse. Quickly touch twice.

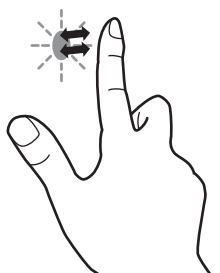

Be sure to lift your finger sufficiently off the screen after the first tap. If there is insufficient distance between the screen and your finger, double-tap will not take place.

### Drag-and-drop

Same action as drag-and-drop with a mouse. Touch the screen with your finger and move without lifting. When you have finished the movement, lift your finger.

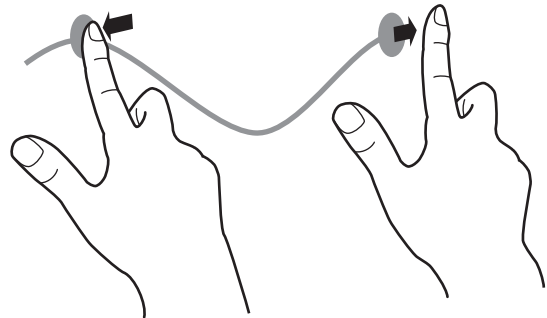

### Flicks\*

Flick your finger in the direction of the function you want to use.

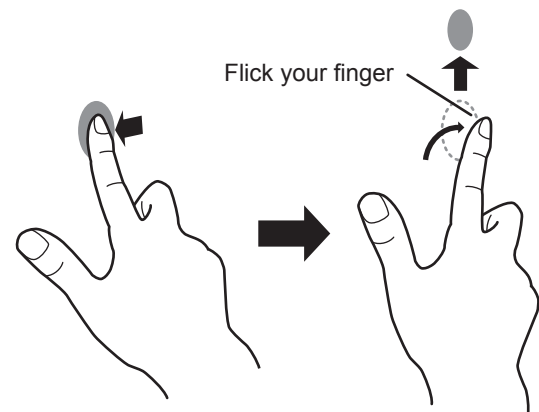

### Press-and-hold\*

Same action as right-clicking a mouse. Press briefly with your finger, and then lift your finger from the screen.

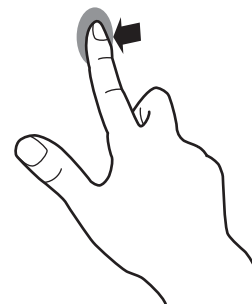

### Pan\*

Use in a screen with a scrollbar. With your finger touching the screen, move in the direction you want to scroll. The screen scrolls in the direction of the movement.

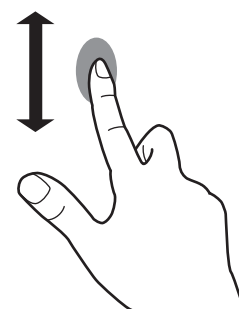

\* The settings can be changed in “Pen and touch” of Control Panel in Windows 7. For details, see Windows Help.



**Zoom**

Use in a screen that is capable of enlargement/reduction. Touch the screen with two fingers and move your fingers closer together to reduce the view, or apart to enlarge the view.

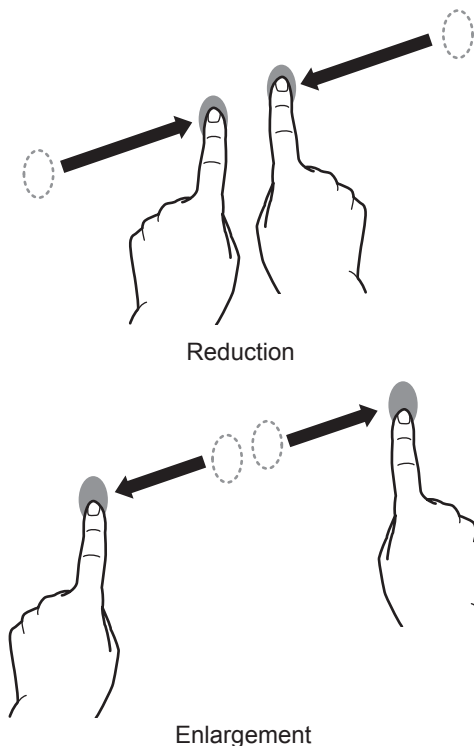
**Press-and-tap**

Same action as right-clicking a mouse. With one finger touching the screen, tap once (single tap) with another finger.

Tap once (single tap) with another finger

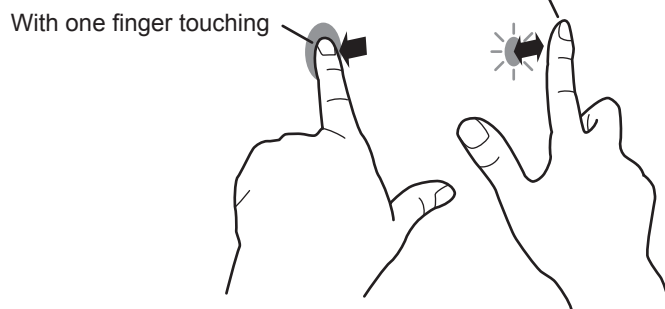
**Rotation**

Use this action in a screen that is capable of image rotation. Touch the center point of the rotation with one finger. While holding that finger still, move another finger in the desired direction of rotation.

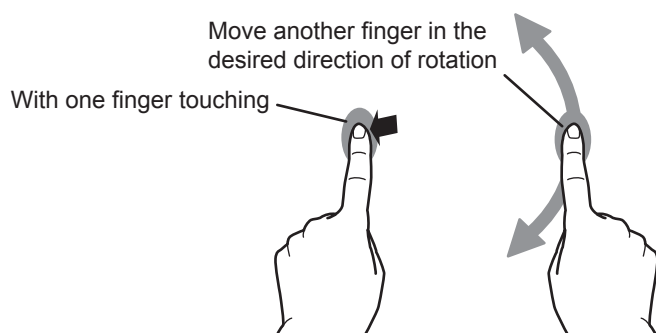
**Other functions**

In Windows 7, touch pointer and input panel functions can be used.

For information on these functions, see Windows Help.

**Touch pointer :**

A translucent image of a mouse appears near the point touched. The left/right buttons of the image can be clicked to perform the same actions as left/right clicking a mouse.

**Input panel :**

A software keyboard and an input panel with handwriting recognition appear on the screen.

In Windows 7 (excluding Starter), the ink function of Microsoft Office can be used.

Handwritten comments can be written, and handwriting can be recognized.

For details, see Microsoft Office Help.

**Cautionary points**

- Operation will not take place correctly if there is an obstacle between the sensor and your finger.
- If the USB cable becomes disconnected, the touch panel may not operate correctly after the cable is reconnected. In this case, restart your computer.
- When operating, do not touch the sensor surface or reflective surface.
- When creating content, take touch position accuracy and parallax into consideration. Make touchable objects such as buttons large and maintain sufficient space between objects.
- If there is lighting nearby, and especially if light shines on the sensor or reflective surface, operation may not take place correctly. In that case, move the display or lighting further away, or adjust the angle.

# Basic Operation

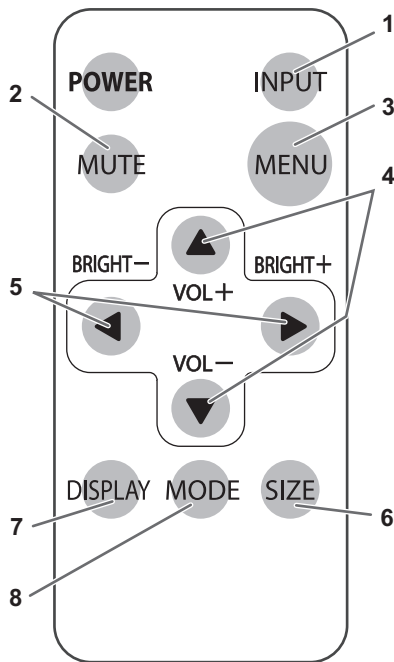

## 1. INPUT (Input mode selection)

The menu is displayed. Press ▲ or ▼ to select the input mode, and press ► to enter.

\* You can select the input terminal by pressing the input switch of the monitor.

Input mode	Video	Audio
DVI-D	PC/AV DVI-D input terminal	PC audio input terminal
D-SUB	PC D-sub input terminal	
HDMI	PC/AV HDMI input terminal	*1
COMPONENT	AV COMPONENT input terminal	AV audio input terminal
VIDEO	AV video input terminal	
USB*2	USB port	-

\*1 If audio will be not input by HDMI cable, use the PC audio input terminal.

\*2 Image and audio files in the USB flash drive can be displayed/played. For details, see page 21.

## 2. MUTE

Turns off the volume temporarily.

Press the MUTE button again to turn the sound back to the previous level.

## 3. MENU

Displays and turns off the menu screen (see page 20).

## 4. VOL +/- (Volume adjustment)

Pressing ▲ or ▼ displays the VOLUME menu when the menu screen is not displayed.



Press ▲ or ▼ to adjust the volume of the sound.

\* If you do not press any buttons for about 4 seconds, the VOLUME menu automatically disappears.

## 5. BRIGHT +/- (Backlight adjustment)

Pressing ◀ or ▶ displays the BRIGHT menu when the menu screen is not displayed.



Press ◀ or ▶ to adjust the brightness.

\* If you do not press any buttons for about 4 seconds, the BRIGHT menu automatically disappears.

## 6. SIZE (Screen size selection)

The menu is displayed.

Press ▲ or ▼ to select the screen size. (See page 17.)

\* When the input mode is USB, the screen size cannot be changed.

\* The menu disappears after about 4 seconds if you do not press any buttons.

## 7. DISPLAY

Displays monitor information. When you press this button again, the display disappears.

\* The display disappears automatically after about 15 seconds.

## 8. MODE (Color mode selection)

Each time you press this button, the color mode changes in the following order:

STD (Standard) → VIVID → sRGB → STD...

- sRGB can only be selected when the input mode is DVI-D or D-SUB.  
sRGB is international standard of color representation specified by IEC (International Electrotechnical Commission). Color conversion is made in taking account of liquid crystal's characteristics and represents color tone close to its original image.

## ■ Switching the screen size

Even when the screen size is changed, the display may remain the same depending on the input signal.

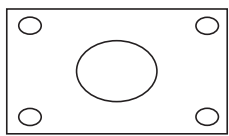
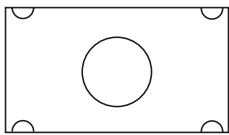
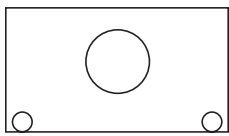
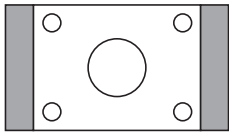
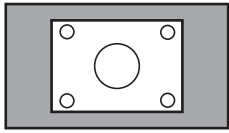
<b>WIDE</b>		Displays image so it fills the entire screen.
<b>ZOOM 1</b>		An image with a 4:3 aspect ratio is enlarged to fill the entire screen without changing the aspect ratio. The edges of the image may be cut off.
<b>ZOOM 2</b>		Use this size if ZOOM 1 cuts off the subtitles.
<b>NORMAL</b>		Displays image so it fills the screen without changing the aspect ratio of the input signals.
<b>Dot by Dot</b>		Displays the dots of the input signals as the corresponding dots on the screen.

### TIPS

- Using this monitor's screen-size switching functions to compress or expand the screen for commercial or public viewing in establishments like cafes or hotels may infringe on the rights of the creators, as protected by Copyright Law, so please be careful.
- The appearance of the original video may change if you select a screen size with a different aspect ratio than the original image (e.g. TV broadcast or video input from external equipment).
- When an ordinary non-wide image (4:3) is viewed with the whole screen using the screen-size switching function of this monitor, the edge of the image may be lost or appear distorted. If you wish to respect the creator's intentions, set the screen size to "NORMAL".
- When playing commercial software, parts of the image (like subtitles) may be cropped. In this case select the optimal screen size using the screen-size switching function of this monitor. With some software, there may be noise or distortion at the edges of the screen. This is due to the characteristics of the software, and is not a malfunction.
- Depending on the original image size, black bands may remain at the edges of the screen.

### Auto playback of image and audio files (Slideshow)

When the input mode is set to USB and a USB flash drive is inserted in the USB port, the image files in the root folder of the USB flash drive will be automatically displayed as a slideshow. If there is an audio file in the root folder, the audio file will also automatically play. If you want to present a slideshow in a different folder, see page 21.

#### TIPS

- Playback will also start automatically if you change from an input terminal other than USB to USB with a USB flash drive inserted.
- The types of files that can be played in USB flash drive are as follows:

File system	FAT16, FAT32
Image files	jpg (jpeg), png
Audio files	mp3 Bit rate: 32 kbps to 320 kbps Sampling frequency: 32kHz, 44.1kHz, 48kHz WMA Bit rate: 32 kbps to 192 kbps Sampling frequency: 32kHz, 44.1kHz, 48kHz (WMA9 files are not supported.)

- In some cases it may not be possible to play the above files.
- It may take time to reproduce a large-data or high-resolution image. In some cases, reproduction may not be possible.
- An image file that includes application-specific information may not display correctly.
- A png file with a transparency setting may not display correctly.
- Use half-width alphanumeric characters for the folder name or file name. It may not be displayed correctly.
- Up to 600 files can be handled in the slideshow folder.
- When file names or folder names are long, some characters may not appear in the list screen.
- If there are no image files in the root folder of the USB flash drive, the list screen will appear (see page 21).
- In PowerPoint, files can be saved in jpeg or png format.
- To change data transfer to the USB flash drive or the order of slideshow display, use the USB Flash Drive Media Tool on the CD-ROM. For details, refer to "USB Flash Drive Media Tool Operation Manual".
- During a slideshow, the remote control or some buttons may not respond when operated.  
This is caused by the heavy image processing load and is not due to a product failure or problem.

# Menu Items

## Displaying the menu screen

Video and audio adjustment and settings of various functions are enabled. This section describes how to use the menu items. See pages 20 to 21 for details of each menu items.

### ! Caution

- Do not turn the main power switch off while the menu items are being displayed. Doing so may initialize the settings.

## Example of operation

(Adjusting CONTRAST in the PICTURE menu)

- Press **MENU** to display the menu screen.

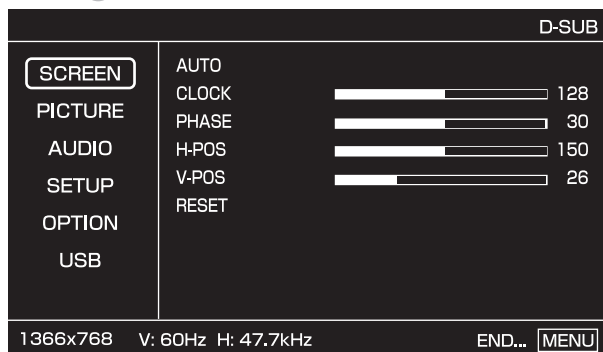

- Press **▲** or **▼** to select PICTURE, and press **▶**.

- Press **▲** or **▼** to select CONTRAST.

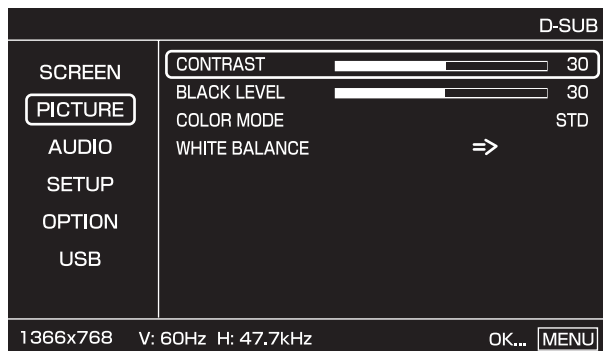

- Press **◀** or **▶** to adjust the setting.

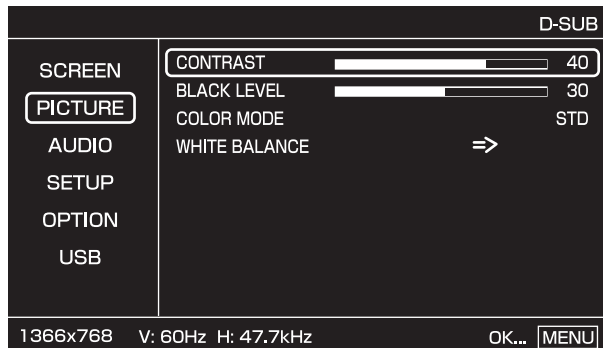

For items that have **=>**, press **▶**, make settings and then press **MENU**.

- Press **MENU** twice to close the menu screen.

### TIPS

- The menu will differ depending on the input mode.
- The menu screen will close automatically if no operation is performed for about 15 seconds.

## Menu screen display

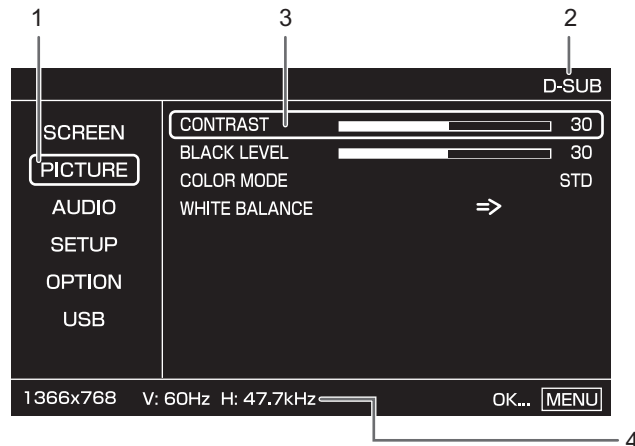

- Name of the menu
- Input mode
- An item being selected
- Screen resolution of input signal, and other data. Does not appear when the input mode is USB.

### TIPS

- Items that cannot be selected appear in gray. (e.g. Function not supported by the current input signal)

## Menu Items

### Menu item details

The menu will differ depending on the input mode.

#### ■SCREEN (D-SUB input)

##### AUTO

The CLOCK, PHASE, H-POS, and V-POS are automatically adjusted.

Pressing **▶** performs adjustment.

Use this automatic adjustment when you use the PC D-sub input terminal to display a PC screen for the first time or when you change the setting of the PC. (See page 22.)

##### CLOCK

Adjusts frequency for sampling clock for applicable video. Adjust when there is flickering in the form of vertical stripes. When using the adjustment pattern (see page 22), make adjustments so that no vertical stripe noise appears in it.

##### PHASE

Adjusts sampling clock phase for applicable video.

Useful when small characters appear with low contrast and/or there are flickers at corners.

When using the adjustment pattern (see page 22), make adjustments so that no horizontal stripe noise appears in it.

\* Adjustments to PHASE should be made only after CLOCK has been correctly set.

##### H-POS

Adjust the horizontal position of the image.

##### V-POS

Adjust the vertical position of the image.

##### RESET

Press **▶** to reset the values of the SCREEN menu items to the factory preset values.

#### ■PICTURE

##### CONTRAST

Adjusts the brightness of the image.

##### BLACK LEVEL

Adjusts the entire brightness of the video signals.

##### TINT (AV signal input)

Adjusts the hue. Selecting + changes the color towards green, and selecting - changes it towards magenta.

##### COLORS (AV signal input)

Adjusts the color intensity.

##### SHARPNESS (AV signal input)

Adjusts the sharpness of the image.

##### NOISE REDUCTION (AV signal input)

Reduces noise that mixes with the image.

##### COLOR MODE

Changes the color mode on the screen. The color mode on the screen can also be changed using a remote control unit. (See page 16.)

\* sRGB can only be selected when the input mode is DVI-D or D-SUB. See page 16 for details.

##### WHITE BALANCE

Selects the white balance when COLOR MODE is set to VIVID or STD.

Adjusts each item when the WHITE BALANCE is set to USER.

R-CONTRAST..... Adjusts red component.

G-CONTRAST ..... Adjusts green component.

B-CONTRAST..... Adjusts blue component.

#### ■AUDIO

##### TREBLE

Adjusts the volume of treble-level sound.

##### BASS

Adjusts the volume of bass-level sound.

##### BALANCE

Adjusts the balance of the audio sound between right and left.

## ■SETUP

### THERMAL SENSOR SETTING

Sets the orientation of the temperature sensor. Change this setting if you change the installation orientation (vertical or horizontal) of the monitor.

LANDSCAPE..... horizontal orientation

PORTRAIT ..... vertical orientation

### LANGUAGE

Sets the display language for the menu screen.

## ■OPTION

### COLOR SYSTEM

Sets the color system (PAL / PAL-60 / SECAM / NTSC (3.58) / NTSC (4.43)) that is sent from the AV device connected to the AV video input terminal. If AUTO does not operate correctly, specify an appropriate color system.

### AUDIO OUTPUT

Sets the volume of sound output from the audio output terminal.

When set to VARIABLE 2, sound will not be output from the built-in speaker.

VARIABLE1 ..... You can adjust the volume using VOLUME.

VARIABLE2 ..... You can adjust the volume using VOLUME.

FIXED ..... Fixes the sounds.

### INPUT SIGNAL (D-SUB input)

If a computer connected to the PC D-sub input terminal outputs any of the following resolutions, make a selection from the following options.

480 LINES ..... AUTO, 640x480 or 848x480

768 LINES ..... AUTO, 1024x768, 1280x768, 1360x768, or 1366x768

1050 LINES ..... 1400x1050 or 1680x1050

## ■USB

### EFFECT

Selects the effect when the images in the USB flash drive are shown as a slideshow.

### INTERVAL

Sets the interval between slides.

Depending on the format and size of the image files, the interval may not always be fixed.

### LIST

Shows the list screen. In the list screen, you can change the folder used for the slideshow.

## List screen

### ■Specifying a folder and presenting a slideshow

In the list screen, you can specify the folder to be used for a slideshow.

If you want to play music while presenting the slideshow, select the audio file first and then the image file.

**Example : Presenting a slideshow of the data in the Folder A.**

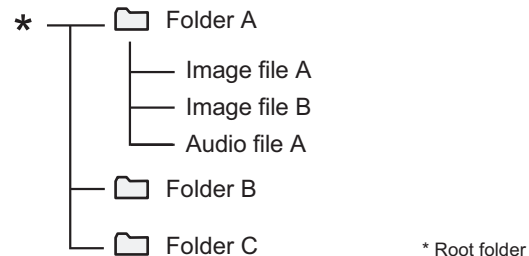

Start from the list screen. If the list screen does not appear, select LIST in the USB menu to display the list screen.

**1. Move the cursor to the root folder and press ▲ or ▼ to select "Folder A".**

**2. Press ► to display "Folder A".**

To move back up to the previous level, press ◀.

**3. Select audio file.**

If you do not want to play music, go to step 4.

(1) Press ▲ or ▼ to select "Audio file A".

(2) Press ►.

- The music plays. The audio files in the folder are played in order.

- To stop playback, press ◀.

**4. Select Image file.**

(1) Press ▲ or ▼ to select "Image file A".

- You can select image file that is in a different folder. Select the folder and then press ►.

To move back up to the previous level, press ◀.

(2) Press ►.

- The slideshow starts. The image files in the folder are displayed in order.

### TIPS

- If there are a large number of files, it is convenient to store the image files and audio files in separate folders.
- "Album" and "Year" information is not displayed for WMA files.

### Adjustments for PC screen display

#### ■ Automatic adjustment

When you use the PC D-sub input terminal to display a PC screen for the first time, or when you change the setting of the PC, use the automatic screen adjustment.

1. **Switch the input to D-SUB and display the adjustment pattern.** (See the description below.)
  2. Press **MENU** and use **▲** or **▼** to display the **SCREEN** menu.
  3. Press **▶** and select **"AUTO"**.
  4. Press **▶**.
- The automatic adjustment is complete in several seconds.
5. Press **MENU** twice to close the menu screen.

#### TIPS

- If the screen cannot be adjusted properly with one automatic adjustment, repeat the automatic adjustment two or three times. Try manual adjustment if necessary.

#### ■ Screen display for adjustment

Before making adjustments in the **SCREEN** menu or **PICTURE** menu, display an image to brighten the entire screen. If you are using a Windows PC, use the adjustment pattern on the supplied CD-ROM.

#### Opening the adjustment pattern

The following example is performed in Windows 7.

1. **Load the supplied CD-ROM into the computer's CD-ROM drive.**
2. **Open [CD Drive] in [Computer].**  
In Windows XP, open [CD Drive] in [My Computer].
3. **Double-click [Adj\_uty.exe] in the [Monitor] folder.**  
The adjustment pattern will appear.  
Adjust the screen automatically or manually.

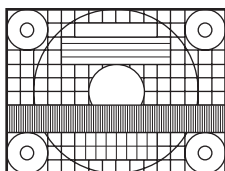

4. **When adjustment is finished, press the [Esc] on the computer's keyboard to quit the adjustment program.**
5. **Eject the CD-ROM from the CD-ROM drive.**

#### TIPS

- If the display mode on the computer you are using is 65,000 colors, the color levels in the color pattern may appear differently or grayscale may appear to be colored. (This is due to the specifications of the input signal and is not a malfunction.)



# Initialization/Functional Restriction Setting (FUNCTION Menu)

You can return the settings to their factory-preset values and restrict operations.

1. After pressing **SIZE** for about 5 seconds, press **▲**, **▶**, **▼**, and **◀** in that order.

D-SUB	
<b>FUNCTION</b>	ALL RESET
	ADJUSTMENT LOCK OFF
	RS-232C UNLOCKED
	OSD DISPLAY ON
	LED ON
	TEMPERATURE ALERT LED

1366x768 V: 60Hz H: 47.7kHz END... **MENU**

2. Press **▶**.
3. Select and set the items.

## ALL RESET

Press **▶**, to reset the settings to the factory default settings.

After initialization, turn the main power switch off and then back on.

## ADJUSTMENT LOCK

You can disable operations on the monitor and the remote control unit that use buttons.

OFF ... Enables operation.

- 1..... Disables all operations other than turning power on/off and FUNCTION menu.
- 2..... Only the FUNCTION menu operation is enabled. Disables all operations other than FUNCTION menu (not even power on/off).

## RS-232C

Specifies whether to allow control via RS-232C (see page 24).

## OSD DISPLAY

Shows (ON) / hides (OFF) menus and other screens. The FUNCTION menu screen appears regardless of the setting.

## LED

Specifies whether to light the power LED.

## TEMPERATURE ALERT

Selects the notification method for an abnormal temperature.

- OFF ..... Do not notify about an abnormal temperature.
- OSD & LED .. When an abnormal temperature is detected, the power LED flashes in red and green alternately and the screen displays a message: TEMPERATURE.
- LED..... When an abnormal temperature is detected, the power LED flashes in red and green alternately.

4. Press **MENU** twice to return to the normal screen.

# Controlling the Monitor with a PC (RS-232C)

You can control this monitor from a PC via RS-232C (COM port) on the PC.

## PC connection

Connect with RS-232 straight cable between the PC's COM port (RS-232C connector) and the RS-232C input terminal on the monitor.

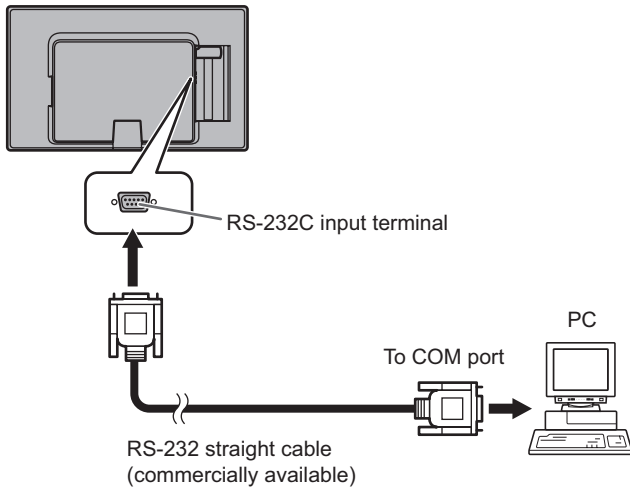

## Communication conditions

Set the RS-232C communication settings on the PC to match the monitor's communication settings as follows:

Baud rate	9600 bps
Data length	8 bits
Parity bit	None

Stop bit	1 bit
Flow control	None

## Communication procedure

### ■ Command format

When a command is sent from the PC to the monitor, the monitor operates according to the received command and sends a response message to the PC.

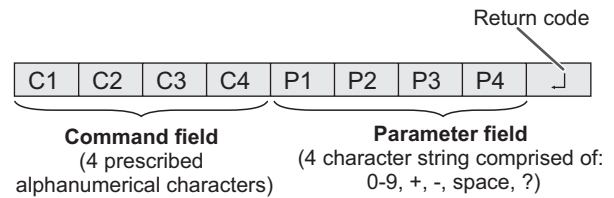

Example: VOLM0030  
VOLM \_ \_ 30

- \* Be sure to input 4 characters for the parameter. Pad with spaces (" ") if necessary.  
(" " is a return code (0DH, 0AH or 0DH))  
Wrong : VOLM30  
Right : VOLM \_ \_ 30

If a command has "R" listed for "DIRECTION" in the "RS-232C command table" on page 26, the current value can be returned by using "?" as the parameter.

Example:

VOLM ? ? ? ?	←	From PC to monitor (How much is current volume setting?).
30	←	From monitor to PC (Current volume setting: 30).

## ■Response code format

When a command has been executed correctly

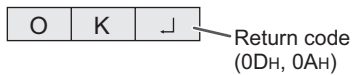

A response is returned after a command is executed.

When a command has not been executed

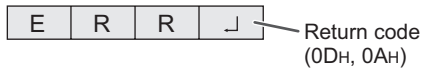

### TIPS

- “ERR” is returned when there is no relevant command or when the command cannot be used in the current state of the monitor.
- If communication has not been established for reasons such as a bad connection between the PC and monitor, nothing is returned (not even ERR).

If execution of the command is taking some time



When the following commands are used, “WAIT” is returned. In this case, a value will be returned if you wait a while. Do not send any command during this period.

- Commands which return WAIT:  
When one of the following commands is used:  
RSET, INPS, ASNC, WIDE, POWR

When control via RS-232C is locked (to prevent use) using the operation lock function (see page 23)



## ■Communication interval

- After OK or ERR is returned, you must send the following commands.  
To set a timeout for the command response, specify 10 seconds or longer.
- Provide an interval of 100 ms or more between the command response and the transmission of the next command.

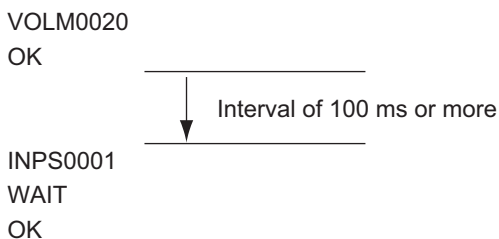

### TIPS

- When executing ALL RESET, set the timeout period to 30 seconds or longer.

## Controlling the Monitor with a PC (RS-232C)

### RS-232C command table

#### How to read the command table

- Command: Command field (See page 24.)
- Direction: W When the "Parameter" is set in the parameter field (see page 24), the command functions as described under "Control/Response Contents".  
R The returned value indicated under "Reply" can be obtained by setting "???" or "???" in the parameter field (see page 24).
- Parameter: Parameter field (See page 24.)
- Reply: Response (Returned value)
- \*: "Yes" indicates a command which can be used in power standby mode.  
"No" indicates a command which cannot be used in power standby mode.

### Power control/Input mode selection

Function	Command	Direction	Parameter	Reply	Control/Response contents	*
POWER CONTROL	POWR	W	0		Switches to standby mode.	Yes
			1		Returns from standby mode.	
		R		0	Standby mode	
				1	Normal mode	
				2	Input signal waiting mode	
INPUT MODE SELECTION	INPS	W	0		Toggle change for input mode.	Yes
			1		DVI-D	
			2		D-SUB	
			3		COMPONENT	
			4		VIDEO	
			9		HDMI	
			11		USB	
			R		1	
				2	D-SUB	
				3	COMPONENT	
				4	VIDEO	
				9	HDMI	
				11	USB	

### SCREEN menu

Function	Command	Direction	Parameter	Reply	Control/Response contents	*
AUTO	ASNC	W	1		Only when the input mode is D-SUB.	No

### PICTURE menu

Function	Command	Direction	Parameter	Reply	Control/Response contents	*
COLOR MODE	BMOD	WR	0	0	STD	No
			2	2	VIVID	
			3	3	sRGB (DVI-D, D-SUB input only)	

### SETUP menu

Function	Command	Direction	Parameter	Reply	Control/Response contents	*
THERMAL SENSOR SETTING	STDR	WR	0	1	LANDSCAPE (Horizontal orientation)	No
			1	1	PORTRAIT (Vertical orientation)	

### FUNCTION (Initialization/Functional Restriction Setting) menu

Function	Command	Direction	Parameter	Reply	Control/Response contents	*
ALL RESET	RSET	W	0		All reset	No
ADJUSTMENT LOCK	ALCK	WR	0-2	0-2	0: OFF	

## Controlling the Monitor with a PC (RS-232C)

### Others

Function		Command	Direction	Parameter	Reply	Control/Response contents	*
SCREEN SIZE (DVI-D, D-SUB)		WIDE	WR	1-5	1-5	1: WIDE, 2: NORMAL, 3: Dot by Dot, 4: ZOOM1, 5: ZOOM2	No
SCREEN SIZE (HDMI, COMPONENT, VIDEO)		WIDE	WR	1-5	1-5	1: WIDE, 2: ZOOM1, 3: ZOOM2, 4: NORMAL, 5: Dot by Dot	
VOLUME		VOLM	WR	0-31	0-31		
MUTE		MUTE	WR	0-1	0-1	0: OFF, 1: ON	
INFORMATION	MODEL	INF1	R		Value		Yes
	SERIAL NO	SRNO	R		Value		
BRIGHT		VLMP	WR	0-31	0-31		No
TEMPERATURE SENSOR		DSTA	R			0 Internal temperature normal	Yes
						1 Internal temperature abnormal (Standby mode)	
						2 Internal temperature abnormal (Temperature is normal now, but it was abnormal during operation.)	
						3 Internal temperature abnormal (Brightness of the backlight decreases.)	
						4 Temperature sensor abnormal	
TEMPERATURE ACQUISITION		ERRT	R		Value	Temperature at temperature sensors are returned in the following forms: [Sensor 1], [Sensor 2], [Sensor 3] This monitor does not have sensors 2 and 3. All return the same value as sensor 1. Indicates a temperature sensor abnormality when "126" is returned.	No
CAUSE OF LAST STANDBY MODE		STCA	W	0		Initialization	Yes
			R		0 No detectable error has occurred		
					1 Standby mode by POWER button		
					2 Main power off by the main power switch		
					3 Standby mode by RS-232C		
					4 Waiting mode by No Signal		
					6 Standby mode by abnormal temperature		

# Troubleshooting

If you are experiencing any problem with your display, before calling for service, please review the following troubleshooting tips.

## **There is no picture or sound.**

- Is the power cord disconnected? (See page 10.)
- Is the main power switch off? (See page 13.)
- Is the monitor in standby mode (the power LED illuminating in orange)? (See page 13.)
- Make sure correct input mode is selected. (See page 16.)
- If any external equipment is connected, make sure the equipment is operating (playing back).

## **Remote control does not work.**

- Are the batteries inserted with polarity (+,-) aligned? (See page 12.)
- Are the batteries exhausted?
- Point the remote control unit toward the monitor's remote control sensor. (See page 12.)
- Is the menu display hidden or is operation disabled? (See page 23.)

## **Sound from left and right speakers is reversed.**

### **Sound is heard from only one side.**

- Are audio cables connected properly? (See pages 9.)
- Check the setting of BALANCE for AUDIO menu. (See page 20.)

## **There is no sound.**

- Is the sound muted?
- Make sure the volume is not set to minimum.
- Are audio cables connected properly?
- When a video signal is not input, sound is not output.

## **Unstable video.**

- The signal may be incompatible.
- Try the automatic screen adjustment when the PC D-sub input terminal is used.

## **The video from the PC/AV HDMI input terminal does not appear properly.**

- Is the HDMI cable HDMI standard compliant? The monitor will not work with cables that are not standard compliant.
- Is the input signal compatible with this monitor? (See pages 31 and 32.)

## **The video from the PC/AV DVI-D input terminal does not appear properly.**

- Is the input signal compatible with this monitor? (See pages 31 and 32.)
- Turn off the power to the connected equipment and then turn the power on again.

## **The video from the AV COMPONENT input terminal does not appear properly.**

- Is the input signal compatible with this monitor? (See page 32.)

## **Control buttons do not work.**

### **There is no picture.**

- Load noises from outside may be interfering with normal operation. Turn off the power and turn it on after waiting at least 5 seconds, and then check the operation.

## **When "AUTO DIMMING" is displayed.**

- When the internal temperature of the monitor rises excessively, the brightness of the backlight automatically decreases in order to prevent a further temperature rise. If you attempt to use ◀ ▶ to adjust the brightness while the monitor is in this state, "AUTO DIMMING" is displayed and you cannot change the brightness.
- Remove the cause of the excessive temperature rise.

## **The monitor makes a cracking sound.**

- You may occasionally hear a cracking sound from the monitor. This happens when the cabinet slightly expands and contracts according to change in temperature. This does not affect the monitor's performance.

## **The touch panel does not respond.**

- Is the USB cable connected properly? (Touch Panel Driver Operation Manual)
- Has the touch panel driver been installed? (Touch Panel Driver Operation Manual)
- If you press hard on the monitor or apply force to the sensor area, sensor correction processing will take place. During this time (several tens of seconds), the touch panel will not respond.

## **The response of the touch screen is slow.**

### **Some parts of the screen do not respond.**

- Is the screen exposed to direct sunlight or other strong light? Is a device that uses infrared being used nearby? The touch panel uses infrared rays and thus may not operate correctly.
- Is there an obstacle between the sensor and your finger? An obstacle will prevent correct operation.
- Is the reflective surface dirty? Gently wipe off any dirt with a soft cloth.
- If the touch panel is touched with a small tip less than about 1/4 inch (7 mm) x 1/4 inch (7 mm), the touch may not be detected and correct operation will not take place.
- When starting your computer or connecting the USB cable, do not touch the touch panel.

## **The Power LED is flashing in red and green alternately.**

### **When "TEMPERATURE" is displayed in the corner of the screen.**

- When the internal temperature of the monitor rises excessively, the brightness of the backlight decreases automatically in order to prevent high-temperature-related problems. When this occurs, "TEMPERATURE" is displayed on the screen and the Power LED flashes red and green alternately. (When TEMPERATURE ALERT is set to OSD & LED. This varies depending on the setting.)
- If the internal temperature rises further, the monitor automatically enters standby mode. (The Power LED continues flashing red and green alternately.)
- Remove the cause of the excessive temperature rise.
  - If the monitor enters standby mode due to a rise in temperature, to return to normal display, turn the power switch off and then back on again. The monitor, however, will enter standby mode again if the cause of the temperature rise is not eliminated. (See page 5.)
  - Check whether the monitor is placed at a location where a quick rise in temperature is likely. Internal temperature rises quickly if the vents on the monitor are blocked.
  - Internal temperature rises quickly if dust accumulates inside the monitor or around the vents. Remove dust if possible. Ask Sharp dealer about removing internal dust.

# Specifications

## ■Product Specifications

Model	PN-T322B		
LCD component	32" Class [31-1/2 inch (80 cm) diagonal] TFT LCD		
Max. resolution	(pixels)	1366 x 768	
Max. colors	Approx. 16.77 million colors		
Pixel pitch	0.511 mm (H) × 0.511 mm (V)		
Viewing angle	176° right/left/up/down (contrast ratio ≥ 10)		
Screen active area	inch (mm)	27-7/16 x 15-7/16 (697.7 x 392.3)	
Computer input signal	Digital (DVI 1.0 standard-compliant), Analog RGB (0.7 Vp-p) [75 Ω]		
Sync signal	Horizontal/vertical separate (TTL: positive/negative), Sync-on-green, Composite sync (TTL: positive/negative)		
Video color system	NTSC (3.58MHz)/NTSC (4.43MHz)/PAL/PAL-60/SECAM		
Plug and play	VESA DDC2B		
Power management	VESA DPMS, DVI DMPM		
Input terminals	Digital	HDMI x 1	
		DVI-D 24 pin (HDCP compatible) x 1	
	Analog	Mini D-sub 15 pin, 3 rows x 1	
	Composite video	RCA pin x 1 *1	
	Component	RCA pin (Y, Cb/Pb, Cr/Pr) x 1 *2	
	Audio	3.5 mm mini stereo jack x 1	
		RCA pin (L/R) x 1 *1	
	Serial (RS-232C)	D-sub 9 pin x 1	
USB flash drive	x 1 (for slideshow)		
Output terminal	Audio	3.5 mm mini stereo jack x 1	
Speaker output	8 W + 8 W		
Touch Panel	Detection method	Infrared camera method	
	Detection area	inch (mm)	27 x 15 (685.7 x 380.3)
	PC connector	USB (1.1 compliant)	
	Power supply	Supplied from USB	
	Position accuracy	inch (mm)	±1/4 (±6)
Power requirement	AC 100 V - 240 V, 50/60 Hz		
Operating temperature *3	41°F to 95°F (5°C to 35°C)		
Operating humidity	20% to 80% (no condensation)		
Power consumption	82 W		
(input signal waiting mode*4 / standby mode)	(0.9 W / 0.9 W)		
Dimensions (excluding protrusions)	inch (mm)	Approx. 30-1/4 (W) x 2-7/16 (D) x 18-1/8 (H) (769 x 62 x 461)	
Weight	lbs. (kg)	Approx. 24.3 (11)	

\*1 Uses the provided conversion cable (for AV video).

\*2 Uses the provided conversion cable (for AV component).

\*3 Temperature condition may change when using the display together with the optional equipments recommended by SHARP. In such cases, please check the temperature condition specified by the optional equipments.

\*4 D-SUB input (factory default setting)

As a part of our policy of continuous improvement, SHARP reserves the right to make design and specification changes for product improvement without prior notice. The performance specification figures indicated are nominal values of production units. There may be some deviations from these values in individual units.

# Specifications

## ■ Dimensional Drawings

Note that the values shown are approximate values.

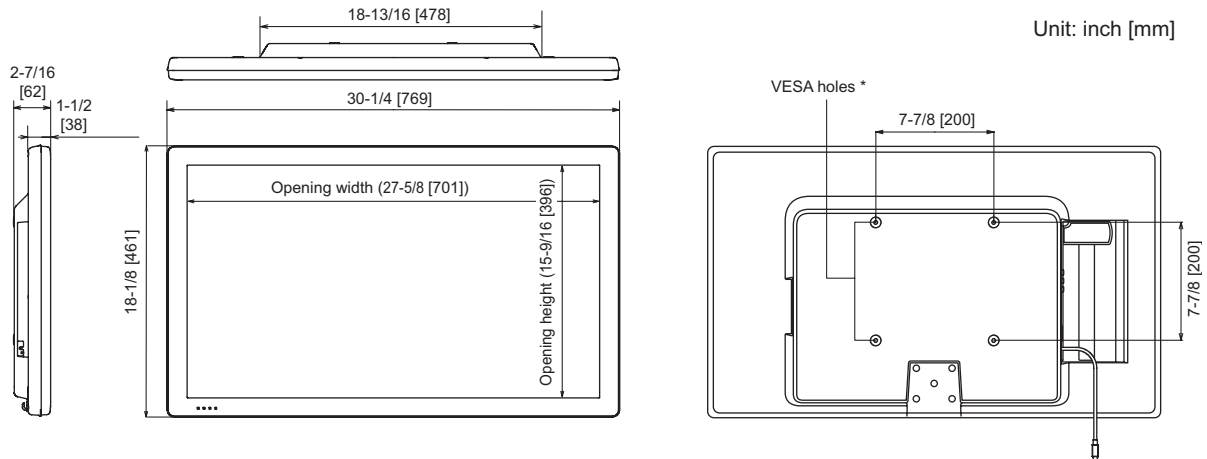

When mounting the monitor, be sure to use a wall-mount bracket that complies with the VESA-compatible mounting method. SHARP recommends using M6 screws and tighten the screws. Note that screw hole depth of the monitor is 3/8 inch (10 mm). Loose mounting may cause the product to fall, resulting in serious personal injuries as well as damage to the product. The screw and hole should come together with over 5/16 inch (8 mm) length of thread. Use a bracket which has been approved for UL1678 standard, and which can endure at least 4 times or more the weight of the monitor.

## ■ Power management

This monitor conforms to VESA DPMS and DVI DMPM. Both your video card and computer must support the same standard in order for the monitor's power management function to work.

DPMS: Display Power Management Signaling

DPMS	Screen	Power consumption	Hsync	Vsync
ON STATE	Display	82 W	Yes	Yes
STANDBY	No display	0.9 W	No	Yes
SUSPEND			Yes	No
OFF STATE			No	No

DMPM: Digital Monitor Power Management

DMPM	Screen	Power consumption
Monitor ON	Display	82 W
Active OFF	No display	10 W

## ■ DDC (plug and play)

The monitor supports the VESA DDC (Display Data Channel) standard.

DDC is a signal standard for plug and play between monitors and computers. Information about resolution and other parameters is exchanged between the two. This function can be used if the computer supports DDC and it has been configured to detect plug-and-play monitors.

There are several types of DDC, depending on the communication method used. This monitor supports DDC2B.



■Compatible signal timing (PC)

Screen resolution		Hsync	Vsync	Dot frequency	Digital		Analog
					DVI-D	HDMI	
VESA	640 × 480	31.5kHz	60Hz	25.175MHz	Yes	Yes	Yes
		37.9kHz	72Hz	31.5MHz	Yes	Yes	Yes
		37.5kHz	75Hz	31.5MHz	Yes	Yes	Yes
	800 × 600	35.1kHz	56Hz	36.0MHz	-	-	Yes
		37.9kHz	60Hz	40.0MHz	Yes	Yes	Yes
		48.1kHz	72Hz	50.0MHz	Yes	Yes	Yes
		46.9kHz	75Hz	49.5MHz	Yes	Yes	Yes
	848 × 480	31.0kHz	60Hz	33.75MHz	Yes	-	Yes
	1024 × 768	48.4kHz	60Hz	65.0MHz	Yes	Yes	Yes
		56.5kHz	70Hz	75.0MHz	Yes	Yes	Yes
		60.0kHz	75Hz	78.75MHz	Yes	Yes	Yes
	1152 × 864 <sup>*1</sup>	67.5kHz	75Hz	108.0MHz	Yes	Yes	Yes
	1280 × 768	47.8kHz	60Hz	79.5MHz	Yes	-	Yes
		60.3kHz	75Hz	102.25MHz	Yes	-	Yes
	1280 × 800 <sup>*1</sup>	49.7kHz	60Hz	83.5MHz	Yes	Yes	Yes
	1280 × 960 <sup>*1</sup>	60.0kHz	60Hz	108.0MHz	Yes	Yes	Yes
	1280 × 1024 <sup>*1</sup>	64.0kHz	60Hz	108.0MHz	Yes	Yes	Yes
		80.0kHz	75Hz	135.0MHz	Yes	Yes	Yes
	1360 × 768	47.7kHz	60Hz	85.5MHz	Yes	Yes	Yes
1400 × 1050 <sup>*1</sup>	65.3kHz	60Hz	121.75MHz	Yes	Yes	Yes	
1440 × 900 <sup>*1</sup>	55.9kHz	60Hz	106.5MHz	Yes	-	Yes	
1600 × 1200 <sup>*1</sup>	75.0kHz	60Hz	162.0MHz	Yes	Yes	Yes	
1680 × 1050 <sup>*1</sup>	65.3kHz	60Hz	146.25MHz	Yes	Yes	Yes	
Wide	1280 × 720	44.7kHz	60Hz	74.4MHz	Yes <sup>*2</sup>	Yes <sup>*2</sup>	Yes
	1366 × 768	47.7kHz	60Hz	85.383MHz	Yes	Yes	Yes
	1920 × 1080 <sup>*1</sup>	66.3kHz	60Hz	148.5MHz	Yes	Yes	Yes
		67.5kHz	60Hz	148.5MHz	Yes <sup>*3</sup>	Yes <sup>*3</sup>	Yes
US TEXT	720 × 400	31.5kHz	70Hz	28.3MHz	Yes	Yes	Yes
Sun	1024 × 768	48.3kHz	60Hz	64.13MHz	-	-	Yes
		53.6kHz	66Hz	70.4MHz	-	-	Yes
		56.6kHz	70Hz	74.25MHz	-	-	Yes
	1152 × 900 <sup>*1</sup>	61.8kHz	66Hz	94.88MHz	-	-	Yes
		71.8kHz	76.2Hz	108.23MHz	-	-	Yes
	1280 × 1024 <sup>*1</sup>	71.7kHz	67.2Hz	117.01MHz	-	-	Yes
		81.1kHz	76Hz	134.99MHz	-	-	Yes
1600 × 1000 <sup>*1</sup>	68.6kHz	66Hz	135.76MHz	-	-	Yes	

\*1 Displays a reduced image, except in Dot by Dot. In Dot by Dot, the image will be cut down to panel size then displayed.

\*2 Displays as an AV signal (1280 x 720p).

\*3 Displays as an AV signal (1920 x 1080p).

- \* All are compliant only with non-interlaced.
- \* Depending on the connected PC, images may not be displayed properly even if the compatible signal described above is input.
- \* The frequency values for the Sun are reference values.

# Specifications

## Compatible signal timing (AV)

Screen resolution	Frequency	DVI-D	HDMI	Component
1920 × 1080p *	24Hz	-	Yes	-
	50Hz	Yes	Yes	Yes
	59.94Hz	Yes	Yes	Yes
	60Hz	Yes	Yes	Yes
1920 × 1080i *	50Hz	Yes	Yes	Yes
	59.94Hz	Yes	Yes	Yes
	60Hz	Yes	Yes	Yes
1280 × 720p	50Hz	Yes	Yes	Yes
	59.94Hz	Yes	Yes	Yes
	60Hz	Yes	Yes	Yes
720 × 576p	50Hz	Yes	Yes	Yes
720 × 480p	59.94Hz	Yes	Yes	Yes
	60Hz	Yes	Yes	Yes
720(1440) × 576i	50Hz	-	Yes	Yes
720(1440) × 480i	59.94Hz	-	Yes	Yes
	60Hz	-	Yes	Yes

\* Displays a reduced image, except in Dot by Dot. In Dot by Dot, the image will be cut down to panel size then displayed.

## PC/AV DVI-D input terminal pins

(DVI-D 24 pin)

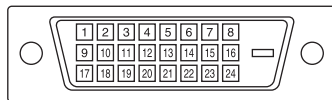

No.	Function	No.	Function
1	TMDS data 2-	13	N.C.
2	TMDS data 2+	14	+5V
3	TMDS data 2/4 shield	15	GND
4	N.C.	16	Hot-plug detection
5	N.C.	17	TMDS data 0-
6	DDC clock	18	TMDS data 0+
7	DDC data	19	TMDS data 0/5 shield
8	N.C.	20	N.C.
9	TMDS data 1-	21	N.C.
10	TMDS data 1+	22	TMDS clock shield
11	TMDS data 1/3 shield	23	TMDS clock+
12	N.C.	24	TMDS clock-

## PC/AV HDMI input terminal pins

(HDMI™ Connector)



No.	Function	No.	Function
1	TMDS data 2+	11	TMDS clock shield
2	TMDS data 2 shield	12	TMDS clock-
3	TMDS data 2-	13	CEC
4	TMDS data 1+	14	N.C.
5	TMDS data 1 shield	15	SCL
6	TMDS data 1-	16	SDA
7	TMDS data 0+	17	DDC/CEC GND
8	TMDS data 0 shield	18	+5V
9	TMDS data 0-	19	Hot-plug detection
10	TMDS clock+		

## PC D-sub input terminal pins

(Mini D-sub 15 pin)

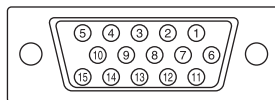

No.	Function	No.	Function
1	Red video signal input	9	+5V
2	Green video signal input	10	GND
3	Blue video signal input	11	N.C.
4	N.C.	12	DDC data
5	GND	13	Hsync signal input
6	GND for red video signal	14	Vsync signal input
7	GND for green video signal	15	DDC clock
8	GND for blue video signal		

## RS-232C input terminal pins

(D-sub 9 pin)

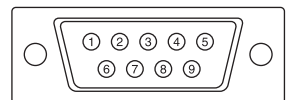

No.	Function	No.	Function
1	N.C.	6	N.C.
2	Transmitted data	7	N.C.
3	Received data	8	N.C.
4	N.C.	9	N.C.
5	GND		

**SHARP**<sup>®</sup>  
SHARP CORPORATION

PN-T322B M EN11D(1)

## Free Manuals Download Website

<http://myh66.com>

<http://usermanuals.us>

<http://www.somanuals.com>

<http://www.4manuals.cc>

<http://www.manual-lib.com>

<http://www.404manual.com>

<http://www.luxmanual.com>

<http://aubethermostatmanual.com>

Golf course search by state

<http://golfingnear.com>

Email search by domain

<http://emailbydomain.com>

Auto manuals search

<http://auto.somanuals.com>

TV manuals search

<http://tv.somanuals.com>