

SHARP®

LC-13E1M
LC-15E1M
LC-20E1M

ENGLISH

中文 (繁體)

中文 (簡體)

LCD COLOUR TELEVISION

液晶顯示彩色電視機

液晶显示彩色电视机

AQUOS



OPERATION MANUAL

使用說明書

使用说明书

Printed on post-consumer recycled paper.

本說明用紙使用的是再生紙。

本說明用紙使用的是再生紙。

Printed in Japan

日本印刷

日本印刷

TINS-A280WJZZ

02P09-JKM

LC-13E1M LC-15E1M LC-20E1M

LCD COLOUR TELEVISION

ENGLISH

OPERATION MANUAL

CONTENTS

	Page		Page
DEAR SHARP CUSTOMER	2	PRESET	15, 16, 17, 18
IMPORTANT SAFETY PRECAUTIONS	2, 3	On-Screen Display Language Selection ...	15
SUPPLIED ACCESSORIES	4	Adjusting the LANGUAGE Settings	15
PREPARATION	5, 6	Presetting the Channels (AUTO)	16
Preparing and Using the Remote Control ..	5	Presetting the Channels (MANUAL)	17
Batteries for Remote Control	5	Channel Setting	18
Power Connection	6	ADJUSTMENT	19, 20, 21, 22, 23, 24, 25
Antenna Connection	6	Adjusting the SLEEP TIMER Setting	19
LOCATION OF USERS CONTROL	7, 8, 9, 10	Adjusting the PICTURE Settings	20, 21
Removing the Back Cover	9	Adjusting the FEATURE Settings	22, 23
Listening with Headphones	9	Adjusting the BRIGHTNESS Settings	24
BASIC OPERATION	11, 12, 13	Adjusting the DISPLAY MODE Settings	25
Turning on POWER	11	NICAM BROADCASTS SELECTION	26
Switching TV/VIDEO AV1/AV2/ COMPONENT/TV Mode	11	IGR (German stereo system) BROADCASTS	27
Sound Volume	12	CONNECTING WITH EXTERNAL DEVICES	28, 29, 30
ON/OFF Standby	12	HOW TO FIX THE CABLES	30
Changing the Channels	13	TROUBLESHOOTING	31, 32
SELECTING THE MENU ITEMS	14	SPECIFICATIONS	33
Selecting a Menu Item	14	DIMENSIONAL DRAWINGS	34, 35, 36

DEAR SHARP CUSTOMER

Thank you for your purchase of the Sharp LCD Colour TV product. To ensure safety and many years of trouble-free operation of your product, please read the Important Safety Precautions carefully before using this product.

IMPORTANT SAFETY PRECAUTIONS

Electricity is used to perform many useful functions, but it can also cause personal injuries and property damage if improperly handled. This product has been engineered and manufactured with the highest priority on safety. However, improper use can result in electric shock and/or fire. In order to prevent potential danger, please observe the following instructions when installing, operating and cleaning the product. To ensure your safety and prolong the service life of your LCD colour TV product, please read the following precautions carefully before using the product.

- Read instructions—All operating instructions must be read and understood before the product is operated.
- Keep this manual in a safe place—These safety and operating instructions must be kept in a safe place for future reference.
- Observe warnings—All warnings on the product and in the instructions must be observed closely.
- Follow instructions—All operating instructions must be followed.
- Attachments—Do not use attachments not recommended by the manufacturer. Use of inadequate attachments can result in accidents.
- Power source—This product must operate on a power source specified on the specification label. If you are not sure of the type of power supply used in your home, consult your dealer or local power company. For units designed to operate on batteries or another power source, refer to the operating instructions.
- Power cord protection—The power cords must be routed properly to prevent people from stepping on them or objects from resting on them. Check the cords at the plugs and product.
- If you plan to use a DC power supply unit other than the AC adapter supplied with the product, make sure the power supply unit provides stable voltage with minimum fluctuations. Unstable power supply can cause problems in the product.
- Overloading—Do not overload AC outlets or extension cords. Overloading can cause fire or electric shock.
- Entering of objects and liquids—Never insert an object into the product through vents or openings. High voltage flows in the product, and inserting an object can cause electric shock and/or short internal parts. For the same reason, do not spill water or liquid on the product.
- Servicing—Do not attempt to service the product yourself. Removing covers can expose you to high voltage and other dangerous conditions. Request a qualified service person to perform servicing.
- Repair—If any of the following conditions occurs, unplug the power cord from the AC outlet, and request a qualified service person to perform repairs.
 - a. When the power cord or plug is damaged.
 - b. When a liquid has spilled on the product or when objects have fallen into the product.
 - c. When the product has been exposed to rain or water.
 - d. When the product does not operate properly as described in the operating instructions. Do not touch the controls other than those described in the operating instructions. Improper adjustment of controls not described in the instructions can cause damage, which often requires extensive adjustment work by a qualified technician.
 - e. When the product has been dropped or damaged.
 - f. When the product displays an abnormal condition. Any noticeable abnormality in the product indicates that the product needs servicing.
- Replacement parts—In case the product needs replacement parts, make sure that the service person uses replacement parts specified by the manufacturer, or those with the same characteristics and performance as the original parts. Use of unauthorized parts can result in fire, electric shock and/or other danger.
- Safety checks—Upon completion of service or repair work, request the service technician to perform safety checks to ensure that the product is in proper operating condition.
- Wall or ceiling mounting—When mounting the product on a wall or ceiling, be sure to install the product according to the method recommended by the manufacturer.

IMPORTANT SAFETY PRECAUTIONS (Continued)

- **Cleaning**—Unplug the power cord from the AC outlet before cleaning the product. Use a damp cloth to clean the product. Do not use liquid cleaners or aerosol cleaners.

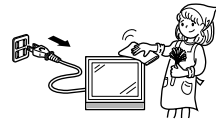

- **Water and moisture**—Do not use the product near water, such as bathtub, washbasin, kitchen sink and laundry tub, swimming pool and in a wet basement.



- **Stand**—Do not place the product on an unstable cart, stand, tripod or table. Placing the product on an unstable base can cause the product to fall, resulting in serious personal injuries as well as damage to the product. Use only a cart, stand, tripod, bracket or table recommended by the manufacturer or sold with the product. When mounting the product on a wall, be sure to follow the manufacturer's instructions. Use only the mounting hardware recommended by the manufacturer.

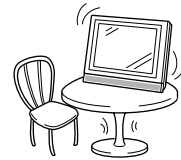

- When relocating the product placed on a cart, it must be moved with utmost care. Sudden stops, excessive force and uneven floor surface can cause the product to fall from the cart.



- **Ventilation**—The vents and other openings in the cabinet are designed for ventilation. Do not cover or block these vents and openings since insufficient ventilation can cause overheating and/or shorten the life of the product. Do not place the product on a bed, sofa, rug or other similar surface, since they can block ventilation openings. This product is not designed for built-in installation; do not place the product in an enclosed place such as a bookcase or rack, unless proper ventilation is provided or the manufacturer's instructions are followed.



- The LCD panel used in this product is made of glass. Therefore, it can break when the product is dropped or applied with impact. Be careful not to be injured by broken glass pieces in case the LCD panel breaks.

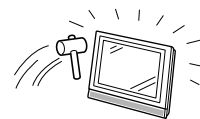

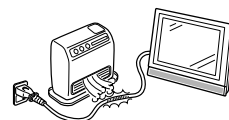

- **Heat sources**—Keep the product away from heat sources such as radiators, heaters, stoves and other heat-generating products (including amplifiers).



- The LCD panel is a very high technology product with 921,600 thin film transistors, giving you fine picture details. Occasionally, a few non-active pixels may appear on the screen as a fixed point of blue, green or red. Please note that this does not affect the performance of your product.

SUPPLIED ACCESSORIES

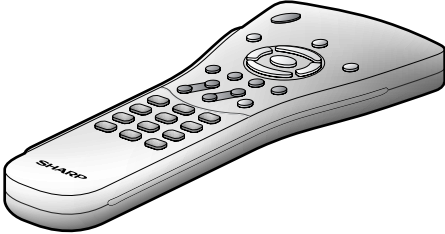
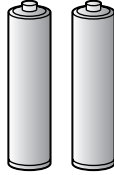
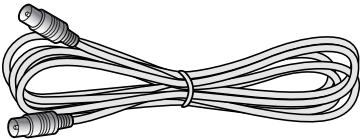
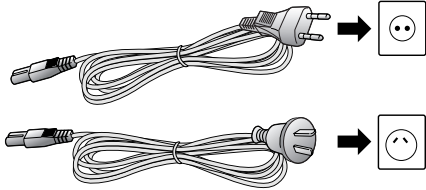
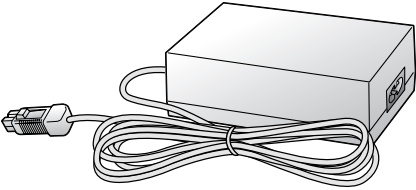
Make sure the following accessories are provided with the product.

<p>Wireless Remote Control (×1)</p> 	<p>“AAA” size (UM/SUM-4) Dry Battery (×2)</p> 	
<p>Antenna Cable (×1)</p> 	<p>AC Cord (×1)</p>  <p>*Product shape varies in some countries.</p>	
<p>AC Adapter (×1)</p> 	<p>Operation Manual (×1)</p> 	<p>Cable Clamp (×1)</p> 

PREPARATION

Preparing and Using the Remote Control

- Use the remote control by pointing it towards the remote sensor window. Objects between the remote control and sensor window may prevent proper operation.

Cautions regarding use of remote control

- Do not expose the remote control to shock. In addition, do not expose the remote control to liquids, and do not place in an area with high humidity.
- Do not install or place the remote control under direct sunlight. The heat may cause deformation of the unit.
- The remote control may not work properly if the remote sensor window of the main unit is under direct sunlight or strong lighting. In such case, change the angle of the lighting or LCD TV set, or operate the remote control closer to the remote sensor window.

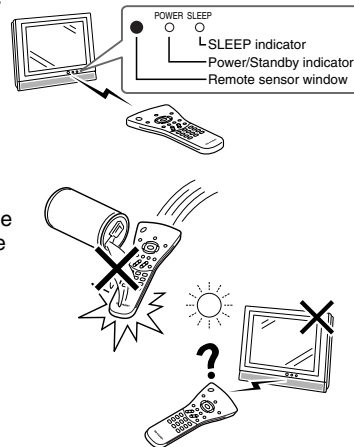

Batteries for Remote Control

Before using the LCD TV set for the first time, install two ("AAA" size, UM/SUM-4) batteries (supplied). When the batteries become depleted and the remote control fails to operate, replace the batteries with new ("AAA" size, UM/SUM-4) batteries.

- 1** Open the battery cover.

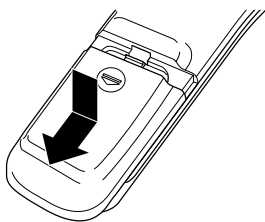

- Slide the cover while pressing the (▼) part.

- 2** Insert two ("AAA" size, UM/SUM-4) batteries.

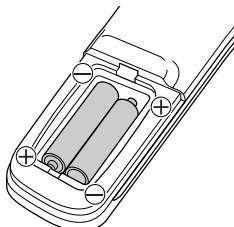

- Position the positive and negative ends of the batteries as indicated in the compartment.

- 3** Close the battery cover.

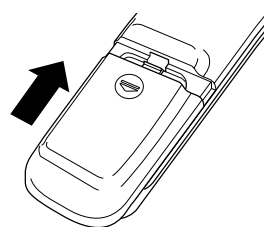

- Engage the claw on the cover into the battery housing and slide shut.

⚠ Caution!

Cautions regarding batteries

Improper use of batteries can result in a leakage of chemicals and/or explosion. Be sure to follow the instructions below.

- Place batteries with their terminals corresponding to the (+) and (-) indications.
- Different types of batteries have different characteristics. Do not mix batteries of different types.
- Do not mix old and new batteries. Mixing old and new batteries can shorten the life of new batteries and/or cause old batteries to leak chemicals.
- Remove batteries as soon as they are non-operable. Chemicals that leak from batteries can cause a rash. If chemical leakage is found, wipe with a cloth.
- The batteries supplied with the product may have a shorter life expectancy due to storage conditions.
- If the remote control is not used for an extended period of time, remove batteries from the remote control.

PREPARATION (Continued)

Power Connection

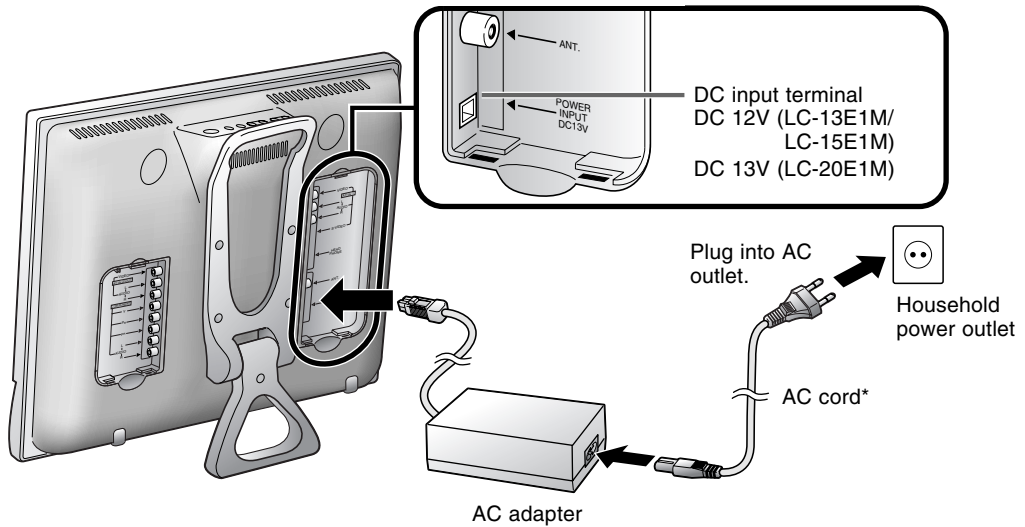

* Product shape varies in some countries.

Note:

- Use a commercially available AC plug adapter, if necessary, depending on the design of the wall outlet.
- Always turn the main power switch of the LCD TV set to OFF when connecting the AC adapter.
- Always unplug the AC adapter from the product and power outlet when not using for long periods of time.

Antenna Connection

- Using the supplied antenna cable, connect the room antenna terminal to the antenna input terminal on the TV set. (Refer to the figure below.)

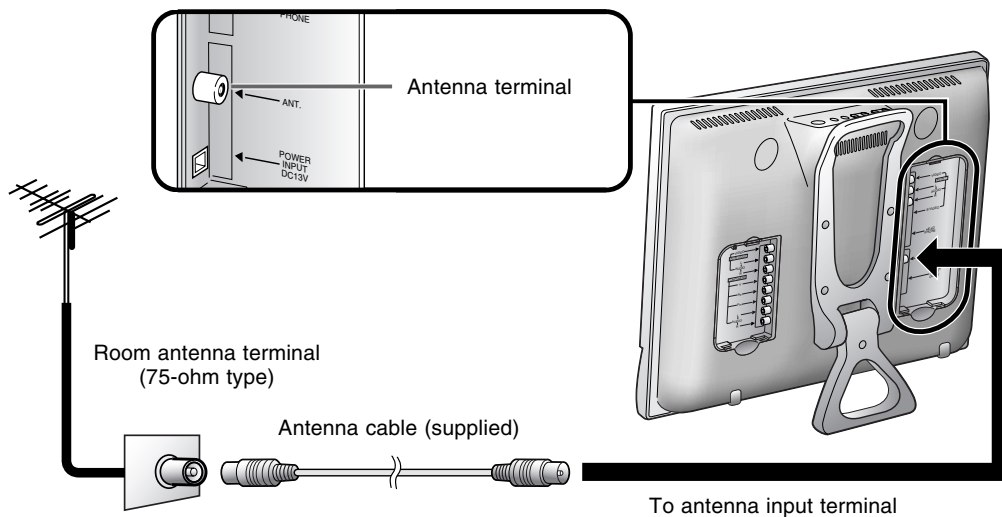

LOCATION OF USERS CONTROL

Main unit (front view)

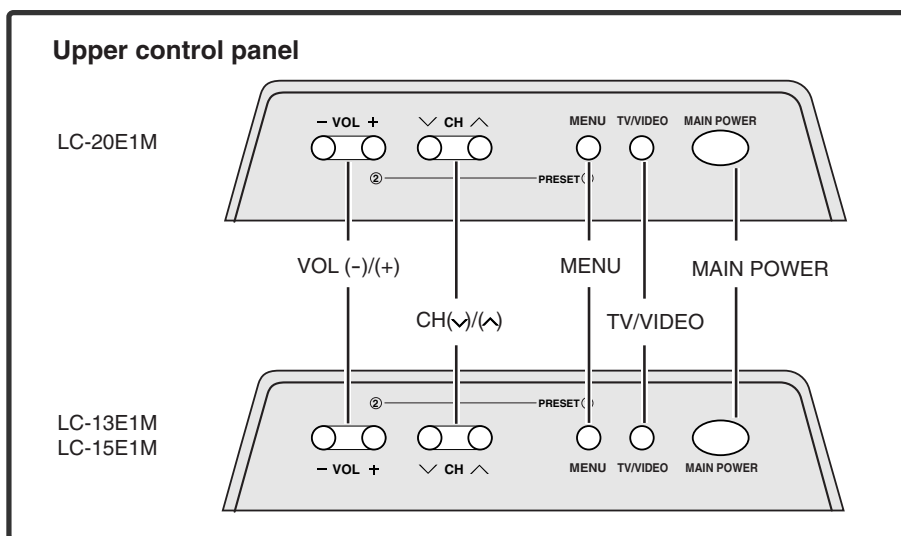

The screen can be adjusted backwards to an angle between 12 degrees and 35 degrees. The screen cannot be set up straight. When changing the angle, make sure to hold the stand and adjust the screen to the best viewable angle.

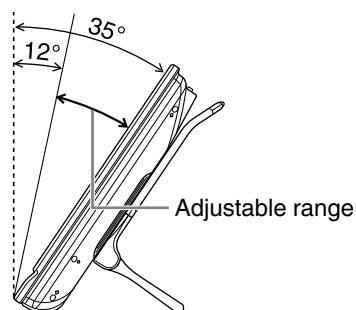

Speaker

Remote sensor window

SLEEP indicator

The SLEEP indicator lights up red when the SLEEP TIMER is set to on.

Power/Standby indicator

A green indicator lights when the power is on and a red indicator lights when in the standby mode (the indicator will not light when the main power is off).

* The examples used throughout this manual are based on the LC-20E1M model. There may be a slight difference in the illustrations, if you are using the LC-13E1M and LC-15E1M models.

Note:

- TV/VIDEO, CH (↓)/(↑), and VOL (-)/(+) on the main unit have the same functions as the same buttons on the remote control. Fundamentally, this operation manual provides a description based on operation with the remote control.

LOCATION OF USERS CONTROL (Continued)

Main unit (rear view)

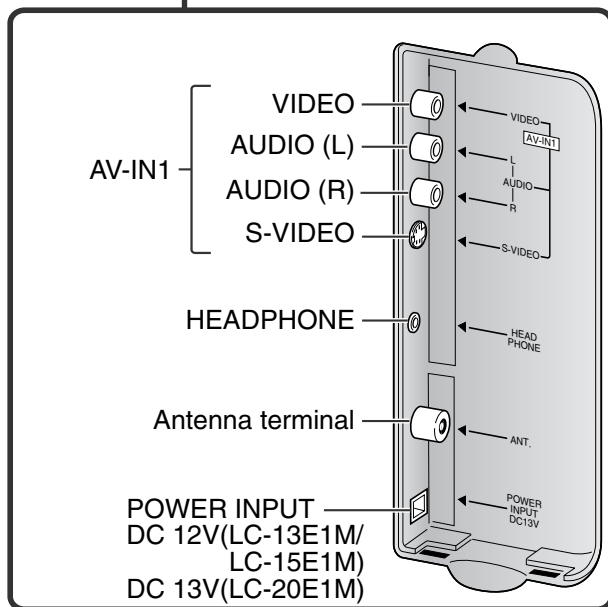
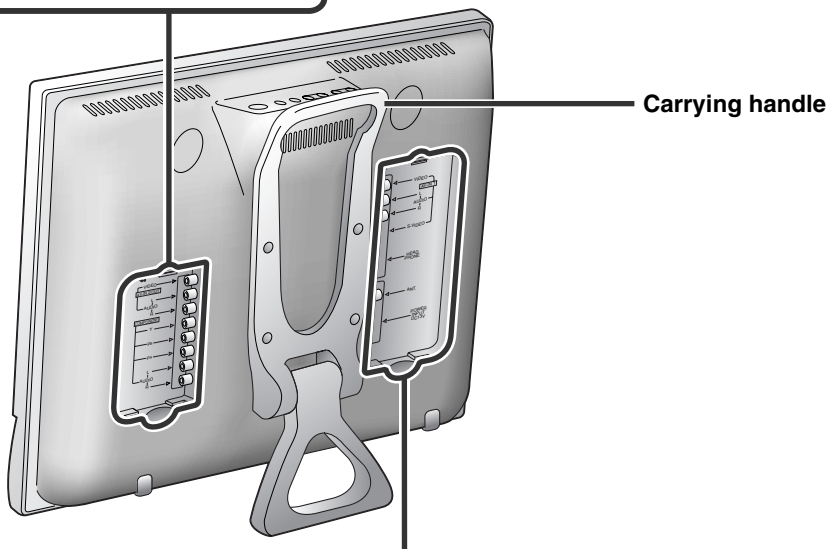
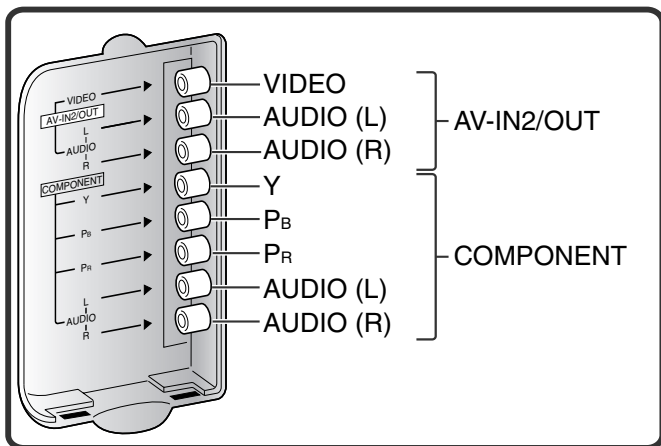

LOCATION OF USERS CONTROL (Continued)

Removing the Back Cover

■ Before connecting a connection cord into the rear terminal, remove the back cover. Push in the tab and pull out the back cover carefully.

■ To mount the cover, insert the 2 hooks on the bottom of the cover into the cabinet and press on the upper part of the back cover until the tab locks in place with a click.

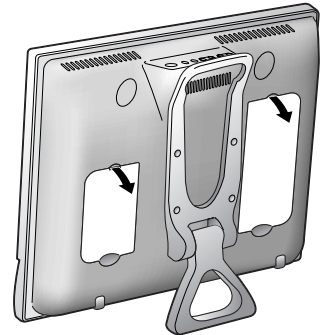

Listening with Headphones

■ Plug the headphone mini-plug into the HEADPHONE jack located on the rear of the TV set.

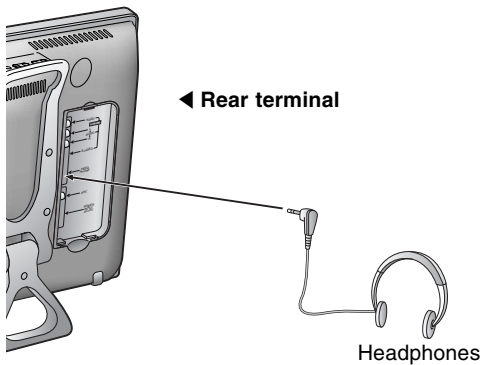

▼ On-screen display

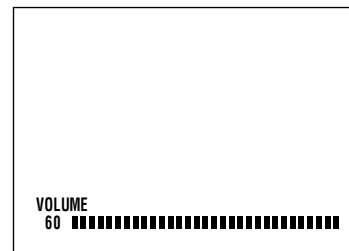

Note:

- Headphones are not included in the supplied accessories.
- No sound will be heard from the main unit speakers when a headphone mini-plug is connected into the HEADPHONE jack.

LOCATION OF USERS CONTROL (Continued)

Remote control

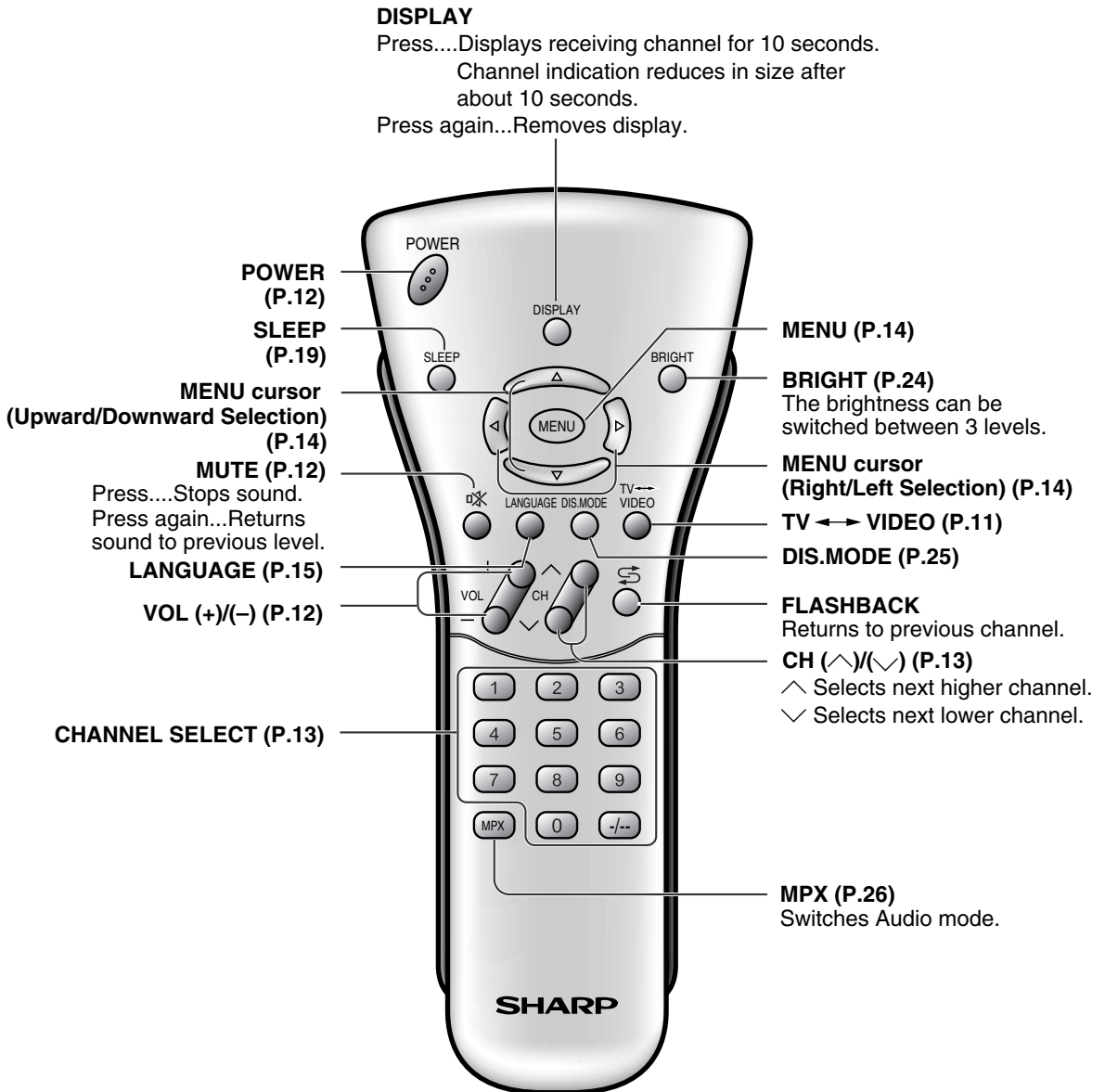

BASIC OPERATION

Turning on POWER

Control section of main unit

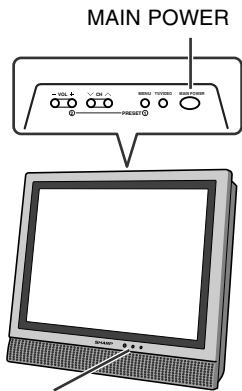

Power/Standby indicator

- 1 Press **MAIN POWER**, located on the upper part of the main unit to ON.
- 2 The **POWER/STANDBY** indicator instantaneously changes from red to green and the main unit is turned on.

Note:

- Input mode indication disappears after several seconds.

▼ On-Screen Display

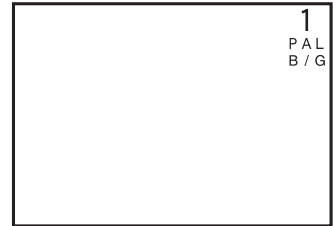

Switching TV/VIDEO AV1/AV2/COMPONENT/TV Mode

- 1 Turn on the power of the connected video equipment.
- 2 Press **TV ↔ VIDEO** and select the applicable input source. The screen displays AV1, AV2, COMPONENT or TV mode at the upper right corner each time **TV ↔ VIDEO** is pressed.

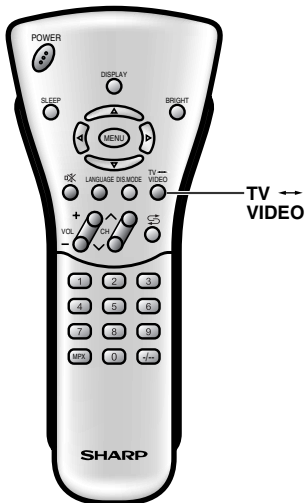

Note:

- AV input mode indication remains for five seconds.
- AV1: Video equipment connected to the AV1 input terminals. An S-video input terminal is additionally provided for the AV1 input. If both S-video terminal and normal video terminals are connected with cables, the S-video input terminal is selected as the high priority.
- AV2: AV2 mode is used to adjust the preset settings and IN or OUT can be selected. AV2 indication is not displayed when OUT is selected. (For details on setting AV-OUT, see page 23.)
- COMPONENT: Video equipment connected to the COMPONENT input terminals.

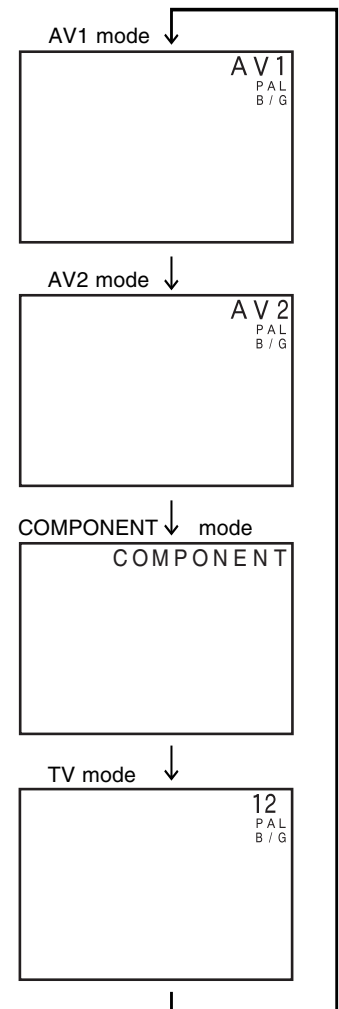

BASIC OPERATION (Continued)

Sound Volume

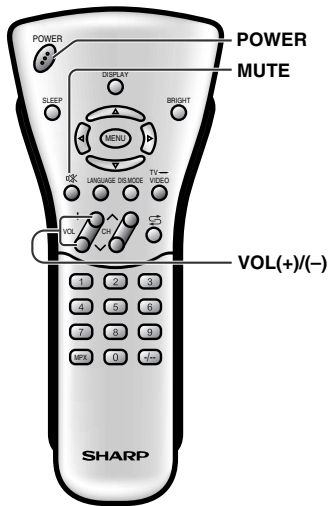

1 Press **VOL (+)** to increase sound volume. The segment of indicator increases.



2 Press **VOL (-)** to decrease sound volume. The segment of indicator decreases.



To mute sound

1 Press **MUTE** to temporarily turn off the sound. Screen displays the MUTE mark.



2 Press **MUTE** or **VOL (+)/(-)** to turn the sound back to the previous level. MUTE is automatically cleared when the following buttons are pressed: **POWER, VOL (+)/(-), MUTE.**



ON/OFF Standby

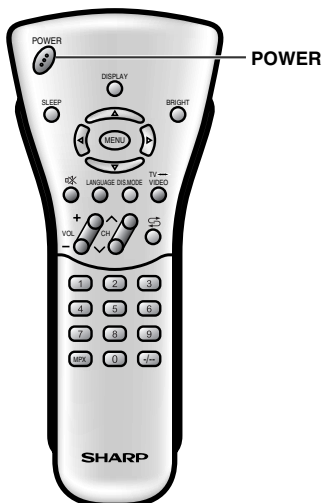

To turn off the LCD TV

Press **POWER** on the remote control. The Power/Standby indicator will turn red. (Standby position)

To turn the LCD TV back on

Press **POWER** again. The Power/Standby indicator will turn green.

BASIC OPERATION (Continued)

Changing the Channels

Changing channels using **CHANNEL SELECT** on the remote control.

- To handle the increasing number of channels available, this LCD TV set allows you to select up to 100 positions (Channels 0 to 99). One-digit and two-digit methods of selection can be used. Follow the procedure shown below to select channels.

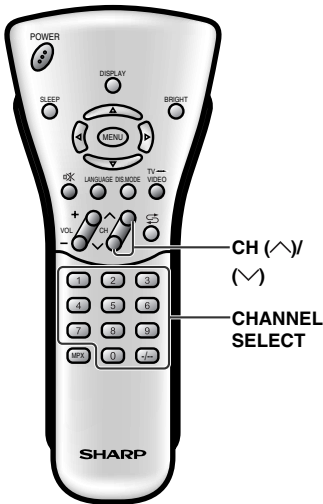

To select a one-digit channel (e.g., Channel 5):

- 1 Press the **5** button.
- 2 If "5-" is indicated and the picture does not change, press the **CH** button to switch over to the 1-digit select mode and press **5** again.



To select a two-digit channel (e.g., Channel 15):

- 1 Press the **CH** button to set the 2-digit select mode.
- 2 Press the **1** button.
- 3 Press the **5** button.

Note:

- Complete this procedure within 4 seconds, otherwise the selection will not be made.

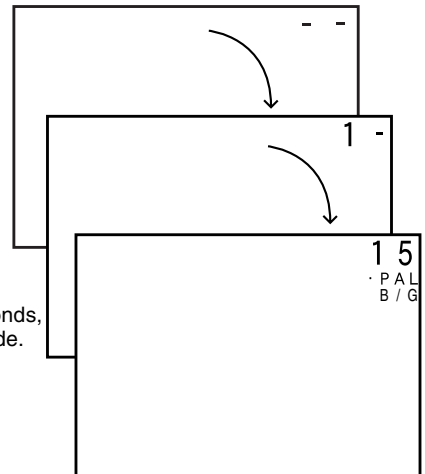

Changing channels with CH (∧)/(∨) on the remote control.

Press **CH (∧)** and the channels change in the order shown below:

1 → 2 → 3 → ... → 98 → 99 → 0 → 1 → 2 → 3 → ...

Press **CH (∨)** and the channels change in the order shown below:

3 → 2 → 1 → 0 → 99 → 98 → ... → 3 → 2 → 1 → ...

SELECTING THE MENU ITEMS

Selecting a Menu Item

- This LCD TV set allows you to adjust the picture and sound, and set the channels and other features using the On-Screen Display. Select the desired menu item by following the steps below and then refer to the indicated page for details.

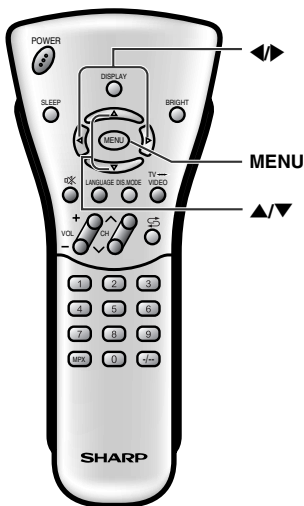

- Press **MENU** to display the MENU screen.
- Press **▲/▼** to select the desired menu item.
 - The “” mark moves up or down.
 - The “” mark indicates the selected menu item.
- Press **▶▶** to enter.

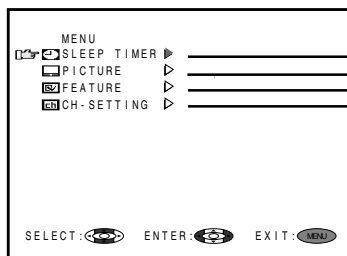

Note:

- The TINT display only appears when the COLOUR SYSTEM sets N358 or N443 in the NTSC mode.
- The displayed items differ depending on the setting conditions.
- The selected item changes to yellow.
- Items in purple cannot be selected.

SLEEP TIMER menu ----- Page 19

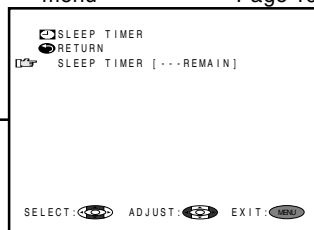

PICTURE menu (TV mode) ----- Page 20

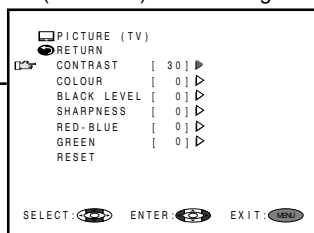

(AV mode) ----- Page 20

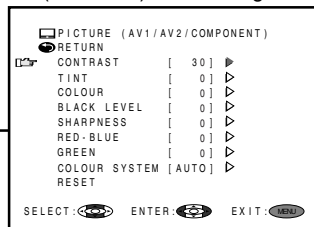

FEATURE menu --- Page 22

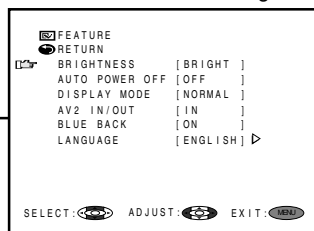

CH-SETTING menu ----- Page 18

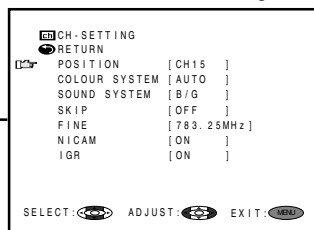

* The screen indications shown above are larger than actual for easy reading.

PRESET

On-Screen Display Language Selection

Upper control panel

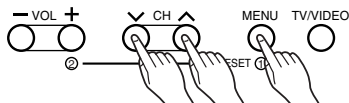

3 1,2,4

* In this example, the LC-20E1M model is used. Refer to page 7 if you are using the LC-13E1M and LC-15E1M models.

■ **MENU** on the LCD TV set can also be used to select the language.

- 1 Press **MENU** on the upper part of the LCD TV set for more than two seconds to display the PRESET mode screen.
- 2 Press **MENU** twice to display the LANGUAGE select mode screen. Press **MENU** again to change the PRESET mode as shown below.

AUTO → MANUAL → LANGUAGE → **NORMAL SCREEN**

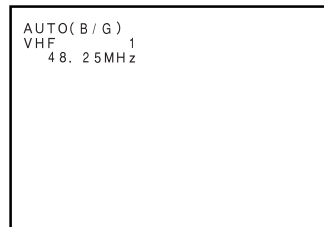

Note:

- Instead of pressing **MENU** for more than two seconds, you can display the LANGUAGE select mode by selecting **FEATURE** → **LANGUAGE** on the Menu screen.
- 3 Press **CH** (∨)/(∧) to select the language you wish to display.
 - 4 Press **MENU** to return to the normal screen.

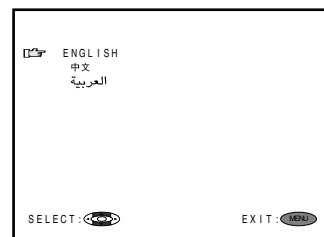

Adjusting the LANGUAGE Settings

Directly setting the LANGUAGE

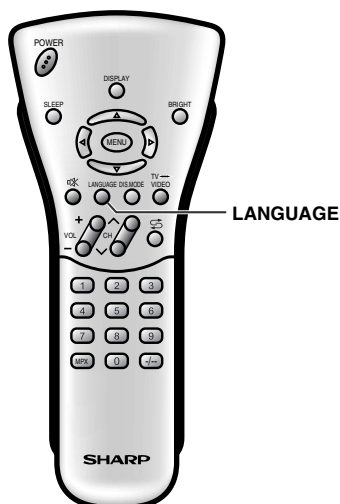

- 1 Press **LANGUAGE** to display the LANGUAGE screen.
- 2 Press **LANGUAGE** to change the setting.

→ ENGLISH → 中文 → العربية →

Note:

- The LANGUAGE screen automatically disappears in 3 seconds.

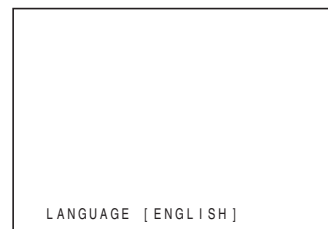

PRESET (Continued)

Presetting the Channels (AUTO)

Upper control panel

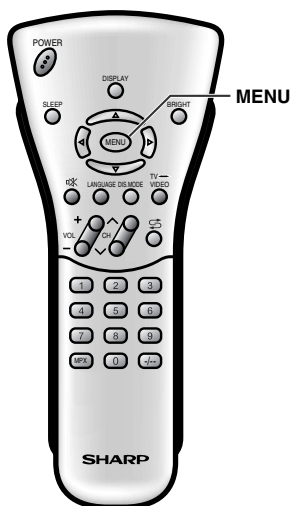
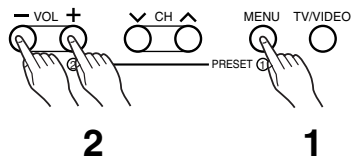

■ Automatically tunes in and presets receivable TV stations.

Make sure the antenna cable is properly connected.

- 1** Press **MENU** (PRESET-①) on the upper part of the LCD TV set for more than two seconds. The AUTO mode screen appears.
- 2** Press **VOL (-)/(+)** (PRESET-②) on the upper part of the LCD TV set. All the TV stations in your area that can be received by the LCD TV set are automatically preset.
- 3** The screen shows whatever is on channel 1 when full auto channel preset is finished.

Note:

- When starting PRESET after setting the SOUND SYSTEM with **MENU** of the Remote Control, the SOUND SYSTEM for all channels are stored into memory.
- Unused channels are automatically skipped.
- The Preset mode is only available in the TV mode and cannot be operated in the AV mode.

(Auto mode screen)

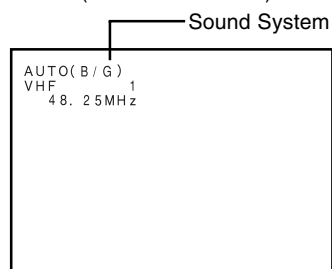

PRESET (Continued)

Presetting the Channels (MANUAL)

Upper control panel

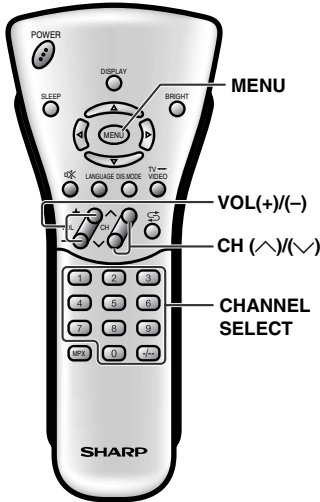
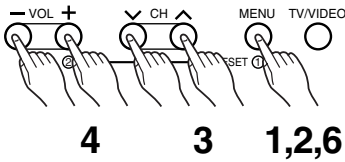

Upper control panel

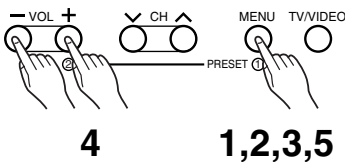

■ Setting a channel to a desired TV station:

- 1 Press **MENU** (PRESET-①) on the upper part of the LCD TV set for more than two seconds. The AUTO mode screen appears.
- 2 Press **MENU** (PRESET-①) to display the MANUAL mode screen. Press **MENU** (PRESET-①) again to change the MANUAL mode as shown below.
- 3 Select the channel position using **CHANNEL SELECT** or **CH (^)/(v)**.
- 4 Press **VOL (+)/(-)** to locate the channel you want to preset to the position. Search is initiated and when a TV signal is received during the search, the search stops.
- 5 Repeat steps 3 and 4 above, to preset the channel positions for other broadcasts, etc.
- 6 Press **MENU** (PRESET-①) to return to the normal screen.

Note:

- SYSTEM may not have been set correctly, if noise can be heard or if there is no sound. In such case, reset to SOUND SYSTEM using **MENU**.

■ In a weak reception area, or under bad reception conditions.

- 1 Press **MENU** (PRESET-①) on the upper part of the LCD TV set for more than two seconds. The AUTO mode screen appears.
- 2 Press **MENU** (PRESET-①) to display the MANUAL mode screen.
- 3 While the MANUAL mode screen is displayed, press **MENU** for more than 2 seconds. The channel position number remains in green.
- 4 Adjust for good reception using **VOL (+)/(-)**.
- 5 After finishing the adjustment, press **MENU** (PRESET-①) to continue channel presetting.

Note:

- While the MANUAL mode screen is displayed, press **MENU**. (The LANGUAGE mode screen will appear.)

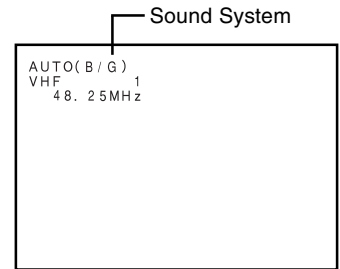

Auto mode screen

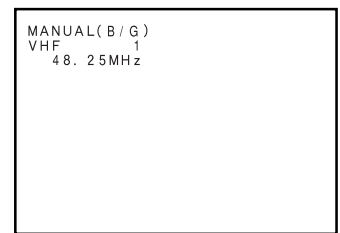

Manual mode screen

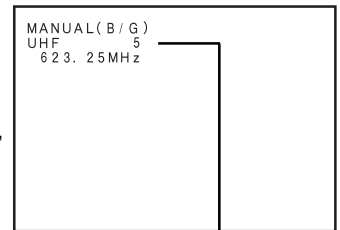

Channel position number

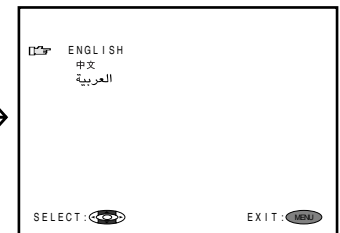
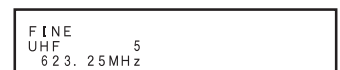
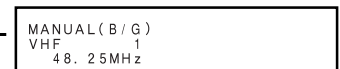
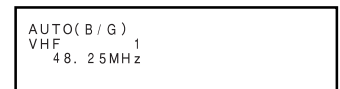

ADJUSTMENT

Adjusting the SLEEP TIMER Setting

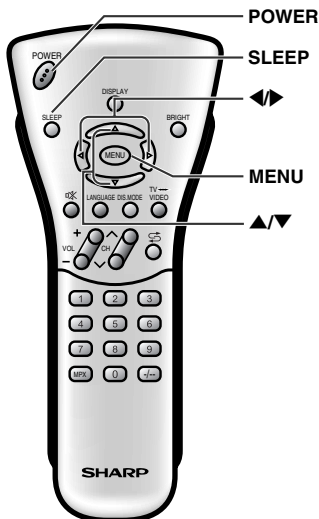

To use Direct Key function

- 1 Press **SLEEP** to display the SLEEP TIMER screen.
- 2 Press **SLEEP** to set the sleep timer (in minutes).
 - Each time you press **SLEEP**, the timer changes as follows:

→ --- → 30 → 60 → 90 → 120

The setting is turned off when --- is displayed.

- 3 Press **MENU** to return to the main screen.



To use MENU item

- 1 Press **MENU** to display the MENU screen.

- 2 Press **▲/▼** to move the cursor to SLEEP TIMER.

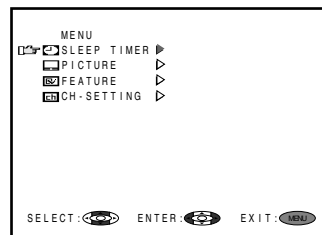

- 3 Press **◀/▶** to display the SLEEP TIMER screen.

- 4 Press **◀/▶** to set the sleep timer (in minutes).

The setting can be set in increment of 30 minutes and in the range between 30 and 120 minutes.

The setting is turned off when --- is displayed.

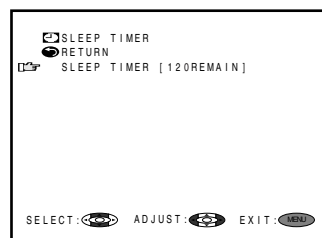

- 5 Press **MENU** to return to the main screen.

Note:

- When you set the SLEEP TIMER, the SLEEP indicator lights.
- After you set the SLEEP TIMER, if you turn off the **MAIN POWER** on the TV set or press **POWER** on the remote control, the SLEEP TIMER setting is cancelled and the SLEEP indicator goes out.
- 5 minutes before the SLEEP TIMER turns off the TV, 5 REMAIN is displayed on the screen for 4 seconds. The SLEEP TIMER counts down and shows a similar 4-second display for each remaining minute until the timer turns off the TV.

ADJUSTMENT (Continued)

Adjusting the PICTURE Settings

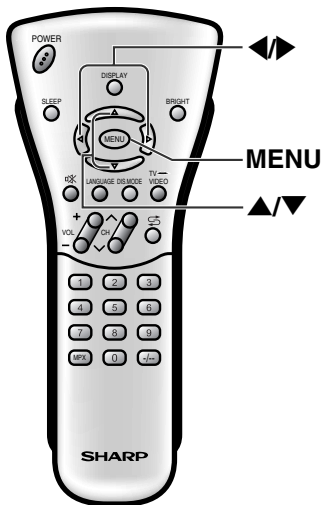

1 Press **MENU** to display the MENU screen.

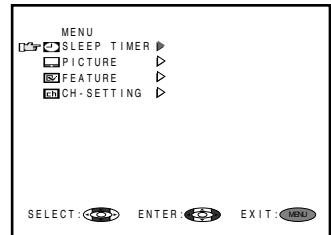

2 Press **▲/▼** to move the cursor to PICTURE.

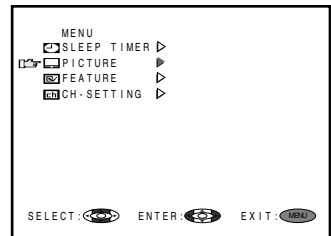

3 Press **◀▶** to display the PICTURE menu screen.

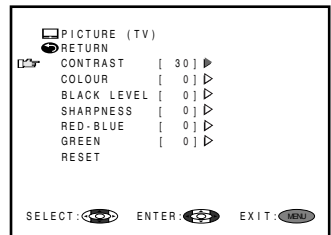

4 Press **▲/▼** to move the cursor and select the desired adjustment item. All of adjustment items are shown in the diagram on page 21.

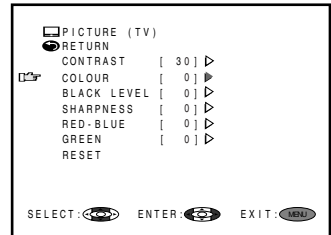



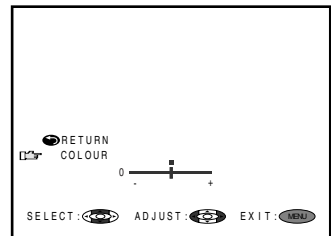

5 Press **◀▶** to display the screen for the selected adjustment item.



6 Press **◀▶** to make adjustment. To adjust another item, move the cursor by pressing **▲/▼** while the MENU screen is displayed. See the diagram on page 21 for details of each item settings.

7 Press **MENU** to return to the main screen.

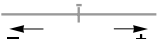
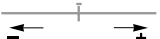
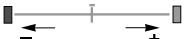
ADJUSTMENT (Continued)

Selected item	Press ◀.		Press ▶.
CONTRAST	Decrease contrast		Increase contrast
TINT	Toward purple		Toward green
COLOUR	Lower colour intensity		Higher colour intensity
BLACK LEVEL	Less bright		More bright
SHARPNESS	Soft picture		Hard picture
RED-BLUE	More red level		More blue level
GREEN	Less green level		More green level
COLOUR SYSTEM (AV1/AV2) (COMPONENT)	Press ▶ to select COLOUR SYSTEM. → AUTO → PAL → SECAM → N358 → N443 → PAL-M → PAL-N → PAL60 → → AUTO → PAL → NTSC →		

Note:

- TINT is displayed only when N358 or N443 is selected.
- COLOUR SYSTEM is displayed only in the AV mode.

Switching the COLOUR SYSTEM

Set the system to AUTO for normal reception. The AUTO mode automatically detects the receiving signal system and changes the reception system of the set.

When the picture or sound is not stable, switching to an appropriate system may improve the picture or sound quality.

ADJUSTMENT (Continued)

Adjusting the FEATURE Settings

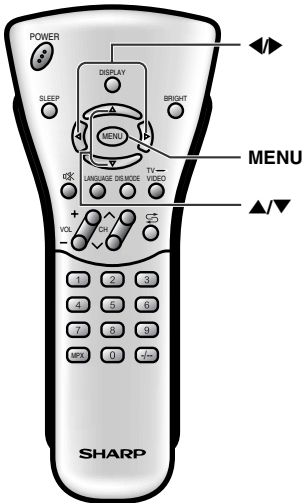



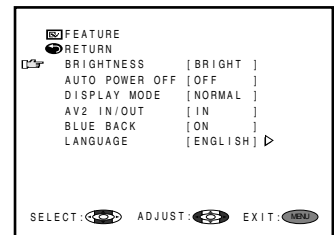
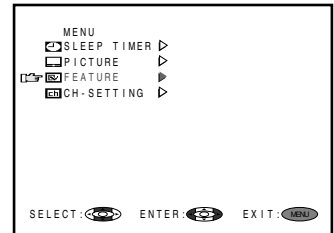
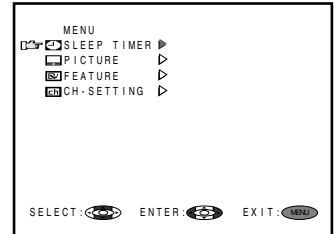

- The FEATURE items can be set by the user.

- 1 Press **MENU** to display the MENU screen.
- 2 Press **▲/▼** to move the cursor to **FEATURE**.
- 3 Press **◀▶** to display **FEATURE** screen.
- 4 Check the factory setting of each item on the **FEATURE** screen. The user can change the settings by using **▲/▼** and **◀▶**. See the diagram on page 23 for details of each item settings.
- 5 Press **MENU** to return to the main screen.

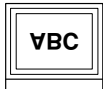

ADJUSTMENT (Continued)

Selected item	Factory setting	Setting change
BRIGHTNESS	[BRIGHT] Maximum brightness	[NORMAL] Brightness 60% → Suitable for viewing in well-lit areas. Saves energy. [DARK] Brightness 20% → Sufficiently bright when viewing in dim areas.
AUTO POWER OFF (only TV mode)	[OFF] This feature is inactive.	[ON] The power of the LCD TV set is turned off when there is no signal for 5 minutes.
DISPLAY MODE	[NORMAL] Normal image orientation 	[MIRROR] Mirror image → To display mirror images for special uses.  [UPSIDE DOWN] Upside down image → To display upside down images for special uses.  [REVERSE + INVERT] Reversed and inverted image → To display images reversed and inverted for special uses. 
AV2 IN/OUT	[IN]	[OUT ] Line Output is selected, Output volume is fixed, Speaker output is available. [OUT ] Line Output is selected, Output volume is variable, Speaker output is Mute.
BLUE BACK	[ON] The screen is turned blue when there is no signal.	[OFF] This feature is inactive.
LANGUAGE	[ENGLISH]	[中文] [العربية]

- In BLUE BACK, PICTURE setting displayed in purple cannot be selected.
- AV2 IN/OUT cannot be selected in AV2 mode. Also, AV2 mode cannot be selected, when selecting AV2 OUT.

ADJUSTMENT (Continued)

Adjusting the BRIGHTNESS Settings

You can set the brightness of the screen.

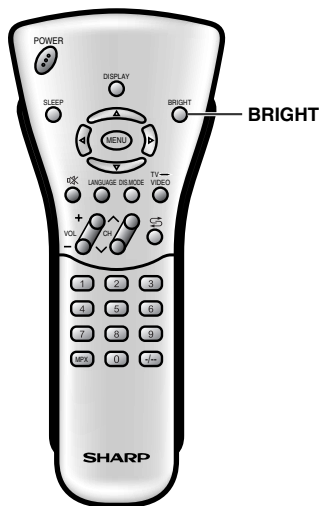

Directly setting the BRIGHTNESS

- 1 Press **BRIGHT** to display the BRIGHTNESS screen.
- 2 Press **BRIGHT** to change the setting.

→ **BRIGHT** → **NORMAL** → **DARK** ←



Note:

- The BRIGHTNESS screen automatically disappears in 3 seconds.
- [BRIGHT]: maximum brightness
- [NORMAL]: 60% brightness (suitable for viewing in a well-lit area and saves energy)
- [DARK]: 20% brightness (sufficiently bright when viewing in a dimly lit area)

Setting the BRIGHTNESS on the MENU screen

- 1 Press **MENU** to display the MENU screen.
- 2 Press **▲/▼** to move the cursor to **FEATURE**.
- 3 Press **◀▶** to display **FEATURE** screen.

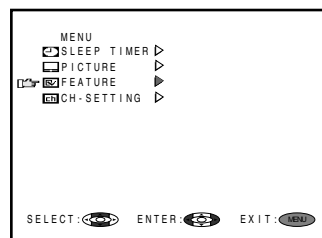
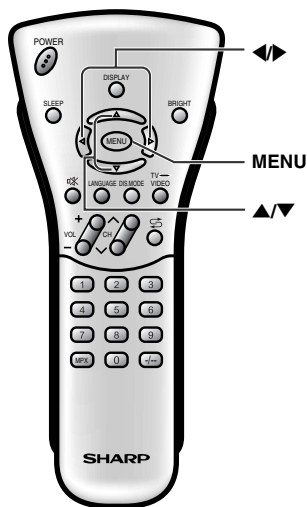

- 4 Press **▲/▼** to move the cursor to **BRIGHTNESS**.
- 5 Press **◀▶** to set the brightness.
- 6 Press **MENU** to return to the main screen.

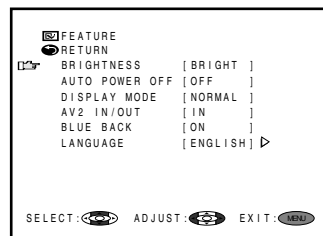

Adjusting the DISPLAY MODE Settings

You can set the orientation of the picture.

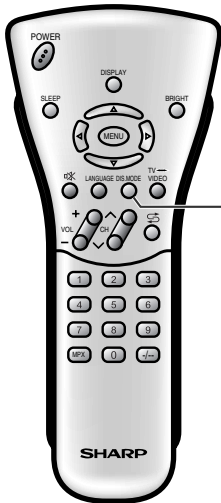

Directly setting the DISPLAY MODE

- 1 Press **DIS.MODE** to display the DISPLAY MODE screen.
- 2 Press **DIS.MODE** to change the setting.



Note:

- The DISPLAY MODE screen automatically disappears in 3 seconds.
- [NORMAL]: normal image
- [MIRROR]: mirror image
- [UPSIDE DOWN]: upside down image
- [REVERSE+INVERT]: reversed and inverted image

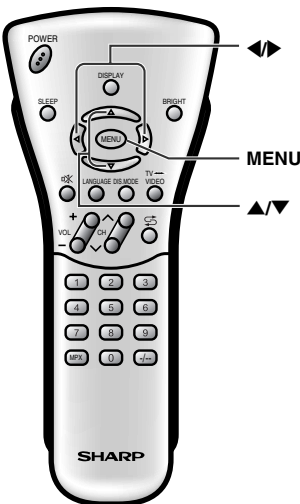

Setting the DISPLAY MODE on the MENU screen

- 1 Press **MENU** to display the MENU screen.
- 2 Press **▲/▼** to move the cursor to FEATURE.
- 3 Press **◀/▶** to display FEATURE screen.
- 4 Press **▲/▼** to move the cursor to DISPLAY MODE.
- 5 Press **◀/▶** to set the DISPLAY MODE.
- 6 Press **MENU** to return to the main screen.

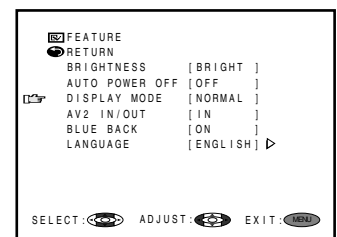
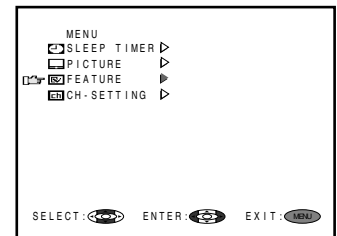

NICAM BROADCASTS SELECTION

Enables selection of reception mode when receiving a NICAM signal.

To let you enjoy NICAM broadcasting, this LCD TV receives NICAM system stereo, bilingual, and monaural broadcasts.

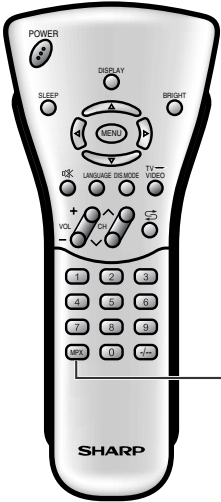

MPX

Stereo

TV set is receiving a stereo broadcast.

- Each time you press **MPX**, the mode switches between NICAM STEREO and MONO. When MONO is selected, the TV sound is output in monaural.

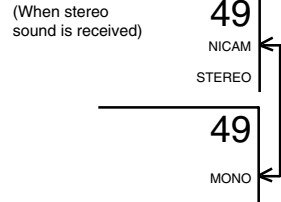

Bilingual

TV set is receiving a bilingual broadcast.

- Pressing **MPX** changes the audio mode in the order shown on the right.
- M1=main sound, M2=sub sound, or MONO=monaural sound, can be selected.

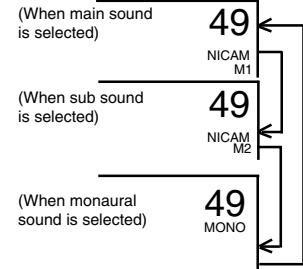

Monaural

TV set is receiving a monaural broadcast.

- Each time you press **MPX**, the mode switches between NICAM MONO and MONO.

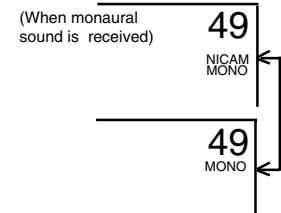

Note:

- If approximately 3 seconds pass without a button being pressed, the mode setting is automatically terminated and the TV set returns to normal mode.
- The setting can be selected individually for each channel position.

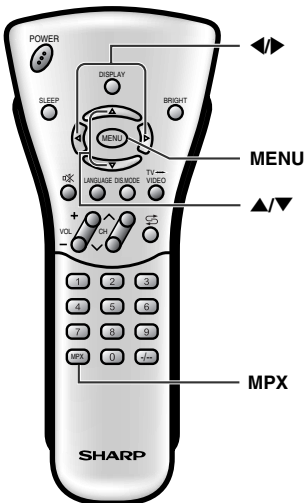

MENU

MPX

If the sound quality is poor due to a weak signal or other problems during NICAM broadcast reception, set the "OFF" position of the NICAM to change the TV sound to monaural.

- Press **MENU** to display the MENU screen.
- Press **▲/▼** to select "CH-SETTING".
- Press **◀▶** to display the CH-SETTING menu.
- Press **▲/▼** to select "NICAM".
- Press **◀▶** to select "OFF". When the NICAM sound is set to the "OFF" position, the TV sound is output in monaural.

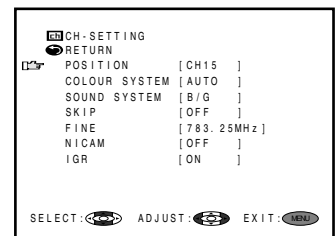

(When off position is selected)

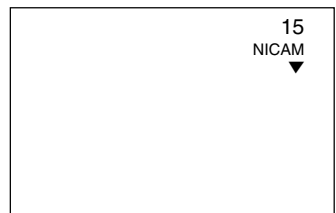

Note:

- When the NICAM sound is set to the "OFF" position, **MPX** cannot be used to change the audio mode (stereo and bilingual settings).

IGR (German stereo system) BROADCASTS

Enables selection of reception mode when receiving an IGR Stereo signal.

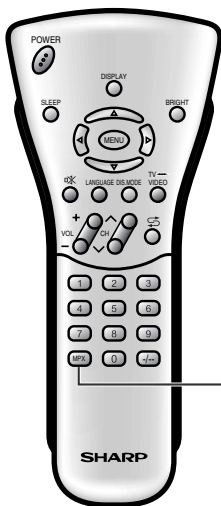

To let you enjoy IGR broadcasting, this TV receives IGR system stereo and bilingual broadcasts.

Stereo

TV set is receiving a stereo broadcast.

- Each time you press **MPX**, the mode switches between STEREO and MONO.
- When MONO is selected, the TV sound is output in monaural.

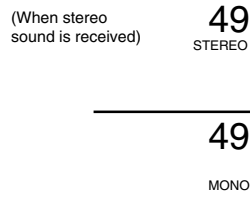

Bilingual

TV set is receiving a bilingual broadcast.

- Pressing **MPX** changes the audio mode in the order shown on the right.
- MAIN=main sound or SUB=sub sound, can be selected.

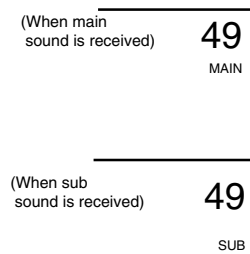

Note:

- If approximately 3 seconds pass without a button being pressed, the mode setting is automatically terminated and the TV set returns to normal mode.
- The setting can be selected individually for each channel position.

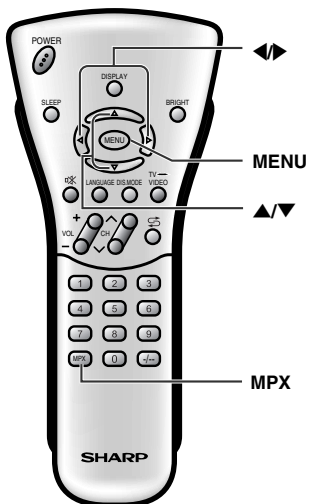

If the sound quality is poor due to a weak signal or other problems during IGR broadcast reception, set the "OFF" position of the IGR to change the TV sound to monaural.

- 1 Press **MENU** to display the MENU screen.
- 2 Press **▲/▼** to select "CH-SETTING".
- 3 Press **◀▶** to display the CH-SETTING menu.
- 4 Press **▲/▼** to select "IGR".
- 5 Press **◀▶** to select "OFF".

When the IGR sound is set to the "OFF" position, the TV sound is output in monaural.

(CH-SETTING menu)

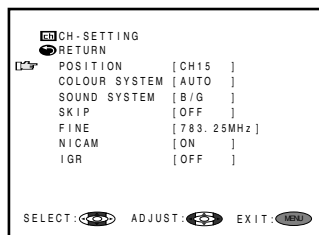

(When off position is selected)

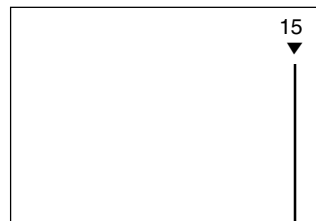

▼ is displayed if IGR is received when IGR is set to OFF.

Note:

- When the IGR sound is set to the "OFF" position, **MPX** cannot be used to change the audio mode (stereo and bilingual settings).

CONNECTING WITH EXTERNAL DEVICES

You can enjoy picture and sound by connecting a VCR or a home video game system to the terminals located on the rear of the TV set.

When connecting an external device, turn off the power of the main unit first to prevent any possible damage.

Example of external devices that can be connected

External devices that can be connected to AV-IN2 terminal

<Example>

- VCR



External devices that can be connected to AV-IN1 terminal

<Example>

- Camcorder
- Home video game system

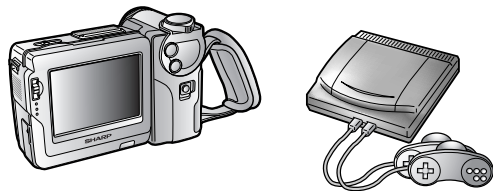

* If your external device has an S-Video terminal, S-VIDEO connection is recommended.

External devices that can be connected to COMPONENT terminal

<Example>

- DVD, etc.



* If your external device has a component terminal, COMPONENT connection is recommended (you can view high-quality pictures).

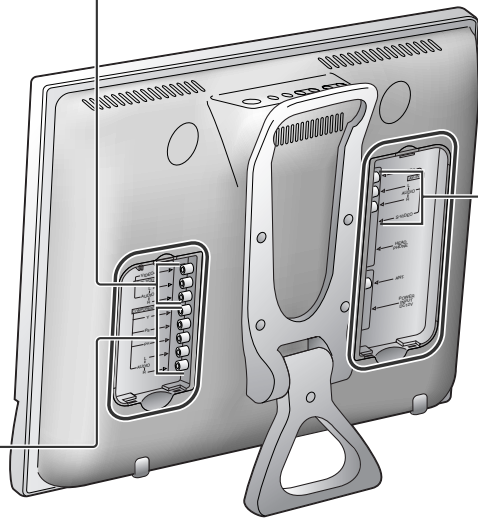

Note:

- For the cable, use a commercially available audio/video cord.
- Only connect audio/video signals to AV-IN1 and AV-IN2/OUT terminals. Connecting other signals may result in a malfunction.
- AV-IN1 has 2 video input terminals: VIDEO and S-VIDEO. When you connect external devices to both terminals (and if you select AV-IN1), you can only view pictures from the S-VIDEO terminal. To view the picture from the VIDEO terminal, do not connect any external devices to the S-VIDEO terminal.
- For more information about external device connections, see the manuals of your external devices.

CONNECTING WITH EXTERNAL DEVICES (Continued)

Connecting a VCR, DVD player or a Camcorder (AV-IN1/AV-IN2/OUT/COMPONENT)

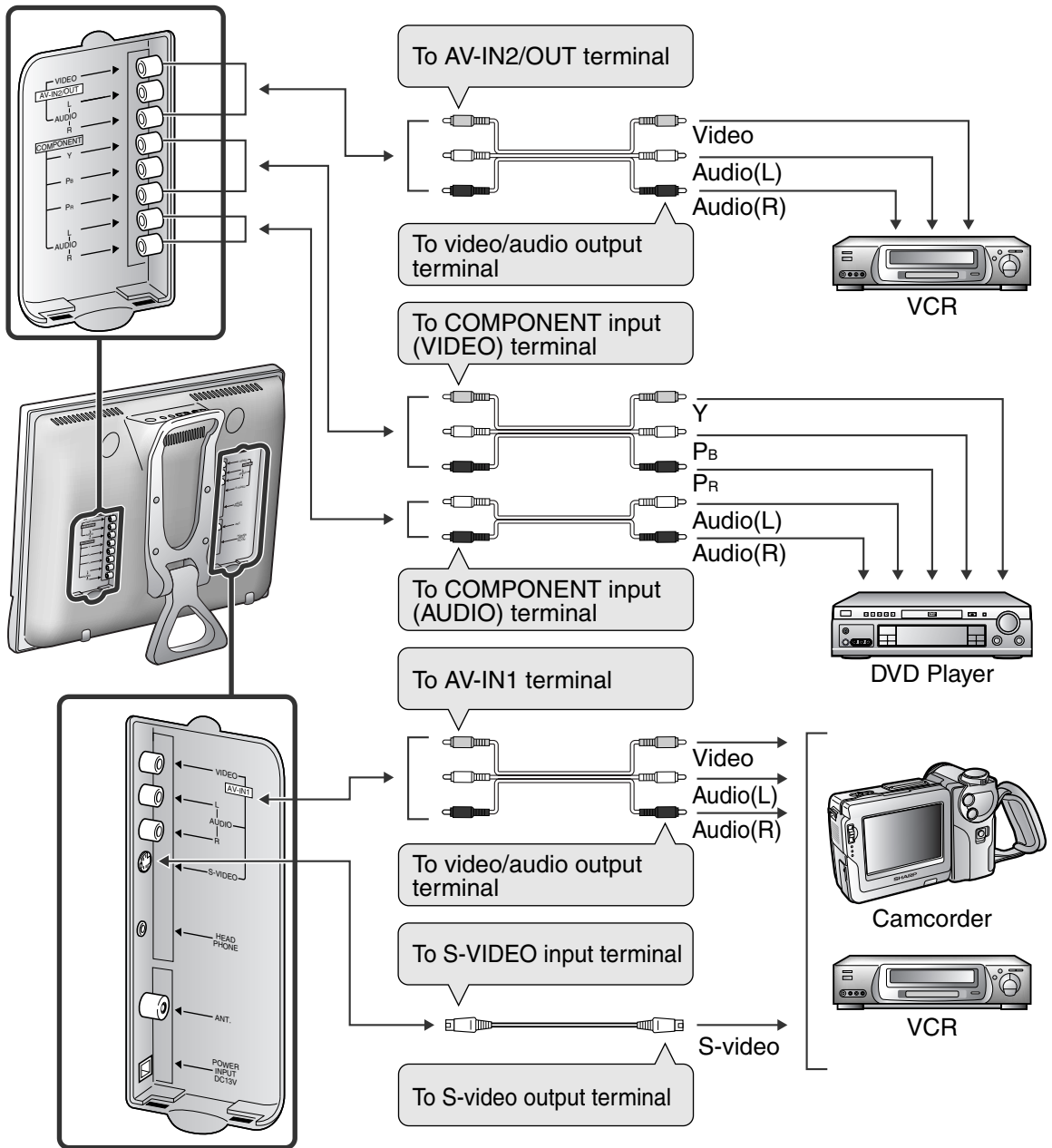

Note:

- If your VCR (or other external devices) has an S-Video terminal, S-VIDEO connection is recommended. (Use an S-video cord.)
- When you connect external devices to both S-VIDEO and VIDEO terminals (and if you select AV-IN1), you can only view pictures from the S-VIDEO terminal.
- You cannot view multiple or synthesized pictures by connecting two or more external devices. When connecting an external device, use care to connect the video and audio cables to the corresponding terminals.

CONNECTING WITH EXTERNAL DEVICES (Continued)

Outputting video and audio (video output)

You can output video and audio data from the TV set through the AV output terminals (AV-OUT).

- When using as an OUTPUT terminal, select FEATURE in the MENU and set AV2 IN/OUT to OUT. (See page 22.)
- The factory setting for AV2 IN/OUT is IN.

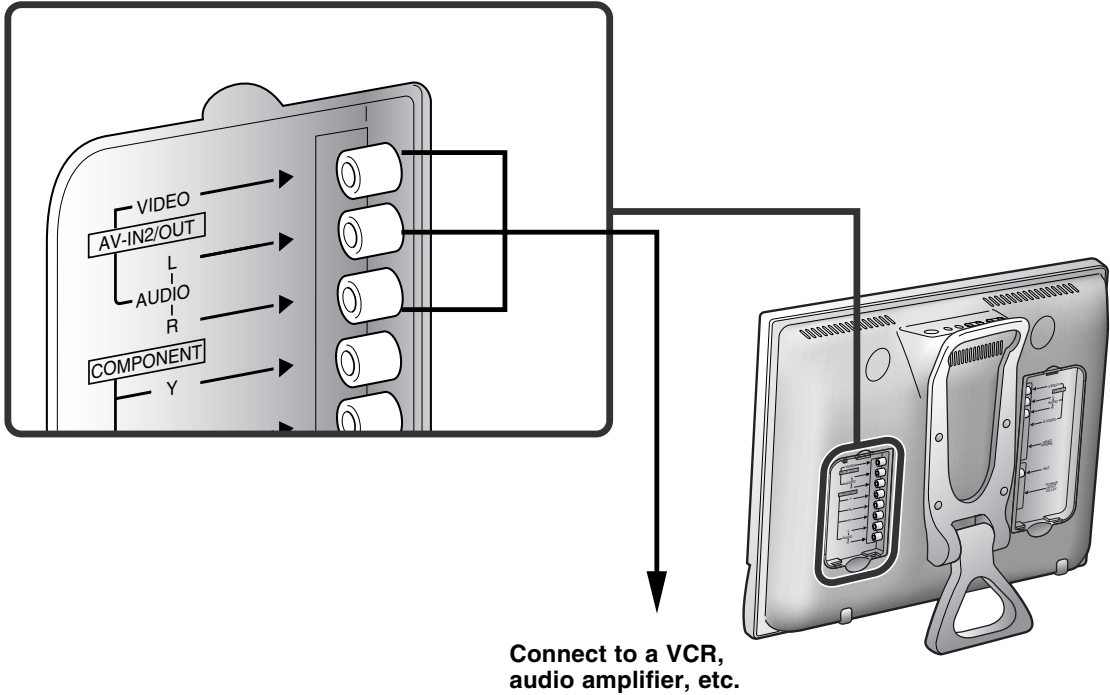

Note:

- AV2 has 2 OUT modes (see page 23).
- When using the S-VIDEO input for AV-IN1, no video output will be made to the AV output terminal, but audio output will be made for connection to external audio systems.
- When using the COMPONENT input, no video output will be made to the AV output terminal, but audio output will be made for connection to external audio systems.

HOW TO FIX THE CABLES



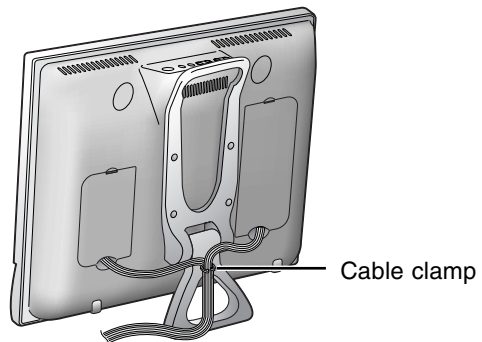

- Fix cables and cords with the attached cable clamp so that they do not get caught when mounting the cover.
- Connect the cables and cords after fixing the cable clamp.



TROUBLESHOOTING

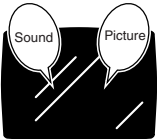
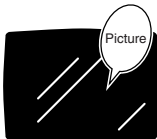

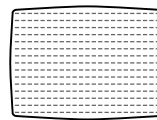
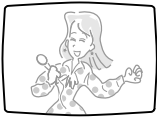

■ Before calling for repair service, check the following items for possible remedies to the encountered symptoms.

TV set

Problem	Check item	Reference Pages
 <p>There is no picture or sound.</p>	<ul style="list-style-type: none"> • Make sure the AC adapter is properly inserted in the power outlet. • Reception other than those of broadcasting stations can be considered. • Make sure the input mode is set to TV. • Make sure the MAIN POWER switch of the main unit is on. 	<p>6</p> <p>–</p> <p>11</p> <p>11</p>
 <p>There is no picture. There is no picture from AV-IN 1.</p>	<ul style="list-style-type: none"> • Make sure the BLACK LEVEL is properly adjusted. • Fluorescent lamp may have reached the end of service life. • Make sure the S-Video terminal is free of connections. 	<p>20, 21</p> <p>33</p> <p>29</p>
 <p>There is no sound.</p>	<ul style="list-style-type: none"> • Make sure the volume is not set to minimum. • Make sure the sound is not set to mute. 	<p>12</p> <p>12</p>
 <p>There is no picture or sound, just noise.</p>	<ul style="list-style-type: none"> • Make sure the antenna cable is properly connected. • Bad reception can be considered. 	<p>6</p> <p>–</p>
 <p>Picture is not clear.</p>	<ul style="list-style-type: none"> • Make sure the antenna cable is properly connected. • Bad reception can be considered. 	<p>6</p> <p>–</p>
 <p>Picture is light or improperly tinted.</p>	<ul style="list-style-type: none"> • Check colour adjustment. (NTSC mode) 	<p>20, 21</p>
 <p>The picture is too dark.</p>	<ul style="list-style-type: none"> • Check if BRIGHTNESS is set to DARK. • Check CONTRAST and BLACK LEVEL adjustment. • Fluorescent lamp may have reached the end of service life. 	<p>22</p> <p>20, 21</p> <p>33</p>
<p>Remote control does not work.</p>	<ul style="list-style-type: none"> • Check if batteries in the remote control have sufficient power. • Make sure the remote sensor window is not under strong fluorescent lighting. 	<p>5</p> <p>5</p>

TROUBLESHOOTING (Continued)

Antenna

Problem	Check item
 <p>The picture is not sharp.</p>  <p>The picture moves.</p>	<ul style="list-style-type: none"> • The reception may be weak. • The state of the broadcast may also be bad. • Make sure the antenna is facing the right direction. • Make sure the outside antenna is not disconnected.
 <p>The picture is doubled or tripled.</p>	<ul style="list-style-type: none"> • Make sure the antenna is facing the right direction. • There may be reflected electric waves from mountains or buildings.
 <p>The picture is spotted.</p>	<ul style="list-style-type: none"> • There may be interference from automobiles, trains, high voltage lines, neon lights, etc. • There may be interference between the antenna cable and power cable. Try positioning them further apart.
 <p>There are stripes on the screen or colours fade.</p>	<ul style="list-style-type: none"> • Is the unit receiving interference from other devices? Transmission antennas of radio broadcasting stations or amateur radios, and cellular phones may also cause interference. • Use the unit as far apart as possible from devices that may cause possible interference.

■ Use in hot and cold rooms (locations)

- When the unit is used in rooms (locations) with low temperature, the picture may leave trails or appear slightly delayed. This is not a malfunction, and the unit will recover when the temperature returns to normal.
- Do not leave the unit in a hot or cold location. Also, do not leave the unit in a location exposed to direct sunlight or near a heater, as this may cause the cabinet to deform and the LCD panel to malfunction. (Storage temperature: -20°C to +60°C)

SPECIFICATIONS

LCD COLOUR TV COMPARISON

ITEMS		MODEL	LC-13E1M	LC-15E1M	LC-20E1M
LCD panel			13" Advanced Super View & BLACK TFT LCD	15" Advanced Super View & BLACK TFT LCD	19.7" Advanced Super View & BLACK TFT LCD
Number of dots			921,600 dots VGA		
Video colour systems			World multi system		
TV FUNCTION	TV Standard		I/DK/M/BG		
	TV Tuning System		Auto preset tuning		
	STEREO/BILINGUAL		NICAM-BG, I, DK/IGR-BG		
	Universal R/C for TV only		Yes		
	AUTO PRESET		Yes		
	CATV		S1~S41 ch. Hyper Band		
4-LINE DIGITAL COMB FILTER			Yes		
Brightness			430 cd/m ²		
Lamp life			60,000 Hours		
Viewing angles			H: 170° V: 170°		
Audio output			2.1W×2		2.5W×2
Speakers			(3 × 7.5 cm), 2 pcs		(4 × 7 cm), 2 pcs
Terminals	AV1		Composite Video, S-Video, Audio		
	AV2 IN/OUT		Composite Video/Audio		
	Component		Y, PB, PR/Audio		
Headphone jack			3.5 mm ø jack (Rear)		
OSD LANGUAGE			English/Chinese/Arabic		
Power requirement			DC 12 V, AC110-240 V, 50/60Hz		DC 13V, AC110-240 V, 50/60Hz
Weight			3.8kg w/o accessories	4.5kg w/o accessories	7.1kg w/o accessories
Accessories			Wireless Remote Control, Batteries, Cable clamp, AC adapter, AC cord, Operation manual, Antenna cable		

- As a part of policy of continuous improvement, SHARP reserves the right to make design and specification changes for product improvement without prior notice. The performance specification figures indicated are nominal values of production units. There may be some deviations from these values in individual units.

DIMENSIONAL DRAWINGS

LC-13E1M

Unit: mm

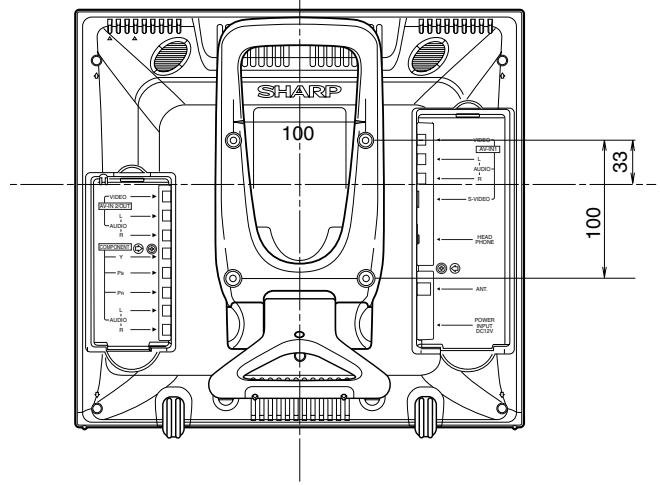
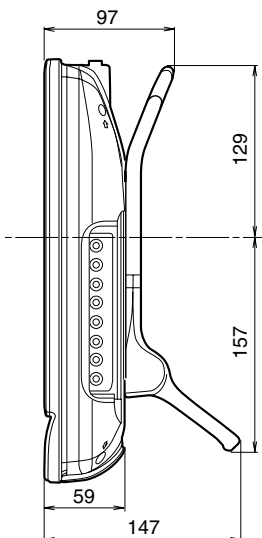
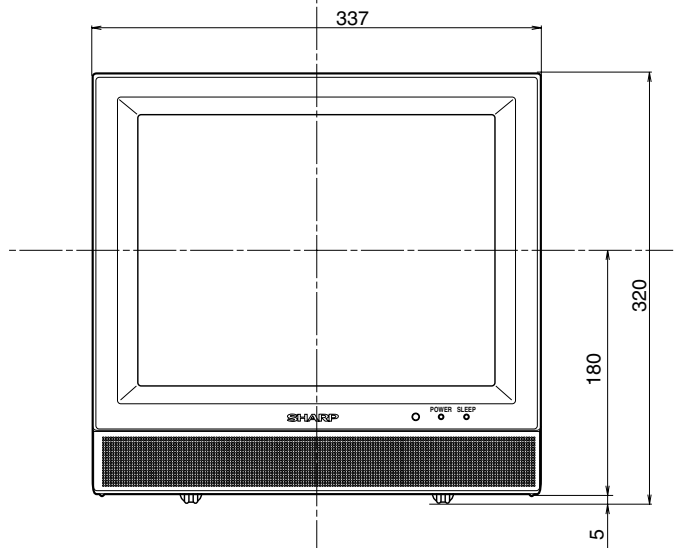
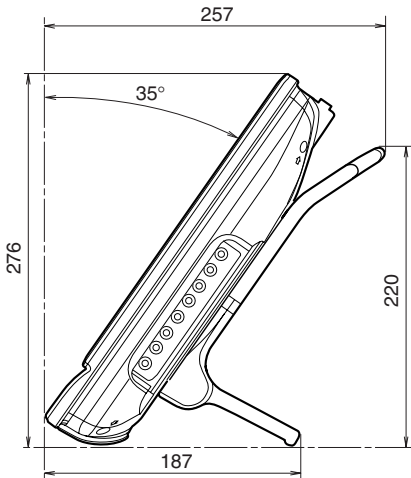
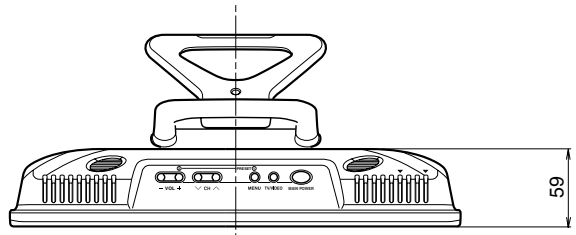
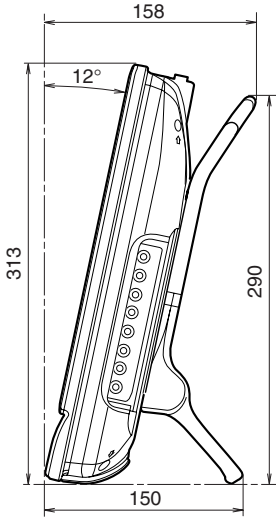

DIMENSIONAL DRAWINGS (Continued)

LC-15E1M

Unit: mm

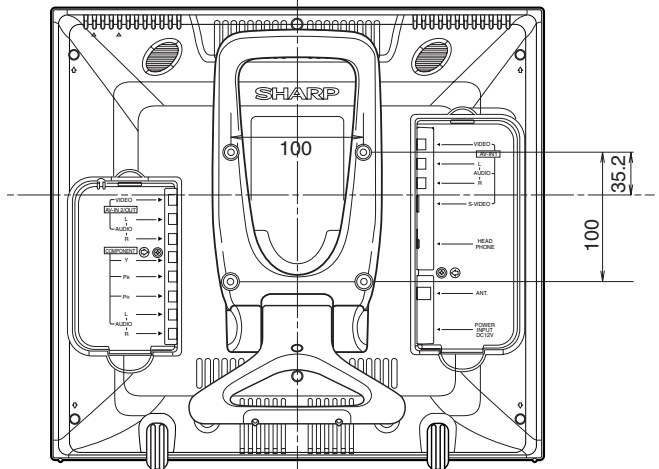
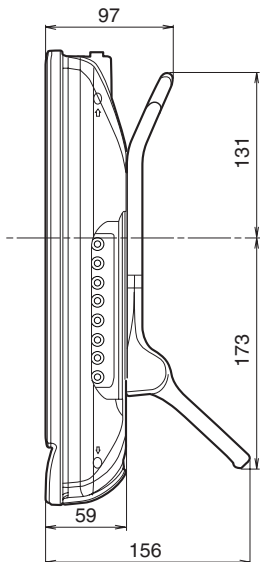
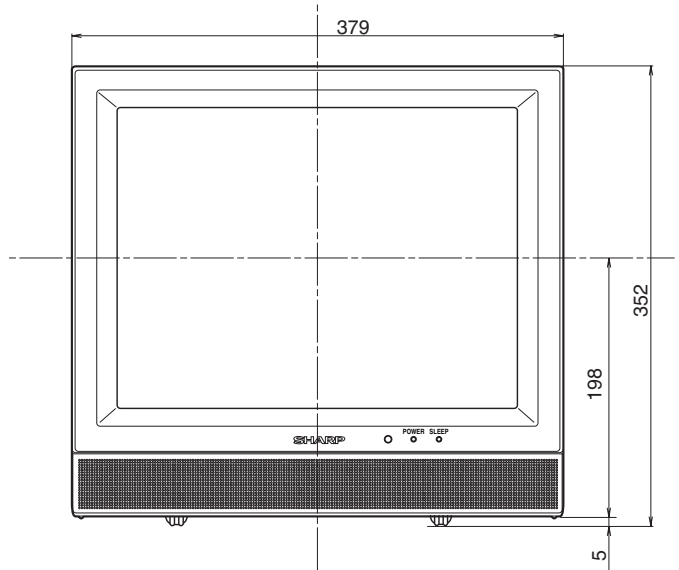
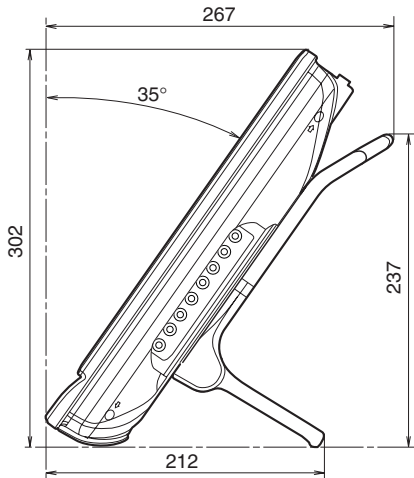
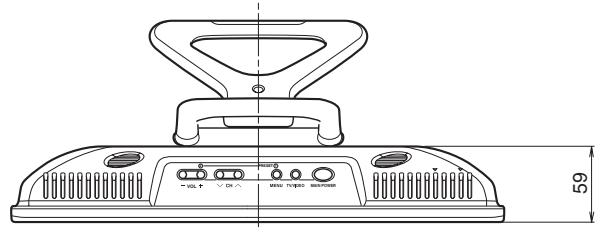
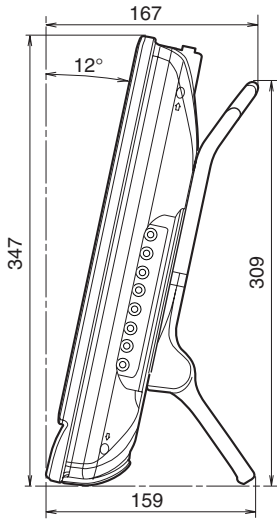

DIMENSIONAL DRAWINGS (Continued)

LC-20E1M

Unit: mm

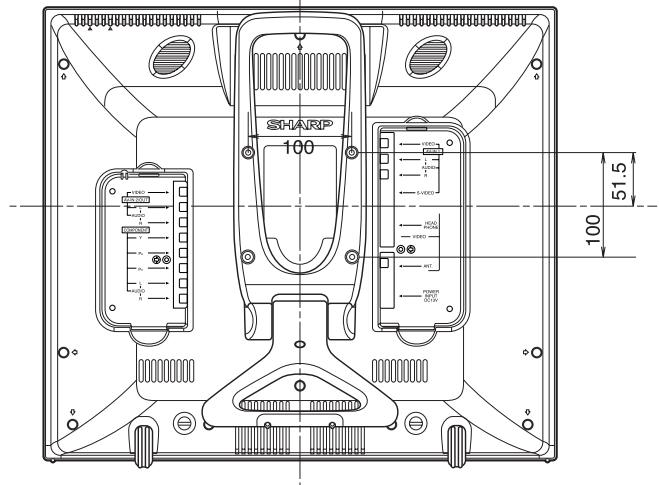
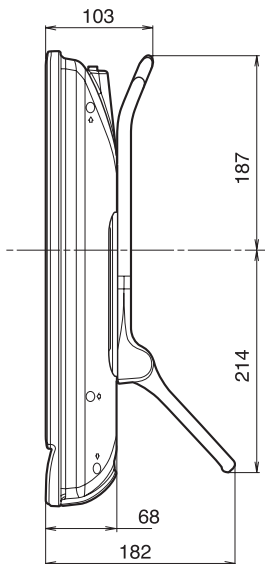
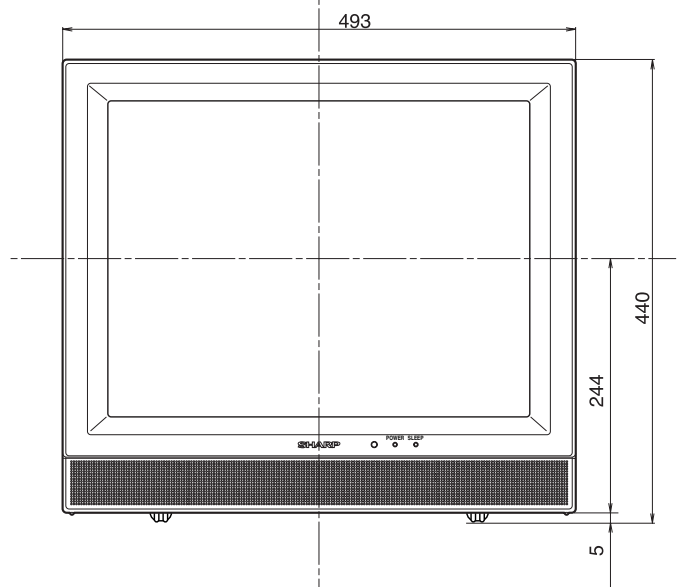
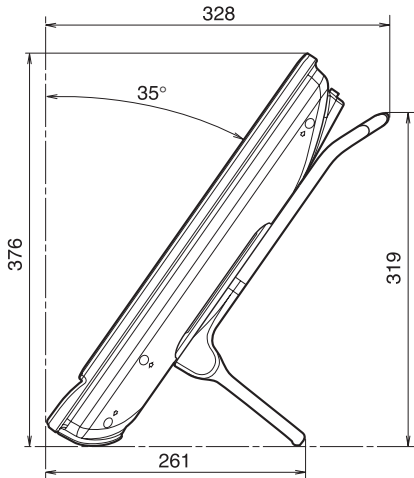
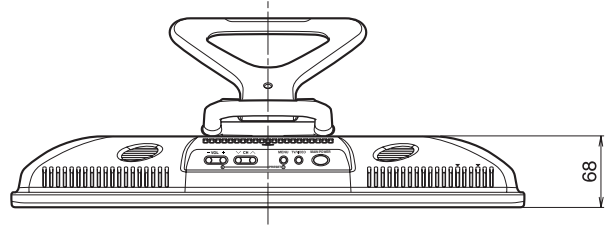
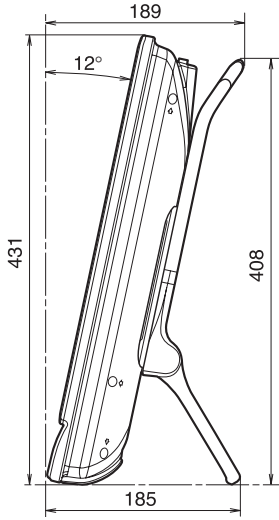

SHARP®

LC-13E1M
LC-15E1M
LC-20E1M

تلفزيون ملون بشاشة كريستال سائل

AQUOS



دليل التشغيل

طبع على ورق مكرر الاستخدام

طبع في اليابان

TINS-A280WJZZ
02P09-JKM

Free Manuals Download Website

<http://myh66.com>

<http://usermanuals.us>

<http://www.somanuals.com>

<http://www.4manuals.cc>

<http://www.manual-lib.com>

<http://www.404manual.com>

<http://www.luxmanual.com>

<http://aubethermostatmanual.com>

Golf course search by state

<http://golfingnear.com>

Email search by domain

<http://emailbydomain.com>

Auto manuals search

<http://auto.somanuals.com>

TV manuals search

<http://tv.somanuals.com>