

SHARP®

MODEL

LC-32L400X

LCD COLOUR TELEVISION

OPERATION MANUAL

AQUOS



HDMI™
HIGH-DEFINITION MULTIMEDIA INTERFACE



DOLBY
DIGITAL

Supplied accessories

Remote control unit

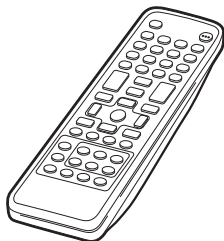

“AA” size battery (× 1)



Operation manual

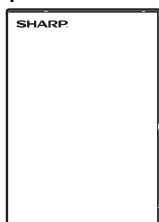

Stand unit

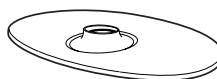

Stand base



Screws (× 4)

Safety restrains

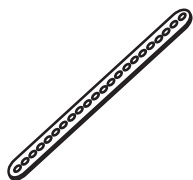

Restraining band



Screw for band



Clamps



Screws for clamps

Contents

	Page		Page
Supplied accessories.....	1	ECO menu	12
Dear SHARP customer.....	2	Setup menu	12
Important Safety Precautions	2	Option menu	14
Important information.....	2	Digital setup menu	16
Trademarks.....	2	Programme Guide	17
Attaching the stand.....	3	Info.....	17
Antenna connection.....	3	ATV (Analogue/DTV/RADIO buttons).....	18
Connecting external devices.....	4	Switching the analogue audio format	18
Remote control unit	5	EPG.....	20
Part names.....	6	Picture and still image	21
Turning the TV on/off.....	7	Wide Mode	21
Supplying electric power to the antenna	7	Teletext function.....	22
Initial auto installation.....	7	PC Control of the TV	22
Checking Signal information.....	7	PC compatibility chart	23
Auto installation.....	8	RS-232C commands list	23
Programme setup	8	Appendix	24
Selecting a preset AV mode	10	Specifications	25
Menu operation	10	Protection against overturning	26
Picture menu.....	11	Dimensional drawings.....	26
Audio menu	11	CLEARING THE PASSWORD.....	27

Dear SHARP customer

Thank you for your purchase of the SHARP LCD colour TV product. To ensure safety and many years of trouble-free operation of your product, please read the Important Safety Precautions carefully before using this product.

Important Safety Precautions

- **Cleaning** — Unplug the AC cord from the AC outlet before cleaning the product. Use a soft damp cloth to clean the product. Do not use liquid cleaners, aerosol cleaners or chemical cloth to clean it, as such materials may damage the product.
- **Water and moisture** — Do not use the product near water, such as bathtub, washbasin, kitchen sink, laundry tub, swimming pool and in a wet basement.
- **Do not place vases or any other water-filled containers on this product.**
The water may spill onto the product causing fire or electric shock.
- **Stand** — Do not place the product on an unstable cart, stand, tripod or table. Doing so can cause the product to fall, resulting in serious personal injuries as well as damage to the product. Use only a cart, stand, tripod, bracket or table recommended by the manufacturer or sold with the product. When mounting the product on a wall, be sure to follow the manufacturer's instructions. Use only the mounting hardware recommended by the manufacturer.
- **When relocating the product placed on a cart, it must be moved with utmost care.** Sudden stops, excessive force and uneven floor surface can cause the product to fall from the cart.
- **Ventilation** — The vents and other openings in the cabinet are designed for ventilation. Do not cover or block these vents and openings since insufficient ventilation can cause overheating and/or shorten the life of the product. Do not place the product on a bed, sofa, rug or other similar surface, since they can block ventilation openings. This product is not designed for built-in installation; do not place the product in an enclosed place such as a bookcase or rack, unless proper ventilation is provided or the manufacturer's instructions are followed.
- **The LCD panel used in this product is made of glass.** Therefore, it can break when the product is struck forcefully or with a sharp object. If the LCD panel is broken, be careful not to be injured by broken glass.
- **Heat sources** — Keep the product away from heat sources such as radiators, heaters, stoves and other heat-generating products (including amplifiers).
- **To prevent fire, never place any type of candle or naked flames on the top or near the TV set.**
- **To prevent fire or shock hazard, do not place the AC power cord under the TV set or other heavy items.**
- **Do not place heavy objects on this product or stand on it.** Doing so could cause injury if the product overturns. Take special care near children and pets.
- **The LCD panel is a very high technology product with 1,049,088 pixels, giving you fine picture details.**
Due to the very large number of pixels, occasionally a few non-active pixels may appear on the screen as a fixed point of blue, green or red.
This is within product specifications and does not constitute a fault.
- **Precautions when transporting the TV**
When transporting the TV, never carry it by holding or otherwise putting pressure onto the display. Be sure to always carry the TV by two people holding it with two hands — one hand on each side of the TV.
- **Do not display a still picture for a long time, as this could cause an afterimage to remain.**
- **Install the product on the place where the AC cord can be unplugged easily from the AC outlet, or from the AC INPUT terminal on the rear of the product.**
- **If a television is not positioned in a sufficiently stable location, it can be potentially hazardous due to falling.** Many injuries, particularly to children, can be avoided by taking simple precautions such as:
 - Using cabinets or stands recommended by the manufacturer of the television.
 - Only using furniture that can safely support the television.
 - Ensuring the television is not overhanging the edge of the supporting furniture.
 - Not placing the television on tall furniture (for example, cupboards or bookcases) without anchoring both the furniture and the television to a suitable support.
 - Not standing the televisions on cloth or other materials placed between the television and supporting furniture.
 - Educating children about the dangers of climbing on furniture to reach the television or its controls.

Important information

This product qualifies for ENERGY STAR when "Home" is selected for "TV location".
Setting "TV Location" to "Home" allows the TV to achieve an energy-saving status for household use.

Trademarks

- "HDMI, the HDMI logo and High-Definition Multimedia Interface are trademarks or registered trademarks of HDMI Licensing LLC."
- Manufactured under license from Dolby Laboratories. Dolby and the double-D symbol are trademarks of Dolby Laboratories.
- Products that have earned the ENERGY STAR® are designed to protect the environment through energy efficiency.

Attaching the stand

- Before attaching (or detaching) the stand, unplug the AC cord from the AC outlet.
- Before performing work spread cushioning over the base area to lay the TV on. This will prevent it from being damaged.

1 Confirm the screws supplied with the TV.

Screws (× 4)
(used in step 3)



2 Insert the stand base to the stand post on the bottom of the TV. (①)

3 Insert and tighten the 4 screws into the 4 holes on the bottom of the stand base. (②)

NOTE

- To detach the stand, perform the steps in reverse order.

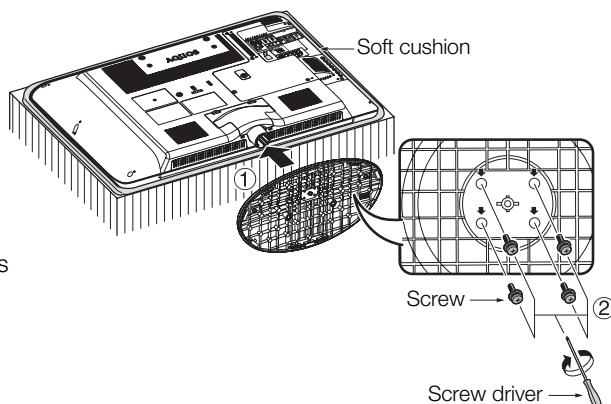

Antenna connection

Connecting the antenna cable

To enjoy a clearer picture, use an outdoor antenna.

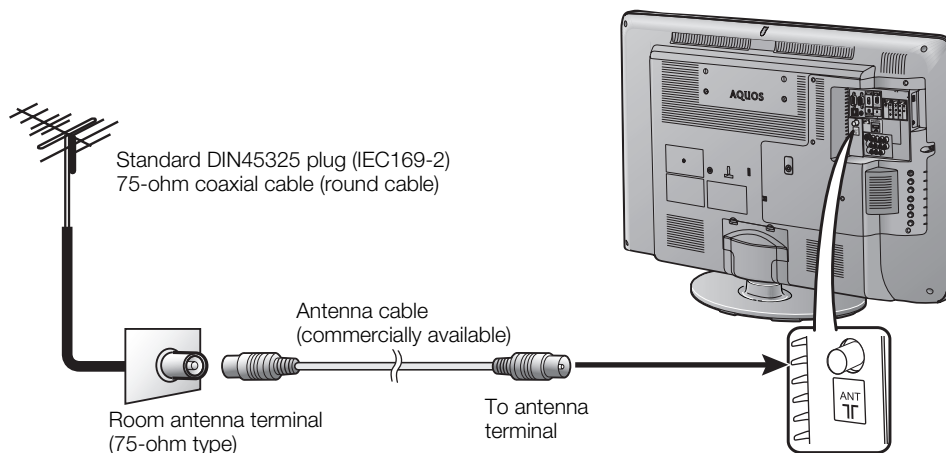

CAUTION

- **TO PREVENT RISK OF ELECTRIC SHOCK, DO NOT TOUCH UN-INSULATED PARTS OF ANY CABLES WITH THE AC CORD CONNECTED.**

Connecting external devices

You can connect many types of external equipment to your TV, like a VCR, game console, camcorder, DVD player, Digital TV STB (Set Top Box) and PC. To view external source images, select the input source from **TV/VIDEO** on the remote control unit or **TV/VIDEO** on the TV.

CAUTION

- To protect all equipment, always turn off the TV before connecting to a VCR, game console, camcorder, DVD player, Digital TV STB (Set Top Box), PC or other external equipment.
- Refer to the relevant operation manual (VCR, DVD player, etc.) carefully before making connections.

Connecting a VCR, game console or camcorder

A VCR, game console, camcorder and some other audiovisual equipment can be conveniently connected using the INPUT 2/INPUT 3 or INPUT 4 terminals.

When using component cable (commercially available)

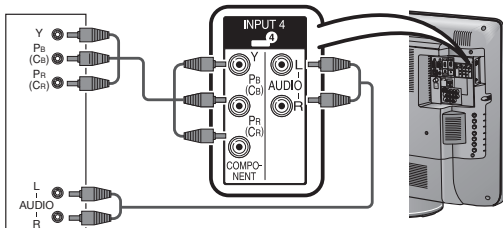

VCR/Game console/Camcorder

When using composite cable or S-VIDEO cable (commercially available)

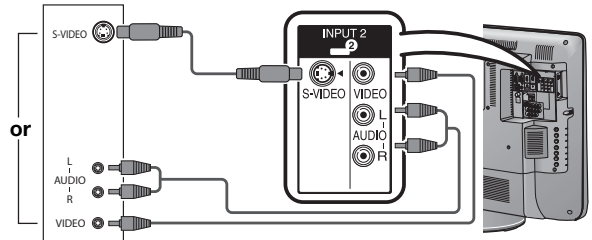

VCR/Game console/Camcorder

Connecting a DVD player/Digital TV STB (Set Top Box)

You can use the INPUT 1 (HDMI), INPUT 4 terminals when connecting to a DVD player/Digital TV STB (Set Top Box) and other audiovisual equipment.

When using HDMI-certified cable (commercially available)

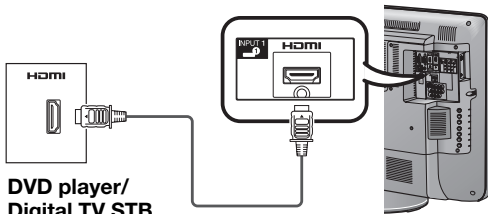

DVD player/
Digital TV STB
(Set Top Box)

When using component cable (commercially available)

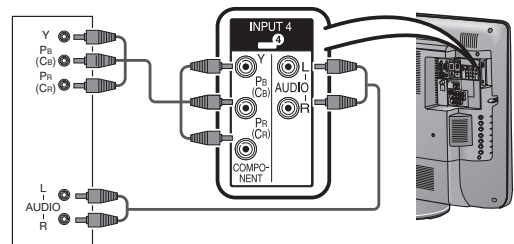

DVD player/Digital TV STB (Set Top Box)

Connecting a PC

You can use the INPUT 5 (PC) terminals when connecting to a PC.

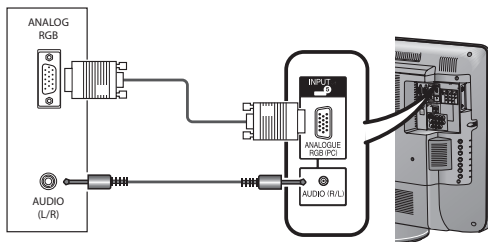

PC

Using Digital Audio Output

It is possible to output audio through the DIGITAL AUDIO OUTPUT terminal. PCM audio outputs from the terminal.

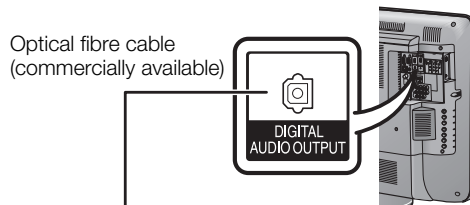

To optical digital input of external audio devices

NOTE

- The DIGITAL AUDIO OUTPUT terminal usually outputs the same audio from the speakers. (The audio of the content you are viewing is output from the terminal.)
- The DIGITAL AUDIO OUTPUT terminal does not output some signals, depending on devices and software.

Remote control unit

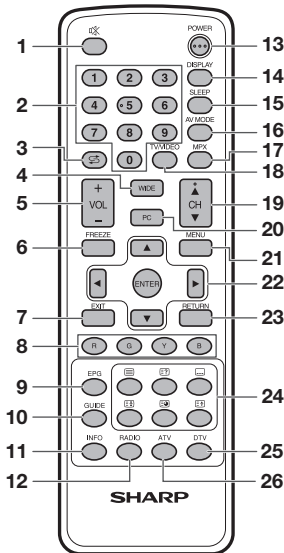

1 Mute

Press → Mutes sound.
Press again → Restores sound.
Mute will be cancelled after 30 minutes. However, the TV will not suddenly output loud sound as the volume level will be set to 0 automatically. Increase the volume level by pressing **VOL +**.

2 0 - 9

Set the channel.
TELETEXT mode: Set the page. (See page 22.)

3 Flashback

Press to return to the previous selected channel or external input mode.

4 WIDE

Change the wide image mode. (See page 21.)

5 VOL + /VOL -

Set the volume.
(**VOL +**) Increase the volume.
(**VOL -**) Decrease the volume.

6 FREEZE

Freeze a motion picture on the screen. (See page 21.)

7 EXIT

Return to the default screen.

8 Colour (Red/Green/Yellow/Blue)

TELETEXT mode: Select a page. (See page 22.)

9 EPG

DTV mode: To display EPG (Electronic Programme Guide) screen. (See pages 20 to 21.)

10 GUIDE

DTV mode: Display the programme list. (See page 17.)

11 INFO

DTV mode: Display the programme information. (See page 17.)

12 RADIO

Press to access RADIO mode. (See page 18.)

13 POWER (STANDBY/ON)

To switch the power on and off. (See page 7.)

14 DISPLAY

Display the channel or input information.

15 SLEEP

Set the Sleep timer.

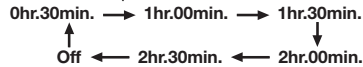

16 AV MODE

Select an audio and video setting. (See page 10.)

17 MPX

Select the sound multiplex mode.

18 TV/VIDEO (INPUT SOURCE)

Select an input source.

19 CH▲/CH▼

TV input mode: Select the channel.

(**CH▲**) Increase the channel number.

(**CH▼**) Decrease the channel number.

TELETEXT mode: Select the page. (See page 22.)

20 PC

Directly select the PC terminal.

21 MENU

Display the menu screen.

22 ▲/▼/◀/▶ (Cursor)

Select a desired item on the setting screen.

ENTER

Execute a command.

23 RETURN

MENU mode: Return to the previous menu screen.

24 (TELETEXT)

Select the TELETEXT mode. (all TV image, all TEXT image, TV/TEXT image) (See page 22.)

(Reveal hidden for TELETEXT)

TELETEXT mode: Display hidden characters. (See page 22.)

(SUBTITLE for TELETEXT)

To turn the subtitles on. (See page 22.)

(Hold)

TELETEXT mode: Stop updating Teletext pages automatically. Press again to release the hold mode. (See page 22.)

(Subpage)

Display the Teletext subpage directly when in Teletext mode. (See page 22.)

(Top/Bottom/Full)

TELETEXT mode: Set the area of magnification. (See page 22.)

25 DTV

Press to access DTV mode. (See page 18.)

26 ATV

Press to access ATV mode. (See page 18.)

Inserting the battery

Before using the TV for the first time, insert a "AA" size battery (supplied). When the battery become depleted and the remote control fails to operate, replace the battery with new "AA" size battery.

1 Open the battery cover.

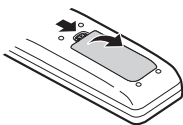

2 Insert the supplied "AA" size battery.

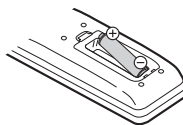

3 Close the battery cover.

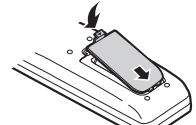

- Place battery with their terminals corresponding to the (+) and (-) indications in the battery compartment.



- Battery (battery pack or batteries installed) shall not be exposed to excessive heat such as sunshine, fire or the like.

Part names

TV (Front)

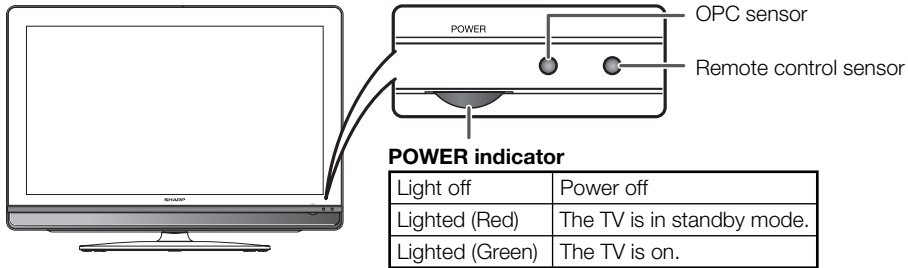

TV (Rear)

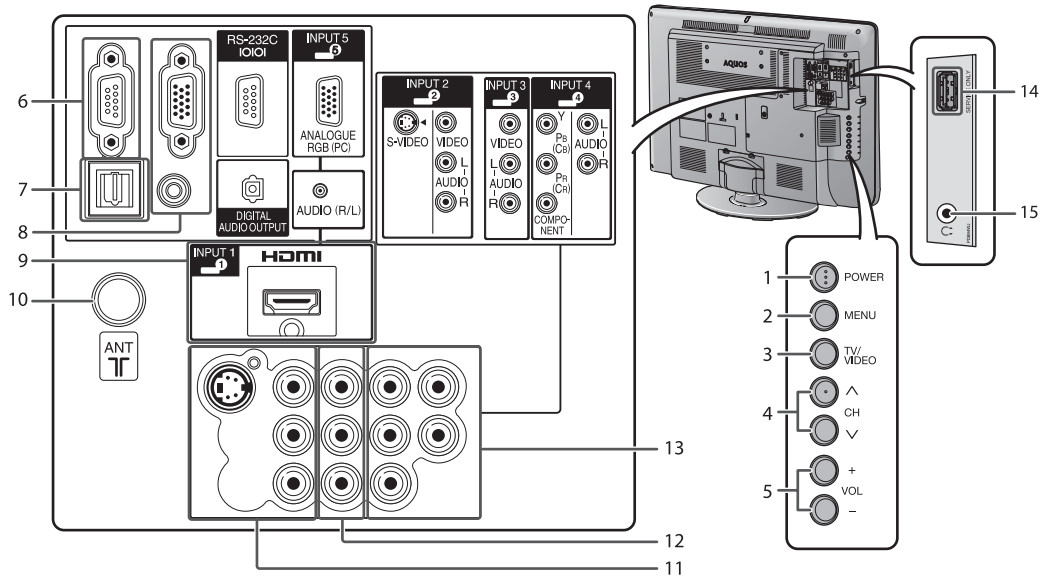

- | | |
|-----------------------------------|----------------------------|
| 1 POWER (On/Off) button | 9 INPUT 1 (HDMI) terminal* |
| 2 MENU button | 10 Antenna input terminal |
| 3 TV/VIDEO button | 11 INPUT 2 terminals |
| 4 Channel up (▲)/down (▼) buttons | 12 INPUT 3 terminals |
| 5 Volume up (+)/down (-) buttons | 13 INPUT 4 terminals |
| 6 RS-232C terminal | 14 SERVICE ONLY terminal** |
| 7 DIGITAL AUDIO OUTPUT terminal | 15 Headphone jack |
| 8 INPUT 5 (PC) terminals* | |

* The INPUT 1 and INPUT 5 terminals can both use the same analogue audio input terminal. However, the proper item must be selected in the "PC audio select" menu. (See page 14.)

**Usually do not connect anything to this terminal as it is reserved only for service personnel.

• The illustrations in this operation manual are for explanation purposes and may vary slightly from the actual operations.

Regarding the headphone jack

- Use headphones with a stereo mini plug (ϕ 3.5 mm).
- Be sure to unplug headphones from the jack when they are not in use.
- The speakers do not output volume when headphones are plugged in.
- The "Audio" menu cannot be operated when headphones are plugged in.

Volume display when headphones are plugged in



Turning the TV on/off

Turning on/off the power

• To turn on the power

Press **POWER** on the TV. (After a few seconds, an image appears with sound.)

• To turn off the power

Switch it off by pressing **POWER** on the TV.

Standby mode

• To standby mode

If the TV is switched on, you can switch it to standby by pressing **POWER** on the remote control.

• Switching on from standby

From standby, press **POWER** on the remote control.

NOTE

- If you are not going to use this TV for a long period of time, be sure to remove the AC cord from the AC outlet.
- Minor power is consumed when the unit is in standby mode.

Supplying electric power to the antenna

When you set-up the DTV antenna for the first time, or connect the antenna to a community antenna, you need to proceed to set the antenna by following this manual.

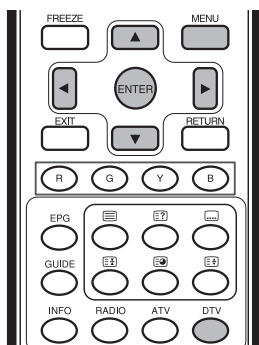

- 1 Press **DTV** to access DTV mode.
- 2 Press **MENU** and the MENU screen displays.
- 3 Press **◀/▶** to select "Setup".
- 4 Press **▲/▼** to select "Digital programme setup" and then press **ENTER**.
- 5 Press **▲/▼** to select "Antenna power" and then press **ENTER**.
- 6 Press **◀/▶** to select "Yes" and then press **ENTER**.

Selected item	Description
Yes	Select "Yes" when your antenna is set-up and connected independently.
No	Select "No" when you do not need to supply voltage to your antenna, i.e. when your antenna is connected to a community antenna. (The factory default setting of this function is "No".)

Initial auto installation

When the TV powers on for the first time after purchase, the initial auto installation wizard appears. Follow the menus and make the necessary settings one after another.

- 1 Press **POWER** on the TV.
 - The initial auto installation wizard appears.
- 2 Press **◀/▶** to select "HOME" or "STORE", and then press **ENTER**. Press **◀/▶** to select your country channels listed on the screen, and then press **ENTER**. Press **▲/▼/◀/▶** to select "DTV", "ATV" or "ATV + DTV", and then press **ENTER**. Press **▲/▼** to select the desired sound system, and then press **ENTER**.
 - Sound system is selectable when the signal search is set to "ATV" or "ATV + DTV" mode only.
 - Auto installation will be executed.
 - You do not need to do anything during the auto search.
 - HOME: "STANDARD" will be the default value for the "AV mode" setting.
 - STORE: "DYNAMIC (FIXED)" will be the default value for the "AV mode" setting. If the "AV mode" is changed, the TV will automatically switch back to "DYNAMIC (FIXED)" when there is no further change to TV setting for 30 minutes.
 - To change the STORE mode to HOME mode, please refer to page 14 to reset the unit.

Checking Signal information

If you install a DVB-T antenna for the first time or relocate it, you should adjust the alignment of the antenna to receive a good reception while checking the antenna setup screen.

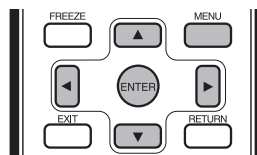

- 1 Press **MENU** and the MENU screen displays.
- 2 Press **◀/▶** to select "Setup".
- 3 Press **▲/▼** to select "Digital programme setup", and then press **ENTER**.

Checking Signal information (Continued)

Checking Signal information

Press ▲/▼ to select "Signal information".

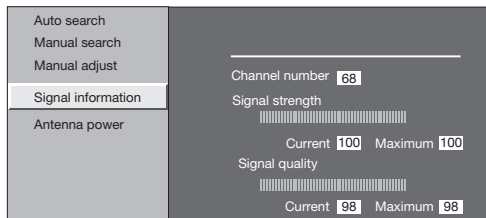

- Position and align the antenna so that the maximum possible values for "Signal strength" and "Signal quality" are obtained.

NOTE

- The values of "Signal strength" and "Signal quality" indicate when to check the appropriate alignment of the antenna.

Auto installation

You can run auto installation again, even after setting up the preset channels.

- Press **MENU** and the MENU screen displays.

- Press ◀/▶ to select "Setup".

- Press ▲/▼ to select "Auto installation", and then press **ENTER**.

- If you have already set the password, enter it here.
 - See page 12 for setting a password.

- Press ◀/▶ to select "Yes", and then press **ENTER**.

- Press ▲/▼/◀/▶ to select "DTV", "ATV" or "ATV + DTV", and then press **ENTER**. Press ▲/▼ to select the desired sound system, and then press **ENTER**.
 - Sound system is selectable when the signal search is set to "ATV" or "ATV + DTV" mode only.
 You do not need to do anything during the auto search. Press **MENU** to exit.

Programme setup

Digital settings

You can reconfigure DTV services settings automatically or manually.

- Press **MENU** and the MENU screen displays.

- Press ◀/▶ to select "Setup".

- Press ▲/▼ to select "Digital programme setup", and then press **ENTER**. If you have already set the password, enter it here.
 - See page 12 for setting a password.

- Press ▲/▼ to select the desired menu item, and then press **ENTER**.

- Press ◀/▶ to select "Yes", and then press **ENTER**.

Auto search (Digital)

Use this menu to add new services automatically after auto installation has been completed.

Manual search (Digital)

Add new services within a specified frequency band.

- Press ◀/▶ to select the frequency and then press **ENTER**.

Manual adjust (Digital)

Configure various settings for each service using the Colour (**R, G, B**) buttons.

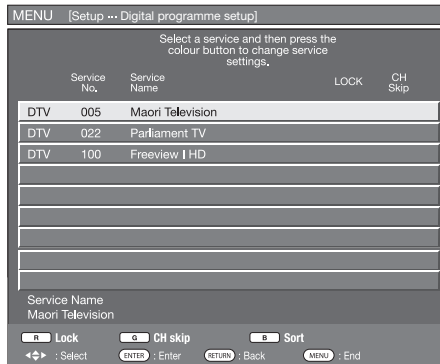

- Press ▲/▼ to select desired service.

- Press the colour button on the remote control corresponding with the item you want to reconfigure.
 - Each time the colour button is pressed, you can switch the corresponding operation on/off.

Buttons for Manual adjust operation

Menu items	Remote control buttons	Description
Lock	R	When the service is locked, you must enter your password whenever you tune to the service.
CH Skip	G	Services with "Skip" are passed over when pressing ▲/▼ in the TV/remote control unit.
Sort	B	The item position of services can be sorted.

Programme setup (Continued)

The item position of services can be sorted

- 1 Press **▲/▼** to select the service whose item position you want to move, and then press **B**.

DTV	005	Maori Television
DTV	022	Parliament TV
DTV	100	Freeview I HD

- 2 Press **▲/▼** to move it to the desired position, and then press **ENTER**.

DTV	100	Freeview I HD
DTV	022	Parliament TV
DTV	005	Maori Television

- 3 Repeat steps 1 and 2 until all desired service items are sorted.

Analogue settings

Auto search (Analogue)

You can also automatically search by performing the procedure below. This is the same function as programme auto search in auto installation.

- 1 Press **MENU** and the MENU screen displays.

- 2 Press **◀/▶** to select "Setup".

- 3 Press **▲/▼** to select "Analogue programme setup", and then press **ENTER**.

- 4 If you have already set the password, enter it here.

- See page 12 for setting a password.

— — — —

- 5 Press **▲/▼** to select "Auto search", and then press **ENTER**.

- 6 Press **◀/▶** to select "Yes", and then press **ENTER**.

Press **▲/▼** to select the desired sound system, and then press **ENTER**.
You do not need to do anything during the auto search. Press **MENU** to exit.

Manual adjust (Analogue)

You can set some channel item manually.

- 1 Repeat steps 1 to 4 in **Auto search**.

- 2 Press **▲/▼** to select "Manual adjust", and then press **ENTER**.

- 3 Press **◀/▶** to select "Yes", and then press **ENTER**.

- 4 Press **▲/▼/◀/▶** to select the channel you want to edit, and then press **ENTER**.
 - The selected channel information displays.

- 5 Press **▲/▼** to select the desired menu, and then press **ENTER**.

- 6 Press **▲/▼** or **◀/▶** to select the desired item or adjust the item to the desired level. Press **ENTER** if necessary.

Search

The next channel will be search in order.

Fine

You can adjust the frequency to your desired position.

NOTE

- Adjust while checking the background picture as a reference.
- Instead of pressing **◀/▶** to adjust the frequency, you can set by directly entering the frequency number of the channel with **0 — 9**.

EXAMPLE

- 179.25 MHz: Press **1 → 7 → 9 → 2 → 5**.
- 49.25 MHz: Press **4 → 9 → 2 → 5 → ENTER**.

Colour system

Select the optimum colour system to receive. (Auto, PAL, SECAM, NTSC 4.43, PAL-60)

Sound system (Broadcasting system)

Select the optimum sound system (Broadcasting system) to receive. (B/G, D/K, I)

Label

To enter the name of the channel. Maximum 5 alphanumeric can be input.

- Press **▲/▼/◀/▶**: To select a desired alphanumeric, and then press **ENTER**.
Repeat until the name is fully spelt out.

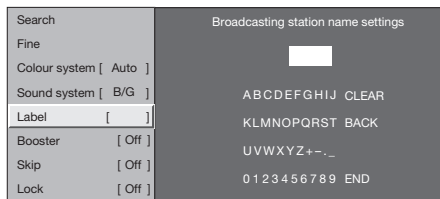

- To exit, select **END** and then press **ENTER**.
- If the wrong alphanumeric is entered, select **CLEAR** to clear, and then press **ENTER**.

Booster

Enhance the picture quality during weak signal. It is not recommended to turn on during strong signal condition. It may induced unwanted noise. (On, Off)

Skip

Channels with "Skip" set to "On" are passed over when using **CH▲/▼** even if selected while watching the image from the TV.

Lock

You can block the viewing of any channel.

NOTE

- See "Child lock" for setting a password.
- If "Lock" is set to "On" for a channel, "Child lock has been activated" is displayed when you select the channel, and the image and sound of the channel is blocked.
- When pressing **ENTER** while "Child lock has been activated" is displayed, password input menu will be displayed. Inputting the correct password lifts the child lock temporarily until the power is turned off.

Programme setup (Continued)

■ Sort (Analogue)

Channel position can be sorted freely.

- 1 Repeat steps 1 to 4 in **Auto search**.
- 2 Press ▲/▼ to select “Sort”, and then press **ENTER**.
- 3 Press ◀/▶ to select “Yes”, and then press **ENTER**.
- 4 Press ▲/▼/◀/▶ to select the channel you want to move, and then press **ENTER**.
- 5 Move it to the desired position by pressing ▲/▼/◀/▶, and then press **ENTER**.
- 6 Repeat the steps 4 and 5 until all desired channels are sorted.

■ Erase programme (Analogue)

The individual programme can be erased.

- 1 Repeat steps 1 to 4 in **Auto search**.
- 2 Press ▲/▼ to select “Erase programme”, and then press **ENTER**.
- 3 Press ◀/▶ to select “Yes”, and then press **ENTER**.
- 4 Press ▲/▼/◀/▶ to select the channel you want to erase, and then press **ENTER**.
- 5 Press **ENTER** to erase the channel.
- 6 Repeat the step 4 and 5 until all desired channels are erased.

Selecting a preset AV mode

“AV mode” gives you several viewing options to choose from to best match the system environment, which can vary due to factors like room-brightness, type of programme watched or the type of image input from external equipment.

- 1 Press **AV MODE**.
- 2 Each time you press **AV MODE**, the mode changes.
 - You can also switch the mode in the “AV mode” menu on the “Picture” menu screen.

Selected item	Description
STANDARD	For a highly defined image in a normally bright room.
MOVIE	For a movie.
GAME	For game play.
PC	For PC. (Available only when inputting an HDMI or PC signal.)
USER	Allows the user to customise settings as desired. You can set the mode for each input source.
DYNAMIC (FIXED)	Changes the image and sound settings to the factory preset values. No adjustments are allowed.
DYNAMIC	For a clear-cut image emphasising high contrast for sports viewing.

NOTE

- You can select a different AV mode item for each input mode. (For example, select STANDARD for TV input and DYNAMIC for VIDEO input.)
- During PC input mode, only “STANDARD”, “PC” and “USER” can be selected under the AV mode selection.

Menu operation

- 1 Press **MENU** and the MENU screen displays.
- 2 Press ◀/▶ to select the desired menu. (Picture, Audio, ECO, Setup, Option, Digital setup)
- 3 Press ▲/▼ to select the desired menu item. Press **ENTER** to proceed if necessary.
- 4 Press ▲/▼ or ◀/▶ to select the desired item or adjust the item to the desired level. Press **ENTER** if necessary.

Picture menu



OPC (Optical Picture Control) setting

You can set the TV to automatically adjust the screen to suitable backlight brightness according to the lighting conditions.

Selected item	Description
On:Display	Displays the OPC effect on the screen while adjusting the brightness of the screen.
On	Automatically adjusts.
Off	The brightness is fixed at the value set in "Backlight".

NOTE

- Make sure no object obstructs the OPC sensor, which could affect its ability to sense surrounding light.

Picture adjustments

Selected item	◀ button	▶ button
Backlight	The screen dims	The screen brightens
Contrast	For less contrast	For more contrast
Brightness	For less brightness	For more brightness
Colour	For less colour intensity	For more colour intensity
Tint	Skin tones become purplish	Skin tones become greenish
Sharpness	For less sharpness	For more sharpness

Advanced

Colour temp. (Colour Temperature)

Adjusts the colour temperature to give the best white image.

Selected item	Description
High	White with bluish tone
Mid-High	
Middle	
Mid-Low	
Low	White with reddish tone

Film mode

Automatically detects a film-based source (originally encoded at 24/25 frames/second, depending on the vertical frequency), analyses it then recreates each still film frame for high-definition picture quality. (On, Off)

Active contrast

Automatically adjusts the contrast of an image according to the scene. (On, Off)

3D-Y/C

Provides high quality images with minimal dot crawl and cross colour noise. (On, Off)

NOTE

- 3D-Y/C is not selectable depending on the input signal type.
- 3D-Y/C may not operate depending on the input signal type or noisy input signal.

Monochrome

For viewing images in monochrome. (On, Off)

DNR (Digital Noise Reduction)

Reduces noise on screen and produces a clearer video image. (Off, High, Low, Auto)

NOTE

- For resetting all Picture adjustment items to factory preset values, press ▲/▼ to select "Reset", press **ENTER**, press ◀/▶ to select "Yes", and then press **ENTER**.

Audio menu

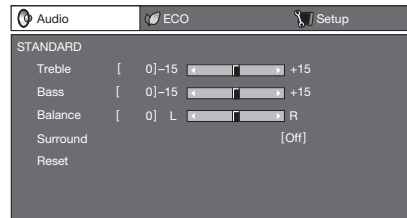

Audio adjustments

Selected item	◀ button	▶ button
Treble	For weaker treble	For stronger treble
Bass	For weaker bass	For stronger bass
Balance	Decrease audio from the right speaker	Increase audio from the left speaker

Surround

When you set to "On", you can enjoy surround sound, the same as if you were in a movie theatre.

Selected item	Description
On	Makes it possible to enjoy natural, realistic surround sound.
Off	Outputs the normal sound.

NOTE

- For resetting all Audio adjustment items to the factory preset values, press ▲/▼ to select "Reset", press **ENTER**, press ◀/▶ to select "Yes", and then press **ENTER**.

ECO menu

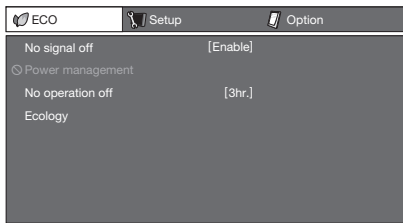

No signal off

You can set the TV to automatically power off in about 15 minutes after the TV goes into a state of receiving no programme signals, such as the end of a broadcast day. (Enable, Disable)

- Five minutes before the power shuts down, the remaining time displays every minute.

NOTE

- “Disable” is the factory preset value.
- When a TV programme finishes, and the TV receives signal input, this function may not operate.

Power management (PC input mode only)

You can set the TV to automatically power off when no image is displayed on PC.

Selected item	Description
Off	<ul style="list-style-type: none"> • No power management • Factory preset value.
Mode1	<ul style="list-style-type: none"> • If no signal inputs for approximately 8 minutes, the power shuts down. • Even if you start using the PC and the signal inputs again, the TV stays off. • The TV turns on again by pressing POWER. (See page 7.)
Mode2	<ul style="list-style-type: none"> • If no signal inputs for approximately 8 seconds, the power shuts down. • When you start using the PC and the signal inputs again, the TV turns on. • The TV turns on again by pressing POWER. (See page 7.)

No operation off

You can set the TV to automatically power off when no TV operation is performed for more than 3 hours. (30 min., 3 hr., Disable)

- Five minutes before the power shuts down, the remaining time displays every minute.

NOTE

- “Disable” is the factory preset value.

Ecology

When set to “Yes”, the TV activates the following power saving mode.

- “OPC” set to “On” (Page 11)
- “No signal off” set to “Enable” (Page 12)
- “Power management” set to “Mode1” (Page 12)
- “No operation off” set to “3 hr.” (Page 12)
- “Quick start” set to “Off” (Page 14).

NOTE

- Ecology mode cannot be deactivated by selecting “No”. Each setting must be changed individually to deactivate Ecology mode.

Setup menu

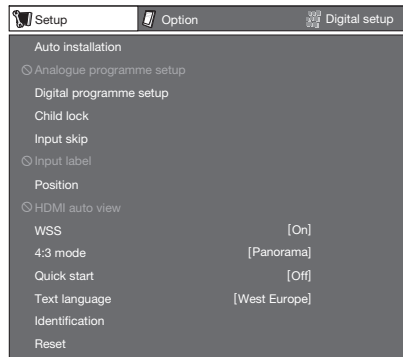

Child lock (ATV and DTV input mode only)

Allows you to set a password to protect certain settings from being accidentally changed.

Setting a password

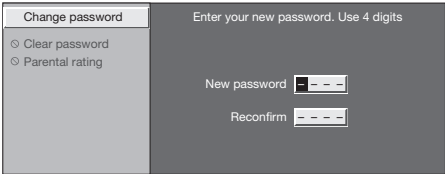
- 1 Repeat steps 1 to 2 in **Menu operation**.
- 2 Press **▲/▼** to select “Child lock”, and then press **ENTER**.
- 3 If you already set the password, enter it here.
- 4 Press **▲/▼** to select “Change password”, and then press **ENTER**.
- 5 Enter the 4-digit number as a password using **0—9**.

- 6 Enter the same 4-digit number as in step 5 to confirm.

NOTE

- To view a locked channel (Lock setting in Analogue programme setup “Manual adjust” is set to “On”), you must enter a password. When you select a locked channel, “Child lock has been activated” is displayed.
- Press **ENTER** to display the password input window.

Clearing the password

Allow you to clear your password.

- 1 Repeat steps 1 to 3 in **Setting a password**.
- 2 Press **▲/▼** to select “Clear password”, and then press **ENTER**.
- 3 Press **◀/▶** to select “Yes”, and then press **ENTER**.

Setup menu (Continued)

Parental rating

This function allows TV channels to be restricted. It prevents children from watching violent or sexual scenes that may be considered inappropriate.

1 Repeat steps 1 to 3 in **Setting a password**.

2 Press **▲/▼** to select "Parental rating", and then press **ENTER**.

3 Press **▲/▼** to select your desired rating, and then press **ENTER**.

When the country setting is set to "Australia".

Selected item	Description
General and above (G)	Content is not offensive to most viewers.
Parental guidance and above (PG)	Content is such that parents may not want their children to view the programme.
Mature and above (M)	Mature audience only. This programme is specifically designed to be viewed by adults and therefore may be unsuitable for children under 15.
Mature adult and above (MA)	Mature adult only. Mature audience only. This programme is specifically designed to be viewed by adults and therefore may be unsuitable for children under 15.
Adult violence (AV)	Not for children under age 15. Strong elements of sex and/or violence.
Restricted and above (R)	Not for children under age 18. Strong elements of sex and/or violence.
No block (-)	Cancel the blocking.

When the country setting is set to "New Zealand" or "Singapore".

Block 5 age and below
Block 11 age and below
Block 13 age and below
Block 15 age and below
Block 17 age and below
Block 18 age and below
No block

Input skip

This setting allows you to skip the HDMI or RGB input on the input source selection operation.

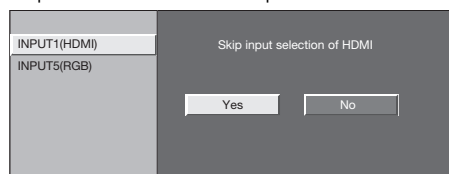

Input label

You can assign each input source a label as you prefer.

1 Press **TV/VIDEO** to select the desired input source.

2 Press **MENU** and the MENU screen displays.

3 Press **◀▶** to select "Setup".

4 Press **▲/▼** to select "Input label", and then press **ENTER**.

5 Press **▲/▼/◀▶** to select a desired alphanumeric, and then press **ENTER**. Repeat until the name is fully spelt out. Maximum 6 alphanumeric can be input.

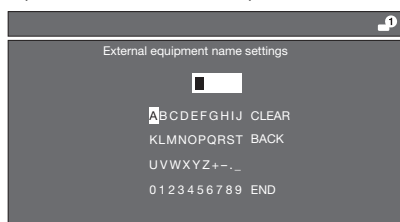

To exit, select **END** and then press **ENTER**. If the wrong alphanumeric is entered, select **CLEAR** to clear and then press **ENTER**.

NOTE

- You cannot change labels if the input source is ATV andDTV.

Position

For adjusting a picture's horizontal and vertical position.

Selected item	Description
H-Position	Centres the image by moving it to the left or right.
V-Position	Centres the image by moving it up or down.
Reset	Reset position to factory preset values.

HDMI auto view (HDMI input mode only)

Selected item	Description
Enable/Disable	Set whether or not to use WIDE MODE based on signal recognition, including an HDMI signal.

WSS

WSS allows a television to switch automatically among the different screen formats. (On, Off)

NOTE

- Try to set WIDE mode if an image does not switch to the correct screen format. When the broadcast signal contains no WSS information, the function will not work even if enabled.
- Not available for COMPONENT, PC and HDMI signal.

4:3 mode

The WSS signal has 4:3 auto-switching that allows you to select between Panorama and Normal.

Selected item	Description
Panorama	Wide image without side bars
Normal	Normal range keeping 4:3 or 16:9 aspect ratio

WSS signal 4:3 screen

4:3 mode "Panorama"



4:3 mode "Normal"



Quick start

You can reduce the TV's start-up time after turning on the power with the remote control unit.

Selected item	Description
On	The TV quickly starts up from standby, 8.5W or more of power consumption is required during standby.
Off	Power consumption is less than 1W.

Text language

Select from among 3 kinds of language: West Europe, Arabic, Farsi.

NOTE

- Teletext can display only when it is sent by a network. Not used to convert between languages.

Identification

You can check the current version of the software on the screen.

Reset

If complex adjustments are made and the settings cannot be restored to normal, you can reset the settings to the factory preset values.

NOTE

- If you execute "Reset", all the settings such as Picture, Audio and Programme will be reset to the factory preset values.

Option menu

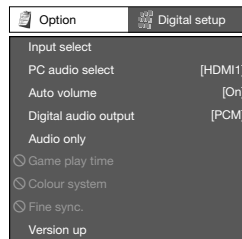

Input select

For setting the signal type of external equipment.

Input source	Selectable item
INPUT2	Auto, S-VIDEO, VIDEO

PC audio select

When using the INPUT5 terminal or HDMI1 terminal, you must select which terminal uses the AUDIO (R/L) jack for analogue audio input.

Selected item	Description
HDMI1	When connecting devices (including a PC) with DVI/HDMI cable to the INPUT1 terminal and inputting analogue audio signals from the AUDIO (R/L) jack.
INPUT5 (RGB)	When connecting a PC to the INPUT5 terminal, and inputting analogue audio signals from the AUDIO (R/L) jack.

NOTE

- You must set this to "INPUT5(RGB)" when connecting devices (including a PC) with an HDMI-certified cable to the INPUT 1 terminal. If "HDMI1" is set, there will be no sound output.

Auto volume

Different sound sources, fairly often do not have the same volume level, for example the changing from movie to the advertisements. Auto volume solves this problem and equalises the volume levels. (On, Off)

Digital audio output

This function allows you to select your favourite audio output system.

Selected item	Description
PCM	The optical output format is normally in PCM.
Dolby Digital	Dolby Digital audio will be output when there is a Dolby Digital audio signal. The output will be in PCM when there is no Dolby Digital audio signal.

Option menu (Continued)

Audio only

When listening to music from a music programme, you can set the display off and enjoy audio only.

Selected item	Description
On	Audio is output without screen image.
Off	Both screen images and audio are output.

NOTE

- When you make operations that change the picture on the TV such as by changing the input source, the Audio only function is set to "Off".

Game play time

This function displays the elapsed game time so you do not lose track of the time.

To display the elapsed time, select "GAME" under "AV mode" for the input mode of the terminal connected to the game console before starting the game.

Selected item	Description
On	The elapsed time is displayed every 30 minutes when you switch to GAME mode in external input mode.
Off	Hides the time.

Colour system

You can change the colour system to one that is compatible with the image on the screen. (Auto, PAL, SECAM, NTSC 3.58, NTSC 4.43, PAL-60)

NOTE

- If "Auto" is selected, colour system for each channel is automatically set. If an image does not display clearly, select another colour system (e.g. PAL).
- "Colour system" is selectable only when inputting an S-VIDEO or composite signal.

Version up

This function is only for service personnel to use for software updates.

Fine sync. (PC input mode only)

Adjusting the PC image automatically

Auto sync.

This function enables the screen to be automatically adjusted to its best possible condition when the analogue terminals of the TV and PC are connected with a commercially available RGB cable, etc.

NOTE

- Auto sync. is likely to succeed when an input PC image has wide vertical stripes (e.g. pattern with high contrast stripes, or cross-hatched). It may fail when an input PC image is solid (low contrast).
- Be sure to connect the PC to the TV and switch it on before starting Auto sync.

Adjusting the PC image manually

Ordinarily you can easily adjust the picture as necessary to change image position using Auto sync. In some cases, however, manual adjustment is needed to optimise the image.

Selected item	Description
H-Position	Centres the image by moving it to the left or right.
V-Position	Centres the image by moving it up or down.
Clock	Adjusts when the image flickers with vertical stripes.
Phase	Adjusts when characters have low contrast or when the image flickers.

NOTE

- For resetting all adjustment items to the factory preset values, press ▲/▼ to select "Reset", press **ENTER**, press ◀▶ to select "Yes", and then press **ENTER**.
- Images may not be displayed properly depending on the settings and/or input signals.

Input signal

- Some input signals may have to be registered manually to display properly.
- The pairs of input signals (resolutions) in the list below are not distinguishable when received. In such case, you have to set the correct signal manually. After setting once, it will display when the same signal (resolution) is input again.

1280 × 768	1360 × 768
------------	------------

Digital setup menu

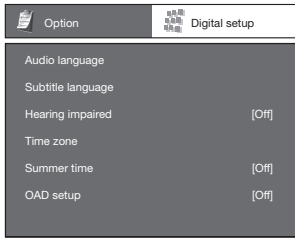

■ Selecting the language

Set up to two preferred multi audio languages to display if the audio languages are available.

- 1 Press **MENU** and the MENU screen displays.
- 2 Press **◀▶** to select “Digital setup”.
- 3 Press **▲▼** to select “Audio language”, and then press **ENTER**.
- 4 Press **▲▼** to select “1st Language” or “2nd Language”, and then press **ENTER**.
- 5 Press **▲▼/◀▶** to select the desired language, and then press **ENTER**.

NOTE

- If audio for the selected languages is not included in a received broadcast, audio will not be output for that language.

■ Displaying subtitles for the hearing impaired

You can display subtitles for the hearing impaired in the Teletext broadcast if the subtitle languages are available.

- 1 Press **MENU** and the MENU screen displays.
- 2 Press **◀▶** to select “Digital setup”.
- 3 Press **▲▼** to select “Subtitle language”, and then press **ENTER**.
- 4 Press **▲▼** to select “1st Language” or “2nd Language”, and then press **ENTER**.
- 5 Press **▲▼/◀▶** to select the desired language, and then press **ENTER**.

NOTE

- If subtitles for the selected language are not included in a received broadcast, subtitles will not be shown for that language.

■ Switching subtitle languages (DVB Subtitle)

Each time you press **[...]** on the remote control, the subtitle switches when the broadcast contains subtitle information.

Set “Hearing impaired” to “On”

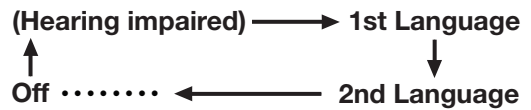

Set “Hearing impaired” to “Off”

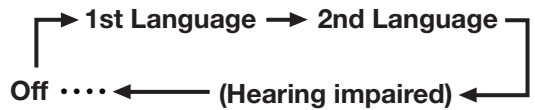

NOTE

- This function is valid only if broadcaster is transmitting multilingual subtitles.

■ Time zone

This function enables you to select your local time zone.

- 1 Press **MENU** and the MENU screen displays.
- 2 Press **◀▶** to select “Digital setup”.
- 3 Press **▲▼** to select “Time zone”, and then press **ENTER**.
- 4 Press **◀▶** to select the desired time zone and then press **ENTER**.

- This function lets you select the right time zone in case the time displayed in the EPG does not match the local time of your area.

■ Summer time

When the Summer time is set to “On”, the Standard Time is plus one hour. (Auto, On, Off)

■ OAD setup

- This function is for automatically download the data for the version update software over digital broadcasts when the “OAD setup” is set to “On”.
- To download, follow the instructions when the download message appears during a digital broadcast.

CAUTION

- **Do not disconnect the AC cord when the software upgrade is in progress, as this may cause the upgrade to fail. If problem arises ask a qualified service personnel before the software upgrade period expires.**

Programme Guide

You can check the current schedule of DTV events and view detailed information about current events.

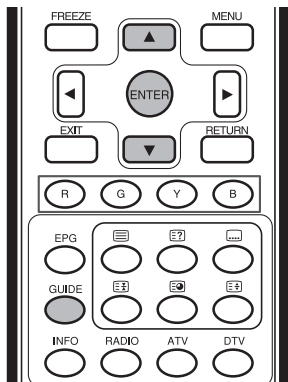

1 Press **GUIDE** to display the programme guide list.

2 Press **▲/▼** to display your desired programme, and then press **ENTER**.

- When you press **ENTER**, the TV jumps to the channel.



3 Press **R** to view programme information.

4 Press **RETURN** or **MENU** to exit.

Info

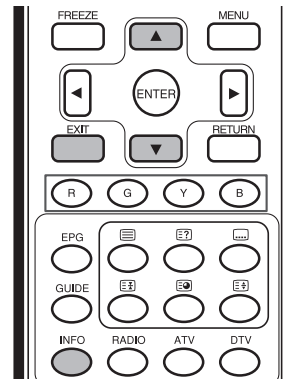

While watching DTV you can check the extended programme information on the screen using **INFO** on the remote control.

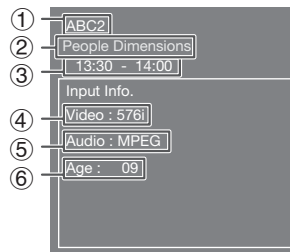

General INFO screen

- 1 Station name
- 2 Title
- 3 Time for the current programme
- 4 Video system
- 5 Audio system (Dolby D or MPEG)
- 6 Parental rating

- If there is more information, pressing **▲/▼** allows you to go to the next page or return to the previous page.
- You can cancel this info by pressing **INFO** or **EXIT**.

ATV (Analogue)/DTV/ RADIO buttons

Use the following buttons on the remote control to operate the menu.

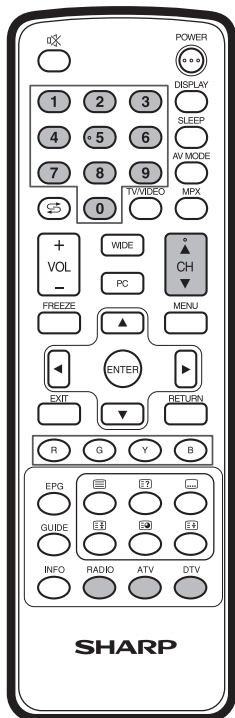

ATV: Press to switch to ATV mode. After switching from DTV, radio or external input mode to ATV mode, the TV jumps to the most recently viewed ATV channel.

DTV: Press to switch to DTV mode. After switching from ATV, radio or external input mode to DTV mode, the TV jumps to the most recently viewed DTV channel.

RADIO: Press to switch to radio mode. After switching from DTV, ATV or external input mode to radio mode, the TV jumps to the most recently tuned radio channel.

When you watch the TV for the first time

When the TV powers on for the first time after purchase, perform the auto installation.

ATV (Analogue TV)

You can run the auto installation to set channels automatically.

1 To watch the analogue TV, select "Auto installation" from Setup menu. (See page 8.)

2 After setting the channels, you can select a channel using **CH** \wedge/\vee or **0-9** on the remote control unit. (See page 5.)

DTV

When the TV accesses to DTV mode for the first time, you need to run the auto search. To scan all available services in your area, follow the procedures below.

1 To watch DTV broadcasts, select "DTV" from auto installation menu. (See page 8.)

2 After setting the channels, you can select a channel using **CH** \wedge/\vee or **0-9** on the remote control unit. (See page 5.)

Switching the analogue audio format

You can switch between multiple audio modes when watching a multiple audio or stereo broadcast programme.

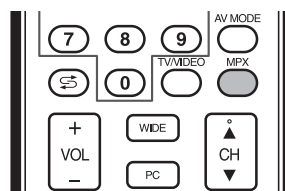

In the NICAM TV broadcasts

When receiving a stereo signal

Each time you press **MPX**, the mode switches between NICAM STEREO and MONO.

Stereo mode

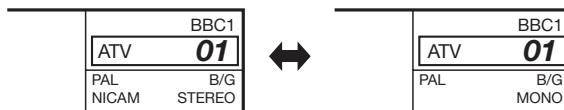

When receiving a bilingual signal

Each time you press **MPX**, the mode switches among NICAM CH A, NICAM CH B, NICAM CH AB and MONO.

Bilingual mode

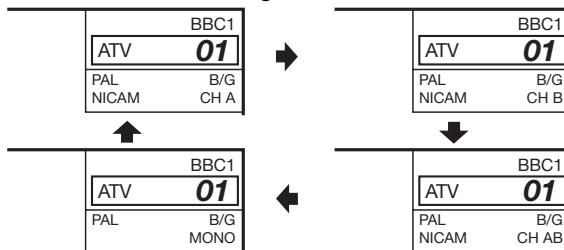

When receiving a monaural signal

Each time you press **MPX**, the mode switches between NICAM MONO and MONO.

Monaural mode

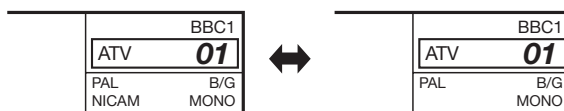

Switching the analogue audio format (Continued)

In the TV mode of A2 TV broadcasts

When receiving a stereo signal

Each time you press **MPX**, the mode switches between STEREO and MONO.

Stereo mode

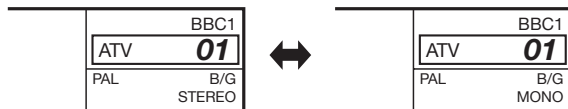

When receiving a bilingual signal

Each time you press **MPX**, the mode switches among CH A, CH B and CH AB.

Bilingual mode

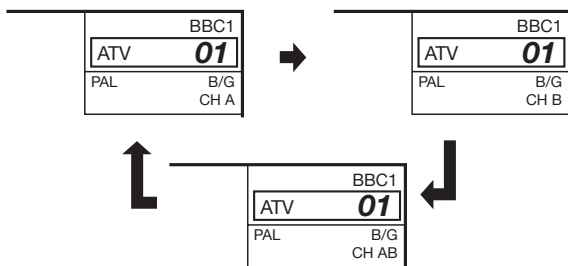

When receiving a monaural signal

When you press **MPX**, "MONO" displays.

Monaural mode

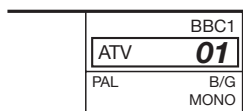

NOTE

- "BBC1", "01" and "PAL" are tentative network name, channel and colour system.

EPG

What is an EPG?

An "EPG (Electronic Programme Guide)" is a programme schedule, which is displayed on the TV screen. The EPG is broadcasted together with DTV. The TV screen shows the EPG when the viewer presses **EPG** on the remote control, provided that the TV is receiving the digital broadcasting signal. The EPG enables you to search for a programme, do timer view the programme schedule in detail.

Basic Operation

Display the EPG screen

- 1 Press **EPG**.

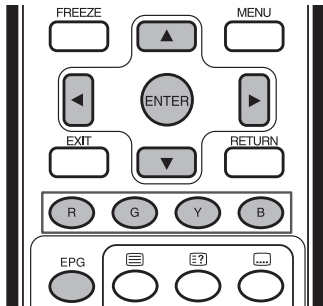

- 2 Press **◀/▶/R/G** to select the time span you want to search.
 - Continue to press **▶** to display programmes in the next time span.

- 3 Press **▲/▼** to select the desired programme.

Close the EPG screen

- 4 Press **EPG** again or **MENU** to exit.

NOTE

• For "New Zealand delivery model", the EPG screen and operation differ due to the use of MHEG EPG. The EPG screen and operation vary depending on the broadcasts.

Reminder timer setting

You can schedule a reminder for future programmes. Channel will automatically change on time as scheduled.

- 1 Press **EPG**.

- 2 Press **▲/▼/◀/▶/R/G** to select the programme you want to watch.

- 3 Press **B** to set reminder time.

Reminder	
Programme	002 ABC TV Sydney
Hour	18
Minute	00
Mode	Once
Date	Tue. 22
Month	June

- 4 Press **ENTER** to save reminder timer.
 - "Timer Save Success" will display.

NOTE

- "Timer Overlap" will display if same time is set twice.
- "Timer Past" will display if past time is set.

- 5 Press **ENTER** to display the reminder schedule list.

REMINDER LIST			
Title	Time	Date	Programme
Jazz Festival	18:00	Tue. 22 J..	002 ABC TV Sydney

- 6 Press **MENU** or **EPG** to exit.

EPG (Continued)

Viewing the reminder schedule list

- 1 Press **EPG**.
- 2 Press **Y** to display the reminder schedule list.
- 3 Press **▲/▼** to display next or previous screen.
- 4 Press **MENU** or **EPG** to exit.

Canceling the reminder timer setting

- 1 Press **EPG**.
- 2 Press **Y** to display the reminder schedule list.
- 3 Press **▲/▼** to select a programme you want to cancel.
- 4 Press **R** to delete a programme from reminder list.
- 5 Press **MENU** or **EPG** to exit.

Picture and still image

You can freeze a motion picture on the Display.

- 1 Press **FREEZE**.
 - A still image displays.
- 2 Press **FREEZE** or **RETURN** again to exit still image.

NOTE

- The still image automatically goes out after 30 minutes.
- FREEZE doesn't function for PC input (all resolution).

Wide Mode

Auto Selection

If you set "WSS" and "4:3 mode" in the Setup menu, the optimum WIDE mode is automatically chosen for every broadcast containing the WSS information.

"WSS" menu

To enable Auto Selection, set "WSS" in the Setup menu to "On". (See page 13.)

"4:3 mode" menu

To set the type of the wide screen, select "Panorama" or "Normal" in the 4:3 mode menu. (See page 14.)

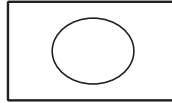

4:3 mode set to "Panorama"

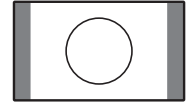

4:3 mode set to "Normal"

NOTE

- If the broadcast signal contains no WSS information, Auto Selection will not function even when the WSS option is enabled.

Manual Selection

You can select different picture sizes that account for the kind of each picture.

- 1 Press **WIDE**.
 - The WIDE MODE menu displays.
 - The menu lists the wide mode options selectable for the type of video signal currently received.
- 2 Press **WIDE** or **▲/▼** while the WIDE MODE menu displays on the screen.
 - As you toggle down the options, each mode is immediately reflected on the TV.

Selected item	Description
Normal	For 4:3 "standard" pictures. A side bar appears on each side.
Zoom14:9	For 14:9 letterbox pictures. A thin side bar appears on each side, and you may also see bars on the top and bottom with some programmes.
Panorama	In this mode the picture is progressively stretched toward each side of the screen.
Full	For 16:9 squeeze pictures.
Cinema16:9	For 16:9 letterbox pictures. Bars may appear on the top and bottom with some programmes.
Cinema14:9	For 14:9 letterbox pictures. Bars may appear on the top and bottom with some programmes.
Underscan	Display with an Underscan image only when receiving a 720p/1080i/1080p signal. Display with the High-Definition image adjusted optimally. Noise may appear on the edge of the screen with some programmes.

NOTE

- Some picture size may not be displayable depending on the input signal.

Teletext function

What is Teletext?

Teletext broadcasts pages of information and entertainment to specially equipped television sets. News, weather reports, sports information, stock exchange prices and programme previews are among the many services available.

Turning on and off Teletext

1 Select a TV channel or external input source providing the Teletext programme.

2 Press  to display the Teletext.







3 Each time you press , the screen switches as shown below.



NOTE

- If you select a programme with no Teletext signal, "No teletext available." is displayed.
- The same message displays during other modes if no Teletext signal is available.
- New Zealand delivery model can receive MHEG data broadcasting.

Button functions

Buttons	Description
CH ( / )	Increase or decrease the page number.
Colour (Red/Green/Yellow/Blue)	You can select a group or block of pages displayed in the coloured brackets at the bottom of the screen by pressing the corresponding Colour (Red/Green/Yellow/Blue) on the remote control unit.
0 — 9	Directly select any page from 100 to 899 by using 0 — 9 .
 (Top/Bottom/Full)	Switch the Teletext image to Top, Bottom or Full.
 (Reveal hidden TELETEXT)	To reveal hidden information such as an answer to a quiz.
 (Hold)	To stop updating Teletext pages automatically or release the hold mode.
 (Subtitle for TELETEXT)	Display the subtitle during Teletext page. <ul style="list-style-type: none"> • Subtitle will not be displayed when the service does not contain subtitle information.
 (Subpage)	Display the subpage during Teletext page.

NOTE

- Teletext can display only when it is sent by network. Not used to convert between languages.

PC Control of the TV

- When a programme is set, the TV can be controlled from the PC using the RS-232C terminal. The input signal (PC/video) can be selected, the volume can be adjusted and various other adjustments and settings can be made, enabling automatic programmed playing.
- Attach an RS-232C cable cross-type (commercially available) to the Din/D-sub RS-232C for the connections.

NOTE

- This operation system should be used by a person who is accustomed to using PCs.

Communication conditions

Set the RS-232C communications settings on the PC to match the communications conditions of the TV.

The communications settings of the TV are as follows:

Baud rate:	9,600 bps
Data length:	8 bits
Parity bit:	None
Stop bit:	1 bit
Flow control:	None

Communication procedure

Send the control commands from the PC via the RS-232C connector.

The TV operates according to the received command and sends a response message to the PC.

Do not send multiple commands at the same time. Wait until the PC receives the OK response before sending the next command.

Command format

Eight ASCII codes + CR

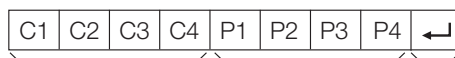

Command 4-digits Parameter 4-digits Return code

Command 4-digits: Command. The text of four characters.
Parameter 4-digits: Parameter 0 – 9, space, ?

Parameter

Input the parameter values, aligning left, and fill with space(s) for the remainder. (Be sure that four values are input for the parameter.)

When the input parameter is not correct, "ERR" returns. (Refer to "Response code format".)

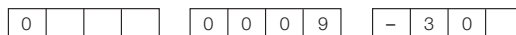

Response code format

Normal response

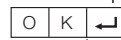

Return code (ODH)

Problem response (communication error or incorrect command)



Return code (ODH)

PC compatibility chart

Resolution		Horizontal Frequency	Vertical Frequency	Analogue (D-Sub)	Digital (HDMI)	VESA Standard
VGA	640 × 480	31.5 kHz	60 Hz	✓	✓	✓
SVGA	800 × 600	37.9 kHz	60 Hz	✓	✓	✓
XGA	1024 × 768	48.4 kHz	60 Hz	✓	✓	✓
WXGA	1360 × 768	47.7 kHz	60 Hz	✓	✓	✓

NOTE

- This TV has only limited PC compatibility, correct operation can only be guaranteed if the video card conforms exactly to the VESA 60Hz standard. Any variations from this standard will result in picture distortions.

DDC is a registered trademark of Video Electronics Standards Association.
 Power Management is a registered trademark of Sun Microsystems, Inc.
 VGA and XGA are registered trademarks of International Business Machines Corp.

RS-232C commands list

Commands

- Commands not indicated here are not guaranteed to operate.

CONTROL ITEM	COMMAND	PARAMETER	CONTROL CONTENTS
POWER SETTING	P O W R 0	_ _ _	POWER OFF (STANDBY)
INPUT SELECTION A	I T G D	_ _ _	INPUT SWITCHING (TOGGLE)
	I T V D	_ _ _	ATV (CHANNEL FIXED)
	I D T V	_ _ _	DTV (CHANNEL FIXED)
	I A V D *	_ _ _	INPUT1-5 (1-5)
CHANNEL	D C C H *	* _ _	ATV DIRECT CHANNEL (1-99)
	C H U P	_ _ _	ATV CHANNEL UP
	C H D W	_ _ _	ATV CHANNEL DOWN
	D T V D *	* * _	DTV DIRECT CHANNEL (1-999)
	D T U P	_ _ _	DTV CHANNEL UP
	D T D W	_ _ _	DTV CHANNEL DOWN
INPUT SELECTION B	I N P 2 0	_ _ _	INPUT2 (Auto)
	I N P 2 2	_ _ _	INPUT2 (S-VIDEO)
	I N P 2 3	_ _ _	INPUT2 (VIDEO)
AV MODE SELECTION	A V M D 0	_ _ _	TOGGLE
	A V M D 1	_ _ _	STANDARD
	A V M D 2	_ _ _	MOVIE
	A V M D 3	_ _ _	GAME
	A V M D 4	_ _ _	USER
	A V M D 5	_ _ _	DYNAMIC (FIXED)
	A V M D 6	_ _ _	DYNAMIC
	A V M D 7	_ _ _	PC

NOTE

- If an underbar (_) appears in the parameter column, enter a space.
- If an asterisk (*) appears, enter a value in the range indicated in brackets under CONTROL CONTENTS.

CONTROL ITEM	COMMAND	PARAMETER	CONTROL CONTENTS
VOLUME	V O L M *	* * _	VOLUME (0-60)
POSITION	H P O S *	* * _	H-POSITION (AV) (-10-010)
	H P O S *	* * _	H-POSITION (PC) (000-180)
	V P O S *	* * _	V-POSITION (AV) (-20-020)
	V P O S *	* * _	V-POSITION (PC) (000-120)
	C L C K *	* * _	CLOCK (000-180)
PHASE	P H S E *	* * _	PHASE (000-015)
	W I D E 0	_ _ _	TOGGLE (AV)
WIDE MODE	W I D E 1	_ _ _	NORMAL (AV)
	W I D E 2	_ _ _	ZOOM 14:9 (AV)
	W I D E 3	_ _ _	PANORAMA (AV)
	W I D E 4	_ _ _	FULL (AV)
	W I D E 5	_ _ _	CINEMA 16:9 (AV)
	W I D E 6	_ _ _	CINEMA 14:9 (AV)
	W I D E 7	_ _ _	NORMAL (PC)
	W I D E 9	_ _ _	FULL (PC)
	W I D E 1 0	_ _ _	DOT BY DOT (AV/PC)
	W I D E 1 1	_ _ _	UNDERSCAN (AV)
MUTE	M U T E 0	_ _ _	TOGGLE
	M U T E 1	_ _ _	MUTE ON
	M U T E 2	_ _ _	MUTE OFF
SURROUND	A C S U 0	_ _ _	SURROUND TOGGLE
	A C S U 1	_ _ _	SURROUND ON
	A C S U 2	_ _ _	SURROUND OFF
AUDIO CHANGE	A C H A	_ _ _	TOGGLE
SLEEP TIMER	O F T M 0	_ _ _	OFF
	O F T M 1	_ _ _	SLEEP TIMER 30 MIN
	O F T M 2	_ _ _	SLEEP TIMER 1 HOUR
	O F T M 3	_ _ _	SLEEP TIMER 1 HOUR 30 MIN
	O F T M 4	_ _ _	SLEEP TIMER 2 HOUR
	O F T M 5	_ _ _	SLEEP TIMER 2 HOUR 30 MIN
TEXT	T E X T 0	_ _ _	TEXT OFF
	T E X T 1	_ _ _	TEXT CHANGE TOGGLE
	D C P G *	* * _	DIRECT PAGE JUMP (100-899)

Appendix

Troubleshooting

The problems described below are not always caused by malfunctions. Check the TV again before having the TV serviced.

Problem	Possible Solution
• No power.	<ul style="list-style-type: none">• Check if you pressed POWER on the remote control unit. (See page 7.) If the indicator on the TV lights up red, press POWER.• Is the AC cord disconnected?• Has the power been turned on? (See page 7.)
• Unit cannot be operated.	<ul style="list-style-type: none">• External influences such as lightning, static electricity, etc., may cause improper operation. In this case, operate the unit after first turning the power off the TV or unplugging the AC cord and re-plugging it in after 1 or 2 minutes.
• Remote control unit does not operate.	<ul style="list-style-type: none">• Is battery inserted with polarity (+, -) aligned? (See page 5.)• Is battery worn out? (Replace with new battery.)• Are you using it under strong or fluorescent lighting?• Is a fluorescent light shining on the remote control sensor?
• Picture is cut off.	<ul style="list-style-type: none">• Is the image position correct? (See page 15.)• Are screen mode adjustments such as picture size made correctly? (See pages 14 to 15.)
• Strange colour, light colour, or dark, or colour misalignment.	<ul style="list-style-type: none">• Adjust the picture tone. (See page 11.)• Is the room too bright? The picture may look dark in a room that is too bright.• Check the colour system setting. (See pages 11, 15.)• Check the input signal setting. (See page 15.)• Check the HDMI auto view setting. (See page 13.)
• Power is suddenly turned off.	<ul style="list-style-type: none">• The unit's internal temperature has increased. Remove any objects blocking the vent or clean.• Check the ECO setting. (See page 12.)• Is the sleep timer set? (See page 5.)
• No picture.	<ul style="list-style-type: none">• Is the connection to external equipment correct? (See page 4.)• Has the input signal setup been performed correctly after connection? (See page 7.)• Is the correct input selected?• Is the picture adjustment correct? (See page 11.)• Is the antenna connected properly? (See page 3.)• Is "On" selected in "Audio only"? (See page 15.)
• No sound.	<ul style="list-style-type: none">• Is the volume too low? (See page 5.)• Make sure that headphones are not connected.
• The TV sometimes makes a cracking sound.	<ul style="list-style-type: none">• This is not a malfunction. This happens when the cabinet slightly expands and contracts according to changes in temperature. This does not affect the TV's performance.

Cautions regarding use in high and low temperature environments

- When the unit is used in a low temperature space (e.g. room, office), the picture may leave trails or appear slightly delayed. This is not a malfunction, and the unit will recover when the temperature returns to normal.
- Do not leave the unit in a hot or cold location. Also, do not leave the unit in a location exposed to direct sunlight or near a heater, as this may cause the cabinet to deform and the LCD panel to malfunction.
Storage temperature: -20°C to +60°C.

Specifications

Item		Model	LC-32L400X
LCD panel			31.5" (800 mm) Advanced Super View & BLACK TFT LCD
Resolution			1,049,088 pixels (1366 × 768)
Video Colour System			PAL/SECAM/NTSC 3.58/NTSC 4.43/PAL 60
TV Function	TV- Standard	Analogue	PAL: B/G, D/K, I SECAM: B/G, D/K, K/K ₁
		Digital	DVB-T
	Receiving Channel	VHF/UHF	44.25—863.25 MHz
		CATV	S1—S41ch (including Hyperband)
	TV-Tuning System		Auto Preset 99 ch
STEREO/BILINGUAL		NICAM: B/G, I, D/K A2 stereo: B/G	
Backlight life			60,000 hours (at Backlight Standard position)
Viewing angles			H : 176° V : 176°
Audio amplifier			10 W × 2
Speakers			9 × 5 cm 2pcs
Terminals	Rear	Antenna input	UHF/VHF 75 Ω DIN type
		INPUT 1	HDMI (HDMI input) (480I, 576I, 480P, 576P, 720P/50Hz, 720P/60Hz, 1080I/50Hz, 1080I/60Hz, 1080P/24Hz, 1080P/50Hz, 1080P/60Hz), AUDIO in (ϕ 3.5 mm jack)
		INPUT 2	S-VIDEO in, VIDEO in, AUDIO in
		INPUT 3	VIDEO in, AUDIO in
		INPUT 4	AUDIO in, COMPONENT in (480I, 576I, 480P, 576P, 720P/50Hz, 720P/60Hz, 1080I/50Hz, 1080I/60Hz)
		INPUT 5 (PC input)	15 pin mini D-sub, AUDIO in (common use with INPUT 1) (ϕ 3.5 mm jack)
		RS-232C	9 pin D-sub male connector
		Digital Audio Output	Optical Digital Audio Output
		Headphone	ϕ 3.5 mm stereo
OSD language			English
Power Requirement			AC 110 — 240 V, 50/60 Hz
Power Consumption			119 W (0.9 W Standby)
Dimensions	without stand		797 (W) × 535 (H) × 115 (D) mm
	with stand		797 (W) × 580 (H) × 262 (D) mm
Weight	without stand		10.0 kg
	with stand		11.0 kg
Operating Temperature			0°C — 40°C

- As a part of policy of continuous improvement, SHARP reserves the right to make design and specification changes for product improvement without prior notice. The performance specification figures indicated are nominal values of production units. There may be some deviations from these values in individual units.

Optional accessory

- Additional optional accessories may be available in the near future. When purchasing, please read the newest catalogue for compatibility and check the availability.

Part name	Model number
Wall mount bracket	AN-37AG5

CAUTION

- This TV should be mounted on the wall only with the AN-37AG5 (SHARP) wall mount bracket. The use of other wall mount brackets may result in an unstable installation and may cause serious injuries.
- Installing the Liquid Crystal Television requires special skill that should only be performed by qualified service personnel. Customers should not attempt to do the work themselves. SHARP bears no responsibility for improper mounting or mounting that results in accident or injury.
- Carefully read the instructions that come with the bracket before beginning work.

Protection against overturning

There is a danger of the product overturning in the case of a disaster or sudden collision. Carry out the following tip-resistant measurement for your safety.

Anchoring the TV to the wall or a pillar

- 1 Fix the product with the 2 clamps (supplied), using the screws (supplied).
- 2 Fix the TV to the wall using extrastrong ties (commercially available).

View from the top

Cup hook (commercially available) Tie (commercially available)

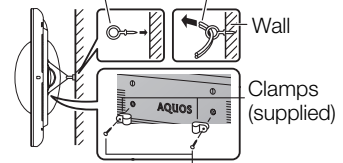

Screws for attaching clamps (supplied)

Fixing the TV to the table

- 1 Lay the TV down on cushioning (such as a blanket) over a table.
- 2 Attach the band (supplied) to the bottom of the stand using the screw (supplied).
- 3 Transfer the product to the table where you intend to fix the TV.
- 4 Fix the TV to the table by the band with a screw (commercially available).
 - Use a screw (commercially available) whose shape is compatible with the band.

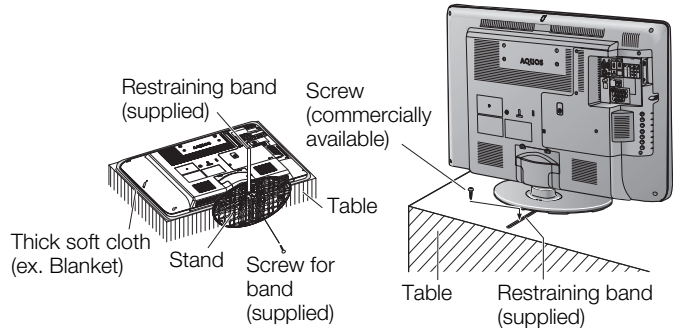

CAUTION

- As this product is heavy, use a table that is wide enough to support the product and capable of withstanding the product's weight. The table should be set where it will not be overturned.

Dimensional drawings

Unit: mm

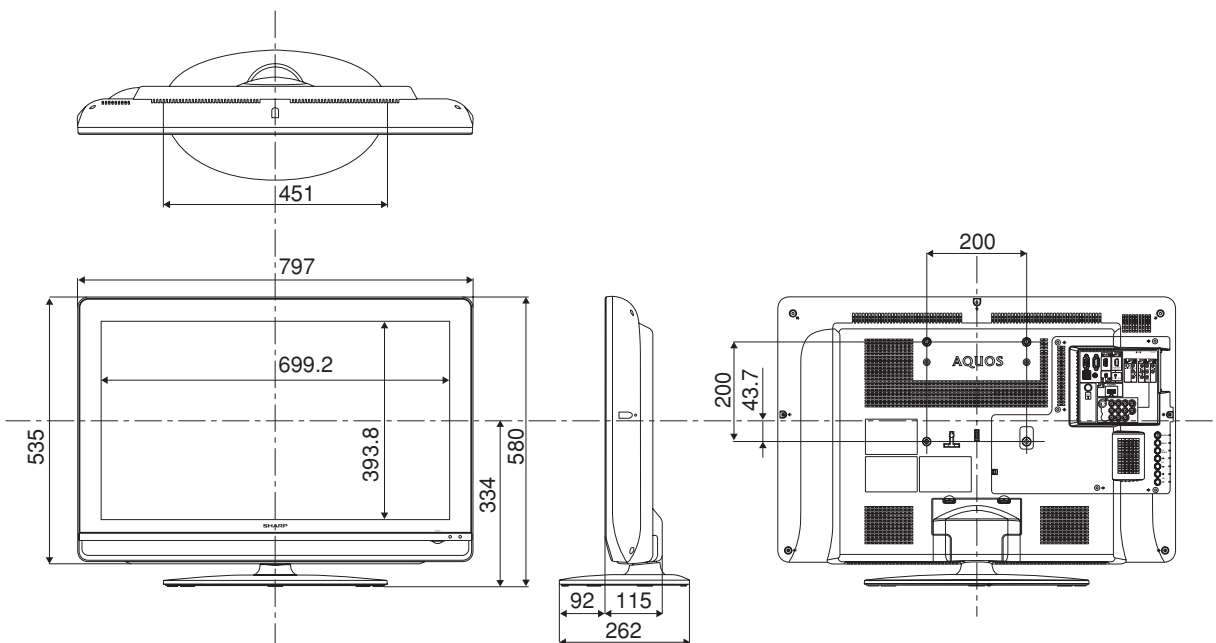

CLEARING THE PASSWORD

If you forget the password, clear the password using the following procedure.

- 1 Press **MENU** to display the MENU screen, and then press ◀▶ to select "Setup".
- 2 Press ▲/▼ to select "Child lock", and then press **ENTER** and the password input screen display.
- 3 If you enter "3001" using **0 - 9**, the "Child lock" setting menu will be displayed.
- 4 Enter the 4-digit number as a password using **0 - 9**. The new password is now set.



The Password is

				.
--	--	--	--	---

NOTE

- As a precautionary measure, make a note of your password above, remove it from this manual, and keep it in a familiar place.

Memo

SHARP

FOR LOCATION ENQUIRIES WITHIN

AUSTRALIA

REGARDING YOUR LOCAL

SHARP APPROVED SERVICE CENTRE

VISIT OUR WEBSITE AT

www.sharp.net.au

OR CALL SHARP CUSTOMER CARE

1300 135 022

(LOCAL CALL COST APPLY WITHIN AUSTRALIA)

SHARP CORPORATION OF AUSTRALIA PTY LTD

SHARP

FOR LOCATION ENQUIRIES WITHIN

NEW ZEALAND

REGARDING YOUR LOCAL

SHARP APPROVED SERVICE CENTRE

VISIT OUR WEBSITE AT

www.sharp.net.nz

CONTACT YOUR SELLING DEALER/RETAILER

OR CALL

SHARP CUSTOMER SERVICES

TELEPHONE: 09 573 0111

FACSIMILE: 09 573 0113

SHARP CORPORATION OF NEW ZEALAND LIMITED

Free Manuals Download Website

<http://myh66.com>

<http://usermanuals.us>

<http://www.somanuals.com>

<http://www.4manuals.cc>

<http://www.manual-lib.com>

<http://www.404manual.com>

<http://www.luxmanual.com>

<http://aubethermostatmanual.com>

Golf course search by state

<http://golfingnear.com>

Email search by domain

<http://emailbydomain.com>

Auto manuals search

<http://auto.somanuals.com>

TV manuals search

<http://tv.somanuals.com>