

# SHARP

2004-2005

## ELECTRONIC DICTIONARIES, ELECTRONIC CALCULATORS, AND ORGANIZERS

Electronic Dictionaries  
Electronic Organizers  
Scientific Calculators  
Printing Calculators  
Super Check & Correct  
Office Calculators  
Personal Calculators

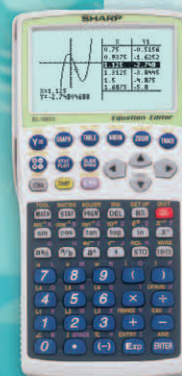
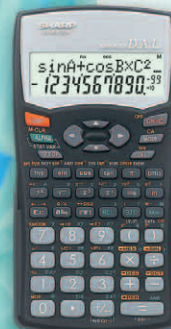
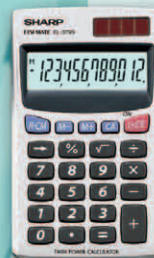
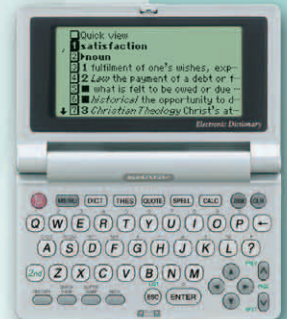

<http://sharp-world.com/calculator/>  
<http://sharp-world.com/organizer/>



# SHARP

## SHARP INNOVATIONS CONTINUALLY WRITE NEW CHAPTERS INTO THE PAGES OF HISTORY.

Forty years ago, SHARP gave the world its first electronic desktop calculator, now on display at the National Museum of Science & Industry as an innovative milestone. Succeeding generations carry on this trailblazing spirit, generating a remarkable stream of SHARP original creations.



Development of the world's first electronic desktop calculator incorporating ICs.



### ▶ SHARP'S HISTORY WITH CALCULATORS AND ORGANIZERS

1964

1966

1969

1973



Development and mass production of the world's first all-transistor desktop calculator.



Marketing of the world's first electronic calculator incorporating ELSIs.



Development and introduction of the world's first super-thin (1.6 mm) card-sized calculator.



SINCE THE INTRODUCTION OF THE FIRST ELECTRONIC DESKTOP CALCULATOR, SHARP HAS LED THE WAY IN THE FIELD OF CALCULATOR TECHNOLOGY. A HISTORY OF SUPERIOR ENGINEERING, ADVANCED FUNCTIONS, AND INNOVATIVE TECHNOLOGIES HAS MADE SHARP CALCULATORS AND ORGANIZERS THE CHOICE IN ALL FIELDS, THE WORLD OVER.

AND THIS YEAR, WE CELEBRATE 40 YEARS SINCE THE DEVELOPMENT OF ONE OF OUR MANY ORIGINAL CREATIONS: THE WORLD'S FIRST ALL-TRANSISTOR DESKTOP CALCULATOR.

Development of the world's first COS electronic LCD calculator.

World's 1st



1979

Development and introduction of electronic organizer (Personal Information Tool).



1996

Development and introduction of graphing calculator with a touch screen for educational market.



2000

Development and introduction of the world's first graphing calculator with a reversible keyboard.

World's 1st

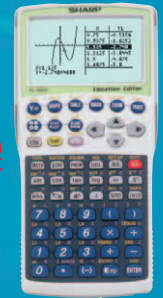

2004

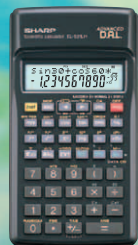

Development and introduction of scientific calculators with Advanced D.A.L. for educational market.

1988



1997

Development and introduction of electronic organizers with add-on software/contents.





40th Anniversary  
OF OUR ORIGINAL  
World's First





# We've Got the Right Answer for You!

## GUIDE TO SYMBOLS

 **BackLight** Display illuminates for easy use in dark or poor lighting conditions.

 **PC PIM Synchronisation** Synchronisation of your organizer and PC PIM data allows for easy one-step integration.

 **PC Link** Exchange data and files between your organizer and your PC with the optional PC-Link software.

 **Multi-Language** Displays information and guidance in one of several selectable languages. (See p.9.)

 **Telephone** The telephone file has a nameable directory. Stored telephone numbers are displayed with other information.

 **E-mail Address** The e-mail file has a nameable directory. Stored e-mail addresses are displayed with other information.

 **Web Address (URL)** Name, web address (URL) and remarks are stored for quick retrieval.

 **Calendar** The monthly calendar shows which days you have activities scheduled for each month, making long-term planning easy. (See p.9.)

 **Schedule** See the entire week's scheduled activities. Enter appointments by day.

 **Memo** The memo function is ideal for structuring and organising ideas within an overview of topics.

 **Anniversary** Enter important dates in the Anniversary mode.

 **Home/World Clock** The customisable clock displays home and world times, including daylight saving time (summer time) on a 12- or 24-hour basis.

 **Calculator/Conversion** The conversion mode lets you convert currencies or measurements by simply touching a button.

 **To Do** Store items and prioritise them on the To Do list.

 **Expense** Record financial transactions and view each type of payment and its total for every time period in the Expense mode.

 **Game** Built-in games turn the pocket databook into an entertainment centre.

 **Translator** English/Spanish word translator.

 **Spell Checker** Check the spelling of English words against suggested matches.

 **Diet** The Diet Function uses the built-in pedometer to keep track of calories burned. It also helps you to calculate your daily caloric intake.

 **Pen Touch Operation** Lets you conveniently select items from the menu screen.



Keys for basic functions are on one side, while keys for advanced functions are on the other. (See p.10.)



**Equation Editor**

Displays equations as they are written. (See p.11.)



**Slide Show**

Use slide shows to help demonstrate lessons. (See p.11.)



**Hard Case**

Durable hard case protects calculator from damage.



**D.A.L.**  
**Direct Algebraic Logic**

Features easy key-in for algebraic equations. (See p.14.)



**2-Line**  
**2-Line Display**

Allows users to check the equation and answer at the same time. (See p.14.)



**Multi-Line Playback**

Recalls any of the last 142 steps. (See p.14.)



**Constant Calculation**

Eliminates the need to re-enter the constant when doing repeated calculations. (See p.14.)



**Chain Calculation**

Allows the previous answer to be used in the next calculation. (See p.14.)



**Numerical Derivative**

Allows you to easily find the answer to derivative calculations. (See p.14.)



**Numerical Integral**

Allows you to easily find the answer to integral calculations. (See p.14.)



**Formula Memory**

Formulas or equations can be stored to simplify calculations. (See p.14.)



**3-Digit Punctuation**

For easier reading of long, multi-digit numbers, "," or "." is inserted for each group of three digits.



**2-Key Roll-Over**

Enables quick input of a keystroke, even if you still have a finger on the previous key.



**Twin Power**

Batteries provide back-up to solar power when light source is interrupted.



Includes handy wallet cover for extra protection and easy storage.



Easy-to-read large digital display reduces eye strain, preventing errors.



Automatically calculates the total sum of amounts generated.



Adjustable angle for personal preference.



Fixed angle to ensure optimum readability.



Allows answer to be used in following equation.



Raises calculator to an ideal operating angle for easier data entry.



**Resume Function**

Resumes operations after the Auto Power-Off Function has taken effect. (See p.21.)



**Resume Plus Function**

Resume Function plus Line Counter and Condition Symbol. (See p.21.)



**Answer Check**

An "OK" sign appears when the calculation being checked matches the result of the first. (See pp.18 & 21.)



**Average**

Calculates average of inputted data.



**Tax Calculation**

Calculates prices with or without taxes. (See pp.18 & 21.)



**Day/Date Calculation**

Determines the number of days and a specific date from inputted dates. (See p.21.)



Printed report is easy to read with red ink used for negative.



Characters are illuminated for improved readability.



**102-Step Memory**

Recalls the last 102 actions performed. (See p.18.)



**Auto Replay**

Automatically reviews the entire calculation. (See p.18.)



**Correct**

Changes incorrectly inputted data. (See p.18.)



**Insert**

Inserts new data. (See p.18.)



**Delete**

Deletes unwanted data. (See p.18.)



**Repeat**

Enters the same values repeatedly. (See p.18.)



**Change Calculation**

Calculates the amount to be returned from a payment. (See p.18.)



3 rates can be converted easily with the touch of a button.



Easy conversion of units such as currencies, based on an adjustable rate set by the user.



**Easy Hold**

Fits easily in the palm of your hand.



Quick and convenient calculation of cost, selling price and margins; ideal for business transactions.



Easy conversion into and out of metric measurements with just the touch of a button.



Easy-to-read large blue display.



**Hard Cover**

Comes with attached hard cover for extra protection and durability.



**Plastic Buttons**

Long-life plastic buttons.



# CONTENTS

## Electronic Dictionaries



PW-E500

- NEW • PW-E500
- NEW • PW-E300

P5

Electronic  
Dictionaries

## Electronic Organizers



ZQ-P20H

- NEW • ZQ-590A
- NEW • ZQ-290H
- ZQ-270P
- ZQ-190P
- NEW • ZQ-P20H
- EL-6990P
- ZQ-P10
- EL-6910
- EL-6053S

P7

Electronic  
Organizers

## Scientific Calculators



EL-9900

- Graphing
- Standard
- Programmable
- Financial

- EL-9900
- NEW • EL-506W(BK/WH)
- NEW • EL-520W(BK/WH)
- NEW • EL-531WH(BK/BL/WH)
- NEW • EL-509W(BK/WH)
- EL-510R
- NEW • EL-501W(BK/WH)
- EL-5120
- EL-735
- EL-733A

P10

Scientific  
Calculators

## Printing Calculators



CS-4194HC

- Desktop
- Semi-Desktop
- Hand-Held

- NEW • CS-4194HC
- NEW • EL-2630PII
- NEW • EL-2607P
- NEW • EL-1607P
- EL-2910R
- EL-2902C
- EL-2901RH
- EL-1801C
- EL-1750P
- EL-1611P

P15

Printing  
Calculators

## Super Check & Correct



EL-792C

- Semi-Desktop
- Nice Size
- Mini Nice Size

- EL-792C
- EL-782C
- EL-771C

P17

Super Check  
& Correct

## Office Calculators

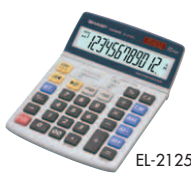

EL-2125C

- Desktop/Semi-Desktop
- Nice Size
- Mini Nice Size

- CS-2122H
- CS-2130
- EL-6138
- EL-2135
- EL-2125C
- EL-2128R
- EL-2139S
- EL-338F
- EL-387R
- EL-337C
- EL-339S
- EL-421M
- EL-334F
- EL-332A
- EL-331A/330A
- EL-310A
- NEW • EL-M711G
- NEW • EL-M710G
- NEW • EL-M700G

P19

Office  
Calculators

## 12/14 Digit Calculators



EL-145A

- Nice Size
- Mini Nice Size
- Hand-Held/Hard Cover

- NEW • EL-145A
- NEW • EL-125A
- NEW • EL-144A
- NEW • EL-124A
- NEW • EL-143S
- NEW • EL-123S

P23

12/14 Digit  
Calculators

## Personal Calculators



EL-480S

- Wallet/Hand-Held
- Hard Cover
- Card

- EL-480S
- EL-344G
- NEW • EL-W211G
- EL-327S
- EL-326S
- EL-379S
- EL-377S
- EL-371S
- NEW • EL-W200G
- EL-250S
- EL-240SA
- EL-231L
- EL-233S
- EL-376S
- EL-243S
- EL-879M

P24

Personal  
Calculators

# ELECTRONIC DICTIONARIES

All the Word Power You Need

Electronic Dictionaries

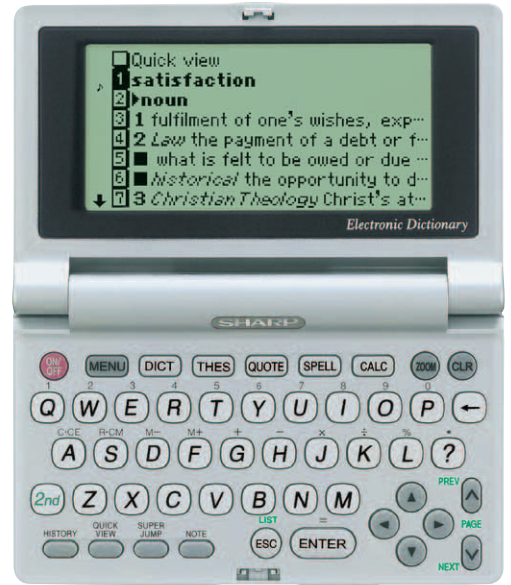
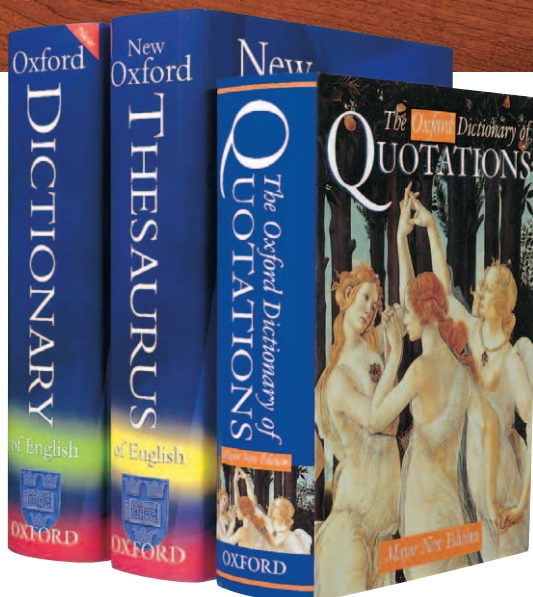
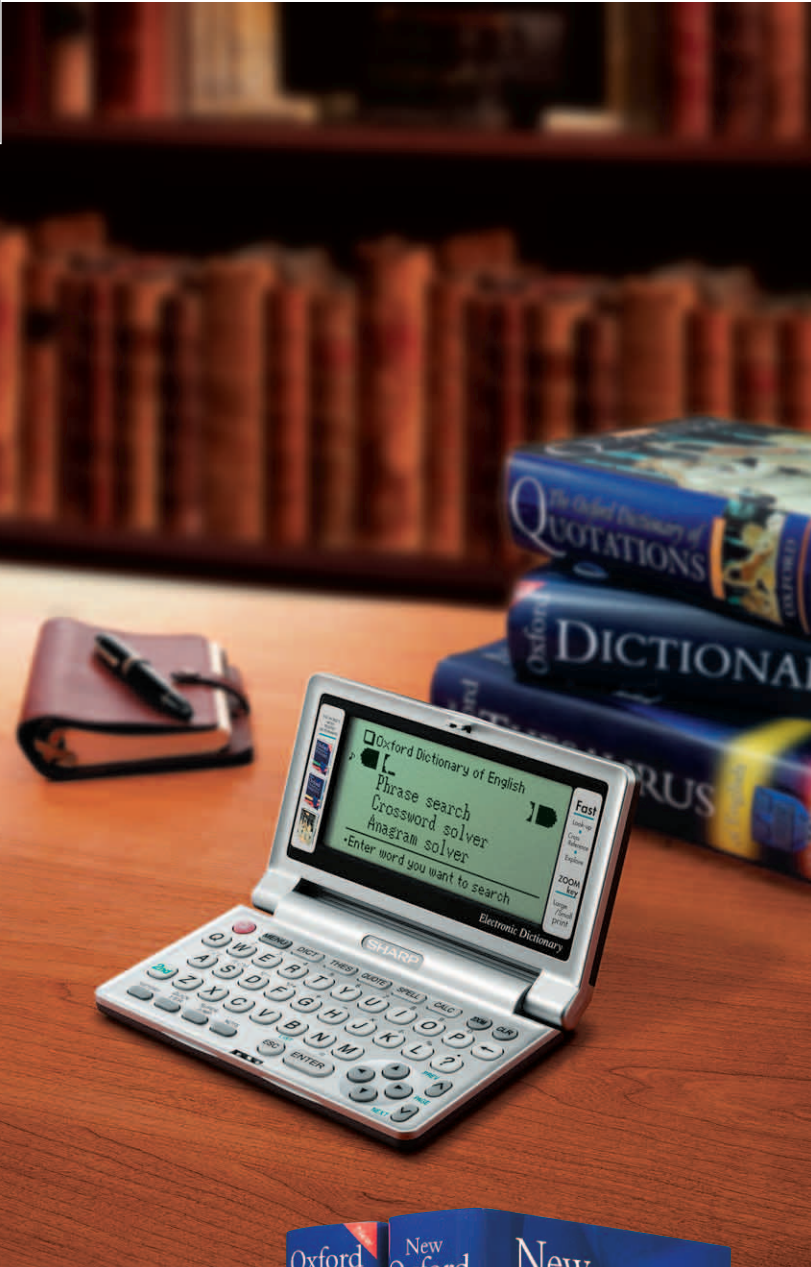

159 dots  
by  
80 dots

**NEW**

## PW-E500

- Power source: LR03 (AAA) x 1
- Dimensions: 125 (W) x 79.4 (D) x 16.8 (H) mm  
4-29/32" x 3-1/8" x 21/32"
- Weight: Approx. 148 g

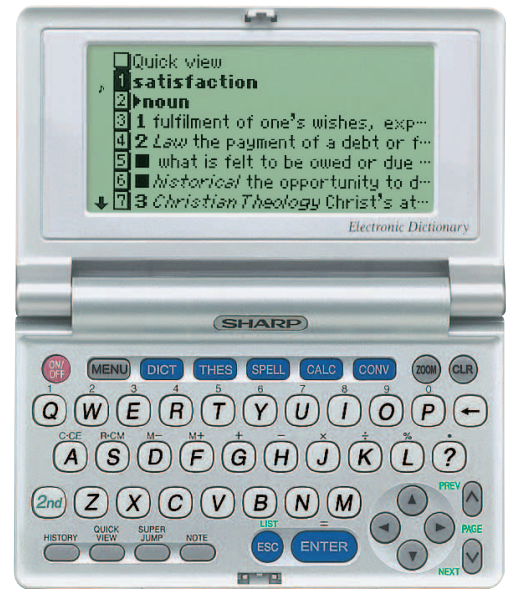

159 dots  
by  
80 dots

**NEW**

## PW-E300

- Power source: LR03 (AAA) x 1
- Dimensions: 125 (W) x 79.4 (D) x 16.8 (H) mm  
4-29/32" x 3-1/8" x 21/32"
- Weight: Approx. 148 g



## Included Dictionaries

### Oxford Dictionary of English

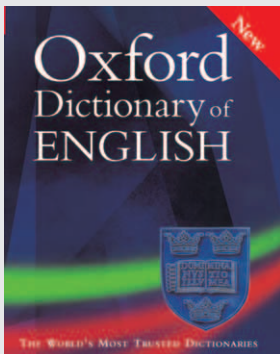

Based on Oxford's vast corpus of contemporary English, the *ODE* has been fully revised to give the most authoritative, up-to-date picture of English today. Comprising 355,000 words, phrases, and definitions — including 3,000 new words and senses, 73,000 scientific and technical words and senses, 68,000 examples, and 12,000 encyclopedic entries — the *ODE* puts a goldmine of knowledge at your fingertips.

### New Oxford Thesaurus of English

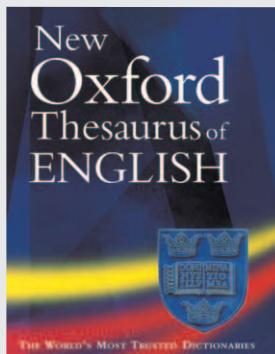

The *NOTE* presents 600,000 alternative and opposite words, with example phrases to convey meanings. Along with synonyms and antonyms, it also lists related words and provides explanations of often-confused words. A vital tool for all those who care about making their language more varied, interesting, and precise.

### The Oxford Dictionary of Quotations

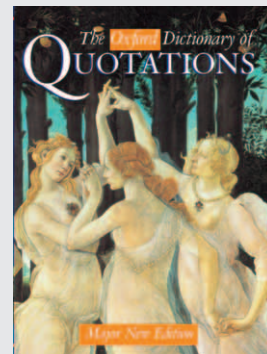

The *ODQ\** is Oxford's largest quotations dictionary, with over 20,000 quotations from books, films, newspapers, and speeches. The *ODQ* contains comprehensively indexed quotations from around 3,000 historical figures, including authors, politicians, scientists, and artists. Whether you're writing an essay or preparing a speech or presentation, this is one resource you can't afford to be without.

\* The *Oxford Dictionary of Quotations* is included in the PW-E500 model only.

## Convenient Functions

### Filter Search

As you are typing in a word to search, a list of potential target words appears on-screen. You can find your target or compound word faster, with fewer keystrokes.

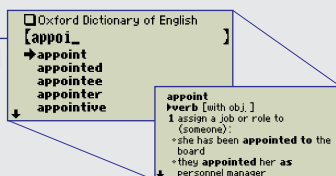

### Quick View

Many dictionary entries have multiple definitions. The Quick View feature displays the first line of each definition, giving you an easy-to-browse summary.

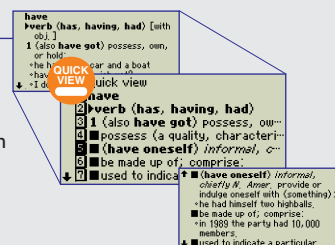

### Phrase Search

With the PW-E series e-dictionaries, you aren't limited to searching only for single-word entries. Using the Phrase Search, you can search for idioms and phrasal verbs by specifying up to three keywords.

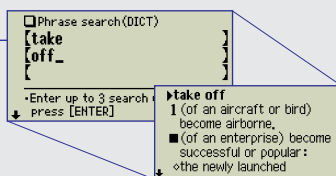

### Zoom Key

With the Zoom key, you can maximise either readability or quantity of information on the display. A single keystroke changes the character size from the default 12-dot to 9-dot vertical pixel resolution.

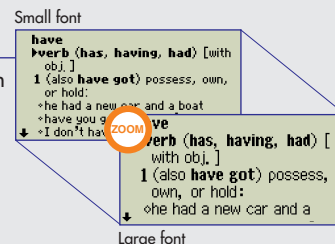

### Super Jump

This function lets you jump directly from the definition of one word to the definition of another. Super Jump returns matching entries from both the *Oxford Dictionary of English* and *New Oxford Thesaurus of English* databases.

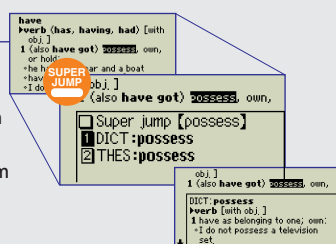

- Crossword Solver
- Anagram Solver
- Spellcheck Function
- Converter Function
- History Function

# ELECTRONIC ORGANIZERS

Flexible Organizers to Meet Your Day-to-Day Needs

80 dots by 111 dots

Microsoft® Outlook®\* Synchronise Capability

**NEW**

8MB Flash Memory

PC PIM Synchrono

BackLight (Included)

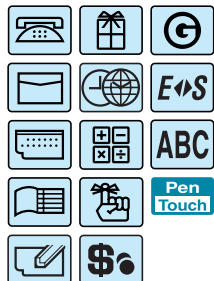

Includes USB PC-Link cable and software\*\*\*

English model only

## ZQ-590A

- Power source: LR03 (AAA) x 1
- Dimensions: 70.8 (W) x 118 (D) x 13.5 (H) mm  
2-25/32" x 4-21/32" x 17/32"
- Weight: Approx. 115 g
- Microsoft® Outlook®\* Synchronisation
- Microsoft® Outlook® E-mail Download\*\*\*

\* An English version of Microsoft® Outlook® 98/2000/2002/2003 must be installed to utilize the synchronisation software.  
\*\* The PC Software is intended to run on a PC with an English version of Microsoft® Windows® 98/98SE/2000 Professional/Me/XP Home/XP Professional.  
\*\*\* File attachments cannot be downloaded. Text viewer only.

14-Column by 5-Line

Microsoft® Outlook®\* Synchronise Capability

**NEW**

1.5MB Equivalent\*\* Flash Memory

PC PIM Synchrono

BackLight (Included)

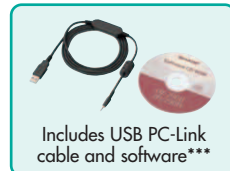
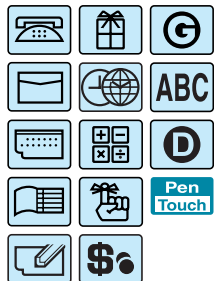

Includes USB PC-Link cable and software\*\*\*

English model only

## ZQ-290H

- Power source: CR2032 x 2 (Main/Backlight)
- Dimensions: 71.6 (W) x 112.5 (D) x 16.9 (H) mm  
2-13/16" x 4-7/16" x 21/32"
- Weight: Approx. 105 g
- Microsoft® Outlook®\* Synchronisation

\* An English version of Microsoft® Outlook® 98/2000/2002/2003 must be installed to utilize the synchronisation software.  
\*\* Memory at 1.5MB equivalent. Approx. 7,000 telephone names & numbers can be stored by using compression technology at a compression rate of approx. 1.5:1. (Names & numbers — including home, office, fax, and mobile — are 14 characters per entry, and addresses are 38 characters per entry.)  
\*\*\* The PC Software is intended to run on a PC with an English version of Microsoft® Windows® 98/98SE/2000 Professional/Me/XP Home/XP Professional.



111 dots by 48 dots

256KB Flash Memory

BackLight

PC Link

(Included PC-Link Kit)

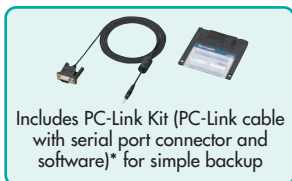

Includes PC-Link Kit (PC-Link cable with serial port connector and software)\* for simple backup

## ZQ-270P

- Power source: CR2032 x 3
- Dimensions (closed): 154 (W) x 92.5 (D) x 13 (H) mm  
6-1/16" x 3-21/32" x 1/2"
- Weight: Approx. 125 g

\* The PC-Link software is intended to run on a PC with an English version of Microsoft® Windows® 98/2000 Professional/Me.

19-Column by 5-Line

256KB

BackLight

PC Link

(Included PC-Link Kit)



Includes PC-Link Kit (PC-Link cable with serial port connector and software)\* for simple backup

## ZQ-190P

- Power source: CR2032 x 2 (Main), CR2032 x 1 (Backup)
- Dimensions (closed): 148 (W) x 92 (D) x 13 (H) mm  
5-13/16" x 3-5/8" x 1/2"
- Weight: Approx. 125 g

\* The PC-Link software is intended to run on a PC with an English version of Microsoft® Windows® 95/98/2000 Professional.





12-Column  
by  
3-Line

Microsoft® Outlook®\* Synchronise Capability

**NEW**

1MB  
Flash Memory

PC PIM  
Synchro  
(Included)

BackLight

Multi-Language

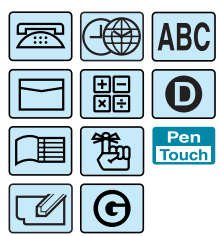

Includes PC-Link cable with serial port connector and software\*\*

English model only

## ZQ-P20H

- Power source: CR2032 x 2 (Main/Backlight)
- Dimensions: 69.8 (W) x 109.3 (D) x 16.3 (H) mm  
2-3/4" x 4-5/16" x 21/32"
- Weight: Approx. 104 g

\* An English version of Microsoft® Outlook® 98/2000/2002/2003 must be installed to utilize the synchronisation software.  
\*\* The PC Software is intended to run on a PC with an English version of Microsoft® Windows® 98/98SE/2000 Professional/Me/XP Home/XP Professional.

12-Column  
by  
3-Line

96KB Equivalent\*

Multi-Language



## ZQ-P10

- Power source: CR2032 x 1
- Dimensions: 64 (W) x 97 (D) x 14.8 (H) mm  
2-17/32" x 3-13/16" x 19/32"
- Weight: Approx. 72 g

\* Memory at 96KB Equivalent. Approx. 1,500 telephone names & numbers (name, telephone and fax number are 14 characters per entry) can be stored by using compression technology. (Compression Rate Approx. 1.5:1)

14-Column  
by  
5-Line

256KB  
Flash Memory

PC Link  
(Included  
PC-Link Kit)

BackLight



## EL-6990P

- Power source: CR2032 x 1 (Main), CR2032 x 1 (Backlight)
- Dimensions (closed): 143 (W) x 88 (D) x 13.3 (H) mm, 5-5/8" x 3-15/32" x 17/32"
- Weight: Approx. 111 g

\* The PC-Link software is intended to run on a PC with an English version of Microsoft® Windows® 98/98SE/2000 Professional/Me.



Includes PC-Link Kit (PC-Link cable with serial port connector and software)\* for simple backup

3-Line  
12-Letter  
24-Number

64KB

Multi-Language



## EL-6910

- Power source: CR2032 x 1
- Dimensions (closed): 143 (W) x 88 (D) x 13.3 (H) mm  
5-5/8" x 3-15/32" x 17/32"
- Weight: Approx. 105 g

3-Line  
12-Letter  
24-Number

8KB

Multi-Language

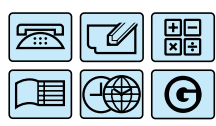

## EL-6053S

- Power source: CR2025 x 1
- Dimensions (closed): 128 (W) x 86.6 (D) x 12.7 (H) mm  
5-1/16" x 3-3/8" x 1/2"
- Weight: Approx. 87 g

# ELECTRONIC ORGANIZERS

## Synchronise with Microsoft® Outlook®\* (ZQ-590A, ZQ-290H, ZQ-P20H)

- Synchronise contact information with your PC.
- Synchronisation of contact information is automatic when you connect the ZQ-590A to your PC.

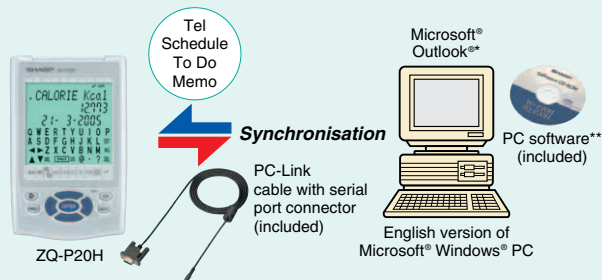
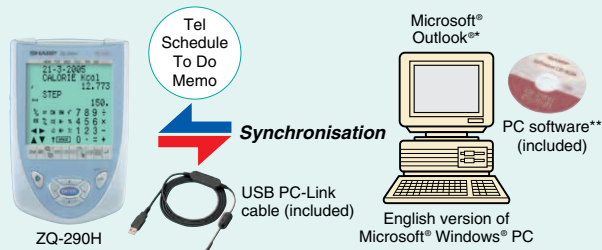
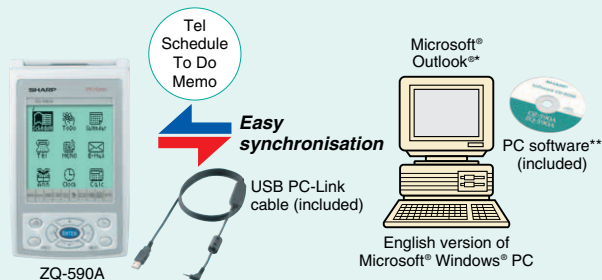

## Backup and Restore Data (ZQ-270P, ZQ-190P, EL-6990P)

- Backup and restore data between your PC and organizer.

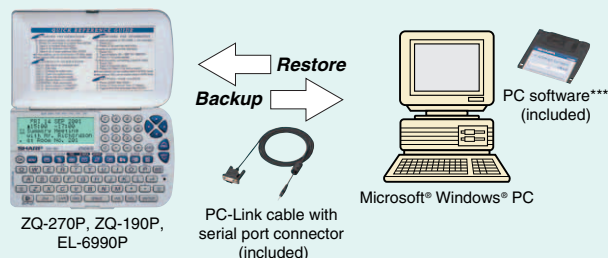

## Calendar Function (ZQ-590A, ZQ-290H, ZQ-270P, ZQ-190P, EL-6990P)



\* An English version of Microsoft® Outlook® 98/2000/2002/2003 must be installed to utilize the synchronisation software.  
 \*\* The PC software is intended to run on a PC with an English version of Microsoft® Windows® 98/98SE/2000 Professional/Me/XP Home/XP Professional.  
 \*\*\* The PC-Link software is intended to run on a PC with an English version of the following software: Microsoft® Windows® 98/2000 Professional/Me (ZQ-270P); Microsoft® Windows® 95/98/2000 Professional (ZQ-190P); and Microsoft® Windows® 98/98SE/2000 Professional/Me (EL-6990P)

## Multi-Language Guidance Message (ZQ-P20H, ZQ-P10, EL-6910, EL-6053S)



\* Only capitalized letters can be entered in Greek Mode.

## Multiple Converter (All models)

Metric conversions and currency conversions are installed. Specified currencies and exchange rates can be customised.

(N.B. Number of conversion functions varies depending on the model.)



## Diet Function (ZQ-290H, ZQ-P20H)

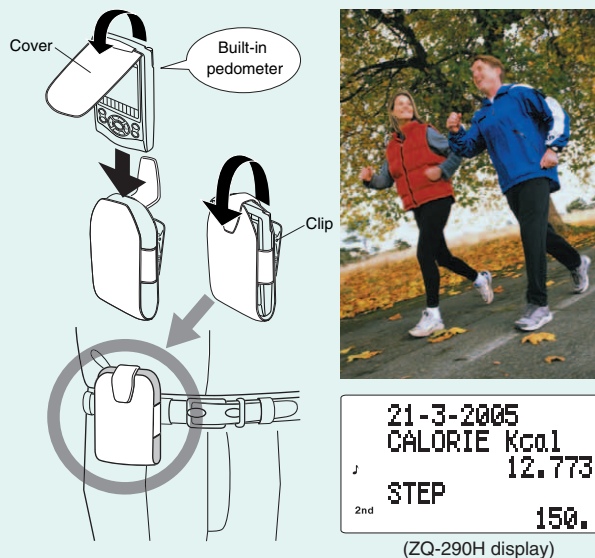

- Use the built-in pedometer to keep track of calories burned by walking.
- Record and calculate your daily intake of calories and carbohydrates, along with other nutritional data, using the downloadable food database on the included CD-ROM. (N.B. Only the ZQ-290H handles other nutritional data.)
- Compare with previous records of calories taken in or burned.

The unit may not count steps correctly if you:

- Walk at an irregular pace, or in a crowded place.
- Shuffle legs excessively.
- Wear sandals when walking.
- Vary your movement (play sports, for example).
- Move up/down excessively.
- Are in a vehicle with vertical and horizontal motions.
- Attach the unit improperly (tilted, for example).



# SCIENTIFIC CALCULATORS

Easy-to-Use, Advanced Features

## GRAPHING

132 x 64  
Dot Matrix

64KB

827 functions



- Reversible keyboard: basic & advanced
- Graphing capability
- Slide show feature
- Solver function
- Matrix function

## EL-9900

- Power source: R03 (AAA) x 4 (Main), CR2032 x 1 (Backup)
- Dimensions: 86 (W) x 183 (D) x 23 (H) mm  
3-3/8" x 7-7/32" x 29/32"
- Weight: Approx. 240 g

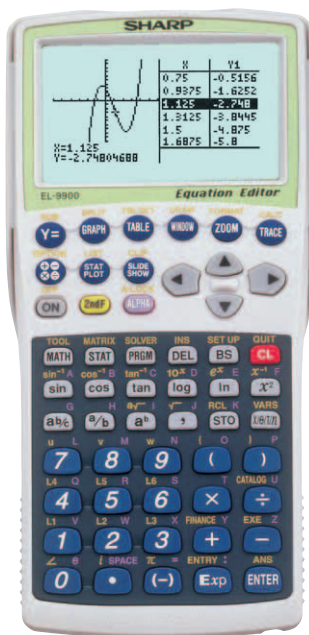

For Advanced Levels

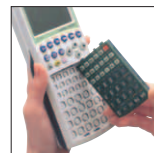

Reversible  
Keyboard

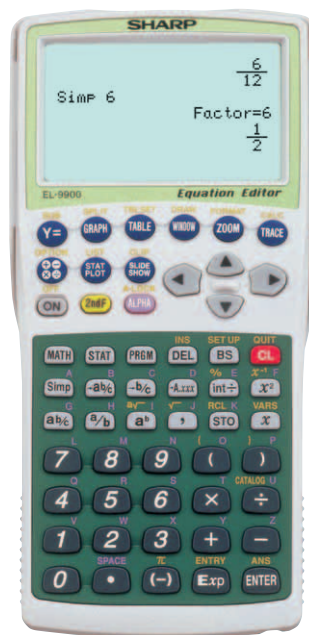

For Basic Levels

Scientific Calculators



## Reversible Keyboard

The Reversible Keyboard gives you a 2-in-1 Graphing Calculator. Keys for basic functions are on one side, while keys for advanced functions are on the other. Functions appearing on the menu display differ depending on which side of the keyboard is being used. The Reversible Keyboard saves you from having to get two separate models for different levels.

### Advanced Keyboard Side

for use at high school level  
(includes all the functions of the Basic Keyboard)

#### Examples of Functions

##### • Scientific Graphing •

Graphs can be drawn in one of 4 modes: by rectangular coordinates, by polar coordinates, by parameters, or by sequences. The Split Screen makes it easy to analyse the relationship between a graph and a table.

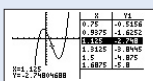
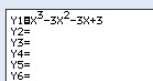

##### • Statistics/Regression •

Data can be easily input and revised in tabular form. You can also draw a variety of graphs, such as statistical graphs (9 types) and regression graphs (14 types), which are useful for analysing data.

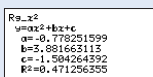
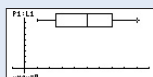

##### Statistical graphs

- Histogram
- Broken line plot
- Normal probability plot
- Normal distribution plot
- Box plot/Modified box plot
- Pie chart
- Scatter diagram
- XY line

##### Regression graphs

- Linear regression (ax+b & a+bx)
- Quadratic/Cubic/Quartic regression
- Natural/Common logarithm regression
- Exponential regression/Euler exponential regression
- Reciprocal regression
- Power regression
- Med-Med regression
- Logistic regression
- Sine regression

### Basic Keyboard Side

for use at junior high school level

#### Examples of Functions

##### • Fraction Study •

Includes a function for simplifying fractions. Finds common divisor either automatically or manually, leading to more effective learning.

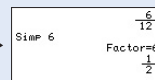
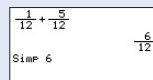

##### • Pie Chart •

Using a pie chart makes it easy to compare each part to the whole. The data can be displayed either as raw numbers or as percentages of the whole.

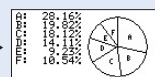
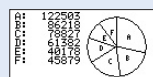

##### • Remainder Calculation •

Using the  $\lfloor$  key allows the user to calculate quotients and remainders easily.

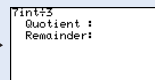
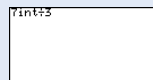

# SCIENTIFIC CALCULATORS

## A Graphing Calculator that Makes Learning and Teaching Easier

### Equation Editor

The Equation Editor displays equations as they would appear in a textbook, providing improved comprehension for students.

By Equation Editor  $\int_0^1 \frac{x}{\sqrt{x^2+1}} dx = 0.414213562$

By one-line editing  $\int_0^1 \frac{x}{\sqrt{x^2+1}} dx = 0.414213562$

Note: The EL-9900 can also switch to conventional one-line editing.

### Slide Show

Lesson preparations are made easy with the Slide Show function. By utilising slide shows, teachers can easily demonstrate lessons to the class, using the cursor to move between slides.

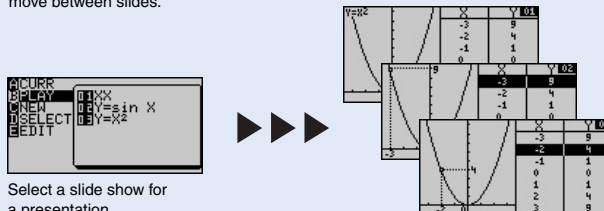

Select a slide show for a presentation.

Move forward/backward between the slides.

## Peripheral Devices for EL-9900

### OHP System

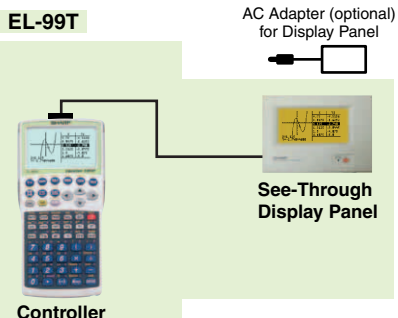

### PC-Link Kit

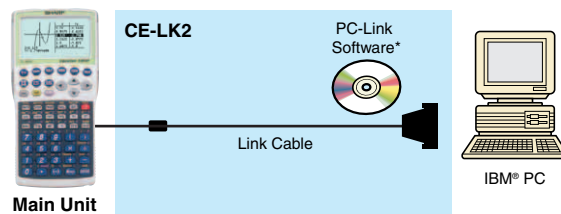

\*The PC software is intended to run on a PC with an English version of Microsoft® Windows® 98/98SE/2000 Professional/Me/XP Home/XP Professional.

### Set-to-Set Communication Cable

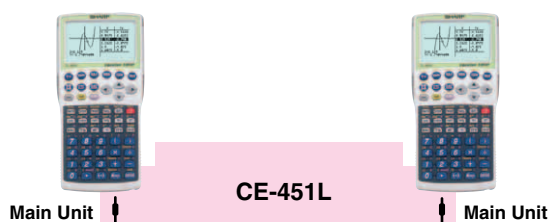

### Data Collection System

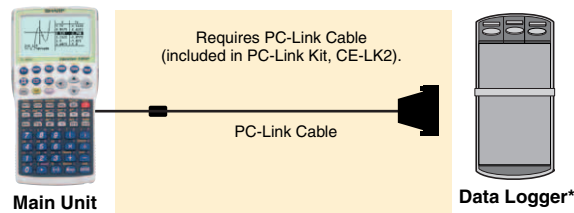

\*Either Vernier's LabPro® or ImTech's DataLab® can be used as a data logger. Vernier® <http://www.vernier.com/> ImTech® <http://firmwaresystems.com/>

## EL-9900 Homepage

For more information on the EL-9900, please go to the following page:

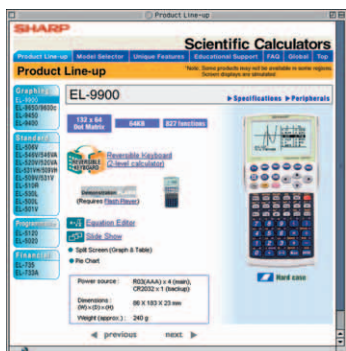

<http://sharp-world.com/products/calculator/product/graphing/9900.html>

N.B. This homepage is subject to being updated, so appearance may vary.

## New Calculator Homepage

The newly redesigned Sharp scientific calculator homepage is even more convenient than before. Along with detailed information about each model in our line-up, you'll find Flash-based demonstrations of the calculators' unique features and a variety of handy downloads for educational use.

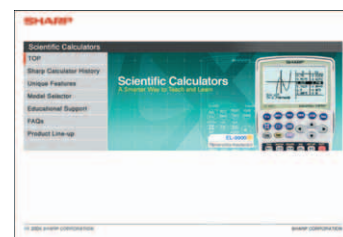

### Available Downloads Include:

- Classroom Materials
- Programme Resources
- Guide Books
- Key Symbols for Textbooks
- Illustrations for OHPs

<http://sharp-world.com/products/calculator/index.html>



**STANDARD**

ADVANCED D.A.L.  
Upper: 12-Digit  
Lower: 10+2-Digit  
**469 functions**

D.A.L. F1-F3  
F2-F4

2-Line 3-DIGIT PUNCTUATION

2-KEY ROLL-OVER

$a \pm K = X$   
 $b \pm K = Y$   
 $c \pm K = Z$

A+B=C  
 $\sqrt{C}=D$

d/dX P

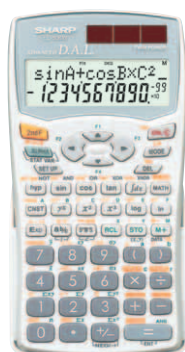

EL-506W(WH)

**NEW**

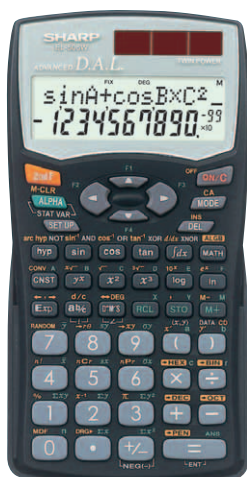

EL-506W(BK)

- Matrix/list calculations
- Constant/chain calculations
- Multi-line playback
- Solver function
- Matrix function
- Sturdy, stylish design

**EL-506W(BK/WH)**

- Power source: Twin power (Solar & LR44 x 2)
- Dimensions: 79.6 (W) x 154.5 (D) x 13.2 (H) mm  
3-1/8" x 6-3/32" x 17/32"
- Weight: Approx. 97 g

ADVANCED D.A.L.  
Upper: 12-Digit  
Lower: 10+2-Digit  
**419 functions**

D.A.L. F1-F3  
F2-F4

2-Line 3-DIGIT PUNCTUATION

2-KEY ROLL-OVER

$a \pm K = X$   
 $b \pm K = Y$   
 $c \pm K = Z$

A+B=C  
 $\sqrt{C}=D$

d/dX P



EL-520W(WH)

**NEW**

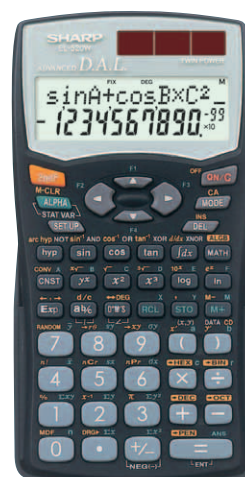

EL-520W(BK)

- Constant/chain calculations
- Multi-line playback
- Solver function
- Sturdy, stylish design

**EL-520W(BK/WH)**

- Power source: Twin power (Solar & LR44 x 2)
- Dimensions: 79.6 (W) x 154.5 (D) x 13.2 (H) mm  
3-1/8" x 6-3/32" x 17/32"
- Weight: Approx. 97 g

ADVANCED D.A.L.  
Upper: 12-Digit  
Lower: 10+2-Digit  
**272 functions**

D.A.L. 3-DIGIT PUNCTUATION

2-Line 2-KEY ROLL-OVER

P

$a \pm K = X$   
 $b \pm K = Y$   
 $c \pm K = Z$

A+B=C  
 $\sqrt{C}=D$

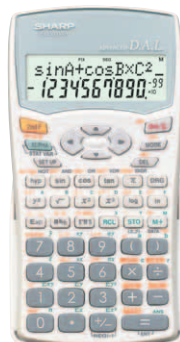

EL-531WH(WH)

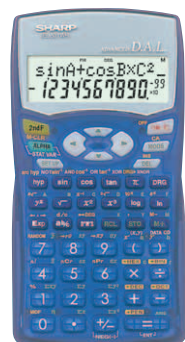

EL-531WH(BL)

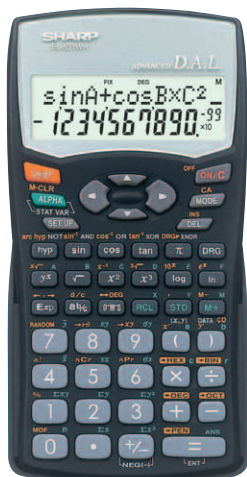

EL-531WH(BK)

**NEW**

- Constant/chain calculations
- Multi-line playback
- Sturdy, stylish design

**EL-531WH(BK/BL/WH)**

- Power source: R6 (AA) x 1
- Dimensions: 79.6 (W) x 154.5 (D) x 18.2 (H) mm  
3-1/8" x 6-3/32" x 23/32"
- Weight: Approx. 110 g

ADVANCED D.A.L.  
Upper: 12-Digit  
Lower: 10+2-Digit  
**272 functions**

D.A.L. 3-DIGIT PUNCTUATION

2-Line 2-KEY ROLL-OVER

P

$a \pm K = X$   
 $b \pm K = Y$   
 $c \pm K = Z$

A+B=C  
 $\sqrt{C}=D$

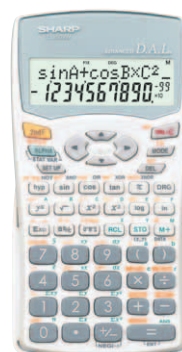

EL-509W(WH)

**NEW**

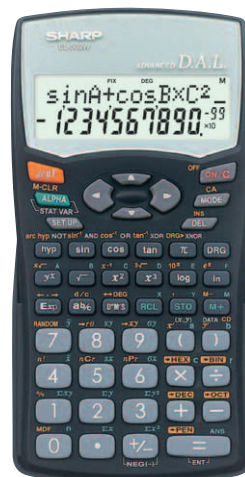

EL-509W(BK)

- Constant/chain calculations
- Multi-line playback
- Sturdy, stylish design

**EL-509W(BK/WH)**

- Power source: LR44 x 2
- Dimensions: 79.6 (W) x 154.5 (D) x 13.2 (H) mm  
3-1/8" x 6-3/32" x 17/32"
- Weight: Approx. 95 g

# SCIENTIFIC CALCULATORS

## STANDARD

ADVANCED **D.A.L.**

**11-Digit**

**160 functions**

**D.A.L.**

$a \pm K = X$   
 $b \pm K = Y$   
 $c \pm K = Z$

$A+B=C$   
 $\sqrt{C}=D$



- Constant/chain calculations
- Equation display

### EL-510R

- Power source: LR44 x 2
- Dimensions: 71.5 (W) x 124 (D) x 9.5 (H) mm  
2-13/16" x 4-7/8" x 3/8"
- Weight: Approx. 57 g

### EL-531WH/531W/509W OHP Calculator

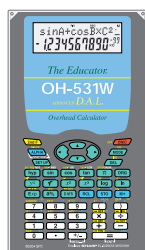
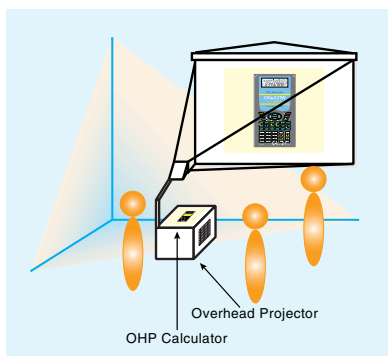

OH-531W  
(Final design pending)

\* Comprehensive calculation capability with same key operations and layout as EL-531WH/531W/509W.

- Number of functions: 272
- Power source: CR2032 x 1
- Dimensions: 120 (W) x 210 (D) x 10 (H) mm  
4-23/32" x 8-9/32" x 13/32"
- Weight: Approx. 370 g

## FINANCIAL

Upper: 12-Digit  
Lower: 10 + 2-Digit



- Constant/chain calculations
- Compound interest calculation
- Bond calculation

### EL-735

- Power source: CR2016 x 1
- Dimensions: 69 (W) x 132 (D) x 7.8 (H) mm  
2-23/32" x 5-3/16" x 5/16"
- Weight: Approx. 69 g (excluding wallet)

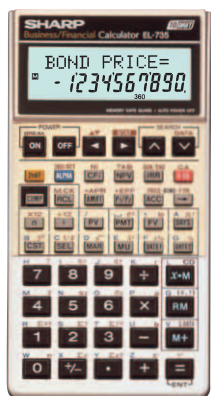

**10(8+2)-Digit**  
**131 functions**

$a \pm K = X$   
 $b \pm K = Y$   
 $c \pm K = Z$

$A+B=C$   
 $\sqrt{C}=D$

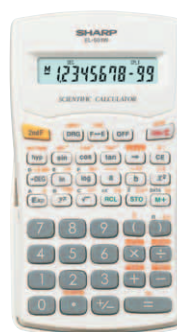

EL-501W(WH)



EL-501W(BK)

- Constant/chain calculations
- Stylish design

### EL-501W(BK/WH)

**NEW**

- Power source: LR44 x 2
- Dimensions: 78.6 (W) x 144 (D) x 11.6 (H) mm  
3-3/32" x 5-21/32" x 15/32"
- Weight: Approx. 75 g

## PROGRAMMABLE

**14 + 2-Digit**  
**by 3-Line**

**1,211 Steps**

**242 functions**

**D.A.L.**

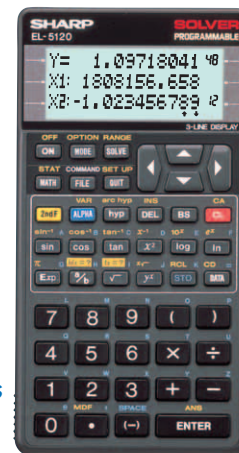

- Programmable up to 1,211 steps
- Solver function

### EL-5120

- Power source: CR2025 x 1
- Dimensions: 76 (W) x 145 (D) x 9.8 (H) mm  
3" x 5-23/32" x 3/8"
- Weight: Approx. 77 g

**10-Digit**



- Constant/chain calculations
- Compound interest calculation

### EL-733A

- Power source: LR44 x 2
- Dimensions: 76 (W) x 143 (D) x 8.5 (H) mm  
3" x 5-5/8" x 11/32"
- Weight: Approx. 110 g (including wallet)

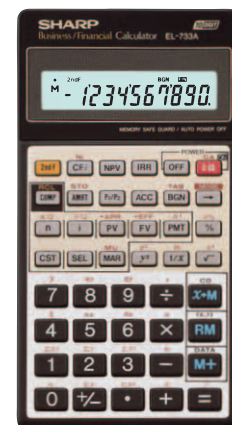



ADVANCED D.A.L. Greater Efficiency and Ease of Use

D.A.L. Direct Algebraic Logic (D.A.L.)

Until the introduction of SHARP's D.A.L., keying in equations had been a complicated process making scientific calculators difficult to use. Introduced in 1992 and an industry-first, SHARP's D.A.L. allows symbols and numbers of an equation to be entered as they are written. Instead of wasting energy on difficult calculator operations, users are free to concentrate on mathematical concepts.

For example, you want to input  $10 + 2 \times \sin 30 =$

- Non D.A.L. system key operation

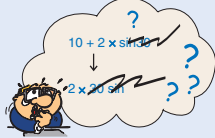

You have to push the keys in a different order than the actual equation, making the input process confusing.

- D.A.L. system key operation



You push the keys in the same order as the actual equation.

2-Line 2-Line Display

A 2-line display allows the users to check the equation and answer at the same time. Because the equation remains on display, it is easy to edit or make substitutions if necessary.

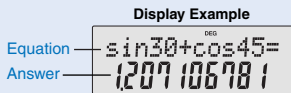

Multi-Line Playback

SHARP's Multi-Line Playback function lets you recall any of the last 142 steps you have made. This feature is very useful for comparing formulas and recalculating equations.

Comparative learning

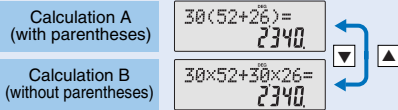

The equations are different, but the answers are the same.

Edit and recalculate

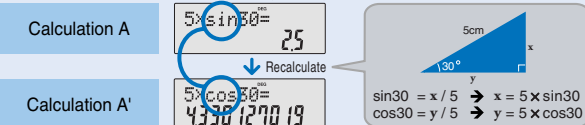

Change the previous equation and recalculate.

Constant/Chain Calculations

Constant and Chain Calculation functions are popular in general electronic calculators as they allow equations to be entered without having to key repeatedly. Confusion may arise however, as not all scientific calculators show the equation being equal to the answer in the formula display. With SHARP's scientific calculators, the figures you omit are automatically shown as K (constant) or ANS (answer). Contradictions between equations and answers are eliminated and calculations are easier and more logical to enter.

Constant Calculation

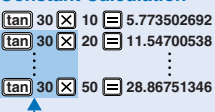

Constant (K x)

A portion of the equation is automatically memorised as a constant, thus omitting redundant input.

Chain Calculation

$3(x^2) + 4(x^2) = 25$  ( $3^2 + 4^2 = 25$ )



Chain (ANS)

The answer can be used as in the next calculation.

(Example using EL-506W.)

d/dx ∫ dx Numerical Derivative/Integral

Simply enter numerical values following the interactive on-screen instructions, and you can find the answer easily of derivative and integral calculations. You don't have to re-enter the formula, and the calculation can be repeated as many times as needed.

Equation  $y = x^2$

Numerical Derivative

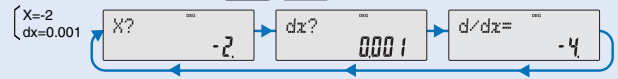

You can calculate the same derivative calculation repeatedly without having to input the formula again.

Numerical Integral

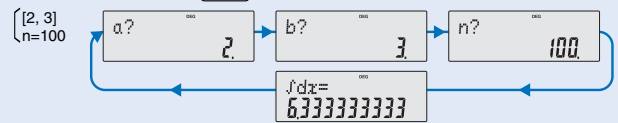

You can calculate the same integral calculation repeatedly without having to input the formula again.

F1-F3 F2-F4 Formula Memory

Frequently used formulas or complex equations can be stored as functions in Formula Memory\*. By recalling the formula, you can substitute new variables into the equation and recalculate it without having to enter the entire sequence again. Since you can do repeat equations, it's also convenient for simulations.

\*Formulas up to 256 characters in length can be stored in F1-F4.

How to use it

- 1) Store the equation into the calculator.
- 2) Call up the equation.
- 3) Use the equation to calculate.

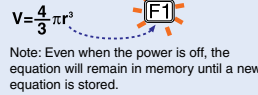

Note: Even when the power is off, the equation will remain in memory until a new equation is stored.

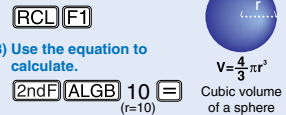

Solver Function

This function enables calculation of a variable x in a given equation. Other variables (a, b, c, etc.) must already be defined in order to calculate x.

Equation "sinx - 0.5" (DEG)

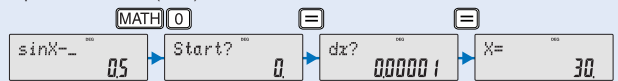

Matrix Function

In addition to the four basic arithmetic functions (excluding division between matrices),  $x^3$ ,  $x^2$ , and  $x^{-1}$ , users are provided with transpose and cumulative matrix functions, among others. Up to four matrices can be saved in memory, each up to four rows by four columns in size.

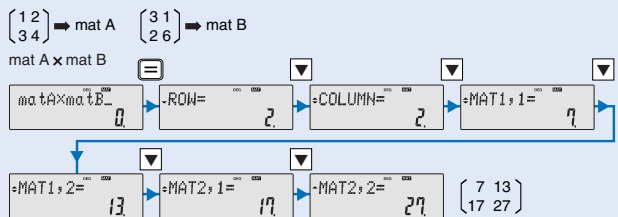

# PRINTING CALCULATORS

Wide Lineup Covering All Printing Needs

## DESKTOP

- 14-Digit
- 2-Memory
- L** DISPLAY
- GT FUNCTION
- 2-COLOUR PRINT
- ±TAX



### CS-4194HC

- Printing speed: **4.3** lines/sec.
- Power source: AC only
- Dimensions: 250 (W) x 345 (D) x 78 (H) mm  
9-27/32" x 13-19/32" x 3-1/6"
- Weight: Approx. 2,000 g

- 12-Digit
- L** DISPLAY
- GT FUNCTION
- Rate Converter
- AVG
- 2-COLOUR PRINT
- ±TAX



### EL-2630PII

- Printing speed: Approx. **4.8** lines/sec.
- Power source: AC only
- Dimensions: 228 (W) x 336 (D) x 78 (H) mm  
8-31/32" x 13-7/32" x 3-1/16"
- Weight: Approx. 1,900 g

- 12-Digit
- L** DISPLAY
- GT FUNCTION
- AVG
- 2-COLOUR PRINT
- ±TAX



### EL-2607P

- Printing speed: Approx. **4.3** lines/sec.
- Power source: AC only
- Dimensions: 222 (W) x 327 (D) x 78 (H) mm  
8-3/4" x 12-7/8" x 3-1/16"
- Weight: Approx. 1,900 g

- 12-Digit
- L** DISPLAY
- GT FUNCTION
- Rate Converter
- 2-COLOUR PRINT
- ±TAX



### EL-1607P

- Printing speed: 3.0 lines/sec.
- Power source: AC only
- Dimensions: 220 (W) x 303 (D) x 71.5 (H) mm  
8-21/32" x 11-15/16" x 2-27/32"
- Weight: Approx. 1,300 g

- 12-Digit
- L** DISPLAY
- GT FUNCTION
- 2-COLOUR PRINT
- ±TAX



### EL-2910R

- Printing speed: 3.0 lines/sec.
- Power source: AC only
- Dimensions: 221 (W) x 305 (D) x 72 (H) mm  
8-11/16" x 12-1/16" x 2-27/32"
- Weight: Approx. 1,300 g

- 12-Digit
- BackLight
- L** DISPLAY
- GT FUNCTION
- 2-COLOUR PRINT
- ±TAX



### EL-2902C

- Printing speed: 3.0 lines/sec.
- Power source: AC only
- Dimensions: 200 (W) x 251 (D) x 62 (H) mm  
7-27/32" x 9-7/8" x 2-7/16"
- Weight: Approx. 950 g



- 12-Digit**
- L<sup>SIZE</sup> DISPLAY**
- Cost Saver Margin**
- GT FUNCTION**
- 2-COLOUR PRINT**
- ±TAX**



## EL-2901RH

- Printing speed: 2.1 lines/sec.
- Power source: AC only
- Dimensions: 193 (W) x 256 (D) x 62.5 (H) mm  
7-19/32" x 10-3/32" x 2-15/32"
- Weight: Approx. 1,000 g



### SEMI-DESKTOP

- 12-Digit**
- L<sup>SIZE</sup> DISPLAY**
- 2-COLOUR PRINT**
- ±TAX**



## EL-1801C

- Printing speed: 2.1 lines/sec.
- Power source: DC/AC (AA x 4, AC adapter optional)
- Dimensions: 170 (W) x 231 (D) x 57.5 (H) mm  
6-11/16" x 9-15/16" x 2-1/4"
- Weight: Approx. 580 g

- 12-Digit**
- L<sup>SIZE</sup> DISPLAY**
- 2-COLOUR PRINT**
- ±TAX**



## EL-1750P

- Printing speed: Approx. 1.6 lines/sec.
- Power source: DC/AC (AA x 4, AC adapter optional)
- Dimensions: 150 (W) x 215 (D) x 50 (H) mm  
5-29/32" x 8-15/32" x 1-31/32"
- Weight: Approx. 500 g

### HAND-HELD

- 12-Digit**
- L<sup>SIZE</sup> DISPLAY**
- ±TAX**



## EL-1611P

- Printing speed: 1.6 lines/sec.
- Power source: DC/AC (AA x 4, AC adapter optional)
- Dimensions: 96 (W) x 191 (D) x 40 (H) mm  
3-3/4" x 7-1/2" x 1-9/16"
- Weight: Approx. 315 g

# SUPER CHECK & CORRECT

Edit, Verify and Confirm Calculations

## SEMI-DESKTOP

|                     |                 |              |
|---------------------|-----------------|--------------|
| 12-Digit            | 102 STEP MEMORY | REPEAT       |
| Tilt Display        | AUTO REPLAY     | CHANGE       |
| Last Answer         | CORRECT         | ANSWER CHECK |
| <b>L</b> DISPLAY    | INSERT          | ±TAX         |
| GT FUNCTION         | DELETE          |              |
| 3-DIGIT PUNCTUATION |                 |              |
| 2-KEY ROLL-OVER     |                 |              |



## EL-792C

- Power source: Twin power (Solar cell & CR2032 x 1)
- Dimensions: 130 (W) x 209 (D) x 21 (H) mm  
5-1/8" x 8-7/32" x 13/16"
- Weight: Approx. 220 g

## NICE SIZE

|                     |                 |              |
|---------------------|-----------------|--------------|
| 12-Digit            | 102 STEP MEMORY | REPEAT       |
| Tilt Display        | AUTO REPLAY     | CHANGE       |
| <b>L</b> DISPLAY    | CORRECT         | ANSWER CHECK |
| 3-DIGIT PUNCTUATION | INSERT          | ±TAX         |
| 2-KEY ROLL-OVER     | DELETE          |              |



## EL-782C

- Power source: Twin power (Solar cell & CR2032 x 1)
- Dimensions: 106 (W) x 177 (D) x 19 (H) mm  
4-3/16" x 6-31/32" x 3/4"
- Weight: Approx. 160 g

## MINI NICE SIZE

|                     |                 |              |
|---------------------|-----------------|--------------|
| 10-Digit            | 102 STEP MEMORY | CHANGE       |
| Slant Display       | AUTO REPLAY     | ANSWER CHECK |
| <b>L</b> DISPLAY    | CORRECT         | ±TAX         |
| 3-DIGIT PUNCTUATION | REPEAT          |              |
| 2-KEY ROLL-OVER     |                 |              |



## EL-771C

- Power source: Twin power (Solar cell & CR2032 x 1)
- Dimensions: 115 (W) x 144 (D) x 39 (H) mm  
4-17/32" x 5-21/32" x 1-17/32"
- Weight: Approx. 125 g





## Check & Correct Functions

SHARP's original **102-step** memory and editing functions make accounting easy.

**Check**

AUTO REPLAY

or

PREV NEXT

| INPUT |          |       |
|-------|----------|-------|
| STEP  | FUNCTION | DATA  |
| 01    |          | 800   |
| 02    | +        | 9750  |
| 03    | +        | 5420  |
| 04    | -        | 360   |
| 05    | -        | 490   |
| 06    | +        | 230   |
| 07    | +        | 450   |
| 08    | +        | 450   |
| 09    | +        | 450   |
| 10    | =        | 16700 |

**EDIT**

**CORRECT** (step 02)  
To change the wrong entry of 9750 to 8750

CORRECT 8750 CORRECT

**INSERT** (step 04)  
To insert the forgotten entry of 300

INS + 300 CORRECT

**DELETE** (step 06)  
To delete the unwanted entry of 230

DEL →

**REPEAT ENTRY**  
To repeat the entry of 450 twice

+ 450 REPEAT REPEAT  
(step 07) (step 08) (step 09)

**TAX CALCULATION**  
To add tax to the total

+TAX (RATE: 5%)

**CHANGE CALCULATION**  
To calculate the amount to return from a payment of 20000

20000 CHANGE

**102**  
Step  
Memory

+TAX 17535

(PAYMENT □: 20000)

20000

CHANGE 2465

### Powerful Function Keys

**102**  
STEP MEMORY

**AUTO**  
REPLAY

#### 102-Step Memory and Auto Replay

The last 102 actions can be recalled step-by-step by scrolling with the cursor keys. Pressing the Auto Replay key reviews the entire calculation automatically.

**CORRECT**

**INSERT**

**DELETE**

#### Correct, Insert and Delete Editing Functions

The Correct key allows you to correct wrong data you've entered. Insert new data with the Insert key and delete previous entries with the Delete key. To confirm the result, press the Auto Replay key.

**REPEAT**

#### Repeat

The Repeat key is extremely handy when entering the same values. Pressing it enters the last inputted value.

**+TAX**

**CHANGE**

#### Tax and Change Calculations

Pressing the Tax key automatically adds or subtracts the total tax amount. After entering the amount received as payment, press the Change key to see how much change to return.

**ANSWER**  
CHECK

#### Answer Check

An "OK" sign appears when the checking calculation matches the result of the first.

# OFFICE CALCULATORS

Functions and Features that Get the Job Done

## DESKTOP/SEMI-DESKTOP

12-Digit

Slant Display

L<sup>ARGE</sup> DISPLAY

GT FUNCTION

3-DIGIT PUNCTUATION

2-KEY ROLL-OVER



### CS-2122H

Time Calculation

- Power source: AC only
- Dimensions: 210 (W) x 220 (D) x 74 (H) mm  
8-9/32" x 8-21/32" x 2-29/32"
- Weight: Approx. 850 g

12-Digit

L<sup>ARGE</sup> DISPLAY

Kick Stand

GT FUNCTION

3-DIGIT PUNCTUATION

2-KEY ROLL-OVER

☺/☹



### CS-2130

- Protective Display Cover
- Power source: Twin power (Solar cell & CR2032 x 1)
- Dimensions: 185 (W) x 175 (D) x 18 (H) mm  
7-9/32" x 6-7/8" x 23/32"
- Weight: Approx. 290 g

16-Digit

Slant Display

L<sup>ARGE</sup> DISPLAY

GT FUNCTION

3-DIGIT PUNCTUATION

2-KEY ROLL-OVER

☺/☹



### EL-6138

- Power source: Twin power (Solar cell & CR2032 x 1)
- Dimensions: 190 (W) x 154 (D) x 42 (H) mm  
7-15/32" x 6-1/16" x 1-21/32"
- Weight: Approx. 330 g

12-Digit

Slant Display

L<sup>ARGE</sup> DISPLAY

GT FUNCTION

3-DIGIT PUNCTUATION

2-KEY ROLL-OVER

☺/☹



### EL-2135

- Protective Display Cover
- Power source: Twin power (Solar cell & CR2032 x 1)
- Dimensions: 190 (W) x 154 (D) x 42 (H) mm  
7-15/32" x 6-1/16" x 1-21/32"
- Weight: Approx. 330 g

12-Digit

Tilt Display

L<sup>ARGE</sup> DISPLAY

GT FUNCTION

3-Rate Converter

3-DIGIT PUNCTUATION

2-KEY ROLL-OVER

RESUME

ANSWER CHECK

±TAX

☺/☹



### EL-2125C

- Power source: Twin power (Solar cell & LR44 x 1)
- Dimensions: 140 (W) x 195 (D) x 22.5 (H) mm  
5-19/32" x 7-21/32" x 29/32"
- Weight: Approx. 215 g

12-Digit

L<sup>ARGE</sup> DISPLAY

Kick Stand

GT FUNCTION

3-DIGIT PUNCTUATION

2-KEY ROLL-OVER

RESUME PLUS

ANSWER CHECK

+TAX

☺/☹

DAY/DATE

☺/☹

☺/☹

☺/☹

☺/☹

☺/☹

☺/☹

☺/☹

☺/☹

☺/☹

☺/☹

☺/☹

☺/☹

☺/☹

☺/☹

☺/☹

☺/☹

☺/☹

☺/☹

☺/☹

☺/☹

☺/☹

☺/☹

☺/☹

☺/☹

☺/☹

☺/☹

☺/☹

☺/☹

☺/☹

☺/☹

☺/☹

☺/☹

☺/☹

☺/☹

☺/☹

☺/☹

☺/☹

☺/☹

☺/☹

☺/☹

☺/☹

☺/☹

☺/☹

☺/☹

☺/☹

☺/☹

☺/☹

☺/☹

☺/☹

☺/☹

☺/☹

☺/☹

☺/☹

☺/☹

☺/☹

☺/☹

☺/☹

☺/☹

☺/☹

☺/☹

☺/☹

☺/☹

☺/☹

☺/☹

☺/☹

☺/☹

☺/☹

☺/☹

☺/☹

☺/☹

☺/☹

☺/☹

☺/☹

☺/☹

☺/☹

☺/☹

☺/☹

☺/☹

☺/☹

☺/☹

☺/☹

☺/☹

☺/☹

☺/☹

☺/☹

☺/☹

☺/☹

☺/☹

☺/☹

☺/☹

☺/☹

☺/☹

☺/☹

☺/☹

☺/☹

☺/☹

☺/☹

☺/☹

☺/☹

☺/☹

☺/☹

☺/☹

☺/☹

☺/☹

☺/☹

☺/☹

☺/☹

☺/☹

☺/☹

☺/☹

☺/☹

☺/☹

☺/☹

☺/☹

☺/☹

☺/☹

☺/☹

☺/☹

☺/☹

☺/☹

☺/☹

☺/☹

☺/☹

☺/☹

☺/☹

☺/☹

☺/☹

☺/☹

☺/☹

☺/☹

☺/☹

☺/☹

☺/☹

☺/☹

☺/☹

☺/☹

☺/☹

☺/☹

☺/☹

☺/☹

☺/☹

☺/☹

☺/☹

☺/☹

☺/☹

☺/☹

☺/☹

☺/☹

☺/☹

☺/☹

☺/☹

☺/☹

☺/☹

☺/☹

☺/☹

☺/☹

☺/☹

☺/☹

☺/☹

☺/☹

☺/☹

☺/☹

☺/☹

☺/☹

☺/☹

☺/☹

☺/☹

☺/☹

☺/☹

☺/☹

☺/☹

☺/☹

☺/☹

☺/☹

☺/☹

☺/☹

☺/☹

☺/☹

☺/☹

☺/☹

☺/☹

☺/☹

☺/☹

☺/☹

☺/☹

☺/☹

☺/☹

☺/☹

☺/☹

☺/☹

☺/☹

☺/☹

☺/☹

☺/☹

☺/☹

☺/☹

☺/☹

☺/☹

☺/☹

☺/☹

☺/☹

☺/☹

☺/



- 12-Digit**
- L<sup>ARGE</sup> DISPLAY**
- Kick Stand**
- GT FUNCTION**
- ANSWER CHECK**
- ±TAX**
- 3-DIGIT PUNCTUATION**
- 2-KEY ROLL-OVER**



## EL-2139S

- Power source: Twin power (Solar cell & LR44 x 1)
- Dimensions: 140 (W) x 195 (D) x 22 (H) mm  
5-19/32" x 7-21/32" x 7/8"
- Weight: Approx. 235 g

- 12-Digit**
- L<sup>ARGE</sup> DISPLAY**
- Kick Stand**
- GT FUNCTION**
- 3-DIGIT PUNCTUATION**
- 2-KEY ROLL-OVER**
- Cost Sell Margin**



## EL-338F

- Power source: Twin power (Solar cell & LR44 x 1)
- Dimensions: 133 (W) x 200 (D) x 18 (H) mm  
5-1/4" x 7-27/32" x 23/32"
- Weight: Approx. 230 g

### NICE SIZE

- 12-Digit**
- L<sup>ARGE</sup> DISPLAY**
- Kick Stand**
- GT FUNCTION**
- 3-DIGIT PUNCTUATION**
- 2-KEY ROLL-OVER**
- RESUME PLUS**
- DAY/DATE**
- ANSWER CHECK**
- +TAX**



## EL-387R

- Power source: Twin power (Solar cell & LR44 x 1)
- Dimensions: 107 (W) x 169 (D) x 19 (H) mm  
4-7/32" x 6-21/32" x 3/4"
- Weight: Approx. 158 g

- 12-Digit**
- Tilt Display**
- L<sup>ARGE</sup> DISPLAY**
- GT FUNCTION**
- 3-Rate Converter**
- 3-DIGIT PUNCTUATION**
- 2-KEY ROLL-OVER**
- RESUME**
- ANSWER CHECK**
- ±TAX**



## EL-337C

- Power source: Twin power (Solar cell & LR44 x 1)
- Dimensions: 108 (W) x 175 (D) x 22 (H) mm  
4-7/32" x 6-7/8" x 7/8"
- Weight: Approx. 165 g

- 12-Digit**
- L<sup>ARGE</sup> DISPLAY**
- Kick Stand**
- GT FUNCTION**
- 3-DIGIT PUNCTUATION**
- 2-KEY ROLL-OVER**
- ANSWER CHECK**
- ±TAX**



## EL-339S

- Power source: Twin power (Solar cell & LR44 x 1)
- Dimensions: 108.6 (W) x 176 (D) x 18.4 (H) mm  
4-9/32" x 6-15/16" x 23/32"
- Weight: Approx. 165 g

- 14-Digit**
- L<sup>ARGE</sup> DISPLAY**
- Kick Stand**
- Easy Hold**
- 3-DIGIT PUNCTUATION**
- 2-KEY ROLL-OVER**
- RESUME**
- ±TAX**



## EL-421M

- Power source: Twin power (Solar cell & LR44 x 1)
- Dimensions: 108 (W) x 170 (D) x 15 (H) mm  
4-1/4" x 6-11/16" x 19/32"
- Weight: Approx. 160 g

# OFFICE CALCULATORS

## NICE SIZE

10-Digit

L<sup>SIZE</sup> DISPLAY

Kick Stand

GT FUNCTION

Easy Hold

3-DIGIT PUNCTUATION

2-KEY ROLL-OVER

±TAX

☺/☹



## EL-334F

- Power source: Twin power (Solar cell & LR44 x 1)
- Dimensions: 108 (W) x 170 (D) x 15 (H) mm  
4-1/4" x 6-11/16" x 19/32"
- Weight: Approx. 160 g

## MINI NICE SIZE

10-Digit

±TAX

Slant Display

☺/☹

L<sup>SIZE</sup> DISPLAY

3-DIGIT PUNCTUATION

2-KEY ROLL-OVER



## EL-332A

- Power source: Twin power (Solar cell & LR44 x 1)
- Dimensions: 101 (W) x 142 (D) x 34 (H) mm  
3-31/32" x 5-19/32" x 1-11/32"
- Weight: Approx. 115 g

## Convenient Functions

RESUME

### Resume Function

To resume operations after the Auto Power-Off Function has taken effect, press the Resume key. The display will return to the calculation that was in progress, providing the following indicator:

- **Function Symbol:** indicates the last function used in the calculation.

RESUME PLUS

### Resume Plus

(Resume Function plus Line Counter and Condition Symbol)

Adds the following indicators as well as Resume Function:

- **Line Counter:** shows number of figures entered.
- **Condition Symbol:** indicates the next figure should be entered.

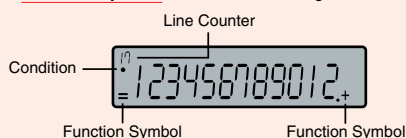

ANSWER CHECK

### Answer Check

An "OK" sign appears when the checking calculation matches the result of the first.



±TAX

### Tax Calculation

Easily calculates prices with or without taxes.

DAY/DATE

### Day/Date Calculation

- **Day Calculation:** determines number of days between two dates.
- **Date Calculation:** determines the date after a number of days and a starting date have been entered.

10-Digit

(EL-331A)

3-DIGIT PUNCTUATION

8-Digit

(EL-330A)

2-KEY ROLL-OVER

Tilt Display

±TAX

L<sup>SIZE</sup> DISPLAY

☺/☹

Easy Hold



EL-331A

## EL-331A, EL-330A

- Power source: Twin power (Solar cell & LR44 x 1)
- Dimensions: 102 (W) x 148 (D) x 15 (H) mm  
4-1/32" x 5-13/16" x 19/32"
- Weight: Approx. 125 g

8-Digit

Slant Display

L<sup>SIZE</sup> DISPLAY

Easy Hold

☺/☹



## EL-310A

- Power source: Twin power (Solar cell & LR1130 x 1)
- Dimensions: 87 (W) x 116 (D) x 20 (H) mm  
3-13/32" x 4-9/16" x 25/32"
- Weight: Approx. 76 g



# Stylish Design

Something new for our office and personal calculators: acrylic glass screen-tops. Sturdy enough to protect the screen from damage, the new screen-tops also bring a touch of modern style to the work station.



- 10-Digit**
- Slant Display**
- L<sup>ARGE</sup> DISPLAY**
- Rate Converter**
- 3-DIGIT PUNCTUATION**
- 2-KEY ROLL-OVER**
- ±TAX**
- ☺/☹**

## EL-M711G

- Power source: Twin power (Solar cell & LR44 x 1)
- Dimensions: 100 (W) x 151.5 (D) x 33 (H) mm  
3-15/16" x 5-31/32" x 1-5/16"
- Weight: Approx. 130 g

- 8-Digit**
- Slant Display**
- L<sup>ARGE</sup> DISPLAY**
- Rate Converter**
- 3-DIGIT PUNCTUATION**
- 2-KEY ROLL-OVER**
- ±TAX**
- ☺/☹**

## EL-M710G

- Power source: Twin power (Solar cell & LR44 x 1)
- Dimensions: 100 (W) x 151.5 (D) x 33 (H) mm  
3-15/16" x 5-31/32" x 1-5/16"
- Weight: Approx. 130 g



- 8-Digit**
- Slant Display**
- L<sup>ARGE</sup> DISPLAY**
- Rate Converter**
- 3-DIGIT PUNCTUATION**
- 2-KEY ROLL-OVER**
- ±TAX**
- ☺/☹**

## EL-M700G

- Power source: Twin power (Solar cell & LR44 x 1)
- Dimensions: 87 (W) x 116.5 (D) x 28.5 (H) mm  
3-7/16" x 4-19/32" x 1-1/8"
- Weight: Approx. 85 g



# 12/14 DIGIT CALCULATORS

Offering Reliability and Convenience

## NICE SIZE

**14-Digit** **±TAX** **NEW**

**Tilt Display**

**L<sup>DS</sup> DISPLAY**

**Easy Hold**

**3-DIGIT PUNCTUATION**

**2-KEY ROLL-OVER**

### EL-145A

- Power source: Twin power (Solar cell & LR44 x 1)
- Dimensions: 110 (W) x 168 (D) x 15 (H) mm  
4-11/32" x 6-5/8" x 19/32"
- Weight: Approx. 160 g

**12-Digit** **NEW**

**Tilt Display**

**L<sup>DS</sup> DISPLAY**

**Easy Hold**

**3-DIGIT PUNCTUATION** **±TAX**

**2-KEY ROLL-OVER**

### EL-125A

- Power source: Twin power (Solar cell & LR44 x 1)
- Dimensions: 110 (W) x 168 (D) x 15 (H) mm  
4-11/32" x 6-5/8" x 19/32"
- Weight: Approx. 160 g

## MINI NICE SIZE

**14-Digit** **±TAX** **NEW**

**Tilt Display**

**L<sup>DS</sup> DISPLAY**

**Easy Hold**

**3-DIGIT PUNCTUATION**

**2-KEY ROLL-OVER**

### EL-144A

- Power source: Twin power (Solar cell & LR44 x 1)
- Dimensions: 102 (W) x 148 (D) x 15 (H) mm  
4-1/32" x 5-13/16" x 19/32"
- Weight: Approx. 125 g

**12-Digit** **NEW**

**Tilt Display**

**L<sup>DS</sup> DISPLAY**

**Easy Hold**

**3-DIGIT PUNCTUATION** **±TAX**

**2-KEY ROLL-OVER**

### EL-124A

- Power source: Twin power (Solar cell & LR44 x 1)
- Dimensions: 102 (W) x 148 (D) x 15 (H) mm  
4-1/32" x 5-13/16" x 19/32"
- Weight: Approx. 125 g

## HAND-HELD/HARD COVER

**14-Digit**

**L<sup>DS</sup> DISPLAY**

**Hard Cover**

**3-DIGIT PUNCTUATION**

**2-KEY ROLL-OVER**

**NEW**

### EL-143S

- Power source: Twin power (Solar cell & LR1130 x 1)
- Dimensions (closed): 72 (W) x 115 (D) x 12 (H) mm  
2-27/32" x 4-17/32" x 15/32"
- Weight: Approx. 66 g

**12-Digit**

**L<sup>DS</sup> DISPLAY**

**Hard Cover**

**3-DIGIT PUNCTUATION**

**2-KEY ROLL-OVER**

**NEW**

### EL-123S

- Power source: Twin power (Solar cell & LR1130 x 1)
- Dimensions (closed): 72 (W) x 115 (D) x 12 (H) mm  
2-27/32" x 4-17/32" x 15/32"
- Weight: Approx. 66 g



# PERSONAL CALCULATORS

Hand-Fitting Sizes with the Functions You Need

## WALLET/HAND-HELD

10-Digit

**L** DISPLAY

Cost Sell Margin

With Wallet

3-DIGIT PUNCTUATION

☺/☹



### EL-480S

- Power source: Twin power (Solar cell & LR1130 x 1)
- Dimensions: 69 (W) x 119 (D) x 7.1 (H) mm  
2-23/32" x 4-11/16" x 9/32"
- Weight: Approx. 65 g (including wallet)



8-Digit

**L** DISPLAY

Converter Metric

With Wallet

3-DIGIT PUNCTUATION

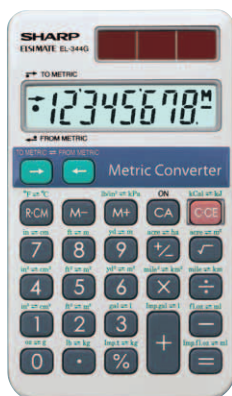

### EL-344G

- Power source: Solar 50 Lux
- Dimensions: 70 (W) x 122 (D) x 5.9 (H) mm  
2-3/4" x 4-13/16" x 7/32"
- Weight: Approx. 80 g (including wallet)

10-Digit

**L** DISPLAY

3-DIGIT PUNCTUATION

2-KEY ROLL-OVER

±TAX

☺/☹

P

**NEW**



### EL-W211G

- Power source: Twin power (Solar cell & CR2016 x 1)
- Dimensions: 70 (W) x 117 (D) x 8.1 (H) mm  
2-3/4" x 4-19/32" x 5/16"
- Weight: Approx. 56 g

10-Digit

**L** DISPLAY

With Wallet

3-DIGIT PUNCTUATION

2-KEY ROLL-OVER

±TAX

☺/☹

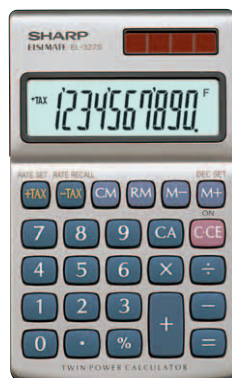

### EL-327S

- Power source: Twin power (Solar cell & LR1130 x 1)
- Dimensions: 69 (W) x 115 (D) x 6.5 (H) mm  
2-23/32" x 4-17/32" x 1/4"
- Weight: Approx. 59 g (excluding wallet)

8-Digit

**L** DISPLAY

With Wallet

3-DIGIT PUNCTUATION

2-KEY ROLL-OVER

±TAX

☺/☹

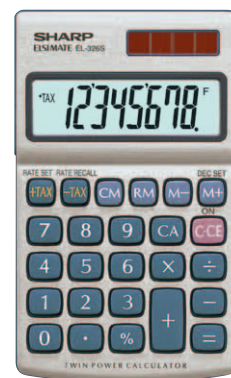

### EL-326S

- Power source: Twin power (Solar cell & LR1130 x 1)
- Dimensions: 69 (W) x 115 (D) x 6.5 (H) mm  
2-23/32" x 4-17/32" x 1/4"
- Weight: Approx. 59 g (excluding wallet)

# PERSONAL CALCULATORS

## WALLET/HAND-HELD

12-Digit

**L** **DISPLAY**

3-DIGIT  
PUNCTUATION

2-KEY  
ROLL-OVER



P

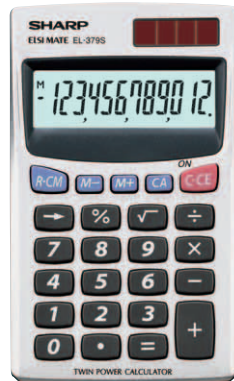

### EL-379S

- Power source: Twin power (Solar cell & LR1130 x 1)
- Dimensions: 70 (W) x 117 (D) x 8 (H) mm  
2-3/4" x 4-19/32" x 5/16"
- Weight: Approx. 47 g

10-Digit

**L** **DISPLAY**

3-DIGIT  
PUNCTUATION

2-KEY  
ROLL-OVER



P

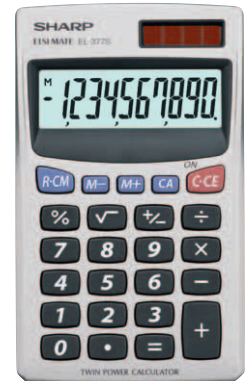

### EL-377S

- Power source: Twin power (Solar cell & LR1130 x 1)
- Dimensions: 70 (W) x 117 (D) x 8 (H) mm  
2-3/4" x 4-19/32" x 5/16"
- Weight: Approx. 47 g

8-Digit

**L** **BLUE  
DISPLAY**

3-DIGIT  
PUNCTUATION

2-KEY  
ROLL-OVER

**±TAX**



### EL-371S

- Power source: Twin power (Solar cell & LR1130 x 1)
- Dimensions: 66 (W) x 108 (D) x 7 (H) mm  
2-19/32" x 4-7/32" x 9/32"
- Weight: Approx. 40 g

8-Digit

**L** **DISPLAY**

3-DIGIT  
PUNCTUATION

2-KEY  
ROLL-OVER

**±TAX**



P

**NEW**

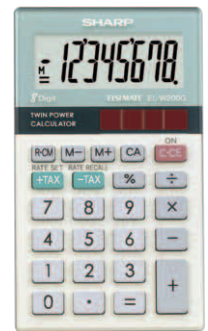

### EL-W200G

- Power source: Twin power (Solar cell & CR2016 x 1)
- Dimensions: 60 (W) x 105 (D) x 8.1 (H) mm  
2-3/8" x 4-1/8" x 5/16"
- Weight: Approx. 45 g

8-Digit

Slant Display

**L** **DISPLAY**

3-DIGIT  
PUNCTUATION

**±TAX**



P

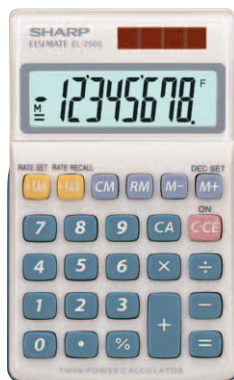

### EL-250S

- Protective Display Cover
- Power source: Twin power (Solar cell & LR1130 x 1)
- Dimensions: 71 (W) x 116 (D) x 16.5 (H) mm  
2-25/32" x 4-9/16" x 21/32"
- Weight: Approx. 58 g

8-Digit

Slant Display

Last Answer

**L** **DISPLAY**

3-DIGIT  
PUNCTUATION



P

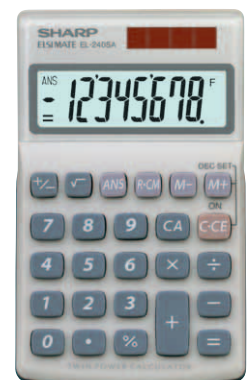

### EL-240SA

- Protective Display Cover
- Power source: Twin power (Solar cell & LR1130 x 1)
- Dimensions: 71 (W) x 116 (D) x 16.5 (H) mm  
2-25/32" x 4-9/16" x 21/32"
- Weight: Approx. 58 g



8-Digit

**L** LARGE DISPLAY

P



## EL-231L

- Power source: AA x 1
- Dimensions: 69 (W) x 115.5 (D) x 20.5 (H) mm  
2-23/32" x 4-9/16" x 13/16"
- Weight: Approx. 71 g

8-Digit

**L** LARGE DISPLAY

P

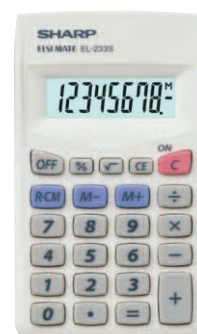

## EL-233S

- Power source: LR1130 x 1
- Dimensions: 60 (W) x 103 (D) x 8.3 (H) mm  
2-3/8" x 4-1/16" x 5/16"
- Weight: Approx. 35 g

### HARD COVER

8-Digit

**L** LARGE DISPLAY



P



## EL-376S

- Power source: Twin power (Solar cell & LR1130 x 1)
- Dimensions (closed): 72 (W) x 115 (D) x 12 (H) mm  
2-13/16" x 4-17/32" x 15/32"
- Weight: Approx. 66 g

8-Digit

**L** LARGE DISPLAY



## EL-243S

- Power source: Twin power (Solar cell & LR1130 x 1)
- Dimensions (closed): 64 (W) x 105 (D) x 11 (H) mm  
2-1/2" x 4-5/32" x 7/16"
- Weight: Approx. 51 g

### CARD

8-Digit

**L** LARGE DISPLAY



3-DIGIT PUNCTUATION



## EL-879M

- Power source: Twin power (Solar cell & LR1130 x 1)
- Dimensions: 99.6 (W) x 67 (D) x 7.3 (H) mm  
3-29/32" x 2-21/32" x 9/32"
- Weight: Approx. 59 g (including wallet)



- 
- Design and specifications are current as of September 2004, but are subject to change without prior notice.
  - All company and/or product names are trademarks and/or registered trademarks of their respective manufacturers. Sharp makes no warranties or representations of any kind with respect to these products.
  - Some peripheral products may not be available in some regions.
  - Screen displays are simulated.
  - Some models may not be available in some regions. Please ask your Sharp dealer for details.

Distributed by:



Revised Mar. 2005

# **SPECIFICATIONS & MERCHANDISING INFORMATION**

2004-2005

Electronic Dictionaries,  
Electronic Calculators and Organizers

**SHARP**  
SHARP CORPORATION OSAKA, JAPAN

# ELECTRONIC DICTIONARIES

## SPECIFICATIONS

| Model                                |  | PW-E500/E300  |
|--------------------------------------|--|---|
| Display                              |  | 159 x 80 dots (35 columns, 8 lines) with 2 font sizes (9- & 12-point)   |
| Dictionaries Included                |  | <i>Oxford Dictionary of English 2e</i> © Oxford University Press 2003<br><i>New Oxford Thesaurus of English</i> © Oxford University Press 2000<br><i>The Oxford Dictionary of Quotations 5e</i> © Oxford University Press 1999 (PW-E500 only) |
| Number of Entries                    | <i>Oxford Dictionary of English (2nd Ed.)</i>        | Approx. 355,000 words, phrases, and definitions   |
|                                      | <i>New Oxford Thesaurus of English</i>               | Approx. 600,000 alternative and opposite words  |
|                                      | <i>The Oxford Dictionary of Quotations (5th Ed.)</i> | Approx. 20,000 quotations, comprehensively indexed, & approx. 3,200 authors (PW-E500 only)  |
| Calculator Function                  |  | 12-digit calculation of addition, subtraction, multiplication, division, percentage, memory calculation, etc.   |
| Converter Function                   |  | 12-digit conversion of currencies and measurements  |
| Power Consumption                    |  | 0.11 W  |
| Operation Temperature                |  | 0 °C – 40°C (32°F – 104°F)  |
| Power Supply                         |  | 1.5 V (DC): Alkaline battery LR03 (AAA size) x 1  |
| Battery Life                         |  | Approx. 200 hours, if data is displayed continuously at 25°C/77°F (May vary according to various usage conditions)  |
| Auto Power Off                       |  | Activated after 3, 5, 10 or 20 minutes (user settable)  |
| Dimensions (When Closed) (W x D x H) |  | 125 mm x 79.4 mm x 16.8 mm (4-29/32" x 3-1/8" x 21/32")   |
| Weight (Including Battery)           |  | Approx. 148 g   |



# ELECTRONIC ORGANIZERS

## SPECIFICATIONS

| Model                                  | ZQ-590A  | ZQ-290H   | ZQ-270P   | ZQ-190P  |   |
|--|--|---|---|--|---|
| <b>Display</b>                         | 80 dots x 111 dots                                   | 14-column x 5-line  | 111 dots x 48 dots  | 19-column x 5-line   |   |
| <b>Backlight</b>                       | ○  | ○   | ○   | ○  |   |
| <b>Memory Capacity</b>                 | 8MB (Flash memory) <sup>*1</sup>                     | 1.5MB equivalent <sup>*1, *6</sup>  | 256KB (Flash memory) <sup>*1</sup>  | 256KB  |   |
| <b>Time Management</b>                 | <b>Calendar</b>                                      | 6-week (1-month)  | 4-week  | 1-month  |   |
|  | <b>Schedule</b>                                      | ○   | ○   | ○  |   |
|  | <b>Anniversary</b>                                   | ○ <sup>*2</sup>   | ○ <sup>*2</sup>   | ○ <sup>*2</sup>  | ○ <sup>*2</sup>   |
|  | <b>To Do</b>   | ○ <sup>*2</sup>   | ○ <sup>*2</sup>   | ○ <sup>*2</sup>  | ○ <sup>*2</sup>   |
|  | <b>Home Clock</b>                                    | ○   | ○   | ○  | ○   |
|  | <b>World Clock</b>                                   | 97-city   | 42-city   | 96-city  | 27-city   |
|  | <b>Alarm</b>   | ○   | ○   | ○  | ○   |
| <b>Database</b>                        | <b>Expense</b>                                       | ○ <sup>*2</sup>   | ○ <sup>*2</sup>   | ○ <sup>*2</sup>  |   |
|  | <b>Telephone Directory</b>                           | 3-file  | 3-file  | 3-file   | 3-file<br>(Multi Address<br>Directory System)   |
|  | <b>E-mail Address</b>                                | in Tel directory  | in Tel directory  | in Tel directory   | —   |
|  | <b>Web Address (URL)</b>                             | —   | —   | —  | —   |
|  | <b>Memo</b>  | ○   | ○   | ○  | ○   |
|  | <b>E-mail Viewer</b>                                 | ○ <sup>*3</sup>   | —   | —  | —   |
|  | —  | —   | —   | —  | —   |
| <b>Calculation</b>                     | ○  | ○   | ○   | ○  |   |
|  | <b>Conversion</b>                                    | ○   | ○   | ○  |   |
| <b>Spell Checker</b>                   | (Approx. 12,000 English words)                       | (Approx. 12,000 English words)  | —   | —  |   |
| <b>English/Spanish Word Translator</b> | ○ <sup>*4</sup><br>(Approx. 12,000 words each)       | —   | —   | —  |   |
| <b>Phrase Book</b>                     | ○ (5-language) <sup>*4</sup>                         | —   | —   | —  |   |
| <b>Game</b>                            | ○  | ○   | ○   | ○  |   |
| <b>Secret</b>                          | ○ <sup>*2</sup>                                      | ○ <sup>*2</sup>   | ○ <sup>*2</sup>   | ○ <sup>*2</sup>  |   |
| <b>Diet Function</b>                   | —  | ○ <sup>*7</sup>   | —   | —  |   |
| <b>Search</b>                          | <b>Sequential/Direct/Keyword</b>                     | ○/○/—   | ○/○/—   | ○/○/—  |   |
|  | <b>Index</b>   | ○   | —   | ○  |   |
| <b>Communication</b>                   | <b>Unit to Unit</b>                                  | —   | —   | CE-260L <sup>*8</sup>  |   |
|  | <b>PC Link</b>                                       | Included<br>(Microsoft® Outlook®<br>synchronise capability)                       | Included<br>(Microsoft® Outlook®<br>synchronise capability)   | Included PC-Link Kit<br>(for simple backup)  | Included PC-Link Kit<br>(for simple backup)   |
| <b>Power Source</b>                    | <b>Main (Approx. Life)</b>                           | LR03 (AAA) x 1<br>(120 hrs. <sup>*9</sup> , 60 hrs. <sup>*9</sup> ) <sup>*5</sup> | CR2032 x 2<br>(1,800 hrs. <sup>*9</sup> , 1,200 hrs. <sup>*9</sup> , 6 mos. <sup>*9</sup> ) <sup>*5</sup> | CR2032 x 2<br>(170 hrs. <sup>*9</sup> , 120 hrs. <sup>*9</sup> , 30 hrs. <sup>*9</sup> ) <sup>*5</sup> | CR2032 x 2<br>(1,200 hrs. <sup>*9</sup> , 300 hrs. <sup>*9</sup> , 270 hrs. <sup>*9</sup> ) <sup>*5</sup> |
|  | <b>Backup (Approx. Life)</b>                         | Flash memory  | Flash memory  | Flash memory   | CR2032 x 1 (5 yrs.) <sup>*9</sup>   |
|  | <b>Backlight</b>                                     | Uses main battery   | Uses main battery   | Uses main battery  | Uses main battery   |
| <b>Dimensions (Closed) (W x D x H)</b> | 70.8 x 118 x 13.5 mm<br>2-25/32" x 4-21/32" x 17/32" | 71.6 x 112.5 x 16.9 mm<br>2-13/16" x 4-7/16" x 21/32"                             | 154 x 92.5 x 13 mm<br>6-1/16" x 3-21/32" x 1/2"   | 148 x 92 x 13 mm<br>5-13/16" x 3-5/8" x 1/2"   |   |
| <b>Weight (Approx.)</b>                | 115 g  | 105 g   | 125 g   | 125 g  |   |

| Model                                  | ZQ-P20H   | EL-6990P  | ZQ-P10   | EL-6910  | EL-6053S   |
|--|---|---|--|--|--|
| <b>Display</b>                         | 12-column x 3-line  | 14-column x 5-line  | 12-column x 3-line   | 12-column x 1-line + 12-digit x 2-line           | 12-column x 1-line + 12-digit x 2-line           |
| <b>Backlight</b>                       | ○   | ○   | —  | —  | —  |
| <b>Memory Capacity</b>                 | 1MB (Flash memory) <sup>*1</sup>                            | 256KB (Flash memory) <sup>*1</sup>  | 96KB equivalent <sup>*1,1</sup>  | 64KB   | 8KB  |
| <b>Max. Input Capacity</b>             | <b>Characters</b>   | Total 716   |  | 36 + 36 + 36 + 36 <sup>*10</sup>                 | 36 + 36 + 36 <sup>*10</sup>                      |
|  | <b>Numbers</b>  | 72 <sup>*10</sup>   |  | 72 <sup>*10</sup>                                | 72 <sup>*10</sup>                                |
| <b>Keyboard</b>                        | —   | QWERTY layout   | —  | QWERTY layout                                    | QWERTY layout                                    |
| <b>Lowercase Letters</b>               | ○ (Except Greek mode)                                       | ○   | ○ (Except Greek mode)  | ○  | ○  |
| <b>European Characters</b>             | ○   | —   | ○  | ○  | ○  |
| <b>Schedule with Alarm</b>             | ○   | ○   | ○  | ○  | ○  |
| <b>Calendar</b>                        | —   | 4-week  | —  | —  | —  |
| <b>Telephone Directory</b>             | 2-file  | 3-file  | 2-file   | 2-file   | 2-file   |
| <b>E-mail Address</b>                  | in Tel directory  | in Tel directory  | in Tel directory   | in Tel directory                                 | in Tel directory                                 |
| <b>Web Address (URL)</b>               | in Tel directory  | —   | in Tel directory   | in Tel directory                                 | —  |
| <b>Memo</b>                            | ○   | ○   | ○  | ○  | ○  |
| <b>Home Clock with Alarm</b>           | ○   | ○   | ○  | ○  | ○  |
| <b>World Clock</b>                     | 42-city   | 42-city   | 29-city  | 29-city  | 29-city  |
| <b>Calculation</b>                     | 10-digit  | 12-digit  | 10-digit   | 10-digit   | 10-digit   |
| <b>Currency/Unit Conversion</b>        | ○   | ○   | ○  | ○  | ○  |
| <b>Anniversary</b>                     | —   | ○   | —  | —  | —  |
| <b>Spell Checker</b>                   | ○<br>(Approx. 10,000 English words)                         | —   | —  | —  | —  |
| <b>English/Spanish Word Translator</b> | —   | Approx. 10,000 words each   | —  | Approx. 1,200 words each                         | —  |
| <b>Game</b>                            | ○   | ○   | ○  | ○  | ○  |
| <b>Secret</b>                          | ○ <sup>*2</sup>   | ○ <sup>*2</sup>   | ○ <sup>*2</sup>  | ○ <sup>*2</sup>                                  | ○ <sup>*2</sup>                                  |
| <b>Diet Function</b>                   | ○ <sup>*7</sup>   | —   | —  | —  | —  |
| <b>PC Link</b>                         | Included<br>(Microsoft® Outlook®<br>synchronise capability) | Included PC-Link Kit<br>(for simple backup)   | —  | —  | —  |
| <b>Power Source</b>                    | <b>Main (Approx. Life)</b>                                  | CR2032 x 2<br>(5,000 hrs. <sup>*9</sup> , 2,000 hrs. <sup>*9</sup> , 6 mos. <sup>*9</sup> ) <sup>*5</sup> | CR2032 x 1<br>(1,200 hrs. <sup>*9</sup> , 800 hrs. <sup>*9</sup> ) <sup>*5</sup> | CR2032 x 1 (2 yrs. <sup>*9</sup> ) <sup>*5</sup> | CR2032 x 1 (2 yrs. <sup>*9</sup> ) <sup>*5</sup> |
|  | <b>Backup</b>   | Flash memory  | Flash memory   | —  | —  |
|  | <b>Backlight (Approx. Life)</b>                             | Uses main battery   | CR2032 x 1 (4,000 times <sup>*9</sup> ) <sup>*5</sup>                            | —  | —  |
| <b>Dimensions (Closed) (W x D x H)</b> | 69.8 x 109.3 x 16.3 mm<br>2-3/4" x 4-5/16" x 21/32"         | 143 x 88 x 13.3 mm<br>5-5/8" x 3-15/32" x 17/32"  | 64 x 97 x 14.8 mm<br>2-17/32" x 3-13/16" x 19/32"                                | 143 x 88 x 13.3 mm<br>5-5/8" x 3-15/32" x 17/32" | 128 x 86.6 x 12.7 mm<br>5-1/16" x 3-3/8" x 1/2"  |
| <b>Weight (Approx.)</b>                | 104 g   | 111 g   | 72 g   | 105 g  | 87 g   |

Certain functions will require a PC, optional PC software, add-on software, a cellular phone, a printer, and/or a wireless interface as demanded. Some services listed may not be available in some regions due to existing restrictions.

\*1 ZQ-590A: 8MB (User area: approx. 8,000KB for data storage)

ZQ-290H: 1.5MB equivalent (User area: approx. 896KB for data storage)

ZQ-270P: 256KB (User area: approx. 235KB for data storage)

ZQ-P20H: 1MB (User area: approx. 896KB for data storage)

EL-6990P: 256KB (User area: approx. 250KB for data storage)

\*2 Functions differ in each model.

\*3 File attachments cannot be downloaded. Text viewer only.

\*4 Downloadable from included CD-ROM.

\*5 At an ambient temperature of 25°C (77°F). Actual battery life may vary depending on usage.

\*6 When data is continuously displayed without backlight.

\*7 When data is searched for 5 minutes and displayed for 55 minutes per hourly use, and backlight is on for 2 minutes per hourly use.

\*8 When data is continuously displayed without backlight, with pedometer off.

\*9 When data is searched for 5 minutes and displayed for 55 minutes per hourly use, with pedometer off.

\*e While pedometer is on, with 5 minutes of data search, 55 minutes of data display, and 10,000 steps counts per day.

\*f When data is continuously displayed and backlight is on for 2 minutes per hourly use.

\*g When data is searched for 5 minutes, displayed for 55 minutes and backlight is on for 2 minutes per hourly use.

\*h When data is displayed for 30 minutes, alarm on for 20 seconds and key touch tone turned on/off 100 times per day.

\*i When backlight is on for 10 seconds and off for 20 seconds.

\*6 Memory at 1.5MB equivalent. Approx. 7,000 telephone names & numbers can be stored by using compression technology at a compression rate of approx. 1.5:1. (Names & numbers — including home, office, fax, and mobile — are 14 characters per entry, and addresses are 38 characters per entry.)

\*7 The Diet function features a built-in pedometer. It also enables calculation of the calories, carbohydrates and other nutritional data for 800 different foods (200 foods for the ZQ-P20H, with no other nutritional data). Databases are downloadable from the included CD-ROM.

\*8 May not be available in some regions as stocks are very limited.

\*9 If operating batteries are replaced promptly when exhausted.

\*10 Telephone directory mode.

\*11 Memory at 96KB Equivalent. Approx. 1,500 telephone names & numbers (name, telephone and fax number are

14 characters per entry) can be stored by using compression technology. (Compression Rate Approx. 1.5:1)

# SCIENTIFIC CALCULATORS

## SPECIFICATIONS (GRAPHING)

| Model  |  | EL-9900                                       |                 |
|--|--|---|-----------------|
| Display  |  | 22 x 8 (132 x 64 dot)                         |                 |
| Calculation Results (Mantissa + Exponent)            |  | 10 + 2  |                 |
| Memory   |  | 27  |                 |
| Functions  |  | 827   |                 |
| Max. Pending Operation (Calculations/Numeric Values) |  | 32/14   |                 |
| Equation Editor                                      |  | ○   |                 |
| Playback   |  | ○   |                 |
| Functions  | FSE Display  | ○   |                 |
|  | Last Digit Correction  | ○   |                 |
|  | Last Entry Recall  | ○   |                 |
|  | Last Answer Recall   | ○   |                 |
|  | $\pi$ , +/-, EXP   | ○   |                 |
|  | $y^x$ , $\sqrt[y]{x}$ , $x^2$ , $\sqrt{x}$ , $x^{-1}$  | ○   |                 |
|  | ln, log, $e^x$ , $10^x$  | ○   |                 |
|  | sin, cos, tan, $\sin^{-1}$ , $\cos^{-1}$ , $\tan^{-1}$   | ○   |                 |
|  | sinh, cosh, tanh, $\sinh^{-1}$ , $\cosh^{-1}$ , $\tanh^{-1}$                                   | ○   |                 |
|  | sec, csc, cot, $\sec^{-1}$ , $\csc^{-1}$ , $\cot^{-1}$   | ○   |                 |
|  | n!, nPr, nCr   | ○   |                 |
|  | Random   | ○   |                 |
|  | Fraction Calculations  | ○   |                 |
|  | Manual Reduction   | ○   |                 |
|  | Fraction/Decimal Conversion  | ○   |                 |
|  | $\rightarrow r\theta$ , $\rightarrow xy$ , $\rightarrow \text{DEG}$ , $\rightarrow \text{DMS}$ | ○   |                 |
|  | Deg, Rad, Grad Modes   | ○   |                 |
|  | Integer Division   | ○   |                 |
|  | Complex Number Calculation   | ○   |                 |
|  | Numerical Derivative   | ○   |                 |
|  | Numerical Integral   | ○   |                 |
|  | Matrix Calculation   | ○   |                 |
|  | Simultaneous Equation  | 2-6VLE <sup>†1</sup>                          |                 |
|  | Solver   | ○   |                 |
|  | Financial Calculation  | ○   |                 |
| List/List Grouping                                   | ○  |   |                 |
| $\Sigma$ Calculation                                 | ○  |   |                 |
| Polynomial Equation                                  | ○  |   |                 |
| BIN/OCT/HEX Cal                                      | Bin/Oct/Hex Modes  | ○   |                 |
|  | Logical Operation  | ○   |                 |
| Statistics   | Variable Statistics  | 1/2   |                 |
|  | Regression Models  | 14  |                 |
|  | Scatter Plots and Histograms   | ○   |                 |
|  | Box and Whisker Diagrams   | ○   |                 |
|  | Inferential Statistics   | ○   |                 |
| Probability Distribution                             | ○  |   |                 |
| Programming  | Programming Type   | Command                                       |                 |
|  | Max. Programmes  | 99  |                 |
|  | Total Memory Size  | 64KB  |                 |
|  | Programme Titles   | ○   |                 |
| Subroutines, Branch                                  | ○  |   |                 |
| Graphing   | Standard Features  | Function Graphing                             | up to 10        |
|  |  | Parametric Graphing                           | up to 6         |
|  |  | Polar Graphing/Sequence Graphing              | up to 6/up to 3 |
|  | Features Unique to SHARP   | Split Screen (Graph-Table/Graph-Equation)     | ○               |
|  |  | Zoom, Trace, Graph Style                      | ○               |
|  |  | Table of Function Values                      | ○               |
|  |  | Slide Show                                    | Original        |
|  | Multiple   | ○   |                 |
| Reversible Keyboard                                  | ○  |   |                 |
| Ports  |  | Unit/PC <sup>†2</sup>                         |                 |
| Optional   | PC Link  | CE-LK2  |                 |
|  | Unit to Unit   | CE-451L                                       |                 |
|  | OHP System   | EL-99T  |                 |
|  | Data Collection System   | ○ <sup>†3</sup>                               |                 |
| Power Source (Approx. Life)                          |  | R03 (AAA) x 4 (150 hrs.) <sup>†4</sup>        |                 |
| Memory Backup  |  | CR2032 x 1                                    |                 |
| Dimensions (W x D x H)                               |  | 86 x 183 x 23 mm<br>3-3/8" x 7-7/32" x 29/32" |                 |
| Weight (Approx.)                                     |  | 240 g   |                 |

## SPECIFICATIONS (STANDARD)

| Model   | EL-506W(BK/WH)                                      | EL-520W(BK/WH)                                      | EL-531WH(BK/BL/WH)                                  | EL-509W(BK/WH)                                      | EL-510R   | EL-501W(BK/WH)                                      |
|---|---|---|---|---|---|---|
| <b>Display</b>  |   |   |   |   |   |   |
| Dot Matrix (Digit x Line)   | 12 x 1  | 12 x 1  | 12 x 1  | 12 x 1  | 11 x 1  | —   |
| Segment (Mantissa + Exponent)   | 10 + 2  | 10 + 2  | 10 + 2  | 10 + 2  | —   | 8 + 2   |
| 3-Digit Punctuation   | ○   | ○   | ○   | ○   | —   | —   |
| <b>Memory</b>   | 9   | 9   | 9   | 9   | 3   | 1   |
| <b>Functions</b>  | 469   | 419   | 272   | 272   | 160   | 131   |
| FSE Display   | ○   | ○   | ○   | ○   | ○   | ○ (E only)  |
| Last Digit Correction   | ○   | ○   | ○   | ○   | ○   | ○   |
| Last Answer Recall  | ○   | ○   | ○   | ○   | ○   | —   |
| $\pi$ , +/-, EXP  | ○   | ○   | ○   | ○   | ○   | ○   |
| $y^x$ , $x/y$ , $x^2$ , $\sqrt{\quad}$ , $x^{-1}$ , $\sqrt[3]{\quad}$ | ○   | ○   | ○   | ○   | ○   | ○   |
| $x^3$   | ○   | ○   | ○   | ○   | —   | —   |
| In, log, $e^x$ , $10^x$   | ○   | ○   | ○   | ○   | ○   | ○   |
| sin, cos, tan, $\sin^{-1}$ , $\cos^{-1}$ , $\tan^{-1}$                | ○   | ○   | ○   | ○   | ○   | ○   |
| sinh, cosh, tanh, $\sinh^{-1}$ , $\cosh^{-1}$ , $\tanh^{-1}$          | ○   | ○   | ○   | ○   | ○   | ○   |
| n!, nPr, nCr  | ○   | ○   | ○   | ○   | ○   | ○ (n! only)   |
| Random  | ○   | ○   | ○   | ○   | ○   | ○   |
| Random Dice   | ○   | ○   | ○   | ○   | —   | —   |
| Random Coin   | ○   | ○   | ○   | ○   | —   | —   |
| Random Integer  | ○   | ○   | ○   | ○   | —   | —   |
| Fraction Calculations   | ○   | ○   | ○   | ○   | ○   | —   |
| → rθ, → xy, → DEG, → DMS  | ○   | ○   | ○   | ○   | ○   | ○   |
| Physical Constants  | 52  | 52  | —   | —   | —   | —   |
| Metric Conversions  | 44  | 44  | —   | —   | —   | —   |
| Deg, Rad, Grad Modes  | ○   | ○   | ○   | ○   | ○   | ○   |
| Complex Number Calculation  | ○   | ○   | —   | —   | —   | ○   |
| 3-Var. Linear Equation  | ○   | ○   | —   | —   | —   | —   |
| Solving Cubic Equation  | ○   | ○   | —   | —   | —   | —   |
| Multi-Line Playback   | ○   | ○   | ○   | ○   | —   | —   |
| Playback  | ○   | ○   | ○   | ○   | ○   | —   |
| Constant Calculation  | ○   | ○   | ○   | ○   | ○   | ○   |
| Chain Calculation   | ○   | ○   | ○   | ○   | ○   | ○   |
| Numerical Derivative  | ○   | ○   | —   | —   | —   | —   |
| Numerical Integral  | ○   | ○   | —   | —   | —   | —   |
| Formula Memory  | ○   | ○   | —   | —   | —   | —   |
| Algebraic Substitution  | ○   | ○   | —   | —   | —   | —   |
| Matrix Calculation  | ○   | —   | —   | —   | —   | —   |
| Solver  | ○   | ○   | —   | —   | —   | —   |
| List Calculation  | ○   | —   | —   | —   | —   | —   |
| <b>Bin/Prn/Oct/Hex</b>  |   |   |   |   |   |   |
| Bin/Prn/Oct/Hex   | ○   | ○   | ○   | ○   | —   | ○ <sup>*6</sup>                                     |
| Logical Operation   | ○   | ○   | ○   | ○   | —   | —   |
| <b>Statistics</b>   |   |   |   |   |   |   |
| Variable Statistics   | 1/2   | 1/2   | 1/2   | 1/2   | 1   | 1   |
| Regression Models   | 6   | 6   | 6   | 6   | —   | —   |
| 2-Key Roll-Over   | ○   | ○   | ○   | ○   | —   | —   |
| <b>Power Source (Approx. Life)</b>                                    | Solar/LR44 x 2<br>(5,000 hrs.) <sup>*5</sup>        | Solar/LR44 x 2<br>(5,000 hrs.) <sup>*5</sup>        | R6 (AA) x 1<br>(17,000 hrs.) <sup>*5</sup>          | LR44 x 2<br>(5,000 hrs.) <sup>*5</sup>              | LR44 x 2<br>(2,500 hrs.) <sup>*5</sup>          | LR44 x 2<br>(3,000 hrs.) <sup>*5</sup>              |
| <b>Dimensions (W x D x H)</b>   | 79.6 x 154.5 x 13.2 mm<br>3-1/8" x 6-3/32" x 17/32" | 79.6 x 154.5 x 13.2 mm<br>3-1/8" x 6-3/32" x 17/32" | 79.6 x 154.5 x 18.2 mm<br>3-1/8" x 6-3/32" x 23/32" | 79.6 x 154.5 x 13.2 mm<br>3-1/8" x 6-3/32" x 17/32" | 71.5 x 124 x 9.5 mm<br>2-13/16" x 4-7/8" x 3/8" | 78.6 x 144 x 11.6 mm<br>3-3/32" x 5-21/32" x 15/32" |
| <b>Weight (Approx.)</b>   | 97 g  | 97 g  | 110 g   | 95 g  | 57 g  | 75 g  |

## SPECIFICATIONS (PROGRAMMABLE)

| Model  | EL-5120                                   |
|--|---|
| <b>Display</b>   |   |
| Dot Matrix Display (Digit x Line)                            | 14 x 3                                    |
| <b>Memory</b>  | 27  |
| <b>Functions</b>   | 242                                       |
| FSE Display  | ○   |
| Last Digit Correction  | ○   |
| Last Answer Recall   | ○   |
| $\pi$ , +/-, EXP   | ○   |
| $y^x$ , $x/y$ , $x^2$ , $\sqrt{\quad}$ , $x^{-1}$            | ○   |
| In, log, $e^x$ , $10^x$                                      | ○   |
| sin, cos, tan, $\sin^{-1}$ , $\cos^{-1}$ , $\tan^{-1}$       | ○   |
| sinh, cosh, tanh, $\sinh^{-1}$ , $\cosh^{-1}$ , $\tanh^{-1}$ | ○   |
| n!, nPr, nCr   | ○   |
| Random   | ○   |
| Fraction Calculations  | ○   |
| → rθ, → xy, → DEG, → DMS                                     | ○   |
| Deg, Rad, Grad Modes   | ○   |
| Numerical Integral   | ○   |
| Playback   | ○   |
| Solver   | ○   |
| <b>Bin/Prn/Oct/Hex</b>                                       |   |
| Bin/Oct/Hex Modes  | ○   |
| Logical Operation  | ○   |
| <b>Statistics</b>  |   |
| Variable Statistics  | 1/2                                       |
| Regression Models  | 1   |
| Max. Programmes  | 25  |
| Max. Steps   | 1,211                                     |
| Programme Titles   | ○   |
| Subroutines, Branch  | ○   |
| <b>Power Source (Approx. Life)</b>                           | CR2025 x 1<br>(1,100 hrs.) <sup>*4</sup>  |
| <b>Dimensions (W x D x H)</b>                                | 76 x 145 x 9.8 mm<br>3" x 5-23/32" x 3/8" |
| <b>Weight (Approx.)</b>                                      | 77 g                                      |

## SPECIFICATIONS (FINANCIAL)

| Model                              | EL-735  | EL-733A                                   |
|------------------------------------|---|---|
| <b>Display</b>                     |   |   |
| Dot Matrix (Digit x Line)          | 12 x 1  | —   |
| Segment                            | 10  | 10  |
| 3-Digit Punctuation                | ○   | ○   |
| <b>Memory</b>                      | 1   | 1   |
| Cost/Sell Margin                   | ○   | ○   |
| Compound Interest                  | ○   | ○   |
| Amortisation of Payment            | ○   | ○   |
| Bond Calculation                   | ○   | —   |
| 360-Day Calendar                   | ○   | —   |
| Non-Uniform Cash Flow              | ○   | ○   |
| Constant Calculation               | ○   | ○   |
| Chain Calculation                  | ○   | ○   |
| 2-Var. Statistics                  | ○   | ○   |
| Date Calculation                   | ○   | —   |
| Database                           | ○   | —   |
| Sign Change                        | ○   | ○   |
| Right Shift                        | ○   | ○   |
| <b>Power Source (Approx. Life)</b> | CR2016 x 1<br>(800 hrs.) <sup>*5</sup>          | LR44 x 2<br>(1,000 hrs.) <sup>*5</sup>    |
| <b>Dimensions (W x D x H)</b>      | 69 x 132 x 7.8 mm<br>2-23/32" x 5-3/16" x 5/16" | 76 x 143 x 8.5 mm<br>3" x 5-5/8" x 11/32" |
| <b>Weight (Approx.)</b>            | 69 g <sup>*7</sup>                              | 110 g <sup>*8</sup>                       |

\*1 VLE = Value Linear Equation.

\*2 CE-LK2 cable (sold separately) is required for hook-up to a PC.

CE-451L cable (sold separately) is required to connect calculators to one another.

\*3 Vernier® LabPro® or ImTech® DataLab® (each sold separately) and CE-LK2 are required.

\*4 When used continuously for 5 minutes and displayed for 55 minutes per hourly use with temperature of approx. 20°C (68°F). Actual battery life may vary depending on usage.

\*5 Continuous display. Actual battery life may vary depending on usage.

\*6 Bin/Oct/Hex only.

\*7 Excluding wallet.

\*8 Including wallet.



# PRINTING CALCULATORS

## SPECIFICATIONS (DESKTOP, SEMI-DESKTOP, HAND-HELD)

| Model                  | CS-4194HC  | EL-2630P II   | EL-2607P   | EL-1607P  | EL-2910R   | EL-2902C  | EL-2901RH  | EL-1801C   | EL-1750P   | EL-1611P   |
|------------------------|--|---|--|---|--|---|--|--|--|--|
| Display                | 14   | 12  | 12   | 12  | 12   | 12  | 12   | 12   | 12   | 12   |
| Backlight              | —  | —   | —  | —   | —  | ○   | —  | —  | —  | —  |
| Memory                 | 3 (GT)   | 2 (GT)  | 2 (GT)   | 2 (GT)  | 2 (GT)   | 2 (GT)  | 2 (GT)   | 1  | 1  | 1  |
| Decimal Setting        | F-6-4-3-2-1-0  | F-6-3-2-1-0   | F-6-3-2-1-0  | F-6-3-2-1-0   | F-6-3-2-1-0  | F-3-2-1-0-A   | F-6-3-2-1-0-A  | F-2-0-A  | F-3-2-1-0-A  | F-3-2-1-0-A                                      |
| Adding Mode            | ○  | ○   | ○  | ○   | ○  | ○   | ○  | ○  | ○  | ○  |
| Constant               | ○  | ○   | ○  | ○   | ○  | ○   | ○  | ○  | ○  | ○  |
| Triple Zero Key        | ○  | —   | —  | —   | —  | —   | —  | —  | —  | —  |
| Double Zero Key        | ○  | ○   | ○  | ○   | ○  | ○   | ○  | ○  | ○  | ○  |
| Round Up/Off/Down      | Up/Off/Down  | Up/Off/Down   | Up/Off/Down  | Up/Off/Down   | Up/Off/Down  | Off/Down  | Up/Off/Down  | Off/Down   | Up/Off/Down  | —  |
| Item Counter           | ○  | ○   | ○  | ○   | ○  | ○   | ○  | ○  | ○  | —  |
| Grand Total            | ○  | ○   | ○  | ○   | ○  | ○   | ○  | —  | —  | —  |
| Cost/Sell/Margin       | —  | —   | —  | —   | —  | —   | ○  | —  | —  | —  |
| +Tax/-Tax Calculation  | ○/○  | ○/○   | ○/○  | ○/○   | ○/○  | ○/○   | ○/○  | ○/○  | ○/○  | ○/○  |
| Mark Up                | —  | ○   | ○  | ○   | ○  | ○   | —  | ○  | ○  | —  |
| Conversion Function    | —  | ○   | —  | ○   | —  | —   | —  | —  | —  | —  |
| Average                | —  | ○   | ○  | —   | —  | —   | —  | —  | —  | —  |
| Printing Colour        | 2  | 2   | 2  | 2   | 2  | 2   | 2  | 2  | 2  | 1  |
| Printing Speed         | 4.3 Lines/Sec.   | 4.8 Lines/Sec.  | 4.3 Lines/Sec.                                     | 3.0 Lines/Sec.  | 3.0 Lines/Sec.   | 3.0 Lines/Sec.                                      | 2.1 Lines/Sec.   | 2.1 Lines/Sec.   | Approx. 1.6 Lines/Sec.                                 | 1.6 Lines/Sec.                                   |
| Power Source           | AC   | AC  | AC   | AC  | AC   | AC  | AC   | AA x 4/AC*   | AA x 4/AC*   | AA x 4/AC*                                       |
| Dimensions (W x D x H) | 250 x 345 x 78 mm<br>9-27/32" x 13-19/32"<br>x 3-1/16" | 228 x 336 x 78 mm<br>8-31/32" x 13-7/32"<br>x 3-1/16" | 222 x 327 x 78 mm<br>8-3/4" x 12-7/8"<br>x 3-1/16" | 220 x 303 x 71.5 mm<br>8-21/32" x 11-15/16"<br>x 2-27/32" | 221 x 305 x 72 mm<br>8-11/16" x 12-1/16"<br>x 2-27/32" | 200 x 251 x 62 mm<br>7-27/32" x 9-7/8"<br>x 2-7/16" | 193 x 256 x 62.5 mm<br>7-19/32" x 10-3/32"<br>x 2-15/32" | 170 x 231 x 57.5 mm<br>6-11/16" x 9-15/16"<br>x 2-1/4" | 150 x 215 x 50 mm<br>5-29/32" x 8-15/32"<br>x 1-31/32" | 96 x 191 x 40 mm<br>3-3/4" x 7-1/2"<br>x 1-9/16" |
| Weight (Approx.)       | 2,000 g  | 1,900 g   | 1,900 g  | 1,300 g   | 1,300 g  | 950 g   | 1,000 g  | 580 g  | 500 g  | 315 g  |

\* AC adapter (optional)

## OPTIONAL ACCESSORY CHART

| Model      | CS-4194HC | EL-2630P II | EL-2607P | EL-1607P                               | EL-2910R                               | EL-2902C                               | EL-2901RH | EL-1801C                               | EL-1750P | EL-1611P                |
|------------|-----------|-------------|----------|--|--|--|-----------|--|----------|-------------------------|
| Paper Roll | ★         | ★           | ★        | ★                                      | ★                                      | ★                                      | ★         | ★                                      | ★        | EA-7100P<br>(58 x ø25)★ |
| Ink Ribbon | ☆         | ☆           | ☆        | —                                      | —                                      | —                                      | —         | —                                      | —        | —                       |
| Ink Roller | —         | —           | —        | EA-781R-BK (black)<br>EA-781R-RD (red) | EA-781R-BK (black)<br>EA-781R-RD (red) | EA-781R-BK (black)<br>EA-781R-RD (red) | EA-772R   | EA-781R-BK (black)<br>EA-781R-RD (red) | EA-772R  | EA-732R                 |
| AC Adapter | —         | —           | —        | —                                      | —                                      | —                                      | —         | EA-28A                                 | EA-28A   | EA-28A                  |

★ Part code: DPAPR1004CSZZ – 5 rolls/pack, 58 (W) x 80 (ø) mm

☆ Part code: URBNT1007CCZZ – Ink ribbon (black/red)

# SUPER CHECK & CORRECT

## SPECIFICATIONS (SEMI-DESKTOP, NICE SIZE, MINI NICE SIZE)

| Model                 | EL-792C | EL-782C | EL-771C | Model                      | EL-792C   | EL-782C   | EL-771C  |
|-----------------------|---------|---------|---------|----------------------------|---|---|--|
| Display               | 12      | 12      | 10      | Grand Total                | ○   | —   | —  |
| 3-Digit Punctuation   | ○       | ○       | ○       | Last Answer Recall         | ○   | —   | —  |
| Memory                | 1 + GT  | 1       | 1       | Auto Power Off             | ○   | ○   | ○  |
| Line Counter          | ○       | ○       | ○       | Double Zero Key            | ○   | —   | —  |
| Storage Memory        | 102     | 102     | 102     | 2-Key Roll-Over            | ○   | ○   | ○  |
| Auto Replay           | ○       | ○       | ○       | Decimal Setting            | F-5-4-3-2-1-0-A                                   | F-3-2-1-0-A                                       | F-2-0  |
| Correct/Insert/Delete | ○/○/○   | ○/○/○   | ○/—/—   | Round Up/Off/Down          | Up/Off/Down                                       | Off/Down  | —  |
| Repeat Entry          | ○       | ○       | ○       | Right Shift                | ○   | ○   | ○  |
| Change Calculation    | ○       | ○       | ○       | Tilt Display/Slant Display | ○/—   | ○/—   | —/○  |
| Answer Check          | ○       | ○       | ○       | Power Source               | Solar/CR2032 x 1                                  | Solar/CR2032 x 1                                  | Solar/CR2032 x 1                                       |
| +Tax/-Tax Calculation | ○/○     | ○/○     | ○/○     | Dimensions (W x D x H)     | 130 x 209 x 21 mm<br>5-1/8" x 8-7/32"<br>x 13/16" | 106 x 177 x 19 mm<br>4-3/16" x 6-31/32"<br>x 3/4" | 115 x 144 x 39 mm<br>4-17/32" x 5-21/32"<br>x 1-17/32" |
| Percent               | ○       | ○       | ○       | Weight (Approx.)           | 220 g   | 160 g   | 125 g  |
| Sign Change           | ○       | —       | ○       |                            |   |   |  |

# OFFICE CALCULATORS

## SPECIFICATIONS (DESKTOP/SEMI-DESKTOP, NICE SIZE, MINI NICE SIZE)

| Model                      | CS-2122H  | CS-2130   | EL-6138   | EL-2135   | EL-2125C   | EL-2128R  | EL-2139S   |
|----------------------------|---|---|---|---|--|---|--|
| Display                    | 12  | 12  | 16  | 12  | 12   | 12  | 12   |
| 3-Digit Punctuation        | ○   | ○   | ○   | ○   | ○  | ○   | ○  |
| Memory                     | 1 + GT  | 1 + GT  | 1 + GT  | 1 + GT  | 1 + GT   | 1 + GT  | 1  |
| Resume Function            | —   | —   | —   | —   | ○  | ○   | —  |
| Line Counter               | —   | —   | —   | —   | —  | ○   | —  |
| Answer Check               | —   | —   | —   | —   | ○ <sup>*1</sup>  | ○   | ○ <sup>*1</sup>                                    |
| +Tax/-Tax Calculation      | -/-   | -/-   | -/-   | -/-   | ○/○  | ○/-   | ○/○  |
| Day/Date Calculation       | —   | —   | —   | —   | —  | ○   | —  |
| Conversion Function        | —   | —   | —   | —   | 3-rate   | —   | —  |
| Root                       | ○   | ○   | ○   | ○   | —  | —   | ○  |
| Percent                    | ○   | ○   | ○   | ○   | ○  | ○   | ○  |
| Sign Change                | ○   | ○   | ○   | ○   | ○  | ○   | ○  |
| Mark Up                    | ○   | ○   | —   | ○   | —  | ○   | —  |
| Grand Total                | ○   | ○   | ○   | ○   | ○ <sup>*2</sup>  | ○   | ○ <sup>*2</sup>                                    |
| Constant                   | ○   | ○   | ○   | ○   | ○  | ○   | ○  |
| Time Calculation           | ○   | —   | —   | —   | —  | —   | —  |
| Auto Power Off             | —   | ○   | —   | ○   | ○  | ○   | ○  |
| Double Zero Key            | ○   | ○   | —   | ○   | ○  | ○   | ○  |
| Triple Zero Key            | ○   | —   | ○   | —   | —  | —   | —  |
| 2-Key Roll-Over            | ○   | ○   | ○   | ○   | ○  | ○   | ○  |
| Decimal Setting            | F-6-3-2-1-0-A   | F-3-2-0-A   | F-3-2-0-A   | F-3-2-0-A   | F-5-4-3-2-1-0-A  | F-3-2-1-0-A                                       | F-5-4-3-2-1-0-A                                    |
| Round Up/Off/Down          | Up/Off/Down   | Up/Off/Down                                       | Off/Down  | Off/Down  | Off/Down   | Up/Off/Down                                       | Up/Off/Down  |
| Right Shift                | ○   | ○   | ○   | ○   | ○  | ○   | ○  |
| Kick Stand                 | —   | ○   | —   | —   | —  | ○ (Double)  | ○  |
| Tilt Display/Slant Display | -/○   | -/-   | -/○   | -/○   | ○/-  | -/-   | -/-  |
| Power Source               | AC  | Solar/CR2032 x 1                                  | Solar/CR2032 x 1                                      | Solar/CR2032 x 1                                      | Solar/LR44 x 1   | Solar/LR44 x 1                                    | Solar/LR44 x 1                                     |
| Dimensions (W x D x H)     | 210 x 220 x 74 mm<br>8-9/32" x 8-21/32"<br>x 2-29/32" | 185 x 175 x 18 mm<br>7-9/32" x 6-7/8"<br>x 23/32" | 190 x 154 x 42 mm<br>7-15/32" x 6-1/16"<br>x 1-21/32" | 190 x 154 x 42 mm<br>7-15/32" x 6-1/16"<br>x 1-21/32" | 140 x 195 x 22.5 mm<br>5-19/32" x 7-21/32"<br>x 29/32" | 128 x 177 x 19 mm<br>5-1/32" x 6-31/32"<br>x 3/4" | 140 x 195 x 22 mm<br>5-19/32" x 7-21/32"<br>x 7/8" |
| Weight (Approx.)           | 850 g   | 290 g   | 330 g   | 330 g   | 215 g  | 205 g   | 235 g  |

| Model                      | EL-338F  | EL-387R   | EL-337C   | EL-339S   | EL-421M  | EL-334F  | EL-332A  |
|----------------------------|--|---|---|---|--|--|--|
| Display                    | 12   | 12  | 12  | 12  | 14   | 10   | 10   |
| 3-Digit Punctuation        | ○  | ○   | ○   | ○   | ○  | ○  | ○  |
| Memory                     | 1 + GT   | 1 + GT  | 1 + GT  | 1   | 1  | 1 + GT   | 1  |
| Resume Function            | —  | ○   | ○   | —   | —  | —  | —  |
| Line Counter               | —  | ○   | —   | —   | —  | —  | —  |
| Answer Check               | —  | ○   | ○ <sup>*1</sup>                                 | ○ <sup>*1</sup>   | —  | —  | —  |
| Cost/Sell/Margin           | ○  | —   | —   | —   | —  | —  | —  |
| +Tax/-Tax Calculation      | -/-  | ○/-   | ○/○   | ○/○   | ○/○  | ○/○  | ○/○  |
| Day/Date Calculation       | —  | ○   | —   | —   | —  | —  | —  |
| Conversion Function        | —  | —   | 3-rate  | —   | —  | —  | —  |
| Root                       | ○  | —   | —   | ○   | —  | —  | —  |
| Percent                    | ○  | ○   | ○   | ○   | ○  | ○  | ○  |
| Sign Change                | ○  | ○   | ○   | ○   | ○  | ○  | ○  |
| Mark Up                    | —  | ○   | —   | —   | —  | —  | —  |
| Grand Total                | ○  | ○   | ○ <sup>*2</sup>                                 | ○ <sup>*2</sup>   | —  | ○  | —  |
| Constant                   | ○  | ○   | ○   | ○   | ○  | ○  | ○  |
| Auto Power Off             | ○  | ○   | ○   | ○   | ○  | ○  | ○  |
| Double Zero Key            | ○  | ○   | ○   | ○   | ○  | ○  | ○  |
| 2-Key Roll-Over            | ○  | ○   | ○   | ○   | ○  | ○  | ○  |
| Decimal Setting            | F-3-2-0-A  | F-3-2-1-0-A                                       | F-3-2-0-A                                       | F-3-2-1-0-A   | —  | —  | —  |
| Round Up/Off/Down          | Off/Down   | Off/Down  | Off/Down  | Off/Down  | —  | —  | —  |
| Right Shift                | ○  | ○   | —   | ○   | ○  | ○  | —  |
| Kick Stand                 | ○  | ○   | —   | ○   | ○  | ○  | —  |
| Tilt Display/Slant Display | -/-  | -/-   | ○/-   | -/-   | -/-  | -/-  | -/○  |
| Power Source               | Solar/LR44 x 1                                     | Solar/LR44 x 1                                    | Solar/LR44 x 1                                  | Solar/LR44 x 1  | Solar/LR44 x 1                                     | Solar/LR44 x 1                                     | Solar/LR44 x 1   |
| Dimensions (W x D x H)     | 133 x 200 x 18 mm<br>5-1/4" x 7-27/32"<br>x 23/32" | 107 x 169 x 19 mm<br>4-7/32" x 6-21/32"<br>x 3/4" | 108 x 175 x 22 mm<br>4-7/32" x 6-7/8"<br>x 7/8" | 108.6 x 176 x 18.4 mm<br>4-9/32" x 6-15/16"<br>x 23/32" | 108 x 170 x 15 mm<br>4-1/4" x 6-11/16"<br>x 19/32" | 108 x 170 x 15 mm<br>4-1/4" x 6-11/16"<br>x 19/32" | 101 x 142 x 34 mm<br>3-31/32" x 5-19/32"<br>x 1-11/32" |
| Weight (Approx.)           | 230 g  | 158 g   | 165 g   | 165 g   | 160 g  | 160 g  | 115 g  |

\*1 Includes "Round Off" mode. \*2 Includes "Round Off/Down" modes.

# OFFICE CALCULATORS

## SPECIFICATIONS (DESKTOP/SEMI-DESKTOP, NICE SIZE, MINI NICE SIZE)

| Model                      | EL-331A, EL-330A                                    | EL-310A  | EL-M711G  | EL-M710G  | EL-M700G   |
|----------------------------|---|--|---|---|--|
| Display                    | 10 (EL-331A),<br>8 (EL-330A)                        | 8  | 10  | 8   | 8  |
| 3-Digit Punctuation        | ○   | —  | ○   | ○   | ○  |
| Memory                     | 1   | 1  | 1   | 1   | 1  |
| +Tax/-Tax Calculation      | ○/○   | -/-  | ○/○   | ○/○   | ○/○  |
| Conversion Function        | —   | —  | ○   | ○   | —  |
| Root                       | —   | ○  | —   | —   | —  |
| Percent                    | ○   | ○  | ○   | ○   | ○  |
| Sign Change                | ○   | ○  | ○   | ○   | —  |
| Constant                   | ○   | ○  | ○   | ○   | ○  |
| Auto Power Off             | ○   | ○  | ○   | ○   | ○  |
| Double Zero Key            | —   | —  | ○   | ○   | —  |
| 2-Key Roll-Over            | ○   | —  | ○   | ○   | ○  |
| Decimal Setting            | — (EL-331A),<br>F-2.0 (EL-330A)                     | —  | —   | —   | —  |
| Tilt Display/Slant Display | ○/—   | -/○  | -/○   | -/○   | -/○  |
| Power Source               | Solar/LR44 x 1                                      | Solar/LR1130 x 1                                   | Solar/LR44 x 1  | Solar/LR44 x 1  | Solar/LR44 x 1   |
| Dimensions (W x D x H)     | 102 x 148 x 15 mm<br>4-1/32" x 5-13/16"<br>x 19/32" | 87 x 116 x 20 mm<br>3-13/32" x 4-9/16"<br>x 25/32" | 100 x 151.5 x 33 mm<br>3-15/16" x 5-31/32"<br>x 1-5/16" | 100 x 151.5 x 33 mm<br>3-15/16" x 5-31/32"<br>x 1-5/16" | 87 x 116.5 x 28.5 mm<br>3-7/16" x 4-19/32"<br>x 1-1/8" |
| Weight (Approx.)           | 125 g   | 76 g   | 130 g   | 130 g   | 85 g   |

# 12/14 DIGIT CALCULATORS

## SPECIFICATIONS (NICE SIZE, MINI NICE SIZE, HAND-HELD/HARD COVER)

| Model                      | EL-145A  | EL-125A  | EL-144A   | EL-124A   | EL-143S   | EL-123S   |
|----------------------------|--|--|---|---|---|---|
| Display                    | 14   | 12   | 14  | 12  | 14  | 12  |
| 3-Digit Punctuation        | ○  | ○  | ○   | ○   | ○   | ○   |
| Memory                     | 1  | 1  | 1   | 1   | 1   | 1   |
| +Tax/-Tax Calculation      | ○/○  | ○/○  | ○/○   | ○/○   | -/-   | -/-   |
| Root                       | —  | —  | —   | —   | ○   | ○   |
| Percent                    | ○  | ○  | ○   | ○   | ○   | ○   |
| Sign Change                | ○  | ○  | —   | —   | —   | —   |
| Constant                   | ○  | ○  | ○   | ○   | ○   | ○   |
| Auto Power Off             | ○  | ○  | ○   | ○   | ○   | ○   |
| Double Zero Key            | ○  | ○  | ○   | ○   | ○   | ○   |
| 2-Key Roll-Over            | ○  | ○  | ○   | ○   | ○   | ○   |
| Right Shift                | ○  | ○  | ○   | ○   | ○   | ○   |
| Tilt Display/Slant Display | ○/—  | ○/—  | ○/—   | ○/—   | -/-   | -/-   |
| Hard Cover                 | —  | —  | —   | —   | ○   | ○   |
| Power Source               | Solar/LR44 x 1                                     | Solar/LR44 x 1                                     | Solar/LR44 x 1                                      | Solar/LR44 x 1                                      | Solar/LR1130 x 1                                    | Solar/LR1130 x 1                                    |
| Dimensions (W x D x H)     | 110 x 168 x 15 mm<br>4-11/32" x 6-5/8"<br>x 19/32" | 110 x 168 x 15 mm<br>4-11/32" x 6-5/8"<br>x 19/32" | 102 x 148 x 15 mm<br>4-1/32" x 5-13/16"<br>x 19/32" | 102 x 148 x 15 mm<br>4-1/32" x 5-13/16"<br>x 19/32" | 72 x 115 x 12 mm<br>2-27/32" x 4-17/32"<br>x 15/32" | 72 x 115 x 12 mm<br>2-27/32" x 4-17/32"<br>x 15/32" |
| Weight (Approx.)           | 160 g  | 160 g  | 125 g   | 125 g   | 66 g  | 66 g  |



# PERSONAL CALCULATORS

## SPECIFICATIONS (WALLET/HAND-HELD, HARD COVER, CARD)

| Model                       | EL-480S   | EL-344G   | EL-W211G  | EL-327S  | EL-326S  | EL-379S   | EL-377S   | EL-371S  |
|-----------------------------|---|---|---|--|--|---|---|--|
| Display                     | 10  | 8   | 10  | 10   | 8  | 12  | 10  | 8  |
| 3-Digit Punctuation         | ○   | ○   | ○   | ○  | ○  | ○   | ○   | ○  |
| Memory                      | 1   | 1   | 1   | 1  | 1  | 1   | 1   | 1  |
| Root                        | ○   | ○   | —   | —  | —  | ○   | ○   | —  |
| Percent                     | ○   | ○   | ○   | ○  | ○  | ○   | ○   | ○  |
| Mark Up                     | ○   | —   | —   | —  | —  | —   | —   | —  |
| Sign Change                 | ○   | ○   | —   | —  | —  | —   | ○   | —  |
| Constant                    | ○   | ○   | ○   | ○  | ○  | ○   | ○   | ○  |
| Metric Conversion           | —   | ○   | —   | —  | —  | —   | —   | —  |
| Cost/Sell/Margin            | ○   | —   | —   | —  | —  | —   | —   | —  |
| Decimal Setting             | —   | —   | —   | F-2-0  | F-2-0  | —   | —   | —  |
| +Tax/-Tax Calculation       | -/-   | -/-   | ○/○   | ○/○  | ○/○  | -/-   | -/-   | ○/○  |
| 2-Key Roll-Over             | —   | —   | ○   | ○  | ○  | ○   | ○   | ○  |
| Auto Power Off              | ○   | —   | ○   | ○  | ○  | ○   | ○   | ○  |
| Key Material                | Rubber  | Rubber  | Plastic   | Rubber   | Rubber   | Plastic   | Plastic   | Rubber   |
| Wallet Case                 | ○   | ○   | —   | ○  | ○  | —   | —   | ○  |
| Power Source (Approx. Life) | Solar/LR1130 x 1                                    | Solar 50 Lux                                      | Solar/CR2016 x 1                                  | Solar/LR1130 x 1                                   | Solar/LR1130 x 1                                   | Solar/LR1130 x 1                                | Solar/LR1130 x 1                                | Solar/LR1130 x 1                                 |
| Dimensions (W x D x H)      | 69 x 119 x 7.1 mm<br>2-23/32" x 4-11/16"<br>x 9/32" | 70 x 122 x 5.9 mm<br>2-3/4" x 4-13/16"<br>x 7/32" | 70 x 117 x 8.1 mm<br>2-3/4" x 4-19/32"<br>x 5/16" | 69 x 115 x 6.5 mm<br>2-23/32" x 4-17/32"<br>x 1/4" | 69 x 115 x 6.5 mm<br>2-23/32" x 4-17/32"<br>x 1/4" | 70 x 117 x 8 mm<br>2-3/4" x 4-19/32"<br>x 5/16" | 70 x 117 x 8 mm<br>2-3/4" x 4-19/32"<br>x 5/16" | 66 x 108 x 7 mm<br>2-19/32" x 4-7/32"<br>x 9/32" |
| Weight (Approx.)            | 65 g <sup>*1</sup>                                  | 80 g <sup>*1</sup>                                | 56 g  | 59 g <sup>*2</sup>                                 | 59 g <sup>*2</sup>                                 | 47 g  | 47 g  | 40 g   |

| Model                       | EL-W200G  | EL-250S  | EL-240SA   | EL-231L  | EL-233S  | EL-376S   | EL-243S   | EL-879M  |
|-----------------------------|---|--|--|--|--|---|---|--|
| Display                     | 8   | 8  | 8  | 8  | 8  | 8   | 8   | 8  |
| 3-Digit Punctuation         | ○   | ○  | ○  | —  | —  | —   | —   | ○  |
| Memory                      | 1   | 1  | 1  | 1  | 1  | 1   | 1   | 1  |
| Root                        | —   | —  | ○  | ○  | ○  | ○   | ○   | ○  |
| Percent                     | ○   | ○  | ○  | ○  | ○  | ○   | ○   | ○  |
| Sign Change                 | —   | —  | ○  | ○  | —  | ○   | ○   | ○  |
| Constant                    | ○   | ○  | ○  | ○  | ○  | ○   | ○   | ○  |
| Last Answer Recall          | —   | —  | ○  | —  | —  | —   | —   | —  |
| Decimal Setting             | —   | F-2-0  | F-2-0  | —  | —  | —   | —   | —  |
| +Tax/-Tax Calculation       | ○/○   | ○/○  | -/-  | -/-  | -/-  | -/-   | -/-   | -/-  |
| 2-Key Roll-Over             | ○   | —  | —  | —  | —  | —   | —   | —  |
| Auto Power Off              | ○   | ○  | ○  | ○  | ○  | ○   | ○   | ○  |
| Key Material                | Plastic   | Plastic  | Plastic  | Plastic  | Plastic  | Plastic   | Rubber  | Rubber   |
| Hard Cover                  | —   | —  | —  | —  | —  | ○   | ○   | —  |
| Wallet Case                 | —   | —  | —  | —  | —  | —   | —   | ○  |
| Power Source (Approx. Life) | Solar/CR2016 x 1                                | Solar/LR1130 x 1                                     | Solar/LR1130 x 1                                     | AA x 1 (17,500 hrs.) <sup>*3</sup>                     | LR1130 x 1 (1 yr.) <sup>*4</sup>                 | Solar/LR1130 x 1  | Solar/LR1130 x 1  | Solar/LR1130 x 1                                     |
| Dimensions (W x D x H)      | 60 x 105 x 8.1 mm<br>2-3/8" x 4-1/8"<br>x 5/16" | 71 x 116 x 16.5 mm<br>2-25/32" x 4-9/16"<br>x 21/32" | 71 x 116 x 16.5 mm<br>2-25/32" x 4-9/16"<br>x 21/32" | 69 x 115.5 x 20.5 mm<br>2-23/32" x 4-9/16"<br>x 13/16" | 60 x 103 x 8.3 mm<br>2-3/8" x 4-1/16"<br>x 5/16" | 72 x 115 x 12 mm <sup>*5</sup><br>2-13/16" x 4-17/32"<br>x 15/32" | 64 x 105 x 11 mm <sup>*5</sup><br>2-1/2" x 4-5/32"<br>x 7/16" | 99.6 x 67 x 7.3 mm<br>3-29/32" x 2-21/32"<br>x 9/32" |
| Weight (Approx.)            | 45 g  | 58 g   | 58 g   | 71 g   | 35 g   | 66 g  | 51 g  | 59 g <sup>*1</sup>                                   |

\*1 Including wallet. \*2 Excluding wallet. \*3 Continuous LCD display. Actual battery life may vary depending on usage.

\*4 When used for 1 hour per day. Actual battery life may vary depending on usage. \*5 When closed.

# MERCHANDISING INFORMATION

## BAR CODE LIST (EAN CODES)

### ELECTRONIC DICTIONARIES

**PW-E500** (Box)



**PW-E300** (Box)



**ZQ-590A** (Clamshell)



**ZQ-290H** (Clamshell)



**ZQ-270P** (Box + Strap)



**ZQ-190P** (Box + Strap)



### ELECTRONIC ORGANIZERS

**ZQ-P20H** (Clamshell)



**EL-6990P** (Clamshell)



**ZQ-P10** (Blister Pack)



**EL-6910** (Box + Strap)



**EL-6053S** (Box + Strap)



### SCIENTIFIC CALCULATORS

#### GRAPHING

**EL-9900** (Box + Strap)



#### STANDARD

**EL-506W** (BK) (Box + Strap)



**EL-506W** (WH) (Blister Pack)



**EL-520W** (BK) (Box + Strap)



**EL-520W** (WH) (Blister Pack)



**EL-531WH** (BK) (Box + Strap)



**EL-531WH** (BL) (Blister Pack)



**EL-531WH** (BK) (Blister Pack)



**EL-509W** (BK) (Box + Strap)



**EL-510R** (Box + Strap)



**EL-510R** (Blister Pack)



**EL-501W** (BK) (Box + Strap)



#### PROGRAMMABLE

**EL-5120** (Box + Strap)



#### FINANCIAL

**EL-735** (Box)



**EL-733A** (Box + Strap)



### PRINTING CALCULATORS

#### DESKTOP

**CS-4194HC** (Box)



**EL-2630P** II (Box)



**EL-2607P** (Box)



**EL-1607P** (Box)



**EL-2910R** (Box)



**EL-2902C** (Box)



#### SEMI-DESKTOP

**EL-2901RH** (Box)



**EL-1801C** (Box + Strap)



**EL-1750P** (Box + Strap)



#### HAND-HELD

**EL-1611P** (Box + Strap)



### SUPER CHECK & CORRECT

#### SEMI-DESKTOP

**EL-792C** (Box + Strap)



#### NICE SIZE

**EL-782C** (Box + Strap)



#### MINI NICE SIZE

**EL-771C** (Box + Strap)



### OFFICE CALCULATORS

#### DESKTOP/SEMI-DESKTOP

**CS-2122H** (Box)



**CS-2130** (Box)



**EL-6138** (Box + Strap)



**EL-2135** (Box)



**EL-2125C** (Box + Strap)



**EL-2125C** (Blister Pack)



**EL-2128R** (Box + Strap)



**EL-2139S** (Box + Strap)



**EL-2139S** (Blister Pack)



**EL-338F** (Box + Strap)



**EL-338F** (Blister Pack)



#### NICE SIZE

**EL-387R** (Box + Strap)



OFFICE CALCULATORS

|   |   |  |   |   |   |
|---|---|--|---|---|---|
| <b>EL-337C</b> (Box + Strap)<br><br>4 974019 022758   | <b>EL-337C</b> (Blister Pack)<br><br>4 974019 022741        | <b>EL-339S</b> (Box + Strap)<br><br>4 974019 023243  | <b>EL-339S</b> (Blister Pack)<br><br>4 974019 023250        | <b>EL-421M</b> (Box + Strap)<br><br>4 974019 023175   | <b>EL-334F</b> (Box + Strap)<br><br>4 974019 022734         |
| <b>MINI NICE SIZE</b>                                 |   |  |   |   |   |
| <b>EL-334F</b> (Blister Pack)<br><br>4 974019 022727  | <b>EL-332A</b> (Box + Strap)<br><br>4 974019 022796         | <b>EL-332A</b> (Blister Pack)<br><br>4 974019 022789 | <b>EL-331A</b> (Box + Strap)<br><br>4 974019 009452         | <b>EL-331A</b> (Blister Pack)<br><br>4 974019 009445  | <b>EL-330A</b> (Box + Strap)<br><br>4 974019 009476         |
| <b>EL-330A</b> (Blister Pack)<br><br>4 974019 009469  | <b>EL-310A</b> (Box + Strap)<br><br>4 974019 009490         | <b>EL-310A</b> (Blister Pack)<br><br>4 974019 009483 | <b>EL-M711G</b> (Window box + Strap)<br><br>4 974019 023755 | <b>EL-M711G</b> (Blister Pack)<br><br>4 974019 023762 | <b>EL-M710G</b> (Window box + Strap)<br><br>4 974019 023731 |
| <b>EL-M710G</b> (Blister Pack)<br><br>4 974019 023748 | <b>EL-M700G</b> (Window box + Strap)<br><br>4 974019 023717 |  |   |   |   |

12/14 DIGIT CALCULATORS

|   |   |   |   |   |   |
|---|---|---|---|---|---|
| <b>NICE SIZE</b>                                    |   | <b>MINI NICE SIZE</b>                               |   | <b>HAND-HELD/HARD COVER</b>                         |   |
| <b>EL-145A</b> (Box + Strap)<br><br>4 974019 024325 | <b>EL-125A</b> (Box + Strap)<br><br>4 974019 024226 | <b>EL-144A</b> (Box + Strap)<br><br>4 974019 024332 | <b>EL-124A</b> (Box + Strap)<br><br>4 974019 024233 | <b>EL-143S</b> (Box + Strap)<br><br>4 974019 024349 | <b>EL-123S</b> (Box + Strap)<br><br>4 974019 024240 |

PERSONAL CALCULATORS

|  |  |   |   |   |  |
|--|--|---|---|---|--|
| <b>WALLET/HAND-HELD</b>                              |  |   |   |   |  |
| <b>EL-480S</b> (Box + Strap)<br><br>4 974019 021881  | <b>EL-480S</b> (Blister Pack)<br><br>4 974019 021874 | <b>EL-344G</b> (Blister Pack)<br><br>4 974019 023298  | <b>EL-W211G</b> (Window box + Strap)<br><br>4 974019 023694 | <b>EL-W211G</b> (Blister Pack)<br><br>4 974019 023700 | <b>EL-327S</b> (Box + Strap)<br><br>4 974019 022277  |
| <b>EL-327S</b> (Blister Pack)<br><br>4 974019 022260 | <b>EL-326S</b> (Box + Strap)<br><br>4 974019 009513  | <b>EL-326S</b> (Blister Pack)<br><br>4 974019 009506  | <b>EL-379S</b> (Box + Strap)<br><br>4 974019 023182         | <b>EL-379S</b> (Blister Pack)<br><br>4 974019 023212  | <b>EL-377S</b> (Box + Strap)<br><br>4 974019 022888  |
| <b>EL-377S</b> (Blister Pack)<br><br>4 974019 022871 | <b>EL-371S</b> (Box + Strap)<br><br>4 974019 022819  | <b>EL-371S</b> (Blister Pack)<br><br>4 974019 022802  | <b>EL-W200G</b> (Window box + Strap)<br><br>4 974019 023670 | <b>EL-W200G</b> (Blister Pack)<br><br>4 974019 023687 | <b>EL-250S</b> (Box + Strap)<br><br>4 974019 022215  |
| <b>EL-250S</b> (Blister Pack)<br><br>4 974019 022208 | <b>EL-240SA</b> (Box + Strap)<br><br>4 974019 023557 | <b>EL-240SA</b> (Blister Pack)<br><br>4 974019 023366 | <b>EL-231L</b> (Box + Strap)<br><br>4 974019 021072         | <b>EL-233S</b> (Box + Strap)<br><br>4 974019 023014   | <b>EL-233S</b> (Blister Pack)<br><br>4 974019 023007 |
| <b>HARD COVER</b>                                    |  |   | <b>CARD</b>   |   |  |
| <b>EL-376S</b> (Box + Strap)<br><br>4 974019 009537  | <b>EL-376S</b> (Blister Pack)<br><br>4 974019 009520 | <b>EL-243S</b> (Box + Strap)<br><br>4 974019 009575   | <b>EL-243S</b> (Blister Pack)<br><br>4 974019 009568        | <b>EL-879M</b> (Box + Strap)<br><br>4 974019 023267   |  |



# MERCHANDISING INFORMATION

## PACKING LIST

Quantity/CTN may be different than shown, depending on location.

| MODEL   | INDIVIDUAL CARTON |                    |                 |       |        | INNER CARTON |                    |           | MASTER CARTON |                    |                 |       |        |          |
|---|-------------------|--------------------|-----------------|-------|--------|--------------|--------------------|-----------|---------------|--------------------|-----------------|-------|--------|----------|
|   | PACKAGE TYPE      | G/W (kg) (Approx.) | DIMENSIONS (mm) |       |        | Q'ty/CTN     | G/W (kg) (Approx.) | M3        | Q'ty/CTN      | G/W (kg) (Approx.) | DIMENSIONS (mm) |       |        | M3       |
|   |                   |                    | DEPTH           | WIDTH | HEIGHT |              |                    |           |               |                    | DEPTH           | WIDTH | HEIGHT |          |
| <b>ELECTRONIC DICTIONARIES</b>  |                   |                    |                 |       |        |              |                    |           |               |                    |                 |       |        |          |
| PW-E500   | Box               | 0.33               | 215             | 151   | 30     | 10           | 3.50               | 0.0110822 | 40            | 15.0               | 458             | 320   | 346    | 0.056398 |
| PW-E300   | Box               | 0.33               | 215             | 151   | 30     | 10           | 3.50               | 0.0110822 | 40            | 15.0               | 458             | 320   | 346    | 0.056398 |
| <b>ELECTRONIC ORGANIZERS</b>  |                   |                    |                 |       |        |              |                    |           |               |                    |                 |       |        |          |
| ZQ-590A   | Clamshell         | 0.33               | 260             | 190   | 42     | 10           | 3.50               | 0.013134  | 40            | 15.1               | 512             | 277   | 427    | 0.060559 |
| ZQ-290H   | Clamshell         | 0.33               | 260             | 190   | 52     | 10           | 3.60               | 0.023755  | 40            | 16.1               | 556             | 448   | 427    | 0.106361 |
| ZQ-270P   | Box + Strap       | 0.44               | 200+20          | 145   | 32     | 10           | 4.80               | 0.012099  | 40            | 21.3               | 448             | 351   | 372    | 0.058496 |
| ZQ-190P   | Box + Strap       | 0.35               | 222+20          | 147   | 32     | 10           | 3.70               | 0.012100  | 40            | 17.9               | 448             | 351   | 372    | 0.058496 |
| ZQ-P20H   | Clamshell         | 0.45               | 263             | 196   | 52     | 10           | 4.80               | 0.023755  | 40            | 20.9               | 556             | 448   | 427    | 0.106361 |
| EL-6990P  | Clamshell         | 0.35               | 249             | 182   | 36     | 10           | 3.90               | 0.024457  | 40            | 17.0               | 540             | 402   | 442    | 0.095949 |
| ZQ-P10  | Blister Pack      | 0.15               | 237             | 170   | 26     | 10           | 1.70               | 0.0125257 | 80            | 15.6               | 542             | 516   | 418    | 0.116903 |
| EL-6910   | Box + Strap       | 0.15               | 147+20          | 93    | 21     | 10           | 1.60               | 0.003932  | 80            | 13.7               | 476             | 336   | 250    | 0.039984 |
| EL-6053S  | Box + Strap       | 0.14               | 132+20          | 92    | 20     | 10           | 1.50               | 0.003398  | 80            | 12.2               | 456             | 308   | 248    | 0.034831 |
| <b>SCIENTIFIC CALCULATORS (GRAPHING, STANDARD, PROGRAMMABLE, FINANCIAL)</b> |                   |                    |                 |       |        |              |                    |           |               |                    |                 |       |        |          |
| EL-9900   | Box + Strap       | 0.67               | 216+35          | 152   | 49     | 5            | 3.60               | 0.010370  | 20            | 15.2               | 480             | 276   | 382    | 0.050607 |
| EL-506W   | Box + Strap       | 0.19               | 161             | 83    | 30     | 10           | 2.00               | 0.004958  | 80            | 16.8               | 363             | 335   | 382    | 0.046454 |
| EL-506W   | Blister Pack      | 0.18               | 245             | 148   | 29     | 10           | 2.10               | 0.0151013 | 80            | 18.6               | 753             | 522   | 356    | 0.139932 |
| EL-520W   | Box + Strap       | 0.19               | 161             | 83    | 30     | 10           | 2.00               | 0.004958  | 80            | 16.8               | 363             | 335   | 382    | 0.046454 |
| EL-520W   | Blister Pack      | 0.18               | 245             | 148   | 29     | 10           | 2.10               | 0.0151013 | 80            | 18.6               | 753             | 522   | 356    | 0.139932 |
| EL-531WH  | Box + Strap       | 0.19               | 161             | 83    | 32     | 10           | 2.10               | 0.005266  | 80            | 17.7               | 363             | 355   | 382    | 0.049227 |
| EL-531WH  | Blister Pack      | 0.20               | 245             | 148   | 32     | 10           | 2.30               | 0.0151013 | 80            | 20.3               | 753             | 522   | 356    | 0.139932 |
| EL-509W   | Box + Strap       | 0.14               | 161             | 83    | 30     | 10           | 1.80               | 0.004958  | 80            | 15.6               | 363             | 335   | 382    | 0.046454 |
| EL-510R   | Box + Strap       | 0.12               | 131+20          | 79    | 22     | 10           | 1.30               | 0.003039  | 80            | 14.4               | 302             | 264   | 382    | 0.030456 |
| EL-510R   | Blister Pack      | 0.13               | 230             | 148   | 20     | 10           | 1.50               | 0.008722  | 80            | 12.8               | 486             | 442   | 374    | 0.080340 |
| EL-501W   | Box + Strap       | 0.13               | 150             | 82    | 24     | 10           | 1.50               | 0.004224  | 80            | 12.0               | 526             | 350   | 234    | 0.043080 |
| EL-5120   | Box + Strap       | 0.22               | 187+20          | 119   | 26     | 10           | 2.30               | 0.007699  | 80            | 19.2               | 564             | 416   | 294    | 0.068980 |
| EL-735  | Box               | 0.26               | 185             | 107   | 27     | 10           | 2.80               | 0.007250  | 80            | 23.0               | 610             | 410   | 275    | 0.068778 |
| EL-733A   | Box + Strap       | 0.22               | 186+20          | 107   | 25     | 10           | 2.30               | 0.006462  | 80            | 19.0               | 519             | 409   | 280    | 0.059436 |
| <b>PRINTING CALCULATORS (DESKTOP, SEMI-DESKTOP, HAND-HELD)</b>              |                   |                    |                 |       |        |              |                    |           |               |                    |                 |       |        |          |
| CS-4194HC   | Box               | 2.46               | 425             | 293   | 115    | —            | —                  | —         | 6             | 16.3               | 610             | 446   | 388    | 0.105559 |
| EL-2630PII  | Box               | 2.57               | 438             | 265   | 136    | —            | —                  | —         | 6             | 17.0               | 548             | 456   | 433    | 0.108201 |
| EL-2607P  | Box               | 2.47               | 438             | 265   | 136    | —            | —                  | —         | 6             | 16.4               | 548             | 456   | 433    | 0.108201 |
| EL-1607P  | Box               | 1.86               | 434             | 264   | 132    | —            | —                  | —         | 6             | 12.7               | 546             | 452   | 433    | 0.106120 |
| EL-2910R  | Box               | 1.60               | 388             | 268   | 89     | —            | —                  | —         | 6             | 11.3               | 574             | 430   | 376    | 0.092804 |
| EL-2902C  | Box               | 1.20               | 367             | 257   | 114    | —            | —                  | —         | 6             | 8.4                | 532             | 385   | 376    | 0.077012 |
| EL-2901RH   | Box               | 1.36               | 362             | 228   | 110    | —            | —                  | —         | 6             | 9.3                | 476             | 384   | 367    | 0.067082 |
| EL-1801C  | Box + Strap       | 0.80               | 297+30          | 218   | 78     | —            | —                  | —         | 10            | 8.8                | 452             | 319   | 419    | 0.060415 |
| EL-1750P  | Box + Strap       | 0.80               | 290+30          | 188   | 73     | —            | —                  | —         | 10            | 8.9                | 398             | 314   | 409    | 0.051114 |
| EL-1611P  | Box + Strap       | 0.37               | 265+35          | 125   | 55     | —            | —                  | —         | 10            | 4.4                | 298             | 285   | 286    | 0.024290 |
| <b>SUPER CHECK &amp; CORRECT (SEMI-DESKTOP, NICE SIZE, MINI NICE SIZE)</b>  |                   |                    |                 |       |        |              |                    |           |               |                    |                 |       |        |          |
| EL-792C   | Box + Strap       | 0.27               | 241+20          | 135   | 33     | 10           | 2.90               | 0.012224  | 40            | 12.7               | 472             | 351   | 348    | 0.057654 |
| EL-782C   | Box + Strap       | 0.20               | 183+20          | 111   | 29     | 10           | 2.20               | 0.007913  | 40            | 9.5                | 412             | 320   | 300    | 0.039552 |
| EL-771C   | Box + Strap       | 0.17               | 151+20          | 119   | 35     | 10           | 1.85               | 0.008394  | 40            | 8.1                | 381             | 346   | 316    | 0.041657 |
| <b>OFFICE CALCULATORS (DESKTOP/SEMI-DESKTOP, NICE SIZE, MINI NICE SIZE)</b> |                   |                    |                 |       |        |              |                    |           |               |                    |                 |       |        |          |
| CS-2122H  | Box               | 1.50               | 330             | 268   | 118    | —            | —                  | —         | 6             | 9.8                | 552             | 371   | 356    | 0.072906 |
| CS-2130   | Box               | 0.45               | 210             | 181   | 32     | 10           | 4.70               | 0.015075  | 40            | 20.1               | 464             | 351   | 440    | 0.071660 |
| EL-6138   | Box + Strap       | 0.42               | 202             | 166   | 52     | 10           | 4.45               | 0.0209713 | 40            | 19.1               | 564             | 452   | 388    | 0.098912 |
| EL-2135   | Box               | 0.38               | 201             | 151   | 51     | 10           | 4.10               | 0.018133  | 40            | 17.7               | 544             | 436   | 380    | 0.090130 |
| EL-2125C  | Box + Strap       | 0.26               | 199+20          | 144   | 27     | 10           | 2.70               | 0.010018  | 40            | 11.7               | 446             | 300   | 366    | 0.048971 |
| EL-2125C  | Blister Pack      | 0.28               | 275             | 173   | 29     | 10           | 2.90               | 0.016901  | 40            | 12.5               | 592             | 315   | 424    | 0.079068 |
| EL-2128R  | Box + Strap       | 0.26               | 180+20          | 131   | 25     | 10           | 2.80               | 0.007887  | 40            | 12.0               | 410             | 281   | 340    | 0.039171 |
| EL-2139S  | Box + Strap       | 0.28               | 198             | 143   | 25     | 10           | 3.00               | 0.009104  | 40            | 12.8               | 448             | 286   | 350    | 0.044845 |
| EL-2139S  | Blister Pack      | 0.30               | 275             | 173   | 24     | 10           | 3.30               | 0.012984  | 40            | 14.1               | 482             | 305   | 424    | 0.062332 |
| EL-338F   | Box + Strap       | 0.29               | 204             | 136   | 27     | 10           | 3.10               | 0.0093934 | 40            | 13.2               | 450             | 306   | 336    | 0.046268 |
| EL-338F   | Blister Pack      | 0.30               | 275             | 173   | 25     | 10           | 3.20               | 0.0151106 | 40            | 14.1               | 558             | 305   | 424    | 0.072161 |
| EL-387R   | Box + Strap       | 0.20               | 172+20          | 111   | 24     | 10           | 2.10               | 0.005704  | 40            | 9.0                | 386             | 266   | 284    | 0.029160 |
| EL-337C   | Box + Strap       | 0.20               | 180+20          | 112   | 26     | 10           | 2.20               | 0.007097  | 40            | 9.6                | 406             | 291   | 302    | 0.035680 |

| MODEL  | INDIVIDUAL CARTON  |                    |                 |       |        | INNER CARTON |                    |           | MASTER CARTON |                    |                 |       |        |          |
|--|--------------------|--------------------|-----------------|-------|--------|--------------|--------------------|-----------|---------------|--------------------|-----------------|-------|--------|----------|
|  | PACKAGE TYPE       | G/W (kg) (Approx.) | DIMENSIONS (mm) |       |        | Q'ty/CTN     | G/W (kg) (Approx.) | M3        | Q'ty/CTN      | G/W (kg) (Approx.) | DIMENSIONS (mm) |       |        | M3       |
|  |                    |                    | DEPTH           | WIDTH | HEIGHT |              |                    |           |               |                    | DEPTH           | WIDTH | HEIGHT |          |
| <b>OFFICE CALCULATORS (DESKTOP/SEMI-DESKTOP, NICE SIZE, MINI NICE SIZE)</b>      |                    |                    |                 |       |        |              |                    |           |               |                    |                 |       |        |          |
| EL-337C  | Blister Pack       | 0.23               | 245             | 148   | 27     | 10           | 2.50               | 0.007172  | 40            | 11.1               | 592             | 312   | 374    | 0.069079 |
| EL-339S  | Box + Strap        | 0.20               | 179             | 111   | 22     | 10           | 2.20               | 0.005758  | 40            | 9.4                | 410             | 256   | 286    | 0.030019 |
| EL-339S  | Blister Pack       | 0.23               | 245             | 148   | 20     | 10           | 2.50               | 0.008388  | 40            | 10.6               | 402             | 275   | 374    | 0.041346 |
| EL-421M  | Box + Strap        | 0.20               | 173             | 115   | 24     | 10           | 2.20               | 0.006387  | 40            | 9.6                | 388             | 270   | 308    | 0.032266 |
| EL-334F  | Box + Strap        | 0.20               | 173+20          | 115   | 24     | 10           | 2.20               | 0.006387  | 40            | 9.6                | 388             | 270   | 308    | 0.032266 |
| EL-334F  | Blister Pack       | 0.23               | 245             | 148   | 25     | 10           | 2.50               | 0.011447  | 40            | 11.1               | 532             | 280   | 374    | 0.055711 |
| EL-332A  | Box + Strap        | 0.15               | 145+20          | 104   | 31     | 10           | 1.60               | 0.006492  | 40            | 7.2                | 340             | 338   | 286    | 0.032867 |
| EL-332A  | Blister Pack       | 0.17               | 245             | 148   | 38     | 10           | 3.50               | 0.015816  | 40            | 15.6               | 532             | 380   | 374    | 0.075608 |
| EL-331A  | Box + Strap        | 0.13               | 151+20          | 102   | 19     | 10           | 1.40               | 0.004158  | 40            | 6.0                | 350             | 220   | 282    | 0.021714 |
| EL-331A  | Blister Pack       | 0.14               | 250             | 148   | 19     | 10           | 1.50               | 0.008997  | 40            | 10.3               | 422             | 280   | 374    | 0.044192 |
| EL-330A  | Box + Strap        | 0.13               | 151+20          | 102   | 19     | 10           | 1.40               | 0.004158  | 40            | 6.0                | 350             | 220   | 282    | 0.021714 |
| EL-330A  | Blister Pack       | 0.14               | 250             | 148   | 19     | 10           | 1.50               | 0.008997  | 40            | 10.3               | 422             | 280   | 374    | 0.044192 |
| EL-310A  | Box + Strap        | 0.10               | 116+20          | 90    | 23     | 10           | 1.10               | 0.003524  | 40            | 5.0                | 278             | 260   | 258    | 0.018648 |
| EL-310A  | Blister Pack       | 0.12               | 230             | 148   | 23     | 10           | 1.40               | 0.009133  | 40            | 6.5                | 462             | 260   | 374    | 0.044925 |
| EL-M711G   | Window box + Strap | 0.27               | 219             | 142   | 36     | 10           | 2.67               | 0.015128  | 40            | 11.9               | 498             | 400   | 364    | 0.072509 |
| EL-M711G   | Blister Pack       | 0.18               | 245             | 148   | 36     | 10           | 2.05               | 0.0133853 | 40            | 9.3                | 519             | 357   | 350    | 0.064850 |
| EL-M710G   | Window box + Strap | 0.27               | 219             | 142   | 36     | 10           | 2.67               | 0.015128  | 40            | 11.9               | 498             | 400   | 364    | 0.072509 |
| EL-M710G   | Blister Pack       | 0.18               | 245             | 148   | 36     | 10           | 2.05               | 0.0133853 | 40            | 9.3                | 519             | 357   | 350    | 0.064850 |
| EL-M700G   | Window box + Strap | 0.17               | 183             | 128   | 32     | 10           | 1.81               | 0.010535  | 40            | 8.2                | 426             | 360   | 366    | 0.051529 |
| <b>12/14 DIGIT CALCULATORS (NICE SIZE, MINI NICE SIZE, HAND-HELD/HARD COVER)</b> |                    |                    |                 |       |        |              |                    |           |               |                    |                 |       |        |          |
| EL-145A  | Box + Strap        | 0.18               | 169+20          | 108   | 23     | 10           | 1.90               | 0.005789  | 40            | 8.3                | 386             | 260   | 294    | 0.029506 |
| EL-125A  | Box + Strap        | 0.18               | 169+20          | 108   | 23     | 10           | 1.90               | 0.005789  | 40            | 8.3                | 386             | 260   | 294    | 0.029506 |
| EL-144A  | Box + Strap        | 0.13               | 151+20          | 102   | 19     | 10           | 1.40               | 0.004158  | 40            | 6.0                | 350             | 220   | 282    | 0.021714 |
| EL-124A  | Box + Strap        | 0.13               | 151+20          | 102   | 19     | 10           | 1.40               | 0.004158  | 40            | 6.0                | 350             | 220   | 282    | 0.021714 |
| EL-143S  | Box + Strap        | 0.08               | 118+20          | 75    | 15     | 40           | 3.50               | 0.008087  | 160           | 14.9               | 342             | 330   | 354    | 0.039952 |
| EL-123S  | Box + Strap        | 0.08               | 118+20          | 75    | 15     | 40           | 3.50               | 0.008087  | 160           | 14.9               | 342             | 330   | 354    | 0.039952 |
| <b>PERSONAL CALCULATORS (WALLET/HAND-HELD, HARD COVER, CARD)</b>                 |                    |                    |                 |       |        |              |                    |           |               |                    |                 |       |        |          |
| EL-480S  | Box + Strap        | 0.11               | 128+20          | 78    | 18     | 40           | 4.60               | 0.010010  | 160           | 19.4               | 394             | 335   | 354    | 0.046725 |
| EL-480S  | Blister Pack       | 0.12               | 230             | 122   | 17     | 40           | 5.60               | 0.023562  | 160           | 24.2               | 536             | 379   | 538    | 0.109292 |
| EL-344G  | Blister Pack       | 0.12               | 230             | 122   | 15     | 40           | 4.80               | 0.022517  | 160           | 20.8               | 536             | 259   | 538    | 0.074687 |
| EL-W211G   | Window box + Strap | 0.12               | 183             | 106   | 16     | 40           | 4.92               | 0.018376  | 160           | 21.0               | 470             | 370   | 496    | 0.086254 |
| EL-W211G   | Blister Pack       | 0.09               | 210             | 122   | 16     | 40           | 3.78               | 0.0200694 | 160           | 16.5               | 536             | 357   | 489    | 0.093572 |
| EL-327S  | Box + Strap        | 0.09               | 118+20          | 72    | 15     | 40           | 3.70               | 0.007776  | 160           | 15.6               | 342             | 318   | 354    | 0.038500 |
| EL-327S  | Blister Pack       | 0.11               | 230             | 122   | 15     | 40           | 4.80               | 0.021473  | 160           | 20.7               | 536             | 347   | 538    | 0.100064 |
| EL-326S  | Box + Strap        | 0.09               | 118+20          | 72    | 15     | 40           | 3.70               | 0.007776  | 160           | 15.6               | 342             | 318   | 354    | 0.038500 |
| EL-326S  | Blister Pack       | 0.11               | 230             | 122   | 15     | 40           | 4.80               | 0.021473  | 160           | 20.7               | 536             | 347   | 538    | 0.100064 |
| EL-379S  | Box + Strap        | 0.07               | 120             | 73    | 13     | 40           | 3.10               | 0.007317  | 160           | 13.0               | 332             | 314   | 346    | 0.036070 |
| EL-379S  | Blister Pack       | 0.10               | 210             | 122   | 14     | 40           | 4.20               | 0.013945  | 160           | 18.0               | 525             | 501   | 250    | 0.065756 |
| EL-377S  | Box + Strap        | 0.07               | 120+20          | 73    | 13     | 40           | 3.10               | 0.007317  | 160           | 13.0               | 332             | 314   | 346    | 0.036070 |
| EL-377S  | Blister Pack       | 0.10               | 210             | 122   | 14     | 40           | 4.20               | 0.016531  | 160           | 18.4               | 564             | 540   | 266    | 0.081013 |
| EL-371S  | Box + Strap        | 0.07               | 112+20          | 71    | 15     | 40           | 2.80               | 0.007399  | 160           | 12.1               | 337             | 330   | 342    | 0.038034 |
| EL-371S  | Blister Pack       | 0.09               | 230             | 122   | 13     | 40           | 3.70               | 0.018406  | 160           | 16.6               | 536             | 300   | 538    | 0.086510 |
| EL-W200G   | Window box + Strap | 0.10               | 171             | 96    | 16     | 40           | 4.30               | 0.015880  | 160           | 18.5               | 430             | 370   | 472    | 0.075095 |
| EL-W200G   | Blister Pack       | 0.08               | 210             | 122   | 16     | 40           | 3.30               | 0.0200694 | 160           | 14.8               | 536             | 357   | 489    | 0.093572 |
| EL-250S  | Box + Strap        | 0.07               | 118+20          | 74    | 19     | 40           | 2.90               | 0.009955  | 160           | 12.4               | 422             | 326   | 354    | 0.048700 |
| EL-250S  | Blister Pack       | 0.09               | 230             | 122   | 19     | 40           | 3.90               | 0.026695  | 160           | 17.4               | 536             | 427   | 538    | 0.123133 |
| EL-240SA   | Box + Strap        | 0.08               | 121             | 75    | 21     | 40           | 3.40               | 0.0110139 | 160           | 15.2               | 464             | 331   | 357    | 0.054830 |
| EL-240SA   | Blister Pack       | 0.09               | 230             | 122   | 20     | 40           | 4.00               | 0.026478  | 160           | 17.4               | 547             | 417   | 522    | 0.119068 |
| EL-231L  | Box + Strap        | 0.10               | 109+20          | 73    | 24     | 40           | 4.20               | 0.012487  | 160           | 17.6               | 522             | 322   | 356    | 0.059838 |
| EL-233S  | Box + Strap        | 0.05               | 108+20          | 65    | 13     | 40           | 2.10               | 0.006257  | 160           | 9.1                | 302             | 290   | 358    | 0.031354 |
| EL-233S  | Blister Pack       | 0.05               | 180             | 122   | 14     | 40           | 2.60               | 0.012947  | 160           | 11.9               | 529             | 284   | 424    | 0.063700 |
| EL-376S  | Box + Strap        | 0.08               | 118+20          | 75    | 15     | 40           | 3.50               | 0.008087  | 160           | 14.9               | 342             | 330   | 354    | 0.039952 |
| EL-376S  | Blister Pack       | 0.11               | 230             | 122   | 15     | 40           | 4.60               | 0.021473  | 160           | 19.9               | 536             | 347   | 538    | 0.100064 |
| EL-243S  | Box + Strap        | 0.07               | 108+20          | 67    | 15     | 40           | 2.20               | 0.006804  | 160           | 9.4                | 342             | 298   | 334    | 0.034040 |
| EL-243S  | Blister Pack       | 0.07               | 230             | 122   | 14     | 40           | 3.30               | 0.020168  | 160           | 14.6               | 536             | 327   | 538    | 0.094296 |
| EL-879M  | Box + Strap        | 0.07               | 111+20          | 76    | 15     | 40           | 3.00               | 0.008421  | 160           | 12.7               | 362             | 338   | 340    | 0.041601 |

# MERCHANDISING INFORMATION

## MANUAL LANGUAGES

Some manuals are not available in some languages. Please check the chart below.

| MODEL  | ENGLISH   | GERMAN | FRENCH | SPANISH | ITALIAN | DUTCH | SWEDISH | PORTUGUESE | ARABIC | THAI | CHINESE | RUSSIAN | KOREAN | INDONESIAN | TURKISH |
|--|---|--------|--------|---------|---------|-------|---------|------------|--------|------|---------|---------|--------|------------|---------|
| <b>ELECTRONIC DICTIONARIES</b>   |   |        |        |         |         |       |         |            |        |      |         |         |        |            |         |
| PW-E500  | •   |        |        |         |         |       |         |            |        |      |         |         |        |            |         |
| PW-E300  | •   |        |        |         |         |       |         |            |        |      |         |         |        |            |         |
| <b>ELECTRONIC ORGANIZERS</b>   |   |        |        |         |         |       |         |            |        |      |         |         |        |            |         |
| ZQ-590A  | •   |        |        |         |         |       |         |            |        |      |         |         |        |            |         |
| ZQ-290H  | •   |        |        |         |         |       |         |            |        |      |         |         |        |            |         |
| ZQ-270P  | •   |        |        |         |         |       |         |            | •      |      | •       |         |        |            |         |
| ZQ-190P  | •   |        |        |         |         |       |         |            | •      |      | •       |         |        |            |         |
| ZQ-P20H  | •   |        |        |         |         |       |         |            |        |      |         |         |        |            |         |
| EL-6990P   | •   |        |        |         |         |       |         |            |        |      |         |         |        |            |         |
| ZQ-P10   | •   |        |        |         |         |       |         |            |        |      |         |         |        |            |         |
| EL-6910  | •   |        |        |         |         |       |         |            |        |      |         |         |        |            |         |
| EL-6053S   | •   |        |        |         |         |       |         |            | •      |      | •       |         |        |            |         |
| <b>SCIENTIFIC CALCULATORS (GRAPHING, STANDARD, PROGRAMMABLE, FINANCIAL)</b>      |   |        |        |         |         |       |         |            |        |      |         |         |        |            |         |
| EL-9900  | •   |        |        |         |         |       |         |            |        |      |         |         |        |            |         |
| EL-506W  | •   |        |        | •       |         |       |         | •          | •      | •    |         | •       |        | •          |         |
| EL-520W  | •   |        |        | •       |         |       |         | •          | •      | •    |         | •       |        | •          |         |
| EL-531WH   | •   |        |        | •       |         |       |         | •          | •      | •    |         | •       |        | •          |         |
| EL-509W  | •   |        |        | •       |         |       |         | •          | •      | •    |         | •       |        | •          |         |
| EL-510R  | •   |        |        | •       |         |       |         | •          | •      | •    |         | •       |        | •          |         |
| EL-501W  | •   |        |        | •       |         |       |         | •          | •      | •    |         | •       | •      | •          |         |
| EL-5120  | •   | •      | •      | •       | •       |       | •       |            |        | •    |         | •       |        | •          |         |
| EL-735   | •   |        | •      | •       |         |       |         |            |        |      |         |         |        |            |         |
| EL-733A  | •   |        | •      | •       |         |       |         |            |        |      |         |         |        |            |         |
| <b>PRINTING CALCULATORS (DESKTOP, SEMI-DESKTOP, HAND-HELD)</b>                   |   |        |        |         |         |       |         |            |        |      |         |         |        |            |         |
| CS-4194HC  | •   |        | •      | •       |         |       |         |            |        |      |         |         |        |            |         |
| EL-2630PII   | •   |        | •      | •       |         |       |         |            |        |      |         |         |        |            |         |
| EL-2607P   | •   |        | •      | •       |         |       |         |            |        |      |         |         |        |            |         |
| EL-1607P   | •   |        | •      | •       |         |       |         |            |        |      |         |         |        |            |         |
| EL-2910R   | •   |        | •      | •       |         |       |         |            |        |      |         |         |        |            |         |
| EL-2902C   | •   |        | •      | •       |         |       |         |            |        |      |         |         |        |            |         |
| EL-2901RH  | •   | •      | •      | •       | •       | •     | •       | •          |        |      |         | •       |        |            |         |
| EL-1801C   | •   |        | •      | •       |         |       |         |            |        |      |         |         |        |            |         |
| EL-1750P   | •   |        | •      | •       |         |       |         |            |        |      |         |         |        |            |         |
| EL-1611P   | •   |        | •      | •       |         |       |         |            |        |      |         |         |        |            |         |
| <b>SUPER CHECK &amp; CORRECT (SEMI-DESKTOP, NICE SIZE, MINI NICE SIZE)</b>       |   |        |        |         |         |       |         |            |        |      |         |         |        |            |         |
| EL-792C  | •   | •      | •      | •       | •       | •     | •       | •          | •      | •    | •       | •       | •      | •          | •       |
| EL-782C  | •   | •      | •      | •       | •       | •     | •       | •          | •      | •    | •       | •       | •      | •          | •       |
| EL-771C  | •   | •      | •      | •       | •       | •     | •       | •          | •      | •    | •       | •       | •      | •          | •       |
| <b>OFFICE CALCULATORS (DESKTOP/SEMI-DESKTOP, NICE SIZE, MINI NICE SIZE)</b>      |   |        |        |         |         |       |         |            |        |      |         |         |        |            |         |
| CS-2122H   | •   |        | •      | •       |         |       |         |            |        |      |         |         |        |            |         |
| CS-2130  | •   | •      | •      | •       | •       | •     | •       |            |        |      |         |         |        |            |         |
| EL-6138  | •   |        | •      | •       |         |       |         |            | •      | •    | •       | •       |        |            |         |
| EL-2135  | •   | •      | •      | •       | •       | •     | •       |            |        |      |         |         |        |            |         |
| EL-2125C   | •   | •      | •      | •       | •       | •     | •       |            |        |      |         |         |        |            |         |
| EL-2128R   | •   | •      | •      | •       | •       | •     | •       |            | •      | •    | •       | •       | •      |            | •       |
| EL-2139S   | •   | •      | •      | •       | •       | •     | •       |            |        |      |         |         |        |            |         |
| EL-338F  | •   | •      | •      | •       | •       | •     | •       |            |        |      |         |         |        |            |         |
| EL-387R  | •   | •      | •      | •       | •       | •     | •       |            | •      | •    | •       | •       | •      |            | •       |
| EL-337C  | •   | •      | •      | •       | •       | •     | •       |            |        |      |         |         |        |            |         |
| EL-339S  | •   | •      | •      | •       | •       | •     | •       |            |        |      |         |         |        |            |         |
| EL-421M  | •   | •      | •      | •       | •       | •     | •       |            | •      |      |         |         |        |            | •       |
| EL-334F  | •   | •      | •      | •       | •       | •     | •       |            |        |      |         |         |        |            |         |
| EL-332A  | •   | •      | •      | •       | •       | •     | •       |            |        |      |         |         |        |            |         |
| EL-331A  | •   | •      | •      | •       | •       | •     | •       |            |        |      |         |         |        |            |         |
| EL-330A  | •   | •      | •      | •       | •       | •     | •       |            |        |      |         |         |        |            |         |
| EL-310A  | No manual available. Operating instructions are printed on the product's box. |        |        |         |         |       |         |            |        |      |         |         |        |            |         |
| EL-M711G   | •   | •      | •      | •       | •       | •     | •       |            |        |      |         | •       |        |            |         |
| EL-M710G   | •   | •      | •      | •       | •       | •     | •       |            |        |      |         | •       |        |            |         |
| EL-M700G   | •   | •      | •      | •       | •       | •     | •       |            |        |      |         | •       |        |            |         |
| <b>12/14 DIGIT CALCULATORS (NICE SIZE, MINI NICE SIZE, HAND-HELD/HARD COVER)</b> |   |        |        |         |         |       |         |            |        |      |         |         |        |            |         |
| EL-145A  | •   |        |        |         |         |       |         |            |        | •    |         |         |        | •          |         |
| EL-125A  | •   |        |        |         |         |       |         |            |        |      |         |         |        |            |         |
| EL-144A  | •   |        |        |         |         |       |         |            |        | •    |         |         |        | •          |         |
| EL-124A  | •   |        |        |         |         |       |         |            |        |      |         |         |        |            |         |
| EL-143S  | •   |        |        |         |         |       |         |            |        | •    |         |         |        | •          |         |
| EL-123S  | •   |        |        |         |         |       |         |            |        |      |         |         |        |            |         |
| <b>PERSONAL CALCULATORS (WALLET/HAND-HELD, HARD COVER, CARD)</b>                 |   |        |        |         |         |       |         |            |        |      |         |         |        |            |         |
| EL-480S  | •   | •      | •      | •       | •       | •     | •       |            |        |      |         | •       |        |            |         |
| EL-344G  | •   |        | •      | •       |         |       |         |            |        |      |         |         |        |            |         |
| EL-W211G   | •   | •      | •      | •       | •       | •     | •       |            |        |      |         | •       |        |            |         |
| EL-327S  | •   | •      | •      | •       | •       | •     | •       |            |        |      |         |         |        |            |         |
| EL-326S  | •   | •      | •      | •       | •       | •     | •       |            |        |      |         | •       |        |            |         |
| EL-379S  | No manual available. Operating instructions are printed on the product's box. |        |        |         |         |       |         |            |        |      |         |         |        |            |         |
| EL-377S  | No manual available. Operating instructions are printed on the product's box. |        |        |         |         |       |         |            |        |      |         |         |        |            |         |
| EL-371S  | •   | •      | •      | •       | •       | •     | •       |            |        |      |         |         |        |            |         |
| EL-W200G   | •   | •      | •      | •       | •       | •     | •       |            |        |      |         | •       |        |            |         |
| EL-250S  | •   | •      | •      | •       | •       | •     | •       |            |        |      |         | •       |        |            |         |
| EL-240SA   | •   | •      | •      | •       | •       | •     | •       |            |        |      |         | •       |        |            |         |
| EL-231L  | No manual available. Operating instructions are printed on the product's box. |        |        |         |         |       |         |            |        |      |         |         |        |            |         |
| EL-233S  | No manual available. Operating instructions are printed on the product's box. |        |        |         |         |       |         |            |        |      |         |         |        |            |         |
| EL-376S  | No manual available. Operating instructions are printed on the product's box. |        |        |         |         |       |         |            |        |      |         |         |        |            |         |
| EL-243S  | No manual available. Operating instructions are printed on the product's box. |        |        |         |         |       |         |            |        |      |         |         |        |            |         |
| EL-879M  | No manual available. Operating instructions are printed on the product's box. |        |        |         |         |       |         |            |        |      |         |         |        |            |         |



## ACCESSORIES AND OPTIONS

### BATTERY

#### Alkaline Manganese Battery

| Model            | LR1130    |                       | LR44     |         |          |         | LR6      |          | LR03    |          |
|------------------|-----------|-----------------------|----------|---------|----------|---------|----------|----------|---------|----------|
| Applicable model | EL-879M   | EL-326M               | EL-M711G | EL-509W | EL-338A  | EL-125A | EL-99T   | ZQ-700PC | EL-9900 | ZQ-590   |
|                  | EL-869GII | EL-326S               | EL-M710G | EL-506R | EL-337C  | EL-124A | EL-6135  |          | EL-99T  | ZQ-590A  |
|                  | EL-869G   | EL-320L               | EL-M700G | EL-506V | EL-337M  |         | EL-531LH |          | EL-9650 | ZQ-570   |
|                  | EL-480G   | EL-310A               | EL-733A  | EL-506W | EL-335H  |         | EL-531RH |          | EL-965T | ZQ-570PC |
|                  | EL-480S   | EL-250S               | EL-556L  | EL-5020 | EL-334A  |         | EL-531VH |          | EL-9600 | ZQ-540P  |
|                  | EL-430S   | EL-243L               | EL-546L  | EL-501V | EL-334F  |         | EL-531WH |          | EL-96T  | ZQ-520P  |
|                  | EL-379S   | EL-243S               | EL-546VA | EL-501W | EL-334L  |         | EL-2626H |          | EL-9450 |          |
|                  | EL-377S   | EL-240L               | EL-520L  | EL-500L | EL-332A  |         | EL-242M  |          | EL-945T |          |
|                  | EL-376L   | EL-240S               | EL-520R  | EL-421M | EL-331A  |         | EL-231L  |          | EL-9400 |          |
|                  | EL-376S   | EL-240SA              | EL-520V  | EL-420M | EL-330A  |         | EL-1801C |          | PW-E500 |          |
|                  | EL-371S   | EL-233L               | EL-520VA | EL-4125 | EL-2139S |         | EL-1801L |          | PW-E300 |          |
|                  | EL-342M   | EL-233S               | EL-520W  | EL-410M | EL-2128R |         | EL-1750P |          | ZQ-6800 |          |
|                  | EL-341S   | EL-2135 <sup>*1</sup> | EL-510R  | EL-387R | EL-2125  |         | EL-1611L |          | ZQ-6600 |          |
|                  | EL-331L   | EL-143S               | EL-509L  | EL-354M | EL-2125C |         | EL-1611P |          | ZQ-650  |          |
|                  | EL-330L   | EL-123S               | EL-509R  | EL-339S | EL-145A  |         | SE-300   |          | ZQ-640  |          |
|                  | EL-327S   |                       | EL-509V  | EL-338F | EL-144A  |         | ZQ-750PC |          | ZQ-630  |          |

#### Lithium Battery

| Model            | CR2032  |         |          |          |                       |          | CR2025  |          | CR2016   |  |
|------------------|---------|---------|----------|----------|-----------------------|----------|---------|----------|----------|--|
| Applicable model | CS-2130 | EL-96T  | EL-782C  | EL-6810  | ZQ-480P               | ZQ-190P  | EL-6690 | EL-5120  | EL-W211G |  |
|                  | EL-9900 | EL-950  | EL-771C  | EL-6790P | EL-6138               | ZQ-470   | ZQ-180P |          | EL-W200G |  |
|                  | EL-99T  | EL-9450 | EL-6990P | EL-6750  | EL-2135 <sup>*1</sup> | ZQ-290II | ZQ-170  | EL-6620  | EL-735   |  |
|                  | EL-9650 | EL-945T | EL-6910  | EL-6710S | ZQ-P20                | ZQ-290H  | ZQ-160  | EL-6053  | EL-6092  |  |
|                  | EL-965T | EL-9400 | EL-6890P | EL-6690  | ZQ-P20H               | ZQ-290P  | ZQ-150  | EL-6053S | EL-6051  |  |
|                  | EL-9600 | EL-792C | EL-6850  | EL-6660  | ZQ-P10                | ZQ-270P  |         | EL-6052  |          |  |

#### AC ADAPTER

| Model            | EA-28A   |          |          |
|------------------|----------|----------|----------|
| Applicable model | EL-2626H | EL-1801L | EL-1611L |
|                  | EL-1801C | EL-1750P | EL-1611P |

#### HALF-SIZE RAM CARD with BATTERY

| Model            | CE-2H16M <sup>*2</sup> |
|------------------|------------------------|
| Applicable model | PC-E500S               |

#### INK RIBBON

| Model            | URBNT1007CCZZ |            |
|------------------|---------------|------------|
| Applicable model | CS-4194       | EL-2631L   |
|                  | CS-4194H      | EL-2630L   |
|                  | CS-4194HC     | EL-2630PII |
|                  | CS-2195L      | EL-2615G   |
|                  | CS-2194       | EL-2607P   |

#### PAPER ROLL

| Model            | DPAPR1004CSZZ <sup>*3</sup> |           |          |          | EA-7100P <sup>*4</sup> |
|------------------|-----------------------------|-----------|----------|----------|------------------------|
| Applicable model | CS-4194                     | EL-2910R  | EL-2630L | EL-1801C | EL-1607R               |
|                  | CS-4194H                    | EL-2902C  | EL-2626H | EL-1801L | EL-1195L               |
|                  | CS-4194HC                   | EL-2901C  | EL-2615G | EL-1750P | EL-1611P               |
|                  | CS-2195L                    | EL-2901RH | EL-2607R | EL-1611L |                        |
|                  | CS-2194                     | EL-2631L  | EL-2195L | EL-1611P |                        |

#### INK ROLLER

| Model            | EA-732R  |          | EA-772R   |          | EA-781R-BK/EA-781R-RD <sup>*5</sup> |          |          |          | EA-741R  |
|------------------|----------|----------|-----------|----------|-------------------------------------|----------|----------|----------|----------|
| Applicable model | EL-1801L | EL-1611P | EL-2901RH | EL-1750P | EL-2910R                            | EL-2901C | EL-1801C | EL-1195L | EL-2607R |
|                  | EL-1611L |          | EL-2626H  |          | EL-2902C                            | EL-2195L | EL-1607P |          | EL-1607R |

#### ACCESSORY LINK KIT

##### PC-Link Software & Cable

| Model            | CE-491FD (without cable) <sup>*6</sup> | CE-491W <sup>*6, 8</sup> |         |         |         |        | CE-690W (cable option) <sup>*6</sup> | CE-LK2  | CE-LK1P <sup>*9</sup> |
|------------------|--|--------------------------|---------|---------|---------|--------|--------------------------------------|---------|-----------------------|
| Applicable model | EL-6890P <sup>*7</sup>                 | EL-6850                  | ZQ-5400 | ZQ-4300 | ZQ-2800 | ZQ-160 | ZQ-8600                              | EL-9900 | EL-9650               |
|                  | EL-6790P <sup>*7</sup>                 | EL-6750                  | ZQ-470  | ZQ-4200 | ZQ-2700 | ZQ-150 | ZQ-6800                              |         | EL-9600               |
|                  | ZQ-480P <sup>*7</sup>                  | EL-6690                  | ZQ-4600 | ZQ-4000 | ZQ-2600 |        | ZQ-6600                              |         | EL-9450               |
|                  | ZQ-190P <sup>*7</sup>                  | EL-6660                  | ZQ-4500 | ZQ-3200 | ZQ-2500 |        |                                      |         | EL-9400               |
|                  | ZQ-180P <sup>*7</sup>                  | ZQ-5900                  | ZQ-4400 | ZQ-3000 | ZQ-170  |        |                                      |         |                       |

#### Docking Station

| Model            | CE-60K <sup>*10</sup> /CE-61T <sup>*11</sup> |          |          |
|------------------|--|----------|----------|
| Applicable model | ZQ-650                                       | ZQ-640PC | ZQ-630PC |
|                  | ZQ-650PC                                     | ZQ-630   | ZQ-570   |

#### Level Converter

| Model            | CE-133T/CE-135T <sup>*12</sup> |         |         |
|------------------|--------------------------------|---------|---------|
| Applicable model | ZQ-8600                        | ZQ-6600 | ZQ-6000 |
|                  | ZQ-6800                        | ZQ-6200 |         |

#### Set-to-Set Communication Cable

| Model            | CE-300L (4-pin) |          |         |         | CE-451L (3-pin) | CE-450L (3-pin) | CE-260L <sup>*8</sup> (3-pin) |         |
|------------------|-----------------|----------|---------|---------|-----------------|-----------------|-------------------------------|---------|
| Applicable model | EL-6690         | ZQ-630PC | ZQ-5400 | ZQ-4200 | EL-9900         | EL-9650         | EL-6890P                      | ZQ-180P |
|                  | EL-6660         | ZQ-6200  | ZQ-470  | ZQ-4000 |                 | EL-9600         | EL-6850                       | ZQ-160  |
|                  | ZQ-650          | ZQ-6000  | ZQ-4600 | ZQ-3200 |                 | EL-9450         | EL-6790P                      |         |
|                  | ZQ-650PC        | ZQ-5900  | ZQ-4500 | ZQ-3000 |                 | EL-9400         | EL-6750                       |         |
|                  | ZQ-640PC        | ZQ-570   | ZQ-4400 | ZQ-2800 |                 |                 | ZQ-480P                       |         |
|                  | ZQ-630          | ZQ-570PC | ZQ-4300 | ZQ-2700 |                 |                 | ZQ-190P                       |         |

\*1 See the back of the calculator for compatibility.

\*2 CE-2H16M: 16KB

\*3 5 rolls/pack, 58 (W) x 80 (ø) mm

\*4 58 (W) x 25 (ø) mm

\*5 EA-781R-BK: Black, EA-781R-RD: Red

\*6 English version only.

\*7 Use either CE-491W or CE-491FD.

\*8 May not be available in some regions as stocks are very limited.

\*9 English and French version only.

\*10 English version only. With PC Link & PIM software.

\*11 Without software.

\*12 CE-130T/CE-133T: for IBM-PC (RS232C), CE-135T: for MAC (RS422)

**SHARP**  
SHARP CORPORATION OSAKA, JAPAN

## Free Manuals Download Website

<http://myh66.com>

<http://usermanuals.us>

<http://www.somanuals.com>

<http://www.4manuals.cc>

<http://www.manual-lib.com>

<http://www.404manual.com>

<http://www.luxmanual.com>

<http://aubethermostatmanual.com>

Golf course search by state

<http://golfingnear.com>

Email search by domain

<http://emailbydomain.com>

Auto manuals search

<http://auto.somanuals.com>

TV manuals search

<http://tv.somanuals.com>