



SHARP

PORTABLE MINIDISC RECORDER

MODEL

MD-MT88H

OPERATION MANUAL

If you require any advice or assistance regarding your Sharp product, please visit our web-site www.sharp.co.uk/support.

Customers without Internet access may telephone 08705 274277 during office hours (or (01) 676 0648 if telephoning from Ireland).

Thank you for purchasing this SHARP product.
For the best performance, read this manual carefully.
It will guide you in operating your SHARP product.



MDLP



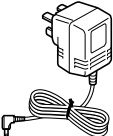
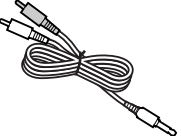

Accessories

 <p>Earphones x 1</p>	 <p>AC Adaptor (RADPA8046AWZZ) x 1</p>	 <p>Connection Cable (for analogue recording) x 1</p>
---	--	---

Notes:

- Parts and equipment mentioned in this operation manual other than those detailed above are not included.
- The AC adaptor may be different from the one in the drawing.

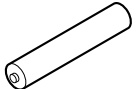
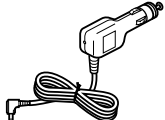
Optional Accessories

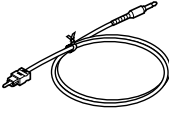
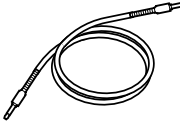
 <p>Rechargeable Nickel-Metal Hydride Battery (AD-N70BT)</p>	 <p>Car adaptor (AD-CA20X)</p>	 <p>Cassette adaptor (AD-CT14)</p>	 <p>Connection Cable (for digital recording) (AD-M1DC)</p>	 <p>Connection Cable (for digital recording) (AD-M2DC)</p>
--	--	--	--	---

Contents

■ Important Introduction

Special Notes	4-5
Names of Controls and Indicators	6-7
Precautions	8

■ Preparation

Inserting a MiniDisc	9
Connections	10-11

■ Basic Operation

Recording	12-15
Playback	16-17

■ Useful Features

Advanced Playback	18-19
Advanced Recording	20-25
Recording from a Microphone	26-29
Checking Displays	30-31
Battery Power	32-33
Hold Function	34

■ Advanced Features

Changing Default Settings	35
Titling a MiniDisc	36-39
Editing a Recorded MiniDisc	40-42
Listening through Another System	43

■ References

Other Features and Caution	44
MiniDisc System Limitations	45
Error Messages	46-47
Troubleshooting	48-49
Maintenance	49
Specifications	50-51

TERMS OF GUARANTEE Back cover

Special Notes

NOTES FOR USERS IN THE U.K. AND IRELAND

SERVICE INFORMATION

In the unlikely event of your equipment requiring repair, please contact the dealer or supplier from whom it was purchased. Where this is not possible, please visit our web-site www.sharp.co.uk/support. Customers without internet access may telephone 08705 274277 during office hours (or (01) 676 0648 if telephoning from Ireland).

Please note; all calls will be charged at local rate.

Certain replacement parts and accessories may be obtained from our main parts distributor.

WILLOW VALE ELECTRONICS LTD.
0121 766 5414

In the unlikely event of this equipment requiring repair during the guarantee period, you will need to provide proof of the date of purchase to the repairing company. Please keep your invoice or receipt, which is supplied at the time of purchase.

■ Warnings

- The supplied AC adaptor contains no user serviceable parts. Never remove covers unless qualified to do so. It contains dangerous voltages, always remove mains plug from the main outlet socket before any service operation or when not in use for a long period.
- The AC adaptor supplied with the MD-MT88H must not be used with other equipment.
- To prevent fire or shock hazard, do not expose this appliance to dripping or splashing liquids. No objects filled with liquids, such as vases, shall be placed on the apparatus.
- Never use an AC adaptor other than the one specified. Otherwise, problems or serious hazards may be created.

■ Caution

- When recording important selections, make a preliminary test to ensure that the desired material is properly recorded.
- SHARP is not liable for damage or loss of your recording arising from malfunction of this unit.

- At full volume, prolonged listening to a personal stereo may damage the user's hearing. This model complies with the law if used with the correct earphones (model number RPHOH0011AWZZ). If the earphones are damaged in any way, please order using the model number given above.
- This product is classified as a CLASS 1 LASER PRODUCT.
- Use the Portable MiniDisc Recorder only in accordance with the instructions given in this manual and do not attempt to interfere with the interlock switch or make any other adjustment as this may result in exposure to hazardous radiation.

Laser Diode Properties

- Material: GaAlAs
- Wavelength: 785 nm
- Pulse time:

Read mode: 0.8 mW Continuous

Write mode: max 10 mW 0.5S
min cycle 1.5S
Repetition

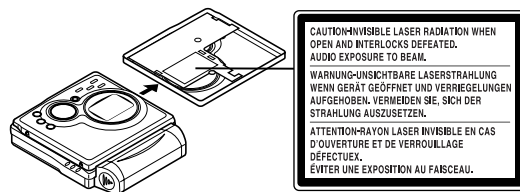

Notes

- Recording and playback of any material may require consent, which SHARP is unable to give. Please refer particularly to the provisions of the Copyright Act 1956, the Dramatic and Musical Performers Protection Act 1958, the Performers Protection Acts 1963 and 1972 and to any subsequent statutory enactments and orders.
- This equipment complies with the requirements of Directives 89/336/EEC and 73/23/EEC as amended by 93/68/EEC.
- US and foreign patents licensed from Dolby Laboratories.
- The letters in brackets contained in the model number indicate the colour of the product only. Operation and specifications are unaffected.

Web-site: www.sharp.co.uk/support Help Line: 08705 274277 (office hours)

5

01/4/4 88UK_1.fm

Names of Controls and Indicators

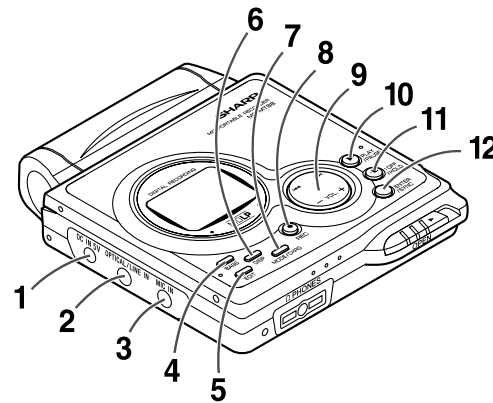

■ Main unit

1. 5V DC Input Socket (10)
2. Optical/Line Input Socket (10, 11)
3. Microphone Input Socket (26)
4. Bass/Delete Button (17, 37)
5. Edit/Auto Mark/Time Mark Button (24, 29, 36)
6. Display/Character Select Button (30, 36)
7. Mode/Charge Button (13, 19, 20, 32, 35)
8. Record/Track Mark Button (12, 24)
9. Volume/Cursor/Fast Forward/Fast Reverse/Recording Level/Name Select Button (12, 17, 18, 35, 36)
10. Play/Pause Button (13, 17)
11. Stop/Power Off/Hold Button (13, 14, 17, 34)
12. Enter/Fast Play/Synchro Button (19, 22, 23)
13. Earphones/Line Output Socket (16, 43)
14. Open Lever (9)
15. Battery Cover (32)

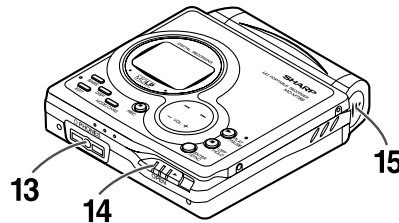

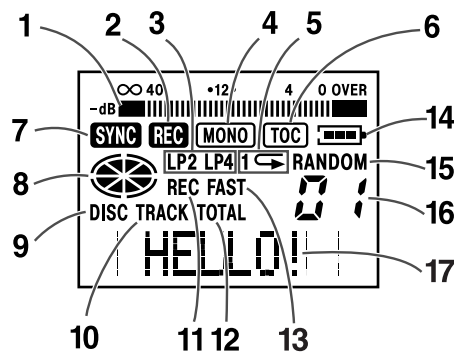

■ Display panel

1. Level Meter (12)
2. Record Indicator (12)
3. Long-play/Recording Mode Indicator (20)
4. Monaural Mode Indicator (20)
5. Repeat Indicator (19)
6. TOC Indicator (13)
7. Synchro Recording Indicator (22)
8. Disc Mode Indicator
9. Disc Name Indicator (30)
10. Track Name Indicator (30)
11. Remaining Recording Time Indicator (30)
12. Total Track Number Indicator (30)
13. Fast Play Indicator (19)
14. Battery Indicator (31)
15. Random Indicator (19)
16. Track Number Indicator (30)
17. Character/Time Information Indicator

Precautions

■ Important

- Do not wear your earphones when you are crossing streets or near traffic.
- Do not use your earphones whilst driving a motor vehicle, it may create a traffic hazard and may be illegal. Remember to obey all of the safety rules in your area.



- Do not play the unit at a high volume. Hearing experts advise against extended listening at high volume levels.
- If you experience ringing in your ears, reduce the volume or discontinue use.
- No naked flame sources, such as lighted candles, should be placed on the apparatus.
- Attention should be drawn to the environmental aspects of battery disposal.
- The apparatus is designed for use in moderate climate.
- This portable MD should only be used within the range of 0°C - 40°C (32°F - 104°F).

To avoid accidental electric shock or other possible problems, observe the precautions listed below.

- Do not disassemble or modify the unit.
- Do not drop or subject the unit to shock.
- Do not use the unit near open flames.
- Do not spill liquid on the unit.
- Do not use an external power supply, other than the 5V DC supplied with this unit, as it may damage it.
- SHARP is not responsible for damage due to improper use. Refer all servicing to a SHARP authorised service centre.

■ Storing the unit

Avoid using or leaving the unit in the following places.

- Places exposed to direct sunlight for many hours (especially in cars with the doors and windows closed) or near heaters. (The cabinet may deform, change colour or the unit may malfunction.)
- Places exposed to excessive dust.
- Places exposed to water.



- Places where temperatures are excessively high or low.



- Places (bathrooms) where the humidity is extremely high.
- Places with strong magnetic fields such as TVs or loudspeakers.
- Places exposed to vibration.
- Places where sand can easily enter the inside of the unit (beaches etc.).



- If the unit is used near radio tuners or TVs, noise and/or picture interference may result. If you experience these problems, move the unit away from such devices.
- It is not recommendable to put the MiniDisc into a rear pocket, as this may damage the product when sitting.

Inserting a MiniDisc

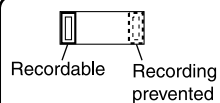
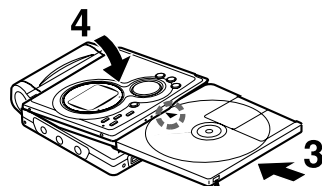
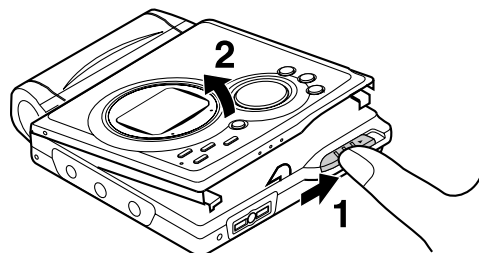

When you record on a MiniDisc, check that the erase prevention tab is set to the "Recordable" position.

- 1 Slide the OPEN lever to release the compartment door.
- 2 Lift it up.
- 3 Insert a MiniDisc as shown.
- 4 Close the compartment door.

Notes:

- Do not place the MiniDisc under the holder.

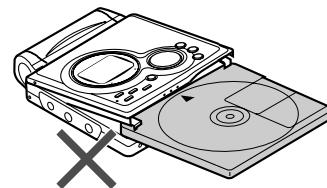

- If any resistance is felt, do not force the MiniDisc into the unit, as it may cause damage to the unit. If resistance is felt, remove the MiniDisc and reload it.
- The lid cannot be opened if "TOC" is displayed; refer to the instruction on page 14.

Connections

You can record your favourite CDs or tapes to MD.

■ To connect to a stereo system with "LINE OUT" or "AUDIO OUT" sockets

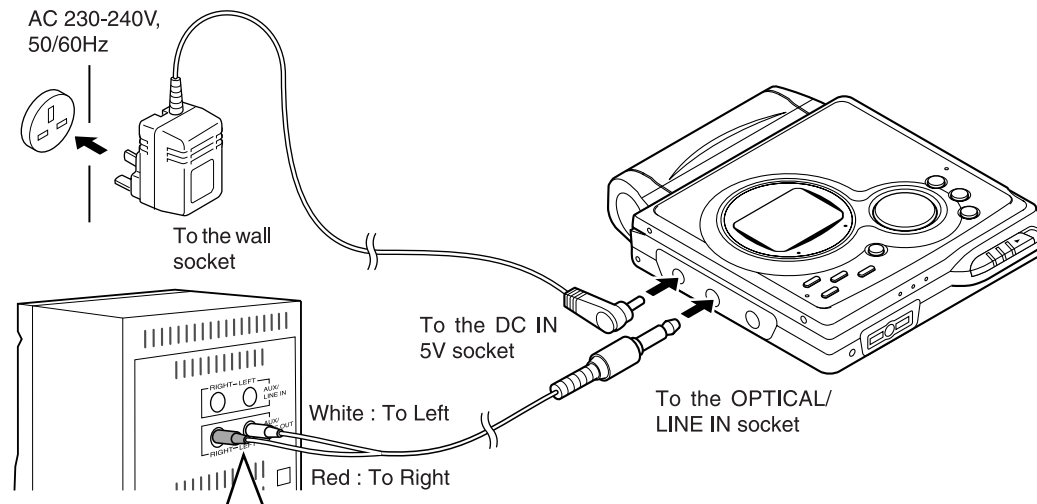

LINE OUT To a stereo system with "LINE OUT" or "AUDIO OUT" sockets.

Note:
If the audio system has only one pair of sockets, they are usually for input only and recording via this connection is not possible.

RIGHT LEFT

■ To connect to a stereo system with a "DIGITAL OUT" or "OPTICAL OUT" socket

AC 230-240V,
50/60Hz

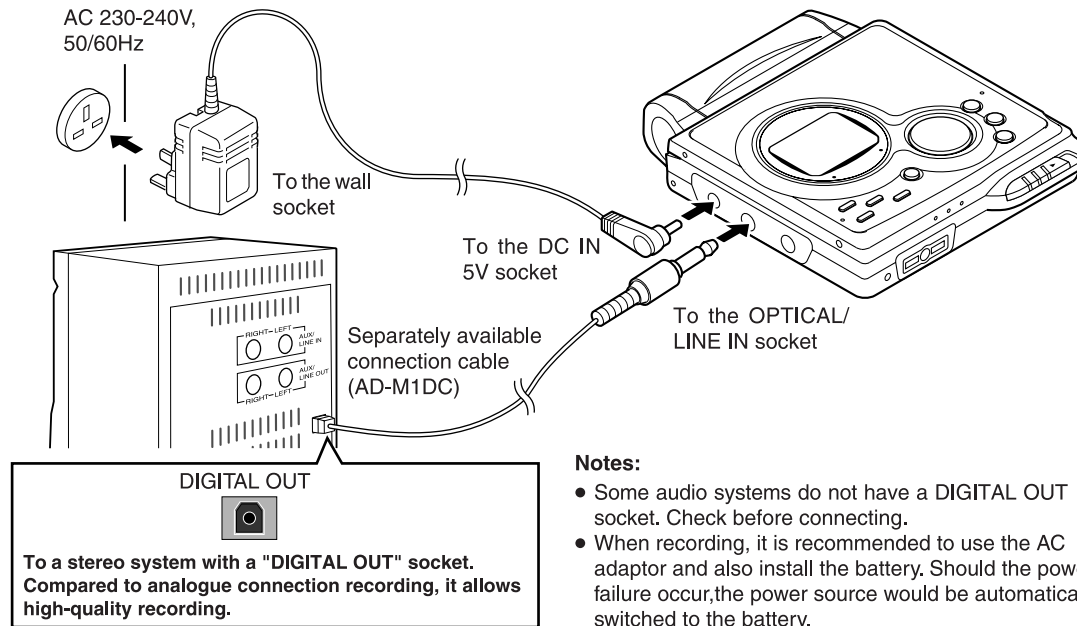

DIGITAL OUT

To a stereo system with a "DIGITAL OUT" socket.
Compared to analogue connection recording, it allows high-quality recording.

Notes:

- Some audio systems do not have a DIGITAL OUT socket. Check before connecting.
- When recording, it is recommended to use the AC adaptor and also install the battery. Should the power failure occur, the power source would be automatically switched to the battery.

Recording

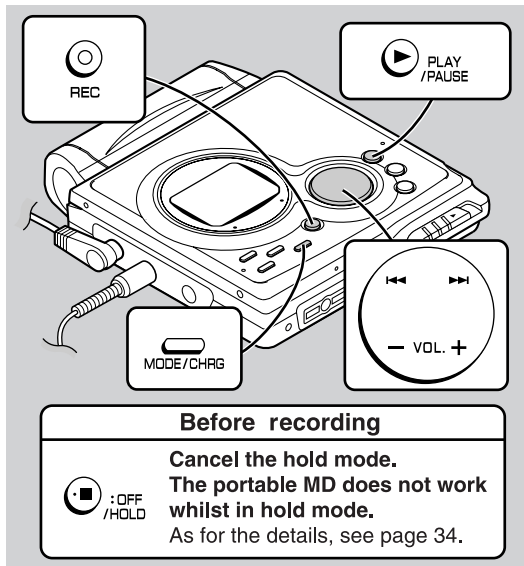

- 1 Press the REC button.**
- 2 Begin playback on the stereo system connected to this portable MD.**

- 3 Press the ◀◀ or ▶▶ button to adjust the recording level.**

<Analogue recording>

Adjust the recording level so that the maximum sound volume from the source makes the reading swing somewhere between -4 dB and 0 dB.

Level meter indicator

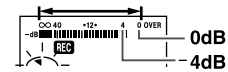

<Digital recording>

You can adjust the level in 1dB increments within the range of +12 - -12dB.

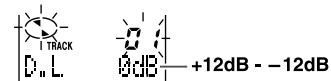

Once you adjust the digital recording level, the setting remains even after the recording stops. (For cancellation instructions, see page 35.)

4 Press the PAUSE button on the stereo system to enter the playback pause mode.

Here you can search for the track to record.

5 Press the MODE/CHRG button repeatedly to select the recording mode (page 20).

No display	(Stereo recording)
LP2	(2 times long recording)
LP4	(4 times long recording)
MONO	(Monaural recording)

6 Press the PLAY/PAUSE button to start the MiniDisc unit recording.

7 Begin playback on the stereo system, the output will be recorded.

To interrupt recording

Press the PLAY/PAUSE button.

- To resume recording, press the PLAY/PAUSE button again.
- The track number will be increased by one each time the recording is interrupted.

To stop recording

Press the ■/OFF button.

- When recording stops, "TOC" appears. Whilst "TOC" appears, the MiniDisc recorded contents have not yet been updated.
- To prevent the new recording from being lost, it is not possible to remove the MiniDisc whilst "TOC" is displayed.

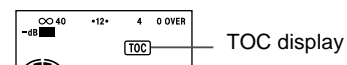

Notes:

- Changing the volume level whilst recording does not affect the recording.
- You cannot adjust the bass level whilst recording.

Recording (continued)

To update the recorded contents of the MiniDisc

Press the ■/OFF button whilst in the stop mode. The power turns off after recorded contents have been updated on the MiniDisc.

About the TOC

After any recording or editing function, "TOC" (Table Of Contents) is displayed. To finalise the recording or editing function, press the ■/OFF button. During this process "TOC" will flash and "TOC EDIT!" will be displayed. During any recording or editing function, the MiniDisc unit lid is locked, and the MiniDisc cannot be removed until the process is finalised.

Warning:

If the power is removed (Battery/AC adaptor) whilst "TOC" is displayed, the MiniDisc unit lid will remain locked until the battery/main power is restored and the unit is turned on. Your new recordings or edited changes will be lost and your MiniDisc may become unusable.

Caution:

Whilst "TOC" or "TOC EDIT!" is displayed, follow the instructions below.

- Do not jerk or bump the unit.
- Do not unplug the AC adaptor.
- Do not remove the rechargeable battery or an alkaline battery.
- Do not subject the unit to shock.

Otherwise, tracks may not be recorded properly.

■ **To prevent recorded MiniDiscs from being erased accidentally**

Slide the accidental erase prevention tab, located on the side of the MiniDisc, in the direction indicated by the arrow.

The MiniDisc will then be protected against accidental erasure.

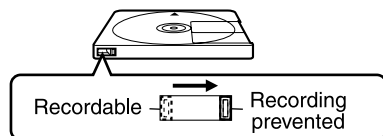

To add a recording to such a MiniDisc, slide the accidental erase prevention tab back to its original position.

■ **Helpful tip when attaching a label**

When attaching a label to an MiniDisc cartridge, be sure to note the following. If the label is not attached properly, the MiniDisc may jam inside the unit and it may not be possible to remove it.

- If the label peels off or partially lifts away, replace it with a new one.
- Do not put a new label on top of an existing one.
- Attach the label only in the specified location.

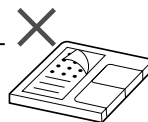

■ **About sampling rate converter**

This portable MD incorporates a sampling rate converter meaning it can record from digital radios or DAT tape recorders.

■ **Note for digital recording**

You cannot copy a MiniDisc that you recorded from digital inputs to another MiniDisc or DAT. It is prevented by the SCMS (Serial Copy Management System). Recording from analogue inputs is not affected.

Digital signals Digitally recorded MiniDisc Cannot record

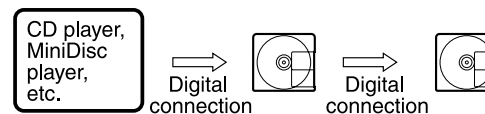

Playback

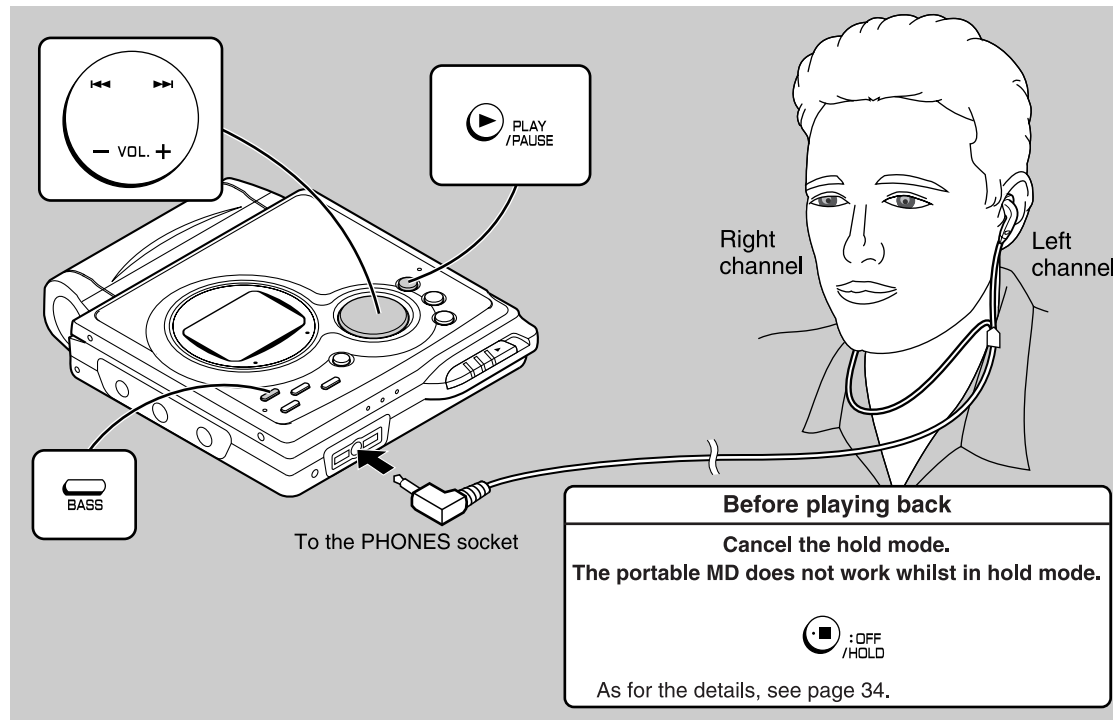

1 Insert the earphones plug into the PHONES socket.

2 Insert a MiniDisc (page 9).

3 Press the PLAY/PAUSE button.

Playback starts automatically with a playback only MiniDisc or a MiniDisc which is protected against accidental erasure (Auto-play function).

To interrupt playback

Press the PLAY/PAUSE button.

To resume playback, press the PLAY/PAUSE button again.

To stop playback

Press the ■:OFF button.

If the unit is not operated for at least 2 minutes whilst in the stop mode, the power will shut off automatically.

To turn off the power

Press the ■:OFF button whilst in the stop mode.

■ Volume control

Press the VOL+ button to increase the volume and the VOL- button to decrease the volume.

Volume (0-30) — VOL 15 ■

■ Bass control

Each time the BASS button is pressed, the tone will be switched as follows.

BASS 1	Emphasised slightly
BASS 2	Emphasised more
BASS 3	Emphasised fully
BASS OFF	Cancelled

Notes:

- If power failure occurs whilst playing a disc using the AC adaptor, disconnect it from the wall socket. Otherwise, playback may start automatically when electricity resumes.
- If you connect the AC adaptor without installing the rechargeable battery, playback may start automatically. Be sure to turn off the power.
- Reduce the volume before starting to play. MiniDiscs, compared to ordinary cassette tapes, have very little noise. If the volume is adjusted according to your usual expectations of noise, high volume may damage your hearing.
- The sound escaping from your earphones may annoy people around you. In particularly crowded places (such as on trains or buses), reduce the volume.

Web-site: www.sharp.co.uk/support Help Line: 08705 274277 (office hours)

Advanced Playback

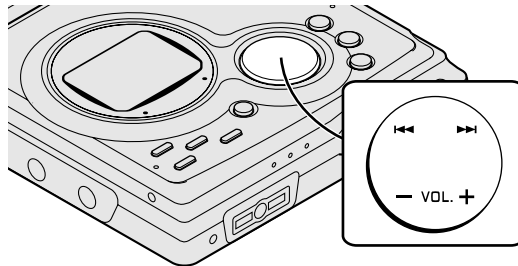

■ To locate the desired portion

For audible fast forward:

Press and hold down the >>>I button during playback.

For audible fast reverse:

Press and hold down the I<<< button during playback.

- Normal playback will resume when the I<<< or >>>I button is released.
- When the end of the last track is reached during fast forward, the unit will enter the pause mode. When the beginning of the first track is reached during fast reverse, the unit will enter the playback mode.

■ To locate the beginning of a track

To move to the beginning of the next track:

Press the >>>I button during playback.

To restart the track being played:

Press the I<<< button during playback.

To locate the next track:

Press the >>>I button whilst the unit is stopped.

To locate the previous track:

Press the I<<< button whilst the unit is stopped.

- To skip a number of tracks at one time, press the I<<< or >>>I button repeatedly until the desired track number is shown.
- When you press the PLAY/PAUSE button, playback starts from the beginning of the track.

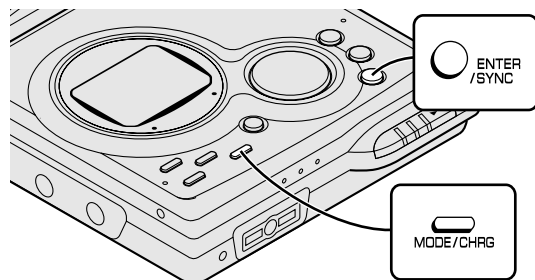

■ **To play at double speed**

Press the ENTER/SYNC button whilst a MiniDisc recorded in the monaural mode is being played.

FAST PLAY

- If a track recorded in the stereo mode is reached during fast playback, the fast playback mode will be cancelled.
- Depending on the contents recorded on a MiniDisc, it may be difficult to hear them.

To interrupt fast playback

Press the PLAY/PAUSE button during playback. When the PLAY/PAUSE button is pressed again, the unit will resume fast playback.

To return to normal playback

Press the ENTER/SYNC button.

■ **Random play or repeat play**

During playback, press the MODE/CHRG button repeatedly to select the playback mode.

RANDOM	Random play
☐RANDOM	Repeat play of tracks in random order
☐☐	Repeat play of all of the tracks
1☐	Repeat play of a single track
No display	Normal playback

Notes:

- If the playback mode is selected whilst stopped, press the PLAY/PAUSE button to start playback.
- When "TOC" is displayed, random play or repeat play is impossible.
- In random play the unit will select and play tracks automatically. (You cannot select the order of the tracks.) After all of the tracks have been played once each in random order, the unit will stop automatically.
- During random, random repeat, or single track repeat play, you can forward or reverse the MiniDisc only within the track being played.
- During random play, the unit cannot find the beginning of any track which has been played.
- Repeat play lasts until you stop the unit.

Advanced Recording

■ Long-play recording

2 times and 4 times long recording

Double or quadruple time of stereo recording is possible.

Monaural recording

In monaural, you can record twice as long as the stereo recording.

A track recorded in monaural can be played back in double speed, see page 19.

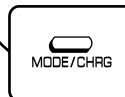
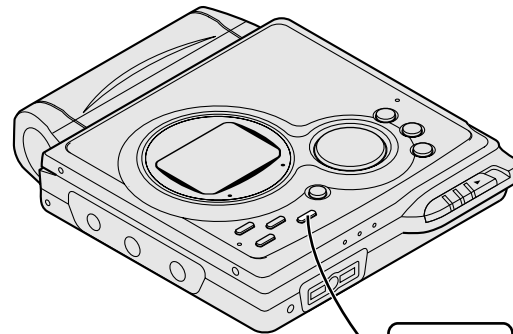

1 When a recording is paused, press the MODE/CHRG button repeatedly to select the recording mode.

Each time the button is pressed, the display will change as follows.

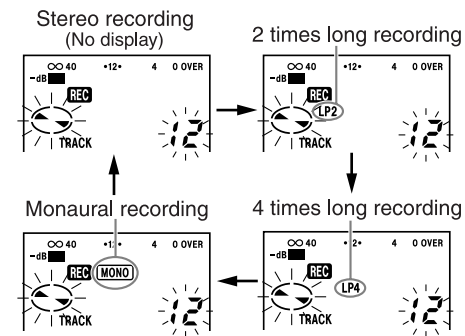

2 Start recording.

The recording mode remains unchanged until a new mode is selected.

Notes:

- Tracks can be recorded in stereo recording mode, 2 times long recording mode, and 4 times long recording mode on one MiniDisc.
- In monaural recording, the sound on the right and left channels is mixed even if the input source is in stereo. Although you can hear the stereo sound from the ear-phones, the recorded sound is monaural.
- Tracks recorded in 2 times long recording and 4 times long recording modes cannot be played with the unit that does not support these modes. On such a unit, "LP" is displayed at the beginning of the track and no sound is heard. (The operation and the display may vary depending on the unit.)
- Tracks recorded in monaural cannot be played if equipment does not support the monaural playback.

■ About ATRAC

The ATRAC (Adaptive TRansform Acoustic Coding) system compresses the sound data into 1/5 by cutting out the inaudible sound. Since the sound is selected based on psychoacoustics masking, the sound quality is not impaired. This unit is equipped with the ATRAC3 compressing system that can reduce the sound data to 1/10 or 1/20 of its original size. By employing this system, 2 times and 4 times long recordings are enabled in stereo mode.

■ About the recording mode

You can select the recording mode from stereo recording, 2 times long recording, 4 times long recording, and monaural recording. Recordable time varies depending on the recording mode. If the tracks are recorded on an 80-minute MiniDisc, its recording time changes as follows:

Indication	Recording mode	Recording time
No display	Stereo	MAX. 80 min.
LP2	2 times long (stereo)	MAX. 160 min.
LP4	4 times long (stereo)	MAX. 320 min.
MONO	Monaural	MAX. 160 min.

■ Caution for 4 times long recording (LP4)

Special compressing method allows the 4 times long recording to realise long-time stereo recording. Therefore, some noise is recorded occasionally. If sound quality should be emphasised, stereo recording or 2 times long recording is recommended.

Advanced Recording (continued)

■ Playback sound-actuated recording

Recording automatically starts or pauses by detecting sound from the stereo system (Synchronised recording).

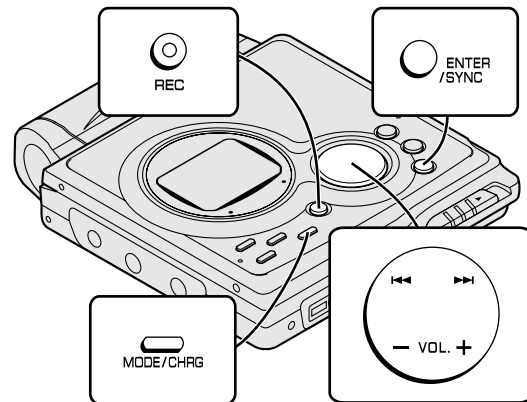

- 1 Press the REC button.**
- 2 Begin playback on the stereo system connected to this portable MD.**
- 3 Press the ◀◀ or ▶▶ button to adjust the recording level. (See page 12.)**

- 4 Press the PAUSE button on the stereo system to enter the playback pause mode.**

Select the starting point for your recording and press the PAUSE button.

- 5 Press the MODE/CHRG button repeatedly to select the recording mode (page 20).**

- 6 Press the ENTER/SYNC button.**

- "SYNC" will be displayed.
- To cancel the operation, press the ■:OFF button.

- 7 Begin playback on the stereo system. Recording will begin automatically.**

To interrupt recording

- When the stereo system is stopped, the unit will enter the synchro recording pause mode. When playback is resumed, the recording will be resumed.
- If a silence lasts for 3 seconds or more, the recording will be paused (pause function does not work for approximately 10 seconds after a recording starts). When the unit receives sound again, recording automatically starts.
- A new track number is created when the recording resumes.

■ To start recording from the middle of a track

You can erase a portion of a track and make a new recording. All of the tracks that follow the newly recorded track will be erased.

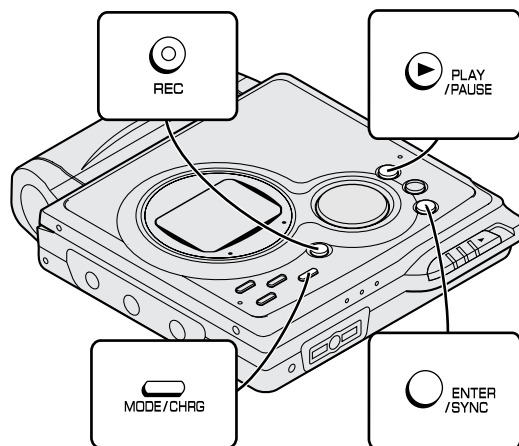

1 During playback, press the **PLAY/PAUSE** button at the point where you want to begin recording.

2 Press the **REC** button.

ERASE OK?

To cancel the operation, press the **■**:OFF button.

3 Press the **ENTER/SYNC** button.

All of the tracks and track names will be erased, following the point where the playback is paused.

4 Press the **MODE/CHRG** button repeatedly to select the recording mode (page 20).

5 Press the **PLAY/PAUSE** button.

Recording will start.

Note:

To keep a track after the point you want to make a new recording, move the track and then make recording after that point. (See "Editing a Recorded MiniDisc", page 42.)

Advanced Recording (continued)

■ To create your own track numbers

You can create your own track numbers at any point.

Whilst recording, press the REC button at the point where you want to create track numbers.

The track number will be increased by one.

One track number will be added every time the REC button is pressed.

■ Numbering restriction

If you try to number more than 10 tracks in certain amount of time, "SORRY" will be displayed and the operation will be disabled.

In that case, wait until the next operation can be resumed.

In stereo recording	Within 40 seconds
In 2 times long recording	Within 80 seconds
In 4 times long recording	Within 160 seconds
In monaural recording	Within 80 seconds

■ Recording tracks as a single track

You can record several pieces of music as a single track by disabling the auto marker function.

When a recording is paused or whilst recording...

Press the EDIT button.

AUTO MARK ↔ MARK OFF

Note:

When making digital recordings using a CD player or an MiniDisc player, track numbers will be created automatically regardless of the setting of the auto marker function.

■ About track numbers

1. Track numbers are created automatically during recording via the analogue connection when a silence of 1 second or more is detected (Auto marker function). A series of tracks can be recorded as one by disabling the auto marker function, see page 24.

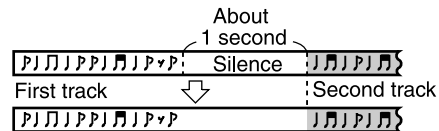

2. When recording from a CD or a MiniDisc using the digital connection, track numbers will be created at the same points as on the CD or MiniDisc (Synchro marker function).

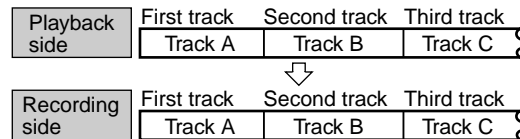

- Track numbers may not be created in proper places, depending on the source to be recorded from, such as signals with noise.
- The track numbers on the playback side may not match the track numbers recorded on the MiniDisc.

- When recording, if a programmed playback is performed by the source or playback is performed by selecting tracks manually, the MiniDisc track numbers may not be the same as on the source.
- Track numbers may not be created properly, depending on the connected stereo system.

Recording from a Microphone

- To record from a microphone

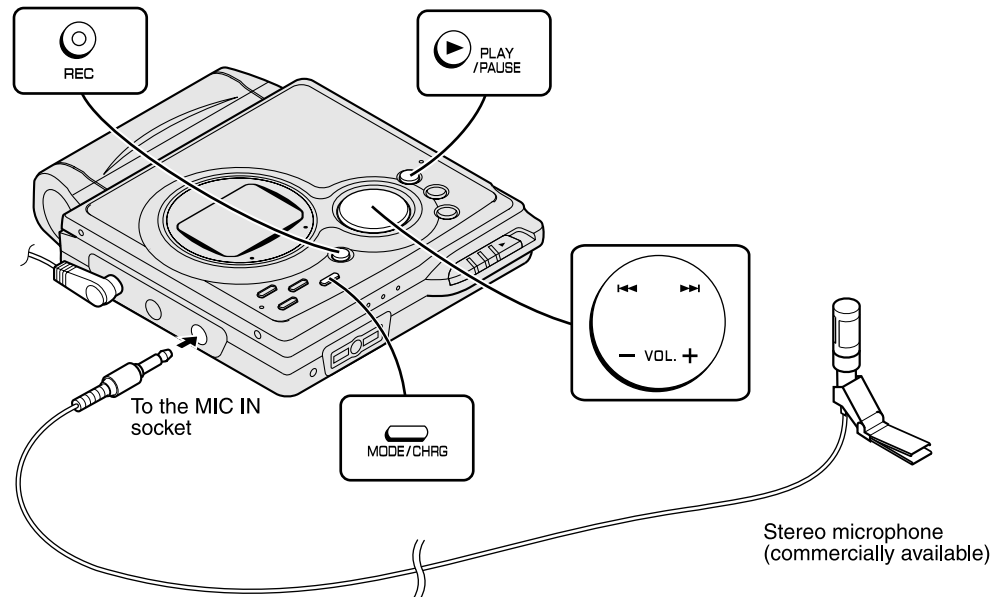

1 Connect a stereo microphone to the MIC IN socket.

2 Insert a recordable MiniDisc (page 9).

3 Press the REC button.

4 Press the ◀◀ or ▶▶ button to adjust the recording level.

Level meter indicator

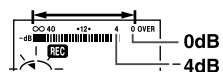

Adjust the recording level so that the maximum sound volume from the source makes the reading swing between -4 dB and 0 dB.

5 Press the MODE/CHRG button repeatedly to select the recording mode (page 20).

6 Press the PLAY/PAUSE button.

Recording will start.

To interrupt recording

Press the PLAY/PAUSE button whilst recording. To resume recording, press the PLAY/PAUSE button again. The track number will be increased by one each time you interrupt recording.

To stop recording

Press the ■/OFF button.

To write recorded contents on the MiniDisc

Press the ■/OFF button whilst in the stop mode.

Recording from a Microphone (continued)

■ Sound-actuated recording (Mic Synchronised recording)

- 1 Press the REC button.**
- 2 Press the ◀◀ or ▶▶ button to adjust the recording level.**

Level meter indicator

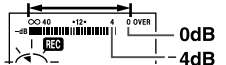
- 3 Press the MODE/CHRG button repeatedly to select the recording mode (page 20).**
- 4 Press the ENTER/SYNC button to select the recording sensitivity.**

MIC SYNC H :	Recording starts when the unit detects -24 dB or more (the unit can start recording from quiet sounds).
MIC SYNC L :	Recording starts when the unit detects -12 dB or more.
- 5 When a sound, such as person speaking, is picked up by the microphone, recording will begin automatically.**

About pause function

The unit automatically pauses when the microphone does not pick up any sound for 3 seconds or more. (Pause function does not work for approximately 10 seconds after a recording starts.) When the microphone picks up sound again, recording starts automatically.

Notes:

- Whilst making a mic recording, do not connect anything to the OPTICAL/LINE IN socket on the portable MD.
- To use a microphone, be sure it is a plug-in-power type microphone.
 - When a plug-in-power type microphone is plugged in, the portable MD will provide power for the microphone's operation.
 - If a different type of microphone is plugged in, it may not operate properly or it may cause the unit to malfunction.
- Insert the plug firmly. If you don't, the recording will not be made properly.
- Use a microphone with a 3.5 mm (1/8") diameter stereo mini plug.
- If the unit starts recording too often from low unwanted noises, set the microphone input to "MIC SYNC L".
- Recording sensitivity can be changed whilst recording.

■ Track intervals

When recording from the microphone, track numbers will be created automatically at regular intervals (default setting: approximately every 5 minutes). During a mic synchro recording, the unit pauses when a silence lasts for 3 seconds or more, and creates a track number.

Changing intervals between tracks

1 When a recording is paused or whilst recording, press the EDIT button repeatedly.

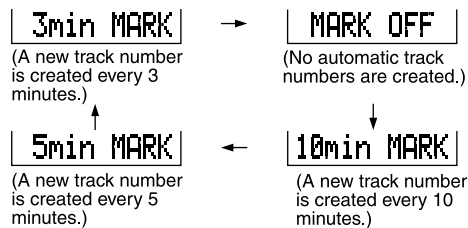

The interval between marks may vary slightly compared with the actual recording time.

2 Track numbers will be created automatically at regular intervals.

Example: Set to "5 minutes".

During a mic manual recording

Timed auto marks will be created every 5 minutes.

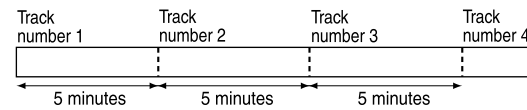

During a mic synchro recording

If a silence lasts for 3 seconds or more, a timed auto mark will be created 5 minutes after the previous mark is created.

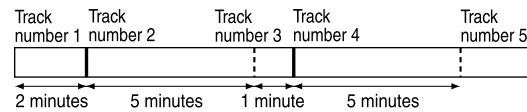
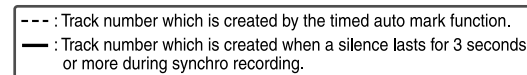

Creating track numbers manually

Press the REC button whilst recording.

Checking Displays

- To check the elapsed time and remaining time of the track

During playback, press the DISP button.

Each time the button is pressed, the display will change as follows.

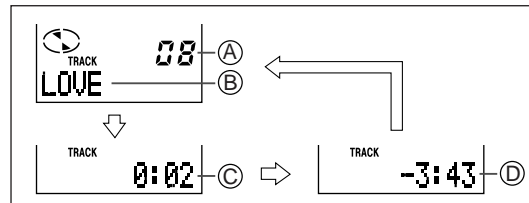

- (A) Track number
- (B) Track name
- (C) Elapsed playback time
- (D) Remaining playback time

Notes:

- If the disc name or the track name was not originally recorded on the MiniDisc, "NO NAME" will be displayed.
- Remaining recording time will not be displayed with a playback only MiniDisc.
- Elapsed playback time and remaining playback time may be different from the actual time.

- To check the remaining recording time and the total playing time

Whilst in the stop mode, press the DISP button.

Each time the button is pressed, the display will change as follows.

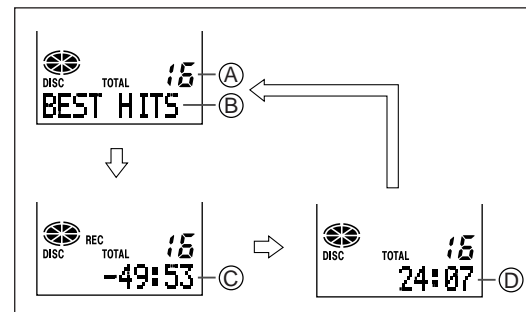

- (A) Total number of tracks
- (B) Disc name
- (C) Remaining recording time
- (D) Total playing time

Remaining recording time varies depending on the set recording mode.

■ To display the playing time of an individual track

1 Whilst in the stop mode, press the **◀◀** or **▶▶** button to display the track number and track name.

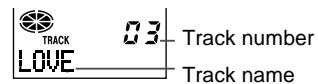

2 Press the **DISP** button to display the playing time for that track.



Each time the **◀◀** or **▶▶** button is pressed, the playing time of the previous or next track will be displayed.

■ Checking the remaining amount of battery level

The remaining amount of battery level is shown by the battery indicator () during operation.

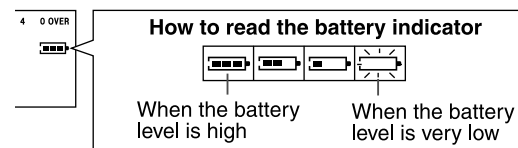

- When the battery is completely discharged, the battery indicator will flash. Recharge the battery or replace the alkaline battery with a new one.
- When the battery has run completely out, "BATT EMPTY" will appear. Then, the power will be disconnected automatically.

Notes:

- If you use the battery which you stopped charging halfway, "" may appear. It does not mean that the battery is completely charged.
- The battery indicator will not correctly display the remaining capacity for approximately 10 seconds after the power has been turned on.
- When the AC adaptor or a separately available car adaptor is used, the battery indicator will not be shown.
- The number of bars shown in the battery indicator may increase or decrease, depending on the operation being performed. This is normal.

Battery Power

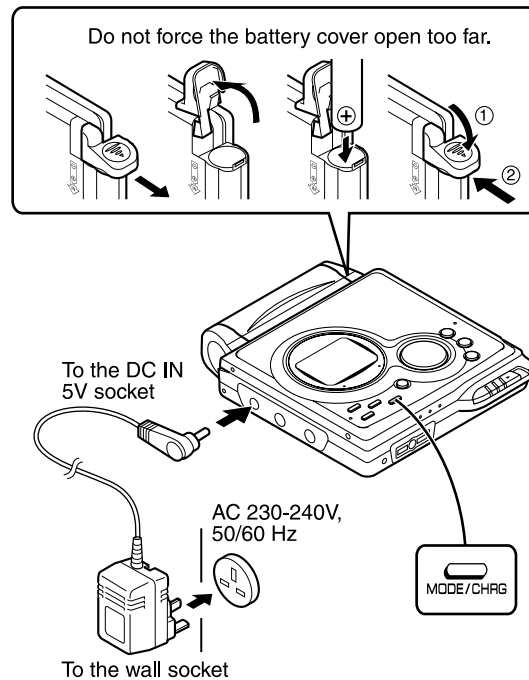

■ Charging the rechargeable battery

When a separately available rechargeable battery is used for the first time or when you use it after a long period of disuse, be sure to charge it fully.

1 Insert the rechargeable battery.

A rechargeable battery other than the AD-N70BT cannot be charged.

2 Plug the AC adaptor into the wall socket, and then insert the plug on the other end into the DC IN 5V socket.

3 Press the MODE/CHRG button.

"" will flash, and battery will begin charging.

- After the rechargeable battery is charged or used, it will get slightly warm. This is normal.
- When the portable MD is turned on or operating, the battery will not be charged.

■ About charging time

After about 3.5 hours have passed, "⎓" will go out. The battery charging is about 90 % complete.

To charge the battery fully, continue charging for about 2 more hours. In this case, you do not need to press the MODE/CHRG button. Even if the MODE/CHRG button is pressed, "⎓" will not appear.

Notes:

- Charge the battery within the range of 5°C - 35°C (41°F - 95°F).
- Charging is completed if "⎓" does not blink when you plug in the AC adaptor and press the MODE/CHRG button.
- The unit can be left in the charging state after it is completed.

Caution:

- Use the specified battery AD-N70BT only. Do not charge a battery (nickel-cadmium, alkaline, etc.) other than that specified.
- Do not remove the outer cover of the rechargeable battery. It may cause heat generation, fire, or explosion.
- Do not dip the battery in water, do not dispose of it in a fire, and do not take it apart.
- If the rechargeable battery terminal is dirty, charging may not start. In such a case, wipe off the dirt with a dry cloth.
- Do not disassemble the battery.



■ Using with the rechargeable or alkaline battery

1 Disconnect the AC adaptor.

2 Insert the rechargeable battery or alkaline battery from the (+) marked side.

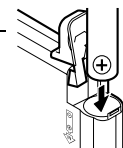

Use a commercially available LR6, "AA" size alkaline battery.

Notes:

- Setting the volume level to "0" whilst recording with the rechargeable or an alkaline battery reduces the battery drain.
- When you do not use the unit for hours, remove the battery. (The battery drains gradually even when the power is turned off.)
- This unit can be used with the AC adaptor when the rechargeable or an alkaline battery is in the unit.

Caution:

Do not use a nickel-cadmium battery.

Hold Function

The present operation condition can be kept even if other buttons are accidentally pressed in a place such as a crowded train.

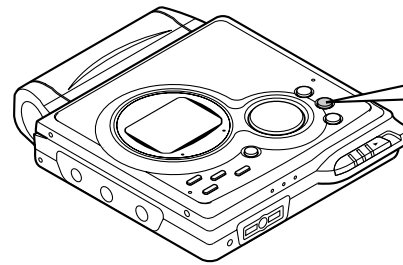

Press the HOLD button for 2 seconds or more.

HOLD ON

Hold

HOLD OFF

Release

If the battery is inserted or the AC adaptor is connected, you can set this function even when the power is turned off.

To cancel the hold mode

Press and hold down the HOLD button for 2 seconds or more whilst the unit is in the hold mode. "HOLD OFF" will be shown.

If the hold function is active whilst the power is turned off, the power cannot be turned on by mistake and the battery will not be drained.

Changing Default Settings

Whilst in the stop mode ...

1 With a MiniDisc inserted, press the MODE/CHRG button for 2 seconds or more. "SET UP" will appear.

When you release the button, "BEEP ON" or "BEEP OFF" will appear.

2 Press the ◀◀ or ▶▶ button to display the menu.

3 Press the MODE/CHRG button to switch items.

4 Press the ■:OFF button.

MENU	SETTING ITEM	
BEEP ON (Confirmation sound)	BEEP ON*	Beep
	BEEP OFF	Silent
A-PLAY ON (Auto play)	A-PLAY ON*	Setting
	A-PLAY OFF	Cancelled
AUTO Psave (Auto power save)	AUTO Psave*	Setting
	Psave OFF	Cancelled
D.L MODE 1 (Digital recording level)	D.L MODE 1*	Setting keep
	D.L MODE 2	Cancelled

(*) indicates default setting.

■ Beep sound

You can eliminate the confirmation sound that beeps when you press a button.

■ Auto play

You can make the unit not play automatically when you insert a playback-only MiniDisc or an accidental erasure protected MiniDisc.

■ Auto power save

When the unit is used in a place exposed to much vibration, sound skipping can be decreased by cancelling the auto power save function. (Battery will drain faster.)

What is auto power save function?

During playback, maximum 40 seconds (in stereo) of musical information is stored. Auto power save function automatically adjusts the storage time between 5 and 40 seconds to reduce the power consumption. If this function is cancelled, the storage time cannot be adjusted. (It cannot be adjusted even if it is operated on the battery charger.) The storage time varies depending on the playback mode.

■ Digital recording level

"D.L MODE 1"

The digital recording level you set will be kept even after cancelling recording.

"D.L MODE 2"

Every time you cancel recording, the level will return to [D.L 0dB].

Titling a MiniDisc

■ Creating disc and track names

Load a MiniDisc to be named. A playback only or recording prevented MiniDisc cannot be edited.

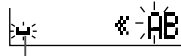
1	<Disc name>	<Track name>
	Whilst in the stop mode, press the EDIT button to select "DISC NAME".	Whilst in the pause mode, press the EDIT button to select "TRACK NAME".
	DISC NAME	TRACK NAME
2	Press the ENTER/SYNC button.	
		
	<ul style="list-style-type: none"> • The unit will enter the character input mode. • To cancel the operation, press the ■/OFF button. 	

3 Press the DISP button repeatedly to select the type of characters.

| select ABC |

ABC <small>(Capital letters)</small>	abc <small>(Lower-case letters)</small>	123 <small>(Numbers and symbols)</small>
---	--	---

The first 3 characters in the group of the selected characters will be displayed for about 1 second.

4 Press the ◀◀ or ▶▶ button repeatedly to select the letter.

◀◀ | AB | ▶▶ → ◀◀ | ABC | ▶▶

5 Press the ENTER/SYNC button to enter it.

| B | ◀◀ | ABC | ▶▶

Position where the next letter will be entered

- 6 To enter more letters, repeat steps 3 - 5.**
- 7 When the name has been completely entered, press the EDIT button.**
- 8 "TOC" will be displayed. To write the updated contents to the MiniDisc, press the **■/:**OFF button.**
- You cannot remove the MiniDisc whilst "TOC" is displayed. "TOC" will not disappear until the recorded contents have been updated.

Note:

One disc name and up to 255 track names can be created per disc (a maximum of 100 characters for the disc and each track name and a total of 1,700 characters can be entered. However, if any tracks are recorded in the 2 times or 4 times long recording mode, the number of characters to be entered is decreased, since the information of the recording mode is stored by the track).

■ To erase a character

Press the VOL+ or VOL- button to move the cursor to the character you want to erase, and then press the BASS button.

■ To enter a space

Press the VOL+ button to move the cursor to the right.

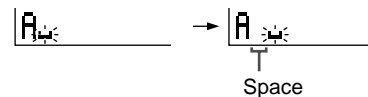

■ Characters (symbols)

Capital letters																										
<input type="checkbox"/>	<input type="checkbox"/>	<input type="checkbox"/>	<input type="checkbox"/>	<input type="checkbox"/>	<input type="checkbox"/>	<input type="checkbox"/>	<input type="checkbox"/>	<input type="checkbox"/>	<input type="checkbox"/>	<input type="checkbox"/>	<input type="checkbox"/>	<input type="checkbox"/>	<input type="checkbox"/>	<input type="checkbox"/>	<input type="checkbox"/>	<input type="checkbox"/>	<input type="checkbox"/>	<input type="checkbox"/>	<input type="checkbox"/>	<input type="checkbox"/>	<input type="checkbox"/>	<input type="checkbox"/>	<input type="checkbox"/>	<input type="checkbox"/>	<input type="checkbox"/>	<input type="checkbox"/>
<input type="checkbox"/>	<input type="checkbox"/>	<input type="checkbox"/>	<input type="checkbox"/>	<input type="checkbox"/>	<input type="checkbox"/>	<input type="checkbox"/>	<input type="checkbox"/>	<input type="checkbox"/>	<input type="checkbox"/>	<input type="checkbox"/>	<input type="checkbox"/>	<input type="checkbox"/>	<input type="checkbox"/>	<input type="checkbox"/>	<input type="checkbox"/>	<input type="checkbox"/>	<input type="checkbox"/>	<input type="checkbox"/>	<input type="checkbox"/>	<input type="checkbox"/>	<input type="checkbox"/>	<input type="checkbox"/>	<input type="checkbox"/>	<input type="checkbox"/>	<input type="checkbox"/>	<input type="checkbox"/>
Lower-case letters																										
<input type="checkbox"/>	<input type="checkbox"/>	<input type="checkbox"/>	<input type="checkbox"/>	<input type="checkbox"/>	<input type="checkbox"/>	<input type="checkbox"/>	<input type="checkbox"/>	<input type="checkbox"/>	<input type="checkbox"/>	<input type="checkbox"/>	<input type="checkbox"/>	<input type="checkbox"/>	<input type="checkbox"/>	<input type="checkbox"/>	<input type="checkbox"/>	<input type="checkbox"/>	<input type="checkbox"/>	<input type="checkbox"/>	<input type="checkbox"/>	<input type="checkbox"/>	<input type="checkbox"/>	<input type="checkbox"/>	<input type="checkbox"/>	<input type="checkbox"/>	<input type="checkbox"/>	<input type="checkbox"/>
<input type="checkbox"/>	<input type="checkbox"/>	<input type="checkbox"/>	<input type="checkbox"/>	<input type="checkbox"/>	<input type="checkbox"/>	<input type="checkbox"/>	<input type="checkbox"/>	<input type="checkbox"/>	<input type="checkbox"/>	<input type="checkbox"/>	<input type="checkbox"/>	<input type="checkbox"/>	<input type="checkbox"/>	<input type="checkbox"/>	<input type="checkbox"/>	<input type="checkbox"/>	<input type="checkbox"/>	<input type="checkbox"/>	<input type="checkbox"/>	<input type="checkbox"/>	<input type="checkbox"/>	<input type="checkbox"/>	<input type="checkbox"/>	<input type="checkbox"/>	<input type="checkbox"/>	<input type="checkbox"/>
Numbers and symbols																										
<input type="checkbox"/>	<input type="checkbox"/>	<input type="checkbox"/>	<input type="checkbox"/>	<input type="checkbox"/>	<input type="checkbox"/>	<input type="checkbox"/>	<input type="checkbox"/>	<input type="checkbox"/>	<input type="checkbox"/>	<input type="checkbox"/>	<input type="checkbox"/>	<input type="checkbox"/>	<input type="checkbox"/>	<input type="checkbox"/>	<input type="checkbox"/>	<input type="checkbox"/>	<input type="checkbox"/>	<input type="checkbox"/>	<input type="checkbox"/>	<input type="checkbox"/>	<input type="checkbox"/>	<input type="checkbox"/>	<input type="checkbox"/>	<input type="checkbox"/>	<input type="checkbox"/>	<input type="checkbox"/>
<input type="checkbox"/>	<input type="checkbox"/>	<input type="checkbox"/>	<input type="checkbox"/>	<input type="checkbox"/>	<input type="checkbox"/>	<input type="checkbox"/>	<input type="checkbox"/>	<input type="checkbox"/>	<input type="checkbox"/>	<input type="checkbox"/>	<input type="checkbox"/>	<input type="checkbox"/>	<input type="checkbox"/>	<input type="checkbox"/>	<input type="checkbox"/>	<input type="checkbox"/>	<input type="checkbox"/>	<input type="checkbox"/>	<input type="checkbox"/>	<input type="checkbox"/>	<input type="checkbox"/>	<input type="checkbox"/>	<input type="checkbox"/>	<input type="checkbox"/>	<input type="checkbox"/>	<input type="checkbox"/>

: indicates a space.

Titling a MiniDisc (continued)

■ To add characters

- 1 Put the unit in the character input mode.**
(Perform steps 1 - 2 on page 36.)
- 2 Press the VOL + or VOL - button to move the cursor to the character before which you want to add a new character.**

|BST «-AB|
- 3 Select the character to add.**
(Perform steps 3 - 4 on page 36.)
- 4 Press the ENTER/SYNC button.**
- 5 Press the EDIT button.**
- 6 "TOC" will be displayed. To write the updated contents to the MiniDisc, press the ■:OFF button.**

You cannot remove the MiniDisc whilst "TOC" is displayed. "TOC" will not disappear until the recorded contents have been updated.

■ Stamping titles from another MiniDisc

Before stamping

When there are 2 MiniDiscs on which the same tracks are recorded, you can transfer the character information (disc and track names) of the Master MiniDisc to another MiniDisc (for stamping).

1. What is a master MiniDisc?

A recordable MiniDisc that contains tracks and character information. (You cannot transfer the information from a playback-only MiniDisc.)

2. What is a MiniDisc for stamping?

A MiniDisc that contains the same tracks in the same order as the master MiniDisc. (Make sure that the total number of tracks of the master MiniDisc and the one for stamping are the same.)

Master MiniDisc operation

1 Insert a Master MiniDisc.

Do not mistake the Master MiniDisc for the target one.

2 Whilst in the stop mode, press the EDIT button to select "NAME STAMP".

NAME STAMP

3 Press the ENTER/SYNC button.

READ OK?

To cancel the operation, press the ■:OFF button.

4 Press the ENTER/SYNC button again.

Reading! | CHANGE MD

5 When the unit displays "CHANGE MD", remove the master MiniDisc.

Remove it without turning off the power. Or, the operation will be cancelled.

Operation of the MiniDisc for stamping

6 Load a MiniDisc for stamping.

INSERT MD | TOC READ
WRITE OK?

7 Press the ENTER/SYNC button.

Writing! | COMPLETE

The unit will finish recording the character information and enter the stop mode.

Note:

If the total number of tracks on the master MiniDisc does not match that on the MiniDisc for stamping, the unit will display "Can'tSTAMP" and turn off the power.

Can'tSTAMP

If this happens, adjust the total number of tracks on the newly recorded MiniDisc using the edit operation.

Editing a Recorded MiniDisc

■ To erase tracks one at a time

1 Start playing the track to be erased, and press the PLAY/PAUSE button.

2 Press the EDIT button repeatedly to select "ERASE".

ERASE 03

3 Press the ENTER/SYNC button.

ERASE 03?

To cancel the operation, press the ■/OFF button.

4 Press the ENTER/SYNC button again.

The track will be erased.

5 To erase other tracks, repeat steps 1 - 4.

■ To erase all of the tracks at once

1 Whilst in the stop mode, press the EDIT button repeatedly to select "ALL ERASE".

ALL ERASE

2 Press the ENTER/SYNC button.

ERASE OK?

To cancel the operation, press the ■/OFF button.

3 Press the ENTER/SYNC button again.

BLANK MD

All of the tracks will be erased.

Caution:

Once a track has been erased, it cannot be recovered. Check the track number before erasing it.

■ To divide a track

1 Start playing the track to be divided into two. Press the PLAY/PAUSE button at the point where you want to divide the track.

2 Press the EDIT button repeatedly to select "DIVIDE".

DIVIDE

3 Press the ENTER/SYNC button.

DIVIDE OK?

To cancel the operation, press the ■:OFF button.

4 Press the ENTER/SYNC button again.

The track will be divided into two tracks, and the unit will pause at the beginning of the second of the two new tracks.

■ To combine tracks

1 Start playing the last of the two tracks to be combined, and press the PLAY/PAUSE button.

2 Press the EDIT button repeatedly to select "COMBINE".

COMBINE

3 Press the ENTER/SYNC button.

05+ 06 ?

To cancel the operation, press the ■:OFF button.

4 Press the ENTER/SYNC button again.

The two tracks will be combined, and the unit will be paused at the beginning of the combined track.

Editing a Recorded MiniDisc (continued)

■ To move a track

1 Play the track to be moved, and press the PLAY/PAUSE button.

2 Press the EDIT button repeatedly to select "MOVE".

MOVE

3 Press the ENTER/SYNC button.

05→ 01 ?

To cancel the operation, press the ■/OFF button.

4 Press the ◀◀ or ▶▶ button to select the direction.

05→ 03 ?

5 Press the ENTER/SYNC button again.

The track will be moved, and the unit will be paused at the beginning of the track.

When a track has a name before dividing:

The two new tracks will have the same name. However, in the "TOC FULL" condition, the second track may not be named.

Total number of tracks that can be divided:

Each disc can hold up to 255 tracks. However, even if the number of assigned tracks has not reached 254, it might not be possible to make any further divisions of tracks.

To combine two non-adjacent tracks:

First, put the two tracks next to each other in the order you want using the MOVE function. Then combine them using the COMBINE function.

When one or both tracks to be combined have a name:

The first track name will be used. However, when the first track does not have a name, the second track name will be used.

In the following cases, tracks may not be combined.

- Tracks recorded by different inputs cannot be combined.
- Example:
- Digital recorded track and analogue recorded track.
 - Different recording modes (stereo recording, 2 times long recording, 4 times long recording, monaural recording).
 - Tracks whose recording time is less than 12 seconds.

Listening through Another System

■ Listening through a stereo system

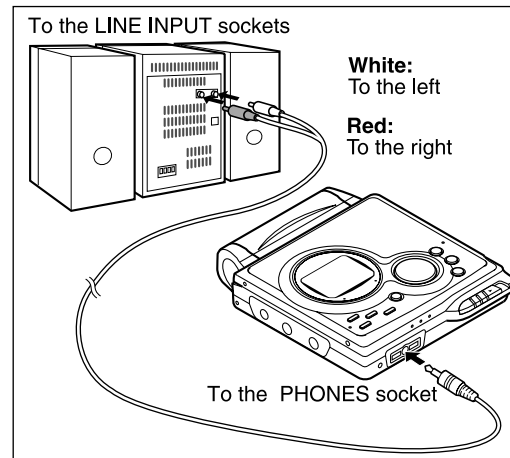

Notes:

- It is recommended that the volume level of the MiniDisc unit be set to maximum when listening through a stereo system.
- When recording with stereo system, eliminate the confirmation sound (page 35). Otherwise, it will also be recorded.
- The recording will be made in the analogue mode.
- Character information will not be recorded.

■ Listening through a car stereo

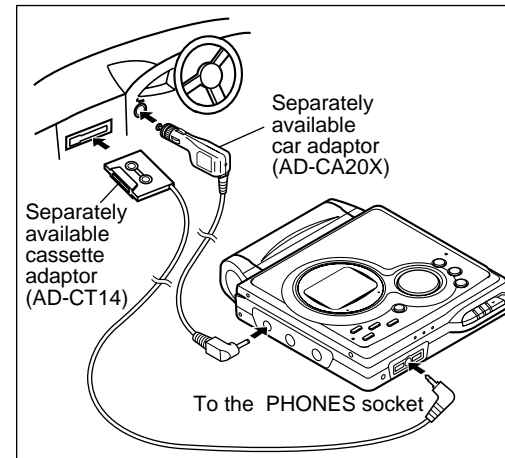

Notes:

- Adjust the volume of both this portable MD and a car stereo.
- Do not operate this portable MD whilst you drive a car. It may distract your attention and cause a traffic accident.
- Do not use any car adaptor except for the separately available AD-CA20X.
- Remove the battery when you power the unit from the car battery.

Web-site: www.sharp.co.uk/support Help Line: 08705 274277 (office hours)

43

Advanced Features
-Listening through Another System-

Other Features and Caution

■ Resuming auto play

When you stop playback and replay the MiniDisc without removing it, playback starts from the point you stopped it.

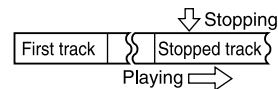

Once you remove the MiniDisc, playback starts from the first track.

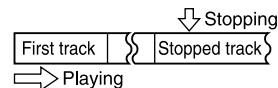

The unit provides the following functions when you use it with the separately available car adaptor (AD-CA20X) (when the rechargeable or alkaline battery is removed):

1. When you turn off the engine, the power of this portable MD also turns off. (It may not work with some types of cars.)
2. When you restart the engine, playback starts from the beginning of the stopped track.

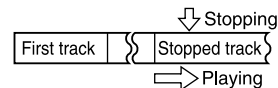

■ Rechargeable battery

- A rechargeable nickel-metal hydride battery is the only kind that can be used. Even if the battery is not used, you should charge it at least once every three months because of the special quality of this battery.
- The rechargeable battery can be charged approximately 300 times.
- When the operating time is reduced to about half the normal amount of time, even after a full charge is performed, replace the battery with a new one (AD-N70BT).
- When the battery is charged for the first time or is charged after not being used for a long period, the operating time may be shorter than normal. The battery life will recover with normal use i.e. charging and discharging.
- To avoid shortening the service life of the battery only recharge the battery after it has been completely discharged.
- If the rechargeable battery is used in a cold environment, the operating time will be reduced.
- Do not carry the battery in your pocket or a bag together with metal objects (keys, coins, jewelry, etc.). The battery may short out and generate significant amounts of heat.
- Do not short-circuit the terminals as they will become very hot and will damage the battery.
- Do not drop or subject the battery to shock.
- Do not insert objects (metal etc.) into the battery compartment of this product or into the rechargeable battery.

MiniDisc System Limitations

The unit may have the following symptoms whilst recording or editing. The unit is not out of order.

SYMPTOM	LIMITATIONS
"DISC FULL" or "TOC FULL" appears even though the MiniDisc still has recording time left.	More than 255 tracks (maximum) cannot be recorded regardless of the recording time. If the MiniDisc is recorded or edited repeatedly or if it has scratches (recording skips scratched parts), you may not be able to record the maximum tracks above.
The remaining recording time does not increase even though you erased tracks.	The unit does not count non-recorded portions that last 12 or fewer seconds to display the remaining recording time. The time may not increase even if you erase short tracks.
The total of the recorded time and the remaining time does not match the maximum recordable time.	One cluster (approximately 2 seconds) is the minimum unit for recording. For example, a 3-second track uses 2 clusters (approximately 4 seconds). Therefore, the actual recordable time may be shorter than the displayed time.
Combine function does not work.	A MiniDisc on which recording and editing are repeated may not allow the combine function.
Sound skips in fast reverse/forward.	One track is divided and recorded in separate places on a repeatedly recorded or edited MiniDisc. Sound may skip.
A track number is created in the middle of a track.	A track number may be created if there are scratches or dust on the MiniDisc.

Web-site: www.sharp.co.uk/support **Help Line:** 08705 274277 (office hours)

Error Messages

ERROR MESSAGES	MEANING
BATT EMPTY	● The battery has run down.
BLANK MD	● Nothing is recorded. (Replace the disc with a recorded disc.)
Can't COPY	● You tried to record from a copy prohibited MiniDisc. ● You tried to record signals other than music (such as data). (Record using the analogue cable.)
Can't EDIT	● A track cannot be edited. (Change the stop position of the track and then edit it.)
Can't READ (*)	● The disc data cannot be read because the disc or unit is damaged. (Reload the Minidisc or replace it with another one.)
Can't REC	● Recording cannot be performed correctly due to vibration or shock.
Can't STAMP	● Stamp function does not work. (Check the number of tracks.)

ERROR MESSAGES	MEANING
Can't WRITE	● Cannot save the TOC information correctly to a MiniDisc.
DEFECT	● The disc is scratched. (If the recorded sound is not right, retry recording or replace the disc with a recordable one.)
DISC FULL	● The disc is out of recording space.
Er-MD (**)	● The microprocessor has reported a system fault and the unit is out of order. (To have it repaired, go to the distributor where you purchased the unit.)
HOLD	● The unit is in the hold mode.
LOCKED	● You removed a MiniDisc whilst recording or editing. (Turn off the power and remove the MiniDisc.)
NO DISC	● A disc has not been loaded.

Number or symbol appears in (*) position.

ERROR MESSAGES	MEANING
NO SIGNAL	<ul style="list-style-type: none"> Poor connection of the digital cable. No output signal comes out from the connected unit to playback. <p>(Use the AC power for the connected unit.)</p> <ul style="list-style-type: none"> The input signal has improper sampling frequency.
NOT PLAY	<ul style="list-style-type: none"> You tried to play back a track that cannot be played with this equipment.
PLAY MD	<ul style="list-style-type: none"> You recorded on a playback-only disc.
POWER ?	<ul style="list-style-type: none"> Improper power is being supplied.
PROTECTED	<ul style="list-style-type: none"> The write protection tab of a MiniDisc is set to the protected position. You tried to record on a playback-only disc.
SORRY	<ul style="list-style-type: none"> Since a track number is currently being located or updated, the unit cannot accept your command. <p>(Wait for a whilst and try the operation again.)</p>

ERROR MESSAGES	MEANING
TEMP OVER	<ul style="list-style-type: none"> The temperature is too high. <p>(Turn off the power, and wait for a whilst.)</p>
TOC FORM (**)	<ul style="list-style-type: none"> There is an error in the recording signal. <p>(Erase all of the tracks, and then record again.)</p>
TOC FULL	<ul style="list-style-type: none"> There is no space left for recording character information (track names, disc names, etc.).
Tr. Protect	<ul style="list-style-type: none"> The track has been protected from being erased. <p>(Edit the track with the device on which it was recorded.)</p>
? DISC	<ul style="list-style-type: none"> A disc which contains data other than music was played. <p>(A disc which contains nonmusic data cannot be played.)</p> <ul style="list-style-type: none"> There is an error in the signal recorded on the disc.

Number or symbol appears in (*) position.

Web-site: www.sharp.co.uk/support **Help Line:** 08705 274277 (office hours)

Troubleshooting

Many potential "problems" can be resolved by the owner without calling a service technician. If something seems to be wrong with this product, check the following before calling your authorised SHARP dealer or service centre.

The unit does not turn on.

- Is the AC adaptor disconnected?
- Is the battery exhausted?
- Is the unit in the hold mode?
- Has condensation formed inside the unit?
- Is the unit being influenced by mechanical shock or by static electricity?

No sound is heard from the earphones.

- Is the volume set too low?
- Is the earphones plugged in?
- Are you trying to play a MiniDisc with data on it instead of a MiniDisc containing music?

When the operation buttons are pressed, the unit does not respond.

- Is the unit in the hold mode?
- Is the battery exhausted?
- Is the earphones plug inserted firmly?

Some sounds are skipped.

- Is the battery exhausted?
- Is the unit being subjected to excessive vibration?

The MiniDisc cannot be ejected.

- Has the track number or character information been written on the disc yet?
- Is the unit in the recording or editing mode?

Recording and editing are impossible.

- Is the MiniDisc protected against accidental erasure?
- Is the unit connected properly to the other equipment?
- Is the AC adaptor unplugged or did a power failure occur whilst recording or editing?
- Is the unit in the hold mode?
- Is an optical signal being output from the stereo system? Read the operation manual for the stereo system.

■ If trouble occurs

When this product is subjected to strong external interference (mechanical shock, excessive static electricity, abnormal supply voltage due to lightning, etc.) or if it is operated incorrectly, it may malfunction.

If such a problem occurs, do the following:

1. Unplug the AC adaptor from the wall socket.
2. Remove the battery.
3. Leave the unit completely unpowered for approximately 30 seconds.
4. Plug the AC adaptor back into the wall socket and re-operate the unit.

■ Moisture condensation

When the unit has condensation inside, the disc signals cannot be read, and the unit may not function properly.

In the following cases, condensation may form inside the unit.

- Shortly after turning on a heater.
- When the unit is placed in a room where there is excessive steam or moisture.
- When the unit is moved from a cool place to a warm place.

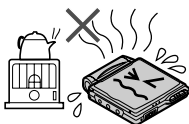

To remove condensation:

Remove the MiniDisc and leave the unit for approximately 1 hour. The condensation should evaporate and the unit will work properly.

Maintenance

■ Cleaning

When the unit becomes dirty

Clean it with a soft cloth. When the unit is excessively dirty, use a soft cloth dampened in water (external surfaces only).

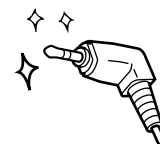

Clean the plugs and the connecting sockets.

If the plugs or sockets are dirty, noise may be heard. Cleaning will prevent noise.

Caution:

- Do not use chemicals for cleaning (petrol, paint thinner, etc.). It may damage the cabinet finish.
- Do not apply oil to the inside of the unit. It may cause malfunctions.

Specifications

As a part of our policy of continuous improvement, SHARP reserves the right to make design and specification changes for product improvement without prior notice. The performance specification figures indicated are nominal values of production units. There may be some deviations from these values in individual units.

Power source:	DC 5 V: AC adaptor (AC 230-240 V, 50/60 Hz) DC 1.5 V: Commercially available, "AA" size (LR6), alkaline battery x 1 DC 1.2 V: Optional rechargeable Nickel-Metal Hydride battery (AD-N70BT) x 1 DC 4.5 V: Optional car adaptor, AD-CA20X (for cars with a 12-24 V DC negative earth electrical system)
Power consumption:	7 W (AC adaptor)
Output power:	RMS: 20 mW (10 mW + 10 mW) (0.2 % T.H.D.)
Charging time:	Approx. 3.5 hours (90 %) Approx. 5.5 hours (fully charged)(When using the AC adaptor included with the unit)
Dimensions:	Width: 81.1 mm (3-7/32") Height: 19.9 mm (13/16") Depth: 92.4 mm (3-21/32")
Weight:	147 g (0.32 lbs.) without battery
Input socket:	Line/optical digital, microphone (powered by the main unit)
Output socket:	Earphones (impedance: 32 ohms)
Type:	Portable MiniDisc recorder
Signal readout:	Non-contact, 3-beam semiconductor laser pickup
Audio channels:	Stereo 2 channels/monaural 1 channel
Frequency response:	20 - 20,000 Hz (± 3 dB)
Rotation speed:	Approx. 400 - 900 rpm
Error correction:	ACIRC (Advanced Cross Interleave Reed-Solomon Code)
Coding:	ATRAC/ATRAC3 (Adaptive Transform Acoustic Coding), 24-bit computed type
Recording method:	Magnetic modulation overwrite method
Sampling frequency:	44.1 kHz (32 kHz and 48 kHz signals are converted to 44.1 kHz, and then recorded.)
Wow and flutter:	Unmeasurable (less than ± 0.001 % W. peak)

Battery life:

	Stereo		2 times long		4 times long	
When using the optional rechargeable battery (fully charged)	Continuous recording: Approx. 7.5 hours	Continuous play: Approx. 13 hours	Continuous recording: Approx. 10.5 hours	Continuous play: Approx. 15.5 hours	Continuous recording: Approx. 13.5 hours	Continuous play: Approx. 17.5 hours
When using a commercially available, high capacity, "AA" size (LR6), alkaline battery	Continuous recording: Approx. 3 hours	Continuous play: Approx. 15 hours	Continuous recording: Approx. 4.5 hours	Continuous play: Approx. 17.5 hours	Continuous recording: Approx. 7 hours	Continuous play: Approx. 20 hours

Input sensitivity:

Recording level	Reference input level	Input impedance
MIC H	0.25 mV	10 k ohms
MIC L	2.5 mV	10 k ohms
LINE	100 mV	20 k ohms

Output level:

	Specified output	Maximum output level	Load impedance
Earphones	-	10 mW + 10 mW	32 ohms
LINE	250 mV (-12 dB)	-	10 k ohms

- The above values are the standard values when the unit is operated horizontally and charged at an ambient temperature of 25°C (77°F). (The operable duration with the rechargeable battery will be shorter when the unit is carried around.)
- The volume level is set at "VOL 15".
- Operable duration with a commercially available battery varies depending on its maker, type, and conditions of use.
- "Fully charged" means that the charging is complete after approximately 3.5 hours since the remaining amount of the battery is reduced to "▢" (1 bar).

Web-site: www.sharp.co.uk/support **Help Line:** 08705 274277 (office hours)

51



TERMS OF GUARANTEE

Subject to the terms listed below, Sharp Electronics (U.K.) Ltd. (hereinafter called "the Company") guarantee to provide for the repair of, or at its option replace this Sharp Equipment, or any component thereof, (other than batteries), which is faulty or below standard, as a result of inferior workmanship or materials.

The conditions of this guarantee are:

1. The guarantee shall only apply to defects which occur within one year from the date of purchase, provided that this equipment is sent to the repair address within this period.
2. This guarantee covers equipment intended for private domestic use only. This guarantee does not apply to equipment used in the course of a business, trade or profession.
3. The guarantee does not cover MiniDiscs or batteries.
4. This guarantee does not cover any faults or defects caused by accident, misuse, fair wear and tear, neglect, tampering with the equipment, or any attempt at adjustment or repair other than by a Service Facility appointed by Sharp.
5. In the unlikely event of a defect occurring, the product must be returned to the Company's repair centre with proof of purchase. A postage paid label and a fault report form are supplied with the product for this purpose. It is your responsibility to ensure that the packaging is adequate, and to obtain proof of posting. Further details of the repair service, which is available after the guarantee period on a chargeable basis, and additional report forms and labels can be obtained by telephoning 0870 738 0000.
6. No person has any authority to vary the terms or conditions of this guarantee.
7. This guarantee is offered as an additional benefit to the consumer's statutory rights and does not affect these rights in any way.

SHARP

SHARP ELECTRONICS (U.K.) LTD.

Sharp House, Thorp Road, Newton Heath, Manchester, M40 5BE

SHARP CORPORATION

TINSE0383AWZZ

A0104.TO

Free Manuals Download Website

<http://myh66.com>

<http://usermanuals.us>

<http://www.somanuals.com>

<http://www.4manuals.cc>

<http://www.manual-lib.com>

<http://www.404manual.com>

<http://www.luxmanual.com>

<http://aubethermostatmanual.com>

Golf course search by state

<http://golfingnear.com>

Email search by domain

<http://emailbydomain.com>

Auto manuals search

<http://auto.somanuals.com>

TV manuals search

<http://tv.somanuals.com>