

## Accessories

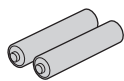

Remote control unit



Two "AA" size batteries



AC cord

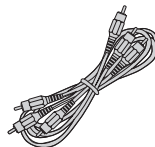

AV cable

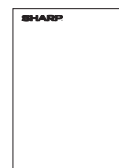

Operation Manual



Quick start guide

## How to install the batteries

- 1 Hold in the tab on the battery cover and pull the cover towards the direction of the arrow.
- 2 Load the two R-06 size batteries ("AA" size, UM/SUM-3). Place batteries with their terminals corresponding to the  $\oplus$  and  $\ominus$  indications in battery compartment.
- 3 Insert the smaller tab of the battery cover into the opening ①, and press down on the cover until it clicks in place ②.

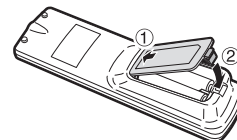
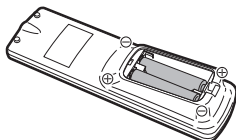
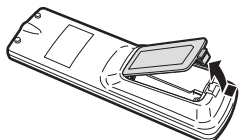

## Connection

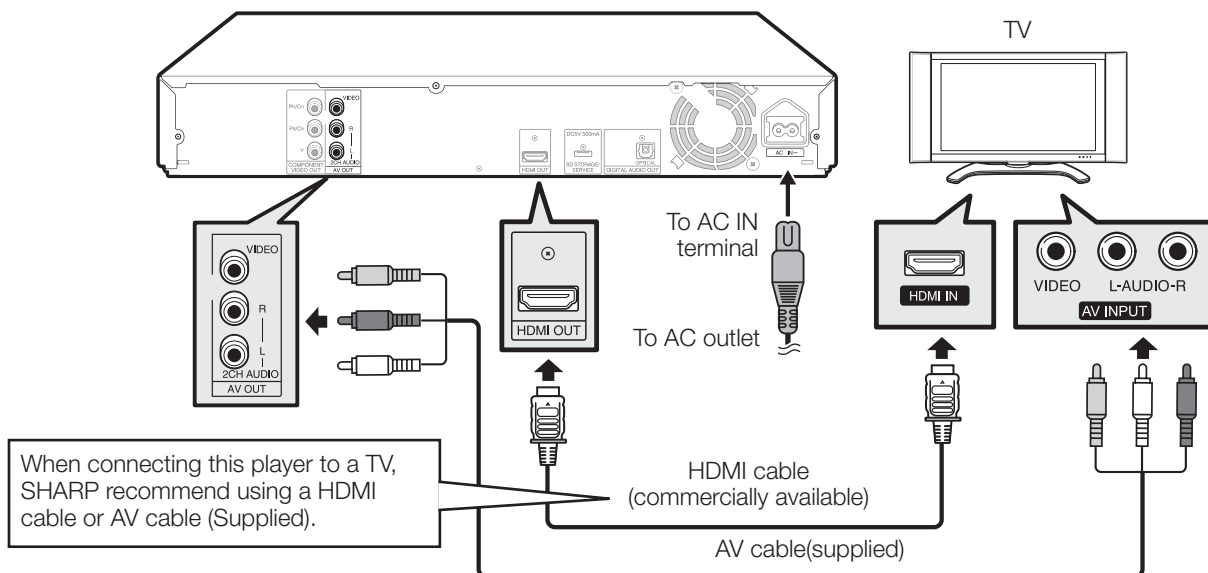

**Note:**  
For HDMI output settings, refer to page 15 of the operation manual.  
When connecting with a component video cable, refer to page 16 of the operation manual.

## Turn on the player and TV

After you have connected the AC cord to the unit, connect the AC cord to the mains. Turn on your TV and switch to the appropriate AV input (Refer to your TV's operation manual). (This may be labeled HDMI/EXT/AUX etc.)

⏻ (POWER)

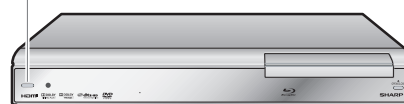

## Setup menu

The SETUP MENU consists of several menus where you can make various settings concerning language, audio functions, images, etc.

The following setting is basic process. There are procedures over the key-guide of each menu indicated below.

### Preparation:

- Turn on your TV and switch to the appropriate AV input (Refer to your TV's operation manual).
- If you are playing a BD / DVD, press the STOP button.

### Example:

**1** Press **SETUP** to display the SETUP MENU screen.

**2** Press **▲/▼/◀/▶** / to select "SETTINGS", then press **ENTER**.

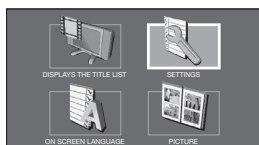

**3** Press **▲/▼** to select "AUDIO VIDEO SETTING", then press **ENTER**.

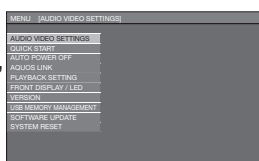

**4** Press **▲/▼** to select "TV ASPECT RATIO", then press **ENTER**.

**5** Press **◀/▶** to select the desired item, then press **ENTER**.

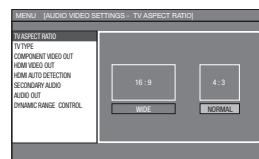

**6** Press **◀/▶** to select the desired format, then press **ENTER**.

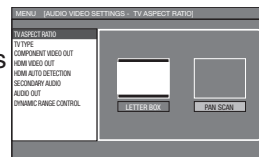

**7** Press **SETUP** or **EXIT** to exit.

## Loading and playing a BD/DVD

Before loading a disc, check to ensure the media type is supported by this player. (Refer to the Operation Manual for more information about supported discs.)

### Getting started

Turn on the power of the TV, amplifier and other equipment that is connected to this player.

Make sure the TV and audio receiver (commercially available) are switched to the correct input.

This Player's region code is **B** for BD and **2** for DVD. (Discs marked **ALL** will play in any player.)

1. Press **⏻** | to turn on the power.
2. Press **OPEN/CLOSE** to open the disc tray.

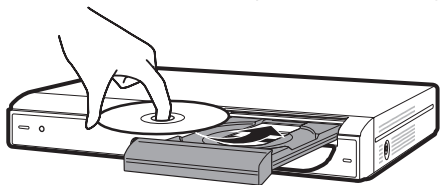

3. Load a disc into the tray with the printed side facing up.
4. Press **OPEN/CLOSE** to close the disc tray.
5. Press **▶ PLAY**.
6. Press **■ STOP** to stop/pause playback.  
Press **▶ PLAY** to resume playback.
7. Press **■ STOP** twice to stop playback.

## BD/DVD playback using the Disc Menu

BD/DVD disc menu options are listed in the top menu or disc guide (Options such as subtitles, audio languages).

### Start playback by selecting a title from the top menu (BD/DVD VIDEO)

- 1 Press **TOP MENU/TITLE LIST**.
- 2 Press **▲/▼/◀/▶** to select the title, then press **ENTER**.

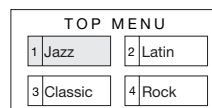

### Using the disc menu (DVD VIDEO)

- 1 Press **POP-UP MENU**.
- 2 Press **▲/▼** to select "SUBTITLE LANGUAGE", then press **ENTER**.
- 3 Press **▲/▼** to select the subtitle language, then press **ENTER**.
- 4 Press **SETUP** or **EXIT** to exit.

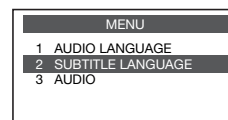

### Using the pop-up menu (BD VIDEO)

- 1 Press **POP-UP MENU** during playback.
- 2 Press **▲/▼/◀/▶** to select the desired item, then press **ENTER**.
- 3 Press **POP-UP MENU** to exit.

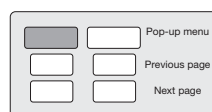

## Free Manuals Download Website

<http://myh66.com>

<http://usermanuals.us>

<http://www.somanuals.com>

<http://www.4manuals.cc>

<http://www.manual-lib.com>

<http://www.404manual.com>

<http://www.luxmanual.com>

<http://aubethermostatmanual.com>

Golf course search by state

<http://golfingnear.com>

Email search by domain

<http://emailbydomain.com>

Auto manuals search

<http://auto.somanuals.com>

TV manuals search

<http://tv.somanuals.com>