

Cordless TV Listening System Set 830-TV

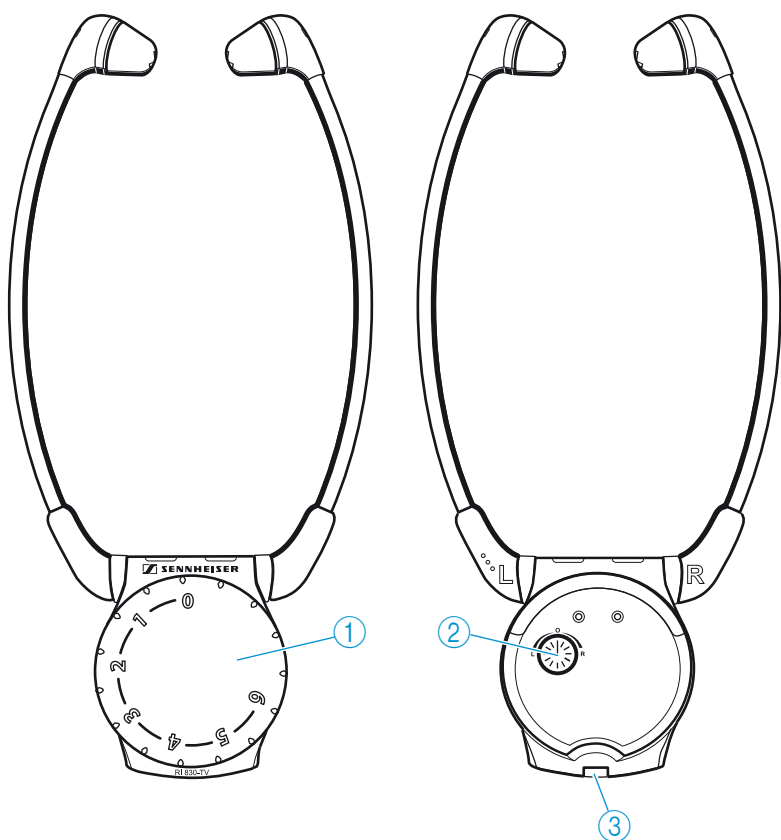

Instruction manual

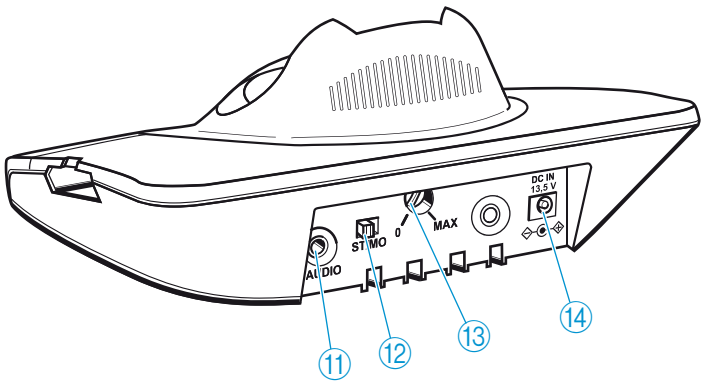

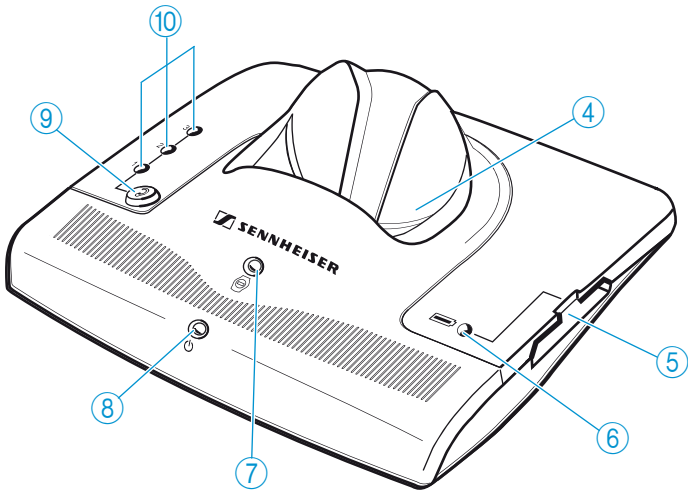

Contents

Safety instructions	2
Delivery includes	4
Product overview	5
Putting the Set 830-TV into operation	6
Setting up the transmitter	6
Connecting the transmitter to a sound source	7
Connecting the transmitter to the mains	10
Using the Set 830-TV	11
Switching the transmitter on/off	11
Switching the receiver on/off	12
Adjusting the volume	13
Adjusting the balance	13
Switching between mono and stereo operation	14
Individually enhancing the speech intelligibility	15
Storing and charging the receiver	16
Charging a rechargeable battery in the transmitter's charging compartment	17
What if...	18
...this indicator lights up?	18
...you press this button?	18
...you change the position of this control/switch? ...	19
...you hear warning signals?	19
Cleaning the Set 830-TV	20
Cleaning the transmitter and the receiver	20
Cleaning the ear pads	20
If a problem occurs	21
Additional technical information	23
Accessories and spare parts	26
Specifications	27
Manufacturer Declarations	29
Index	31

Safety instructions

- Please read this instruction manual carefully and completely before using the devices.
- Make this instruction manual easily accessible to all users at all times. Always include this instruction manual when passing the devices on to third parties.
- Do not use the devices in situations which require special attention (e.g. when performing skilled jobs).
- Always keep the devices dry and do not expose them to extreme temperatures.
- Use the devices with care and set them up in a clean, dust-free environment.
- Varnish or furniture polish may degrade the feet of the transmitter, which could stain your furniture. You should therefore place the transmitter on a non-slip pad to avoid potential staining of furniture.
- The receiver generates stronger permanent magnetic fields that could cause interference with cardiac pacemakers and implanted defibrillators (ICDs).
 - ▶ Always maintain a **distance of at least 3.94" (10 cm)** between the ends of the earbuds with the ear pads and the cardiac pacemaker or implanted defibrillator.
- This receiver allows you to set higher volumes than conventional headphones. This can cause hearing damage in persons with healthy hearing and especially in children.
- Refer all servicing to qualified service personnel. Servicing is required if the devices have been damaged in any way, such as mains cable or plug damage, liquid has been spilled, objects have fallen inside, the devices have been exposed to rain or moisture, do not operate properly or have been dropped.
- **WARNING:** To reduce the risk of fire or electric shock, do not expose the device and the mains unit to rain or moisture.
- Use only the supplied mains unit.
- Disconnect the mains connector from the wall socket
 - to completely disconnect the device from the mains,
 - during lightning storms or when unused for long periods of time.
- Ensure that the mains unit is:
 - always readily operable and easily accessible,
 - properly plugged into the wall socket,
 - not covered or exposed to direct sunlight for longer periods of time in order to prevent heat accumulation,
 - only operated within the permissible temperature range (see "Specifications" on page 27),
 - not operated near heat sources.

Intended use

Intended use includes:

- having read this instruction manual, especially the chapter "Safety instructions" on page 2,
- using the devices within the operating conditions and limitations described in this instruction manual.

"Improper use" means using the devices other than as described in this instruction manual, or under operating conditions which differ from those described herein.

Safety instructions for the Lithium-Polymer rechargeable battery

The BA 300 is a Lithium-Polymer rechargeable battery. If abused or misused, this rechargeable battery may be damaged. Please understand that Sennheiser does not accept liability for damage arising from abuse or misuse.

WARNING!



In extreme cases, the rechargeable battery may even present a

- heat hazard,
- fire hazard,
- explosion hazard,
- smoke and gas hazard.



Do not heat above 70°C/158°F, e.g. do not expose to sunlight or throw into a fire.



Only charge rechargeable batteries with the appropriate Sennheiser chargers.



Do not expose to moisture.



When not using the rechargeable battery for extended periods of time, charge it regularly (every six months for about one hour).



Do not short-circuit.



Only charge rechargeable batteries at ambient temperatures between 10°C/50°F and 40°C/104°F.



Do not mutilate or dismantle.



Do not charge the rechargeable battery if the device is obviously defective.



Store the devices/ rechargeable batteries in a cool and dry place at room temperature.



Return defective devices or devices with defective rechargeable batteries to your specialist dealer.

Delivery includes

Delivery of the Set 830-TV system includes:

- 1 RI 830 stethoset receiver
with BA 300 Lithium-Polymer rechargeable battery
- 1 TI 830 transmitter with integrated charging
compart-ments
- 1 NT 13 mains unit
with 3 country adapters (EU, UK, US)
- 1 audio connection cable
with two 3.5 mm stereo jack plugs
for connection to a headphone socket
- 3 audio adapters:
 - 1 adapter 3.5 mm to 1/4" (6.3 mm) jack plug
 - 1 adapter for RCA socket
 - 1 SCART adapter for SCART socket
- 2 pairs of spare ear pads
- 1 instruction manual





Product overview

The overview pictures of the stethoset receiver and the transmitter can be found on the inside front cover of this instruction manual.

I Stethoset receiver

- ① Volume control
- ② Balance control
- ③ Battery compartment

II Transmitter

- ④ Charging compartment for receiver
- ⑤ Charging compartment for optional spare rechargeable battery
- ⑥ Charging indicator for optional spare rechargeable battery 
- ⑦ Charging indicator for receiver's rechargeable battery 
- ⑧ Operation indicator 
- ⑨ "Speech intelligibility" button 
- ⑩ Indicator for the selected speech intelligibility
- ⑪ Socket (marked blue) for connection of sound source or external microphone
- ⑫ Mono/stereo slide switch
- ⑬ Treble adjustment control
- ⑭ DC socket (marked yellow) for connection of mains unit

Putting the Set 830-TV into operation

Setting up the transmitter

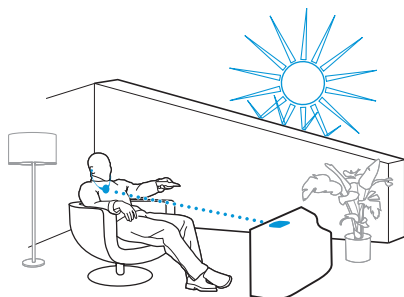

- ▶ Place the transmitter so that:
 - there are no obstacles in the light path between transmitter and receiver and
 - transmitter and receiver are not exposed to direct sunlight. Direct sunlight may interfere with the reception and may damage the transmitter.

If you are using a [plasma TV screen](#):

Plasma TV screens radiate an infra-red signal that can adversely affect the transmission quality.

- ▶ Make sure that the transmitter is placed as far as possible from your plasma TV screen.
- ▶ If necessary, use a standard extension cable with 3.5 mm stereo jack plug to reduce the distance between transmitter and receiver. This extension cable is available from your Sennheiser partner.

Note:



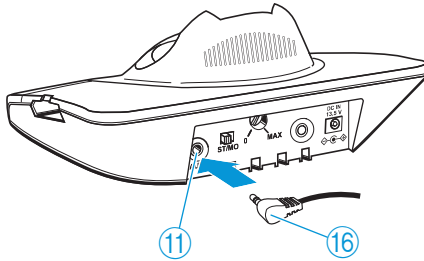

One transmitter can be used to transmit to several receivers on the same frequency.

Connecting the transmitter to a sound source

- ▶ Switch your sound source (e.g. TV) off before connecting the transmitter.

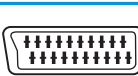

- ▶ Plug one end of the audio connection cable ⑯ into the blue socket ⑪ on the transmitter.
- ▶ Check the available connection possibilities of your sound source (e.g. TV):

Connection possibility	Name of connection possibility
A 	Headphone socket
B 	RCA socket
C 	SCART socket
D 	MKE 800 TV-N external microphone

- ▶ Connect the transmitter as described in the corresponding chapter **A**, **B**, **C** or **D**.

Notes:

- If there are several connections (**A**, **B** or **C**) available, select the SCART socket **C**.
- The MKE 800 TV-N microphone and additional SCART adapters are available as accessories (see page 26).

A Connecting the transmitter to a headphone socket

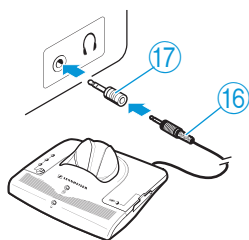

- ▶ Plug the other end of the audio connection cable (16) into the headphone socket on your sound source.

Is the plug on the audio connection cable too small for the headphone socket?

- ▶ Plug the adapter to 1/4" (6.3 mm) jack socket (17) onto the audio connection cable (16).

- ▶ Adjust the volume of the headphone socket on your sound source to a medium level.

This improves the quality of cordless sound transmission. For detailed information, please refer to the instruction manual of your sound source (e.g. TV).

Note:

With most TVs, the headphone socket is located at the front or sides.

B Connecting the transmitter to an RCA socket

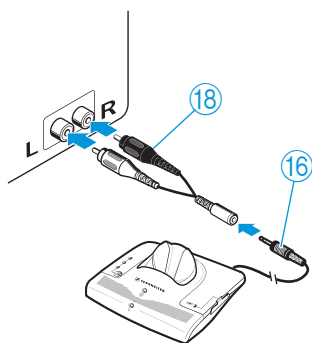

- ▶ Plug the adapter for RCA socket (18) onto the audio connection cable (16).

- ▶ Connect the red connector of the adapter (18) to the red RCA socket R of your sound source.

- ▶ Connect the white connector of the adapter (18) to the white or black RCA socket L of your sound source.

Notes:

– With most TVs, the RCA socket is located at the rear.

If your TV has several RCA sockets, use the socket **RCA output**.

C Connecting the transmitter to a SCART socket

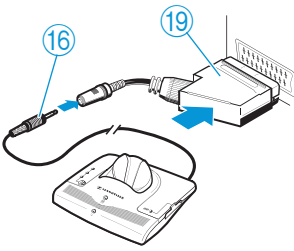

- ▶ Plug the SCART adapter (19) onto the audio connection cable (16).
- ▶ Connect the SCART adapter (19) to the SCART socket on your TV.

Note:

If your TV has several SCART sockets, use the socket **SCART output**.

D Using the MKE 800 TV-N external microphone

What if your sound source doesn't have any of the connections mentioned above? What if your sound source mutes the external loudspeakers if you use one of the connections mentioned above?

- ▶ Via the operating menu of your TV, check if the muting can be deactivated.

If the muting persists:

- ▶ Use the optional MKE 800 TV-N microphone (see page 26).

To make the sound of your sound source audible:

- ▶ Directly connect the microphone to the blue socket (11) on the transmitter.
- ▶ Position the microphone in front of the loudspeaker of your sound source.

Note:

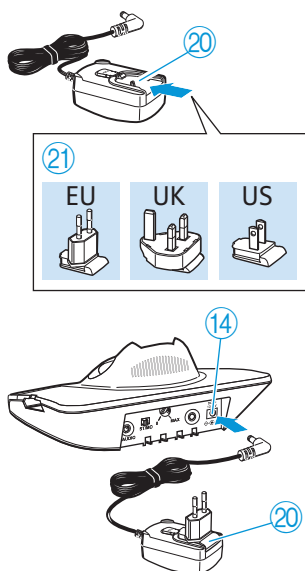

You can change the sound by varying the position of the microphone in front of the loudspeaker.

Connecting the transmitter to the mains



- ▶ Select the suitable country adapter (21) for your wall socket.
- ▶ Slide the suitable country adapter onto the mains unit (20).
- ▶ Connect the yellow connector of the mains unit to the yellow socket (14) on the transmitter.
- ▶ Plug the mains unit (20) into a wall socket.
The operation indicator (8)  on the transmitter lights up green.

Notes:

- When connecting the transmitter to the mains for the first time, charge the rechargeable battery for 3 hours as described in the chapter “Storing and charging the receiver” on page 16. 
- If there is no audio signal from the sound source for about 3 minutes, the transmitter automatically switches off. The operation indicator (8)  goes off.

Using the Set 830-TV

To switch the Set 830-TV system on, proceed as follows:

Sequence of steps	Page
1. Switch your sound source (e.g. TV) on. The transmitter automatically switches on.	11
2. Adjust the volume on the receiver to a low level.	12,13
3. Put the stethoset receiver on. The receiver automatically switches on.	12
4. Adjust the desired volume on the receiver.	13

Switching the transmitter on/off

To switch the transmitter **on**:

- ▶ Switch your sound source on.
The transmitter automatically switches on. The operation indicator ⑧  lights up green.

If the transmitter doesn't switch on:

- ▶ Read the chapter "If a problem occurs ..." on page 21.

To switch the transmitter **off**:

- ▶ Switch your sound source off.
The transmitter automatically switches off after 3 minutes. The operation indicator ⑧  goes off.

To **disconnect** the transmitter **from the mains**:

- ▶ Pull out the mains connector from the wall socket.

Note:

When not using the transmitter for extended periods of time (e.g. when you are on holiday), pull out the mains connector from the wall socket. In this case, however, the receiver's rechargeable battery will not be recharged.

Switching the receiver on/off

WARNING! Interference due to magnetic fields!



The receiver generates stronger permanent magnetic fields that could cause interference with cardiac pacemakers and implanted defibrillators (ICDs).

- ▶ Always maintain a **distance of at least 3.94" (10 cm)** between the ends of the earbows with the ear pads and the cardiac pacemaker or implanted defibrillator.

CAUTION! Hearing damage due to high volumes!



This receiver allows you to set higher volumes than conventional headphones. This can cause hearing damage in persons with healthy hearing and especially in children.

- ▶ Before putting the receiver on, set the volume on the receiver to a low value.
- ▶ Do not continuously expose yourself to high volumes.

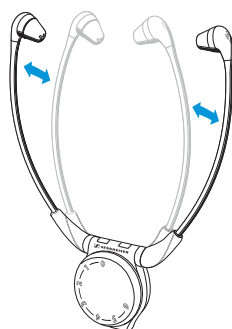

Switching the receiver on

The receiver automatically switches on when you pull the earbows apart.

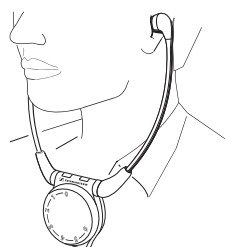

Putting the receiver on

- ▶ Put the receiver on the correct way round, with the Sennheiser logo facing away from your body. The ear pads adapt to the ear form and thus increase the wearing comfort.

Switching the receiver off

- ▶ Take the receiver off.

The receiver automatically switches off after 30 seconds.

Notes:

- For how to store and charge the receiver, refer to page 16.
- If you are not within the range of the transmitter, the receiver automatically switches off after 3 minutes.



Adjusting the volume

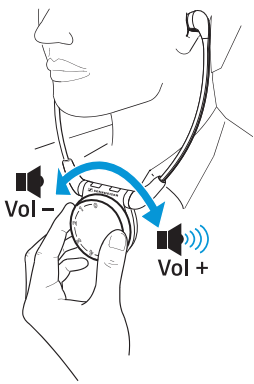

- ▶ Use the volume control ① to adjust the volume to a sufficient and comfortable level.

Adjusting the balance

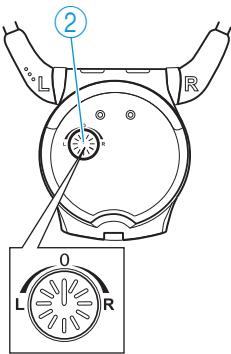

The balance control allows for right/left volume adjustment. Adjust the balance so that you hear equally well with both ears.

- ▶ Turn the balance control ② to the left **L** or right **R** in order to increase the volume for the corresponding ear.

Switching between mono and stereo operation

If, despite a correct balance adjustment, you can hear the sound only with one ear:

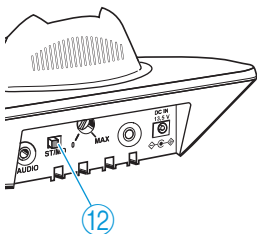

- ▶ Set the ST/MO switch ⑫ on the transmitter to MO (mono).



Meaning of the terms "mono" and "stereo"

Stereo (ST)	Mono (MO)
<p>Example: L: Speech from the left R: Music from the right</p>	
<p>You hear speech from the left and music from the right.</p>	<p>You hear speech and music coming from the front.</p>



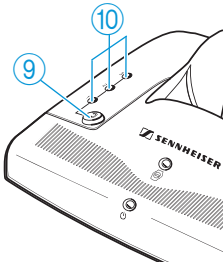

Individually enhancing the speech intelligibility



The “speech intelligibility” button ⑨  allows you to adjust the sound to your individual needs.

Try out which setting works best for you.

- ▶ Press the “speech intelligibility” button ⑨  repeatedly until the sound is optimally adjusted to your needs.

Press the button	1 x	2 x	3 x	4 x
Indicator ⑩ is lit yellow				
Setting	1	2	3	Default setting

If necessary, you can have the speech intelligibility fine adjusted to your hearing ability (see page 23).

Storing and charging the receiver

Do not store the receiver on a glass dummy head, chair armrest, or similar for long periods of time as this can reduce the contact pressure of the earbuds. Furthermore, with the earbuds pulled apart, the receiver remains switched on.

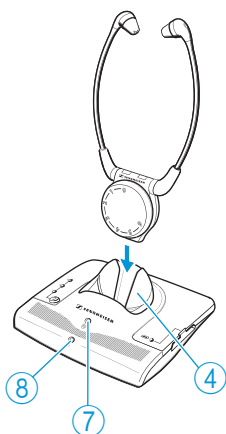

- ▶ After use, place the receiver into the transmitter's charging compartment (4) without exerting too much pressure. The receiver automatically switches off.

When the receiver is placed correctly into the charging compartment, the indicator (7) lights up:



- red: The battery is being charged.
- green: The battery is fully charged.

Notes:

- With a fully charged battery, the **operating time is up to 12 hours**.
- If you have several receivers, they can be used during charging.
- Always store the receiver in the transmitter's charging compartment (4) to ensure that it is fully charged. The intelligent battery charging technology prevents over-charging.

Charging a rechargeable battery in the transmitter's charging compartment

You can charge the receiver's rechargeable battery or a spare BA 300 rechargeable battery (not included in the delivery of the Set 830-TV) in the charging compartment ⑤ at the side of the transmitter.

The spare battery offers extended listening time while the discharged first battery is being recharged.

Note:

Before using the spare rechargeable battery for the first time, charge it for at least 3 hours.



Removing and charging the receiver's battery

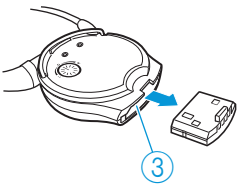

To remove the receiver's battery:

- ▶ Pull the battery out of the receiver's battery compartment ③.

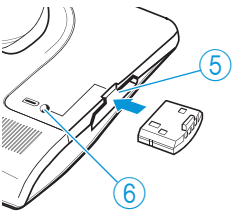

- ▶ Insert the receiver's battery into the charging compartment ⑤ at the side of the transmitter as shown.

When the battery is inserted correctly into the charging compartment, the indicator ⑥ lights up:



red: The battery is being charged.

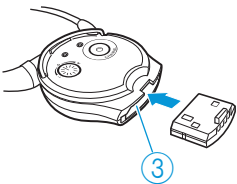

green: The battery is fully charged.



- ▶ Slide the battery into the receiver's battery compartment ③ as far as it will go.

What if...

...this indicator lights up?

Indicator		Status	Meaning
	Operation indicator ⑧ on the transmitter	lit green	Transmitter is switched on.
		off	Transmitter is switched off.
 	Charging indicator ⑦	lit red	Rechargeable battery is being charged.
	Charging indicator ⑥	lit green	Rechargeable battery is fully charged.
3 ○ 2 ● 1 ○	"Speech intelligibility" indicator ⑩ on the transmitter	lit yellow	Speech intelligibility enhancement is switched on.
		off	Speech intelligibility enhancement is switched off.



...you press this button?

Button	Function	Page
"Speech intelligibility" button ⑨  on the transmitter	Selects one of the possible settings in order to individually enhance the speech intelligibility.	15

...you change the position of this control/switch?

Control/switch	Function	Page
Volume control ① on the receiver	Reduces or increases the volume of the receiver.	13
Balance control ② on the receiver	Increases the volume for the left or the right ear.	13
Mono/stereo slide switch ⑫ on the transmitter	Sets the transmitter to mono or stereo operation.	14
Treble adjustment control ⑬ on the transmitter	Treble adjustment is only to be made by a hearing aid technician / an expert.	23

...you hear warning signals?

Warning signal	Meaning
 6 short beeps	The receiver does not receive any signal from the transmitter: <ul style="list-style-type: none"> • Transmitter and receiver are too distant. The receiver switches off after 3 minutes. • The transmitter is switched off.
 2 long beeps	The rechargeable battery is almost flat.

Cleaning the Set 830-TV

Cleaning the transmitter and the receiver

CAUTION! Liquids can damage the electronics of the devices!



Liquids entering the housing of the devices can cause a short-circuit and damage the electronics.

- ▶ Keep all liquids far away from the devices.
- ▶ Do not use any cleansing agents or solvents.

- ▶ Before cleaning, disconnect the transmitter from the mains.
- ▶ Use only a slightly damp cloth to clean the devices.

Cleaning the ear pads

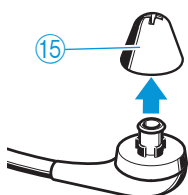

- ▶ Carefully remove the ear pads (15) from the receiver.
- ▶ Clean the ear pads (15) with warm soapy water and rinse thoroughly.

- ▶ Dry the ear pads (15).
- ▶ Put the ear pads back on the receiver.

Note:

For reasons of hygiene, you should replace the ear pads (15) from time to time. Spare ear pads are available from your Sennheiser dealer (see "Accessories and spare parts" on page 26).

If a problem occurs ...

The transmitter does not switch on

Possible cause	Solution
Is the mains unit connected correctly?	Check the connection of the mains unit to the transmitter and to the mains (see page 10).
Is the sound source switched on?	Switch your sound source on.
Is the volume of the sound source sufficient?	Set the volume on your sound source to a medium value.
Is the transmitter set to operating mode 2 (see page 25)?	Take the receiver out of the charging compartment. The transmitter automatically switches on.

You cannot hear anything

Possible cause	Solution
Is there a free line of sight between receiver and transmitter?	Remove obstacles in the light path between receiver and transmitter.
Is the receiver still within the transmitter's range?	Move the receiver closer to the transmitter.
Are transmitter and receiver exposed to direct sunlight?	Avoid exposure to direct sunlight.
Are all connectors connected correctly?	Check the connection between the transmitter and your sound source (see page 7).
Is the operation indicator ⑧ lit?	Check if the transmitter is switched on (see page 11).
Is the transmitter set up the wrong way round?	Set up the transmitter so that the cables are guided away from the receiver (see page 6).

Possible cause	Solution
Does the receiver's Sennheiser logo face the transmitter?	Wear the receiver the right way round, with the Sennheiser logo facing the transmitter.
Is the volume of the sound source sufficient?	Set the volume on your sound source to a medium value.
Is the volume of the receiver sufficient?	Increase the volume by turning the volume control ① on the receiver (see page 13).
Is the rechargeable battery inserted properly into the receiver and fully charged?	Remove the rechargeable battery and reinsert it into the receiver. If this doesn't help: recharge the rechargeable battery (see page 17).

You hear the sound only with one ear

Possible cause	Solution
Is the balance adjusted correctly?	Turn the balance control ② to the left or right (see page 13).
Is the transmitter set to mono?	Set the mono/stereo switch ⑫ on the transmitter to the left (see page 14).

The sound of your sound source is hardly intelligible

Possible cause	Solution
Is the speech intelligibility enhancement out of adjustment?	Press the "speech intelligibility" button ⑨  on the transmitter repeatedly until the sound is optimally adjusted to your needs (see page 15).
Do you use a plasma TV screen?	Make sure that the transmitter is placed as far as possible from your plasma TV screen (see page 6).
Is the receiver still within the transmitter's range?	Move the receiver closer to the transmitter.

The loudspeakers of your TV are muted

Possible cause	Solution
Some TVs have a function that mutes the loudspeakers when you connect a transmitter.	Via the operating menu of your TV, check if and how the muting function can be deactivated.
	Use either a different audio socket on your TV or use the MKE 800 TV-N external microphone (see "Accessories and spare parts" on page 26).





If a problem occurs that is not listed in the above tables or if the problem cannot be solved with the proposed solutions, please contact your Sennheiser partner for assistance.

Additional technical information

Fine adjusting the speech intelligibility

The speech intelligibility can be enhanced individually on the transmitter (see page 15).

There are the following settings:

Setting	Indicator ⑩ is lit yellow	Fine adjustment
1		Compression
2		Treble boost
3		Compression and treble boost
Default setting		No fine adjustment made

Compression (settings 1 and 3)

Deterioration of the ability to hear quiet sounds as well as loud ones is a typical symptom of old age. Compression compensates for these volume differences by boosting the volume of quiet sounds and reducing the volume of loud sounds if necessary.

Compression seems to put the speech in the foreground, making it easier to understand.

Compression is self-regulating; once it has been activated, it is not necessary to make any other settings.

Treble boost (settings 2 and 3)

Another typical age-related phenomenon is the deterioration of the hearing with regard to high frequencies. However, high frequencies are important for the intelligibility of speech.

The treble boost makes the speech clearer and easier to understand.

With the treble boost (settings 2 and 3), additional fine adjustment is possible using the treble boost control ⑬ on the rear of the transmitter.

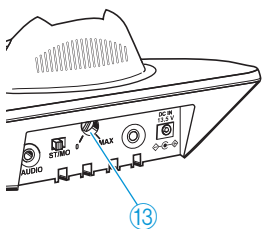

- ▶ Use a screwdriver to turn the treble boost control ⑬ to the left or right until the sound can be heard very well.

The position "0" corresponds to a minimum boost, the position "MAX" corresponds to a maximum boost, and the control is factory-pret to the medium position.

Function of the treble boost control

By means of the transmitter's steplessly adjustable treble boost control ⑬ the audio signal is boosted as shown in the diagram.

The treble boost control ⑬ allows you to select one of the curves shown in the diagram below.

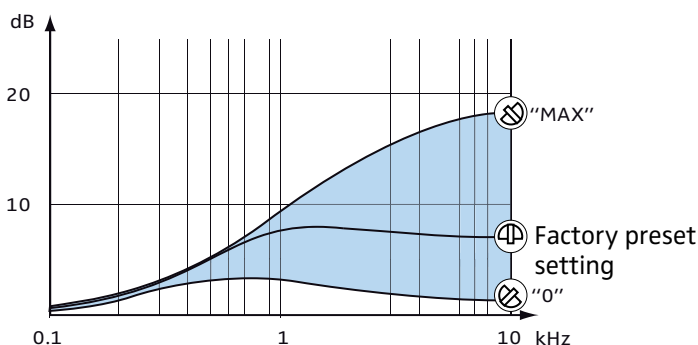

Changing the operating mode

The transmitter can be set to a different operating mode. This is useful when the sound of your sound source is very low and the transmitter therefore does not always switch on automatically.

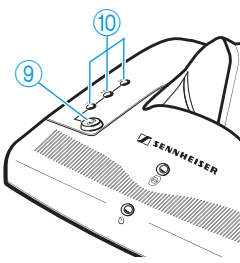

- ▶ Press the "speech intelligibility" button ⑨  for approx. 5 seconds.

The indicator ⑩ goes off. The charging indicator for the spare rechargeable battery ⑥ flashes several times:

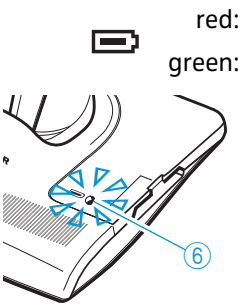

- red: operating mode 2
- green: operating mode 1 (factory preset setting)

If the operating mode was changed successfully, the charging indicator for the spare rechargeable battery ⑥ goes off and the indicator ⑩ lights up again.

Particularities of operating mode 2:

In operating mode 2, the transmitter is **not** switched on by the sound signal from the sound source.

To **switch** the transmitter **on**:

- ▶ Take the receiver out of the charging compartment.

To **switch** the transmitter **off**:

- ▶ Place the receiver into the charging compartment.

If – in operating mode 2 – you want to use a second receiver and charge its rechargeable battery during operation:

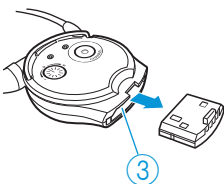

- ▶ Pull the battery out of the receiver's battery compartment ③.

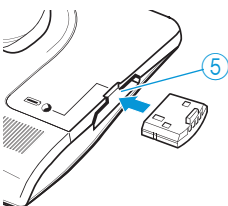

- ▶ Slide the battery into the transmitter's charging compartment ⑤ as far as it will go.

Accessories and spare parts

CAUTION! Danger of damage to the device!



Components from other manufacturers (e.g. for power supply or rechargeable battery) may cause damage to the device and will invalidate the warranty!

- ▶ Use only use original Sennheiser accessories and spare parts.
-

The following receivers are available from your specialist dealer:

Cat. No. **Accessory/spare part**

- 502021 RI 830 S receiver
- 502020 RI 830 stethoset receiver
- 502023 RI 900 stethoset receiver

The following Set 830-TV accessories are available from your specialist dealer:

Cat. No. **Accessory/spare part**

- 500898 BA 300 spare rechargeable battery
- 528123 Ear pads (silicone, black), 5 pairs
- 528124 Ear pads (silicone, transparent), 5 pairs
- 528125 Ear pads (foam, black), 5 pairs
- 531428 10 swivel joints for ear pads
- 517627 Extension cable, 3 m
(3.5 stereo jack plug)
- 500974 MKE 800 TV-N external microphone (mono)

Specifications

System

Modulation	FM, stereo
Carrier frequencies	2.3 MHz/2.8 MHz
Frequency response	50 Hz–16,000 Hz
THD	< 1%
Charging time for rechargeable battery	approx. 3 hours
Signal-to-noise ratio (1 mV, peak deviation)	typ. 75 dBA
Operating temperature	10°C to 40°C

Transmitter

Range	up to 12 m within a room
Audio/microphone connection	3.5 mm stereo jack socket
Power supply	13.5 V DC/500 mA via NT 13 mains unit
Weight	approx. 260 g
Dimensions	approx. 112 x 146 x 58 mm

Receiver

Max. SPL	125 dB (SPL)
Power supply	via BA 300 rechargeable Lithium-Polymer battery (3.7 V / 150 mAh)
Operating time	up to 12 hours
Weight	approx. 68 g (incl. BA 300)
Dimensions	approx. 240 x 128 x 26 mm

NT 13 mains unit

Nominal input voltage	100 V~ to 240 V~
Mains frequency	50–60 Hz
Max. power consumption	2.4 W (incl. battery charging)
Nominal output voltage	13.5 V DC
Nominal output current	500 mA
Standby consumption	approx. 0.9 W (w/o battery charging)
Ambient temperature	+5°C to +40°C

The NT 13 mains unit is certified in accordance with the legal safety requirements of Europe, the United States, Canada, Russia and Japan.

The devices comply with the following standards:

Europe  **EMC:** EN 55013, EN 55020
Safety: EN 60065, EN 61558, EN 60950

USA  47CFR15_B

Canada IC ICES-003

Manufacturer Declarations

Warranty

Sennheiser electronic GmbH & Co. KG gives a warranty of 24 months on this product.

For the current warranty conditions, please visit our web site at www.sennheiser.com or contact your Sennheiser partner.

CE Declaration of Conformity

 This equipment is in compliance with the essential requirements and other relevant provisions of Directives 2004/108/EC and 2006/95/EC.

The declaration is available at www.sennheiser.com.

Batteries or rechargeable batteries



Please dispose of exhausted batteries and rechargeable batteries as special waste or return them to your specialist dealer.

WEEE Declaration



Please dispose of this product at the end of its operational lifetime by taking it to your local collection point or recycling centre for such equipment.

Statements regarding FCC and Industry Canada

This equipment has been tested and found to comply with the limits for a Class B digital device, pursuant to Part 15 of the FCC Rules.

These limits are designed to provide reasonable protection against harmful interference in a residential installation. This equipment generates, uses and can radiate radio frequency energy and, if not installed and used in accordance with the instructions, may cause harmful interference to radio communications. However, there is no guarantee that interference will not occur in a particular installation. If this equipment does cause harmful interference to radio or television reception, which can be determined by turning the equipment off and on, the user is encouraged to try to correct the interference by one or more of the following measures:

- Reorient or relocate the receiving antenna.
- Increase the separation between the equipment and receiver.
- Connect the equipment into an outlet on a circuit different from that to which the receiver is connected.
- Consult the dealer or an experienced radio/TV technician for help.

This class B digital equipment complies with the Canadian ICES-003.

Changes or modifications made to this equipment not expressly approved by Sennheiser electronic Corp. may void the FCC authorization to operate this equipment.

Index

Receiver

- Adjusting the balance 13
- Adjusting the volume 13
- Balance control (function) 19
- Charging the receiver 16
- Cleaning 20
- No sound signal 21
- Operating time 16
- Putting the receiver on/taking the receiver off 12
- Sound hardly intelligible 22
- Sound only audible with one ear 22
- Storing the receiver 16
- Switching the receiver on/off 12

Rechargeable battery

- Charging in the charging compartment 17
- Replacing and charging the rechargeable battery 17

Special functions

- Changing the operating mode 25
- Fine adjusting the speech intelligibility 23
- Treble boost control 24

Terms

- Compression/treble boost 24
- Mono/stereo 14

Transmitter

- Cleaning 20
- Connection to a headphone socket 8
- Connection to a SCART socket 9
- Connection to a sound source 7
- Connection to an RCA socket 8
- Connection to the mains 10
- Enhancing the speech intelligibility 15
- Installation 6
- Operation indicator (meaning) 18
- “Speech intelligibility” indicator (meaning) 18
- Switching between mono and stereo operation 14
- Switching the transmitter on/off 11
- Treble boost control (function) 24
- Troubleshooting 21
- Using the MKE 800 TV-N external microphone 9



Sennheiser electronic GmbH & Co. KG
Am Labor 1, 30900 Wedemark, Germany
www.sennheiser.com

Printed in China
Publ. 08/10
528249/A02

Free Manuals Download Website

<http://myh66.com>

<http://usermanuals.us>

<http://www.somanuals.com>

<http://www.4manuals.cc>

<http://www.manual-lib.com>

<http://www.404manual.com>

<http://www.luxmanual.com>

<http://aubethermostatmanual.com>

Golf course search by state

<http://golfingnear.com>

Email search by domain

<http://emailbydomain.com>

Auto manuals search

<http://auto.somanuals.com>

TV manuals search

<http://tv.somanuals.com>