

EKI 830

Infrared bodypack receiver



Instruction manual



Contents

Important safety information	2
The EKI 830 receiver	4
Delivery includes	5
Product overview	5
Putting the EKI 830 into operation	6
Removing and charging the rechargeable battery	6
Using the EKI 830	8
Connecting headphones or an induction coupler	8
Wearing the receiver	9
Cleaning and maintaining the EKI 830	11
If a problem occurs	12
Accessories	13
Specifications	14
Manufacturer Declarations	15

Important safety information

- ▶ Read this instruction manual carefully and completely before using the product.
- ▶ Always include this instruction manual when passing the product on to third parties.
- ▶ Do not use an obviously defective product.

Preventing damage to health and accidents

- ▶ Do not use the product in an environment that requires your special attention.
- ▶ Do not listen at high volume levels for long periods of time to prevent hearing damage.

Preventing damage to the product and malfunctions

- ▶ Always keep the product dry and do not expose it to extreme temperatures (hairdryer, heater, extended exposure to sunlight, etc.) to avoid corrosion or deformation.
- ▶ Only use attachments/accessories supplied or recommended by Sennheiser.
- ▶ Only clean the product with a soft, dry cloth.

Intended use/liability

The receiver can be used together with infra-red transmission systems which operate on a carrier frequency of 2.3 or 2.8 MHz. Headphones with 3.5 mm jack plugs, induction plates and induction loops can be used for audio transmission.

This product can be used for commercial purposes. It is considered improper use when this product is used for any application not named in this instruction manual.

Sennheiser does not accept liability for damage arising from abuse or misuse of this product and its attachments/accessories.

Safety instructions for the BA 300 Lithium-Polymer rechargeable battery

In extreme cases, abuse or misuse of rechargeable batteries can lead to:



WARNING

- explosion,
- fire development,
- heat generation or
- smoke or gas development.



Do not heat above 70°C/158°F, e.g. do not expose to sunlight or throw into a fire.



Only use rechargeable batteries recommended by Sennheiser and the appropriate chargers.



Do not expose to moisture.



When not using rechargeable batteries for extended periods of time, charge them regularly (about every 3 months).



Store charged rechargeable batteries so that the terminals cannot contact each other – danger of shorting out/fire hazard.



Only charge rechargeable batteries at ambient temperatures between 10°C/50°F and 40°C/104°F.



Do not mutilate or dismantle.



Do not continue to use defective rechargeable batteries and dispose of them immediately.



Immediately remove rechargeable batteries from an obviously defective product.



Dispose of rechargeable batteries at special collection points or return them to your specialist dealer.

The EKI 830 receiver

The EKI 830 is an infra-red receiver designed to assist your hearing. Sound can be transmitted from the receiver to the hearing aid via headphones, induction plates or an induction loop.

Areas of application

The EKI 830 receiver can be used together with infra-red transmission systems which operate on a carrier frequency of 2.3 or 2.8 MHz (example: Sennheiser SZI/SI 1015).

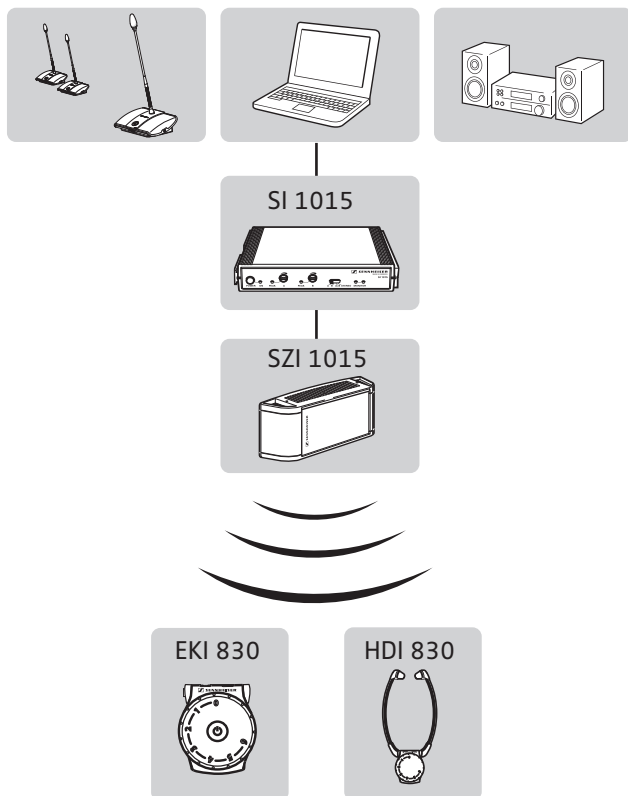

Alternatively, the receiver can be used with transmitters of the Sennheiser Set 830 S, Set 830 TV and Set 900 infra-red hearing systems.

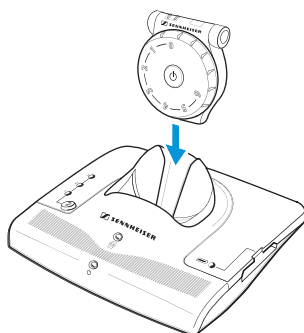

Delivery includes

- 1 EKI 830 receiver
with BA 300 Lithium-Polymer rechargeable battery
- 1 lanyard
- 1 instruction manual
- 1 quick start guide for display at the receiver counter

Product overview

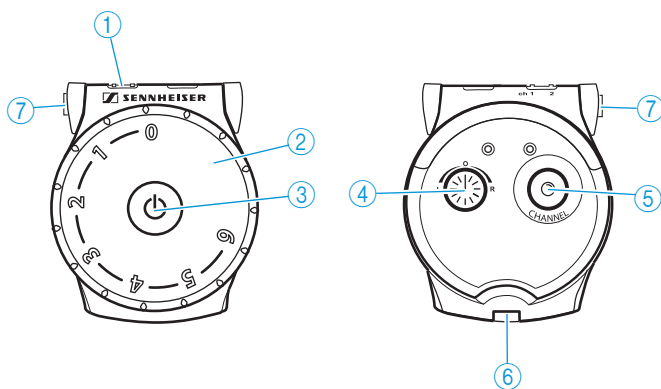

- ① Channel indicator
- ② Volume control
- ③ On/off button 
- ④ Balance control

- ⑤ Channel selection button
- ⑥ Battery compartment
- ⑦ Socket for headphones, induction loop, connection cable to hearing aid

Putting the EKI 830 into operation

Removing and charging the rechargeable battery

You can charge the receivers and the removed rechargeable batteries in the Sennheiser L 300 10-10 charger. An individual receiver can be charged in the Sennheiser TI 830 infra-red transmitter.

- ▶ Before using the rechargeable batteries for the first time, charge them for **at least 3 hours**.



Charging the receiver

- ▶ Place the receiver into the charging compartment of the L 300 10-10 charger or into the transmitter's charging compartment. The receiver automatically switches off. The charging process is started automatically. The corresponding LED lights up red.
- ▶ Charge the rechargeable batteries until they are fully charged. The corresponding LED lights up green.

For further information on charging, refer to the instruction manual of the L 300 10-10 or to the instruction manual of the corresponding Sennheiser infra-red hearing system.

Charging the rechargeable battery separately

When a rechargeable battery is discharged, you can use the receiver with an optional spare rechargeable battery:

- ▶ Remove the discharged battery from the receiver and recharge the battery in the L 300 10-10 charger or in the Sennheiser infra-red transmitter.

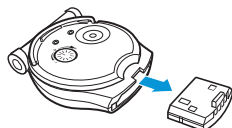

To remove the receiver's discharged battery:

- ▶ Pull the battery out of the receiver's battery compartment.

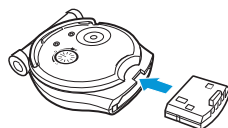

To insert the receiver's battery:

- ▶ Insert the battery into the receiver and slide the battery into the battery compartment as far as it will go.





- With a fully charged rechargeable battery, the **operating time is up to 12 hours**.
- Always store the receiver in the L 300 10-10 charger to ensure that it is fully charged when needed. The intelligent battery charging technology prevents overcharging.

Setting the receiver to the frequency of the transmission system

The receiver allows you to select between three channels with preset frequencies so that you can match the receiver to the channel used by your transmission system.

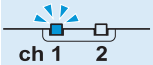
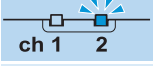
Overview of the channel indicator:

Channel	Channel indicator	Frequency	You hear the sound in
1		2.3 MHz	mono
2		2.8 MHz	mono
3		2.3 MHz + 2.8 MHz	stereo

To change the channel:

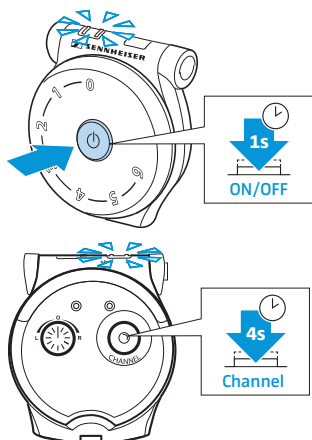

- ▶ Press the on/off button. The receiver switches on, the LEDs light up. If the correct channel is already set, no further steps are necessary. To select a different channel:
- ▶ Press the channel selection button repeatedly until the channel indicator displays the desired channel (see table). If no further buttons are pressed, the channel indicator goes off after 30 seconds. If no channel is found, the channel indicator flashes.

i If you wish your Sennheiser partner can permanently assign the receivers to either channel 1 or 2 and disable the channel selection button to prevent user tampering.

Using the EKI 830

Connecting headphones or an induction coupler

The 3.5 mm jack socket of the receiver allows you to connect

- headphones such as the Sennheiser HD 410/1029, PX 90, PMX 60/90, GP 03,
- an induction coupler such as the Sennheiser EZT 3011 induction loop or the EZI 120 induction plates or
- a connection cable with 3.5 mm jack plug to your hearing aid.

Connecting headphones

- ▶ Connect the 3.5 mm jack plug of the headphones to the socket of the receiver.

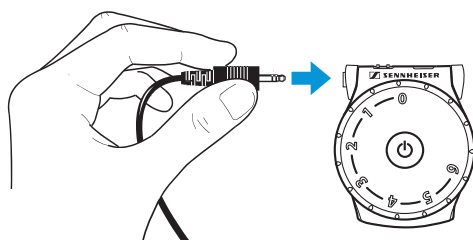

Connecting the induction loop

- ▶ Carefully remove the clip from the receiver.
- ▶ Attach the clip of the induction loop as shown.

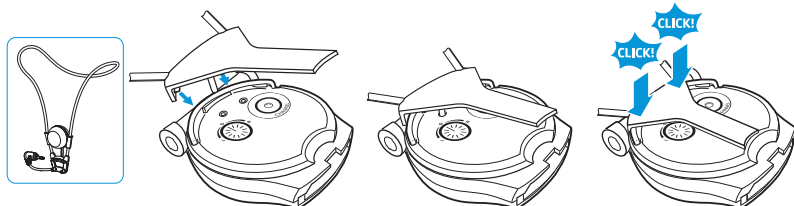

- ▶ Connect the 3.5 mm jack plug of the induction loop to the socket of the receiver.

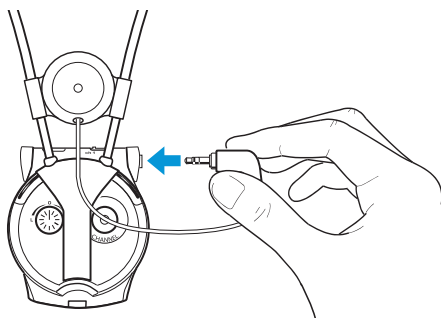

- ▶ Set your hearing aid to position "T". If your hearing aid has no position "T", please contact your hearing aid acoustician.

i For alternative connection possibilities to your hearing aid as well as the connection to cochlea implants, please contact your hearing aid acoustician.

Wearing the receiver

Wearing the receiver around the neck

If you want to wear the receiver around your neck, use the supplied lanyard or the EZT 3011 induction loop (see page 8). To attach the lanyard:

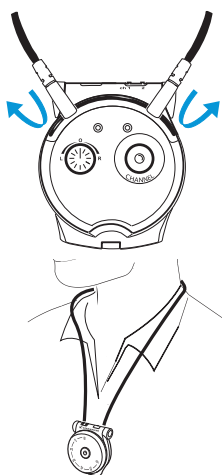

- ▶ Connect the fasteners of the lanyard to the metal ring at the rear of the receiver.
- ▶ Wear the receiver around your neck, with the Sennheiser logo facing away from your body.

Attaching the receiver to clothing using the clip

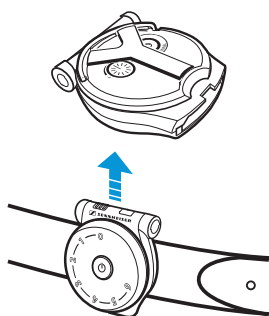

- ▶ Attach the clip to your clothing or belt.
- ▶ Pull the clip with the receiver away from your clothing or belt.

Switching the receiver on and off



WARNING

Danger of hearing damage!

This receiver allows you to set high volumes. This can cause hearing damage in persons with healthy hearing and especially in children.

- ▶ Before using the receiver, set the volume on the receiver to a low level and gradually increase the volume to a comfortable level.

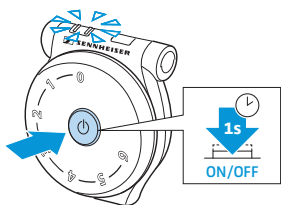

To switch the receiver **on**:

- ▶ Press the on/off button until the channel indicator lights up. If no further buttons are pressed, the channel indicator goes off after 30 seconds.

To switch the receiver **off**:

- ▶ Press the on/off button until the channel indicator lights up briefly and then goes off.

Adjusting the volume

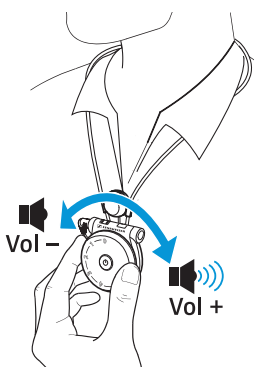

- ▶ Use the volume control to adjust the volume to a sufficient and comfortable level.

Adjusting the balance

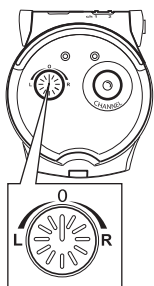

The balance control allows for right/left volume adjustment. Adjust the balance so that you hear equally well with both ears.

- ▶ Turn the balance control to the left **L** or right **R** in order to increase the volume for the corresponding ear.

Cleaning and maintaining the EKI 830

CAUTION

Liquids can damage the electronics of the product!

Liquids entering the housing of the product can cause a short-circuit and damage the electronics.

- ▶ Keep all liquids far away from the product.
 - ▶ Do not use any cleansing agents or solvents.
-
- ▶ Only use a dry and soft cloth to clean the product.

If a problem occurs ...

You cannot hear anything

Possible cause	Solution
There are obstacles in the light path between receiver and transmission system	Remove obstacles in the light path between receiver and transmission system to ensure a free line of sight between the two devices.
The receiver is exposed to direct sunlight	Avoid exposure to direct sunlight.
The volume of the receiver is set too low	Increase the volume by turning the volume control (see page 10).
The rechargeable battery is not inserted properly into the receiver	Remove the rechargeable battery and reinsert it into the receiver's battery compartment (see page 6).
The rechargeable battery is flat	Recharge the rechargeable battery (see page 6).
The receiver is outside the transmission range	Move the receiver closer to the transmitter.
The transmission system and the receiver are set to different frequencies	Set the transmission system and the receiver to the same frequency (see page 7).
The receiver is worn the wrong way round: the Sennheiser logo is facing towards your body	Wear the receiver the right way round, with the Sennheiser logo facing away from your body.

You can hear the sound only with one ear

Possible cause	Solution
The balance is misadjusted	Turn the balance control to the left or right (see page 10).

You hear warning signals

Warning signal	Meaning
 2 long beeps	The rechargeable battery is almost flat; you have approx. 15 minutes of battery power left.

If a problem occurs that is not listed in the above tables or if the problem cannot be solved with the proposed solutions, please contact your Sennheiser partner for assistance.

To find a Sennheiser partner in your country, search at www.sennheiser.com.

Accessories

Sennheiser recommend the following accessories for audio transmission:

Cat. No. **Accessory: Sennheiser headphones**

002146	HD 410
003985	HD 1029
502861	PX 90
004917	PMX 60
502860	PMX 90
005225	GP 03

Cat. No. **Sennheiser accessory for your hearing aid**

502566	EZT 3011 induction loop
003448	EZI 120 induction plates

In addition, the following EKI 830 accessories are available from your specialist dealer:

Cat. No. **Accessory**

502710	L 300 10-10 charger
500898	BA 300 spare rechargeable battery
528185	Lanyard
528184	Clip

Specifications

Modulation	FM
Carrier frequencies	2.3 MHz/2.8 MHz
Frequency response	50 Hz–16,000 Hz
Signal-to-noise ratio (1 mV, peak deviation)	typ. 75 dBA
THD	< 1%
Operating time	up to 12 hrs
Charging time for rechargeable battery	approx. 3 hrs
Power supply	BA 300 Lithium-Polymer rechargeable battery (3.7 V / 150 mAh)
Weight	approx. 50 g (with rechargeable battery)
Dimensions	approx. 70 x 60 x 25 mm

In compliance with:

Europe  **EMC:** EN 55013, EN 55020, EN 60065

USA  47CFR15_B

Safety: UL 2054

Canada IC ICES-003

Manufacturer Declarations

Warranty

Sennheiser electronic GmbH & Co. KG gives a warranty of 24 months on this product.

For the current warranty conditions, please visit our website at www.sennheiser.com or contact your Sennheiser partner.

In compliance with the following requirements

- RoHS Directive (2002/95/EC)
- Battery Directive (2006/66/EC)

The supplied rechargeable batteries can be recycled. Please dispose of them as special waste or return them to your specialist dealer. In order to protect the environment, only dispose of exhausted batteries.



CE Declaration of Conformity

- EMC Directive (2004/108/EC)

The declaration is available at www.sennheiser.com.



Before putting the product into operation please observe the respective country-specific regulations!



Sennheiser electronic GmbH & Co. KG

Am Labor 1, 30900 Wedemark, Germany
www.sennheiser.com

Printed in Germany, Publ. 05/12, 549106/A01

Free Manuals Download Website

<http://myh66.com>

<http://usermanuals.us>

<http://www.somanuals.com>

<http://www.4manuals.cc>

<http://www.manual-lib.com>

<http://www.404manual.com>

<http://www.luxmanual.com>

<http://aubethermostatmanual.com>

Golf course search by state

<http://golfingnear.com>

Email search by domain

<http://emailbydomain.com>

Auto manuals search

<http://auto.somanuals.com>

TV manuals search

<http://tv.somanuals.com>