

evolutionwireless 

SR 300 IEM



Contents

Important safety instructions	2
The evolution wireless series ew 300 IEM G3	4
The SR 300 IEM G3 rack-mount transmitter	4
The frequency bank system	4
Delivery includes	5
Product overview	6
Overview of the SR 300 IEM G3 transmitter	6
Overview of the displays	7
Putting the transmitter into operation	8
Preparing the transmitter for use	8
Connecting external devices	11
Connecting transmitters in a network	12
Connecting the mains unit	12
Using the transmitter	13
Switching the transmitter on/off	13
Monitoring the audio signal via headphones	14
Synchronizing transmitters and receivers via the infra-red interface	14
Adjusting the audio channels	17
Daisy chaining audio signals	17
Deactivating the lock mode temporarily	18
Activating/deactivating the RF signal	18
Using the operating menu	19
The buttons	19
Overview of the operating menu	20
Synchronizing the transmitter with a receiver	21
Cleaning the transmitter	23
If a problem occurs	23
Specifications	25
Manufacturer Declarations	27



For more detailed information on the individual sections of this instruction manual, visit the corresponding product page on our website at www.sennheiser.com.

Important safety instructions

- Read this instruction manual.
- Keep this instruction manual. Always include this instruction manual when passing the product and the mains unit on to third parties.
- Heed all warnings and follow all instructions in this instruction manual.
- Only clean the product and the mains unit when they are not connected to the mains. Use a cloth for cleaning.
- Never open the product, otherwise you can receive an electric shock. If products are opened by customers in breach of this instruction, the warranty becomes null and void.
- Refer all servicing to qualified service personnel.
Servicing is required if the product or the mains unit have been damaged in any way, liquid has been spilled, objects have fallen inside, the product or the mains unit have been exposed to rain or moisture, do not operate properly or have been dropped.
- **WARNING:** To reduce the risk of fire or electric shock, do not use the product and the mains unit near water and do not expose them to rain or moisture. Do not place objects filled with liquids, such as vases or coffee cups, on the product.
- Only use the supplied mains unit.
- Unplug the mains unit from the wall socket
 - to completely disconnect the device from the mains,
 - during lightning storms or
 - when unused for long periods of time.
- Only operate the mains unit from the type of power source specified in the chapter “Specifications” (see page 25).
- Ensure that the mains unit is
 - in a safe operating condition and easily accessible,
 - properly plugged into the wall socket,
 - only operated within the permissible temperature range,
 - not covered or exposed to direct sunlight for longer periods of time in order to prevent heat accumulation (see “Specifications” on page 25).
- Do not block any ventilation openings. Install the product and the mains unit in accordance with the instructions given in this instruction manual.
- Do not install the product and the mains unit near any heat sources such as radiators, stoves, or other devices (including amplifiers) that produce heat.
- Only use attachments/accessories specified by Sennheiser.
- When replacement parts are required, only use replacement parts specified by Sennheiser or those having the same characteristics as the original part. Unauthorized substitutions may result in fire, electric shock, or other hazards.
- Do not overload wall outlets and extension cables as this may result in fire and electric shock.

Danger due to high volumes

This product is also intended for professional use. Commercial use is subject to the safety-at-work regulations. Sennheiser, as the manufacturer, is therefore obliged to expressly point out possible health risks arising from use.

This product is capable of producing sound pressure exceeding 85 dB(A). 85 dB(A) is the sound pressure corresponding to the maximum permissible volume which is by law (in some countries) allowed to affect your hearing for the duration of a working day. It is used as a basis according to the specifications of industrial medicine. Higher volumes or longer durations can damage your hearing. At higher volumes, the duration must be shortened in order to prevent hearing damage. The following are sure signs that you have been subjected to excessive noise for too long a time:

- You can hear ringing or whistling sounds in your ears.
- You have the impression (even for a short time only) that you can no longer hear high notes.

Intended use

Intended use of the SR 300 IEM G3 transmitter includes:

- having read this instruction manual especially the chapter "Important safety instructions",
- using the product within the operating conditions and limitations described in this instruction manual.

"Improper use" means using the product other than as described in these instructions, or under operating conditions which differ from those described herein.

The evolution wireless series ew 300 IEM G3

This transmitter is part of the evolution wireless series generation 3 (ew G3). With this series, Sennheiser offers high-quality state-of-the-art RF transmission systems with a high level of operational reliability and ease of use. Transmitters and receivers are designed for monitoring applications and permit wireless transmission with studio-quality sound.

The SR 300 IEM G3 rack-mount transmitter

With the SR 300 IEM G3 2-channel/stereo monitoring transmitter, musicians, video and sound amateurs, reporters/broadcasters, etc. can directly monitor the received sound signals without troublesome cables or monitor speakers being required. In addition, it can also be used for any application where talkback signals are to be transmitted.

Features of the SR 300 IEM G3 transmitter:

- Optimized PLL synthesizer and microprocessor technology
- Stereo/mono selection
- HDX noise reduction system
- Switching bandwidth of 42 MHz
- Safe configuration of a multi-channel system using the WSM
- Easy setup of a multi-channel system using the Easy Setup Sync function

The frequency bank system

The transmitter is available in 6 UHF frequency ranges with 1,680 transmission frequencies per frequency range:

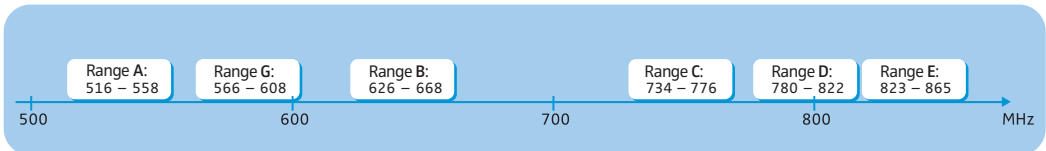

Each frequency range (A–E, G) offers 26 frequency banks with up to 16 channels each:

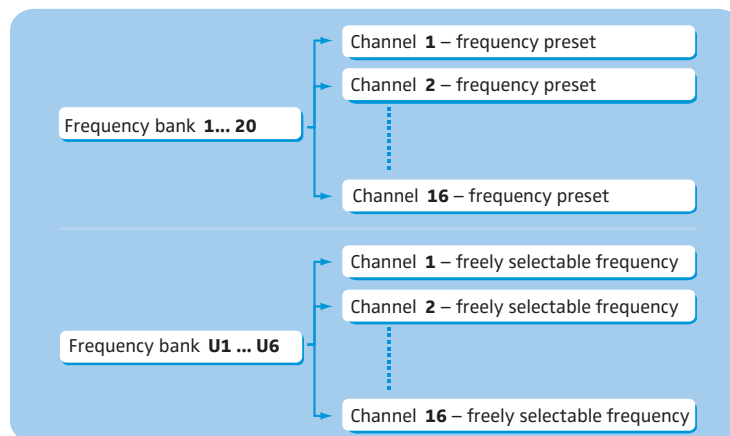

Each of the channels in the frequency banks “1” to “20” has been factory-preset to a fixed transmission frequency (frequency preset). The factory-preset frequencies within one frequency bank are intermodulation-free. These frequencies cannot be changed.

For an overview of the frequency presets, please refer to the supplied frequency information sheet. Updated versions of the frequency information sheet can be downloaded from the corresponding product page on our website at www.sennheiser.com.

The frequency banks “U1” to “U6” allow you to freely select and store transmission frequencies. It might be that these transmission frequencies are **not** intermodulation-free (see page 22).

Delivery includes

The packaging contains the following items:

- 1 SR 300 IEM G3 rack-mount transmitter
- 1 NT 2-3 mains unit with one country adapter
- 1 rod antenna
- 1 GA 3 rack adapter
- 1 instruction manual
- 1 frequency information sheet
- 1 RF licensing information sheet
- 4 device feet

Product overview

Overview of the SR 300 IEM G3 transmitter

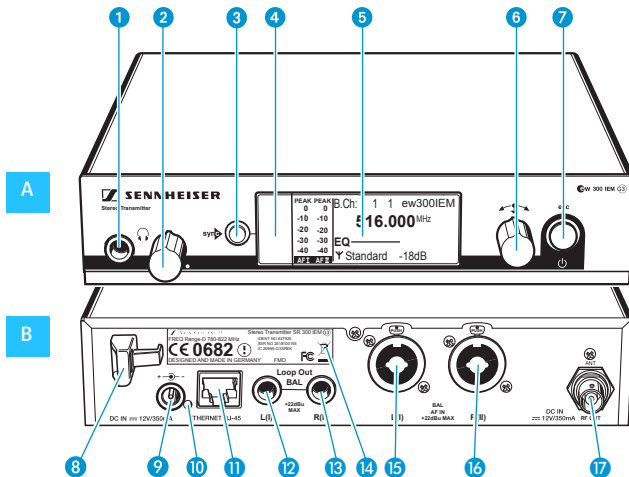

A Operating elements – front panel

- 1 Headphone output, 1/4" (6.3 mm) jack socket
- 2 Headphone volume control
- 3 **syn** button, backlit
- 4 Infra-red interface
- 5 Display panel, backlit in orange
- 6 Jog dial
- 7 **STANDBY** button with operation indication (red backlighting), serves as the ESC (cancel) key in the operating menu

B Operating elements – rear panel

- 8 Cable grip for power supply DC cable
- 9 DC socket (**DC IN**) for connection of NT 2-3 mains unit
- 10 LED (yellow) for network activity indication
- 11 LAN socket (**ETHERNET RJ 45**)
- 12 Audio output left (**LOOP OUT BAL L(I)**), 1/4" (6.3 mm) jack socket
- 13 Audio output right (**LOOP OUT BAL R(II)**), 1/4" (6.3 mm) jack socket
- 14 Type plate
- 15 Audio input left (**BAL AF IN L(I)**), 1/4" (6.3 mm) jack/XLR-3 combo socket
- 16 Audio input right (**BAL AF IN R(II)**), 1/4" (6.3 mm) jack/XLR-3 combo socket
- 17 Antenna output (**RF OUT**) with remote power supply input, BNC socket

Overview of the displays

After switch-on, the transmitter displays the standard display.

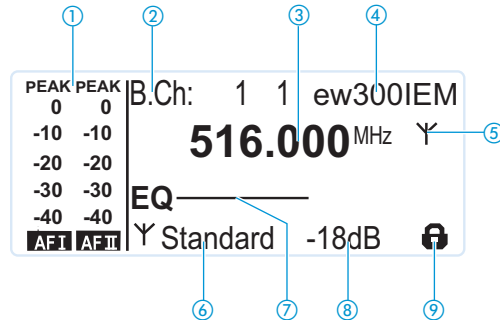

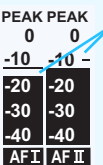
Display	Meaning
① Audio level "AF IN L(I)" and "AF IN R(II)" (AF = Audio Frequency)	 <p>Modulation of the left (I) and right (II) audio channel with peak hold function</p> <p>When the level displays for audio level show full deflection, the audio input level is excessively high. When the transmitter is overmodulated frequently or for extended periods of time, the "PEAK" display is shown inverted.</p>
② Frequency bank and channel	Current frequency bank and channel number
③ Frequency	Current transmission frequency
④ Name	Freely selectable name of the transmitter
⑤ Transmission icon	RF signal is being transmitted
⑥ Transmission power	Current transmission power
⑦ Equalizer setting	Current equalizer setting
⑧ Input sensitivity	Current input sensitivity for the audio signal available at the audio input sockets BAL AF IN L (I) ⑮ and BAL AF IN R (II) ⑯
⑨ Lock mode icon (see page 18)	Lock mode is activated

Putting the transmitter into operation

Preparing the transmitter for use



When using more than one transmitter, we recommend connecting remote antennas and, if necessary, using Sennheiser antenna accessories. For more information, visit the ew G3 product page at www.sennheiser.com.

Setting up the transmitter on a flat surface

Place the transmitter on a flat, horizontal surface. Please note that the device feet can leave stains on delicate surfaces.



The rack mount "ears" are designed to help protect the operating elements from damage or deformation, e.g. if the transmitter is dropped. Therefore, fasten the rack mount "ears", even if you do not want to rack mount your transmitter.

Mounting the rack mount "ears"

To fasten the rack mount "ears" ②1:

- ▶ Unscrew and remove the two recessed head screws (M4x8) on each side of the transmitter (see left-hand diagram).
- ▶ Secure the rack mount "ears" ②1 to the sides of the transmitter using the previously removed recessed head screws (see right-hand diagram).

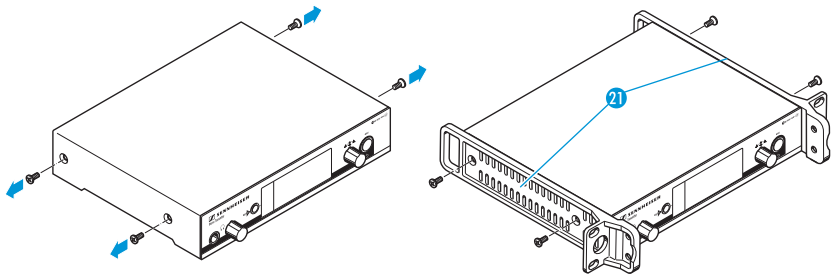

Fitting the device feet



Do not fit the device feet when mounting the transmitter into a 19" rack.

- ▶ Clean the base of the transmitter where you want to fix the device feet.
- ▶ Fit the device feet to the four corners of the transmitter.

Connecting the rod antenna

The supplied rod antenna 18 is suitable for use in good reception conditions.

- ▶ Connect the rod antenna 18 (see diagram).

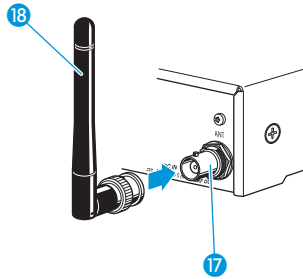

Mounting the transmitter into a 19" rack



Do not fit the device feet when mounting the transmitter into a 19" rack.

CAUTION!



Risks when rack mounting the transmitter!

When installing the device in a closed or multi-rack assembly, please consider that, during operation, the ambient temperature, the mechanical loading and the electrical potentials will be different from those of devices which are not mounted into a rack.

- ▶ Make sure that the ambient temperature within the rack does not exceed the permissible temperature limit specified in the SR 300 IEM G3 specifications. If necessary, provide additional ventilation.
- ▶ Make sure that the mechanical loading of the rack is even.
- ▶ When connecting to the power supply, observe the information indicated on the type plate. Avoid circuit overloading. If necessary, provide overcurrent protection.
- ▶ When rack mounting, please note that intrinsically harmless leakage currents of the individual mains units may accumulate, thereby exceeding the allowable limit value. As a remedy, ground the rack via an additional ground connection.

Rack mounting one transmitter

- ▶ Secure the rack mount "ears" 21 of the supplied GA 3 rack adapter to the transmitter as described on page 8.
- ▶ Secure the blanking plate 22 to one of the rack mount "ears" using two recessed head screws (M 6x10) (see diagram).

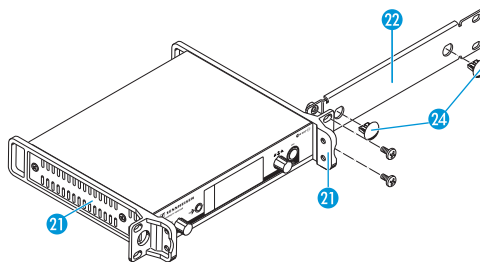

- ▶ Connect the antenna. You have the following options:
 - You can connect the supplied rod antenna 18 to the rear of the transmitter (see page 9). In this case, insert the two blanking plugs 24 into the holes of the blanking plate (see diagram on page 9).
 - You can use the AM 2 antenna front mount kit (optional accessory) and mount the rod antenna to the blanking plate 22.
 - You can use a remote antenna, if necessary in conjunction with the AC 3 antenna combiner.
- ▶ Slide the transmitter with the mounted blanking plate 22 into the 19" rack.
- ▶ Secure the rack mount "ear" 21 and the blanking plate 22 to the 19" rack.

Rack mounting two transmitters

To mount two transmitters into a rack using the GA 3 rack adapter:

- ▶ Place the two transmitters side by side upside-down onto a flat surface.

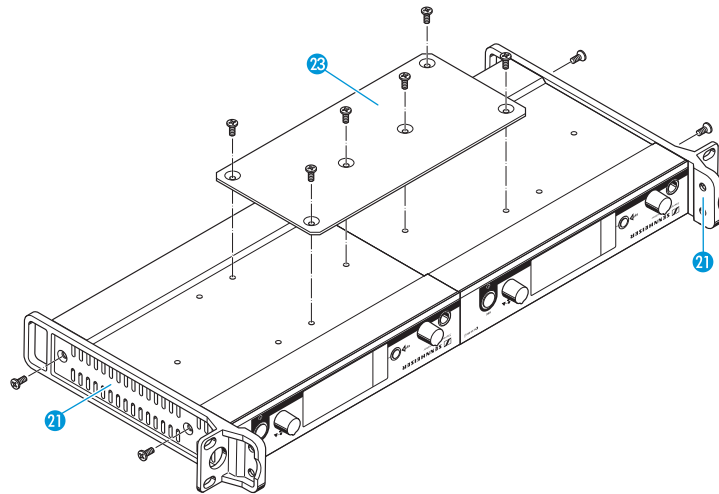

- ▶ Secure the jointing plate 23 to the transmitters using six recessed head screws (M 3x6).
- ▶ Secure the rack mount "ears" 21 to the transmitters as described on page 8.

To mount the antennas:

- ▶ Use remote antennas, if necessary in conjunction with the AC 3 antenna combiner.
For more information, visit the ew G3 product pages at www.sennheiser.com.

To mount the transmitters into the rack:

- ▶ Slide the transmitters into the 19" rack.
- ▶ Secure the rack mount "ears" to the 19" rack.

Connecting external devices

Connecting external devices to the input sockets

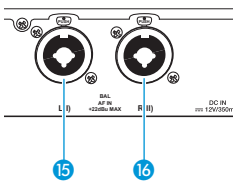

- ▶ Use a suitable cable to connect the output of an external device (e.g. a mixing console or an additional SR 300 IEM G3) to the input socket **BAL AF IN L(I)** 15 and/or **BAL AF IN R(II)** 16 (see also page 17).
- ▶ Adjust the output level of your external device.
- ▶ Via the operating menu, adjust the transmitter's input sensitivity. The input sensitivity is adjusted via the "Sensitivity" menu item and is common for both inputs (see page 20).



The input amplifier of the SR 300 IEM G3 is designed for line level input.

Connecting external devices to the output sockets

- ▶ Use a suitable cable to connect the input of an external device (e.g. a mixing console or an additional SR 300 IEM G3) to the output socket **LOOP OUT BAL L(I)** 12 and/or **LOOP OUT BAL R(II)** 13 (see also page 17).



The signal received from the AF input sockets **BAL AF IN L(I)** 15 and **BAL AF IN R(II)** 16 is actively buffered and then routed to the output sockets **LOOP OUT BAL L(I)** 12 and **LOOP OUT BAL R(II)** 13. The AF output sockets will therefore work only when the transmitter is switched on and powered.

Connecting a remote antenna to the BNC socket

Use a remote antenna when the transmitter position is not the best antenna position for optimum transmission. You can choose between two antennas:

- A 2003 UHF passive directional antenna
 - A 1031 passive omni-directional antenna
- ▶ Use a low-attenuation 50-Ω cable to connect the antenna to the transmitter.
 - ▶ If possible, use a short antenna cable and as little connections as possible, since long cables and many connectors lead to an attenuation of the antenna signal.
 - ▶ Position the antenna in the same room in which the transmission takes place.
 - ▶ Observe a minimum distance of 1 m between the antenna and metal objects (including reinforced concrete walls).

Connecting the AC 3 antenna combiner to the BNC socket

To make multi-channel systems, you should use the AC 3 antenna combiner (optional accessory). The AC 3 allows you to operate up to four transmitters with a single antenna without virtually any intermodulation.

In addition, the AC 3 incorporates DC distribution to enable simultaneous powering of up to four transmitters via its BNC sockets.

- ▶ Connect the AC 3 antenna combiner to the BNC socket 17.

Connecting transmitters in a network

You can connect several transmitters in a network. The transmitters are remote controlled via a PC running the “Wireless Systems Manager” (WSM) software. This software will assist in the quick and safe configuration of multi-channel systems.



The “Wireless Systems Manager” (WSM) software can be downloaded from the corresponding product page on our website at www.sennheiser.com.

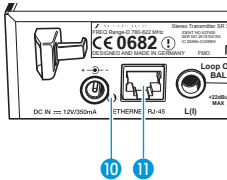

- ▶ Connect a standard network cable (at least Cat 5) to the LAN socket 11 of the transmitter.
- ▶ Connect your transmitters to an Ethernet switch.
- ▶ Connect a PC to the Ethernet switch.
When a transmitter is properly connected to the Ethernet switch or the PC, the yellow LED 10 at the rear of the transmitter lights up.

For further information on network operation, refer to page 22.

Connecting the mains unit

Only use the supplied mains unit. It is designed for the transmitter and ensures safe operation.

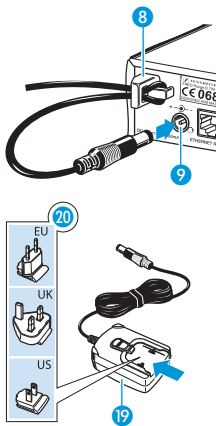

- ▶ Insert the yellow connector of the NT 2-3 mains unit into the yellow socket 9 of the transmitter.
- ▶ Pass the cable of the mains unit through the cable grip 8.
- ▶ Slide the supplied country adapter 20 onto the mains unit 19.
- ▶ Plug the mains unit 19 into a wall socket.
The **STANDBY** button is backlit in red.



The AC 3 antenna combiner incorporates DC distribution to enable simultaneous powering of up to four transmitters via its BNC sockets. These transmitters do not require their individual power supply (see also page 11).

Using the transmitter

To establish a transmission link, proceed as follows:

1. Switch the transmitter on (see below).
2. Switch the receiver on (see the instruction manual of the receiver).
The transmission link is established.



It is vital to observe the notes on frequency selection on page 21.

If you cannot establish a transmission link between transmitter and receiver:

- ▶ Make sure that transmitter and receiver are set to the same frequency bank and to the same channel.
- ▶ If necessary, read the chapter "If a problem occurs ..." on page 23.

Switching the transmitter on/off

To switch the transmitter **on** (online operation):



- ▶ Press the **STANDBY** button **7**.
The transmitter switches on and the standard display appears.
The transmitter transmits an RF signal and the transmission icon **5** is displayed



You can switch the transmitter on and deactivate the RF signal on switch-on. For more information, see below.

To switch the transmitter to **standby mode**:

- ▶ If necessary, deactivate the lock mode (see page 18).
- ▶ Keep the **STANDBY** button **7** pressed until "OFF" appears on the display panel. The display panel switches off.



When in the operating menu, pressing the **STANDBY** button **7** will cancel your entry (ESC function) and return you to the standard display.

The **STANDBY** button **7** is backlit in red both during operation and in standby mode.

To completely switch the transmitter **off**:

- ▶ Disconnect the transmitter from the mains by unplugging the mains unit from the wall socket.
The backlighting of the **STANDBY** button **7** goes off.

To switch the transmitter **on** and to **deactivate the RF signal on switch-on** (offline operation):



- ▶ Press the **STANDBY** button **7** until "RF Mute On?" appears on the display panel.



- ▶ Press the jog dial.
The transmission frequency is displayed but the transmitter does not transmit an RF signal. The transmission icon **5** is not displayed.

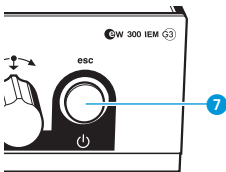



Use this function to prepare a transmitter for use during live operation without causing interference to existing transmission links.

To **activate** the RF signal:



- ▶ Briefly press the **STANDBY** button 7.
"RF Mute Off" appears on the display panel.



- ▶ Press the jog dial.
The transmission icon 5 is displayed again.

Monitoring the audio signal via headphones

You can monitor the audio signal via the headphone output.

CAUTION!



Danger of hearing damage!

Listening at high volume levels for long periods can lead to permanent hearing defects.

- ▶ Set the headphone volume control 2 to the minimum position before putting the headphones on.

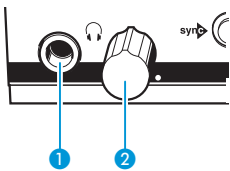

- ▶ Set the headphone volume control 2 to the minimum position.
- ▶ Connect headphones with a 1/4" (6.3 mm) stereo jack plug to the headphone output 1.
- ▶ Gradually increase the volume and monitor the audio signal with the lowest possible volume.



Synchronizing transmitters and receivers via the infra-red interface

Easy Setup Sync function (EK 300 IEM G3 -> SR 300 IEM G3)

Once you have performed a frequency preset scan with your EK 300 IEM G3 diversity receiver (see the instruction manual of the receiver), you can use the **Easy Setup Sync** function to transfer unused frequency presets from the receiver to the transmitters via the infra-red interface. The diversity receiver transfers the first unused channel from the current frequency bank to the first transmitter and the next unused channel to the second transmitter and so on.

Sync function (SR 300 IEM G3 -> EK 300 IEM G3)

On the other hand, you can use the **Sync** function to adjust settings for your EK 300 IEM G3 diversity receiver directly on your SR 300 IEM G3 rack-mount transmitter and transfer these settings to the receiver via the infra-red interface.

Via the "**Sync Settings**" submenu, you can adjust the parameters listed below and activate or deactivate their transfer to the receiver (see page 20).

Setting	Transferred parameters
"Balance"	Current balance setting ("−15"/"+15")
"Squelch"	Current squelch setting ("Off", "5 dB" ... "25 dB")
"Mode"	Current audio mode setting ("Stereo"/"Focus")
"High boost"	Current treble boost setting ("flat"/"High boost")
"Auto Lock"	Current lock mode setting ("active"/"inactive")
"Limiter"	Current limiter setting ("−18 dB", "−12 dB", "−6 dB", "Off")



When carrying out the [Sync](#) function, the transmitter's current frequency bank and channel setting is automatically transferred to the receiver via the infra-red interface.

Carrying out an Easy Setup Sync or a Sync function

The following assumes that you are using the [Easy Setup Sync](#) function for setting up a multi-channel system. You can also use the [Easy Setup Sync](#) function for establishing a transmission link between one transmitter and one receiver.

Easy Setup Sync	Sync
<ul style="list-style-type: none"> ▶ Switch your rack-mount transmitters and your diversity receiver on. ▶ On all transmitters, call up the "Easy Setup" menu item. The text "Easy Setup Sync" and the icon appear on the display panels of the transmitters. The RF signal of the transmitters is automatically deactivated. ▶ Use your EK 300 IEM G3 diversity receiver to perform a frequency preset scan and select a frequency bank with a sufficient number of unused channels (see the instruction manual of the receiver). 	<ul style="list-style-type: none"> ▶ Switch your rack-mount transmitter and your diversity receiver on. ▶ Press the button 3 on the transmitter. The icon appears on the display panels of the transmitter.
	–

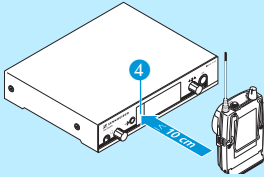
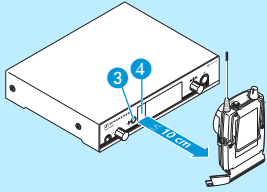
Easy Setup Sync	Sync
 <p>▶ Place the infra-red interface of the receiver (see the instruction manual of the receiver) in front of the infra-red interface 4 of the first transmitter. The next unused frequency preset is transferred from the receiver to the transmitter.</p> <p>As soon as the transfer is completed, the display panel of the transmitter displays the numbers of the transferred frequency bank and channel.</p> <p>Please note that the transmitter does not automatically store the frequency bank and channel setting.</p>	 <p>▶ Place the infra-red interface of the receiver (see the instruction manual of the receiver) in front of the infra-red interface 4 of your transmitter. The parameters adjusted via the "Sync Settings" menu item are transferred from the transmitter to the receiver.</p> <p>In addition, the current frequency bank and channel setting is transferred.</p> <p>When the transfer is completed, "✓" appears on the display panel of the transmitter. The transmitter then switches back to the standard display.</p> <p>The transferred parameters are automatically adjusted and stored by the receiver.</p> <p>The transmission link between transmitter and receiver is now established.</p>
<p>▶ Place the infra-red interface of the diversity receiver in front of the infra-red interfaces of the remaining transmitters, one after the other.</p> <p>▶ Store the frequency bank and channel setting by pressing the jog dial on your transmitters. You can carry out the Sync function (see right-hand column) at a later time to establish a transmission link between transmitters and receivers.</p> <p>OR:</p> <p>▶ Immediately synchronize your receivers with your transmitters by carrying out the Sync function (see right-hand column). This establishes a transmission link between transmitters and receivers. The sync icon in the left lower corner of the transmitter display indicates that the Sync function can be carried out.</p>	<p>–</p> <p>–</p>

Easy Setup Sync	Sync
–	<p>To cancel the transfer:</p> <ul style="list-style-type: none"> ▶ Press the STANDBY button on the transmitter. <p>“X” appears on the display panel of the transmitter. “X” also appears if no suitable receiver was found.</p>

Adjusting the audio channels

Via the “Mode” menu item, you can adjust the audio channels.

- ▶ Select “Stereo” if you want to transmit two separate audio signals on channel I and channel II (e.g. channel I = audio signal of the presenter/musician, channel II = sum of all audio signals).
This allows the presenter/musician to adjust the balance between the left and right stereo signal on his receiver.
- ▶ Select “Mono” if you only want to transmit an audio signal on one channel. In this case, the signal from the left audio input **BAL AF IN L 15** is transmitted.



During mono operation, you have to deactivate the pilot tone evaluation on the EK 300 IEM G3 receiver in order to ensure that your receiver outputs the same signal on channel I and II.

Daisy chaining audio signals

The output sockets **LOOP OUT BAL L 12** and/or **LOOP OUT BAL R 13** allow you to daisy chain a signal that is to be transmitted to all receivers from the mixing console to one transmitter and then to the other transmitters.

To daisy-chain an audio signal from one transmitter to the next:

- ▶ Route a signal from the mixing console to the input socket (in this example: **BAL AF IN R 15**) of transmitter **A**.
- ▶ Connect the output socket **LOOP OUT BAL R 13** of transmitter **A** to the input socket **BAL AF IN R 15** of transmitter **B**.
- ▶ Connect the output socket **LOOP OUT BAL R 13** of transmitter **B** to the input socket **BAL AF IN R 15** of transmitter **C**.
- ▶ Repeat for the other transmitters.



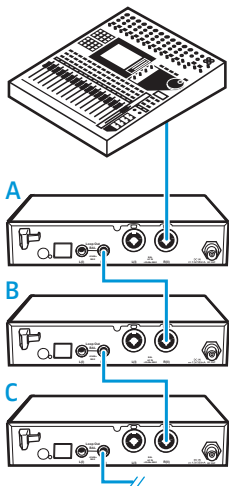

You can use the output sockets **LOOP OUT BAL L(I) 12** and/or **LOOP OUT BAL R(II) 13** only when the transmitter is switched on (see page 11).



Deactivating the lock mode temporarily

You can activate or deactivate the automatic lock mode via the "Auto Lock" menu item. If the lock mode is activated, you have to temporarily deactivate it in order to be able to operate the transmitter:

-  ▶ Press the jog dial.
"Locked" appears on the display panel.
-  ▶ Turn the jog dial.
"Unlock?" appears on the display panel.
-  ▶ Press the jog dial.
The lock mode is temporarily deactivated:

When you are in the operating menu

The lock mode remains deactivated until you exit the operating menu.

When the standard display is shown

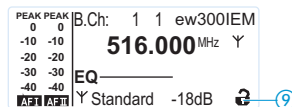

The lock mode is automatically activated after 10 seconds.

The lock mode icon  flashes prior to the lock mode being activated again.





Activating/deactivating the RF signal

To **deactivate** the RF signal:

-  ▶ When the standard display is shown on the display panel, press the **STANDBY** button.
"RF Mute On?" appears on the display panel.
-  ▶ Press the jog dial.
The RF signal is deactivated. "RF Mute" flashes in alternation with the standard display and the display is backlit in red.

To **activate** the RF signal:



-  ▶ Press the **STANDBY** button.
"RF Mute Off?" appears on the display panel.
-  ▶ Press the jog dial.
The RF signal is activated and the display backlighting changes from red to orange.



You can also deactivate the RF signal on switch-on. For more information, refer to the chapter "Switching the transmitter on/off" on page 13.

Using the operating menu

The buttons

Button	Function of the button
Press the STANDBY button 	<ul style="list-style-type: none"> • Switches the transmitter on and off • Cancels the entry and returns to the standard display (ESC function) • Activates/deactivates the RF signal (special function, see page 18)
Press the jog dial 	<ul style="list-style-type: none"> • Changes from the standard display to the operating menu • Calls up a menu item • Enters a submenu • Stores the settings and returns to the operating menu
Turn the jog dial 	<ul style="list-style-type: none"> • Changes to the next/previous menu item • Changes the setting of a menu item

Overview of the operating menu



For more detailed information on the operating menu, refer to the instruction manual of the SR 300 IEM G3. This instruction manual can be downloaded from the SR 300 IEM G3 product page at www.sennheiser.com.

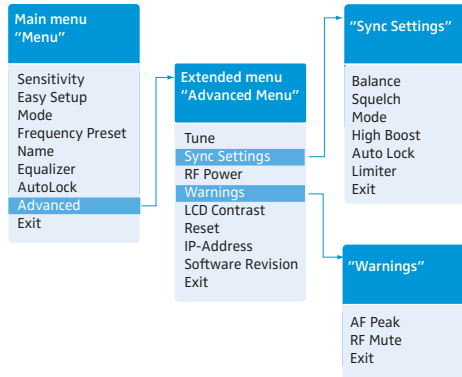

When the standard display is shown on the display panel, you can get into the main menu by pressing the jog dial. The extended menu **"Advanced Menu"** and the other menus can be accessed via the corresponding menu items.

Display	Function of the menu item
Main menu "Menu"	
Sensitivity	Adjusts the input sensitivity
Easy Setup	Deactivates the RF signal and activates Easy Setup Sync (see page 21)
Mode	Selects mono or stereo operation
Frequency Preset	Changes the frequency bank and the channel
Name	Enters the transmitter name
Equalizer	Changes the frequency response of the output signal using a graphic equalizer
AutoLock	Activates/deactivates the automatic lock mode
Advanced	Calls up the extended menu "Advanced Menu"
Exit	Exits the operating menu and returns to the standard display
Extended menu "Advanced Menu"	
Tune	Sets the transmission frequencies for the frequency banks "U1" to "U6" Special function: Sets a channel and a transmission frequency for the frequency banks "U1" to "U6" : ▶ Select this menu item and call it up by pressing the jog dial 6 until the channel selection appears.
Sync Settings	Adjusts the parameters to be transferred to the receiver and activates/deactivates the transfer
RF Power	Adjusts the transmission power
Warnings	Activates/deactivates the warning messages
LCD Contrast	Adjusts the contrast of the display panel
Reset	Resets the transmitter

Display	Function of the menu item
IP-Address	Adjusts the IP address of the transmitter
Software Revision	Displays the current software revision
Exit	Exits the extended menu "Advanced Menu" and returns to the main menu

"Sync Settings"

Adjusts the parameters to be transferred to the receiver and activates/deactivates the transfer. For an overview of the parameters, refer to page 14.

"Warnings"

Activates/deactivates warnings (color change and warning messages):

AF Peak	Audio overmodulation
RF Mute	RF signal is deactivated
Exit	Exits the submenu "Warnings" and returns to the extended menu "Advanced Menu"

Synchronizing the transmitter with a receiver

When synchronizing your transmitter with a receiver, please observe the following:



- ▶ Only use a transmitter and a receiver from the same frequency range (see the type plate on the transmitter and the receiver).
- ▶ Make sure that the desired frequencies are listed in the enclosed frequency information sheet.
- ▶ Make sure that the desired frequencies are approved and legal in your country and, if necessary, apply for an operating license.

Synchronizing the transmitter with a receiver – individual operation

Upon delivery, transmitter and receiver are synchronized with each other. If, however, you cannot establish a transmission link between transmitter and receiver, you have to synchronize the channels of the devices:

- ▶ Carry out the [Easy Setup Sync](#) function and then the [Sync](#) function (see page 15).
The frequency of the selected frequency preset must be approved and legal in your country (see above).

Alternatively, you can set the channel on the transmitter manually:

- ▶ Make sure that you set the transmitter to the same frequency bank and the same channel as the receiver.

Synchronizing transmitters with receivers – multi-channel operation

Network operation using the WSM

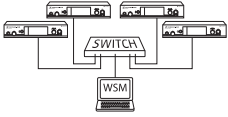

In multi-channel operation, the transmitters are remote controlled via a PC running the “Wireless Systems Manager” (WSM) software.



Advantages of controlling the transmitters via the “Wireless Systems Manager” (WSM) software:

- Detailed overview of all transmission and receiving channels
- Remote control of all transmitters in the network
- Combination of transmitters of different frequency ranges (see page 4)

Operation without network

- ▶ Connect your transmitters and your PC in a network (see page 12).
- ▶ Switch your transmitters and your PC on.
- ▶ Launch the “Wireless Systems Manager” (WSM) software.
- ▶ To set up your multi-channel system, proceed as described in the instruction manual of the “Wireless Systems Manager” (WSM) software.
- ▶ Carry out the **Easy Setup Sync** function and then, for each transmission link, the **Sync** function (see page 15).
The frequencies of the selected frequency presets must be approved and legal in your country (see above).

You can also freely select the frequencies and store these frequencies in the frequency banks “U1” to “U6”.

If you want to use the frequency banks “U1” to “U6”:

- ▶ Make sure to use transmitters and receivers from the same frequency range (see page 4 and the type plates of the devices).
- ▶ Only use frequencies that are approved and legal in your country (see page 21).



To ensure that the desired frequencies are intermodulation-free:

- ▶ Contact your Sennheiser partner (see www.sennheiser.com).
- ▶ Set each transmitter to the same frequency bank.
- ▶ On one of the transmitters, select a channel within this frequency bank (see page 20).
- ▶ Assign this channel one of the calculated transmission frequencies (see page 20).
- ▶ Synchronize a receiver with your transmitter (**sync**, see page 15).
- OR
- ▶ Manually set the receiver to the same frequency bank, channel and frequency that you set on the transmitter.
- ▶ Repeat for the remaining transmitters and receivers as described above.

Cleaning the transmitter

CAUTION!



Liquids can damage the electronics of the transmitter!

Liquids entering the housing of the device can cause a short-circuit and damage the electronics.

- ▶ Keep all liquids away from the transmitter.
- ▶ Before cleaning, disconnect the device from the mains.
- ▶ Use a slightly damp cloth to clean the device from time to time. Do not use any solvents or cleansing agents.

If a problem occurs ...

Problem	Possible cause	Possible solution
Transmitter cannot be operated, "Locked" appears on the display panel	Lock mode is activated	Deactivate the lock mode (see page 18 and page 20).
No operation indication	No mains connection	Check the connections of the mains unit.
No RF signal at the receiver	Transmitter and receiver are not on the same channel	Set the transmitter and receiver to the same channel. To do so, use the synchronization function (see page 14).
	If "RF Mute" additionally appears on the transmitter display: RF signal is deactivated	Activate the RF signal (see page 18).
Very weak RF signal at the receiver	Transmission range is exceeded	Check the squelch threshold setting on the receiver.
		Reduce the distance between receiver and transmitter.
		Increase the transmission power (see page 20).
RF signal available, no audio signal at the receiver	Receiver's squelch threshold is adjusted too high	Reduce the squelch threshold (see the instruction manual of the receiver). Reposition the antennas.
	No input signal at the transmitter	Check the audio level on the transmitter display (see page 7).
	Very low input signal	Check the audio level on the transmitter display (see page 7), increase the level of the input signal or adjust the input sensitivity (see page 20).
Audio signal has a high level of background noise	Transmitter sensitivity is adjusted too low	Adjust the transmitter sensitivity correctly.

Problem	Possible cause	Possible solution
Audio signal is distorted	If "AF PEAK" additionally appears on the transmitter display: transmitter sensitivity is adjusted too high	Adjust the transmitter sensitivity correctly.
	Receiver's audio output level is adjusted too high	Reduce the audio output level (see the instruction manual of the receiver).

If a problem occurs that is not listed in the above table or if the problem cannot be solved with the proposed solutions, please contact your local Sennheiser partner for assistance. To find a Sennheiser partner in your country, search at www.sennheiser.com under "Service & Support".



For accessories, visit the ew G3 product page at www.sennheiser.com.

Specifications

RF characteristics

Frequency ranges	516–558, 566–608, 626–668, 734–776, 780–822, 823–865 MHz (A to E, G, see page 4)
Transmission frequencies	1,680 frequencies, tuneable in steps of 25 kHz
Switching bandwidth	20 frequency banks, each with up to 16 factory-preset channels
Frequency stability	6 frequency banks with up to 16 user programmable channels
Antenna output	42 MHz
RF output power at 50 Ω	±10 ppm (–10°C to +55°C)
Frequency ranges	BNC socket, 50 Ω
Transmission frequencies	typ. 10/30 mW (Low/Standard), switchable

AF characteristics

Modulation	wideband FM stereo (MPX pilot tone)
Compander system	Sennheiser HDX
Nominal/peak deviation	±24 kHz/±48 kHz
MPX pilot tone (frequency/deviation)	19 kHz/±5 kHz
AF frequency response	25 Hz to 15 kHz
AF input BAL AF IN L (I)/BAL AF IN R (II)	2 x XLR-3/¼" (6.3 mm) jack combo socket, electronically balanced
Max. input level	+22 dBu
THD (at 1 kHz and nominal deviation)	< 0.9%
Signal-to-noise ratio at nominal load and peak deviation	> 90 dB
AF output LOOP OUT BAL L (I)/LOOP OUT BAL R (II)	¼" (6.3 mm) stereo jack socket, balanced

Overall device

Temperature range	–10°C to +55°C
Power supply	12 V ===
Current consumption	max. 350 mA
Dimensions	approx. 202 mm x 212 mm x 43 mm
Weight	approx. 980 g

In compliance with

Europe	EMC	EN 301489-1/-9
	Radio	EN 300422-1/-2
	Safety	EN 60065

Approved by

Canada

Industry Canada RSS 210,
IC: 2099A-G3SREK
limited to 806 MHz

USA

FCC-Part 74 FCC-ID: DMOG3SREK
limited to 698 MHz

NT 2-3 mains unit

Input voltage

100 to 240 V~, 50/60 Hz

Current consumption

max. 120 mA

Output voltage

12 V ===

Secondary output current

400 mA

Temperature range

-10°C to +40°C

In compliance with

Europe

CE EMC EN 55022, EN 55024,
EN 55014-1/-2
Safety EN 60065

USA



FC 47 CFR 15 subpart B

Canada

ICES 003

The mains unit is certified in accordance with the legal safety requirements of Europe, the United States, Canada, Russia and Japan.

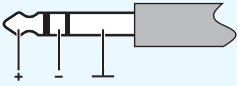
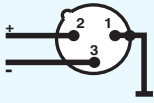
Connector assignment

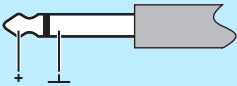
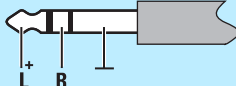
Audio		Other connectors
<p>¼" (6.3 mm) stereo jack plug, balanced (Audio In/Loop out)</p> 	<p>XLR-3F connector, balanced (Audio In)</p> 	<p>DC connector for power supply</p> 
<p>¼" (6.3 mm) mono jack plug, unbalanced</p> 	<p>¼" (6.3 mm) stereo jack plug for headphone output</p> 	

Manufacturer Declarations

Warranty

Sennheiser electronic GmbH & Co. KG gives a warranty of 24 months on this product.

For the current warranty conditions, please visit our web site at www.sennheiser.com or contact your Sennheiser partner.

In compliance with the following requirements

- RoHS Directive (2002/95/EC)
- WEEE Directive (2002/96/EC)



Please dispose of the transmitter at the end of its operational lifetime by taking it to your local collection point or recycling center for such equipment.

CE Declaration of Conformity

- **CE 0682** ⓘ
- R&TTE Directive (1999/5/EC), EMC Directive (2004/108/EC), Low Voltage Directive (2006/95/EC)
The declarations are available at www.sennheiser.com.
Before putting the device into operation, please observe the respective country-specific regulations.

Statements regarding FCC and Industry Canada

This device complies with Part 15 of the FCC Rules and with RSS-210 of Industry Canada. Operation is subject to the following two conditions: (1) this device may not cause harmful interference, and (2) this device must accept any interference received, including interference that may cause undesired operation.

This equipment has been tested and found to comply with the limits for a Class B digital device, pursuant to Part 15 of the FCC Rules. These limits are designed to provide reasonable protection against harmful interference in a residential installation. This equipment generates, uses and can radiate radio frequency energy and, if not installed and used in accordance with the instructions, may cause harmful interference to radio communications. However, there is no guarantee that interference will not occur in a particular installation. If this equipment does cause harmful interference to radio or television reception, which can be determined by turning the equipment off and on, the user is encouraged to try to correct the interference by one or more of the following measures:

- Reorient or relocate the receiving antenna.
- Increase the separation between the equipment and receiver.
- Connect the equipment into an outlet on a circuit different from that to which the receiver is connected.
- Consult the dealer or an experienced radio/TV technician for help.

This class B digital device complies with the Canadian ICES-003.

Changes or modifications made to this equipment not expressly approved by Sennheiser electronic Corp. may void the FCC authorization to operate this equipment.

Before putting the device into operation, please observe the respective country-specific regulations!

Sennheiser electronic GmbH & Co. KG
Am Labor 1, 30900 Wedemark, Germany
www.sennheiser.com

Printed in Germany
Publ. 01/09
529680/A01

Free Manuals Download Website

<http://myh66.com>

<http://usermanuals.us>

<http://www.somanuals.com>

<http://www.4manuals.cc>

<http://www.manual-lib.com>

<http://www.404manual.com>

<http://www.luxmanual.com>

<http://aubethermostatmanual.com>

Golf course search by state

<http://golfingnear.com>

Email search by domain

<http://emailbydomain.com>

Auto manuals search

<http://auto.somanuals.com>

TV manuals search

<http://tv.somanuals.com>