

# INSTRUCTION FOR USE

# EM 203

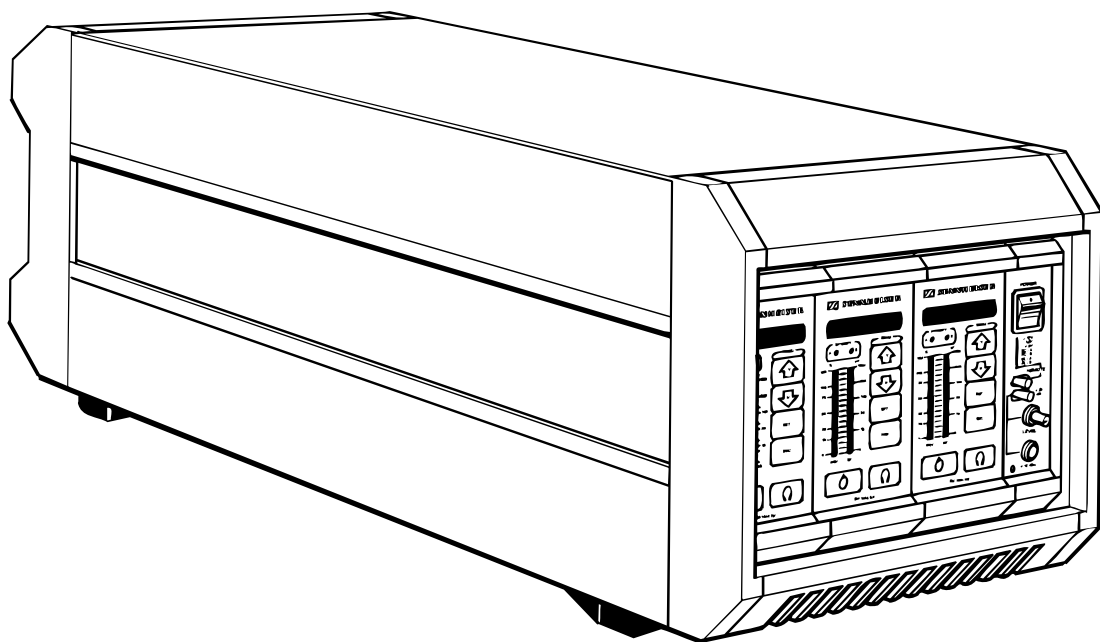

## CONTENTS

<b>1</b>	<b>TECHNICAL OVERVIEW</b>
1.1	Computer Control
1.2	Diversity
1.3	HIDYN plus <sup>®</sup> noise reduction system
1.4	Block diagrams
<b>2</b>	<b>POSSIBLE TRANSMITTER/RECEIVER COMBINATIONS</b>
2.1	EM 203 receiver/SK 2012 TV(HiDyn plus <sup>®</sup> ) and SKM 4031 HiDyn plus <sup>®</sup>
2.2	EM 203 receiver/SK 50/250 UHF and SKM 5000 (HiDyn plus <sup>®</sup> )
2.3	EM 203 receiver/SER 20 transceivers
<b>3</b>	<b>PUTTING THE EM 203 TO WORK</b>
3.1	Mains connection
3.2	Antenna connection
3.3	AF connection
3.4	Start-up procedure/operating indicators
<b>4</b>	<b>AVAILABLE MODULES</b>
<b>4.1</b>	<b>EM 1046 RX RECEIVER MODULE</b>
4.1.1	Adjustment
4.1.2	Receiver frequencies
4.1.3	Squelch
4.1.4	Selection RF signal/deviation/battery condition
4.1.5	Display-text/frequency/battery condition
4.1.6	Entry of brief text
4.1.7	System configurations and specifications
4.1.8	Remote monitoring of transmitter battery
4.1.9	Monitoring of audio signals
4.1.10	Stand-by
<b>4.2</b>	<b>MONITOR</b>
4.2.1	LED indicators
4.2.2	Monitor headphones
<b>5</b>	<b>TECHNICAL DATA</b>

# Introduction

The wireless Mikroport multi-channel sound transmission system EM 1046 is a transmitter/receiver system in a modular design. It offers comfortable handling and can be relied on for dependable service.

- 3-channel diversity receiver EM 203 with microprocessor-controlled receiver modules
- Ultimate flexibility in the selection of transmitter and receiver frequencies thanks to easy-to-replace PROMs and EEPROMs.

The present manual shall help you to get acquainted with the EM 203 receiver.



- The chapter "**START-UP PROCEDURE**" helps you to connect the unit to the mains and to put it to work.



- The chapter "**AVAILABLE MODULES**" provides you with information on every single module. It explains how to adjust them to satisfy your individual transmission requirements.

The necessary modules for this receiver system are incorporated into a "Mainframe". For programming and servicing, the EM 1046 RX receiver modules can be removed to the front. Output module, input module and mains power supply module, however, are integral parts of the system.

## IMPORTANT INFORMATION

Each HF input is supplied with a wideband power distributor 1:3, which intendedly does not affect the adjustment possibilities of the EM 1046 RX receiver modules. In order to achieve sufficient sensitivity and protection against subscriber's extension stations, an antenna with booster and pre-selection is required. In general, Sennheiser's AB 1036 TV antenna booster is used.

---

Refer programming of the EEPROMs in the receiver modules to qualified service personnel or Sennheiser's Service Department, 30900 Wedemark, Germany.

<b>Computer control</b>	<b>1.1</b>
<b>Diversity</b>	<b>1.2</b>
<b>HiDyn plus<sup>®</sup> noise reduction</b>	<b>1.3</b>
<b>Block diagrams</b>	<b>1.4</b>

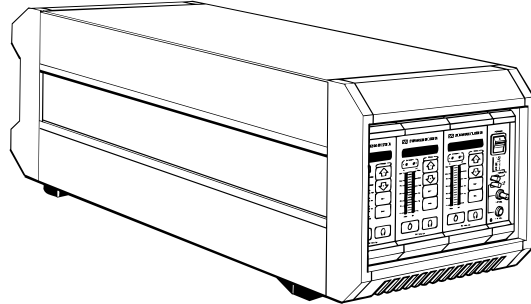

Every single EM 1046 RX receiver module has an in-built microprocessor for the RF section, the operating elements and all indicators. It serves to control the following components or parameters:

- phase locked loop (PLL) synthesizer
- function of keys
- 8 digit LED display
- two LED bargraph displays
- true diversity
- monitoring
- squelch threshold
- description fields
- stand-by
- storage of all receiver parameters (e. g. receiver frequencies) in a permanent memory

During diversity operations, the microprocessor controls every one of the two receiver chains that are combined on one module.

The receiver parameters and the selectable frequencies can easily be changed with the help of a conventional computer system as every receiver module incorporates an additional service interface. Changes are only possible within the admissible RF bandwidth.

The software can easily be adapted to your individual requirements and updated at any time by Sennheiser's Service Department. Our servicemen simply replace the PROM in the receiver modules.

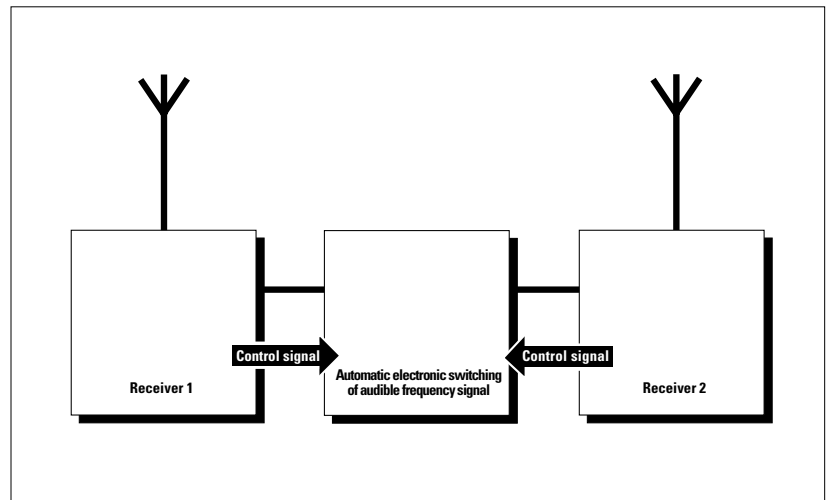

Every EM 1046 RX receiver module operates on true diversity. An antenna splitter, integrated into the chassis, serves to route the antenna signals from both antennas to the three receiver modules.

The receiving antenna not only receives direct electromagnetic waves, but also reflections from walls, windows, ceilings and other installations, which results in the cancellation of these waves, so-called „field strength gaps“. Repositioning the receiving antenna is a possible remedy, provided the transmitter remains in its original position. However, as most transmitters are used for portable applications, the „field strength gaps“ then occur in other positions. The effects of field strength variations can only be eliminated through the use of true diversity techniques.

Sennheiser’s specially developed diversity system is based on two receivers operating on the same frequency and two separate antennas. A comparator ensures that the receiver with the strongest RF signal is automatically and noiselessly switched to the AF output. Diversity operations can compensate for considerable variations in field strength, thus providing an enormous gain in transmission reliability.

Nota bene: Every single EM 1046 RX receiver module incorporates two receivers for diversity operation.

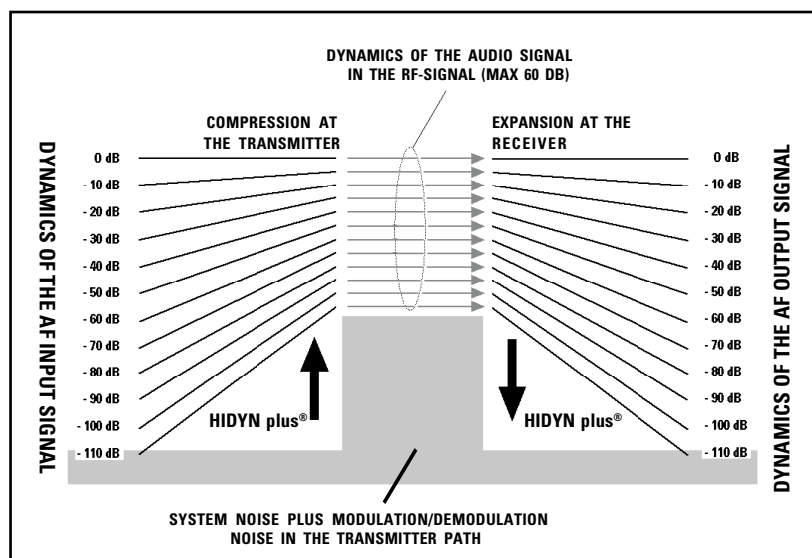

#### »HIDYN plus®« NOISE REDUCTION SYSTEM

The »HIDYN plus®« noise reduction system serves to reduce the effects of RF interference fields. It increases the signal-to-noise ratio and gets close to about 110 dB for peak modulation.

»HIDYN plus®« is a wideband compander system. It is a combination of a compressor at the transmitter (ratio 2:1) and an expander at the receiver, the compressor reducing the volume of the signal and the expander restoring it. The optimized dynamic range and the control amplifier in the transmitter effectively reduce modulation problems.

»HIDYN plus®« has been especially developed by Sennheiser for studio and stage applications.

Its features:

- extremely low degree of noise modulation
- level compensation
- excellent dynamic range due to the control amplifier

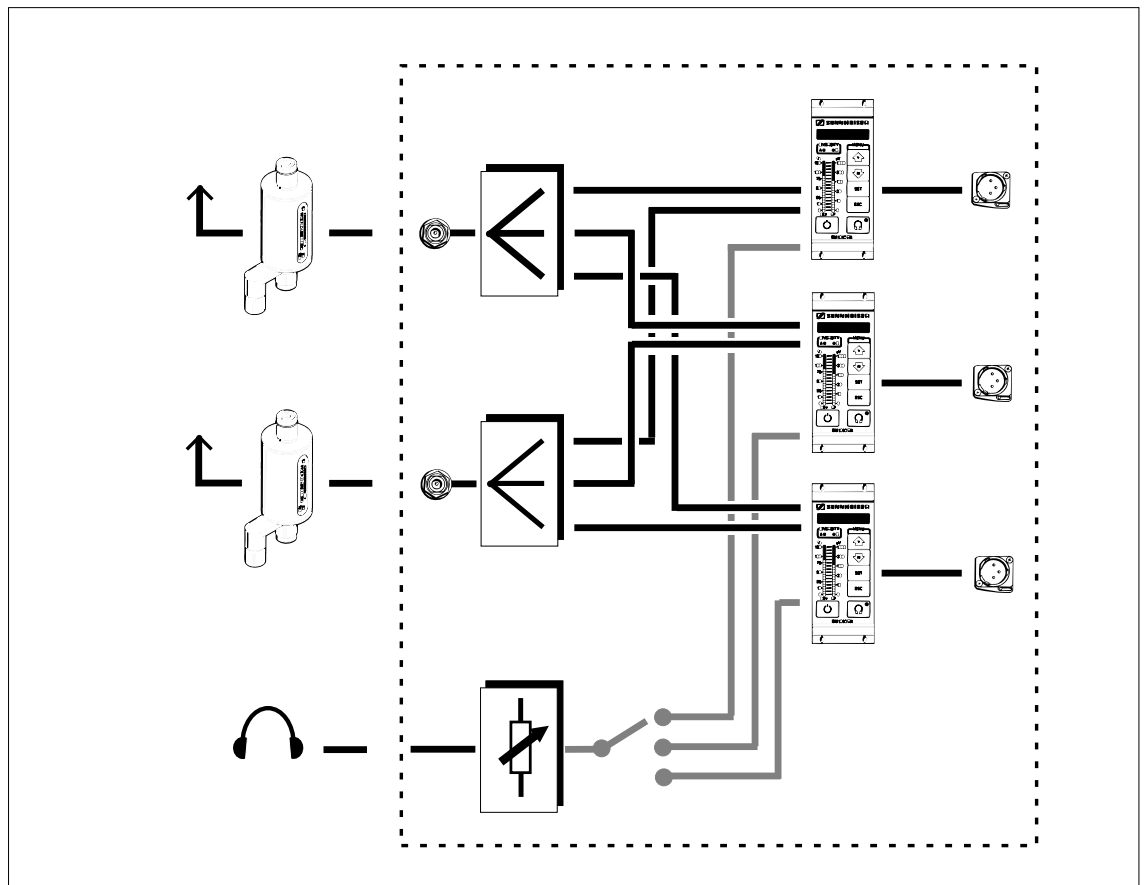
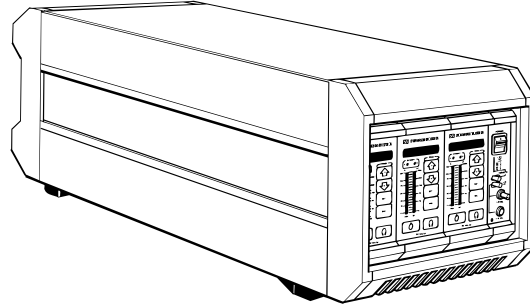



## **Possible transmitter/ receiver combinations**

**2**

**EM 203 receiver/  
SK 2012 TV (HiDyn plus®)  
and SKM 4031 TV-HiDyn plus®  
Transmitters**

**2.1**

**EM 203 receiver/  
SK 50/250 UHF  
and SKM 5000 (HiDyn plus®)  
Transmitters**

**2.2**

**EM 203 RECEIVER/  
SER 20 TRANSCEIVER**

**2.3**

# EM 203 receiver/ SK 2012 TV (HiDyn plus®) and SKM 4031 TV-HiDyn plus®

**NOTA BENE**

SK 2012 body-pack transmitters can be retrofitted (change from HIDYN® to HIDYN plus®) to make them suitable for use with EM 1046 receivers.

To this purpose please send the transmitters to be retrofitted to Sennheiser's Service Department, 30900 Wedemark.

**Attention:** After the transmitters have been retrofitted, they are no longer compatible with HIDYN®.

**NOTA BENE**

SKM 4031 TV transmitter microphones can be used in conjunction with EM 203 systems if they incorporate a HIDYN plus® compander. This is the case with SKM 4031 HIDYN plus® condenser microphones.

Models incorporating a compander can be retrofitted. To this purpose please send the microphones to Sennheiser's Service Department, 30900 Wedemark, Germany.

**Attention:** After the transmitters have been retrofitted, they are no longer compatible with HIDYN®.

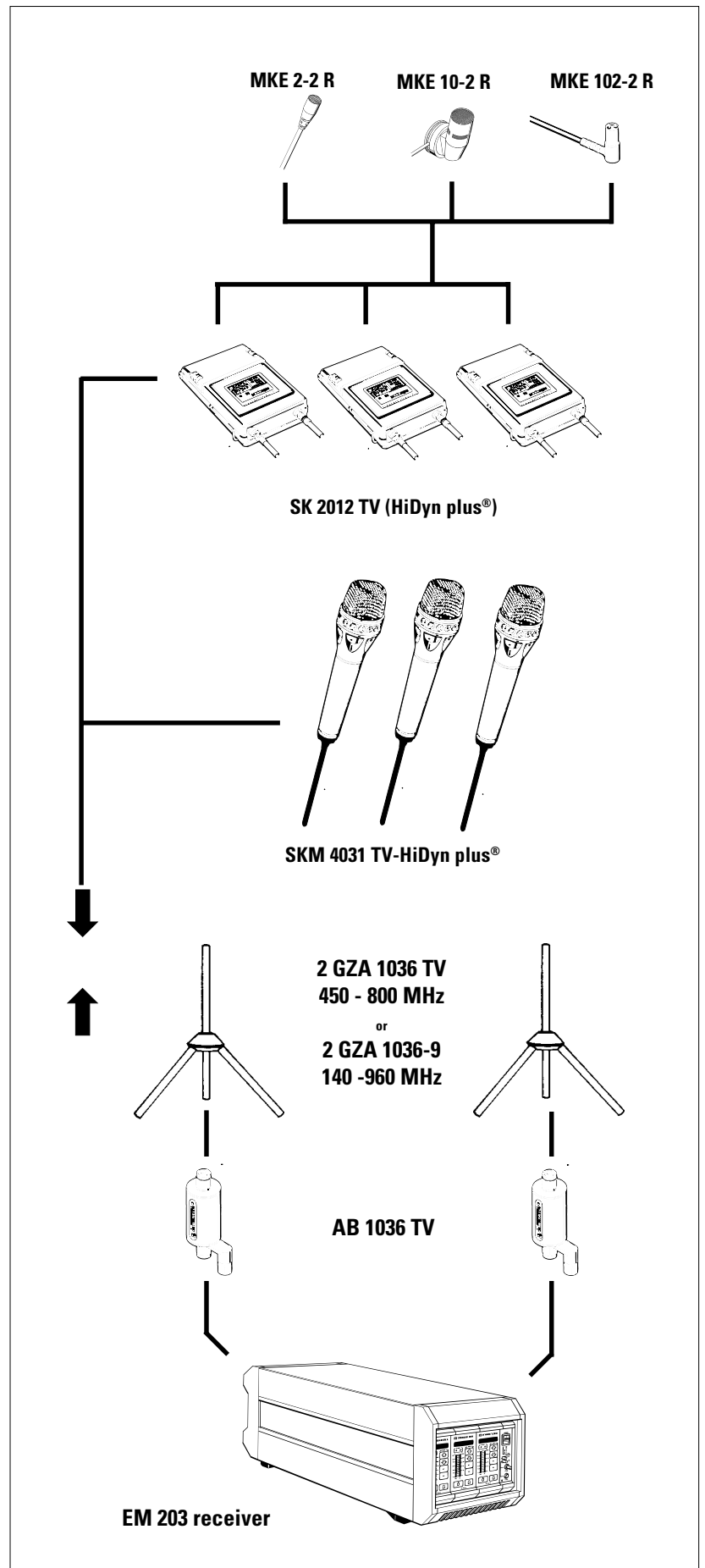

**EM 1046/  
SK 50 UHF / SK 250 UHF  
and SKM 5000**

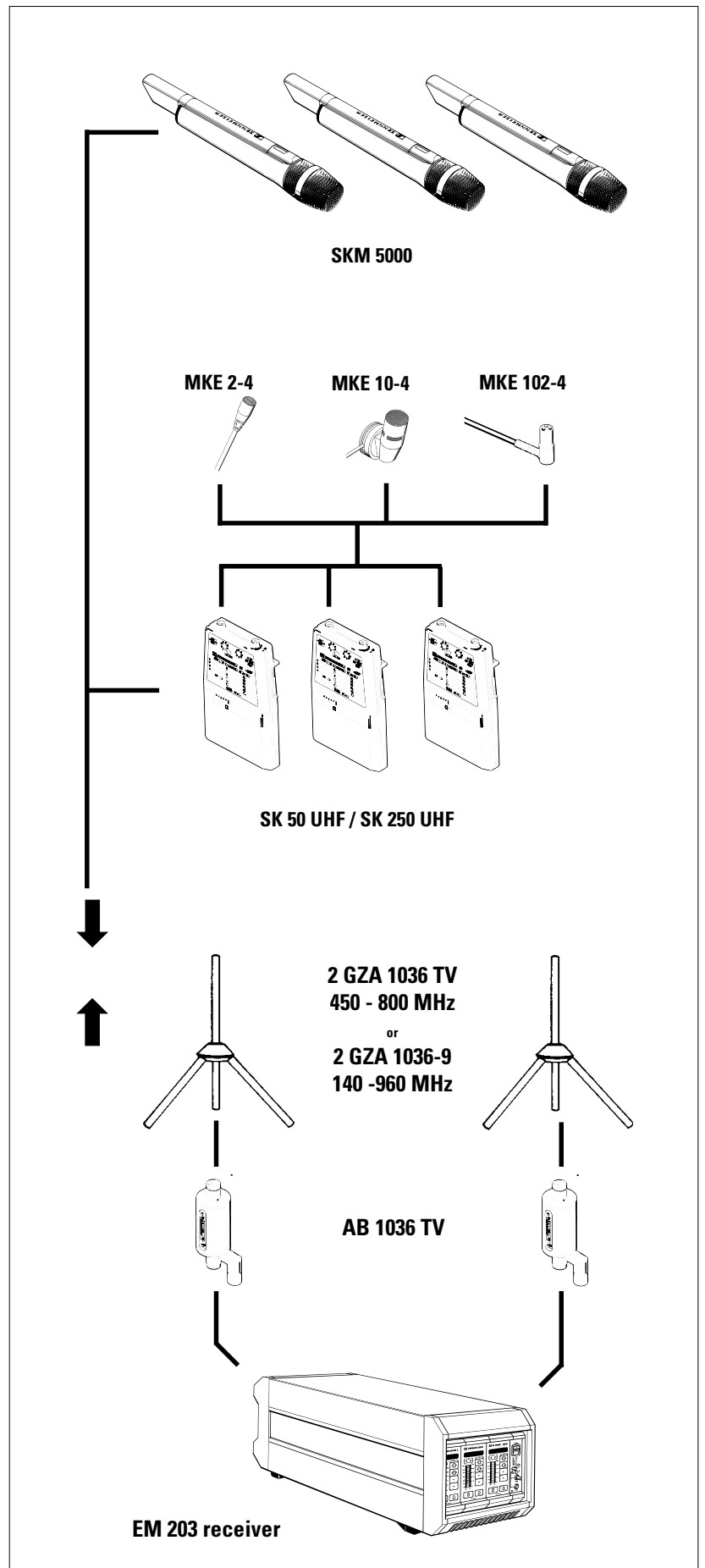

Retrofitted SER 20 transceivers (change from HIDYN® to HIDYN plus®) can be used in conjunction with EM 203 receivers.

Refer retrofitting to Sennheiser distributors or Sennheiser's Service Department, 30900 Wedemark, Germany.

At the time that the present brochure went to print the retrofit kit for the SER 20 transceiver was already under development. Please contact your Sennheiser distributor for further information on the exact date of delivery.

Another possibility:

If you don't need the advantages of HIDYN plus® (e.g. in order to operate with older equipment), the EM 203 receiver can be modified to HIDYN®.

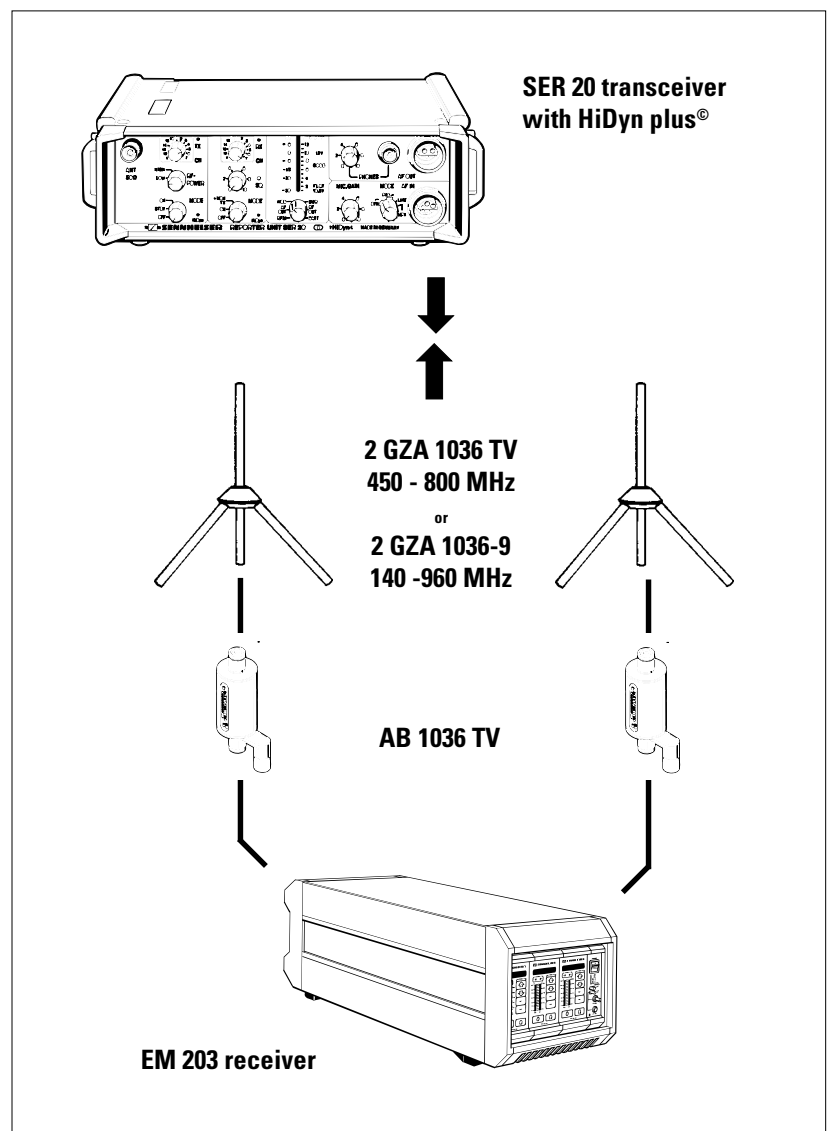

## Mains connection 3.1

## Antenna connection

3.2

## AF connection

3.3

## Start-up procedure/ operating indicators

3.4

Power is supplied by a plug-in power supply unit.

The power module is available as a 110, 230 or 240 V AC model. The unit can easily be adapted to changing power requirements by replacing the power module.

Connection of the plug-in power supply unit is via socket **P** at the back panel of the EM 203.

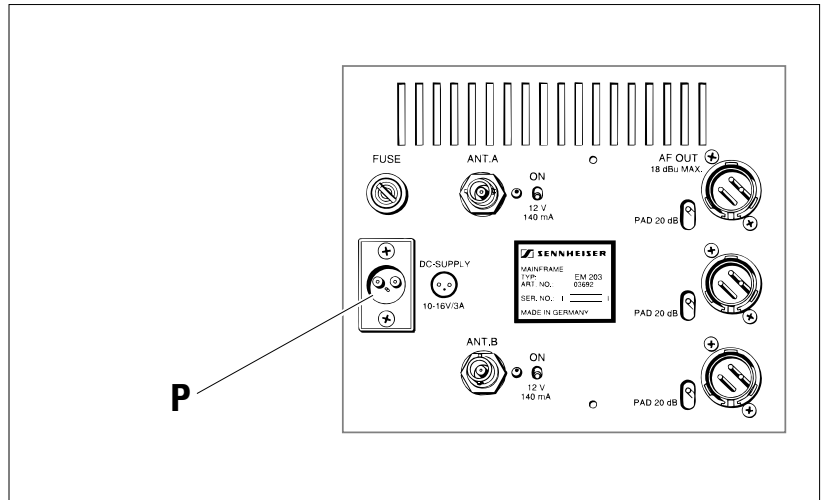

# Antenna connection

The two antennas needed for diversity operation (see **ch. 1.2**) connect to sockets **A** and **B** on the EM 302RI module (N-type sockets).

The AB 1036 TV antenna boosters connected in series are powered via sockets **A** and **B**. The supply voltage can be switched on or off by means of the switches next to the antenna sockets.

If the antenna boosters are in operation, the control LEDs for the booster supply voltage light up at the front panel (→ **ch. 4.2.1**).

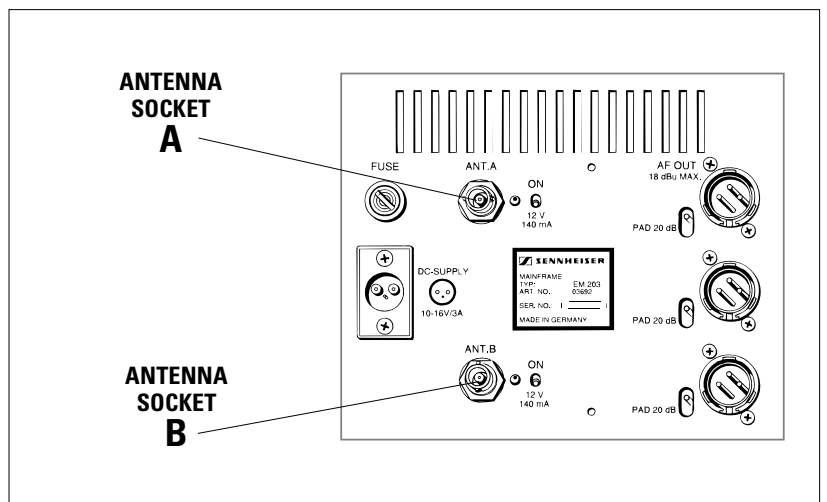

# AF connection

The AF output signals from every single EM 1046 RX receiver module are available at AF outputs 1 to 3 on the EM 203 module (floating, transformer-balanced). The connection is made through XLR-3 plugs.

The switches at the left-hand side of the XLR outputs ("PAD") allow to attenuate the output signals by 20 dB.

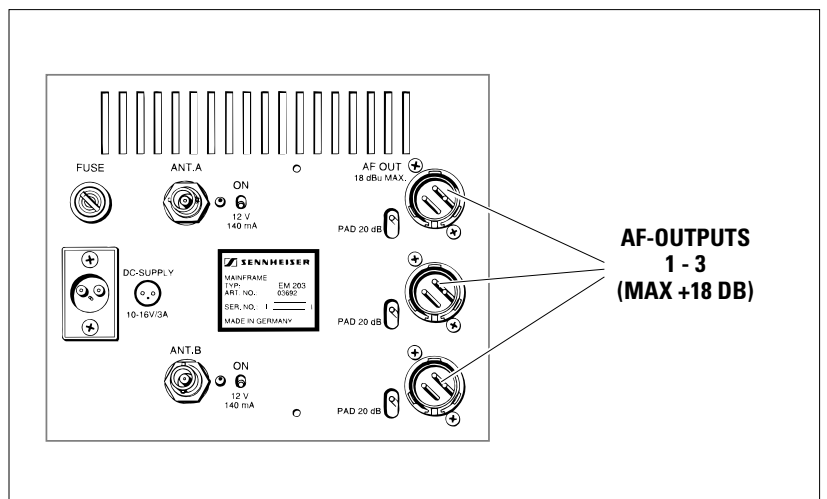

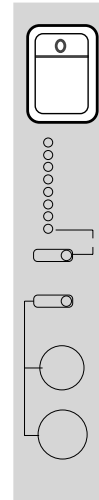

**MANIPULATION**

Switch on the receiver:

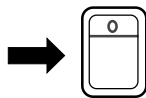

**FUNCTION**

This is how the channel module indicates that it is ready for operation (after power-up). The three LED indicators for the operating voltages light up (see **ch. 4.2.1**).

The display changes after about 5 seconds

It shows the frequency on which the module is operating

or

the name of the user, e. g. "THE CAT":

**DISPLAY (RX)**

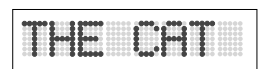
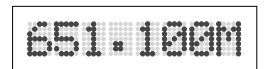

**NOTA BENE**

Put the transmitters to work (see their user's guide).

Check both transmitters and receivers for identical frequencies. Check whether or not the transmitters' battery capacity is sufficient for the planned applications.

Sennheiser SK 50, SK 250 and SK 5000 Mikroport transmitters automatically transfer data on the condition of their batteries or rechargeable battery packs to the EM 203 receiver. If the LowBatt indicator starts blinking on one of the displays, the batteries or rechargeable battery packs of the transmitters concerned are to be replaced or recharged.

The capacity of the transmitter battery is insufficient for proper operation. The transmitter will be switched off in about 10 minutes.

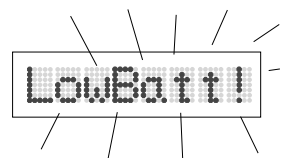

## **Available modules**

**4**

**EM 1046 RX  
receiver module**

**4.1**

**Monitor**

**4.2**



<b>EM 1046 RX receiver module</b>	<b>4.1</b>
<b>Adjustment</b>	<b>4.1.1</b>
<b>Receiver frequencies</b>	<b>4.1.2</b>
<b>Squelch</b>	<b>4.1.3</b>
<b>Selection RF Signal level/deviation/ battery condition</b>	<b>4.1.4</b>
<b>Display Text/frequency/battery condition</b>	<b>4.1.5</b>
<b>Entry of brief texts</b>	<b>4.1.6</b>
<b>System configurations and specifications</b>	<b>4.1.7</b>
<b>Remote monitoring Of transmitter battery</b>	<b>4.1.8</b>
<hr/>	
<b>Monitoring of audio signals</b>	<b>4.1.9</b>
<b>Stand-by</b>	<b>4.1.10</b>

## OPERATING ELEMENTS ON THE EM 1046 RX MODULE

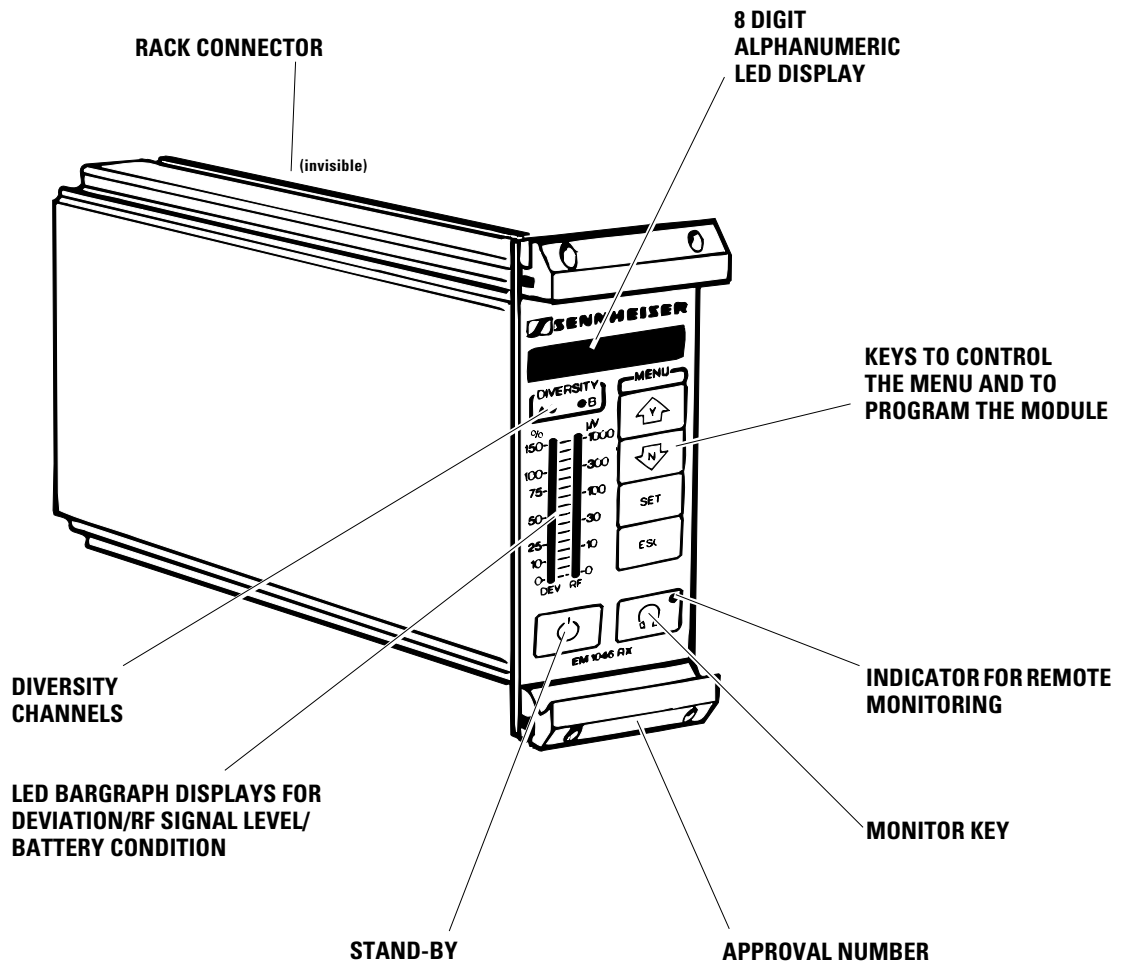

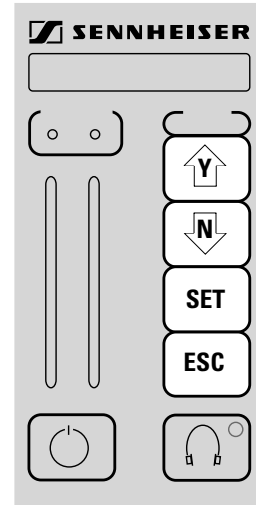

**MANIPULATION**

Depress an arbitrary menu key on the EM 1046 RX receiver module:

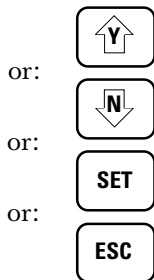

**FUNCTION**

The receiver switches to the menu mode. It is now ready for data entry.

**Receiver operation remains unaffected.**

**The receiver is not set to the new parameters unless the new data are stored!**

**DISPLAY (RX)**



Different functions can be selected from the menu by depressing the following keys:



Selection of receiver frequencies  
Please see **chapter 4.1.2**

Squelch  
Please see **chapter 4.1.3**

LED bargraph displays for RF signal level/  
deviation/battery condition  
Please see **chapter 4.1.4**

Display - text or frequency  
Please see **chapter 4.1.5**

Text  
Please see **chapter 4.1.6**

Display of EM 1035 RX configuration and  
identification data  
Please see **chapter 4.1.7**

Battery condition (SK 50/250)  
Please see **chapter 4.1.8**



**NOTA BENE**

Depress

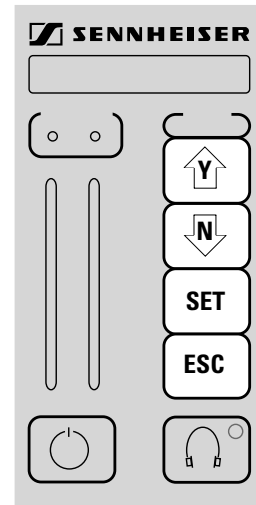

to return to the previous level.  
This key also serves to stop data entry in case of errors.

**MANIPULATION**

Chose option "RX-Freq." (chapter 4.1.1).

Depress



to allow the receiver frequencies to be selected.  
The "M" on the display starts blinking.

**FUNCTION****DISPLAY (RX)**

The EM 1046 RX receiver module can be configured as follows:

- operation on max. 32 switchable frequencies or
- variable adjustment of receiver frequencies (5 kHz grid) within 16 frequency ranges

The frequencies or frequency ranges selected must fall within the system's 24 MHz window. The configuration selected is stored in the EM 1046 RX receiver module by a personal computer via the service interface or by the remote computer. The configuration can be changed as often as desired.

**Refer changes to the system configuration to your authorized Sennheiser distributor.**

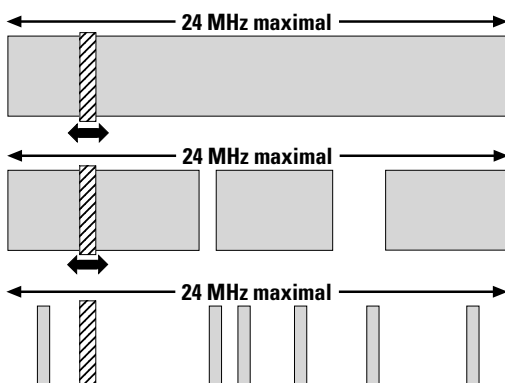
**Example 1:**

Variable adjustment within one frequency range (in the present case the total bandwidth of the system).

**Example 2:**

Variable adjustment within three frequency ranges. The frequencies between two adjacent frequency ranges cannot be used.

**Example 3:**

Seven selectable frequencies. The EM 1046 RX receiver modules come with this standard setting.

CONTINUED FROM PAGE 20 / CH. 4.1.2

## MANIPULATION

Use keys

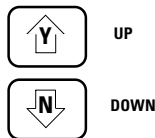

to select a receiver frequency as per pre-programmed parameters.

- Keeping the key depressed accelerates selection.

## FUNCTION

- Freely selectable receiver frequencies can easily be adjusted in a 5 kHz grid. The unit changes automatically from one grid to another.
- For standard frequencies the display automatically switches to the next channel.

## DISPLAY (RX)

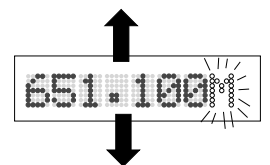

Depress



to store new frequency.



## NOTA BENE

Depress



to return to the previous level.  
This key also serves to stop data entry in case of errors.

**Receiver operation remains unaffected.  
The receiver is not set to the new parameters  
unless the new data are stored!**

CONTINUED FROM PAGE 21 / CH. 4.1.2

## MANIPULATION

## FUNCTION

## DISPLAY (RX)

Depress



The new frequency is stored in the memory.  
The EM 1046 RX receiver module switches to the new frequency selected.

to store data

For a short time the display indicates



or depress



The program returns to the selection mode.

or



Additional frequencies can be selected, if need be. The program returns to the menu.  
The display shows:

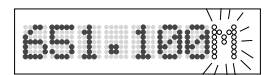

to stop storage.



## NOTA BENE

Depress



to return to the previous level.

This key also serves to stop data entry in case of errors.

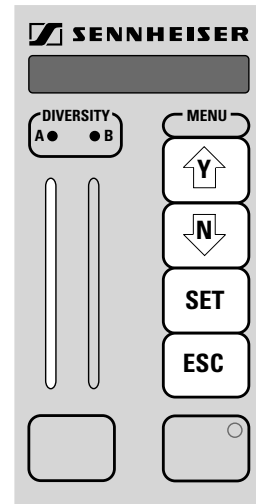

## MANIPULATION

Choose option „Squelch“ (see **ch. 4.1.1**)

Depress



to allow the squelch threshold to be set.

Use keys



UP



DOWN

to select the squelch threshold.

- Keeping the key depressed accelerates adjustment.

Depress



and subsequently:



Y = YES !

to store the squelch threshold

or

depress



N = NO !

or:



to stop storage.

## FUNCTION

The squelch threshold can be set in 140 steps. The display indicates the level selected.

In addition, the left-hand LED bargraph display indicates the squelch threshold:

- Use the RF scale ( $\mu V$ ) to read off the squelch threshold.

The squelch threshold can be additionally checked on the monitor (monitor - see **ch. 4.1.8**).

The new data are stored.

The display changes to „Menu“.

The program returns to the input routine.

New data can be selected, if need be. The program returns to the menu. The display shows:

## DISPLAY (RX)

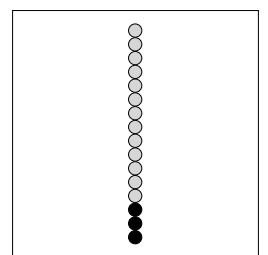
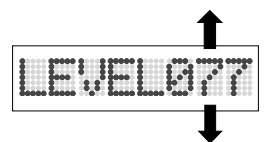

# Selection RF signal level/deviation/batery condition

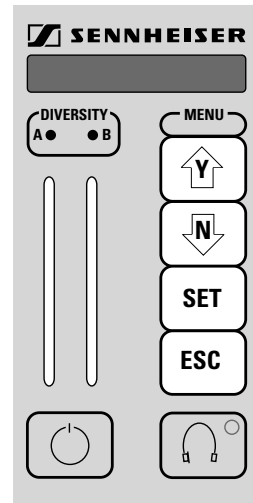

## MANIPULATION

Choose option "DEV", "RF" or "BAT" to indicate the RF signal level, deviation or battery condition.

Depress key



to allow selection.

Depress key



to select the parameters to be indicated.

## FUNCTION

It is useful to have permanent settings to facilitate day-to-day applications. The LED bargraph displays on the EM 1046 RX receiver module can be set to four different modes:

DEVIATION/FIELD STRENGTH OF THE ACTIVE CHANNEL

FIELD STRENGTH OF CHANNELS A AND B (DIVERSITY)

COMPARISON BETWEEN DEVIATION OF CHANNEL A AND B (DIVERSITY)

TRANSMITTER BATTERY CONDITION/FIELD STRENGTH

## DISPLAY (RX)

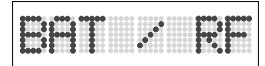
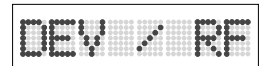

## FOR FURTHER INFORMATION ON DATA INDICATED PLEASE REFER TO THE FOLLOWING PAGES!

After you have selected the data to be indicated,

depress



and subsequently



Y = YES !

The new setting is stored.

or depress



N = NO !

The display changes to „Menu“.

or



to stop storage.

The program returns to the original setting, e. g.

New data can be selected, if need be. The program returns to the menu. The display shows:

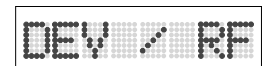



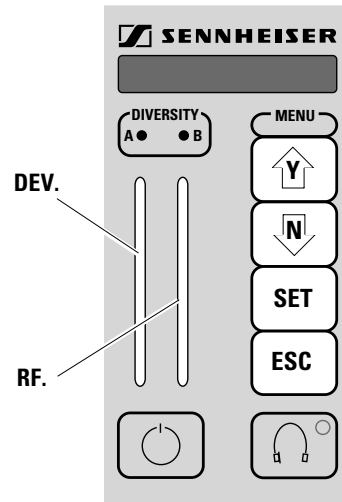

CONTINUED FROM PAGE 24, CH. 4.1.4

**MANIPULATION**

**FUNCTION**

**DISPLAY (RX)**

Use



**DEVIATION/FIELD STRENGTH**  
to be indicated:

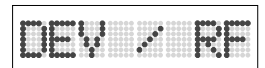

or



to select the parameters to be indicated.

Depress



and subsequently



Y = YES !

to store the latest setting



or depress



N = NO !

to stop storage.



After having depressed



The left-hand bargraph display indicates  
**DEV (= Deviation) in %**

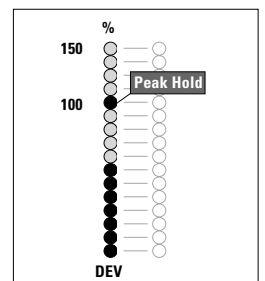

and





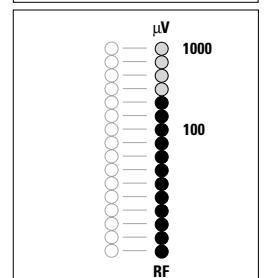

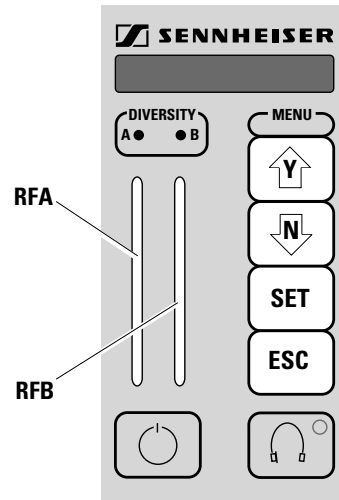





The right-hand bargraph display shows the  
**field strength (RF= Radio Frequency) in μV**



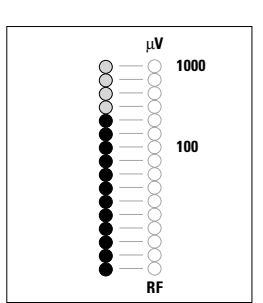
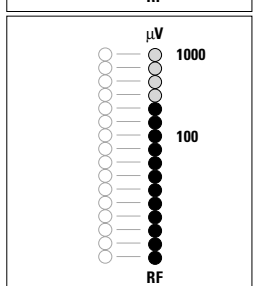

CONTINUED FROM PAGE 25, CH. 4.1.4

MANIPULATION	FUNCTION	DISPLAY (RX)
Use  or  to select the parameters to be indicated.	<b>FIELD STRENGTH OF CHANNELS A/B (DIVERSITY)</b> to be indicated:	
Depress  and subsequently  <b>Y = YES !</b> to store the latest setting or depress  <b>N = NO !</b> to stop storage.		  
After having depressed  and 	→ The left-hand bargraph display indicates <b>Field strength (RF = Radio Frequency) in <math>\mu V</math> for diversity channel A</b>	
<b>NOTA BENE</b> This display allows to monitor the RF level of both diversity channels and indicates possible antenna problems.	The right-hand bargraph display shows the <b>field strength (RF = Radio Frequency) in <math>\mu V</math> for diversity channel B</b>  The scale in $\mu V$ near the right-hand bargraph display is to be used <b>for both</b> LED bargraph displays.	

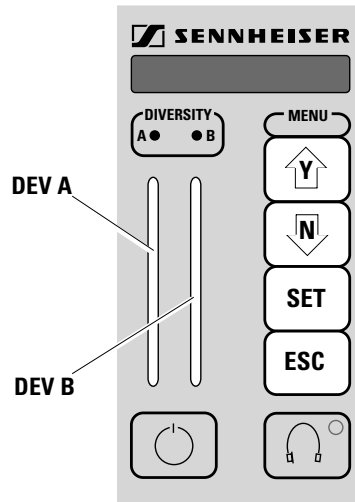

CONTINUED FROM PAGE 26, CH. 4.1.4

**MANIPULATION**

Use



or



to select the parameters to be indicated.

**FUNCTION**

**DEVIATION CHANNELS A/B (DIVERSITY)**  
to be indicated:

**DISPLAY (RX)**



Depress



and subsequently



Y = YES !

to store the latest setting

or depress



N = NO !

to stop storage.



After having depressed



and



The left-hand bargraph display indicates  
**DEV (= deviation) in %**  
for diversity channel A.

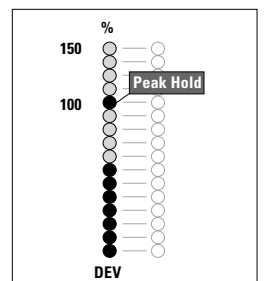

The right-hand bargraph display shows the  
**DEV (= deviation) in %**  
for diversity channel B

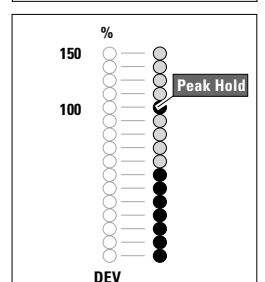

**NOTA BENE**

The read-outs of both bargraph displays differ from each other only in case of faulty functioning.

The scale in % near the left-hand bargraph display is to be used **for both** LED bargraph displays.

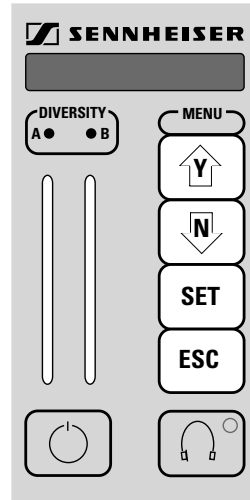

CONTINUED FROM PAGE 27, CH. 4.1.4

**MANIPULATION**

Use



or



to select the parameters to be indicated.

**FUNCTION**

**TRANSMITTER BATTERY CONDITION/FIELD STRENGTH** to be indicated:

**DISPLAY (RX)**

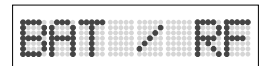

Depress



and subsequently



Y = YES !

to store the latest setting

or depress



N = NO !

to stop storage.



After having depressed



and



The left-hand bargraph display indicates the **battery condition (bat = batterie) in %**

In contrast to DEV and RF, the battery condition is indicated by one LED only. **If the transmitter battery does not transfer any data, the LED does not light up.**

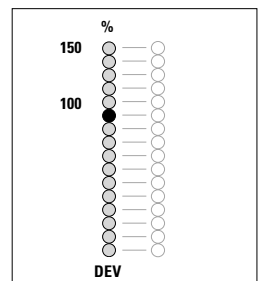

**NOTA BENE**

- The display is only operative if SK 50 TV or SK 250 TV transmitters are used!
- After power-up of the transmitter, it will take the display about 10 seconds to indicate the battery condition.

The right-hand bargraph display shows the **field strength (RF= radio frequency) in µV**

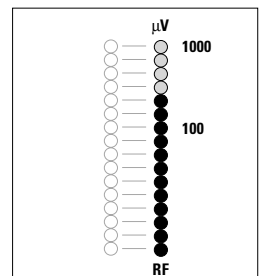

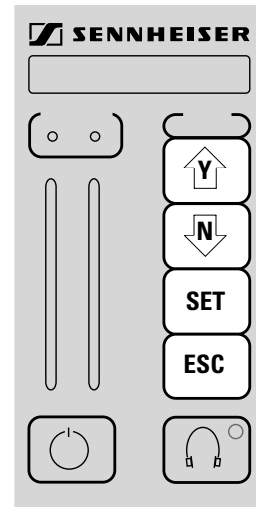

### MANIPULATION

### FUNCTION

### DISPLAY (RX)

Choose option "DispConf" (see **ch. 4.1.1**).



Depress



The display can be set to two modes.

to allow the display to be set.

- It indicates the receiver frequency of the EM 1046 RX receiver module (see **ch. 4.1.2**)



Use



UP

or



DOWN

- it indicates the text entered, e. g. the actors' names who use the transmitters (see **ch. 4.1.6**)

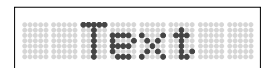

to select the parameters to be indicated.

Depress



The new data are stored.



and subsequently



Y = YES !

The display changes to "Menu".



to store the latest setting

or

The program returns to the input routine, i. e. the receiver frequency



depress key



N = NO !

or the text.



to stop storage.

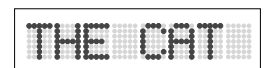

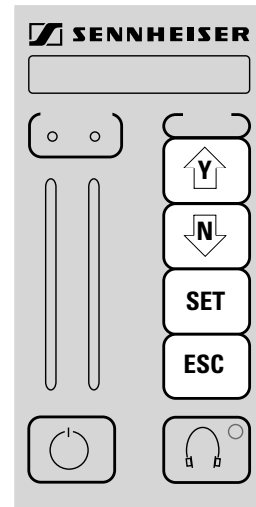

**MANIPULATION**

**FUNCTION**

**DISPLAY (RX)**

Choose the option to enter brief text (ch. 4.1.1).

Depress



The display indicates the latest text entered. The first segment of the eight alphanumeric segments starts blinking.



to allow a brief text to be entered.

Use



or



to select the letters, numbers or special characters to be indicated with each segment.

**NOTA BENE**

- If you don't want to use all segments: **When "scrolling" the character set, you will find a "blank segment" after the exclamation mark.**

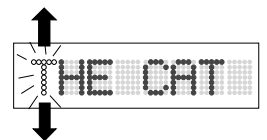
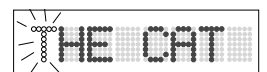

Depress



to go to the next segment.

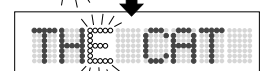
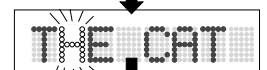
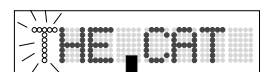

Depress



and subsequently



Y = YES !

The new data are stored.

to store the text

or

depress



N = NO !

The display changes to "Menu".

The display indicates again



to stop storage.



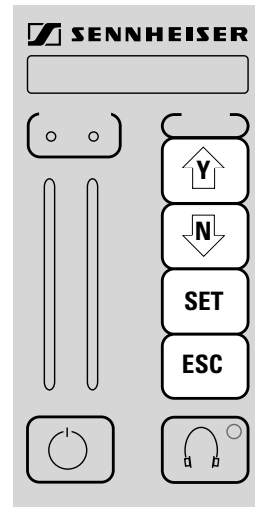

## MANIPULATION

Choose the option to set the display (ch. 4.1.1).

Depress



to return to the display mode.

Use



or



to select the parameter to be indicated.

Scrolling is stopped by keeping



depressed.

## NOTA BENE

Depress



to return to the previous level.

This key also serves to stop data entry in case of errors.

## FUNCTION

The receiver specifications are stored in every single module:

The display indicates the

### MODEL/SERIES

- **EM 1046-U-L**  
UHF ( 450 - 790 MHz)
- **EM 1046-U-H**  
UHF ( 630 - 960 MHz)

### SERIAL NUMBER OF THE MODULE

Every module has a serial number to facilitate its identification. The serial number cannot be changed.

### FREQUENCY RANGE OF THE MODULE

The display shows the standard frequencies or frequency ranges.

### SOFTWARE VERSION

Shows the version of the software used.

### HARDWARE VERSION OF THE MODULE

- 1 Version of the analog section (information for Sennheiser's Service Department or Sennheiser distributors)
- 2 Version of the digital section (information for Sennheiser's Service Department or Sennheiser distributors)

### CUSTOMER-SPECIFIC TEXT

It is entered by Sennheiser electronic KG or your Sennheiser distributor, if ordered.

## DISPLAY (RX)

DeviceID

►Modell:  
← ← ←

►Serial Nr:  
← ← ←

►Fra-Ränge:  
← ← ←

►Softw.Rev:  
← ← ←

►Hardw.Rev\_A:  
← ← ←

►Hardw.Rev\_D:  
← ← ←

►Customer Id:  
← ← ←

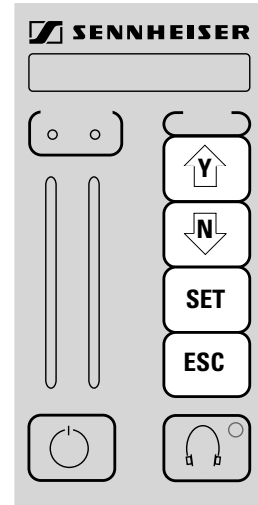

## MANIPULATION

Choose the option to indicate the condition of the transmitter battery (see **ch. 4.1.1**).

Depress



to select the display mode for the indication of the battery condition.

## NOTA BENE

This function is only operative if SK 50 UHF, SK 250 UHF or SKM 5000 UHF transmitters are used.

Depress



to return to the previous level.

This key also serves to stop data entry in case of errors.

## FUNCTION

The EM 1046 RX receiver module distinguishes between two types of power supply: the transmitters can be powered by batteries or rechargeable batteries.

If primary cells are used, the display indicates the remaining capacity in three steps. A 5-step display is used for rechargeable batteries.

If you connect transmitters other than SK 50 UHF, SK 250 UHF or SKM 5000 UHF, the display indicates

### CONDITION OF PRIMARY CELLS:

Capacity of 100 %

Capacity of about 70 %

Capacity of about 30 %, the display starts blinking.

### Attention !



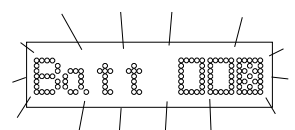
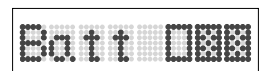
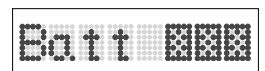
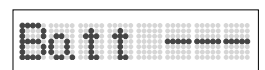

Replace the transmitter batteries. The remaining capacity only suffices for about half an hour!

## DISPLAY (RX)



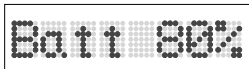

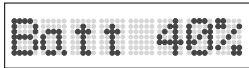
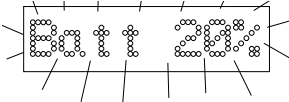
CONTINTUED FROM PAGE 32, CH. 4.1.8

MANIPULATION	FUNCTION	DISPLAY (RX)
	<b>CAPACITY OF RECHARGEABLE BATTERIES:</b>	
	Capacity of 100 %	
	Capacity of about 80 %	
	Capacity of about 60 %	
	Capacity of about 40 %	
	Capacity of about 20 %, the display starts blinking.	
<b>NOTA BENE</b>	<b>Attention !</b>	
Use the luminous band for permanent monitoring of transmitter batteries (see <b>ch. 4.1.4</b> ).	Replace the battery pack. The remaining capacity only suffices for about half an hour!	
If the remaining operating time falls below half an hour (during normal operation), the EM 203 receiver display indicates " <b>Low Batt!</b> " at short intervals.	<b>Recommendation:</b> Replace the battery pack after about 15 minutes to maintain 100 % reliability.	
		

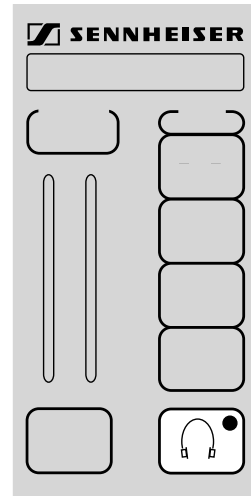

**MANIPULATION**

**FUNCTION**

**DISPLAY (RX)**

Depress



to monitor the audio signal via headphones connected to the mainframe.

It is only possible to monitor the active channel, i. e. one channel at a time.

The LED on the monitor key lights up if the key is depressed, i. e. monitoring is possible.

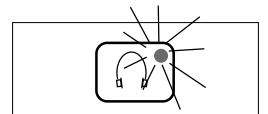

Depress



once again to stop monitoring.

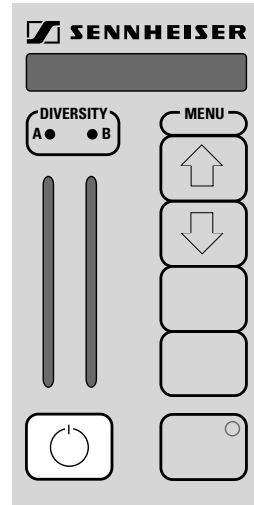

**MANIPULATION**

**FUNCTION**

**DISPLAY (RX)**

In some situations it is useful not only to mute the audio signal at the mixing console but also to switch off the complete RF section of the EM 1046 receiver module. Two reasons of several possible are:

- the wish to have only active channels indicated or
- the need of fault finding in case of RF interference.



Depress the stand-by key  
and choose  
or



The receiver offers two options:  
Y = yes, switch off receiver  
N = no, return to normal operation

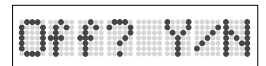

If the receiver has been switched off, the display indicates for about 2 seconds



and subsequently goes out, except for a small luminous spot.

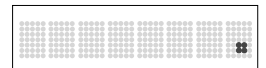

Depress the stand-by key once again to put the unit to work  
and choose



Y = yes, return to normal operation. The module is switched on as previously described (see ch. 3.5.)  
N = no, the module is to remain in the off-state.

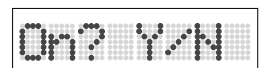

**NOTA BENE**

Depressing the menu keys during stand-by operation results in the indication of the receiver frequency selected (see ch. 4.1.2). The monitor key remains active!



# Monitor

4.2

LED indicators

4.2.1

Monitor headphones

4.2.2

## OPERATING ELEMENTS

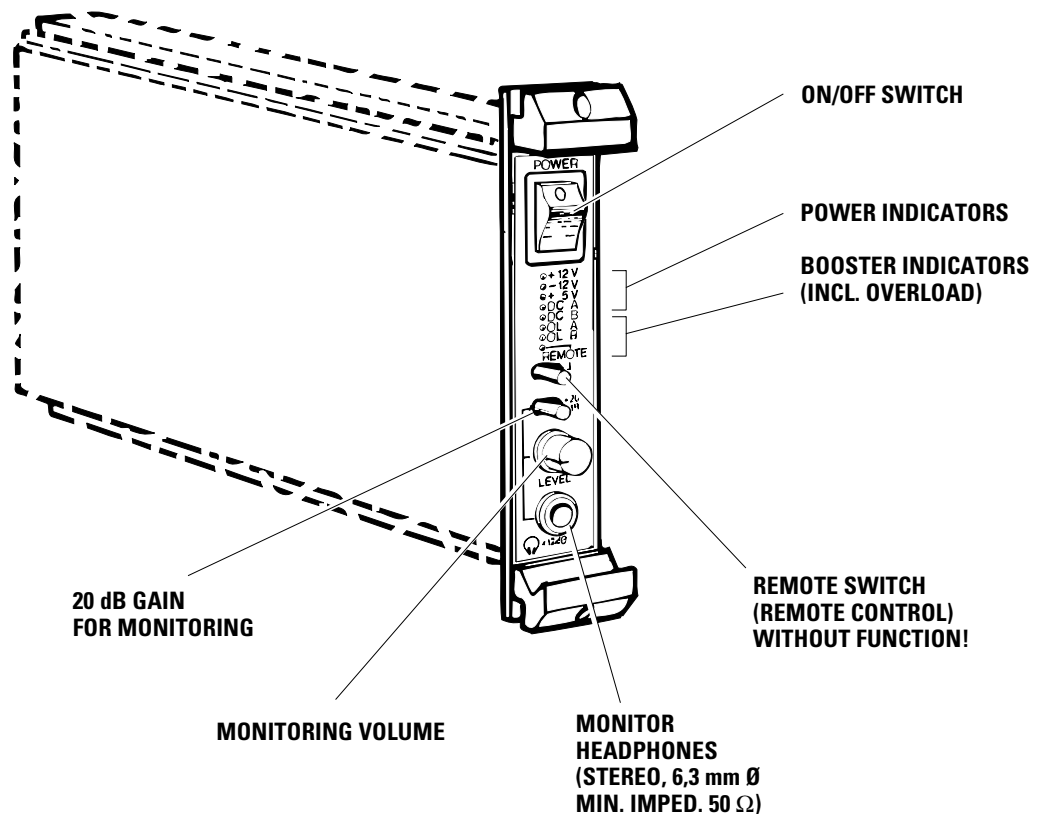

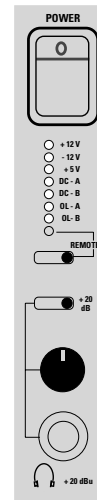

## LED DISPLAY

## FUNCTION

The three upper LEDs light up if the in-built power supply unit operates perfectly

**+ 12 V supply voltage = 12 V**

**- 12 V supply voltage = -12 V**

**+ 5 V supply voltage = 5 V**

If one LED switches off, please replace the complete power module and return it for fault finding.

The other four LEDs serve to monitor the antenna boosters connected (e.g. AB 1036 TV):



**DC-A** The switch on input module A is set to ON. The antenna booster is powered by the EM 1046 system



**DC-B** The switch on input module B is set to ON. The antenna booster is powered by the EM 1046 system



**OL-A (Overload)** The current across antenna socket A exceeds 150 mA! Short circuit! Check your antenna booster.



**OL-B (Overload)** The current across antenna socket B exceeds 150 mA! Short circuit! Check your antenna booster.

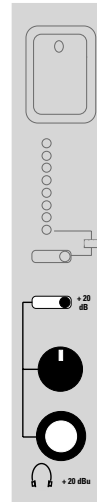

### FUNCTION

The monitor socket is suited to connect mono or stereo headphones with an impedance of about 50 to 300  $\Omega$ .

The rotary switch serves to adjust the volume.

The "+ 20 dB" switch increases the signal level at the monitor socket by 20 dB. This facilitates the identification of residual noise.

### NOTA BENE

The max. output level at the monitor socket amounts to + 18 dBm.

Check the setting if audible distortions occur.

Frequency range	450 - 790 MHz with RX module item no. 03246 760 - 960 MHz with RX module item no. 03247
Bandwidth	24 MHz
Channel spacing, min.	300 kHz
Channel grid, min.	5 kHz
1st oscillator frequency (1st LO)	71 MHz below / above Fe
1st intermediate frequency (1st IF)	71 MHz
2nd oscillator frequency (2nd LO)	81.7 MHz
2nd intermediate frequency (2nd IF)	10.7 MHz
Deemphasis	50 $\mu$ s
Nominal deviation/Peak deviation	$\pm$ 40 kHz / $\pm$ 56 kHz
AF outputs	3 x XLR connectors with a balanced AF output signal, min. load impedance 600 $\Omega$
Nominal audio level	+ 12 dBm
Peak audio level	+ 18 dBm
THD for peak deviation	$\leq$ 1 % (typ. < 0,5 %)
Audio frequency range (+1 dB / -2 dB)	40 Hz - 20 kHz
Compander	HIDYN plus <sup>®</sup> (internally defeatable)
Diversity	RF signal-dependent selection of AF outputs
Squelch	adjustable threshold (0-100 $\mu$ V RF input voltage)
S/N = 52 dB (unweighted, with HIDYN plus <sup>®</sup> )	$\leq$ 1.5 $\mu$ V (typ. 1 $\mu$ V)
S/N max. (peak deviation, with HIDYN plus <sup>®</sup> )	$\geq$ 112 dBA eff. / $\geq$ 100 dB CCIR peak
Limiter threshold	$\leq$ 1 $\mu$ V *
Intermodulation attenuation	$\geq$ 76 dB
Rejection of adjacent channels	$\geq$ 66 dB
Suppression of spurious and harmonics	$\geq$ 100 dB *
Blocking	$\geq$ 85 dB *
Image rejection	$\geq$ 100 dB *
Spurious emissions (RF)	$\leq$ - 80 dBm at HF - input
RF inputs	2 x N - sockets
Monitor socket	6.3 mm- $\emptyset$ jack, max. +18 dBu / 600 $\Omega$ , short-circuit proof, min. load imp. 50 $\Omega$ , gain: +20 dB (adjustable) and +20 dB (switchable)
Indicators	Monitor: 3 LEDs for operating voltages 2 LEDs for booster supply voltage 2 LEDs for booster overload 1 LED for remote operation  RF input: 2 LEDs for booster supply voltage RX modules: 8 digit alphanumeric LED display (text or frequency) 2 diversity LEDs, 1 monitor LED, 2 x 16 digit LED bargraph display for dev. and RF IN
Operating elements	Monitor: mains switch, remote switch +20 dB switch, +20 dB regulator  RX modules: 6 keys RI module: 2 switches for booster voltage 2 NF-PAD, 20 dB attenuation
Booster supply voltage	2 x 12 V, max. 150 mA, current limiter, switchable
Supply voltage	12 - 16 V / 3 A DC, protective low voltage
Power consumption	max. 30 W
Mains connection	4-pin XLR, for plug-in PSU (different for each country)
Housing	19" rack, 4 height units, 34 BE
Dimensions	approx. 200 mm x 360 mm x 190 mm
Weight	approx. 7 kg (incl. all modules)
Approval number (Germany)	A 102 932C RF (BZT)

\* with AB 1036 antenna booster connected in series.  
GZA 1036 antenna recommended.

**SENNHEISER ELECTRONIC KG**  
30900 Wedemark

Subject to alterations. Errors and omissions excepted!

Publ.: 10/94

51104



## Free Manuals Download Website

<http://myh66.com>

<http://usermanuals.us>

<http://www.somanuals.com>

<http://www.4manuals.cc>

<http://www.manual-lib.com>

<http://www.404manual.com>

<http://www.luxmanual.com>

<http://aubethermostatmanual.com>

Golf course search by state

<http://golfingnear.com>

Email search by domain

<http://emailbydomain.com>

Auto manuals search

<http://auto.somanuals.com>

TV manuals search

<http://tv.somanuals.com>