

# ADN CU1

Quick guide

## AUDIO DISTRIBUTION NETWORK



A detailed instruction manual for the complete ADN conference system can be found:

- on our website at [www.sennheiser.com](http://www.sennheiser.com) or
- on the CD ROM enclosed with the ADN CU1.

# Contents

- Important safety instructions** ..... 2
- The ADN central unit** ..... 4
- Delivery includes** ..... 4
- Product overview – ADN CU1 central unit** ..... 5
  - Overview of the ADN CU1 display panel ..... 6
  - The “Conference Manager” software ..... 6
- Structuring and controlling the conference system** ..... 7
- Preparing the central unit for use** ..... 8
- Setting up the conference system** ..... 8
- Using the central unit** ..... 11
  - Switching the conference system on/off ..... 11
  - Deactivating the lock mode of the central unit ..... 11
  - Functions of the keys ..... 11
- Configuring the conference system** ..... 12
  - Overview of the operating menu ..... 12
  - Working with the operating menu ..... 16
  - Setting the volume of the conference units’ built-in loudspeakers ..... 17
- Cleaning and maintaining the conference system** ..... 17
- Specifications – ADN CU1 central unit** ..... 18
- Manufacturer Declarations** ..... 19

DE

EN

FR

ES

IT

RU

NL

ZH

JP

DK

FI

SE

NO

## Important safety instructions

1. Read these instructions.
2. Keep these instructions. Always include these instructions when passing the apparatus on to third parties.
3. Heed all warnings.
4. Follow all instructions.
5. Do not use this apparatus near water.
6. Clean only with a dry cloth.
7. Do not block any ventilation openings. Install in accordance with the manufacturer's instructions.
8. Do not install near any heat sources such as radiators, heat registers, stoves, or other apparatus (including amplifiers) that produce heat.
9. Do not defeat the safety purpose of the polarized or grounding-type plug. A polarized plug has two blades with one wider than the other. A grounding type plug has two blades and a third grounding prong. The wide blade or the third prong are provided for your safety. If the provided plug does not fit into your outlet, consult an electrician for replacement of the obsolete outlet.
10. Protect the power cord from being walked on or pinched, particularly at plugs, convenience receptacles, and the point where they exit from the apparatus.
11. Only use attachments/accessories specified by the manufacturer.
12. Use only with the cart, stand, tripod, bracket, or table specified by the manufacturer, or sold with the apparatus.  
When a cart is used, use caution when moving the cart/apparatus combination to avoid injury from tip-over.
13. Unplug this apparatus during lightning storms or when unused for long periods of time.
14. Refer all servicing to qualified service personnel.  
Servicing is required when the apparatus has been damaged in any way, such as power supply cord or plug is damaged, liquid has been spilled or objects have fallen into the apparatus, when the apparatus has been exposed to rain or moisture, does not operate normally, or has been dropped.
15. To completely disconnect this apparatus from the AC mains, disconnect the power supply cord plug from the AC receptacle.
16. **WARNING:** To reduce the risk of fire or electric shock, do not expose this apparatus to rain or moisture.
17. Do not expose this equipment to dripping or splashing and ensure that no objects filled with liquids, such as vases, are placed on the equipment.
18. The mains plug of the power supply cord shall remain readily accessible.



### Hazard warnings on the rear of the central unit

The label shown on the left is attached to the rear of the central unit. The symbols on this label have the following meaning:

Presence of uninsulated dangerous voltage within the central unit's enclosure that may be of sufficient magnitude to constitute risk of fire or electric shock.

Never open the central unit as there is a risk of electric shock. There are no user serviceable parts inside. Refer servicing to an authorized Sennheiser service partner.

Read and follow the safety and operating instructions contained in the instruction manual.

**Risk of fire due to overloading**

Do not overload wall outlets and extension cables as this may result in fire and electric shock.

**Danger of hearing damage due to high volumes**

These products are used for commercial purposes. Commercial use is subject to the rules and regulations of the trade association responsible. Sennheiser, as the manufacturer, is therefore obliged to expressly point out possible health risks arising from use.

When the conference participants listen to the floor channel via headphones, they can adjust the volume themselves. In doing so, sound pressure exceeding 85 dB(A) can be produced. 85 dB(A) is the sound pressure corresponding to the maximum permissible volume which is by law (in some countries) allowed to affect your hearing for the duration of a working day. It is used as a basis according to the specifications of industrial medicine. Higher volumes or longer durations can damage your hearing. At higher volumes, the duration must be shortened in order to prevent hearing damage. The following are sure signs that you have been subjected to excessive noise for too long a time:

- You can hear ringing or whistling sounds in your ears.
- You have the impression (even for a short time only) that you can no longer hear high notes.

Inform the conference participants about these facts and, if necessary, ask them to set the volume to a medium level.

**Intended use**

Intended use of the products includes:

- having read this instruction manual, especially the chapter "Important safety instructions",
- using the products within the operating conditions and limitations described in this instruction manual.

"Improper use" means using the products other than as described in this instruction manual, or under operating conditions which differ from those described herein. This will invalidate the warranty.



This instruction manual is also available on the Internet at [www.sennheiser.comcom](http://www.sennheiser.comcom).

# The ADN central unit

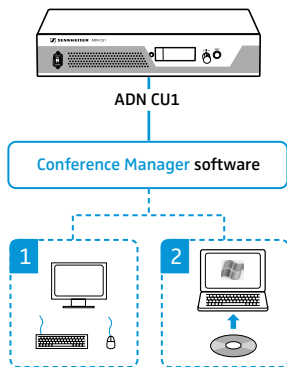

The ADN CU1 central unit is part of the Sennheiser ADN conference system.

The central unit controls the communication of the ADN D1 delegate units and the ADN C1 chairman units and supplies power to them. For configuring the conference system, you can either use the central unit's operating menu or the "Conference Manager" software.

The "Conference Manager" software can be run in two different ways:

1. As a program on the central unit's built-in PC (a screen, keyboard, and mouse are required)
2. As a program on a separate Windows PC with Ethernet connection

## Delivery includes

- 1 ADN CU1 central unit
- 1 quick guide
- 1 CD ROM (including the "Conference Manager" software (Windows) and the instruction manual for the overall conference system as PDF)

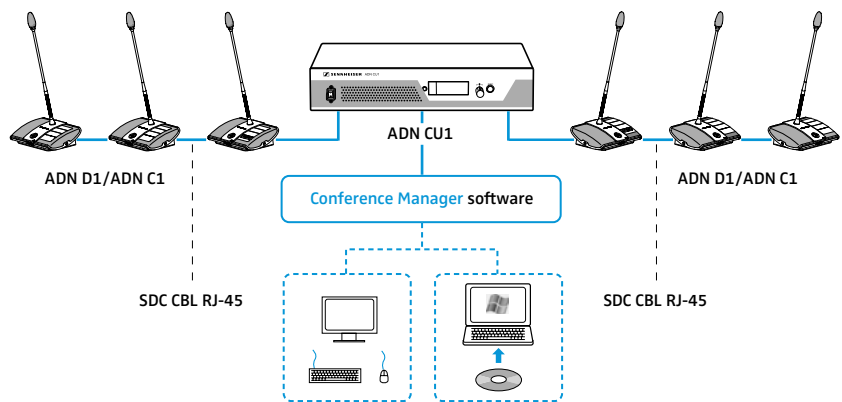

### Additional components required:

- 1 mains cable (for the central unit; country-specific)
- ADN D1 delegate units
- ADN C1 chairman units (optional; for granting speaking privileges)
- SDC CBL RJ-45 system cables (for connecting the conference units)



Cat. No.	Description
054324	Mains cable, EU version, black, 1.8 m
054325	Mains cable, US version, black, 1.8 m
057256	Mains cable, UK version, black, 1.8 m
502758	ADN D1 delegate unit
502759	ADN C1 chairman unit (optional; for granting speaking privileges)
009842	SDC CBL RJ-45-2 system cable with two shielded RJ 45 plugs, black, 2 m
009853	SDC CBL RJ-45-3 system cable with two shielded RJ 45 plugs, black, 3 m
009844	SDC CBL RJ-45-5 system cable with two shielded RJ 45 plugs, black, 5 m
009845	SDC CBL RJ-45-10 system cable with two shielded RJ 45 plugs, black, 10 m
009846	SDC CBL RJ-45-20 system cable with two shielded RJ 45 plugs, black, 20 m
009847	SDC CBL RJ-45-50 system cable with two shielded RJ 45 plugs, black, 50 m

 Additional accessories for the ADN conference system can be found at [www.sennheiser.com](http://www.sennheiser.com).

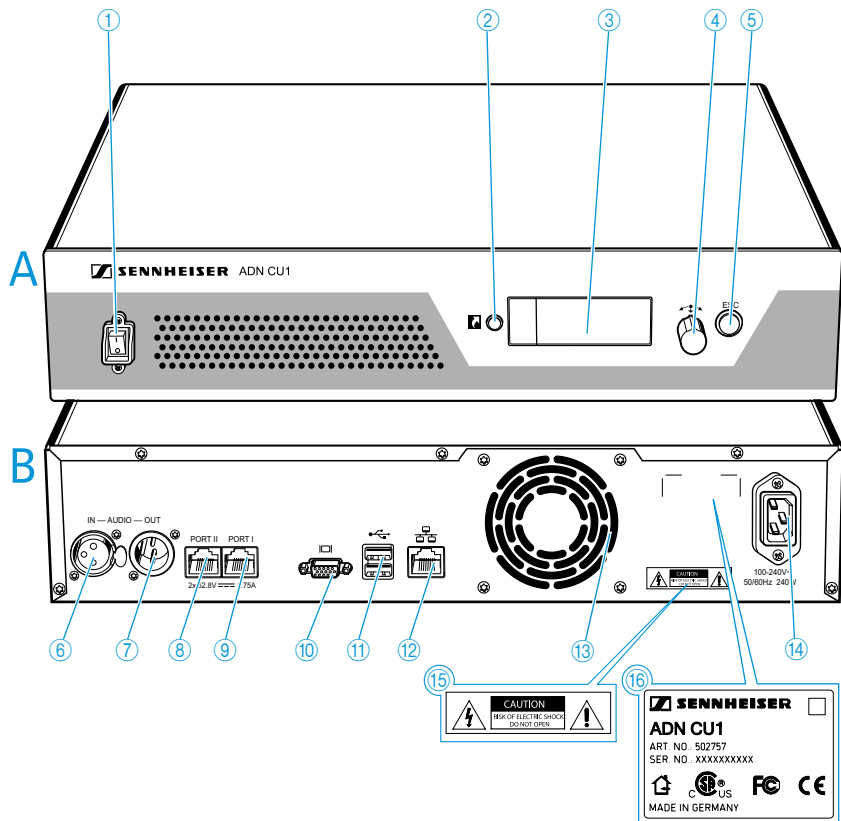

## Product overview – ADN CU1 central unit



### A Front view

- ① On/off switch
- ② Standard display key 
- ③ Display panel
- ④ Jog dial 
- ⑤ ESC key

### B Rear view

- ⑥ IN audio input
- ⑦ OUT audio output
- ⑧ PORT II socket (RJ 45) for connection of conference units
- ⑨ PORT II socket (RJ 45) for connection of conference units
- ⑩ VGA monitor output 
- ⑪ USB socket  (2x)
- ⑫ Network socket (RJ 45) 
- ⑬ Fans
- ⑭ Mains socket
- ⑮ Hazard warnings
- ⑯ Type plate

## Overview of the ADN CU1 display panel

After switch-on, the central unit's display shows a progress bar for approx. 30 seconds and then the standard display:

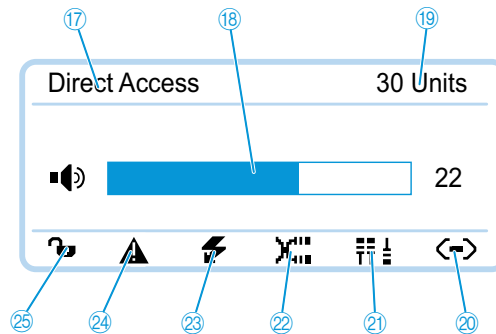

Text/icon	Possible display/function
17 Conference mode	Current conference mode: "Direct Access", "Override", "Request"
18 Floor channel volume	Current volume setting for the conference units' built-in loudspeakers
19 Number of conference units	Number of connected conference units
20 Connection status	↔: The central unit is not connected to the "Conference Manager" software and/or a media control unit ↔: The central unit is connected to the "Conference Manager" software and/or a media control unit
21 Structural change icon	Icon appears if, since the last initialization, a malfunction/change has occurred in the wiring of the conference units
22 Cable fault icon	Icon appears if conference units are not correctly connected
23 Short-circuit icon	Icon appears if there is a short circuit in the wiring of the conference units. The display panel lights up red.
24 Warning triangle	Icon appears if there is a malfunction/change. The display panel lights up red.
25 Lock mode icon (see page 11)	Lock mode of the central unit: 🔓: lock mode is deactivated 🔒: lock mode is activated

For information on troubleshooting when error icons 21 to 24 are displayed, refer to the detailed instruction manual.

## The "Conference Manager" software

The "Conference Manager" software allows you to conveniently configure and control the entire conference via a Windows PC or directly via the central unit.

For information on the software, refer to the detailed instruction manual.

# Structuring and controlling the conference system

## Structuring the conference system

The ADN conference system is suitable for small to medium size conferences with approx. 30 conference units (divided up onto the two connection sockets **PORT I** and **PORT II**). Delegate units and chairman units can be combined in an arbitrary order and are connected to the central unit using SDC CBL RJ-45 system cables. The ends of the cable strings are open (no ring topology). The maximum number of conference units that can be used depends on the voltage supply which in turn is influenced by the cable lengths (see next chapter).

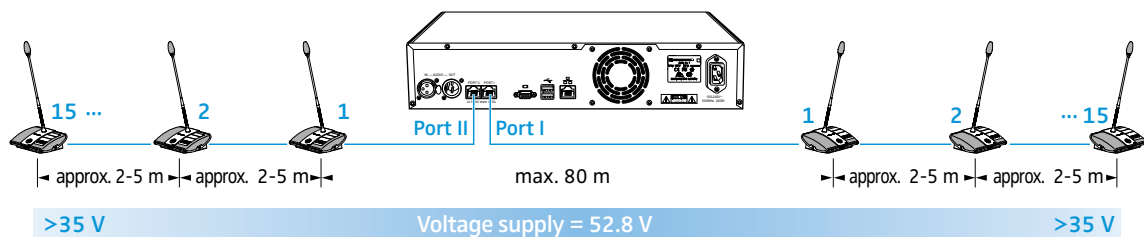

In addition, you can connect audio devices to the central unit in order to e.g. feed audio signals to the floor channel or to output the floor channel via an external audio device. The ADN conference system can be completely integrated into a media control system.

## Calculating the voltage drop on the system cables

For safe operation of the conference system, make sure that all conference units are supplied with a voltage of at least 35 V! The voltage supplied depends on the number of connected conference units and on the cable lengths. The standard cable length between the central unit and the first conference unit is 80 m max. and the standard cable length between the conference units is 2-5 m. If these cable lengths are observed, safe operation of a conference system with 30 conference units is ensured. If cable lengths are shorter, it might be that more conference units can be used.

The "ADN Cable Calculator" program allows you to calculate the voltage drops on the individual sections of a cable string and to plan the structure of the conference system. The program is available from your Sennheiser partner or from the "Product Downloads" area on the product page at [www.sennheiser.com](http://www.sennheiser.com).

## Integration into a media control system

The ADN conference system can be completely integrated into a media control system. You can monitor and control all functions of the conference system via the programmable commands of your media control system. For information on the integration into a media control system, refer to the detailed instruction manual.



## Preparing the central unit for use

### Setting up the central unit on a flat surface or mounting it into a rack

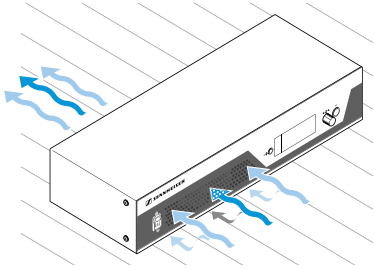

- ▶ Make sure that the air vents are not covered or blocked.
- ▶ Place the central unit on a flat surface as shown.

**i** For information on how to mount the central unit [into a 19" rack](#), refer to the detailed instruction manual.

### Connecting the central unit to the mains

#### CAUTION

#### Product damage due to unsuitable mains cables or power outlets!

An unsuitable power supply can damage the product.

- ▶ Only use the recommended mains cable (see page 4) for connecting the product to the mains.
- ▶ Only use multi-outlet power strips or extension cables with protective ground contacts.
- ▶ Only use mains cables with a 3-pin connector.

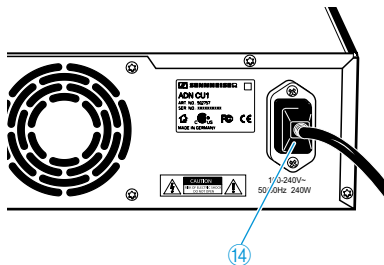

- ▶ First connect the mains cable to the mains socket [14](#).
- ▶ Connect the mains cable to the mains.  
The central unit is now ready for operation.

## Setting up the conference system

### Connecting the conference units to the central unit

You can connect up to 15 conference units to each of the central unit's connection sockets [PORT II \(8\)](#) or [PORT I \(9\)](#). The maximum number of conference units that can be used in one cable string depends on the overall cable length connected to a port (see page 7).

The following describes the procedure for one cable string. If necessary, repeat these steps for a second cable string.

- ▶ Place the conference units at the corresponding seats.
- ▶ Put out a sufficient number of system cables in the required lengths.
- ▶ If necessary, calculate the maximum length of the cable string in order to ensure that all conference units connected in the string are supplied with a voltage of at least 35 V (see page 7).

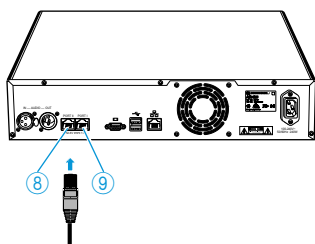

To connect the conference units to the central unit:

**CAUTION**

**Product damage due to an unsuitable power supply!**

An unsuitable power supply can damage network devices with RJ 45 plugs that are connected to the connection sockets **PORT I** and **PORT II**.

- ▶ Only connect the ADN C1 and ADN D1 conference units to the connection sockets **PORT I** and **PORT II**.

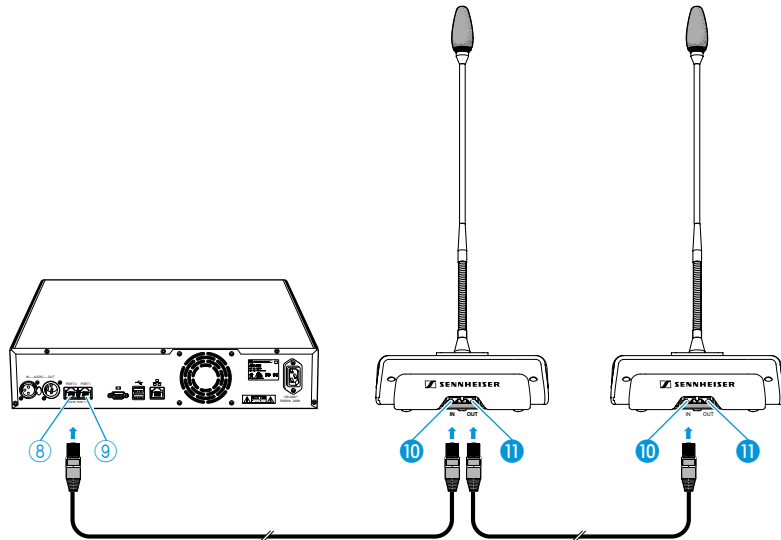

- ▶ Use a system cable to connect the **IN** socket 10 of the first conference unit to the **PORT II** socket 8 or **PORT I** socket 9 of the central unit (see above).
- ▶ Use a system cable to connect the **OUT** socket 11 of the first conference unit to the **IN** socket 10 of the second conference unit.
- ▶ Repeat these steps for the remaining conference units.

**i** You can use optional cable holders for guiding the system cables. For further information, refer to the detailed instruction manual.

**Connecting external audio devices to the central unit**

To output the floor channel via an external audio device:

- ▶ Use an XLR cable to connect the **OUT** audio output 7 of the central unit to an external audio device.

To connect an external audio source and to feed its signals to the floor channel:

- ▶ Use an XLR cable to connect the external audio source to the **IN** audio input 6 of the central unit.

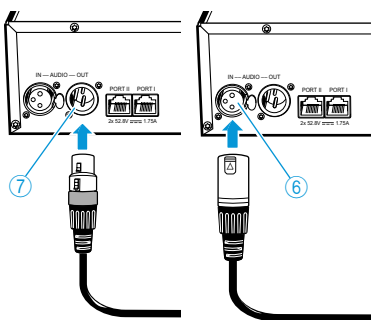

Running the software installed on the central unit

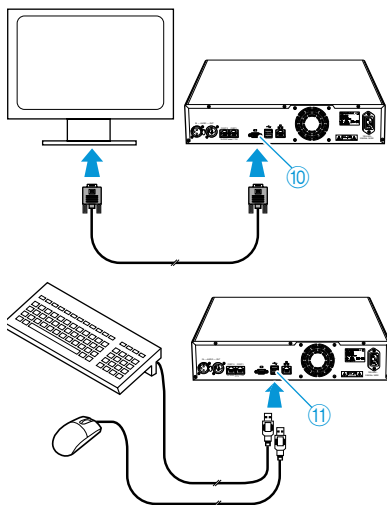

Running the software on a separate Windows PC

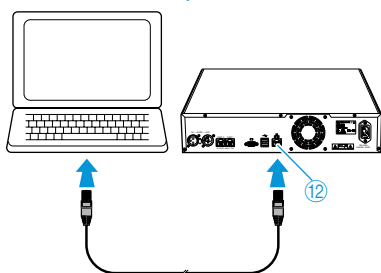

Preparing to use the “Conference Manager” software

To use the “Conference Manager” software installed on the central unit, you require the following devices:

Device	Requirements
Screen	Connection: 15-pin Sub-D VGA Resolution: 800 x 600 pixels or higher Recommended: 1024 x 768 or 1280 x 1024 pixels
Mouse	Standard USB for Windows PCs
Keyboard	Standard USB for Windows PCs Supported language layouts: e.g. English, German, French, Spanish, Italian, Russian, Dutch (for the complete list, refer to the detailed instruction manual)

- ▶ Use a Sub-D VGA cable to connect a screen to the VGA monitor output 10.
- ▶ Connect the keyboard and the mouse to the two USB sockets 11.
- ▶ Configure the screen, the keyboard and the mouse using the “Conference Manager” software (refer to the detailed instruction manual). Your conference system is now ready for operation.

To run the “Conference Manager” software on a separate Windows PC, the PC must meet the following system requirements:

Component	Requirement
Processor	Intel Pentium 4 or AMD Athlon XP, 2 GHz or more
RAM	Min. 512 MB
Hard disk	Min. 150 MB free hard disk memory
Drives	CD ROM or DVD ROM
Interfaces/network	Ethernet 100 MBit/s
TCP/IP internet protocol	Internet protocol version 4 (IPv4)
Screen	Minimum resolution: 800 x 600 pixels Recommended: 1024 x 768 pixels
Operating system	Microsoft Windows XP Professional with SP 2 Microsoft Windows Vista Microsoft Windows 7

- ▶ Use a network cable (Cat5) to connect the Ethernet socket 12 of the central unit to the network interface of your PC. You can also connect the PC and the central unit using a switch or similar.
- ▶ Install the “Conference Manager” software supplied on the CD ROM on your connected PC and configure the network (for further information on the software, refer to the detailed instruction manual).

## Using the central unit

### Switching the conference system on/off

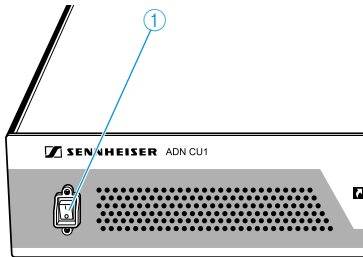

To switch the conference system on:



- ▶ Set the on/off switch ① to position "1".  
The central unit switches on and its display panel lights up.

To switch the conference system off:





- ▶ Set the on/off switch ① to position "0".  
The central unit is switched off completely.

### Deactivating the lock mode of the central unit

If the lock mode is activated (see page 15), you have to deactivate it in order to be able to operate the central unit:

- ▶  Press the jog dial or any other key.  
"Lock" appears on the display panel.
- ▶  Turn the jog dial.  
The "OFF" setting is selected.
- ▶  Press the jog dial.  
The lock mode is deactivated.

### Functions of the keys

Action	Functions
Press the <b>ESC</b> key 	<ul style="list-style-type: none"> <li>• Cancels the entry and returns to the next higher menu level or to the standard display</li> </ul>
Press the jog dial 	<ul style="list-style-type: none"> <li>• Changes from the standard display to the operating menu</li> <li>• Calls up a menu item</li> <li>• Enters a submenu</li> <li>• Stores the settings and returns to the operating menu</li> </ul>
Turn the jog dial 	<ul style="list-style-type: none"> <li>• Increases or reduces the floor channel volume (when the standard display is shown)</li> <li>• Changes to the next/previous menu item</li> <li>• Changes the setting of a menu item</li> </ul>
Press the standard display key 	<ul style="list-style-type: none"> <li>• Returns to the standard display</li> </ul>



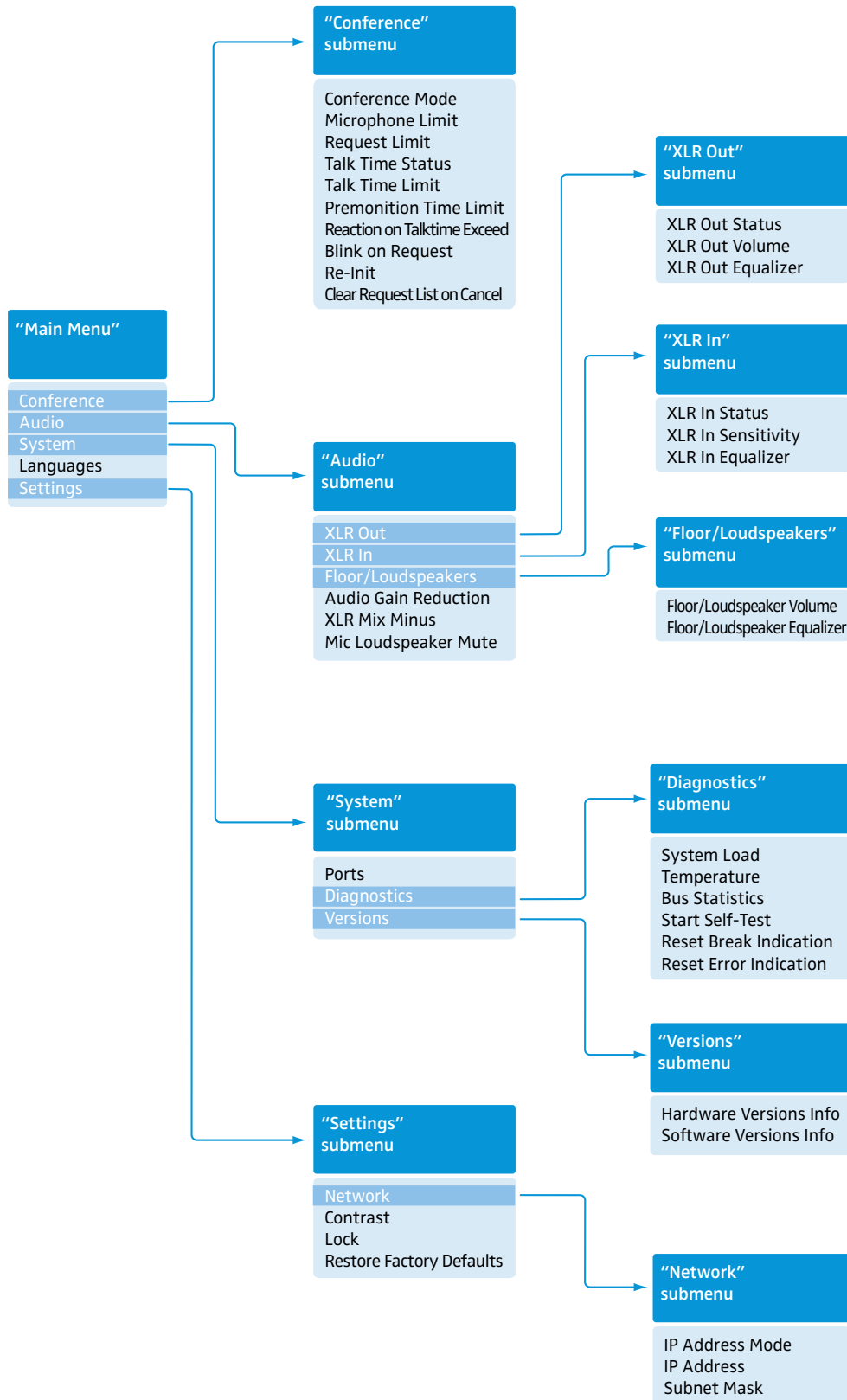

# Configuring the conference system



## Overview of the operating menu



Display	Function of the menu item	Option/display
<b>"Main Menu"</b>		
"Conference"	Calls up the "Conference" submenu	–
"Audio"	Calls up the "Audio" submenu	–
"System"	Calls up the "System" submenu	–
"Languages"	Adjusts the language	"Deutsch", "English", "Espanol"...
"Settings"	Calls up the "Settings" submenu	–
<b>"Conference" menu</b>		
"Conference Mode"	Adjusts the conference mode "Direct Access" and "Override": These two conference modes do not require the use of a chairman unit. If the maximum number of speakers who can take the floor simultaneously has not been reached, a further speaker can take the floor immediately. "Request": For this mode to function, a chairman unit is required. The chairman receives requests to speak and grants speaking privileges according to the FIFO principle (First In – First Out), i.e. the participant with the longest waiting time is granted speaking privileges.	"Direct Access", "Override" or "Request"
"Microphone Limit"	Sets the maximum number of speakers who can take the floor simultaneously in "Direct Access" and "Override" mode	"1" ... "10"
"Request Limit"	Sets the maximum number of requests to speak in "Request" and "Direct Access" mode	"0" ... "10"
"Talk Time Status"	Activates/deactivates the speaking time limit	"On"/"Off"
"Talk Time Limit"	Sets the speaking time limit	"01" ... "60" in steps of 1 minute
"Premonition Time Limit"	Sets the advance warning time (warns speakers that they are approaching the end of the individual speaking time)	"00" ... "120" in steps of 10 seconds
"Reaction on Talktime Exceed"	Determines the behavior when the individual speaking time is exceeded "Continue": The individual speaking time is continued. "Cancel": The individual speaking time is terminated.	"Continue"/"Cancel"
"Blink on Request"	Activates/deactivates the flashing of the signal light ring when a request to speak is made	"On"/"Off"
"Re-Init"	Re-initializes the conference units If you connect chairman units to the conference system during a running conference, you have to re-initialize them. When conference units are re-initialized, the conference will be interrupted.	"Yes"/"No"
"Clear Request List on Cancel"	Sets the function of the priority key  of the chairman unit Setting "On": Pressing the priority key deactivates all delegate units. All requests to speak are deleted. Setting "Off": Pressing the priority key deactivates all currently active delegate units. All requests to speak are retained.	"On"/"Off"

DE  
EN  
FR  
ES  
IT  
RU  
NL  
ZH  
JP  
DK  
FI  
SE  
NO

Display	Function of the menu item	Option/display
<b>"Audio" menu</b>		
"XLR Out"	Calls up the "XLR Out" submenu	–
"XLR In"	Calls up the "XLR In" submenu	–
"Floor/Loudspeakers"	Calls up the "Floor/Loudspeakers" submenu	–
"Audio Gain Reduction"	The sum signal of all active conference units is output via the floor channel ("Floor/Loudspeakers"). The "Audio Gain Reduction" menu item allows you to adjust how the volume levels of the signals of the individual conference units are processed.	"0.0 dB per Mic" ... "–3.0 dB per Mic"; "Linear Division"
"XLR Mix Minus"	Activates the filtering of the IN audio input from the OUT audio output in order to avoid, for example, echoes during videoconferencing or teleconferencing	"On"/"Off"
"Mic Loudspeaker Mute"	Deactivates the conference units' built-in loudspeakers for contributions coming from the conference units' microphones	"On"/"Off"
<b>"XLR Out" menu</b>		
"XLR Out Status"	Activates/deactivates the OUT audio output	"On"/"Off"
"XLR Out Volume"	Adjusts the volume of the XLR output	 "01" ... "32"
"XLR Out Equalizer"	Adjusts the tone color of the XLR output	 "+02 dB –03 dB +05 dB "–12 dB" ... "+12 dB"
<b>"XLR In" menu</b>		
"XLR In Status"	Activates/deactivates the IN audio input	"On"/"Off"
"XLR In Sensitivity"	Adjusts the sensitivity of the XLR input	 "–18.0 dBu" ... "+18.0 dBu"
"XLR In Equalizer"	Adjusts the tone color of the XLR input	 "+02 dB –03 dB +05 dB "–12 dB" ... "+12 dB"

Display	Function of the menu item	Option/display
<b>"Floor/Loudspeakers" menu</b>		
"Floor/Loudspeakers Volume"	Adjusts the floor channel volume ("Floor/Loudspeakers")	 "00" ... "32"
"Floor/Loudspeakers Equalizer"	Adjusts the tone color of the floor channel	 +02 dB -03 dB +05 dB "-12 dB" ... "+12 dB"
<b>"System" menu</b>		
"Ports"	Displays the type and number of the conference units connected to Port I and Port II	Deleg Chair. Port1: xx xx Units Port2: xx xx Units
"Diagnostics"	Calls up the "Diagnostics" submenu	-
"Versions"	Calls up the "Versions" submenu	-
<b>"Diagnostics" menu</b>		
"System Load"	Provides information on the current and voltage supply	Current Voltage Port1 😊 😞 Port2 😊 😊
"Temperature"	Provides information on the temperature status	Status 😊
"Bus Statistics"	Provides information on the status of data transmission/errors	Error Indication : 😊 Break Count : 1
"Start Self-Test"	Performs a self-test on the conference system	"On"/"Off"
"Reset Break Indication"	Resets the error counter ("Break Count") in the "Bus Statistic" menu item	"Yes"/"No"
"Reset Error Indication"	Resets the display for data bus errors ("Error Indication") in the "Bus Statistic" menu item	"Yes"/"No"
<b>"Versions" menu</b>		
"Hardware Version Info"	Displays the hardware version	DU/PU: 1 CU SB: 1
"Software Version Info"	Displays the software version	DU/PU: 0.1.1.5 CU SB: 1.0.0.0 CU Main: 1.0.0.1
<b>"Settings" menu</b>		
"Network"	Calls up the "Network" submenu	-
"Contrast"	Adjusts the contrast of the display panel	"1" ... "15"
"Lock"	Activates/deactivates the lock mode	"On"/"Off"
"Restore Factory Defaults"	Restores the factory default settings	"Yes"/"No"
<b>"Network" menu</b>		
"IP Address Mode"	Sets the IP address allocation mode	"Static IP"/"Dynamic IP"
"IP Address"	Sets the IP address of the central unit	"xxx . xxx . xxx . xxx"
"Subnet Mask"	Sets the subnet mask of the central unit	"xxx . xxx . xxx . xxx"



## Working with the operating menu

By way of example of the “Microphone Limit” menu item, this section describes how to use the operating menu.

### Changing from the standard display to the operating menu

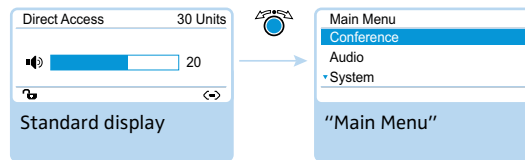

- ▶ Press the jog dial. The standard display is replaced by the main menu. The last selected menu item is highlighted.

### Calling up a menu item

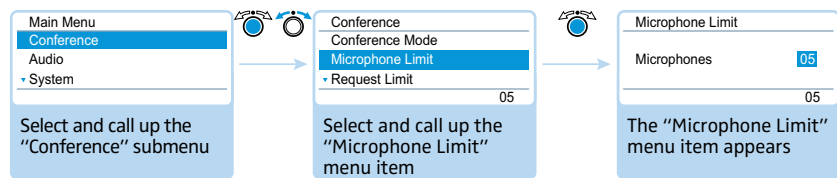

- ▶ Press the jog dial to call up the “Conference” menu item. The “Conference” submenu appears.
- ▶ Turn the jog dial to select the “Microphone Limit” menu item.
- ▶ Press the jog dial to call up the “Microphone Limit” menu item.

### Changing and storing settings

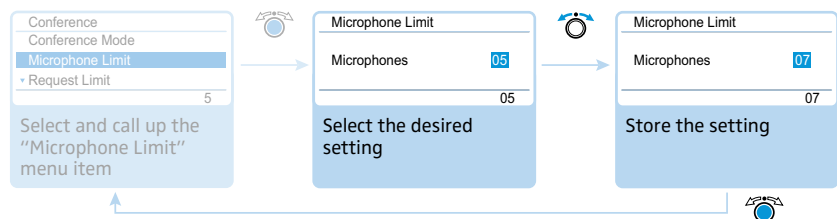

- ▶ Turn the jog dial to adjust settings in the “Microphone Limit” menu item.
- ▶ Press the jog dial. Your setting is stored. You are back to the operating menu.

### Canceling an entry

- ▶ Press the **ESC** key. The operating menu or the next higher menu level appears.

Or:

- ▶ Press the standard display key. The standard display appears.

To subsequently directly return to the last edited menu item:

- ▶ Press the jog dial repeatedly until the last edited menu item appears.

### Exiting the operating menu

- ▶ Press the standard display key. The standard display appears.

Or:

- ▶ Press the **ESC** key repeatedly until the standard display appears.

## Setting the volume of the conference units' built-in loudspeakers

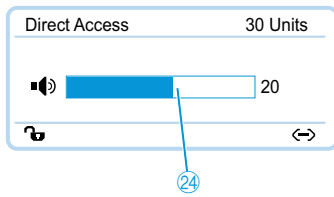

You can set the volume of the conference units' built-in loudspeakers via the jog dial on the central unit. The standard display displays the current volume setting 24.



### CAUTION

#### Danger of hearing damage due to loud hissing!

When the floor channel volume is set to a high level or when several participants speak simultaneously, feedback noise (loud hissing) can occur. This can cause hearing damage.

- ▶ Reduce the floor channel volume (see below).
- ▶ Make sure that the "Audio Gain Reduction" function is activated (see page 14). This function reduces the gain per active microphone by the selected level and thus prevents feedback noise.
- ▶ Increase the distance between the individual conference units to at least 50 cm.



- ▶ Turn the jog dial
  - to the right to increase the volume or
  - to the left to reduce the volume.

## Cleaning and maintaining the conference system

### CAUTION

#### Liquids can damage the product!

Liquids entering the product can cause a short-circuit in the electronics or damage the mechanics.

Solvents or cleansing agents can damage the surfaces of the product.

- ▶ Keep all liquids away from the product.
- ▶ Do not use any solvents or cleansing agents.

- ▶ Before cleaning, switch the product off and disconnect the central unit from the mains.
- ▶ Only use a dry and soft cloth to clean the product.

To ensure optimum cooling of the central unit:

- ▶ Clean the air vents on the front, back and bottom from time to time with a soft brush or paintbrush in order to avoid dust deposits.

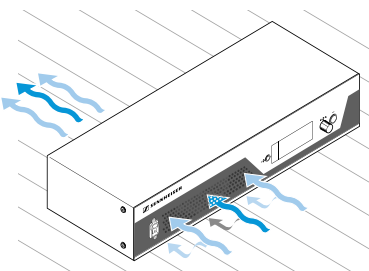

## Specifications – ADN CU1 central unit

Dimensions	417 x 100 x 345 mm (W x H x D)
Weight	approx. 6.5 kg
Nominal input voltage	100 to 240 V~
Mains frequency	50 to 60 Hz
Power consumption	245 W
Output voltage at RJ45 EtherCAT	52,8 V ---
Nominal output current	max. 1.75 A
Temperature range	operation: +5°C to +50°C storage: -25°C to +70°C
Relative humidity	operation: 10 to 80% storage: 10 to 90%

### XLR IN

Input resistance	$R_{IN} > 10\text{ K}\Omega$
Input level	max +18 dBu min -18 dBu
Nominal level	+7.5 dBu

### XLR OUT

Output resistance	$R_{OUT} < 100\ \Omega$
Frequency response	20 Hz to 14.5 kHz; -3 dB
Output level	max. +11 dBu
Nominal level	+6 dBu
DHT (at 1 kHz)	< 0.02% A-weighted at +7.5 dBu
Signal-to-noise ratio	> 80 dB A-weighted at +11 dBu

# Manufacturer Declarations

## Warranty

Sennheiser electronic GmbH & Co. KG gives a warranty of 24 months on this product. For the current warranty conditions, please visit our website at [www.sennheiser.com](http://www.sennheiser.com) or contact your Sennheiser partner.

## In compliance with the following requirements

- RoHS Directive (2002/95/EC)
- WEEE Directive (2002/96/EC)
- China-RoHS 

ADN CU1

部件名称 Parts	有毒有害物质或元素					
	铅 Pb	汞 Hg	镉 Cd	六价铬 Cr <sup>6+</sup>	多溴联苯 PBB	多溴二苯醚 PBDE
金属部件 Metal Parts	x	o	o	o	o	o
电路模块 Circuit Modules	x	o	o	o	o	o

o: 表示该有毒有害物质在该部件所有均质材料中的含量均在SJ/T11363-2006 标准规定的限量要求以下。

x: 表示该有毒有害物质至少在该部件的某一均质材料中的含量超出 SJ/T11363-2006 标准规定的限量要求。

## CE Declaration of Conformity

- 
- EMC Directive (2004/108/EC)
- Low Voltage Directive (2006/95/EC)

The declaration is available at [www.sennheiser.com](http://www.sennheiser.com).

## WEEE Declaration



Please dispose of this product at the end of its operational lifetime by taking it to your local collection point or recycling centre for such equipment. This will help to protect the environment in which we all live.

## Certified by:



Audio, Video and Similar Electronic Apparatus - Safety Requirements  
CAN/CSA C22.2 No. 60065-03 Incl. AM1 and UL Std. No. 60065-2007

## Trademarks

Sennheiser is a registered trademark of Sennheiser electronic GmbH & Co. KG.

Other product and company names mentioned in this instruction manual may be the trademarks or registered trademarks of their respective holders.

## Free Manuals Download Website

<http://myh66.com>

<http://usermanuals.us>

<http://www.somanuals.com>

<http://www.4manuals.cc>

<http://www.manual-lib.com>

<http://www.404manual.com>

<http://www.luxmanual.com>

<http://aubethermostatmanual.com>

Golf course search by state

<http://golfingnear.com>

Email search by domain

<http://emailbydomain.com>

Auto manuals search

<http://auto.somanuals.com>

TV manuals search

<http://tv.somanuals.com>