

 **SENNHEISER**



 evolution wireless 

# EK 100



Instruction manual

# Contents

Important safety instructions .....	2
The EK 100 G3 diversity receiver .....	3
The frequency bank system .....	3
Areas of application .....	4
Delivery includes .....	4
Product overview .....	5
Overview of the EK 100 G3 diversity receiver .....	5
Overview of the displays .....	6
Putting the diversity receiver into operation .....	7
Inserting the batteries/accupack .....	7
Charging the accupack .....	7
Mounting the diversity receiver to a camera .....	7
Using the diversity receiver .....	9
Switching the diversity receiver on/off .....	9
Deactivating the lock mode temporarily .....	10
Selecting a standard display .....	10
Using the operating menu .....	11
The buttons .....	11
Overview of the operating menu .....	11
Working with the operating menu .....	12
Adjusting settings via the operating menu .....	14
The main menu "Menu" .....	14
The extended menu "Advanced Menu" .....	16
Synchronizing a transmitter with the diversity receiver .....	19
Cleaning the diversity receiver .....	21
Recommendations and tips .....	21
If a problem occurs ... ..	22
Accessories .....	23
Specifications .....	23
Manufacturer Declarations .....	24
Index .....	26



For further information, visit the EK 100 G3 product page on our website at [www.sennheiser.com](http://www.sennheiser.com).

## Important safety instructions

- Read this instruction manual.
- Keep this instruction manual. Always include this instruction manual when passing the product on to third parties.
- Heed all warnings and follow all instructions in this instruction manual.
- Use only a cloth for cleaning the product.
- Do not place the product near any heat sources such as radiators, stoves, or other devices (including amplifiers) that produce heat.
- Only use attachments/accessories specified by Sennheiser.
- Refer all servicing to qualified service personnel.  
Servicing is required if the product has been damaged in any way, liquid has been spilled, objects have fallen inside, the product has been exposed to rain or moisture, does not operate properly or has been dropped.
- **WARNING:** To reduce the risk of short circuits, do not use the product near water and do not expose it to rain or moisture.

### Replacement parts

When replacement parts are required, be sure the service technician uses replacement parts specified by Sennheiser or those having the same characteristics as the original part. Unauthorized substitutions may result in fire, electric shock, or other hazards.

### Intended use

Intended use of the EK 100 G3 diversity receiver includes:

- having read these instructions especially the chapter "Important safety instructions",
- using the product within the operating conditions and limitations described in this instruction manual.

"Improper use" means using the product other than as described in this instruction manual, or under operating conditions which differ from those described herein.

## The EK 100 G3 diversity receiver

This diversity receiver is part of the evolution wireless series generation 3 (ew G3). With this series, Sennheiser offers high-quality state-of-the-art RF transmission systems with a high level of operational reliability and ease of use. Transmitters and receivers permit wireless transmission with studio-quality sound.

Features of the evolution wireless 100 G3 series:

- Optimized PLL synthesizer and microprocessor technology
- HDX noise reduction system
- Adaptive diversity technology
- Switching bandwidth of 42 MHz
- Scan function (Easy Setup) for scanning the frequency banks for unused channels

### Adaptive diversity

This diversity receiver uses the ground connection of the line cable as its second antenna to provide improved reception.

## The frequency bank system

The diversity receiver is available in 6 UHF frequency ranges with 1,680 receiving frequencies per frequency range:

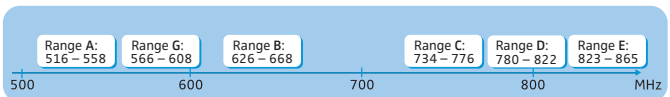

Each frequency range (A–E, G) offers 21 frequency banks with up to 12 channels each:

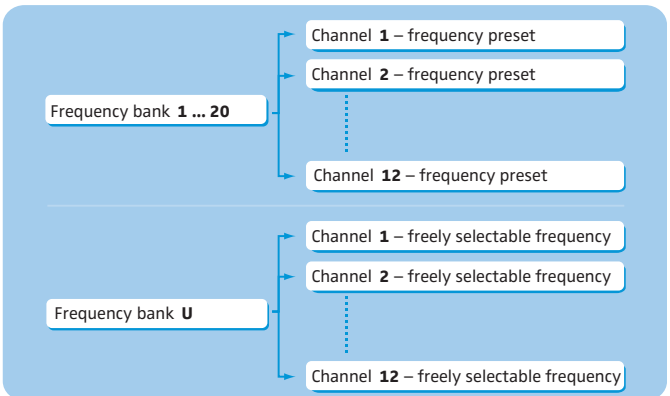

Each of the channels in the frequency banks "1" to "20" has been factory-preset to a fixed receiving frequency (frequency preset). The factory-preset frequencies within one frequency bank are intermodulation-free. These frequencies cannot be changed.

For an overview of the frequency presets, please refer to the supplied frequency information sheet. Updated versions of the frequency information sheet can be downloaded from the EK 100 G3 product page on our website at [www.sennheiser.com](http://www.sennheiser.com).

The frequency bank "U" allows you to freely select and store receiving frequencies. It might be that these receiving frequencies are **not** intermodulation-free (see page 19).

Delivery includes

## Areas of application

The receiver can be combined with the following transmitters:

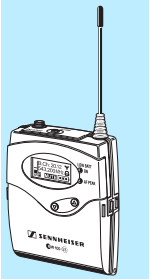
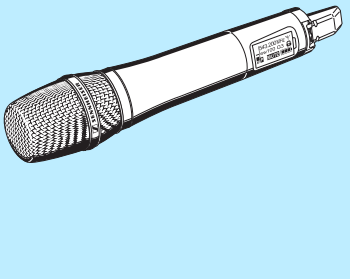
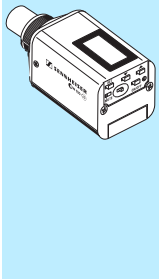
Bodypack transmitter	Radio microphone	Plug-on transmitter
SK 100	SKM 100	SKP 100
		

These transmitters are available in the same UHF frequency ranges and are equipped with the same frequency bank system with factory-preset frequencies. An advantage of the factory-preset frequencies is that

- a transmission system is ready for immediate use after switch-on,
- several transmission systems can be operated simultaneously on the preset frequencies without causing intermodulation interference.

## Delivery includes

The packaging contains the following items:

- 1 EK 100 G3 diversity receiver
- 2 AA size batteries, 1.5 V
- 1 CA 2 camera adapter
- 1 CL 100 line cable
- 1 CL 1 line cable
- 1 instruction manual
- 1 frequency information sheet

## Product overview

### Overview of the EK 100 G3 diversity receiver

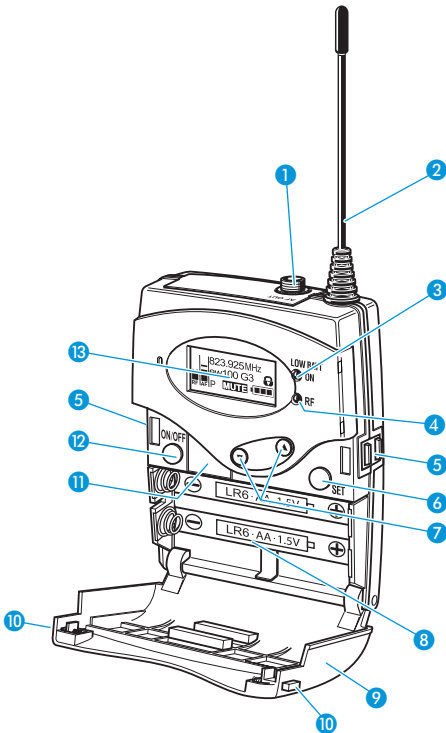





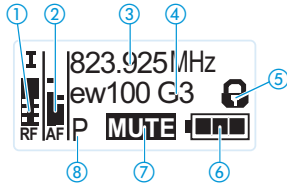

- 1 3.5 mm jack socket (**LINE**), lockable  
(the ground contact is used by antenna II)
- 2 Antenna I
- 3 Operation and battery status indicator, red LED  
lit = **ON**  
flashing = **LOW BATT**
- 4 RF signal indication, green LED  
lit = **RF**
- 5 Charging contacts
- 6 **SET** button
- 7 ▲/▼ rocker button (**UP/DOWN**)
- 8 Battery compartment
- 9 Battery compartment cover
- 10 Battery compartment catches
- 11 Infra-red interface
- 12 **ON/OFF** button with **ESC** function (cancel)
- 13 Display panel, backlit in orange

## Overview of the displays

After switch-on, the diversity receiver displays the “Frequency/Name” standard display. For further illustrations and examples of the different standard displays, refer to page 10.

The display backlighting is automatically reduced after approx. 20 seconds.

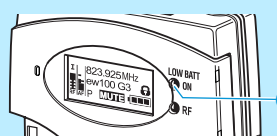

Display	Meaning
① RF level “RF” (Radio Frequency)	 Diversity display: <b>I</b> Antenna input I is active <b>II</b> Antenna input II is active RF signal level: Field strength of the received signal Squelch threshold level
② Audio level “AF” (Audio Frequency)	 Modulation of the transmitter Peak hold function When the display shows full deflection, the audio input level is excessively high. For details, see page 16.
③ Frequency	Current receiving frequency (see page 16)
④ Name	Freely selectable name of the receiver (see page 16)
⑤ Lock mode icon	Lock mode is activated (see page 10)
⑥ Battery status	Charge status:  approx. 100%  approx. 70%  approx. 30%  charge status is critical, the red <b>LOW BATT LED ③</b> is flashing: 
⑦ Muting function “MUTE” or line output level AF OUT	“Mute” is only displayed on the “Frequency/Name” standard display (see page 10) when the transmitter’s RF signal is deactivated. The diversity receiver does then not output an audio signal. The line output level <b>AF OUT</b> is only displayed on the “Frequency bank/Channel/Name” standard display (see page 10).
⑧ Pilot tone “P”	Activated pilot tone evaluation (see page 18)

## Putting the diversity receiver into operation

### Inserting the batteries/accupack

For powering the diversity receiver, you can either use two 1.5 V AA size batteries or the rechargeable Sennheiser BA 2015 accupack or the DC 2 power adapter (see "Accessories" on page 23).

- ▶ Open the battery compartment by pushing the two catches **10** in the direction of the arrows and open the cover **9**.

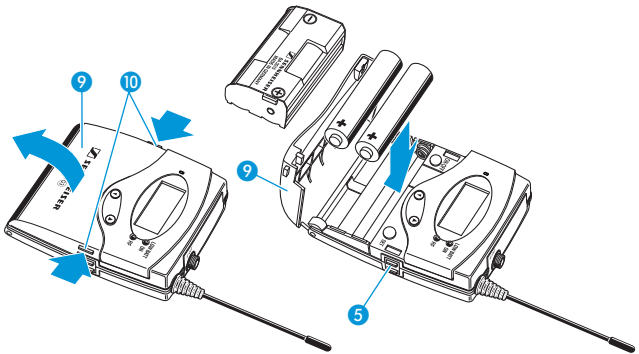

- ▶ Insert the two batteries or the accupack as shown above. Please observe correct polarity when inserting the batteries/accupack.
- ▶ Close the battery compartment by pressing on the center of the cover **9**. The battery compartment cover **9** locks into place with an audible click.

### Charging the accupack

To charge the BA 2015 accupack:

- ▶ Insert the diversity receiver into the L 2015 charger (see "Accessories" on page 23).



The L 2015 charger can only charge the combination BA 2015 accupack/diversity receiver. Standard batteries (primary cells) or individual rechargeable battery cells cannot be charged.

### Mounting the diversity receiver to a camera

Use the supplied CA 2 camera adapter to mount the receiver to a camera's flash mount.

- ▶ Determine where on the perforated plate **14** the flash mount adapter **15** will need to be fastened so that the receiver can best be attached to the camera.

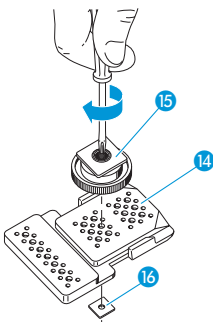

- ▶ At this position, place a square nut **16** under the perforated plate **14**.
- ▶ Fasten the flash mount adapter **15** to the perforated plate **14** using the square nut **16**.



## Putting the diversity receiver into operation

- ▶ Lift one side of the belt clip 17 as shown.

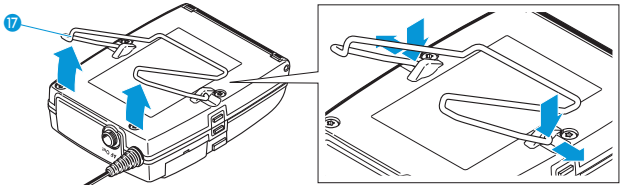

- ▶ Press down the belt clip 17 at one fixing point and pull it out of the receiver housing.
- ▶ Repeat for the other side.
- ▶ Place the perforated plate 14 onto the rear of the receiver.

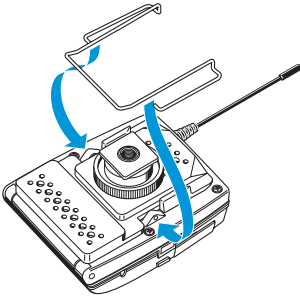

- ▶ Reinsert the belt clip 17.
- ▶ Use one of the supplied line cables to connect the line input of the camera to the socket 1.

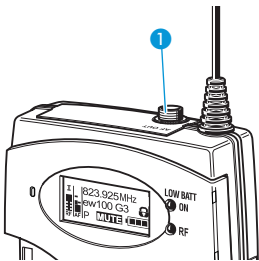

The ground connection of the line cable serves as the antenna for the second diversity section. For details on the connector assignment, refer to the diagram on page 24.

## Using the diversity receiver

To establish a transmission link, proceed as follows:

1. Switch the diversity receiver on (see next section).
2. Switch a transmitter on (see the instruction manual of the transmitter).  
The transmission link is established and the receiver's RF level display "RF" ① reacts.



It is vital to observe the notes on frequency selection on page 19.

If you cannot establish a transmission link between transmitter and receiver, read the chapter "Synchronizing a transmitter with the diversity receiver" on page 19.

### Switching the diversity receiver on/off

- ▶ Push the two battery compartment catches ⑩ and open the battery compartment cover ⑨.

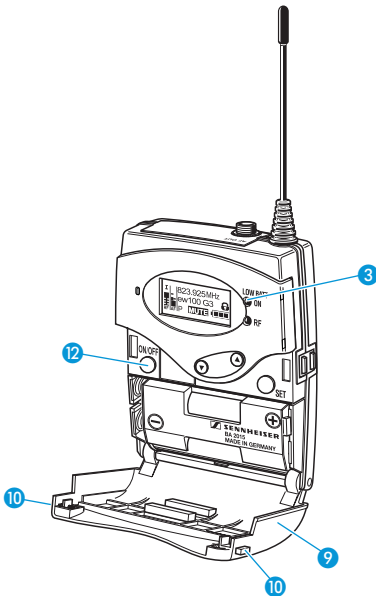

To switch the diversity receiver **on**:

- ▶ Press the **ON/OFF** button ⑫.  
The red **ON** LED ③ lights up and the standard display "Frequency/Name" appears on the display panel.

To switch the diversity receiver **off**:



- ▶ Keep the **ON/OFF** button ⑫ pressed until "OFF" appears on the display panel.  
The red **ON** LED ③ goes off and the diversity receiver switches off.



When in the operating menu, pressing the **ON/OFF** button ⑫ will cancel your entry (ESC function) and return you to the current standard display.

## Deactivating the lock mode temporarily

You can activate or deactivate the automatic lock mode via the “Auto Lock” menu item (see page 16). If the lock mode is activated, you have to temporarily deactivate it in order to be able to operate the receiver:





- 
  - ▶ Press the **SET** button.  
“Locked” appears on the display panel.
- 
  - ▶ Press the rocker button.  
“Unlock?” appears on the display panel.
- 
  - ▶ Press the **SET** button.
    - When you are in the operating menu, the lock mode remains deactivated until you exit the operating menu.
    - When one of the standard displays is shown, the lock mode is automatically activated after 10 seconds.

The lock mode icon  flashes prior to the lock mode being activated again.

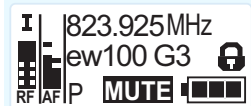

## Selecting a standard display

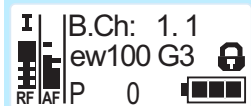
- 
  - ▶ Press the **ON/OFF** button to select a standard display.



Contents of the display	Selectable standard display
	“Frequency/Name” with “MUTE” display 
	“Frequency bank/Channel/Name” with display of the line output level “AF OUT” 

For more detailed information, refer to the chapter “Overview of the displays” on page 6.

## Using the operating menu

A special feature of the Sennheiser ew G3 series is the consistent, intuitive menu structure of transmitters and receivers. As a result, adjustments to the settings can be made quickly – even in stressful situations, for example on stage or during a live show or presentation.

### The buttons

Button	Function of the button
Press the <b>ON/OFF</b> button 	<ul style="list-style-type: none"> <li>• Switches the diversity receiver on and off</li> <li>• Selects a standard display (see page 10)</li> <li>• Cancels the entry and returns to the current standard display (ESC function)</li> </ul>
Press the <b>SET</b> button 	<ul style="list-style-type: none"> <li>• Changes from the current standard display to the operating menu</li> <li>• Calls up a menu item</li> <li>• Enters a submenu</li> <li>• Stores the settings and returns to the operating menu</li> </ul>
Press the rocker button 	<ul style="list-style-type: none"> <li>• Changes to the next/previous menu item</li> <li>• Changes the setting of a menu item</li> </ul>

### Overview of the operating menu

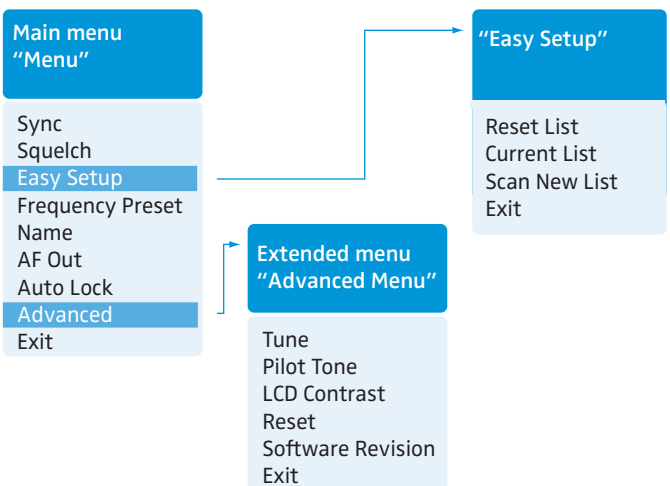

Display	Function of the menu item	Page
<b>Main menu "Menu"</b>		
Sync	Synchronizes a transmitter with the diversity receiver	14
Squelch	Adjusts the squelch threshold	14
Easy Setup	Scans for unused frequency presets, releases and selects frequency presets	15
Frequency Preset	Sets the frequency bank and the channel	15
Name	Enters a freely selectable name	16
AF Out	Adjusts the audio output level	16
Auto Lock	Activates/deactivates the automatic lock mode	16
Advanced	Calls up the extended menu "Advanced Menu"	16
Exit	Exits the operating menu and returns to the current standard display	–

Display	Function of the menu item	Page
<b>Extended menu "Advanced Menu"</b>		
Tune	Sets the receiving frequencies for the frequency bank "U"	16
	Sets the channel and the receiving frequency for the frequency bank "U"	17
Pilot Tone*	Activates/deactivates the pilot tone evaluation	18
LCD Contrast	Adjusts the contrast of the display panel	18
Reset	Resets the settings made in the operating menu	18
Software Revision	Displays the current software revision	18
Exit	Exits the extended menu "Advanced Menu" and returns to the main menu	-

## Working with the operating menu



If the lock mode is activated, you have to deactivate it in order to be able to work with the operating menu (see page 10).

By way of example of the "Frequency Preset" menu, this section describes how to use the operating menu.

### Changing from a standard display to the operating menu

- Press the **SET** button.  
 The current standard display is replaced by the main menu.  
 The last selected menu item is displayed.

### Selecting a menu item

- Press the rocker button to change to the "Frequency Preset" menu item.  
 The current setting of the selected menu item is displayed:

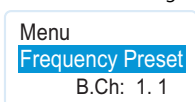

### Changing and storing settings

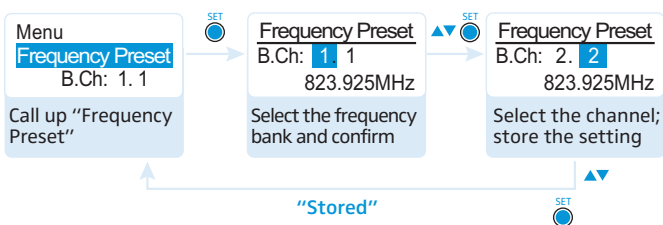

- Press the **SET** button to call up the menu item.
- Press the rocker button to set the frequency bank.
- Press the **SET** button to confirm your selection.
- Press the rocker button to set the channel.
- Press the **SET** button to store the setting.

### Canceling an entry

- ON/OFF** ▶ Press the **ON/OFF** button to cancel the entry.  
The current standard display appears on the display panel.



To subsequently return to the last edited menu item:

- SET** ▶ Press the **SET** button repeatedly until the last edited menu item appears.



### Exiting a menu item

To return to the next higher menu level:

- ▼▲** ▶ Change to the “Exit” menu item.

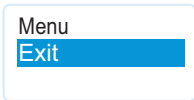

- SET** ▶ Confirm your selection.  
You return to the next higher menu level.



To directly return to the current standard display:

- ON/OFF** ▶ Press the **ON/OFF** button.



## Adjusting settings via the operating menu

### The main menu "Menu"

#### Synchronizing a transmitter with the diversity receiver – "Sync"

You can synchronize a suitable transmitter of the ew 100 G3 series with the diversity receiver. During synchronization, the following parameters are transferred to the transmitter:

- Current receiving frequency ("Frequency Preset", see page 15)
- Current name set for the receiver ("Name", see page 16)
- Current pilot tone setting of the receiver ("Pilot Tone", see page 18)

To transfer these parameters:

- ▶ Switch the transmitter and the diversity receiver on.
- ▶ On the receiver, call up the "Sync" menu item. "Sync" appears on the display panel of the receiver.
- ▶ Place the infra-red interface of the transmitter (see the instruction manual of the transmitter) in front of the infra-red interface of the receiver 11.

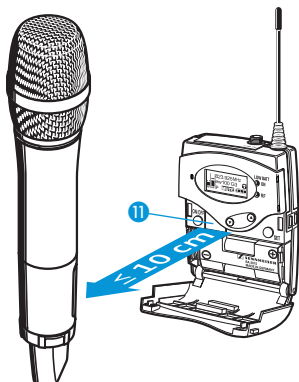

The parameters are transferred to the transmitter. When the transfer is completed, "✓" appears on the display panel of the diversity receiver. The receiver then switches back to the current standard display.

To cancel the transfer:

- ▶ Press the ON/OFF button 12 on the receiver. "X" appears on the display panel of the receiver. "X" also appears if:
  - no transmitter was found or the transmitter is not compatible,
  - no transmitter was found and the synchronization process was canceled after 30 seconds,
  - you canceled the transfer.

#### Adjusting the squelch threshold – "Squelch"

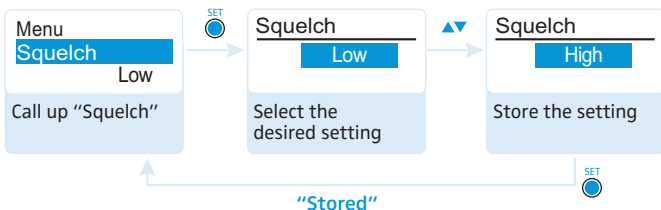

Adjustment range: "Low", "Middle", "High", can be switched off

The squelch eliminates annoying noise when the transmitter is switched off or when there is no longer sufficient transmitter power received by the receiver.

- ▶ Adjust the squelch threshold – with the transmitter switched off – to the lowest possible setting that suppresses hissing noise.



If the squelch threshold is set to "High", the transmission range will be reduced under unfavourable reception conditions.

The squelch should only be switched off for servicing purposes. With the squelch threshold set to "Low", you switch the squelch off by keeping the DOWN rocker button pressed for 3 seconds.

Display	Squelch is ...
	... switched on. The dotted line ⑩ displays the squelch threshold.
	... switched off. The dotted line ⑩ goes off and the audio level display "AF" shows full deflection (hissing noise).

If you have accidentally switched off the squelch:

- ▶ Press the UP rocker button to switch the squelch on.

### Scanning for, releasing and selecting frequency presets – "Easy Setup"

Menu item	Function of the menu item
Reset List	Releases all locked frequency presets
Current List	Selects an unused frequency preset
Scan New List	Automatically scans for unused receiving frequencies (frequency preset scan). If receiving frequencies are used, they will be locked; if receiving frequencies are unused, they will be released. After the frequency preset scan, you can select an unused frequency preset.

### Selecting the frequency bank and the channel – "Frequency Preset"

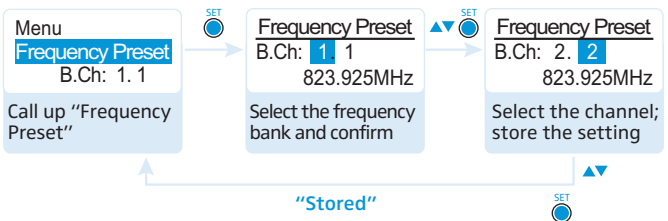

When setting up multi-channel systems, please observe the following:

Only the factory-preset receiving frequencies within one frequency bank ("1" to "20") are intermodulation-free. It is vital to observe the notes on frequency selection on page 19.

Overview of the frequency banks and channels:

Frequency bank	Channels	Type
"1" to "20"	up to 12 per frequency bank	System bank: frequencies are factory-preset
"U"	up to 12	User bank: frequencies are freely selectable



### Entering a name – “Name”

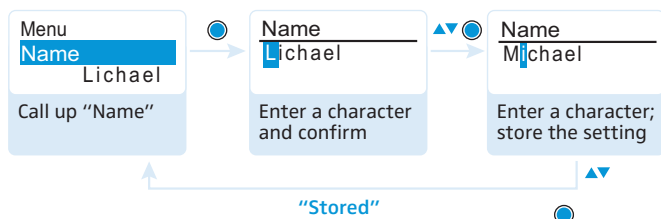

Via the “Name” menu, you can enter a freely selectable name (e.g. the name of the performer) for the receiver. The name is displayed on the standard display (see page 6). The name can consist of up to 8 characters such as:

- letters (without pronunciation marks),
- numbers from 0 to 9,
- special characters and spaces.

To enter a name, proceed as follows:

- ▶ Press the rocker button to select a character.
- ▶ Press the **SET** button to change to the next segment/character or to store the complete entry.

### Adjusting the audio output level – “AF Out”

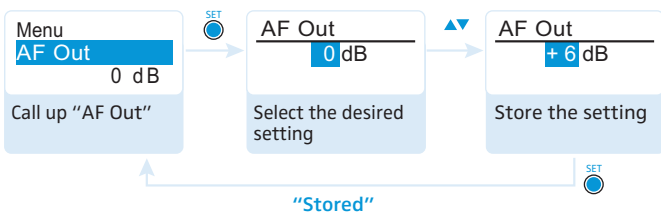

Adjustment range: –30 dB to +12 dB, adjustable in 6-dB steps

Via the “AF Out” menu item, you can adjust the level of the audio output **Line** from the receiver to the input of the connected camera.

### Activating/deactivating the automatic lock mode – “Auto Lock”

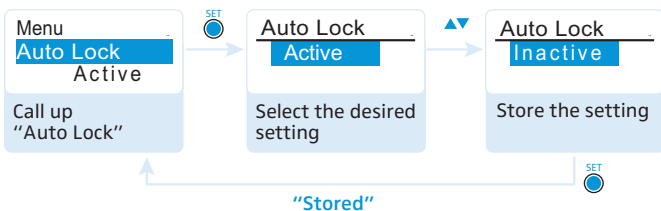

The lock mode prevents that the diversity receiver is accidentally switched off or programmed during operation. The lock mode icon ⑤  on the current standard display indicates that the lock mode is activated. For information on how to use the lock mode, refer to page 10.

### The extended menu “Advanced Menu”

To get into the extended menu “Advanced Menu”:

- ▶ From the main menu, select “Advanced”.

### Setting the receiving frequencies for the frequency bank “U” – “Tune”



When you have selected one of the system banks and then select the “Tune” menu, the diversity receiver automatically switches to channel 1 of the frequency bank “U”. In this case, “U.1” briefly appears on the display panel.

Upon delivery, the channels of the frequency bank “U” are not assigned a receiving frequency.

Via the "Tune" menu item, you can set a receiving frequency to be stored in the current channel **or** you can select a different channel in the frequency bank "U" and assign this channel a receiving frequency.

### Setting a receiving frequency for the current channel

- ▼ ▲ ▶ Press the rocker button until the "Tune" menu item appears.
- SET ▶ Press the SET button.  
The MHz section of the receiving frequency of the channel is highlighted.

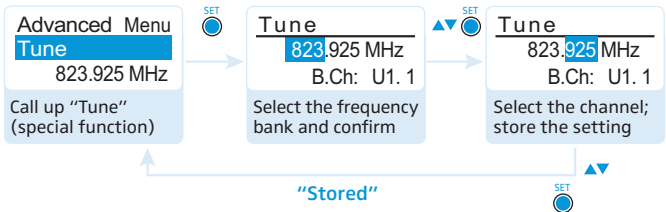

It is vital to observe the notes on frequency selection on page 19.

- ▼ ▲ ▶ Press the rocker button to set the MHz section of the frequency.
- SET ▶ Press the SET button to confirm the MHz section of the frequency.  
The kHz section of the frequency is highlighted.
- ▼ ▲ ▶ Press the rocker button to set the kHz section of the frequency.
- SET ▶ Press the SET button to confirm the frequency.  
"Stored" appears on the display panel. The "Tune" menu item appears again.

### Selecting a channel and assigning this channel a frequency

- ▼ ▲ ▶ Press the rocker button until the "Tune" menu item appears.
- SET ▶ Press the SET button and keep it pressed until the frequency bank is highlighted.

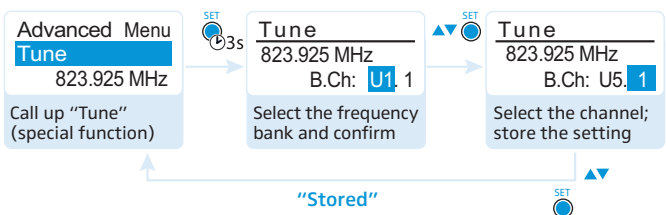

- ▼ ▲ ▶ Press the rocker button to set the channel.
- SET ▶ Press the SET button to confirm the channel.  
The frequency (MHz section) is highlighted.
- ▶ Set the desired frequency (MHz and kHz section) as described in the previous chapter.

### Activating/deactivating the pilot tone evaluation – “Pilot Tone”

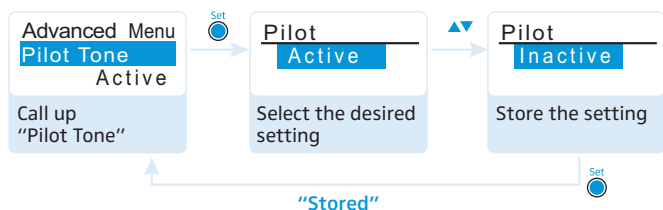

The transmitter adds an inaudible signal, known as the pilot tone, to the transmitted signal. The diversity receiver detects and evaluates the pilot tone. The pilot tone supports the diversity receiver’s squelch function, thus protecting against interference due to RF signals from other devices.

Display	Meaning
No icon	The pilot tone evaluation is deactivated.
<b>P</b>	The pilot tone evaluation is activated but the receiver does not receive a pilot tone.
<b>P</b>	The pilot tone evaluation is activated. The receiver receives a pilot tone.

Observe the following when combining a transmitter or receiver of the ew 100 G3 series (generation 3) with devices from an earlier evolution wireless generation:



Devices of the ew 100 G1 series (generation 1) do not support the pilot tone function.

Transmitter	Receiver	Make sure to ...
ew G3/ew G2	ew G3/ew G2	... activate the pilot tone function on both transmitter and diversity receiver.
ew G3	ew G1	... deactivate the pilot tone function on the ew 100 G3 transmitter.
ew G1	ew G3	... deactivate the pilot tone function on the ew 100 G3 diversity receiver.

### Adjusting the contrast of the display panel – “LCD Contrast”

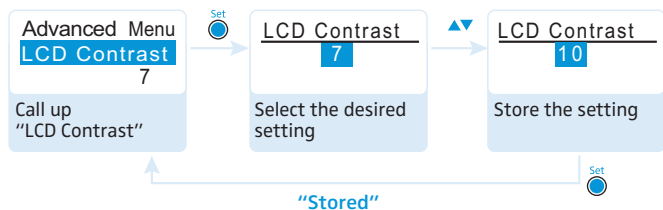

You can adjust the contrast of the display panel in 16 steps.

### Resetting the settings made in the operating menu – “Reset”

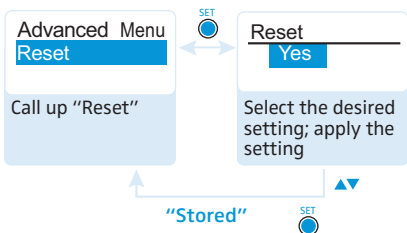

When resetting the settings made in the operating menu, only the selected settings for the pilot tone and for the frequency bank “U” remain unchanged. For an overview of the factory-preset default settings, refer to the supplied frequency information sheet.

### Displaying the software revision – “Software Revision”

You can display the current software revision of the diversity receiver.

## Synchronizing a transmitter with the diversity receiver



When synchronizing a transmitter with a diversity receiver, please observe the following:

- ▶ Only use a transmitter and a diversity receiver from the same frequency range (see the type plates on the transmitter and the diversity receiver).
- ▶ Make sure that the desired frequencies are listed in the enclosed frequency information sheet.  
You can also contact your Sennheiser partner who will be pleased to calculate intermodulation-free frequencies for you.
- ▶ Make sure that the desired frequencies are approved and legal in your country and, if necessary, apply for an operating license.

Upon delivery, transmitter and diversity receiver are synchronized with each other. If, however, you cannot establish a transmission link between transmitter and diversity receiver, you have to synchronize the channels of the devices:

- ▶ Deactivate the RF signal on all transmitters (see the instruction manual of the transmitter).  
This prevents that, during the frequency scan, the channels used by switched-on transmitters are displayed as "used".
- ▶ With a diversity receiver, perform a frequency preset scan to scan the frequency banks for unused channels ("Scan New List", see page 15).
- ▶ Select a frequency bank and a channel on this diversity receiver ("Current List", see page 15).  
If you want to set up a multi-channel system, select a frequency bank with a sufficient number of unused channels for all planned transmission links.
- ▶ Synchronize a transmitter with the diversity receiver (see page 14).  
The receiver's frequency, name and pilot tone setting are transferred to the transmitter.

OR:

- ▶ Manually set the transmitter to the same frequency bank and channel that you set on the receiver.
- ▶ Activate the RF signal on this transmitter.  
The transmission link is established.

If you want to set up a multi-channel system:

- ▶ Repeat the following 4 steps for each additional transmission link:
  - Perform a frequency preset scan with the next diversity receiver.
  - Select a channel from the same frequency bank as with the first diversity receiver.
  - Synchronize a transmitter with the diversity receiver.
  - Activate the RF signal on the transmitter.

### Using freely selectable receiving frequencies

You can also freely select the receiving frequencies and store these frequencies in the frequency bank "U".



**It might be that the freely selected frequencies are not intermodulation-free**

If you use frequencies from the frequency bank "U", it might be that the frequencies are not intermodulation-free.

- ▶ Contact your Sennheiser partner who will be pleased to calculate intermodulation-free frequencies for you (see [www.sennheiser.com](http://www.sennheiser.com)).

- ▶ Set each diversity receiver to the frequency bank "U".

- ▶ On one of the receivers, select a channel within this frequency bank and assign this channel one of the calculated receiving frequencies (see page 17).
- ▶ Synchronize a transmitter with this receiver (see page 14).  
OR:
- ▶ Manually set the transmitter to the same frequency bank and channel that you set on the receiver.
- ▶ Repeat for the remaining transmitters and receivers as described above.

## Cleaning the diversity receiver

**CAUTION!** Liquids can damage the electronics of the receiver!  
Liquids entering the housing of the device can cause a short-circuit and damage the electronics.

- ▶ Keep all liquids away from the receiver.
- ▶ Do not use any solvents or cleansing agents.

▶ Use a cloth to clean the diversity receiver from time to time.

## Recommendations and tips

### ... for the diversity receiver

- Make sure that the antenna and the line cable do not cross.
- For best results, make sure that the transmitter sensitivity is correctly adjusted.

### ... for optimum reception

- Transmission range depends to a large extent on location and can vary from about 10 m to about 150 m. There should be a "free line of sight" between transmitting and receiving antennas.
- To avoid overloading the receiver, observe a minimum distance of 5 m between transmitting and receiving antennas.

### ... for multi-channel operation

- When operating a multi-channel system, you should only use the channels within one frequency bank. Each of the frequency banks "1" to "20" accommodates factory-preset frequencies which are intermodulation-free.
- The frequency bank "U" allows you to freely select and store receiving frequencies (see page 16).
- When using several transmitters simultaneously, interference can be avoided by maintaining a minimum distance of 20 cm between two transmitters.

## If a problem occurs ...

Problem	Possible cause	Possible solution
Diversity receiver cannot be operated, "Locked" appears on the display panel	Lock mode is activated	Deactivate the lock mode (see page 10).
No operation indication	Batteries are flat or accupack is flat	Replace the batteries or recharge the accupack (see page 7).
No RF signal	Transmitter and receiver are not on the same channel	Set the transmitter and receiver to the same channel. Synchronize the transmitter with the receiver (see page 14).
	Transmission range is exceeded	Check the squelch threshold setting (see page 14). Reduce the distance between transmitter and receiver.
	RF signal is deactivated ("RF Mute")	Activate the RF signal (see the instruction manual of the transmitter).
RF signal available, no audio signal, "MUTE" appears on the display panel	Transmitter is muted	Cancel the muting (see the instruction manual of the transmitter).
	Receiver's squelch threshold is adjusted too high	Reduce the squelch threshold setting (see page 14).
	Transmitter doesn't transmit a pilot tone	Deactivate the pilot tone evaluation (see page 18).
Audio signal has a high level of background noise	Transmitter sensitivity is adjusted too low	Adjust the transmitter sensitivity correctly (see the instruction manual of the transmitter).
Audio signal is distorted	Transmitter sensitivity is adjusted too high	Adjust the transmitter sensitivity correctly (see the instruction manual of the transmitter).
	Receiver's audio output level is adjusted too high	Reduce the audio output level ("AF Out", see page 16).
No access to a certain channel	During scanning, an RF signal has been detected on this channel and the channel has been locked	Set the transmitter operating on this channel to a different channel and redo the frequency preset scan (see page 15).
	During scanning, a transmitter of your system operating on this channel has not been switched off	Switch the transmitter off and redo the frequency preset scan (see page 15).

If a problem occurs that is not listed in the above table or if the problem cannot be solved with the proposed solutions, please contact your local Sennheiser partner for assistance.

To find a Sennheiser partner in your country, search at [www.sennheiser.com](http://www.sennheiser.com) under "Service & Support".

## Accessories

The following EK 100 G3 accessories are available from your specialist dealer:

Cat. No.	Accessory
009950	BA 2015 accupack
009828	L 2015 charger
009827	DC 2 power adapter for external DC powering (12 V)
009986	CA 2 camera adapter
005022	CL 1 line cable (jack to jack)
087046	CL 100 line cable (XLR-3 to jack)

## Specifications

### RF characteristics

Modulation	wideband FM
Frequency ranges	516–558, 566–608, 626–668, 734–776, 780–822, 823–865 MHz (A to E, G, see page 3)
Receiving frequencies	1,680 frequencies, tuneable in steps of 25 kHz 20 frequency banks, each with up to 12 factory-preset channels 1 frequency bank with up to 12 user programmable channels
Switching bandwidth	42 MHz
Nominal/peak deviation	$\pm 24$ kHz/ $\pm 48$ kHz
Receiver principle	adaptive diversity
Sensitivity (with HDX, peak deviation)	$< 1.6 \mu\text{V}$ for 52 dB <sub>A,rms</sub> S/N
Adjacent channel rejection	typ. $\geq 65$ dB
Intermodulation attenuation	typ. $\geq 65$ dB
Blocking	$\geq 70$ dB
Squelch	Off, Low: 5 dB $\mu\text{V}$ , Middle: 15 dB $\mu\text{V}$ , High: 25 dB $\mu\text{V}$
Pilot tone squelch	can be switched off

### AF characteristics

Compander system	Sennheiser HDX
S/N ratio (1 mV, peak deviation)	$\geq 60$ dB
THD	$\leq 0.9\%$
AF output voltage (at peak deviation, 1 kHz AF)	3.5 mm jack socket: +11 dBu (mono, unbalanced)
Adjustment range of audio output level	42 dB, adjustable in steps of 6 dB

### Overall device

Temperature range	$-10^{\circ}\text{C}$ to $+55^{\circ}\text{C}$
Power supply	2 AA size batteries, 1.5 V or BA 2015 accupack
Nominal voltage	2.4 V $\approx \approx$
Power consumption:	
• at nominal voltage	typ. 140 mA
• with switched-off receiver	$\leq 25 \mu\text{A}$



## Manufacturer Declarations

Operating time	typ. 8 hrs
Dimensions	approx. 82 x 64 x 24 mm
Weight (incl. batteries)	approx. 120 g

### In compliance with

Europe	<b>CE</b> EMC: EN 301489-1/-9 Radio: EN 300422-1/-2 Safety: EN 60065
--------	--

USA	<b>FC</b> 47 CFR 15 subpart B
-----	-------------------------------

### Approved by

Canada	Industry Canada RSS 123 IC 2099A-G3EK100 limited to 806 MHz
--------	---

### Connector assignment

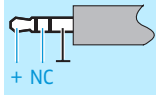
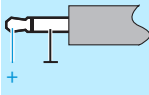
3.5 mm jack plug	
wired stereo	wired mono
	

## Manufacturer Declarations

### Warranty

Sennheiser electronic GmbH & Co. KG gives a warranty of 24 months on this product.

For the current warranty conditions, please visit our website at [www.sennheiser.com](http://www.sennheiser.com) or contact your Sennheiser partner.

### In compliance with the following requirements

- RoHS Directive (2002/95/EC)
- WEEE Directive (2002/96/EC)



Please dispose of the diversity receiver at the end of its operational lifetime by taking it to your local collection point or recycling center for such equipment.

- Battery Directive (2006/66/EC)



The supplied batteries or rechargeable batteries can be recycled. Please dispose of them as special waste or return them to your specialist dealer. In order to protect the environment, only dispose of exhausted batteries.

### CE Declaration of Conformity

- **CE 0682**
- R&TTE Directive (1999/5/EC)

The declarations are available at [www.sennheiser.com](http://www.sennheiser.com).

Before putting the device into operation, please observe the respective country-specific regulations.

## Statements regarding FCC and Industry Canada

This device complies with Part 15 of the FCC Rules and with RSS-210 of Industry Canada. Operation is subject to the following two conditions: (1) this device may not cause harmful interference, and (2) this device must accept any interference received, including interference that may cause undesired operation.

This equipment has been tested and found to comply with the limits for a Class B digital device, pursuant to Part 15 of the FCC Rules. These limits are designed to provide reasonable protection against harmful interference in a residential installation. This equipment generates, uses and can radiate radio frequency energy and, if not installed and used in accordance with the instructions, may cause harmful interference to radio communications. However, there is no guarantee that interference will not occur in a particular installation. If this equipment does cause harmful interference to radio or television reception, which can be determined by turning the equipment off and on, the user is encouraged to try to correct the interference by one or more of the following measures:

- Reorient or relocate the receiving antenna.
- Increase the separation between the equipment and receiver.
- Connect the equipment into an outlet on a circuit different from that to which the receiver is connected.
- Consult the dealer or an experienced radio/TV technician for help.

This class B digital device complies with the Canadian ICES-003.

Changes or modifications made to this equipment not expressly approved by Sennheiser electronic Corp. may void the FCC authorization to operate this equipment.

Before putting the device into operation, please observe the respective country-specific regulations!

# Index

- Accessories 23
- Accupack
  - charging 7
  - inserting 7
- Advanced Menu (extended menu)
  - overview 12
  - settings 16
- AF Out (adjusting the audio output level) 16
- Auto Lock (activating/deactivating the lock mode) 16
- Batteries
  - battery status 6
  - inserting 7
- Buttons
  - function of the ~ 11
  - ON/OFF button 5
  - SET button 5
  - UP/DOWN button 5
- Channel
  - assigning a frequency 17
  - selecting 15
  - setting a frequency 17
- Displays
  - adjusting the contrast of the display panel (LCD Contrast) 18
  - AF (audio level) 6
  - AF OUT 6
  - LOW BATT 6
  - MUTE 6
  - RF (RF level) 6
  - standard displays 10
- Easy Setup (scanning for, releasing and selecting frequency presets) 15
- Frequency bank
  - selecting 15
  - setting a frequency 17
  - ~ system 3
- Frequency Preset (selecting a frequency bank/channel) 15
- Frequency presets
  - releasing (Reset List) 15
  - searching for unused ~ (Scan New List) 15
  - selecting (Current List) 15
- Lock mode
  - activating/deactivating (Auto Lock) 16
  - deactivating temporarily 10
  - lock mode icon 6
- Locked 10
- LOW BATT 5
- Menu (main menu)
  - overview 11
  - settings 14
- Name (entering a name) 16
- Operating menu
  - overview 11
  - settings 14
  - using 12
- Pilot Tone (activating/deactivating the pilot tone evaluation) 18
- Receiver
  - cleaning 21
  - mounting to a camera 7
  - switching off 9
  - switching on 9
- Reset (resetting the settings made in the operating menu) 18
- RF signal indication 5
- Software Revision (displaying the software revision) 18
- Squelch (adjusting the squelch) 14
- Sync (synchronizing a transmitter with the receiver) 14
- Transmitter (synchronizing with receiver) 19
- Troubleshooting 22
- Tune (setting the receiving frequencies for the frequency bank "U") 16

Sennheiser electronic GmbH & Co. KG  
Am Labor 1, 30900 Wedemark, Germany  
[www.sennheiser.com](http://www.sennheiser.com)

Printed in Germany  
Publ. 01/09  
529667/A01

## Free Manuals Download Website

<http://myh66.com>

<http://usermanuals.us>

<http://www.somanuals.com>

<http://www.4manuals.cc>

<http://www.manual-lib.com>

<http://www.404manual.com>

<http://www.luxmanual.com>

<http://aubethermostatmanual.com>

Golf course search by state

<http://golfingnear.com>

Email search by domain

<http://emailbydomain.com>

Auto manuals search

<http://auto.somanuals.com>

TV manuals search

<http://tv.somanuals.com>