

# Model DPX2203™ and EPX2203™ VoIP Cable Modem User's Guide



## In This Document

■ IMPORTANT SAFETY INFORMATION .....	2
■ FCC Compliance.....	8
■ Introduction .....	9
■ What's In the Carton? .....	10
■ Front Panel Components.....	11
■ Back Panel Components.....	13
■ Where Is the Best Location for My Cable Modem? .....	14
■ What Are the System Requirements for Internet Service? .....	15
■ How Do I Set Up My High-Speed Internet Access Account? .....	16
■ How Do I Connect My Devices to Use the Internet?.....	17
■ How Do I Configure TCP/IP Protocol? .....	19
■ How Do I Install USB Drivers?.....	22
■ What Are the Requirements for Ethernet Network Devices? .....	24
■ How Do I Select and Place Ethernet Network Devices? .....	25
■ How Do I Connect Ethernet Network Devices? .....	26
■ How Do I Troubleshoot My Internet Service Installation?.....	28
■ How Do I Use My Cable Modem for Telephone Service?.....	31
■ Where Do I Place My Cable Modem for Telephone Service? .....	32
■ What Are the Requirements for Telephone Service? .....	33
■ How Do I Install the Modem for Telephone Service? .....	34
■ Using the Battery Pack (Optional) .....	37
■ Mount the Battery Pack on a Wall .....	40
■ Having Difficulty?.....	44
■ Front Panel LED Status Indicator Functions .....	47
■ Notices .....	50

# IMPORTANT SAFETY INFORMATION

## Notice to Installers



The servicing instructions in this notice are for use by qualified service personnel only. To reduce the risk of electric shock, do not perform any servicing other than that contained in the operating instructions, unless you are qualified to do so.

<p><b>Note to System Installer</b></p> <p>For this apparatus, the coaxial cable shield/ screen shall be grounded as close as practical to the point of entry of the cable into the building. For products sold in the US and Canada, this reminder is provided to call the system installer's attention to Article 820-93 and Article 820-100 of the NEC (or Canadian Electrical Code Part 1), which provides guidelines for proper grounding of the coaxial cable shield.</p> <div style="text-align: center;">  </div> <p>This symbol is intended to alert you that uninsulated voltage within this product may have sufficient magnitude to cause electric shock. Therefore, it is dangerous to make any kind of contact with any inside part of this product.</p>	<div style="text-align: center;">  </div> <div style="text-align: center;"> <p><b>CAUTION</b> RISK OF ELECTRIC SHOCK DO NOT OPEN</p> <p><b>AVIS</b> RISQUE DE CHOC ÉLECTRIQUE NE PAS OUVRIR</p> </div> <p>CAUTION: To reduce the risk of electric shock, do not remove cover (or back). No user-serviceable parts inside. Refer servicing to qualified service personnel.</p> <p><b>WARNING</b> TO PREVENT FIRE OR ELECTRIC SHOCK, DO NOT EXPOSE THIS UNIT TO RAIN OR MOISTURE.</p> <div style="text-align: center;">  </div> <p>This symbol is intended to alert you of the presence of important operating and maintenance (servicing) instructions in the literature accompanying this product.</p>
--	---

20060608SICM-EN

## Notice à l'attention des installateurs de réseaux câblés



Les instructions relatives aux interventions d'entretien, fournies dans la présente notice, s'adressent exclusivement au personnel technique qualifié. Pour réduire les risques de chocs électriques, n'effectuer aucune intervention autre que celles décrites dans le mode d'emploi et les instructions relatives au fonctionnement, à moins que vous ne soyez qualifié pour ce faire.

<p><b>Remarque à l'attention de l'installateur du système</b></p> <p>Avec cet appareil, le blindage/écran du câble coaxial doit être mis à la terre aussi près que possible du point d'entrée du câble dans le bâtiment. En ce qui concerne les produits vendus aux États-Unis et au Canada, ce rappel est fourni pour attirer l'attention de l'installateur sur les articles 820-93 et 820-100 du Code national de l'électricité (ou Code de l'électricité canadien, Partie 1) qui fournissent des lignes directrices concernant la mise à la terre correcte du blindage (écran) du câble coaxial.</p> <div style="text-align: center;">  </div> <p>Ce symbole a pour but de vous prévenir que des tensions électriques non isolées existent à l'intérieur de ce produit, pouvant être d'une intensité suffisante pour causer des chocs électriques. Il est donc dangereux d'établir un contact quelconque avec l'une des pièces comprises à l'intérieur de ce produit.</p>	<div style="text-align: center;">  </div> <div style="text-align: center;"> <p><b>CAUTION</b> RISK OF ELECTRIC SHOCK DO NOT OPEN</p> <p><b>ATTENTION</b> DANGER ÉLECTRIQUE NE PAS OUVRIR</p> </div> <p>ATTENTION : Pour réduire les risques de chocs électriques, ne pas enlever le couvercle (ou le panneau arrière). Ne contient aucune pièce réparable par l'utilisateur. Confier les interventions aux techniciens d'entretien qualifiés.</p> <p><b>AVERTISSEMENT</b> POUR ÉVITER LES INCENDIES OU LES CHOC ÉLECTRIQUES, NE PAS EXPOSER L'APPAREIL À LA PLUIE OU À L'HUMIDITÉ.</p> <div style="text-align: center;">  </div> <p>Ce symbole a pour but de vous prévenir de la présence d'instructions importantes relatives au fonctionnement ou à l'entretien (et aux réparations) dans la documentation accompagnant ce produit.</p>
---	--

20060608SICM-FR

## Mitteilung für CATV-Techniker

Die in dieser Mitteilung aufgeführten Wartungsanweisungen sind ausschließlich für qualifiziertes Fachpersonal bestimmt. Um die Gefahr eines elektrischen Schlags zu reduzieren, sollten Sie keine Wartungsarbeiten durchführen, die nicht ausdrücklich in der Bedienungsanleitung aufgeführt sind, außer Sie sind zur Durchführung solcher Arbeiten qualifiziert.

<p><b>Mitteilung an den Systemtechniker</b></p> <p>Für dieses Gerät muss der Koaxialkabelschutz/ Schirm so nahe wie möglich am Eintrittspunkt des Kabels in das Gebäude geerdet werden. Dieser Erinnerungshinweis liegt den in den USA oder Kanada verkauften Produkten bei. Er soll den Systemtechniker auf Paragraph 820-93 und Paragraph 820-100 der US-Elektrovorschrift NEC (oder der kanadischen Elektrovorschrift Canadian Electrical Code Teil 1) aufmerksam machen, in denen die Richtlinien für die ordnungsgemäße Erdung des Koaxialkabelschirms festgehalten sind.</p>  <p>Dieses Symbol weist den Benutzer auf das Vorhandensein von nicht isolierten gefährlichen Spannungen im Gerät hin, die Stromschläge verursachen können. Ein Kontakt mit den internen Teilen dieses Produktes ist mit Gefahren verbunden.</p>	<table border="1"> <tr> <td data-bbox="760 470 829 533"></td> <td data-bbox="841 436 1003 499"> <p><b>CAUTION</b> RISK OF ELECTRIC SHOCK DO NOT OPEN</p> </td> <td data-bbox="1015 470 1084 533"></td> </tr> <tr> <td></td> <td data-bbox="841 506 1003 569"> <p><b>ACHTUNG</b> STROMSCHLAGEGFAHR, NICHT ÖFFNEN</p> </td> <td></td> </tr> </table> <p>ACHTUNG: Zur Vermeidung eines Stromschlags darf die Abdeckung (bzw. die Geräterückwand) nicht entfernt werden. Das Gerät enthält keine vom Benutzer wartbaren Teile. Wartungsarbeiten dürfen nur von qualifiziertem Fachpersonal durchgeführt werden.</p> <p><b>WARNUNG</b> DAS GERÄT NICHT REGEN ODER FEUCHTIGKEIT AUSSETZEN, UM STROMSCHLAG ODER DURCH EINEN KURZSCHLUSS VERURSACHTEN BRAND ZU VERMEIDEN.</p>  <p>Dieses Symbol weist den Benutzer darauf hin, dass die mit diesem Produkt gelieferte Dokumentation wichtige Betriebs- und Wartungsanweisungen für das Gerät enthält.</p>		<p><b>CAUTION</b> RISK OF ELECTRIC SHOCK DO NOT OPEN</p>			<p><b>ACHTUNG</b> STROMSCHLAGEGFAHR, NICHT ÖFFNEN</p>	
	<p><b>CAUTION</b> RISK OF ELECTRIC SHOCK DO NOT OPEN</p>						
	<p><b>ACHTUNG</b> STROMSCHLAGEGFAHR, NICHT ÖFFNEN</p>						

20060608SICM-GR

## Aviso a los instaladores de sistemas CATV

Las instrucciones de reparación contenidas en el presente aviso son para uso exclusivo por parte de personal de mantenimiento cualificado. Con el fin de reducir el riesgo de descarga eléctrica, no realice ninguna otra operación de reparación distinta a las contenidas en las instrucciones de funcionamiento, a menos que posea la cualificación necesaria para hacerlo.

<p><b>Nota para el instalador del sistema</b></p> <p>En lo que se refiere a este aparato, el blindaje del cable coaxial debe conectarse a tierra lo más cerca posible al punto por el cual el cable entra en el edificio. En el caso de los productos vendidos en los EE. UU. y Canadá, el presente aviso se suministra para llamar la atención del instalador del sistema sobre los Artículos 820-93 y 820-100 del NEC (o Código Eléctrico de Canadá, Parte 1), que proporcionan directrices para una correcta conexión a tierra del blindaje del cable coaxial.</p>  <p>Este símbolo tiene como fin advertirle de que una tensión sin aislamiento en el interior de este producto podría ser de una magnitud suficiente como para provocar una descarga eléctrica. Por consiguiente, resulta peligroso realizar cualquier tipo de contacto con alguno de los componentes internos de este producto.</p>	<table border="1"> <tr> <td data-bbox="760 1257 829 1320"></td> <td data-bbox="841 1224 1003 1287"> <p><b>CAUTION</b> RISK OF ELECTRIC SHOCK DO NOT OPEN</p> </td> <td data-bbox="1015 1257 1084 1320"></td> </tr> <tr> <td></td> <td data-bbox="841 1293 1003 1356"> <p><b>ATENCIÓN</b> RIESGO DE DESCARGA ELÉCTRICA NO ABRIR</p> </td> <td></td> </tr> </table> <p>ATENCIÓN: con el fin de reducir el riesgo de descarga eléctrica, no retire la tapa (ni la parte posterior). No existen en el interior componentes que puedan ser reparados por el usuario. Encargue su revisión a personal de mantenimiento cualificado.</p> <p><b>ADVERTENCIA</b> PARA EVITAR EL RIESGO DE INCENDIO O DESCARGA ELÉCTRICA, NO EXPONGA LA UNIDAD A LA LLUVIA O A LA HUMEDAD.</p>  <p>Este símbolo tiene como fin alertarle de la presencia de importantes instrucciones de operación y mantenimiento (revisión) contenidas en la literatura que acompaña al producto.</p>		<p><b>CAUTION</b> RISK OF ELECTRIC SHOCK DO NOT OPEN</p>			<p><b>ATENCIÓN</b> RIESGO DE DESCARGA ELÉCTRICA NO ABRIR</p>	
	<p><b>CAUTION</b> RISK OF ELECTRIC SHOCK DO NOT OPEN</p>						
	<p><b>ATENCIÓN</b> RIESGO DE DESCARGA ELÉCTRICA NO ABRIR</p>						

20060608SICM-SP

## IMPORTANT SAFETY INFORMATION

### Heed All Warnings

Adhere to all warnings on the product and in the operating instructions.

### Read, Retain, and Follow These Instructions

Carefully read all safety and operating instructions before operating this product. Follow all operating instructions that accompany this product. Retain the instructions for future use. Give particular attention to all safety precautions.

### Comply with Warnings

Avoid electric shock. Comply with all warnings and cautions in the operating instructions, as well as those that are affixed to this product.

### Power Warnings

#### Providing a Power Source

A label on this product indicates the correct power source for this product. Operate this product only from an electrical outlet with the voltage and frequency indicated on the product label.

If you are uncertain of the type of power supply to your home or business, consult your service provider or your local power company.

#### Grounding This Product (U.S.A. and Canada Only)



#### WARNING:

To avoid electric shock and fire hazard, do not defeat the safety purpose of the polarized or grounding-type plug. A polarized plug has two blades with one wider than the other. A grounding-type plug has two blades and a third grounding prong. The wide blade or the third prong is provided for your safety. If the provided plug does not fit into your outlet, consult an electrician for replacement of the obsolete outlet.

If this product is equipped with either a three-prong (grounding pin) safety plug or a two-prong (polarized) safety plug, do not defeat the safety purpose of the polarized or grounding-type plug. Follow these safety guidelines to properly ground this product:

- For a 3-prong plug (consists of two blades and a third grounding prong), insert the plug into a grounded mains, 3-prong outlet.  
**Note:** This plug fits only one way. The grounding prong is provided for your safety. If you are unable to insert this plug fully into the outlet, contact your electrician to replace your obsolete outlet.
- For a 2-prong plug (consists of one wide blade and one narrow blade), insert the plug into a polarized mains, 2-prong outlet in which one socket is wider than the other.

**Note:** If you are unable to insert this plug fully into the outlet, try reversing the plug. The wide blade is provided for your safety. If the plug still fails to fit, contact an electrician to replace your obsolete outlet.

### Overloading



#### **WARNING:**

**Avoid electric shock and fire hazard! Do not overload mains AC outlets and extension cords. For products that require battery power or other power sources to operate them, refer to the operating instructions for those products.**

Do not overload electrical outlets, extension cords, or integral convenience receptacles as this can result in a risk of fire or electric shock. For products that require battery power or other sources to operate, refer to the operating instructions for that product.

### Preventing Power Cord Damage

Protect the power cord from being walked on or pinched, particularly at plugs, convenience receptacles, and the point where they exit from the apparatus. Arrange all power cords so that pets cannot walk on or disturb the cords. Do not place objects on or lean objects against the cords, which can damage the cords.

### Handling Replaceable Battery Pack

This product contains replaceable battery pack. Heed the following warning and see the instructions later in this guide for handling, replacing, and disposing of the battery.



#### **WARNING:**

**There is danger of explosion if the battery is mishandled or incorrectly replaced. Replace only with the same type of battery. Do not disassemble it or attempt to recharge it outside the system. Do not crush, puncture, dispose of in fire, short the external contacts, or expose to water or other liquids. Dispose of the battery in accordance with local regulations and instructions from your service provider.**

## Usage Warnings

### Providing Ventilation

- Do not block any ventilation openings. Install in accordance with the manufacturer's instructions.
- Do not place this apparatus on a bed, sofa, rug, or similar surface.
- Do not install near any heat sources such as radiators, heat registers, stoves, or other apparatus (including amplifiers) that produce heat.
- Do not install this apparatus in an enclosure, such as a bookcase or rack, unless the installation provides proper ventilation.
- Do not place entertainment devices (such as VCRs or DVDs), lamps, books, vases with liquids, or other objects on top of this product.
- Do not use this apparatus near water.

## IMPORTANT SAFETY INFORMATION

### Selecting a Proper Location



**WARNING:**

**Avoid personal injury and damage to this product! An unstable surface may cause this product to fall.**

Place this product on a stable surface. The surface must support the size and weight of this product. Any mounting accessory used must be recommended by the manufacturer. The product should be mounted to a wall or ceiling only as recommended by the manufacturer.

**Important!** The power cord is the mains power supply disconnect device.

Place this product in a location that is close enough to an electrical outlet and where the power cord is easily accessible to be disconnected from the wall outlet or from the rear panel of the product.

### Cleaning This Product



**WARNING:**

**Avoid electric shock! Unplug this product before cleaning. Clean only with a dry cloth.**

Before cleaning this product, unplug it from the electrical outlet. Clean this product only with a dry cloth. Do not use a liquid cleaner or an aerosol cleaner. Do not use a magnetic/static cleaning device (dust remover) to clean this product.

### Protecting This Product from Foreign Objects and Water or Moisture Damage



**WARNING:**

**Avoid electric shock and fire hazard! Never push objects through the openings in this product. Foreign objects can cause electrical shorts that can result in electric shock or fire. Do not expose this product to rain or moisture. Do not place objects filled with liquid, such as vases, on this product.**

Never push objects of any kind into this product through openings as they may touch dangerous voltage points or short out parts that could result in a fire or electric shock.

Do not expose this product to liquids or moisture. Do not place this product on a wet surface. Do not spill liquids on or near this product.

Do not use this product near water (such as a bathtub, washbowl, sink, or laundry tub), in a wet basement, or near a swimming pool.

## Accessories Warnings



**WARNING:**

**Avoid any potential for electric shock or fire. Only use attachments/accessories specified by the manufacturer.**

Do not use accessories or attachments with this product unless recommended by your service provider or manufacturer.

## Service Warnings

### Servicing This Product

**WARNING:**

**Avoid electric shock! Opening or removing the cover may expose you to dangerous voltages. This product contains no user-serviceable parts. Refer all servicing to qualified service personnel.**

Do not open the cover of this product. If you open the cover, your warranty will be void. Refer all servicing to qualified personnel only. Contact your service provider for instructions.

### Obtaining Service for Product Damage

For damage that requires service, unplug this product from the AC outlet. Refer all servicing to your service provider or qualified service personnel. Servicing is required when:

- The apparatus has been damaged in any way
- A power-supply cord or plug is damaged
- Liquid has been spilled or objects have fallen into the apparatus
- The apparatus has been exposed to rain or moisture
- The apparatus does not operate normally
- The apparatus has been dropped

### Checking Product Safety

Upon completion of any service or repairs to this product, the service technician must perform safety checks to determine that this product is in proper operating condition.

### Lightning

For added protection, unplug this apparatus during lightning storms or when unused for long periods of time. In addition to disconnecting the AC power from the wall outlet, disconnect the signal inputs. This may prevent damage to the apparatus due to lightning and power-line surges. Plugging this apparatus into a surge protector may reduce the risk of damage.

20060712MDBR

## FCC Compliance

### United States FCC Compliance

This device has been tested and found to comply with the limits for a Class B digital device, pursuant to part 15 of the FCC Rules. These limits are designed to provide reasonable protection against such interference in a residential installation. This equipment generates, uses, and can radiate radio frequency energy. If not installed and used in accordance with the instructions, it may cause harmful interference to radio communications. However, there is no guarantee that interference will not occur in a particular installation. If this equipment does cause harmful interference to radio or television reception, which can be determined by turning the equipment OFF and ON, the user is encouraged to try to correct the interference by one or more of the following measures:

- Reorient or relocate the receiving antenna.
- Increase the separation between the equipment and receiver.
- Connect the equipment into an outlet on a circuit different from that to which the receiver is connected.
- Consult the cable company or an experienced radio/television technician for help.

Any changes or modifications not expressly approved by Scientific-Atlanta, Inc., could void the user's authority to operate the equipment.

The information shown in the FCC Declaration of Conformity paragraph below is a requirement of the FCC and is intended to supply you with information regarding the FCC approval of this device. *The phone numbers listed are for FCC-related questions only and not intended for questions regarding the connection or operation for this device. Please contact your cable service provider for any questions you may have regarding the operation or installation of this device.*

### FCC Declaration of Conformity

This device complies with Part 15 of FCC Rules. Operation is subject to the following two conditions: 1) the device may not cause harmful interference, and 2) the device must accept any interference received, including interference that may cause undesired operation.

VoIP Cable Modem  
DPX2203/EPX2203  
Scientific-Atlanta, Inc.  
5030 Sugarloaf Parkway  
Lawrenceville, Georgia 30044 USA  
Telephone: 770-236-1077

### Canada EMI Regulation

This Class B digital apparatus complies with Canadian ICES-003.

Cet appareil numérique de la class B est conforme à la norme NMB-003 du Canada.

20060628FDC



## Introduction

Welcome to the world of high-speed Internet and high-quality digital telephone service. Your new Model DPX2203 or Model EPX2203 Cable Modem with Embedded MTA is a modem that meets industry standards for high-speed data connectivity along with digital telephone service. The DPX2203 or EPX2203 offers the following outstanding features:

- Data Over Cable System Interface Specifications (DOCSIS) technology to deliver high-end performance and reliability
- 10/100BaseT Ethernet and USB ports to provide connectivity for high-speed data services or to other Internet devices
- Two RJ-11 telephony ports for connecting conventional telephones or fax machines

This guide provides procedures and recommendations for placing, installing, configuring, operating, and troubleshooting your DPX2203 or EPX2203 cable modem for high-speed Internet or digital telephone service, or both simultaneously. Refer to the appropriate section in this guide for the specific information you need for your situation. Contact your cable service provider for more information about subscribing to these services.

## What's In the Carton?

When you receive your DPX2203 or EPX2203, you should check the cable modem equipment and accessories to verify that each item is in the carton and that each item is undamaged. The carton contains the following items:



One Model DPX2203 or EPX2203  
VoIP Cable Modem



One power adapter with power  
cord



One Ethernet cable (CAT5/RJ-45)



One USB cable



One CD-ROM containing the  
user's guide and the USB drivers

If any of the items listed are missing or damaged, please contact your service provider for assistance.

### Notes:

- You will need an optional cable signal splitter and additional standard RF coaxial cables if you want to connect a VCR, a Digital Home Communications Terminal (DHCT) or a set-top converter, or a TV to the same cable connection as your cable modem.
- Cables and other equipment needed for telephone service must be purchased separately. Contact your service provider to inquire about the equipment and cables you need for telephone service.

## Front Panel Components

The following illustration shows the function of the front panel LED status indicators on the DPX2203 and EPX2203 and the optional battery pack.

**Note:** The model shown here is the DPX2203. The EPX2203 does not attach to a battery pack.

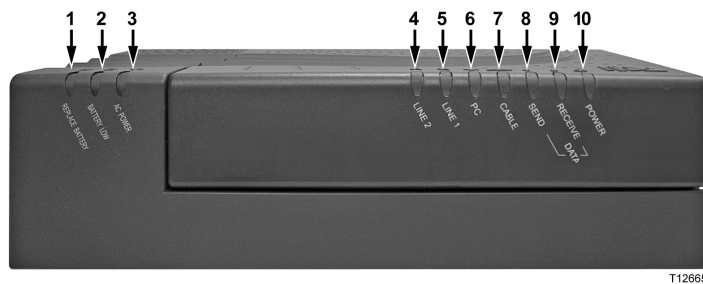

T12665

- 1 **REPLACE BATTERY** – Illuminates to indicate that the battery could not be fully charged. While the battery may be able to provide some backup power, it should be replaced to restore maximum capacity. Contact your cable service provider for instructions to replace and dispose of the old battery.
- 2 **BATTERY LOW** – Illuminates to indicate that approximately 20 percent of charge is remaining in the battery
- 3 **AC POWER** – Illuminates when the cable modem is operating on AC power. AC power must be available to recharge the battery
- 4 **LINE 2** – Illuminates solid green when the telephone line 2 is in use
- 5 **LINE 1** – Illuminates solid green when telephone line 1 is in use
- 6 **PC** – Illuminates solid green to indicate that an Ethernet/USB carrier is present. Blinks to indicate that Ethernet/USB data is being transferred between the PC and the cable modem
- 7 **CABLE** – Illuminates solid green when the modem is registered on the network and fully operational. This light blinks to indicate one of the following conditions:
  - Booting up and not ready for data
  - Scanning the network and attempting to register
  - Lost registration on the network and will continue blinking until it registers again
  - Blinks very slowly (once every 5 seconds) to indicate that Cable Modem Access Protection is enabled
- 8 **SEND** – Blinks to indicate that the modem is sending data to the cable network
- 9 **RECEIVE** – Blinks to indicate that the modem is receiving data from the cable network
- 10 **POWER** – Illuminates solid green to indicate that power is being applied to the cable modem

## Front Panel Components

### Notes:

- After the cable modem is successfully registered on the network, the **POWER** LED (LED 10) and the **CABLE** LED (LED 7) illuminate continuously to indicate that the cable modem is active and fully operational.
- If the optional battery pack is installed, the **POWER** LED (LED 10) and the **CABLE** LED (LED 7) blink periodically and the other lights go out to indicate that the modem is running on battery power.
- Operation without AC power: Most LEDs are disabled if the unit is operating on battery power. In this mode the **POWER** LED (LED 10) and **CABLE** LED (LED 7) blink periodically to indicate that the unit is operating under battery power but AC power has failed.

## Back Panel Components

The following illustration shows the description and function of the back panel components on the DPX2203 and EPX2203.

**Note:** The model shown here is the DPX2203. The EPX2203 does not attach to a battery pack.

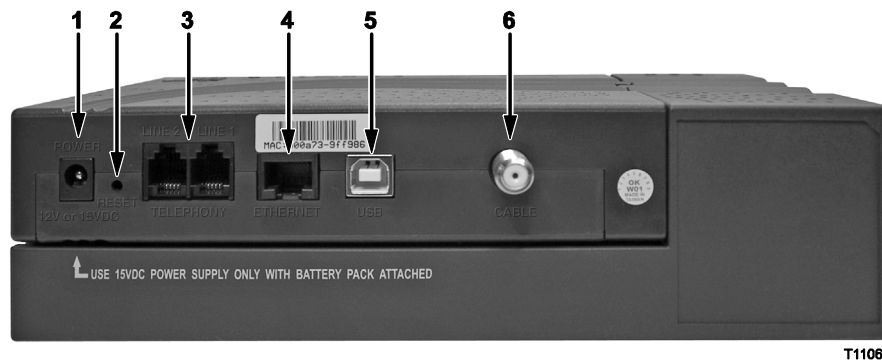

**Important!** Do not connect your PC to both the Ethernet and USB ports at the same time. Your modem will not function if both the Ethernet and USB ports are connected to your PC at the same time.

**Note:** You can connect two separate PCs to the cable modem at the same time by connecting one to the Ethernet port and one to the USB port. This dual-connection requires that you purchase two IP addresses from your ISP.

- 1 **POWER** – Connects the cable modem to the DC output of the AC power adapter that is provided with your cable modem



**CAUTION:**

Only use the power cord and the AC power adapter that are provided with your cable modem.

- 2 **RESET** – Reset-to-Default button (Factory Reset)



**CAUTION:**

This button is for maintenance purposes only. Do not use unless instructed to do so by your cable or telephone service provider! Doing so may cause you to lose any cable modem settings you have selected.

- 3 **LINE 1/LINE 2** – RJ-11 telephone ports connect to home telephone wiring to conventional telephones or fax machines. Port 1 can connect *both* Line 1 and Line 2. Port 2 connects only Line 2.
- 4 **ETHERNET** – RJ-45 Ethernet port connects to the Ethernet port on your PC
- 5 **USB** – 12 Mbps USB port connects to the USB port on your PC
- 6 **CABLE IN** – F-Connector connects to an active cable signal from your cable service provider

## Where Is the Best Location for My Cable Modem?

The ideal location for your cable modem is where it has access to outlets and other devices. Think about the layout of your home or office, and consult with your service provider to select the best location for your cable modem. Read this user's guide thoroughly before you decide where to place your cable modem.

Consider these recommendations:

- Position your PC and cable modem so that they are located near an AC power outlet.
- Position your PC and cable modem so that they are located near an existing cable input connection to eliminate the need for an additional cable outlet. There should be plenty of room to guide the cables away from the modem and the PC without straining or crimping them.
- Airflow around the cable modem should not be restricted.
- Choose a location that protects the cable modem from accidental disturbance or harm.

## What Are the System Requirements for Internet Service?

To ensure that your cable modem operates efficiently for high-speed Internet service, verify that all of the Internet devices on your system meet or exceed the following minimum hardware and software requirements.

**Note:** You will also need an active cable input line and an Internet connection.

### Minimum System Requirements for a PC

- A PC with a Pentium MMX 133 processor or greater
- 32 MB of RAM
- Web browsing software
- CD-ROM drive

### Minimum System Requirements for Macintosh

- MAC OS 7.5
- 32 MB of RAM

### System Requirements for an Ethernet Connection

- A PC with Microsoft Windows 95 operating system (or later) with TCP/IP protocol installed, or an Apple Macintosh computer with TCP/IP protocol installed
- An active 10/100BaseT Ethernet network interface card (NIC) installed

### System Requirements for a USB Connection

- A PC with Microsoft Windows 98SE, ME, 2000, or XP operating system
- A master USB port installed in your PC or your Apple Macintosh computer

## How Do I Set Up My High-Speed Internet Access Account?

Before you can use your cable modem, you need to have a high-speed Internet access account. If you do not have a high-speed Internet access account, you need to set up an account with your local service provider. Choose one of the two options in this section.

### I Do Not Have a High-Speed Internet Access Account

If you do *not* have a high-speed Internet access account, your service provider will set up your account and become your Internet Service Provider (ISP). Internet access enables you to send and receive e-mail, access the World Wide Web, and receive other Internet services.

You will need to give your service provider the following information:

- The serial number of the modem
- The Media Access Control (MAC) address of the modem

These numbers appear on a bar code label located on the cable modem. The serial number consists of a series of alphanumeric characters preceded by **S/N**. The MAC address consists of a series of alphanumeric characters preceded by **MAC**. The following illustration shows a sample bar code label.

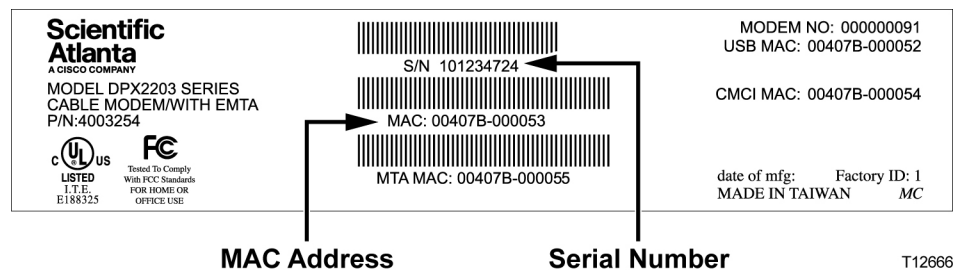

Write down these numbers in the space provided here.

Serial Number \_\_\_\_\_

MAC Address \_\_\_\_\_

### I Already Have an Existing High-Speed Internet Access Account

If you have an existing high-speed Internet access account, you must give your service provider the serial number and the MAC address of the cable modem. Refer to the serial number and MAC address information listed previously in this section.

**Note:** You may not be able to continue to use your existing e-mail account with your cable modem. Contact your service provider for more information.



## How Do I Connect My Devices to Use the Internet?

You can use your cable modem to access the Internet, and you can share that Internet connection with other Internet devices in your home or office. Sharing one connection among many devices is called networking.

### Connecting and Installing Internet Devices

You must connect and install your cable modem to access the Internet. Professional installation may be available. Contact your local cable service provider for further assistance.

#### To connect devices

The following diagram illustrates one of the various networking options that are available to you.

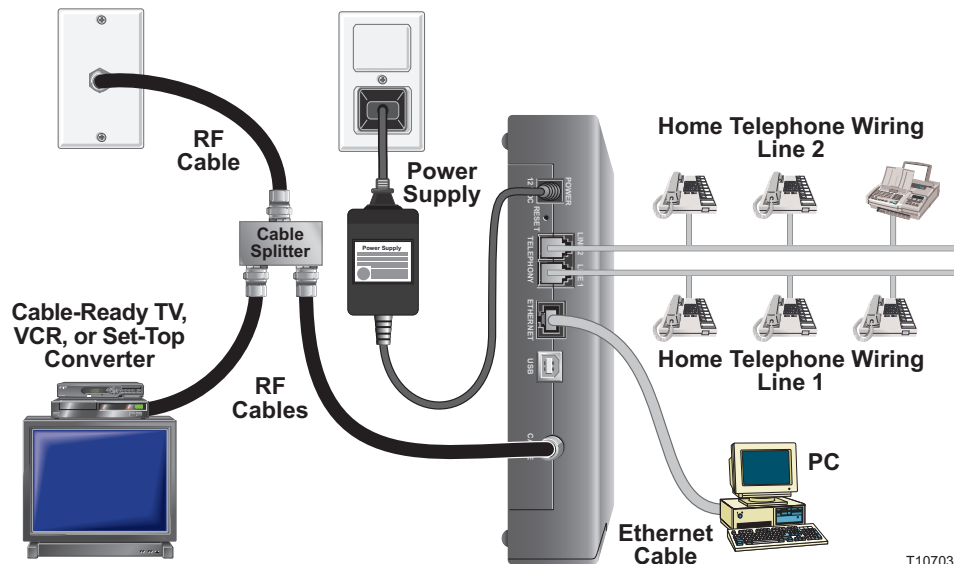

T10703

### Connecting the Modem for High-Speed Data Service



#### WARNING:

To avoid personal injury or damage to your equipment, follow these steps in the exact order shown.

- 1 Power off your PC and unplug it from the power source.
- 2 Connect your PC to either the **ETHERNET** port or the **USB** port using the appropriate data cable. Do not connect your PC to both the Ethernet and USB ports at the same time. You can connect two separate PCs to the cable modem at the same time by connecting one PC to the Ethernet port and one PC to the USB port.

## How Do I Connect My Devices to Use the Internet?

- 3 Connect the active RF coaxial cable to the **CABLE** connector. Use an optional cable signal splitter to add a TV, a DHCT or set-top converter, or a VCR.
- 4 Insert the AC power cord into the **POWER** connector on the back of the cable modem, and then plug the cord into an AC power source.
- 5 Plug in and power on your networked devices including your PC. The cable modem will then begin an automatic search to locate and sign on to the broadband data network. This process may take up to 5 minutes. The modem will be ready for use when the **ONLINE** LED status indicator on the front panel stops blinking and illuminates continuously.
- 6 The next step in setting up your cable modem is to configure your Internet devices for Internet access. Choose one of the following options:
  - If you want to use Ethernet connections, you must configure the TCP/IP protocol. To configure the TCP/IP protocol, go to *How Do I Configure TCP/IP Protocol?* (on page 19).
  - If you want to use USB connections, you must install the USB drivers. To install the USB Drivers for USB, go to *How Do I Install USB Drivers?* (on page 22).

## How Do I Configure TCP/IP Protocol?

To configure TCP/IP protocol, you need to have an Ethernet Network Interface Card (NIC) with TCP/IP communications protocol installed on your system. TCP/IP is a communications protocol used to access the Internet. This section contains instructions for configuring TCP/IP on your Internet devices to operate with the cable modem in Microsoft Windows or Macintosh environments.

### Configuring TCP/IP on Your Internet Devices

TCP/IP protocol in a Microsoft Windows environment is different for each operating system. Follow the appropriate instructions in this section for your operating system.

#### Configuring TCP/IP on Windows 95, 98, 98SE, or ME Systems

- 1 Click **Start**, select **Settings**, and choose **Control Panel**.
- 2 Double-click the **Network** icon in the Control Panel window.
- 3 Read the list of installed network components under the **Configuration** tab to verify that your PC contains the TCP/IP protocol/Ethernet adapter.
- 4 Is TCP/IP protocol listed in the installed network components list?
  - If **yes**, go to step 7.
  - If **no**, click **Add**, click **Protocol**, click **Add**, and then go to step 5.
- 5 Click **Microsoft** in the Manufacturers list.
- 6 Click **TCP/IP** in the Network Protocols list, and then click **OK**.
- 7 Click the **TCP/IP Ethernet Adapter** protocol, and then choose **Properties**.
- 8 Click the **IP Address** tab, and then select **Obtain an IP address automatically**.
- 9 Click the **Gateway** tab and verify that these fields are empty. If they are not empty, highlight and delete all information from the fields.
- 10 Click the **DNS Configuration** tab, and then select **Disable DNS**.
- 11 Click **OK**.
- 12 Click **OK** when the system finishes copying the files, and then close all networking windows.
- 13 Click **YES** to restart your computer when the System Settings Change dialog box opens. The computer restarts. The TCP/IP protocol is now configured on your PC, and your Ethernet devices are ready for use.
- 14 Try to access the Internet. If you cannot access the Internet, go to *Having Difficulty?* (on page 44). If you still cannot access the Internet, contact your service provider for further assistance.

## How Do I Configure TCP/IP Protocol?

### Configuring TCP/IP on Windows 2000 Systems

- 1 Click **Start**, select **Settings**, and choose **Network and Dial-up Connections**.
- 2 Double-click the **Local Area Connection** icon in the Network and Dial-up Connections window.
- 3 Click **Properties** in the Local Area Connection Status window.
- 4 Click **Internet Protocol (TCP/IP)** in the Local Area Connection Properties window, and then click **Properties**.
- 5 Select both **Obtain an IP address automatically** and **Obtain DNS server address automatically** in the Internet Protocol (TCP/IP) Properties window, and then click **OK**.
- 6 Click **Yes** to restart your computer when the Local Network window opens. The computer restarts. The TCP/IP protocol is now configured on your PC, and your Ethernet devices are ready for use.
- 7 Try to access the Internet. If you cannot access the Internet, go to *Having Difficulty?* (on page 44). If you still cannot access the Internet, contact your service provider for further assistance.

### Configuring TCP/IP on Windows XP Systems

- 1 Click **Start**, and depending on your Start menu setup, choose one of the following options:
  - If you are using the Windows XP Default Start Menu, select **Connect to**, choose **Show all connections**, and then go to step 2.
  - If you are using the Windows XP Classic Start Menu, select **Settings**, choose **Network Connections**, click **Local Area Connection**, and then go to step 3.
- 2 Double-click the **Local Area Connection** icon in the LAN or High-Speed Internet section of the Network Connections window.
- 3 Click **Properties** in the Local Area Connection Status window.
- 4 Click **Internet Protocol (TCP/IP)**, and then click **Properties** in the Local Area Connection Properties window.
- 5 Select both **Obtain an IP address automatically** and **Obtain DNS server address automatically** in the Internet Protocol (TCP/IP) Properties window, and then click **OK**.
- 6 Click **Yes** to restart your computer when the Local Network window opens. The computer restarts. The TCP/IP protocol is now configured on your PC, and your Ethernet devices are ready for use.
- 7 Try to access the Internet. If you cannot access the Internet, go to *Having Difficulty?* (on page 44). If you still cannot access the Internet, contact your service provider for further assistance.

### Configuring TCP/IP on Macintosh Systems

- 1 Click the **Apple** icon in the upper-left corner of the Finder. Scroll down to **Control Panels**, and then click **TCP/IP**.
- 2 Click **Edit** on the Finder at the top of the screen. Scroll down to the bottom of the menu, and then click **User Mode**.
- 3 Click **Advanced** in the User Mode window, and then click **OK**.
- 4 Click the Up/Down selector arrows located to the right of the Connect Via section of the TCP/IP window, and then click **Using DHCP Server**.
- 5 Click **Options** in the TCP/IP window, and then click **Active** in the TCP/IP Options window.  
**Note:** Make sure that the **Load only when needed option** is *unchecked*.
- 6 Verify that the **Use 802.3** option located in the upper-right corner of the TCP/IP window is unchecked. If there is a check mark in the option, uncheck the option, and then click **Info** in the lower-left corner.
- 7 Is there a Hardware Address listed in this window?
  - If **yes**, click **OK**. To close the TCP/IP Control Panel window, click **File**, and then scroll down to click **Close**. You have completed this procedure.
  - If **no**, you must power off your Macintosh.
- 8 With the power off, simultaneously press and hold down the **Command (Apple)**, **Option, P**, and **R** keys on your keyboard. Keeping those keys pressed down, power on your Macintosh but do not release these keys until you hear the Apple chime at least three times, then release the keys and let the computer restart.
- 9 When your computer fully reboots, repeat steps 1 through 7 to verify that all TCP/IP settings are correct. If your computer still does not have a Hardware Address, contact your authorized Apple dealer or Apple technical support center for further assistance.

## How Do I Install USB Drivers?

To install USB drivers, your PC must be equipped with a USB network interface and a Microsoft Windows 98SE, ME, 2000, or XP operating system. This section contains instructions for installing the USB drivers for the cable modem.

**Note:** If you are not using the USB interface, skip this section.

### Installing USB Drivers

The USB driver installation procedures are different for each operating system. Follow the appropriate instructions in this section for your operating system.

#### Installing USB Drivers on Windows 98SE and Windows ME Systems

- 1 Insert the **USB Cable Modem Driver Installation Disk** into the CD-ROM drive of your PC.
- 2 Wait until the **POWER** and **ONLINE** LED status indicators on the front panel of the cable modem illuminate solid green. The Add New Hardware Wizard window opens.
- 3 Click **Next** in the Add New Hardware Wizard window.
- 4 Select **Search for the best driver for your device (Recommended)** in the Add New Hardware Wizard window, and then click **Next**.
- 5 Select **CD-ROM drive** in the Add New Hardware Wizard window, and then click **Next**.
- 6 Select **The updated driver (Recommended)** in the Add New Hardware Wizard window, and then click **Next**.
- 7 Click **Next** in the Add New Hardware Wizard window. The Copying Files window opens. After 10 to 20 seconds have passed, the Add New Hardware Wizard window reopens.
- 8 Click **Finish**. The USB driver installation is complete.

#### Installing USB Drivers on Windows 2000 Systems

- 1 Insert the **USB Cable Modem Driver Installation Disk** into the CD-ROM drive of your PC.
- 2 Wait until the **POWER** and **ONLINE** LED status indicators on the front panel of the cable modem illuminate solid green.
- 3 Click **Next** in the Found New Hardware Wizard window.
- 4 Select **Search for a suitable driver for my device (recommended)** in the Found New Hardware Wizard window, and then click **Next**.
- 5 Select **CD-ROM drives** in the Found New Hardware Wizard window, and then click **Next**.

- 6 Click **Next** in the Found New Hardware Wizard window. The system searches for the driver file for your hardware device.
- 7 After the system finds the USB driver, the Digital Signature Not Found window opens and displays a confirmation message to continue the installation.
- 8 Click **Yes** to continue the installation. The Found New Hardware Wizard window reopens with a message that the installation is complete.
- 9 Click **Finish** to close the Found New Hardware Wizard window. The USB drivers are installed on your PC, and your USB devices are ready for use.
- 10 Try to access the Internet. If you cannot access the Internet, go to *Having Difficulty?* (on page 44). If you still cannot access the Internet, contact your service provider for further assistance.

### Installing USB Drivers on Windows XP Systems

- 1 Insert the **USB Cable Modem Driver Installation Disk** into the CD-ROM drive of your PC.
- 2 Wait until the **POWER** and **ONLINE** LED status indicators on the front panel of the cable modem illuminate solid green.
- 3 Select **Install from a list or specific location (Advanced)** in the Found New Hardware Wizard window, and then click **Next**.
- 4 Select **Search removable media (floppy, CD-ROM)** in the Found New Hardware Wizard window, and then click **Next**.
- 5 Click **Continue Anyway** in the Hardware Installation window to continue the installation. The Found New Hardware Wizard window reopens with a message that the installation has finished.
- 6 Click **Finish** to close the Found New Hardware Wizard window. The USB drivers are installed on your PC, and your USB devices are ready for use.
- 7 Try to access the Internet. If you cannot access the Internet, go to *Having Difficulty?* (on page 44). If you still cannot access the Internet, contact your service provider for further assistance.

## What Are the Requirements for Ethernet Network Devices?

### How Many Ethernet Network Devices Can I Connect?

The Scientific Atlanta cable modem can support several Ethernet network devices using external Ethernet hubs that must be purchased separately.

The theoretical maximum number of Ethernet network devices supported by the cable modem is 63. However, under normal circumstances, the number of devices connected should be a much lower number.

Contact your service provider for more information on the maximum number of Ethernet network devices to connect to your cable modem to maintain optimal network performance.

### What Are the Wiring Requirements for Ethernet Networking?

A number of factors can impact the practical limit of the network. Although the cable modem is designed to support several Ethernet network devices, it is important to view the characteristics of the entire network and not just each individual node.

The theoretical distance between two 10/100BaseT CAT-5 Ethernet hubs is 382 feet (100 meters). Contact your service provider or consult the documentation for your Ethernet network devices for more information.

**Note:** Scientific Atlanta recommends that you use CAT-5 Ethernet cables.

### Do I Need to Configure the TCP/IP Protocol on My Computer?

For you to use Ethernet network devices on your network, you must have the TCP/IP protocol properly configured on your PC. Refer to *How Do I Configure TCP/IP Protocol?* (on page 19), for detailed information on configuring the TCP/IP protocol.



## How Do I Select and Place Ethernet Network Devices?

You can use a large variety of Ethernet network devices with your cable modem. These include NIC cards, hubs, bridges, etc. Contact your service provider or consult the documentation for your Ethernet network devices for more information on configuring Ethernet network devices.

### Where Is the Best Location for My Ethernet Network Devices?

You should work with your service provider to choose the best location for your Ethernet network devices. Consider these recommendations:

- Location of two-way cable outlets
- Distance of the Ethernet network devices from the cable modem
- Location of computers and other equipment from AC power outlets
- Ease of running Ethernet cable to the Ethernet network devices

Now that you have selected a location for your Ethernet network devices, the next step is to place and connect your Ethernet network devices. Go to *How Do I Connect Ethernet Network Devices?* (on page 26).

## How Do I Connect Ethernet Network Devices?

### Connecting Ethernet Devices

You must connect your Ethernet devices for use with the cable modem. Professional installation may be available. Contact your local service provider for further assistance.

The following diagram illustrates one of the various Ethernet network connection options that are available to you.

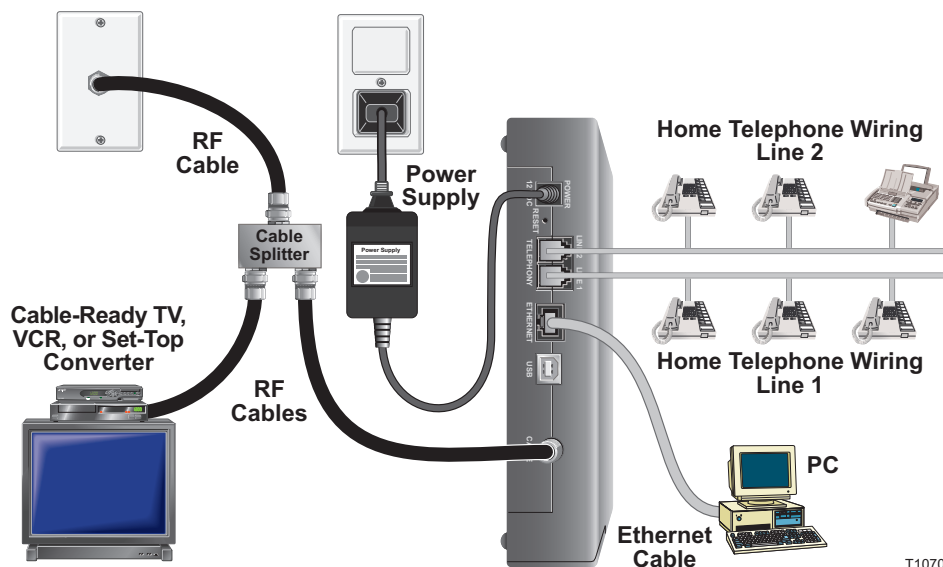

T10703



#### WARNING:

Hazardous electrical voltages can be present on any connected wiring. Ethernet wiring and connections must be properly insulated to prevent electrical shock. Disconnect power from the cable modem before attempting to connect to any device.

To avoid personal injury, follow the connection steps in the exact order shown.



#### CAUTION:

To prevent possible damage to the equipment, disconnect any other service before connecting your cable modem to other devices.

Read the warnings and caution on this page. Then, follow the installation procedures later in this guide to ensure proper cable modem operation when connecting Ethernet network devices.

- 1 Select locations for Ethernet network devices. For more information, see *How Do I Select and Place Ethernet Network Devices?* (on page 25).
- 2 Connect the Ethernet port on the cable modem to your PC.

## How Do I Connect Ethernet Network Devices?

- 3 Connect additional Ethernet network devices by connecting an Ethernet hub or router to the cable modem.
- 4 Connect the active RF coaxial cable to the **CABLE** connector on the back of the cable modem. Use an optional cable signal splitter to add a TV, a DHCT or set-top converter, or a VCR.
- 5 After all connections are complete, insert the AC power cord into the **POWER** connector on the back of the cable modem, and then plug the cord into an AC power source.
- 6 The cable modem begins an automatic search to locate and sign on to the network. In some unusual circumstances, this process may take up to 5 minutes. The cable modem is ready for use when the **ONLINE** status indicator on the front panel stops blinking and illuminates continuously.
- 7 Verify that all Ethernet network devices are working properly.

**Note:** You will not be able to check the front panel LED status indicator on the cable modem until after one or more Ethernet network devices are connected to the cable modem.

# How Do I Troubleshoot My Internet Service Installation?

## Troubleshooting for Internet Service

### I cannot connect to the Internet

- Verify that the plug to your cable modem AC power is properly inserted into an electrical outlet.
- Verify that your cable modem AC power cord is not plugged into an electrical outlet that is controlled by a wall switch. If a wall switch controls the electrical outlet, make sure the switch is in the **ON** position.
- Verify that the **POWER** and **CABLE** indicator lights on the front panel of your cable modem are illuminated.
- Verify that the indicator lights on your router or other network connection equipment are illuminated
- Verify that all cables are properly connected, and that you are using the correct cables.
- Verify that your cable service is active and that it supports two-way service.
- Verify that TCP/IP is properly installed and configured on all devices if you are using the Ethernet connections.
- Verify that you have followed the procedure in *How Do I Install USB Drivers?* (on page 22), if you are using the USB connection.
- Verify that you have called your service provider and given them the serial number and MAC address of your cable modem.
- If you are using a cable signal splitter so that you can connect the cable signal to other devices, remove the splitter and reconnect the cable so that the cable modem is connected directly to the main cable input. If the cable modem now functions properly, the cable signal splitter may be defective and may need to be replaced.

### My cable modem does not register an Ethernet connection

Even new devices do not always have Ethernet capabilities. Verify that your device has an Ethernet card and that the Ethernet driver software is properly installed. If you purchase and install an Ethernet card, follow the installation instructions very carefully.

### **My cable modem does not register a cable connection**

- The cable modem works with a standard, 75-ohm, RF coaxial cable. If you are using a different cable, your cable modem will not function properly. Contact your service provider to determine if you are using the correct cable.
- You may need to renew the IP address on your PC. Refer to *How Do I Renew the IP Address on My PC?* (on page 30), for instructions on how to renew the IP address for your particular operating system.
- Your USB interface may be malfunctioning. Refer to the troubleshooting information in your USB documentation.

## How Do I Renew the IP Address on My PC?

If your PC cannot access the Internet after the cable modem is online, it is possible that your PC did not renew its IP address. Follow the appropriate instructions in this section for your operating system to renew the IP address on your PC.

### Renewing the IP address on Windows 95, 98, 98SE, and ME Systems

- 1 Click **Start**, and then click **Run** to open the Run window.
- 2 Type **wiipcfg** in the Open field, and click **OK** to execute the winipcfg command. The IP Configuration window opens.
- 3 Click the down arrow to the right of the top field, and select the Ethernet adapter that is installed on your PC. The IP Configuration window displays the Ethernet adapter information.
- 4 Click **Release**, and then click **Renew**. The IP Configuration window displays a new IP address.
- 5 Click **OK** to close the IP Configuration window, you have completed this procedure.

**Note:** If you cannot access the Internet, contact your service provider for further assistance.

### Renewing the IP Address on Windows NT, 2000, or XP Systems

- 1 Click **Start**, and then click **Run**. The Run window opens.
- 2 Type **cmd** in the Open field and click **OK**. A window with a command prompt opens.
- 3 Type **ipconfig/release** at the C:/ prompt and press **Enter**. The system releases the IP address.
- 4 Type **ipconfig/renew** at the C:/ prompt and press **Enter**. The system displays a new IP address.
- 5 Click the **X** in the upper-right corner of the window to close the Command Prompt window. You have completed this procedure.

**Note:** If you cannot access the Internet, contact your service provider for further assistance.

## How Do I Use My Cable Modem for Telephone Service?

### Contacting Your Local Service Provider

You need to set up a telephone account with your local service provider to use your cable modem for telephone service. When you contact your service provider, verify the following conditions:

- Does the service to your home support two-way, DOCSIS-compatible cable modem access? If your service provider does not provide two-way service, this modem will not be able to communicate with your service provider's Internet access and telephone services.
- Can you transfer your existing telephone numbers from another telephony service provider to your current telephony service provider? In some areas, you may be able to transfer your existing telephone numbers, or your cable telephony service provider will assign a new telephone number for each current or additional active telephone line. Discuss these options with your telephony service provider.

You will need to give your service provider the following information:

- The serial number of the modem
- The Media Access Control (MAC) address of the modem

These numbers appear on a bar code label located on the cable modem. The serial number consists of a series of alphanumeric characters preceded by **S/N**. The MAC address consists of a series of alphanumeric characters preceded by **MAC**. The following illustration shows a sample bar code label.



Write down these numbers in the space provided here.

Serial Number \_\_\_\_\_

MAC Address \_\_\_\_\_

## Where Do I Place My Cable Modem for Telephone Service?

If you are planning to use your modem for telephone service, you should work with your cable telephony provider to choose the best location for your modem.

### Where Is the Best Location for My Modem?

When choosing a location for your modem, consider the following recommendations:

- Choose a location close to your computer if you will also use the cable modem for high-speed Internet service.
- Choose a location that is near an existing RF coaxial connection to eliminate the need for an additional RF coaxial outlet.
- Choose a location for the cable modem that is adjacent to your telephone equipment if you are using only one or two pieces of telephone equipment.  
**Note:** If you are using the cable modem to provide service to several telephones, a professional installer can connect the cable modem to your existing home telephone wiring. To minimize changes to the home telephone wiring, you may want to locate the cable modem near an existing telephone outlet. See *How Do I Install the Modem for Telephone Service?* (on page 34), for further instructions.
- Choose a location that is relatively protected from accidental disturbance or harm, such as a closet, basement, or other protected area.
- Choose a location so that there is plenty of room to guide the cables away from the modem without straining or crimping them.
- Airflow around the cable modem should not be restricted.
- Read this user's guide thoroughly before installing the cable modem.



## What Are the Requirements for Telephone Service?

This section provides hardware and software requirements for using your cable modem for telephone service.

### Number of Telephone Devices

The RJ-11 telephone-style connectors on the cable modem can each provide telephone service to multiple telephones, fax machines, and analog modems.

The maximum number of telephone devices connected to each RJ-11 port is limited by the total Ringing Load of the telephone devices that are connected. Many telephone devices are marked with a Ringer Equivalent Number (REN). Each telephone port on the cable modem can support up to a 5 REN load.

The sum of the REN load on all of the telephone devices attached to each port must not exceed 5 REN.

### Telephone Device Types

You can use telephone devices that are not labeled with a REN number, but the maximum number of attached telephone devices cannot be accurately calculated. With telephone devices that are not labeled, each device should be connected and the ring signal should be tested before adding more devices. If too many telephone devices are attached and the ring signal can no longer be heard, telephone devices should be removed until the ring signal works properly.

Telephones, fax machines, and other telephone devices should use the center 2 pins of the RJ-11 connectors to connect to the cable modem telephone ports. Some telephones use other pins on the RJ-11 connectors and require adapters in order to work.

### Dialing Requirements

All your telephones should be set to use DTMF dialing. Pulse dialing is typically not enabled by your local provider.

### Telephone Wiring Requirements

The cable modem supports interior telephone wiring. The maximum distance from the unit to the most distant telephone device must not exceed 1000 feet (300 meters). Use 26-gauge twisted-pair, or larger, telephone wiring.

**Important!** Connection to an existing or a new permanently installed home telephone wiring network must be done by a qualified installer.

## How Do I Install the Modem for Telephone Service?

The cable modem can be used to provide telephone service for one or two telephone lines. This section describes how to connect a single telephone, fax machine, analog telephone modem, or other telephone device to each telephone port on the cable modem.

**Important!** Connecting the cable modem permanently to the installed home telephone wiring is not covered by this document.

### Installing the Modem to Provide Telephone Service

Heed the following warnings, and then follow the subsequent installation procedures in this section to ensure proper cable modem installation and configuration for providing telephone service.



**WARNING:**

- To avoid personal injury, follow the installation instructions in the exact order shown.
- Telephone connections to an installed home telephone wiring network must be done by a qualified installer. The cable telephone service provider may offer professional installation and connection to the home telephone wiring network. A fee may be charged for this service.
- Hazardous electrical voltages can exist on the telephone ports on the cable modem and can be present on any connected wiring. Telephone wiring and connections must be properly insulated to prevent electrical shock. Disconnect power from the cable modem before attempting to connect to any device.
- To prevent possible damage to equipment, disconnect any other telephone service before connecting your cable modem to the same wires.

**Note:** Professional installation may be available. Contact your service provider for further assistance.

### Installation Diagram

The following diagram illustrates one of the various connection options that are available to you.

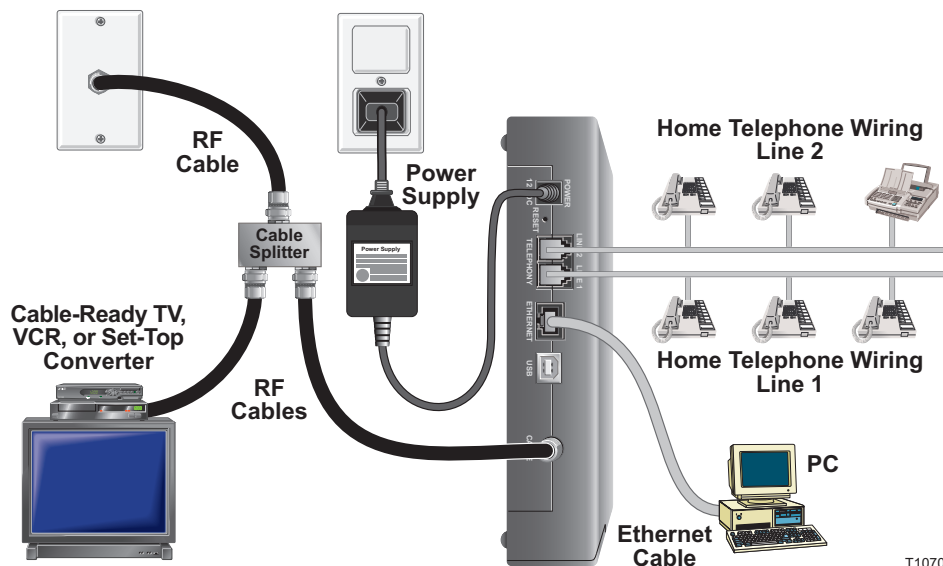

### To install the cable modem for telephone service

- 1 Connect a telephone, fax machine, or analog modem to each of the appropriate RJ-11 ports on the cable modem.

#### Notes:

- The cable modem provides one line of telephone service on each of the RJ-11 connectors.
  - Service must be set up and enabled by the telephone service provider.
  - The two center conductors (pins 3 and 4) on the RJ-11 connector provide electrical connections to directly attached telephone devices or to a permanently installed in-home telephone wiring network.
  - The telephone port labeled Line 1 also supports multi-line telephone devices. Line 1 is supported on pins 3 and 4, and Line 2 is supported on pins 2 and 5.
  - The use of telephones that require electrical connections to other RJ-11 pins requires an adapter.
- 2 After all telephone connections are complete, insert the AC power cord into the power connector on the back of the cable modem, and then plug the cord into an AC power source.

## How Do I Install the Modem for Telephone Service?

- 3 Connect the active RF coaxial cable to the **CABLE** connector on the back of the cable modem. The cable modem begins an automatic search to locate and sign on to the network that provides the telephone service. This process may take up to 5 minutes. The modem will be ready for use when the **CABLE** LED status indicator on the front panel stops blinking and illuminates continuously.  
**Note:** Use an optional cable signal splitter to add a TV, a DHCT or set-top converter, or a VCR.
- 4 Test your telephone service by lifting the receiver of each attached telephone to verify that the dial tone can be heard and that you can make and receive telephone calls. This process may take several minutes.

### Notes:

- The **TEL 1** and **TEL 2** LED status indicators on the front panel of the cable modem are OFF when the phone lines are not in use.
- The **TEL 1** or the **TEL 2** LED status indicators on the front panel of the cable modem illuminate continuously when the attached device is “off the hook.”

## Using the Battery Pack (Optional)

### Introduction

Your modem may include a rechargeable Lithium-Ion battery back to provide stand-by operation in the event of an AC power failure. You can replace the battery pack without the use of any tools.



#### WARNING:

There is danger of explosion if the battery is mishandled or incorrectly replaced. Replace only with the same type of battery. Do not disassemble it or attempt to recharge the battery outside the system. Do not crush, puncture, dispose of in a fire, short external contacts, or expose to water or other liquids. Dispose of the battery in accordance with local regulations and instructions from your service provider.

### Installing the Battery Pack

- 1 Disconnect all wires and cables and unplug the power supply from the modem.
- 2 To attach the modem to the battery pack, you must first remove the plastic foot located on the side edge of the modem. Rotate the foot on your modem counterclockwise to the second click.
- 3 Firmly lift the foot out of the hole on the bottom of the modem. The foot can be discarded or retained for future use.

**Important!** Be sure that the foot is aligned as shown before you try to remove it from the modem. Otherwise, you may break the prong on the modem foot.

- 4 On the right side of the battery pack is a slide-locking switch marked Lock and Unlock. Slide the switch to the **Unlock** position.

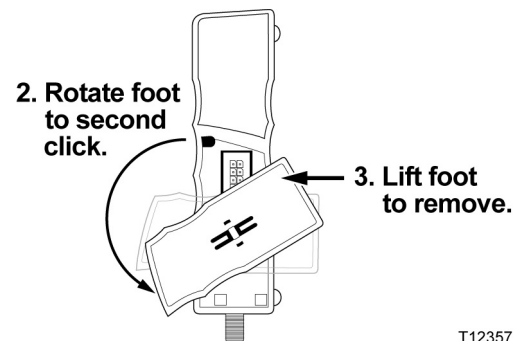

T12357

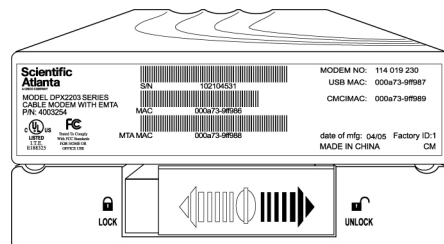

T12676

## Using the Battery Pack (Optional)

- Align the battery pack tabs with the corresponding slots on the bottom of the modem. Then, set the modem on the battery pack and carefully, but firmly, slide the modem into the battery pack connector.

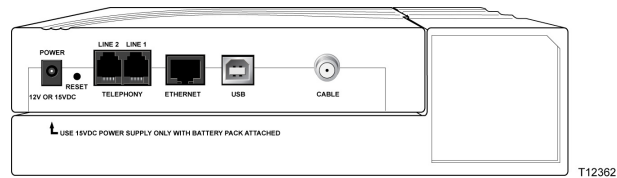
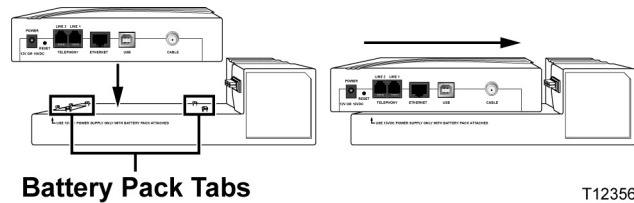

- Slide the switch to the **Lock** position. If it is difficult to slide the latch to the locked position, firmly slide the modem once again into the battery pack to fully seat the connector. Then slide the switch to the **Lock** position.

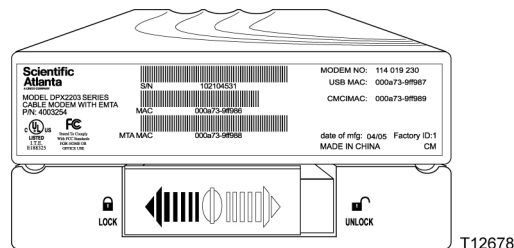
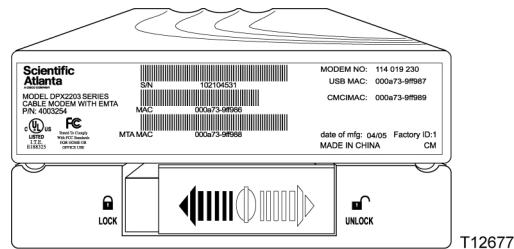

- Connect the 15 V DC power supply to the back panel of the modem, and then plug the power supply into an AC power outlet. The **AC POWER** LED status indicator illuminates.

## Charging the Battery Pack

The battery begins to charge automatically as soon as you attach the modem to the battery pack, connect the 15 V DC power supply to the back panel of the modem, and plug the power supply into an AC outlet. When you first plug in the modem, the **AC POWER** LED status indicator illuminates.

**Note:** It may take as much as 24 hours for the battery pack to charge fully.

## Replacing the Battery Pack

Under normal circumstances, the battery pack should last for several years. The **REPLACE BATTERY** indicator illuminates to indicate that the battery should be replaced soon. Contact your service provider to obtain a replacement battery and for disposal instructions.



### WARNING:

There is danger of explosion if the battery is mishandled or incorrectly replaced. Replace only with the same type of battery. Do not disassemble it or attempt to recharge the battery outside the system. Do not crush, puncture, dispose of in a fire, short external contacts, or expose to water or other liquids. Dispose of the battery in accordance with local regulations and instructions from your service provider.

## Using the Modem Without a Battery Pack

If you want, you can choose to use the modem without a battery pack. To remove the battery pack, follow these steps.

- 1 Slide the Lock/Unlock switch to the **Unlock** position.
- 2 Carefully but firmly slide the modem away from the battery pack.
- 3 Attach the modem foot to the modem by aligning the prong on the foot with the hole on the bottom of the modem. You can now use the foot to support the modem vertically, or you can install the modem horizontally.

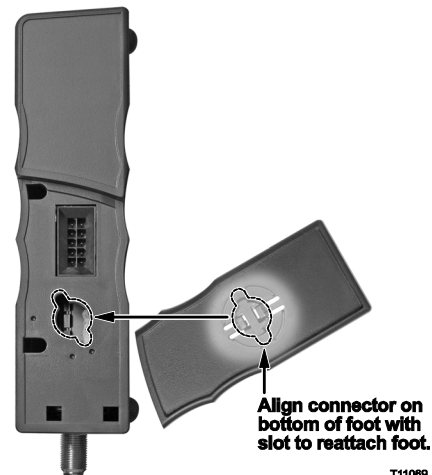

T11089

## Adding a Battery Pack

You may still be able to use a battery pack, even if one was not included with your modem. To determine if you can use a battery pack with your modem, look at the bottom of the modem. If your modem has a ten-pronged connector socket, you can add a battery pack to your modem.

**Note:** Contact your service provider to obtain the correct battery pack for your modem.

To add a battery pack to your modem, complete the procedure for *Installing the Battery Pack* (on page 37).

## Mount the Battery Pack on a Wall

### Before You Begin

Before you begin, choose an appropriate mounting place. The wall can be made of cement, wood, or drywall. The mounting location should be free of obstructions on all sides, and the cables should be able to easily reach the cable modem without strain. Leave sufficient clearance between the bottom of the cable modem, and any flooring or shelving underneath, to allow access to cabling. In addition, leave enough slack in all cables so that the cable modem can be removed for any required maintenance without disconnecting the cables. Also, verify that you have the following items:

- Two wall anchors for #8 x 1 inch screws
- Two #8 x 1 inch pan head sheet metal screws
- Drill with a 3/16-in. wood or masonry bit

**Note:** This section contains detailed wall-mounting instructions and a wall-mounting template.



## Mounting Illustrations

You can mount the optional battery pack for the DPX2203 on a wall using two wall anchors, two screws, and the mounting slots on the bottom of the unit. The modem can be mounted vertically or horizontally as shown in the following illustrations.

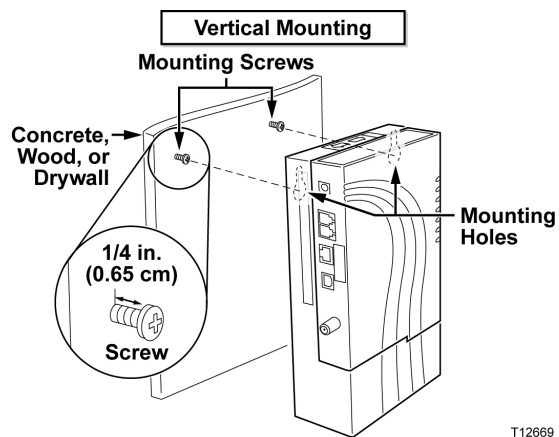

T12669

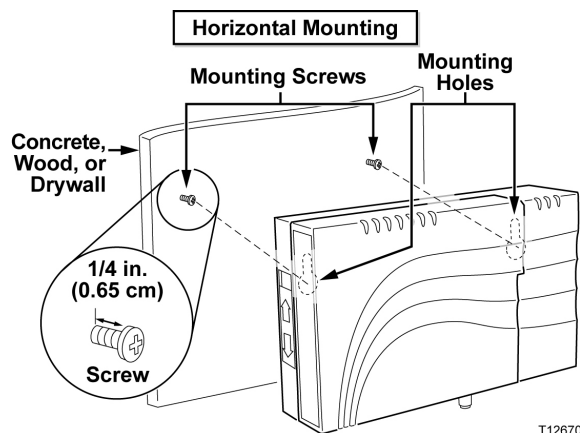

T12670

## Mount the Battery Pack on a Wall

### Using the Wall-Mounting Template

The following page shows the wall-mounting template. Copy this page and use that copy of the wall-mounting template to mark the mounting screw locations.

**Important!** Use the mounting slots labeled "A" on the template for vertical mounting, or use the mounting slots labeled "B" on the template for horizontal mounting.

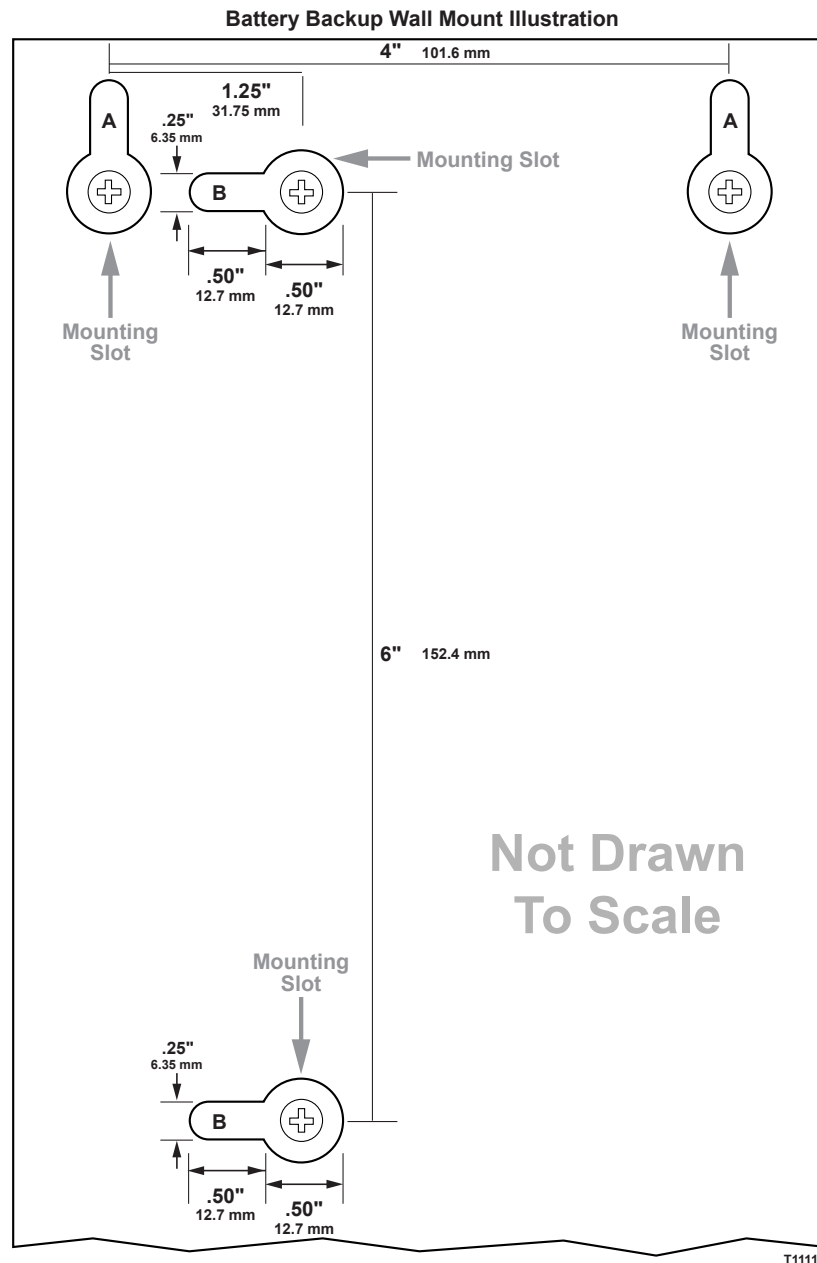

## Mounting the Battery Pack to the Wall

Complete these steps to mount the battery pack to the wall.

- 1 Using a drill with a 3/16-in. bit, drill two holes in the wall as follows:
  - To mount the cable modem vertically, drill the holes at the same height and 4 inches apart.
  - To mount the cable modem horizontally, drill the holes at the same height and 6 inches apart.
- Note:** The illustration on the previous page illustrates the location of the mounting holes on the back of the battery pack.
- 2 Are you mounting the battery pack into a drywall or concrete surface where a wooden stud is not available?
  - If **yes**, drive the anchor bolts into the wall, and install the mounting screws into the anchor bolts leaving a gap of about 1/4-in. between the screw head and the wall. Then, go to step 4.
  - If **no**, go to step 3.
- 3 Install the mounting screws into the wall leaving a gap of about 1/4-in. between the screw head and the wall.
- 4 Verify that no cables or wires are connected to the battery pack or to the cable modem.
- 5 Lift the cable modem into position. Slip the large end of both mounting slots (located in the back of the battery pack) over the mounting screws, then slide the battery pack down until the narrow end of the keyhole slot contacts the screw shaft.

**Important!** Verify that the mounting screws securely support the battery pack and modem before you release the unit.

## Having Difficulty?

### Common Troubleshooting Suggestions

#### The modem does not register a cable connection

The modem works with a standard, 75-ohm, RF coaxial cable. If you are using a different cable, your cable modem will not function properly. Contact your service provider to determine whether you are using the correct cable.

#### There is no dial tone when I lift the telephone handset

- Your telephone wiring may be connected to the wrong RJ-11 port on the cable modem. The cable modem has two telephone ports. Verify that you are connected to the correct telephone port.
- There may be a problem with your telephone set. Use a different telephone set and listen to hear dial tone.
- There may be a problem with your home telephone wiring. Use a telephone and connect directly to the same RJ-11 port on the back of the unit. If the dial tone is working here but does not work at other locations in the home, a professional may need to diagnose and repair a problem with your telephone wiring.
- Verify that the phone company has removed the previous telephone service from your home telephone wiring.
- Your telephone service may not be enabled from your cable telephony service provider. Contact your cable telephony service provider for more information.

### Frequently Asked Questions

#### Q. What if I don't subscribe to cable TV?

A. If cable TV is available in your area, data service may be made available with or without subscribing to cable TV service. Contact your local cable service provider for complete information on cable services, including high-speed Internet access.

#### Q. How do I arrange for installation?

A. Call your cable telephony service provider to inquire about professional installation. A professional installation ensures proper cable connection to the modem and to your PC, and it ensures the proper configuration of all hardware and software settings. Contact your cable telephony service provider for more information about installation.

**Q. How does the cable modem connect to my computer?**

A. The cable modem connects to the USB port or the 10/100BaseT Ethernet port on your PC. If your PC is not equipped with an Ethernet interface, an Ethernet card is available from your local PC or office supply retailer, or from your cable service provider.

**Q. After my cable modem is connected, how do I access the Internet?**

A. Your local service provider becomes your Internet Service Provider (ISP). They offer a wide range of services including e-mail, chat, news, and information services. Your cable service provider will provide the software you will need.

**Q. Can I watch TV and surf the Internet at the same time?**

A. Absolutely! If you subscribe to cable television service, you can watch TV and use your cable modem at the same time by connecting your TV and your cable modem to the cable network using an optional cable signal splitter.

**Q. Can I run more than one device on the modem?**

A. Yes. A single cable modem will theoretically support up to 253 Ethernet devices utilizing user-supplied Ethernet hubs or routers that you can purchase at your local PC or office supply retailer. Another user at your location can simultaneously connect to the USB port on the cable modem. Contact your service provider for further assistance.

## Common Troubleshooting Issues

### I don't understand the front panel status indicators

See Front Panel LED Status Indicator Functions, for more detailed information on front panel LED status indicator operation and function.

### The modem does not register an Ethernet connection

- Verify that your computer has an Ethernet card and that the Ethernet driver software is properly installed. If you purchase and install an Ethernet card, follow the installation instructions very carefully.
- Verify the status of the front panel LED status indicators.

### The modem does not register an Ethernet connection after connecting to a hub

If you are connecting multiple PCs to the cable modem, you should first connect the modem to the uplink port of the hub using the correct crossover cable. The LINK LED of the hub will illuminate continuously.

## Having Difficulty?

### **The modem does not register a cable connection**

- The modem works with a standard 75-ohm RF coaxial cable. If you are using a different cable, your cable modem will not function properly. Contact your cable service provider to determine whether you are using the correct cable.
- Verify that you have followed the procedures in *How Do I Troubleshoot My Internet Service Installation?* (on page 28).
- Your NIC card or USB interface may be malfunctioning. Refer to the troubleshooting information in the NIC or USB documentation provided with the device.

## Front Panel LED Status Indicator Functions

### Initial Power Up, Calibration, and Registration

The following chart illustrates the sequence of steps and the corresponding appearance of the front panel lights on the cable modem during power up, calibration, and registration on the network. Use this chart to troubleshoot the power up, calibration, and registration process of your cable modem.

**Note:** After the cable modem completes step 8 (Registration Completed), the modem proceeds immediately to Normal Operations.

Front Panel LED Status Indicators During Initial Power Up, Calibration, and Registration									
Step		1	2	3	4	5	6	7	8
Front Panel Indicator		Power Up	Self Test	Downstream Scan	Downstream Signal Lock	Ranging	Requesting IP Address	Registering	Registration Complete
4 <sup>1</sup>	Line 2	Off	On	Off	Off	Off	Off	Off	Off
5	Line 1	Off	On	Off	Off	Off	Off	Off	Off
6	PC <sup>2</sup>	Off	On	Off, On or Blinking	Off, On or Blinking	Off, On or Blinking	Off, On or Blinking	Off, On or Blinking	Off or On
7	Cable	Off	On	Slow Blinking 1 Blink	Momentary On	Off	Blinking 2 Blinks	Blinking 4 Blinks	On
8	Send	Off	On	Off	Off	Occasional Blinking	Occasional Blinking	Occasional Blinking	On
9	Receive	Off	On	Off	Off	Occasional Blinking	Occasional Blinking	Occasional Blinking	On
10	Power	On	On	On	On	On	On	On	On

<sup>1</sup>LEDs number 1, 2, and 3 (Replace Battery, Battery Low, and AC Power) are part of the optional battery pack and are not affected by the power up, calibration, and registration process.

<sup>2</sup>The PC light is on whenever a PC is connected to the modem, and it blinks to indicate that data is being transferred. If the modem is used to provide telephone service only and is not connected to a PC, the PC light is off.

## Normal Operations

The following chart illustrates the appearance of the front panel LED status indicators on the cable modem during normal operations.

Front Panel LED Status Indicators During Normal Operations		
Front Panel Indicator	Normal Operations	
4 <sup>1</sup>	Line 2	On when line 2 is in use
5	Line 1	On when line 1 is in use
6	PC	<p>On - When a single device is connected to either the Ethernet or USB port and no data is being sent to or from the modem</p> <p>Blinks - When only one Ethernet or USB device is connected and data is being transferred between the consumer premise equipment (CPE) and the cable modem</p> <p>Off - When no devices are connected to either the Ethernet or USB ports</p> <p><b>Note:</b> With both Ethernet and USB devices connected to the modem at the same time, when data is being transferred through only one of the devices (Ethernet or USB), the light illuminates continuously. Whenever data is being sent through both data ports (Ethernet and USB) simultaneously, the light blinks as described above.</p>
7	Cable	On
8	Send	Blinks - To indicate that the modem is sending data to the network
9	Receive	Blinks - To indicate that the modem is receiving data from the network
10	Power	On
<sup>1</sup> Lights number 1, 2, and 3 (Replace Battery, Battery Low, and AC Power) are part of the optional battery pack and are not affected by the operations of the modem.		



## Special Conditions

The following chart describes the appearance of the front panel lights on the cable modem during special conditions to show that you have been denied network access.

**Note:** If the front panel lights on the cable modem indicate that network access is denied, contact your cable service provider.

Front Panel LED Status Indicators During Special Conditions		
Front Panel Indicator		Network access Denied
4 <sup>1</sup>	Line 2	Off
5	Line 1	Off
6	PC	Slow Blinking 1 time per second
7	Cable	Slow Blinking 1 time per second
8	Send	Slow Blinking 1 time per second
9	Receive	Slow Blinking 1 time per second
10	Power	Slow Blinking 1 time per second
<sup>1</sup> Indicators number 1, 2, and 3 (Replace Battery, Battery Low, and AC Power) are part of the optional battery pack and are not affected when network access is denied.		

## Notices

### Trademarks

Scientific Atlanta is a registered trademark of Scientific-Atlanta, Inc.

DPX2203 and EPX2203 are trademarks of Scientific-Atlanta, Inc.

Cisco, Cisco Systems, and the Cisco Systems logo are registered trademarks of Cisco Systems, Inc. and/or its affiliates in the U.S. and certain other countries.

DOCSIS is a registered trademarks of Cable Television Laboratories, Inc.

PacketCable is a trademark of Cable Television Laboratories, Inc.

Other trademarks listed herein are the property of their respective owners.

### Disclaimer

Scientific-Atlanta, Inc. assumes no responsibility for errors or omissions that may appear in this guide. Scientific-Atlanta, Inc. reserves the right to change this guide at any time without notice.

### Documentation Copyright Notice

© 2006 Scientific-Atlanta, Inc. All rights reserved.

Printed in the United States of America.

Information in this document is subject to change without notice. No part of this document may be reproduced in any form without the express written permission of Scientific-Atlanta, Inc.

### Software Use Notice

The software described in this document is copyrighted and furnished to you under a license agreement. You may only use or copy this software in accordance with the terms of your license agreement.

### Firmware Use Notice

The firmware in this equipment is copyrighted. You may only use the firmware in the equipment in which it is provided. Any reproduction or distribution of this firmware, or any portion of it, without express written consent is prohibited.



**Scientific  
Atlanta**  
A CISCO COMPANY

Scientific Atlanta, A Cisco Company  
5030 Sugarloaf Parkway, Box 465447  
Lawrenceville, GA 30042

770.236.5000  
[www.scientificatlanta.com](http://www.scientificatlanta.com)

This document includes various trademarks of Scientific-Atlanta, Inc. Please see the Notices section of this document for a list of the Scientific-Atlanta, Inc. trademarks used in this document.

*All other trademarks shown are trademarks of their respective owners.*

Product and service availability subject to change without notice.

© 2006 Scientific-Atlanta, Inc. All rights reserved.  
August 2006

Printed in United States of America  
Part Number 4004041 Rev C

## Free Manuals Download Website

<http://myh66.com>

<http://usermanuals.us>

<http://www.somanuals.com>

<http://www.4manuals.cc>

<http://www.manual-lib.com>

<http://www.404manual.com>

<http://www.luxmanual.com>

<http://aubethermostatmanual.com>

Golf course search by state

<http://golfingnear.com>

Email search by domain

<http://emailbydomain.com>

Auto manuals search

<http://auto.somanuals.com>

TV manuals search

<http://tv.somanuals.com>