

**SAMSUNG TECHWIN**

**SAMSUNG**

**SALES NETWORK**

**SAMSUNG TECHWIN CO., LTD.**

145-3, Sangdaewon-dong, Jungwon-gu, Seongnam-si, Gyeonggi-do, 462-120, Korea  
TEL : +82-31-740-8151-8158 FAX : +82-31-740-8145

**SAMSUNG OPTO-ELECTRONICS UK, LTD.**

Samsung House, 1000 Hillwood Drive, Hillwood Business Park Chertsey, Surrey KT16 0PS  
TEL : +44-1932-45-5308 FAX : +44-1932-45-5325

[www.samsungtechwin.com](http://www.samsungtechwin.com)  
[www.samsungcctv.com](http://www.samsungcctv.com)

P/No. : Z6806-0836-01C  
VAN 08 05

Download from [www.Somanuals.com](http://www.Somanuals.com). All Manuals Search And Download.

**SAMSUNG**

**Compact**

10X Zoom, Pan & Tilt



**10X Day & Night PTZ Dome Camera SPD-1000 User's Manual**

Thank you for purchasing a SAMSUNG CCD CAMERA.  
Before attempting to connect or operate this product,  
please read these instructions carefully and save this manual for future use.

**ENGLISH**



The lightning flash with an arrowhead symbol, within an equilateral triangle is intended to alert the user to the presence of uninsulated “dangerous voltage” within the product’s enclosure that may be of sufficient magnitude to constitute a risk of electric shock to persons.



The exclamation point within an equilateral triangle is intended to alert the user to the presence of important operating and maintenance (servicing) instructions in the literature accompanying the appliance.

**INFORMATION** - This equipment has been tested and found to comply with limits for a Class A digital device, pursuant to part 15 of the FCC Rules. These limits are designed to provide reasonable protection against harmful interference when the equipment is operated in a commercial environment. This equipment generates, uses, and can radiate radio frequency energy and, if not installed and used in accordance with the instruction manual, may cause harmful interference to radio communications.

Operation of this equipment in a residential area is likely to cause harmful interference in which case the user will be required to correct the interference at his own expense.

**WARNING** - Changes or modifications not expressly approved by the manufacturer could void the user’s authority to operate the equipment.

**CAUTION** : To prevent electric shock and risk of fire hazards:

- ◆ Do NOT use power sources other than that specified.
- ◆ Do NOT expose this appliance to rain or moisture.

This installation should be made by a qualified service person and should conform to all local codes.

## Features

### 10X Zoom Lens with Auto-Focus Function

The 10X zoom lens having Auto-focus function magnifies the image up to 100 times when used with the digital 10X zoom function.

### Various Auto Surveillances

\*Individual Preset Saving Modes  
12 camera adjustment functions can be saved independently in each Preset menu to provide optimum images.

\*Various Protocols  
9 different makers protocols are supported: Samsung Techwin, Pelco, Samsung Electronics, Panasonic, Vicon and Honeywell etc.

\*PTZ Trace  
4 patterns operated with the joystick can be saved and replayed by users.

\*AUTO Swing  
Pan or Tilt is operated in sequence between 2 designated positions.

\*Group Search  
Maximum 128 Preset positions are toured in order.

\*Tour Search  
Maximum 6 Group Search functions are toured in order.

### Proportional P/T

Even when the Zoom-In function is On for the Pan and Tilt speed correction function linked to the zoom position, fine manual operation is possible.

### Day & Night

Day & Night function of ICR (IR Cut-Filter Removal) and Sens-Up function can achieve optimum images during day and night.

\*Sens-Up function improves the CCD sensitivity by lengthening the exposure time using electricity.

\*Day&Night function enables users to select and adjust the colour and black and white images according to the light level.

### OSD (On Screen Display)

Items such as Camera ID, Camera Name, Preset Number, Preset Name, Area Name and Camera Status are displayed on the monitor. Camera functions can be set up on the OSD menu screen.

### 128 Preset Positions

A maximum of 128 Preset positions can be set up. This function enables users to set up the monitoring place any time.

### Digital Flip

When you want to monitor the moving object below the camera, you can execute the Digital Flip using the controller's joystick. The moving object can be monitored without screen reverse.

### Area Masking

For privacy protection, a maximum of 4 areas can be masked among the surveillance areas preventing them to be displayed on the screen.



Samsung Techwin cares for the environment at all product manufacturing stages to preserve the environment, and is taking a number of steps to provide customers with more environment-friendly products. The Eco mark represents Samsung Techwin's will to create environment-friendly products, and indicates that the product satisfies the EU RoHS Directive.

## Warnings & Cautions

This information is provided to ensure your safety and to prevent any losses, financial or otherwise. Please read it carefully and use the product accordingly.

- \* For product inquiries, please contact the retail shop where you bought the camera. The use of equipment such as an aerial ladder while providing after-sales service shall be at your expense.
- \* Disconnect the power cord temporarily during a thunderstorm or in case of lightning, in order to prevent fire or damage to the product.
- \* This product is auxiliary equipment for a surveillance system and the company shall not be held liable for any damage to property or injury caused by theft, fire or act of god.

### Warning/Attention/Special Mark Messages

	Ignoring this information may result in death or serious personal injuries.		Ignoring this information may result in material loss or personal injuries.
	Indicates "Never Allowed."		Indicates "No Disassembling."



### Correct Disposal of This Product (Waste Electrical & Electronic Equipment)

(Applicable in the European Union and other European countries with separate collection systems)

This marking shown on the product or its literature, indicates that it should not be disposed with other household wastes at the end of its working life. To prevent possible harm to the environment or human health from uncontrolled waste disposal, please separate this from other types of wastes and recycle it responsibly to promote the sustainable reuse of material resources.

Household users should contact either the retailer where they purchased this product, or their local government office, for details of where and how they can take this item for environmentally safe recycling.

Business users should contact their supplier and check the terms and conditions of the purchase contract. This product should not be mixed with other commercial wastes for disposal.

# Contents

<b>Precautions</b> .....	8	<b>Functional Description</b> .....	31
<b>Part Names and Functions</b> .....	10	■ OSD Menu Organization .....	31
■ Body .....	10	■ PTZ Camera User Menu Settings .....	34
■ Main Body Port Block .....	10	1. Camera Settings .....	34
■ Cable Connection .....	11	2. Sequence Setting .....	42
■ Camera Initial Setting .....	12	3. P/T Setting .....	47
<b>Components and Accessories</b> .....	22	4. OSD Setting .....	50
<b>Installation</b> .....	23	5. Alarm Setting .....	54
		6. Initialize .....	56
		7. Status .....	57
		<b>Product Structure and Installation</b> .....	58
		<b>Specifications</b> .....	61

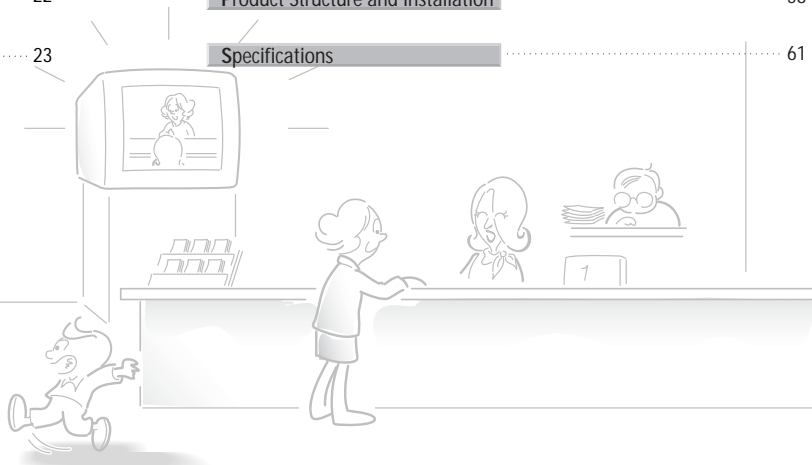

## Precautions

**Installation by unqualified persons is not recommended.**



Experienced and skilled technicians have to install this product. Unqualified and personal installation may cause fire or electric shock. Contact the dealer for installation.

**If any unusual odors or smoke comes from the camera, stop using the product.**

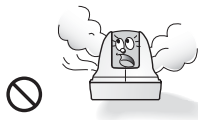

It may cause fire.

**Do not install the product in too hot or too cold environments.**



Do not use the camera under extreme temperatures (below -10° or above +50°). It may cause poor image quality or failure. Be especially careful to provide ventilation when operating the camera under high temperatures.

**Do not install the camera in intermittent lighting environments.**

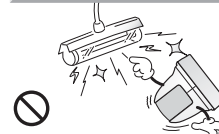

Do not install the camera under severely changing lighting environments such as fluorescent lamps. It may cause the camera to work improperly.

**Do not install the product under humid conditions or near flammable or explosive gases.**



It may cause failure, electric shock or fire.

**Install the product in a place strong enough to hold it.**



The product may fall.

**Never drop the camera or subject it to severe shocks or vibrations.**

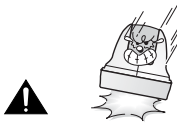

It may cause failure.

**Do not aim the camera at the sun or any other strong light source.**



It may cause fatal damage to CCD device or internal circuit.

**Do not handle the power plug with wet hands.**

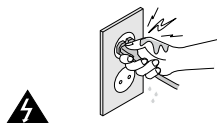

It may cause electric shock.

**Do not disassemble or insert foreign objects.**



It may cause failure or electric shock.

**Do not touch the front glass of the camera.**

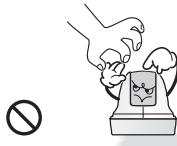

It is the most important part of camera. Be careful not to mark it with fingerprints.

**Do not install the camera where it might be exposed to rain, water or spillages.**



If the camera gets wet, it may cause failure.

# Part Names and Functions

## Body

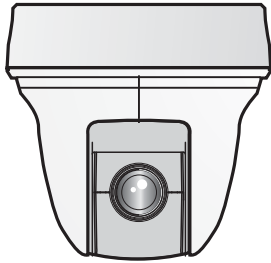

## Main Body Port Block (Rear panel)

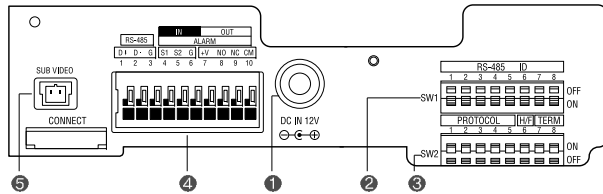

- ① Power Input Jack
- ② Camera ID Setting Switch
- ③ Communication Protocols, Transmission Mode, Termination Setting Switch
- ④ Controller and Alarm Input/Output Connection Terminal
- ⑤ Auxiliary Video Terminal

## Cable Connection

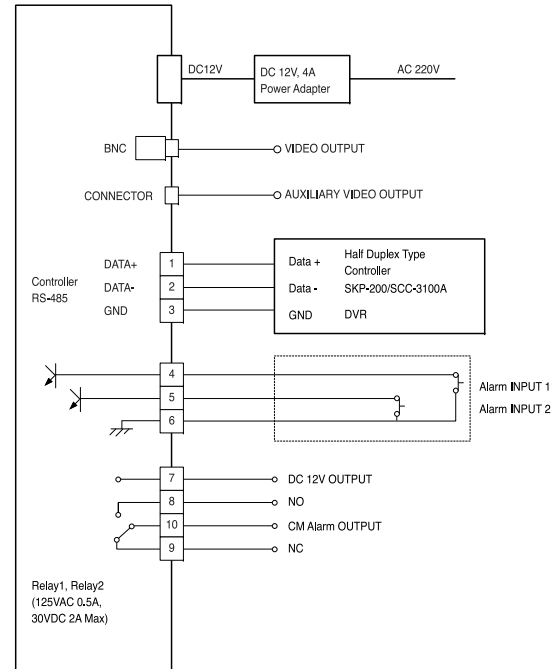

# Part Names and Functions

## Camera Initial Settings

### Setting Communications Protocol

Use the SW2 #1~#5 of installation bracket to set the communications protocol.

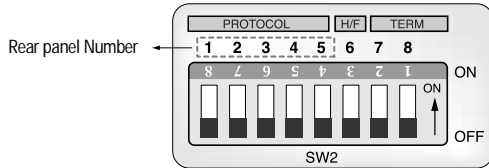

Protocol	Baud Rate(BPS)	SW2-#1	SW2-#2	SW2-#3	SW2-#4	SW2-#5
Samsung	9,600	OFF	OFF	OFF	OFF	OFF
Samsung	19,200	OFF	OFF	OFF	OFF	ON
Pelco-D	2,400	OFF	OFF	OFF	ON	OFF
Pelco-D	4,800	OFF	OFF	OFF	ON	ON
Pelco-P	4,800	OFF	OFF	ON	OFF	OFF
Pelco-P	9,600	OFF	OFF	ON	OFF	ON
Samsung Elec.	9,600	OFF	OFF	ON	ON	OFF
Samsung Elec.	19,200	OFF	OFF	ON	ON	ON
Panasonic	9,600	OFF	ON	OFF	OFF	OFF
Panasonic	19,200	OFF	ON	OFF	OFF	ON
Vicon	4,800	OFF	ON	OFF	ON	OFF
Vicon	9,600	OFF	ON	OFF	ON	ON
AD	4,800	OFF	ON	ON	OFF	OFF
Bosch	9,600	OFF	ON	ON	OFF	ON
Bosch	19,200	OFF	ON	ON	ON	OFF
Honeywell	9,600	OFF	ON	ON	ON	ON
Honeywell	19,200	ON	OFF	OFF	OFF	OFF
SUNGLIN	4,800	ON	OFF	OFF	OFF	ON
Pelco-D	9,600	ON	OFF	OFF	ON	OFF
Reserved						

### Notes

- Default Setting : Samsung 9,600 bps
- When you set up, refer to rear panel number(Ignore, DIP SWITCH number).
- Please see our homepage for details on the protocol

### Setting Baud Rate Based on DVR Model

If the speed dome camera is controlled not by the camera controller but by a DVR, set the communication speed based on the DVR model as follows.

Protocol DVR Model	Samsung	Pelco	Samsung Elec.
SVR-950	9600,19200	2400,4800	19,200
SVR-1640	9600,19200	2400,4800	19,200
SVR-1650	9600,19200	2400,4800	19,200

### Setting Transmission Mode

Set the transmission mode using the ON/OFF of the Rear Panel SW2.

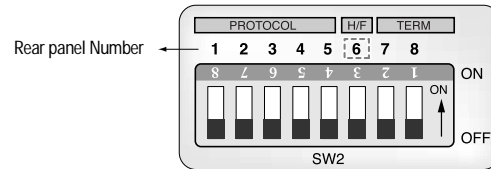

SW2- #6	Function	ON	OFF
	Transmission Mode Selection	Full (DVR)	Half (SCC-3100A)

### Notes

- Factory Setting: OFF
- When you set up, refer to rear panel number(Ignore, DIP SWITCH number).

# Part Names and Functions

## Setting RS-485 Termination

Set the termination using the ON/OFF of #7~#8 of the Rear Panel SW2.

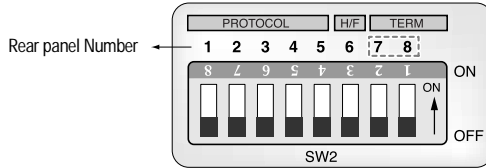

Location of Camera Connection	SW2 - #7	SW2 - #8
Termination of Longest Path	ON	ON
On the Path	OFF	OFF

### Notes

- Factory Setting: OFF
- When you set up, refer to rear panel number (Ignore, DIP SWITCH number).

## Setting Camera ID Switch

Set the Camera ID using the ON/OFF of #1~#8 of the Rear Panel SW1.

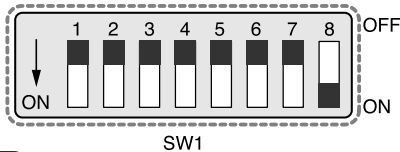

### Notes

- Factory Setting: ID=001
- ID=0, 160, 175 is cannot be used.

Camera ID	SW1-#1	SW1-#2	SW1-#3	SW1-#4	SW1-#5	SW1-#6	SW1-#7	SW1-#8
0	OFF	OFF	OFF	OFF	OFF	OFF	OFF	OFF
1	OFF	OFF	OFF	OFF	OFF	OFF	OFF	ON
2	OFF	OFF	OFF	OFF	OFF	OFF	ON	OFF
3	OFF	OFF	OFF	OFF	OFF	OFF	ON	ON
4	OFF	OFF	OFF	OFF	OFF	ON	OFF	OFF
5	OFF	OFF	OFF	OFF	OFF	ON	OFF	ON
6	OFF	OFF	OFF	OFF	OFF	ON	ON	OFF
7	OFF	OFF	OFF	OFF	OFF	ON	ON	ON
8	OFF	OFF	OFF	OFF	ON	OFF	OFF	OFF
9	OFF	OFF	OFF	OFF	ON	OFF	OFF	ON
10	OFF	OFF	OFF	OFF	ON	OFF	ON	OFF
11	OFF	OFF	OFF	OFF	ON	OFF	ON	ON
12	OFF	OFF	OFF	OFF	ON	ON	OFF	OFF
13	OFF	OFF	OFF	OFF	ON	ON	OFF	ON
14	OFF	OFF	OFF	OFF	ON	ON	ON	OFF
15	OFF	OFF	OFF	OFF	ON	ON	ON	ON
16	OFF	OFF	OFF	ON	OFF	OFF	OFF	OFF
17	OFF	OFF	OFF	ON	OFF	OFF	OFF	ON
18	OFF	OFF	OFF	ON	OFF	OFF	ON	OFF
19	OFF	OFF	OFF	ON	OFF	OFF	ON	ON
20	OFF	OFF	OFF	ON	OFF	ON	OFF	OFF
21	OFF	OFF	OFF	ON	OFF	ON	OFF	ON
22	OFF	OFF	OFF	ON	OFF	ON	ON	OFF
23	OFF	OFF	OFF	ON	OFF	ON	ON	ON
24	OFF	OFF	OFF	ON	ON	OFF	OFF	OFF
25	OFF	OFF	OFF	ON	ON	OFF	OFF	ON
26	OFF	OFF	OFF	ON	ON	OFF	ON	OFF
27	OFF	OFF	OFF	ON	ON	OFF	ON	ON
28	OFF	OFF	OFF	ON	ON	ON	OFF	OFF
29	OFF	OFF	OFF	ON	ON	ON	OFF	ON
30	OFF	OFF	OFF	ON	ON	ON	ON	OFF
31	OFF	OFF	OFF	ON	ON	ON	ON	ON
32	OFF	OFF	ON	OFF	OFF	OFF	OFF	OFF
33	OFF	OFF	ON	OFF	OFF	OFF	OFF	ON
34	OFF	OFF	ON	OFF	OFF	OFF	ON	OFF
35	OFF	OFF	ON	OFF	OFF	OFF	ON	ON
36	OFF	OFF	ON	OFF	OFF	ON	OFF	OFF
37	OFF	OFF	ON	OFF	OFF	ON	OFF	ON
38	OFF	OFF	ON	OFF	OFF	ON	ON	OFF
39	OFF	OFF	ON	OFF	OFF	ON	ON	ON
40	OFF	OFF	ON	OFF	ON	OFF	OFF	OFF
41	OFF	OFF	ON	OFF	ON	OFF	OFF	ON
42	OFF	OFF	ON	OFF	ON	OFF	ON	OFF
43	OFF	OFF	ON	OFF	ON	OFF	ON	ON
44	OFF	OFF	ON	OFF	ON	ON	OFF	OFF
45	OFF	OFF	ON	OFF	ON	ON	OFF	ON
46	OFF	OFF	ON	OFF	ON	ON	ON	OFF
47	OFF	OFF	ON	OFF	ON	ON	ON	ON
48	OFF	OFF	ON	ON	OFF	OFF	OFF	OFF
49	OFF	OFF	ON	ON	OFF	OFF	OFF	ON



## Part Names and Functions

Camera ID	SW1-#1	SW1-#2	SW1-#3	SW1-#4	SW1-#5	SW1-#6	SW1-#7	SW1-#8
50	OFF	OFF	ON	ON	OFF	OFF	ON	OFF
51	OFF	OFF	ON	ON	OFF	OFF	ON	ON
52	OFF	OFF	ON	ON	OFF	ON	OFF	OFF
53	OFF	OFF	ON	ON	OFF	ON	OFF	ON
54	OFF	OFF	ON	ON	OFF	ON	ON	OFF
55	OFF	OFF	ON	ON	OFF	ON	ON	ON
56	OFF	OFF	ON	ON	ON	OFF	OFF	OFF
57	OFF	OFF	ON	ON	ON	OFF	OFF	ON
58	OFF	OFF	ON	ON	ON	OFF	ON	OFF
59	OFF	OFF	ON	ON	ON	OFF	ON	ON
60	OFF	OFF	ON	ON	ON	ON	OFF	OFF
61	OFF	OFF	ON	ON	ON	ON	OFF	ON
62	OFF	OFF	ON	ON	ON	ON	ON	OFF
63	OFF	OFF	ON	ON	ON	ON	ON	ON
64	OFF	ON	OFF	OFF	OFF	OFF	OFF	OFF
65	OFF	ON	OFF	OFF	OFF	OFF	OFF	ON
66	OFF	ON	OFF	OFF	OFF	OFF	ON	OFF
67	OFF	ON	OFF	OFF	OFF	OFF	ON	ON
68	OFF	ON	OFF	OFF	OFF	ON	OFF	OFF
69	OFF	ON	OFF	OFF	OFF	ON	OFF	ON
70	OFF	ON	OFF	OFF	OFF	ON	ON	OFF
71	OFF	ON	OFF	OFF	OFF	ON	ON	ON
72	OFF	ON	OFF	OFF	ON	OFF	OFF	OFF
73	OFF	ON	OFF	OFF	ON	OFF	OFF	ON
74	OFF	ON	OFF	OFF	ON	OFF	ON	OFF
75	OFF	ON	OFF	OFF	ON	OFF	ON	ON
76	OFF	ON	OFF	OFF	ON	ON	OFF	OFF
77	OFF	ON	OFF	OFF	ON	ON	OFF	ON
78	OFF	ON	OFF	OFF	ON	ON	ON	OFF
79	OFF	ON	OFF	OFF	ON	ON	ON	ON
80	OFF	ON	OFF	ON	OFF	OFF	OFF	OFF
81	OFF	ON	OFF	ON	OFF	OFF	OFF	ON
82	OFF	ON	OFF	ON	OFF	OFF	ON	OFF
83	OFF	ON	OFF	ON	OFF	OFF	ON	ON
84	OFF	ON	OFF	ON	OFF	ON	OFF	OFF
85	OFF	ON	OFF	ON	OFF	ON	OFF	ON
86	OFF	ON	OFF	ON	OFF	ON	ON	OFF
87	OFF	ON	OFF	ON	OFF	ON	ON	ON
88	OFF	ON	OFF	ON	ON	OFF	OFF	OFF
89	OFF	ON	OFF	ON	ON	OFF	OFF	ON
90	OFF	ON	OFF	ON	ON	OFF	ON	OFF
91	OFF	ON	OFF	ON	ON	OFF	ON	ON
92	OFF	ON	OFF	ON	ON	ON	OFF	OFF
93	OFF	ON	OFF	ON	ON	ON	OFF	ON
94	OFF	ON	OFF	ON	ON	ON	ON	OFF
95	OFF	ON	OFF	ON	ON	ON	ON	ON
96	OFF	ON	ON	OFF	OFF	OFF	OFF	OFF
97	OFF	ON	ON	OFF	OFF	OFF	OFF	ON
98	OFF	ON	ON	OFF	OFF	OFF	ON	OFF
99	OFF	ON	ON	OFF	OFF	OFF	ON	ON

Camera ID	SW1-#1	SW1-#2	SW1-#3	SW1-#4	SW1-#5	SW1-#6	SW1-#7	SW1-#8
100	OFF	ON	ON	OFF	OFF	ON	OFF	OFF
101	OFF	ON	ON	OFF	OFF	ON	OFF	ON
102	OFF	ON	ON	OFF	OFF	ON	ON	OFF
103	OFF	ON	ON	OFF	OFF	ON	ON	ON
104	OFF	ON	ON	OFF	ON	OFF	OFF	OFF
105	OFF	ON	ON	OFF	ON	OFF	OFF	ON
106	OFF	ON	ON	OFF	ON	OFF	ON	OFF
107	OFF	ON	ON	OFF	ON	OFF	ON	ON
108	OFF	ON	ON	OFF	ON	ON	OFF	OFF
109	OFF	ON	ON	OFF	ON	ON	OFF	ON
110	OFF	ON	ON	OFF	ON	ON	ON	OFF
111	OFF	ON	ON	OFF	ON	ON	ON	ON
112	OFF	ON	ON	ON	OFF	OFF	OFF	OFF
113	OFF	ON	ON	ON	OFF	OFF	OFF	ON
114	OFF	ON	ON	ON	OFF	OFF	ON	OFF
115	OFF	ON	ON	ON	OFF	OFF	ON	ON
116	OFF	ON	ON	ON	OFF	ON	OFF	OFF
117	OFF	ON	ON	ON	OFF	ON	OFF	ON
118	OFF	ON	ON	ON	OFF	ON	ON	OFF
119	OFF	ON	ON	ON	OFF	ON	ON	ON
120	OFF	ON	ON	ON	ON	OFF	OFF	OFF
121	OFF	ON	ON	ON	ON	OFF	OFF	ON
122	OFF	ON	ON	ON	ON	OFF	ON	OFF
123	OFF	ON	ON	ON	ON	OFF	ON	ON
124	OFF	ON	ON	ON	ON	ON	OFF	OFF
125	OFF	ON	ON	ON	ON	ON	ON	OFF
126	OFF	ON	ON	ON	ON	ON	ON	ON
127	OFF	ON	ON	ON	ON	ON	ON	ON
128	ON	OFF	OFF	OFF	OFF	OFF	OFF	OFF
129	ON	OFF	OFF	OFF	OFF	OFF	OFF	ON
130	ON	OFF	OFF	OFF	OFF	OFF	ON	OFF
131	ON	OFF	OFF	OFF	OFF	OFF	ON	ON
132	ON	OFF	OFF	OFF	OFF	ON	OFF	OFF
133	ON	OFF	OFF	OFF	OFF	ON	OFF	ON
134	ON	OFF	OFF	OFF	OFF	ON	ON	OFF
135	ON	OFF	OFF	OFF	OFF	ON	ON	ON
136	ON	OFF	OFF	OFF	ON	OFF	OFF	OFF
137	ON	OFF	OFF	OFF	ON	OFF	OFF	ON
138	ON	OFF	OFF	OFF	ON	OFF	ON	OFF
139	ON	OFF	OFF	OFF	ON	OFF	ON	ON
140	ON	OFF	OFF	OFF	ON	ON	OFF	OFF
141	ON	OFF	OFF	OFF	ON	ON	OFF	ON
142	ON	OFF	OFF	OFF	ON	ON	ON	OFF
143	ON	OFF	OFF	OFF	ON	ON	ON	ON
144	ON	OFF	OFF	ON	OFF	OFF	OFF	OFF
145	ON	OFF	OFF	ON	OFF	OFF	OFF	ON
146	ON	OFF	OFF	ON	OFF	OFF	ON	OFF
147	ON	OFF	OFF	ON	OFF	OFF	ON	ON
148	ON	OFF	OFF	ON	OFF	ON	OFF	OFF
149	ON	OFF	OFF	ON	OFF	ON	OFF	ON

## Part Names and Functions

Camera ID	SW1-#1	SW1-#2	SW1-#3	SW1-#4	SW1-#5	SW1-#6	SW1-#7	SW1-#8
150	ON	OFF	OFF	ON	OFF	ON	ON	OFF
151	ON	OFF	OFF	ON	OFF	ON	ON	ON
152	ON	OFF	OFF	ON	ON	OFF	OFF	OFF
153	ON	OFF	OFF	ON	ON	OFF	OFF	ON
154	ON	OFF	OFF	ON	ON	OFF	ON	OFF
155	ON	OFF	OFF	ON	ON	OFF	ON	ON
156	ON	OFF	OFF	ON	ON	ON	OFF	OFF
157	ON	OFF	OFF	ON	ON	ON	OFF	ON
158	ON	OFF	OFF	ON	ON	ON	ON	OFF
159	ON	OFF	OFF	ON	ON	ON	ON	ON
160	ON	OFF	ON	OFF	OFF	OFF	OFF	OFF
161	ON	OFF	ON	OFF	OFF	OFF	OFF	ON
162	ON	OFF	ON	OFF	OFF	OFF	ON	OFF
163	ON	OFF	ON	OFF	OFF	OFF	ON	ON
164	ON	OFF	ON	OFF	OFF	ON	OFF	OFF
165	ON	OFF	ON	OFF	OFF	ON	OFF	ON
166	ON	OFF	ON	OFF	OFF	ON	ON	OFF
167	ON	OFF	ON	OFF	OFF	ON	ON	ON
168	ON	OFF	ON	OFF	ON	OFF	OFF	OFF
169	ON	OFF	ON	OFF	ON	OFF	OFF	ON
170	ON	OFF	ON	OFF	ON	OFF	ON	OFF
171	ON	OFF	ON	OFF	ON	OFF	ON	ON
172	ON	OFF	ON	OFF	ON	ON	OFF	OFF
173	ON	OFF	ON	OFF	ON	ON	OFF	ON
174	ON	OFF	ON	OFF	ON	ON	ON	OFF
175	ON	OFF	ON	OFF	ON	ON	ON	ON
176	ON	OFF	ON	ON	OFF	OFF	OFF	OFF
177	ON	OFF	ON	ON	OFF	OFF	OFF	ON
178	ON	OFF	ON	ON	OFF	OFF	ON	OFF
179	ON	OFF	ON	ON	OFF	OFF	ON	ON
180	ON	OFF	ON	ON	OFF	ON	OFF	OFF
181	ON	OFF	ON	ON	OFF	ON	OFF	ON
182	ON	OFF	ON	ON	OFF	ON	ON	OFF
183	ON	OFF	ON	ON	OFF	ON	ON	ON
184	ON	OFF	ON	ON	ON	OFF	OFF	OFF
185	ON	OFF	ON	ON	ON	OFF	OFF	ON
186	ON	OFF	ON	ON	ON	OFF	ON	OFF
187	ON	OFF	ON	ON	ON	OFF	ON	ON
188	ON	OFF	ON	ON	ON	ON	OFF	OFF
189	ON	OFF	ON	ON	ON	ON	OFF	ON
190	ON	OFF	ON	ON	ON	ON	ON	OFF
191	ON	OFF	ON	ON	ON	ON	ON	ON
192	ON	ON	OFF	OFF	OFF	OFF	OFF	OFF
193	ON	ON	OFF	OFF	OFF	OFF	OFF	ON
194	ON	ON	OFF	OFF	OFF	OFF	ON	OFF
195	ON	ON	OFF	OFF	OFF	OFF	ON	ON
196	ON	ON	OFF	OFF	OFF	ON	OFF	OFF
197	ON	ON	OFF	OFF	OFF	ON	OFF	ON
198	ON	ON	OFF	OFF	OFF	ON	ON	ON
199	ON	ON	OFF	OFF	OFF	ON	ON	OFF

Camera ID	SW1-#1	SW1-#2	SW1-#3	SW1-#4	SW1-#5	SW1-#6	SW1-#7	SW1-#8
200	ON	ON	OFF	OFF	ON	OFF	OFF	OFF
201	ON	ON	OFF	OFF	ON	OFF	OFF	ON
202	ON	ON	OFF	OFF	ON	ON	ON	OFF
203	ON	ON	OFF	OFF	ON	ON	ON	ON
204	ON	ON	OFF	OFF	ON	ON	OFF	OFF
205	ON	ON	OFF	OFF	ON	ON	OFF	ON
206	ON	ON	OFF	OFF	ON	OFF	ON	OFF
207	ON	ON	OFF	OFF	ON	OFF	ON	ON
208	ON	ON	OFF	ON	OFF	OFF	OFF	OFF
209	ON	ON	OFF	ON	OFF	OFF	OFF	ON
210	ON	ON	OFF	ON	OFF	ON	ON	OFF
211	ON	ON	OFF	ON	OFF	ON	ON	ON
212	ON	ON	OFF	ON	OFF	ON	OFF	OFF
213	ON	ON	OFF	ON	OFF	ON	OFF	ON
214	ON	ON	OFF	ON	OFF	OFF	ON	OFF
215	ON	ON	OFF	ON	OFF	OFF	ON	ON
216	ON	ON	OFF	ON	ON	OFF	OFF	OFF
217	ON	ON	OFF	ON	ON	OFF	OFF	ON
218	ON	ON	OFF	ON	ON	ON	ON	OFF
219	ON	ON	OFF	ON	ON	ON	ON	ON
220	ON	ON	OFF	ON	ON	ON	OFF	OFF
221	ON	ON	OFF	ON	ON	ON	OFF	ON
222	ON	ON	OFF	ON	ON	OFF	ON	OFF
223	ON	ON	OFF	ON	ON	OFF	ON	ON
224	ON	ON	ON	OFF	OFF	OFF	OFF	OFF
225	ON	ON	ON	OFF	OFF	OFF	OFF	ON
226	ON	ON	ON	OFF	OFF	ON	ON	OFF
227	ON	ON	ON	OFF	OFF	ON	ON	ON
228	ON	ON	ON	OFF	OFF	ON	OFF	OFF
229	ON	ON	ON	OFF	OFF	ON	OFF	ON
230	ON	ON	ON	OFF	OFF	OFF	ON	OFF
231	ON	ON	ON	OFF	OFF	OFF	ON	ON
232	ON	ON	ON	OFF	ON	OFF	OFF	OFF
233	ON	ON	ON	OFF	ON	OFF	OFF	ON
234	ON	ON	ON	OFF	ON	ON	ON	OFF
235	ON	ON	ON	OFF	ON	ON	ON	ON
236	ON	ON	ON	OFF	ON	ON	OFF	OFF
237	ON	ON	ON	OFF	ON	ON	OFF	ON
238	ON	ON	ON	OFF	ON	OFF	ON	OFF
239	ON	ON	ON	OFF	ON	OFF	ON	ON
240	ON	ON	ON	ON	OFF	OFF	OFF	OFF
241	ON	ON	ON	ON	OFF	OFF	OFF	ON
242	ON	ON	ON	ON	OFF	ON	ON	OFF
243	ON	ON	ON	ON	OFF	ON	ON	ON
244	ON	ON	ON	ON	OFF	ON	OFF	OFF
245	ON	ON	ON	ON	OFF	ON	OFF	ON
246	ON	ON	ON	ON	OFF	OFF	ON	OFF
247	ON	ON	ON	ON	OFF	OFF	ON	ON
248	ON	ON	ON	ON	ON	OFF	OFF	OFF
249	ON	ON	ON	ON	ON	OFF	OFF	ON

## Part Names and Functions

Camera ID	SW1-#1	SW1-#2	SW1-#3	SW1-#4	SW1-#5	SW1-#6	SW1-#7	SW1-#8
250	ON	ON	ON	ON	ON	OFF	ON	OFF
251	ON	ON	ON	ON	ON	OFF	ON	ON
252	ON	ON	ON	ON	ON	ON	OFF	OFF
253	ON	ON	ON	ON	ON	ON	OFF	ON
254	ON	ON	ON	ON	ON	ON	ON	OFF
255	ON	ON	ON	ON	ON	ON	ON	ON

Connect the controller and alarm input and output signal (main body port block)

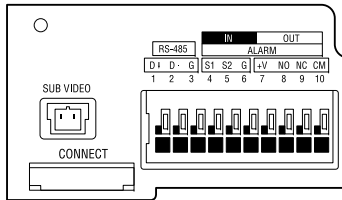

Pin Order	Pin Name	Purpose
1	D+	RS-485 Data+
2	D-	RS-485 Data-
3	G	GND
4	S1	Alarm Signal Input Port #1
5	S2	Alarm Signal Input Port #2
6	G	GND
7	+V	+12V Output Port
8	NO	Alarm Signal Output Port #1 (For Normal Open)
9	NC	Alarm Signal Output Port #1 (For Normal Close)
10	CM	Alarm Signal Output (For Common)

## Auxiliary Video Out Port

When the product is installed in a place where video signal connection through the BNC port is unavailable, you can connect a video cable using the Auxiliary Video Out Port. In this case, connect using the BNC auxiliary cable that is supplied as an accessory.



## Setting Termination Resistance

In order to prevent signal reduction, the termination resistance of the 2 end units, which are the distant paths for camera and controller to be connected on the RS485 interface, should be connected. As the termination resistance is built in the camera, whether to make the termination resistance valid or invalid is selected with the DIP switch. See the connection diagram below for determining to which device the termination resistance will be connected to. Set up the termination resistance in the dark products. The installation distance of the product for the termination resistance setting should be less than 1.2 Km. (Maximum cable length is 1.2 Km according to the RS-485 standards.)

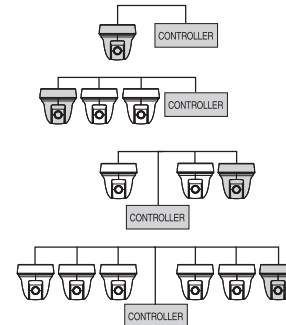

## Components and Accessories

## Installation

### Accessories

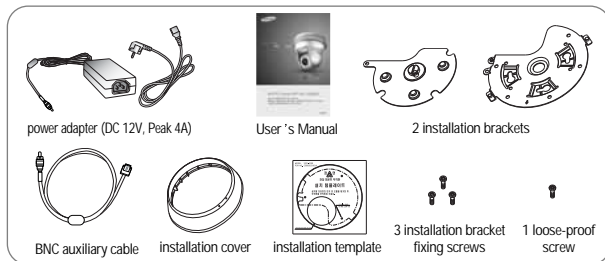

### Products Sold Separately

The following products are provided separately.

- CONTROLLER  
Camera Controller : SCC-3100A
- Accessory Housing  
Wall Type Mount : STB-280PW  
Wall Type Mount : STB-230PW  
Dome Housing : STH-1000PI  
Outdoor Housing : STH-1000PO

#### Notes

- See pages 25 for product images.

### Preparation for Cable

To install and use the SPD-1000, the following cables should be used.

- Power Adapter Cable  
The cable connected to the power input terminal of SPD-1000 is shown below with a rated voltage of DC 12V 4A.

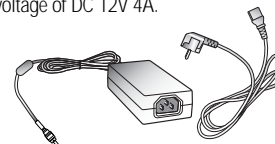

- Video Cable  
The cable connected to the video output terminal and to the monitor of SPD-1000 is the BNC cable shown below.

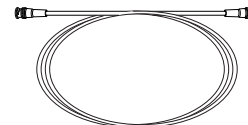

- Communications Cable  
The cable connected to the controller of SPD-1000 for RS-485 communication is shown below.

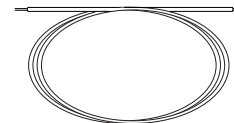

#### Notes

- Video cable and RS-485 communication cable are not provided in this product's package.

# Installation

## Cable Connection

1. First, connect one end of the BNC video cable connector to the Video Output Terminal.
2. Next, connect the other end of the connector to the Video Input Terminal of the monitor.
3. Connect the Controller Connection Terminal of SPD-1000 and the external Controller.
4. Then, connect the Power Adapter Cable. Use a driver (-) to screw one part of the Power Adapter consisting of two lines to the Power Input Terminal of the camera holder.

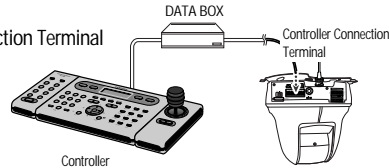
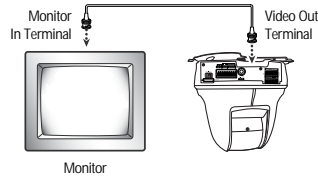

5. Connect the Power Adapter's plug to the Power Outlet.

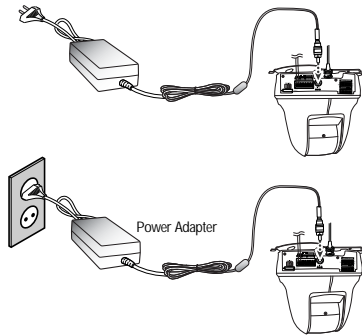

## Installation of SPD-1000

- Precautions for Installation
  - Check that the installation location can safely bear four times the weight of the camera and its installation fittings.
  - When fixing the ceiling installation bracket, use the supplied installation template and fixing screws.
  - Take care not to drop the product during installation. Do not allow anyone to stand below the installation area.

### • Optional Products for Installation

#### 1) Wall Mount (STB-280PW)

This housing is used to install the camera on an indoor wall or ceiling using an external conduit.



#### 2) Wall Mount (STB-230PW)

This housing is used to install the camera on an indoor wall.



#### 3) Dome Housing (STH-1000PI)

This housing is used to install the camera in a location that is dusty, or a place where extra protection for the camera is required.

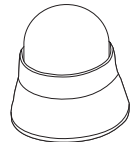

#### 4) Outdoor Housing (STH-1000PO)

This housing is used to install the camera at outdoor area



# Installation

## Installing the SPD-1000 on a Ceiling

1. Prepare the accessories in the camera box (power adapter, installation template, BNC auxiliary cable, 1 loose-proof screw, 3 installation bracket fixing screws, 2 installation brackets, installation cover) and a tool for making a hole in the ceiling.

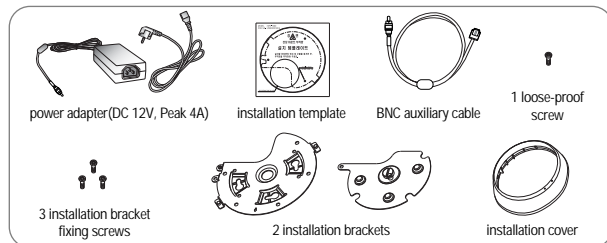

2. Attach the installation template to the ceiling where you want to install the camera, make a hole of at least 65mm in diameter, and 3 holes for fixing screws according to the marks on the template, and pull the external incoming cables out of the hole.

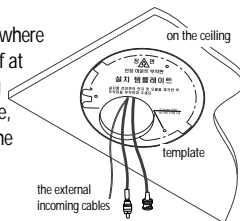

### Notes

#### \*Precautions before Attaching the Installation Template

- Installation Location: Check that the function and performance of the camera installed on the ceiling will not be adversely affected by the external environment, and that the ceiling can adequately support the weight of the camera.
- Installation Direction: Determine the main direction of the camera in advance and attach the template so that the front of the template is in line with the camera direction.
- Caution: Since there is a danger of the product falling during installation, take care not to allow anyone to stand below the installation area.

3. Align the arrow on the ceiling attachment installation bracket with the front of the template, fix the bracket by fastening the 3 screws through the holes, and connect the external incoming cables (video cable, controller cable and power cord) to the camera.

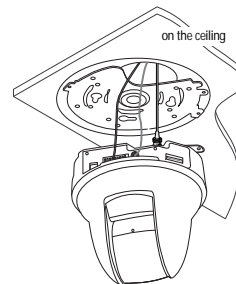

4. Assemble the camera, which should already have been attached to the product installation bracket, to the ceiling attachment installation bracket, facing forwards, and fix the camera with the supplied fixing screw.



5. To complete installation, rotate the installation cover along the groove of the ceiling attachment bracket, and fix it.

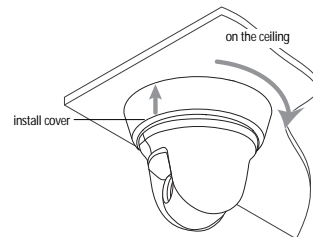

# Installation

## Installing the SPD-1000 Wall Mount

1. Prepare the accessories in the camera box (power adapter, BNC auxiliary cable, 1 loose-proof screw, 2 installation brackets, installation cover) and the wall mount (STB-280PW or STB-230PW) and 3 installation bracket fixing screws in the mount packaging box.

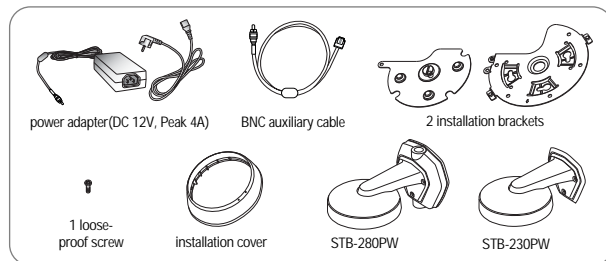

2. Fix the wall mount (STB-280PW) with 3 screws to the wall where the camera is to be installed, as shown in the figure on the right.

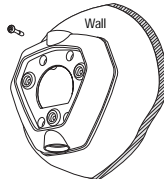

### Notes

#### \*Precautions before Attaching the Installation Template

- Installation Place: Check that the function and performance of the camera installed on the wall will not be adversely affected by the external environment, and that the ceiling can adequately support the weight of the camera.
- Installation Direction: Determine the main direction of the camera in advance and attach the template so that the front of the template is in line with the camera direction.
- Caution: Since there is a danger of the product falling during installation, take care not to allow anyone to stand below the installation area.

3. Fix the wall bracket and the wall surface attachment installation bracket onto the wall mount (STB-280PW) with the screws supplied, as shown in the figure on the right, and connect the external incoming cables (video cable, controller cable and power cord) to the camera.

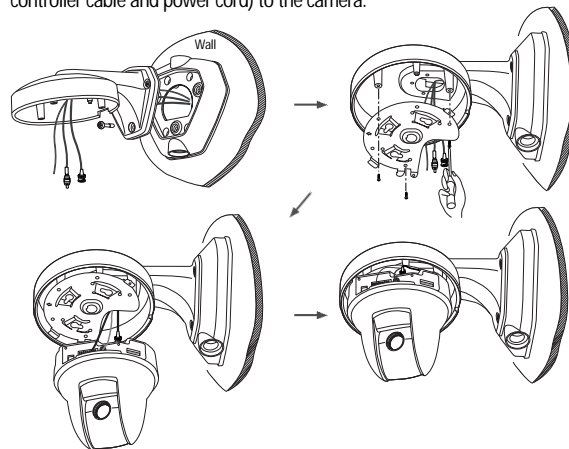

4. Assemble the camera, which should already have been attached to the product installation bracket, to the wall attachment installation bracket, facing forwards, and fix the camera with the supplied fixing screw.

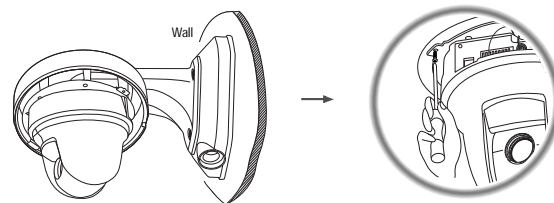

## Installation

5. To complete installation, rotate the installation cover along the groove of the ceiling attachment bracket, and fix it.

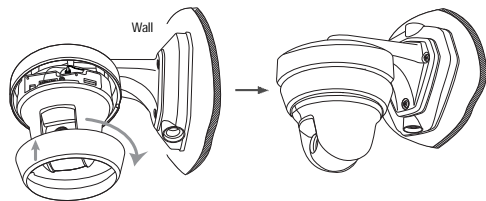

### Installing the Dome Housing (STH-1000PI)

To install the Dome Housing (STH-1000PI), fix it instead of installing the cover in the last step "Installing the SPD-1000 on a Ceiling" on page 26 and "Installing the SPD-1000 Wall Mount" on page 28.

- When the Dome Housing is installed on the ceiling

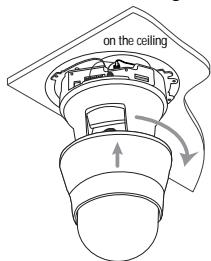

- When the Dome Housing is installed on the wall

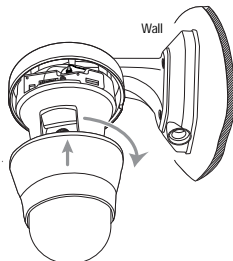

### Installing the Outdoor Housing (STH-1000PO)

To install the outdoor housing, refer to the SPEED DOME CAMERA ACCESSORY user manual.

## Functional Description

### OSD Menu Organization

PTZ camera can be set up on the OSD (On Screen Display) menu displayed on the video monitor by the camera controller. The joystick operations in the OSD menu are as follows. In addition, sending control codes to the camera from the PC can also use the camera functions.

Menu	Function	Menu	Function
TILT UP	Move up on the OSD menu	PAN LEFT	Move left on the OSD menu
TILT DOWN	Move down on the OSD menu	PAN RIGHT	Move right on the OSD menu

P1	P2	P3	P4	Defaults	
① Camera Setting	① Focus	① Focus Mode	Auto/Manual/One Shot AF	One Shot AF	
		② Zoom Tracking	Mode	On/Off	ON
			Speed	Slow/Fast	Fast
	③ Digital Zoom		Off(2-10X)	OFF	
	② White Balance	AWB Mode	ATW/AWC/MANUAL		ATW(O)
			▶ATW		29
			-ATW(I): Indoor -ATW(O): Outdoor		41
			▶Manual		
			-Red -Blue		
	③ Exposure	① Brightness		25	025
			② Iris	Auto	Auto
			Manual	Iris Level	100
		④ Shutter	---		ESC
			A.FLK		
		④ Sens-Up	Manual	1/60(1/50)-1/120,000, x2-x128	1/60(1/50)
			Auto	Sens-Up Limit x2-x128	x4
			Off		
	④ Back Light	High/Middle/Low/Off		OFF	
	⑤ AGC	High/Normal/Off		Normal	
	⑥ SSNR	High/Middle/Low/Off		Low	
⑦ Day & Night	Auto				
	B/W				
	Color	Burst Level	060		
⑧ Others	① Sync		Internal		
	② Image Adj.	Sharpness		008	
		Color		050	
	③ Freeze	On/Off	OFF		
	④ Position	Ceiling/Desktop	Ceiling		



# Functional Description

P1	P2	P3	P4	Defaults
②Sequence Setting	①Preset	①Setting ②Edit ③Execute ④Clear ⑤Status		
	②Swign SEO	①Pan Swing	①Setting ②Execute ③Clear	
		②Tilt Swing	①Setting ②Execute ③Clear	
		③P/T Swing	①Setting ②Execute ③Clear	
	③Group SEO	①Group1	①Setting ②Execute ③Clear	
		②Group2	①Setting ②Execute ③Clear	
		③Group3	①Setting ②Execute ③Clear	
		④Group4	①Setting ②Execute ③Clear	
		⑤Group5	①Setting ②Execute ③Clear	
		⑥Group6	①Setting ②Execute ③Clear	
④Tour SEO	①Setting ②Execute ③Clear			
⑤PTZ Trace	①Trace1	①Replay ②Memorize		
	②Trace2	①Replay ②Memorize		
	③Trace3	①Replay ②Memorize		
	④Trace4	①Replay ②Memorize		
⑥Auto Run	①Mode	①Off	OFF	
		②Preset Preset No		
		③Swing Swing Mode Pan/Tilt/P&T		
		④Group Group No		
		⑤Tour		
		⑥Trace Trace1-Trace4		
	⑦A.Pan	①Auto Pan Speed 20-50 ②Tilt Angle 10-45	32 25	
②Time	1-59(SEC), 1-59(MIN)	30 sec		
⑦Power On Resume	On/Off		OFF	
③P/T Setting	①Pan Limit	①Position ②ON/OFF		
	②Tilt Limit	①Position ②ON/OFF		
	③Area Setting	①Area1	①Area Name ②Position ③ON/OFF	
		②Area2		
		③Area3		
		④Area4		
	④Area Masking	①Mask1 ②Mask2	①Position ②ON/OFF	

P1	P2	P3	P4	Defaults
③P/T Setting	④Area Masking	③Mask3 ④Mask4		
	⑤Prop. P/T	ON / OFF		ON
	⑥Digital Flip	ON / OFF		ON
	⑦Log Speed	Manual (10,20,30,40,50,60)		MANUAL
④OSD Setting	①Camera ID	ON / OFF	①Position ②ON/OFF	ON
	②Camera Name	①ON / OFF ②Edit		
	③Preset Number	ON / OFF		ON
	④Preset Name	①ON / OFF ②Edit		
	⑤Sequence Status	ON / OFF		ON
	⑥Area Name	ON / OFF		OFF
	⑦PTZ Position	ON / OFF		OFF
⑤Alarm Setting	⑧Language	English, Chinese, Francais, Deutsch, Espanol, Italiano		English
	①Output Clear			
	②Input 1	NC/NO/OFF L/H(Priority) Preset/Swing/Group/Tour /Trace/A.PAN/OFF		
	③Input 2	1-2, MD 1-59 (Sec) 1-59 (Min) 1-59 (Hour)		01(Min)
	④Output			
⑤Enable	ON/OFF		OFF	
⑥MD Dwell Time	ON/OFF	1-59(Sec) / 1-59(Min)	30sec	
⑥Initialize	①Power On Reset	①Cancel ②Execute		
	②Initial Position	①Position ②ON/OFF		
	③Factory Default Set	①Cancel ②Execute		
	④Camera Default Set	①Cancel ②Execute		
	⑤Auto Refresh	OFF, 1-7Days		OFF
⑦Status				



## Notes

- Preset settings are only possible within the OSD menu or by using the controller.

# Functional Description

## Symbol Description

1. Motion Stabilization Stand-by Operation
    - "D" symbol is flashing on the right top of the screen.
  2. Alarm Input #1, 2 Sensor Operation
    - "①", "②" symbols are flashing on the right top of the screen.
  3. Alarm Output Operation
    - Symbols are flashing on the right top of the screen.
  4. Motion Detect Operation
    - "Man Icon" is flashing on the right top of the screen.
5. When there are sub menus under the selected OSD menu
    - Numbers are displayed in white colour like ① on the right top of the screen.
  6. When there is no sub menu under the selected OSD menu
    - Numbers are displayed in black colour like ① on the right top of the screen.

## PTZ Camera User Menu Settings

- Execution of OSD Menu : After checking if the camera is in manual operation mode, press the OSD Menu key. The following commands are displayed on the monitor screen.

### • Main Menu

The selection key moves up and down. Press the execution key switch on the selected menu to change the setup menu. Press the ESC key to exit the OSD Menu.

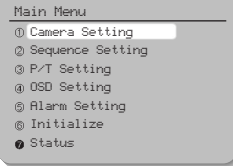

## 1) Camera Setting

Select the Camera Setting on the Main Menu screen to control camera settings

### • Camera Setting Menu

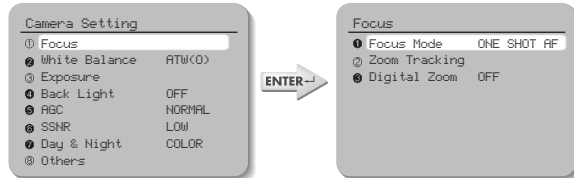

## FOCUS

In Focus menu, you can set up the focus mode among Auto, Manual or One Shot AF.

### ① Focus Mode

- ▶ Auto : The camera adjusts the focus automatically while monitoring the screen continuously in the auto mode. In the auto focusing mode, zoom key operation is not recognized as the input of the focus key.
- ▶ Manual : In the manual mode, users can adjust the camera focus manually.
- ▶ One Shot AF : Only when the camera does not move, it turns into the auto mode. It is the same as the manual mode.

### ② Zoom Tracking

- ▶ Mode: When you select ON, the Focus function is executed when the Zoom function is on. When you select OFF, the Focus function is not executed even when the Zoom function is on.
- ▶ Speed: Fast will speed up the Zoom. Slow will slow down the Zoom.

### ③ Digital Zoom

- Magnification of the Digital Zoom can be selected among Off, 2X~10X.  
\*It is recommended that the Digital Zoom should be set up before the preset operation.



## Notes

- Digital Zoom
  - As the digital zoom magnification increases, the image quality is lowered.
- Auto-focus
  - Auto-focus may not function normally under the following conditions.
    - When the light level in the surveillance area is low
    - When the slow-shutter works
    - When the amplification is increased
    - When the light level in the surveillance area is excessively high
    - When the objects in the long and short distance are under the same surveillance area
    - When there is no contrast (white and black) in the object (e.g. sky or wall)
    - When the thin horizontal line is captured

# Functional Description

## White Balance

The White Balance function corrects the abnormal white colour into the normal white colour under any colour temperature lighting. Select the mode among ATW, AWC and Manual. ATW is selected by default.

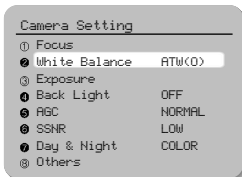

### WB Mode

▶ATW: Balances the colour automatically depending on the source of light from 1,800~10,500K colour temperature.

\* Indoor[ATW(I)] : Use this mode in the area under the limited colour temperature.

\* Outdoor[ATW(O)]: Use this mode in the area under the broad colour temperature.

▶AWC: Set up the lighting to the objects and corrects the right colour temperature to that of a white object. Camera works under the setup conditions. For the most appropriate condition under the current illumination, capture the white paper and then change the mode into AWC. Press the Enter key and then AWC Start will be displayed. When the adjustment is completed after pressing the Enter key for AWC Start, go to the upper menu. When conditions change, adjust the white balance function again.

▶Manual: Fine tuning is possible through this manual control mode. Select the colour temperature and increase or decrease the Red or Blue values to shift the colour of the object.

\* Red : Red Gain can be changed.

\* Blue : Blue Gain can be changed.

### Notes

• White Balance may not function properly under the following conditions.

- ① When the colour temperature surrounding the object is very high. (e.g. clear sky or sunset)
- ② When it is dark around the object.
- ③ When the camera is pointing towards a fluorescent lamp directly or when lighting conditions change a lot.

## Exposure

Camera exposure can be controlled.

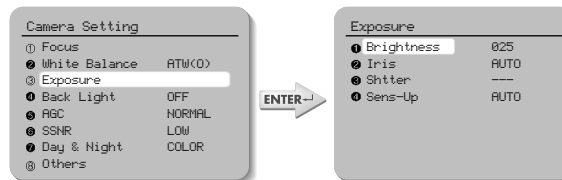

① Brightness: The brightness of the screen can be adjusted.

② Iris: Auto mode or manual mode can be selected.

▶Auto: The brightness of the image signal can be adjusted automatically depending on the amount of light.

▶Manual: The brightness of the image can be adjusted.

③ Shutter

▶---: Electronic shutter mode is enabled. The shutter speed is controlled automatically according to the brightness of the screen.

▶A.FLK: Use this mode when the screen flickers because of inconsistent frequency with the surrounding lights.

▶Manual: 1. Shutter speed can be controlled manually.

2. Shutter speed can be adjusted from 1/60(1/50) second to 1/120,000 second.

3. Sens-Up function can be operated manually from x2 - x128.

### Notes

- If the Shutter mode is ESC in the inner synchronization mode and the camera faces to the bright fluorescent lamp directly, the image may be unstable. Be careful to select the installation location.
- If the Manual or A.FLK mode is selected for the Shutter menu, the Sens-Up function is disabled.

## Functional Description

### ④ Sens-Up

- ▶ Auto: The low light level of the night or dark condition is detected automatically and the bright and clear image can be maintained.
- ▶ Sens-Up Limit: Maximum accumulated magnification can be selected.
- ▶ Off: Sens-Up function is cancelled.



#### Notes

- As the accumulated magnification increases, the screen goes bright. But, the after image of the moving object also becomes larger and the optimum Auto Focus function may not work.

### Back Light

Unlike other cameras, Samsung Techwin's unique W-III DSP chip gives you a clear image of the subject even with bright backlight.

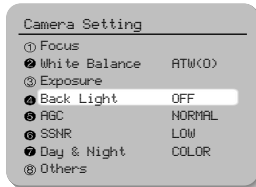

- ▶ HIGH : Gain increased from 6dB up to 34dB.
- ▶ MIDDLE : Gain increased from 6dB up to 30dB.
- ▶ LOW : Gain increased from 6dB up to 18dB
- ▶ OFF : BLC function is cancelled.

### AGC

When the brightness of the image taken under dark light is under a certain level, the AGC (Automatic Gain Control) functions to define whether to control the Gain automatically or not.

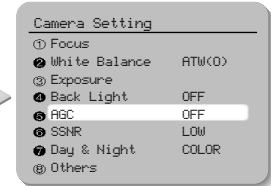
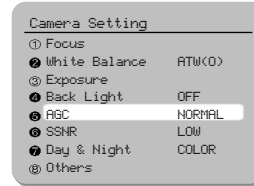

- ▶ HIGH : Gain increased from 6dB up to 34dB.
- ▶ NORMAL : Gain increased from 6dB up to 18dB.
- ▶ OFF : Gain is fixed at 6dB.

### SSNR (Samsung Super Noise Reduction)

SSNR function reduces background noise under low light conditions differently in different modes. The noise reduction effect grows in Off, Low, Middle and High modes in order.

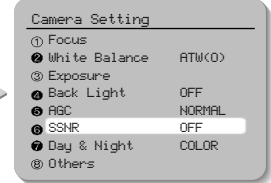
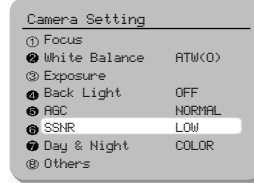

- ▶ OFF : No noise reduction effect.
- ▶ LOW : Noise reduction effect is small but there is little afterimage.
- ▶ MIDDLE : Noise reduction effect is generally effective in this mode. Noise can be reduced properly and the afterimage is not strong.
- ▶ HIGH : Noise reduction effect is excellent but afterimage is also strong.



#### Notes

- When you select the AGC mode as "OFF", you cannot use the SSNR function.

# Functional Description

## Day & Night

The darkness level is detected automatically under low light conditions such as at night or under dark light to keep the screen bright and clear.

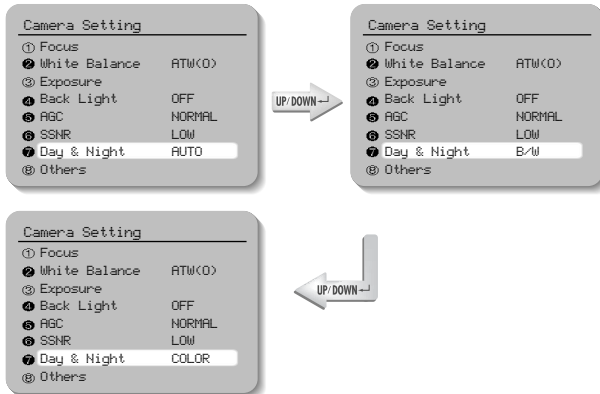

- ▶ **COLOR** : Output images are displayed in colour all the time. Burst signal size can be adjusted.
- ▶ **BW** : Output images are displayed in black and white all the time. Burst signal can be kept or removed.
- ▶ **AUTO** : Under day condition, the mode is automatically changed into the COLOR mode to keep an optimum colour. At night, the mode is automatically changed into the B/W mode to distinguish dark images clearly.

### Notes

- If the AGC is in OFF mode, the Auto mode cannot be used. Only COLOR or B/W mode can be used.
- If the sunlight or halogen lamp is used in B/W mode, the focus may be blurred compared with the general illumination.

## Others

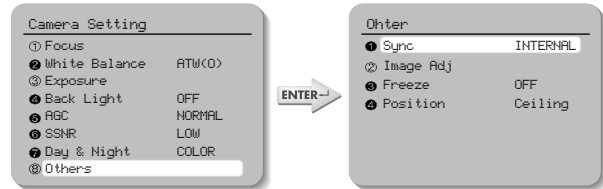

- ➊ **Sync**: Internal Sync is selected by default.
  - ▶ Internal : Internal synchronization
- ➋ **Image Adj.** : Clarity of the video signal and saturation of the color may be adjusted.
  - ▶ Sharpness : The overall sharpness of the image can be adjusted.
  - ▶ Color : The overall colour density of the image can be adjusted.
- ➌ **Freeze** : Moving image can be stopped and replayed.
  - ▶ ON : Image can be frozen.
  - ▶ OFF : Frozen image is released and the film is replayed.
- ➍ **Position** : Select the installation direction of the camera.
  - ▶ Ceiling : When the camera is installed on the ceiling
  - ▶ Desktop : When the camera is installed on the table

# Functional Description

## 2) Sequence Setting

### • Sequence Setting Menu

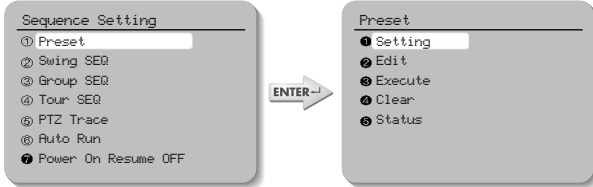

- ① Preset : 12 items such as Pan/Tilt location, Zoom and Focus are selected among camera functions and they can be called for monitoring. Total 128 points can be preset.
- ▶ Setting : Select the Preset number for setup. Adjust Pan/Tilt/Zoom and press the Enter key to save the setting. If you want to change the 12 items such as Focus, Brightness, Iris and Scene Adj., use the Up/Down key to go to and select the item. If you don't want to change the 12 items, press the ESC key to go to the next Preset step.
  - ▶ Edit : You can edit the 12 preset items such as Pan/Tilt location, Zoom and Focus, which are selected among camera functions.
  - ▶ Execute : Select the Preset number for execution.
  - ▶ Clear : Select the Preset number to delete for clearing.
  - ▶ Status : The current Preset number setup is displayed.

### • Motion Detection Setting

Select Motion Detection in the Preset Setting menu and then turn on the mode.

#### Notes

- When the illumination is shaking under direct lighting such as a fluorescent lamp, it may cause malfunction of the camera. MD function is not recommended under this condition.
- When brightness of objects fluctuates suddenly due to lighting of flashlights or headlights or the lamp going on/off, it may cause malfunction of the camera.
- The purpose of this security function is not to prevent accidents or crimes such as fire or burglary. Our company is not responsible for the injury or damage caused by the inadequate use of this function.

### • Preset Menu Setting

1. Select the Preset item on the Sequence Setting Menu
2. Select the Setting item.

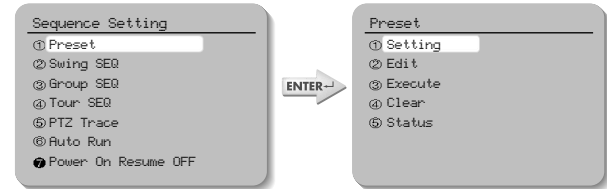

3. Select the Preset number.
4. Set up the Zoom and Focus.



5. To change the camera settings, select Edit from the upper menu first. Select the item to change, and then make the necessary adjustments.

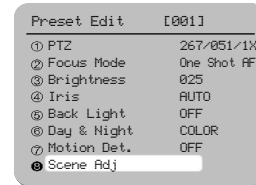

## Functional Description

6. If you select the Scene Adj. item, such items as Shutter, AGC, SSSNR, Sens-Up, White Balance can be set up differently in every Preset item.

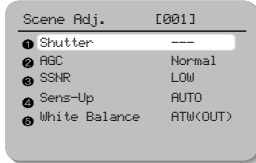

### Notes

- In the White Balance setting of the individual Preset Scene Adj., the AWC selection is not available.

- ② Swing SEQ : Swing surveillance can be executed and set up and the data can be deleted.

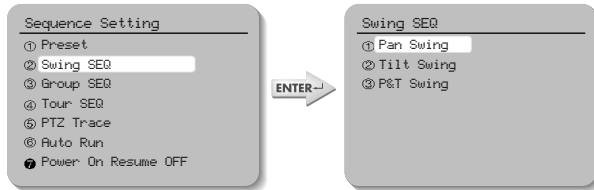

- ▶ Pan Swing : Swing surveillance for the Pan direction is executed and set up. Data is deleted.
- ▶ Tilt Swing : Swing surveillance for the Tilt direction is executed and set up. Data is deleted.
- ▶ P&T Swing : Swing surveillance both for the Pan and the Tilt directions are executed and set up simultaneously. Data is deleted.

\* Setting : The Preset Position for Swing function is selected with the joystick and confirmed with the Execution key. SPD is the moving speed (01-64step). DWL is the stop time (00-120sec). Press the Execution key in the location with selection mark to finish the setting process.

\* Execute : Swing surveillance is executed. Stop key designates this function.

\* Clear : Data in the Swing function is deleted.

- ③ Group SEQ: Sequence surveillance can be executed and set up and data can be deleted. Up to 6 groups can be registered.

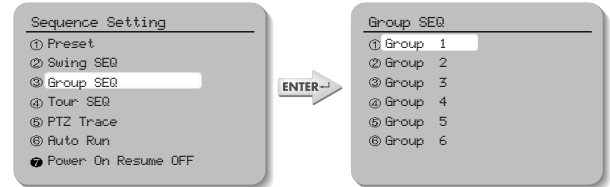

- ▶ Setting : Preset position for swing is selected with the joystick and confirmed with the Execution key. SPD is the moving speed (01~64 step). DWL is the stop time (00~120sec). Press the Execution key in the location with selection mark to finish the setting process.
- ▶ Execute : Swing surveillance can be executed. Stop key will stop this function.
- ▶ Clear : Swing data can be deleted.

- ④ Tour : Group surveillance can be executed and set up and data can be deleted.

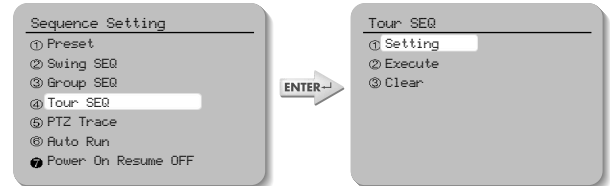

- ▶ Setting : The registered Group Sequence is selected with the joystick and confirmed with the Execution key. If the selected number is not registered, it cannot be input. Press the Execution key in the location with selection mark to finish the setting process.
- ▶ Execute : Group surveillance is executed.
- ▶ Clear : Group surveillance data are deleted.

## Functional Description

- ⑤PTZ Trace : Maximum 4 patterns of the manual operation paths (for Pan, Tilt, Zoom and Focus) are memorized and replayed.

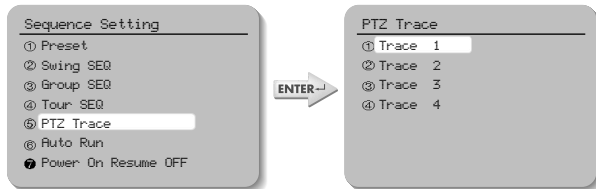

- ▶ Replay : The manual operation paths are repeated and replayed. Stop key will stop the replay.
  - \* If the operation range is limited using ①Pan Limit and ②Tilt Limit, please note that other operations beyond the limited operation range are not possible.
- ▶ Memorize : Manual operations for minimum 120 seconds after executing this function are memorized into the internal memory. Nevertheless, the memorizing time becomes different depending on the PTZ operation. OVER mark will finish this function.
  - \* If the operation range is limited using ①Pan Limit and ②Tilt Limit, only the operations within the limited range are memorized.



### Notes

- Press the OSD key to stop the internal memory to continue saving.

- ⑥Auto Run: If there is no controller operation by the user for a certain time, the sequence operation designated by the user will be executed.

- ▶ Mode - • OFF : Auto Run will be cancelled.
  - Preset : Auto Run in the corresponding Preset number
  - Swing : Auto Run in the corresponding Swing mode
  - Group : Auto Run in the corresponding Group number
  - Tour : Auto Run in the corresponding Tour number
  - Trace : Auto Run in the corresponding Trace number
  - A. Pan : 350° Auto Run in Pan direction

\* Auto Pan Speed: Pan operation in the speed designated by the user

\* Tilt Angle: The tilt angle set up by the user is kept.

- ▶ Time : Auto Run operation is executed after a certain time designated by the user.
  - \* Time can be set up by the unit of 1-59 SEC and 1-59 MIN

- ⑦Power On Resume : When the power supply for the camera is stopped for some reason, such as electricity failure, and resumed, the Sequence Settings before the power off are restored.

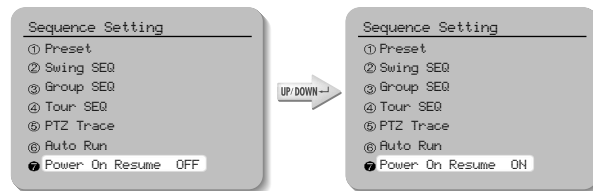

## 3) P/T Setting

- ①Pan Limit : The moving range in the Pan direction can be limited.

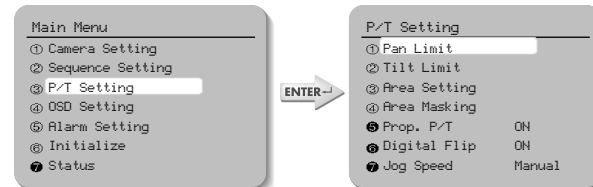

- ▶ Position : Moving range can be set up. Set the position from the left using the joystick and the Execution key. The stop position may change due to the initialization by such operation as power resumption depending on position setting. This does not mean it is out of order.
- ▶ On/Off : When this function is on, the limit is effective. Default setting is Off.



## Functional Description

②Tilt Limit : Moving range in the tilt direction can be limited.

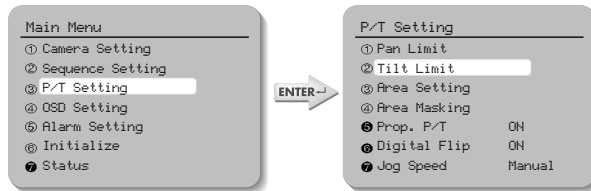

▶ Position : Moving range can be set up. Set the position from the top direction using the joystick and the Execution key. The stop position may change due to initialization by such operation as power resumption depending on position setting. This does not mean it is out of order.

▶ On/Off : The application of limitation will be determined. Default setting is Off.

③Area Setting : Areas can be indicated. Areas can be designated up to 4.

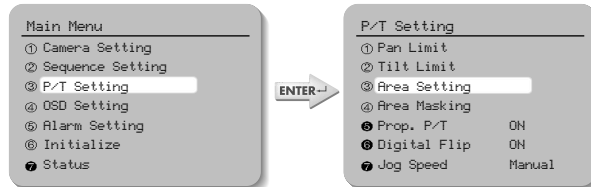

▶ Area Name : Area name can be set up. Use the joystick and the Execution key to enter the area name. A maximum of 12 letters (English, Chinese, numbers) can be entered. When you finish inputting the name, adjust the position mark to "SET" using the joystick and press the Execution key. This is the end of Area Name setting.

▶ Area Position : Area range can be designated. Use the joystick and the Execution key to determine the position from the left. If the area range is overlapped, the smaller area number will indicate the overlapping part.

▶ On/Off : It can be determined whether or not to activate the area mark. The activation becomes effective as soon as the position moves from the current area to other areas. Set up the OSD Setting as ON. If it is in OFF mode, this function does not work. Default setting is Off.

④Area Masking : If you want to exclude some areas for surveillance, they can be turned into black. You can mask 4 parts of one screen.

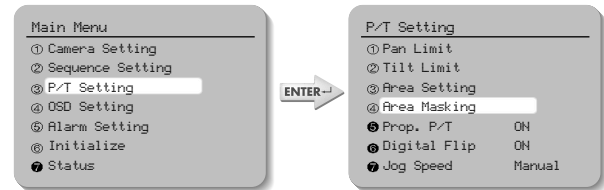

▶ Position : Use the joystick and the Execution key to determine the position for screen operation from the left.

▶ On/Off : Operation of screen area masking can be determined. Default setting is Off.

⑤Prop. P/T : Pan and Tilt speeds can be changed depending on zoom magnification. Tele will slow down the speed of Pan/Tilt and Wide will increase the Pan/Tilt speed. It will take about 20 seconds for 1 cycle in Tele mode and about 3 seconds in the Wide mode. Default setting is ON.

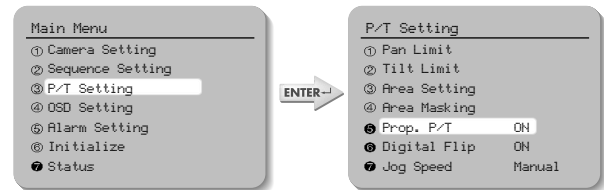



## Functional Description

③ Preset Number (Default setting is ON.) : Preset numbering is set up.

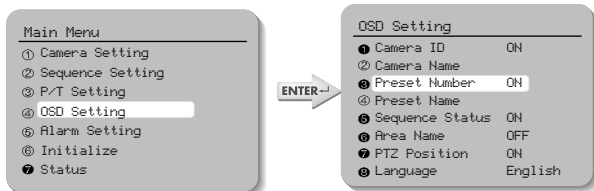

④ Preset Name

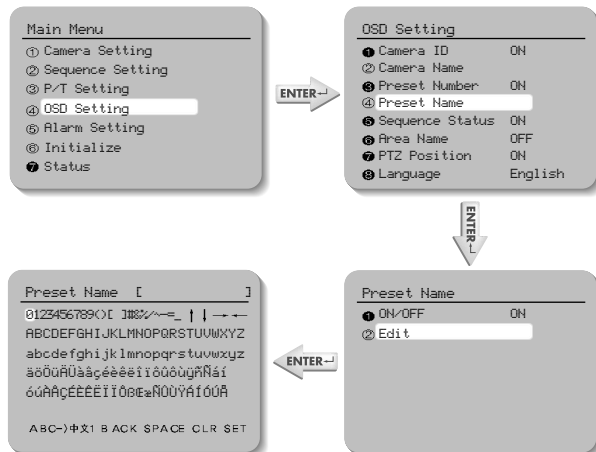

- ▶ Edit : A maximum of 12 characters consisting of English (or Chinese), numbers and special characters can be input for Preset Name.
- ▶ On/Off : The operation of this function is predetermined. Default setting is On.

⑤ Sequence Status (Default setting is ON.) : Display of the Sequence Group is set up.

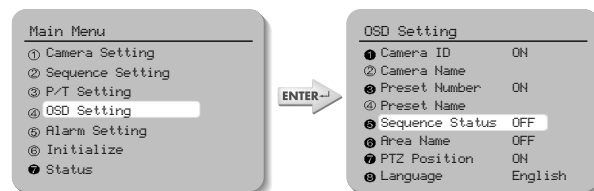

⑥ Area Name : Display of Area Name is set up.

- When the Area Name is OFF, the Area Name cannot be displayed.

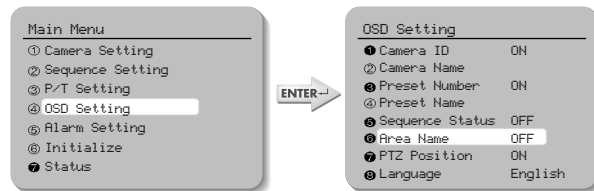

⑦ PTZ Position : Pan and Tilt position and Zoom magnification are displayed.

- PTZ positions are not displayed in the OFF mode. (Only manual operation can display them.)

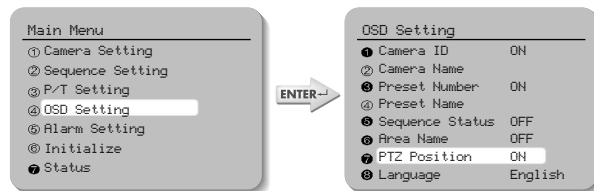

# Functional Description

- ③ Language : The OSD can be displayed either in English (default setting) , Chinese, French, German, Italy and Spanish

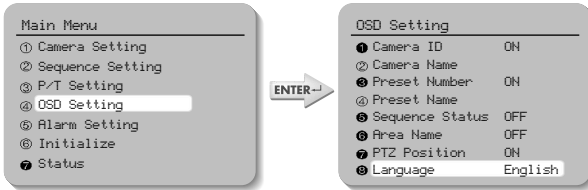

## 5) Alarm Setting

- ① Output Clear : If you want to cancel the operating Alarm outputs at once, select the corresponding menu to cancel the operating Alarm.



- ② Input 1, ③ Input 2 : Alarm Input Mode/Priority/Method is set up.

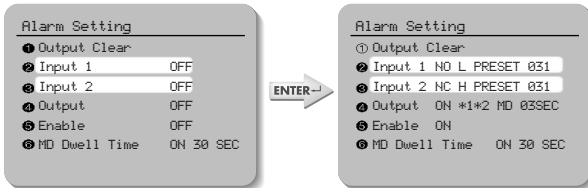

- ▶ NC/NO/OFF : NC/NO/OFF can be selected depending on the alarm sensor.
- ▶ L/H (Priority) : Priority for the 2 alarm inputs is set up. Response comes first from the alarm input of higher priority.
- ▶ Preset/Swing/Group/Tour/Trace/A.PAN : Whether to enable the operation of Preset/Swing/Group/Tour/Trace/A.PAN by alarm input can be set up. When the alarm is input, it stays in the Preset/Swing/ Group/Tour/Trace/A.PAN position.

- ④ Output : One of the 2 Alarm Outs and MD(Motion Detection) corresponds to each Alarm input.

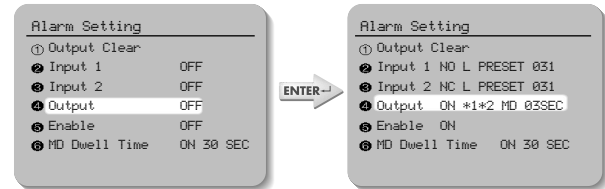

- ▶ For the 2 Alarm Outputs, On/Off and the operation time can be set up in the units of second/minute/hour. (1-59 sec, 1-59 min, 1-59 hour)

- ⑤ Enable : It can be determined whether to enable the alarm setting.

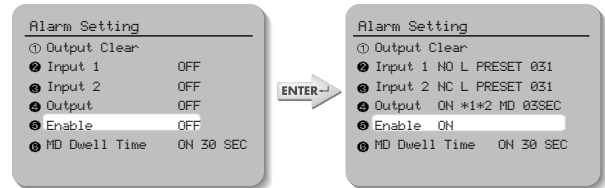

- ▶ ON/OFF : Alarm is enabled in ON mode.

## Functional Description

- ⑥ MD Dwell Time : When was motion detection in each preset that have established motion detection function, it set time that keep relevant preset. For detailed settings of the Motion Detection for each Preset menu, see page 42 and 43.

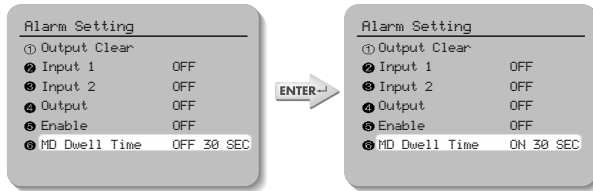

- ▶ ON/OFF : It can be set up how long the operation will be kept when the motion is detected. (1-59 sec, 1-59 min)

### 6) Initialize

- Initialization Menu

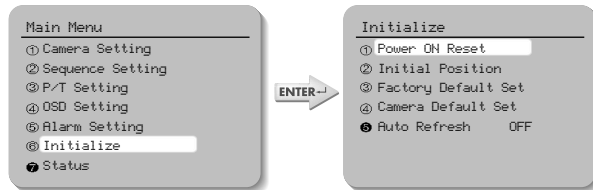

- ① Power On Reset : Camera is initialized into the original status of power input.  
 ② Initial Position : If you want to set the default direction of the camera so that the camera faces that direction when the power is turned on, you can set up the desired Pan and Tilt for the camera.

- ③ Factory Default Settings : Camera is initialized into the factory default settings. Data including Preset is deleted. This function is used for initialization all settings.  
 ④ Camera Default Settings : If only the camera module is replaced due to camera module failure, the new camera module can be set up with the settings of the old camera module.  
 ⑤ Auto Refresh : The electric circuit and the status of the equipment parts within the camera are optimized regularly. (The cycle can be set up.) If camera faces toward a certain source of light or if the settings cannot be kept because of the long time rotation filming of a certain area, the Auto Refresh function is used to maintain and reset the existing camera settings. Default setting is OFF.

- ▶ OFF, 1-7 Days : This function is disabled in the OFF mode. 1-7 Days enables the Auto Refresh operation in the interval of the selected days. Auto Refresh takes less than 10 seconds. The message "Auto Refresh" disappears after finishing the operation.

### 7) Status

- The status of dome camera setting is displayed.

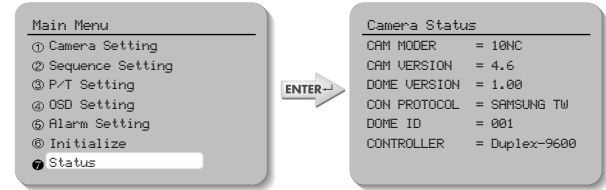

Cam Model = 10NC	Camera Model
Cam Version = 4.6	Camera S/W Version
Dome Version = 1.00	Control Board S/W Version
Dome ID=001	Dome Camera ID
Controller=Duplex-9600	Communication Mode Setup

# Product Structure and Installation

## Product Structure

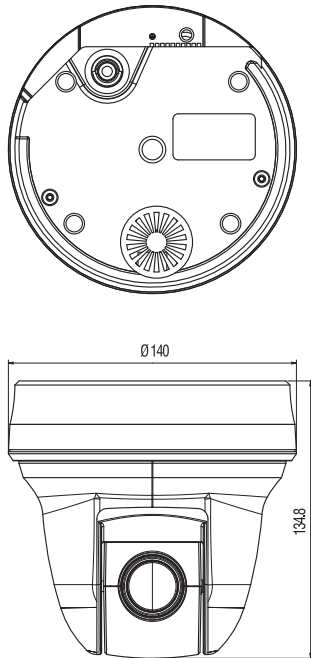

## Installation1 (Mini PTZ Dome Camera Control)

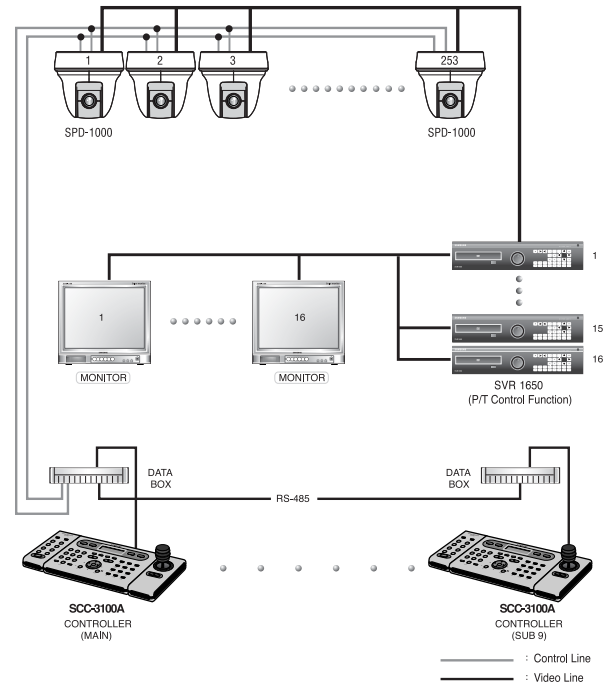

## Installation 2 (Mini PTZ Dome Camera Control)

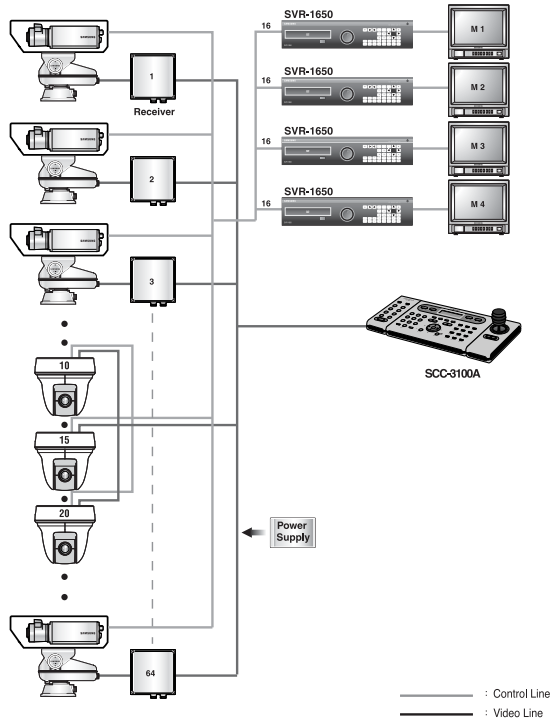

	SPD-1000N	SPD-1000P
Imaging device	1/4" Color Interline Transfer CCD.	
TV	NTSC	PAL
Total Number of Pixels	811(H) X 508(V)	795(H)X596(V)
Valid Pixel	768(H) X 494(V)	752(H)X582(V)
Horizontal Scan Frequency	15.734kHz	15.625kHz
Vertical Scan Frequency	59.94Hz	50Hz
Synchronization	Internal Sync	
Image Output	1.0p-p/75Ω	
S/N Ratio	Higher than 50dB (AGC OFF)	
Horizontal Resolution	520 TV Lines (Color) / 570 TV Lines(B/W)	
Minimum Light for Object	0.7Lux(Color), 0.1Lux(B/W)(@50IRE), 0.0007Lux (Day & Night is On.)(@50IRE)	
Electronic Shutter	Auto/Manual(1/60 - 1/120000)	Auto/Manual(1/50 - 1/120000)
Sens-Up	ON (x2 - x128 Fields) / OFF	
Day&Night	ICR(Filter Switching) ON/OFF	
White Balance	ATW(Indoor/Outdoor Selection)/AWC/Manual (1,800K - 10,500K)	
Flickless Adjustment	Fixed Shutter Speed (1/100)	(1/120)
Iris	Auto/Manual (Iris Level Adjustment Mode)	
Gain Control	Normal, High, Off	
OSD Display	ON/OFF	
Outline Correction	Adjustable Level	
Focal Length	F3.8mm(WIDE)-F38.0mm(TELE), 10X Optical Zoom	
Digital Zoom	OFF, 2-10X Selection (Total 100X Zoom)	
Maximum Aperture Rate	Ligh Angle 1: 1.6, Telescopic 1: 2.8	
Coverage Angle	Wide: 51.2(H) X 39.3(V) Tele: 5.58(H) X 4.27(V)	
Proximity Distance	1.5m (Tele)	
Horizontal Rotation Angle	350°	
Horizontal Rotation	Manual/Program	
Horizontal Rotation Speed	Manual: 0.5° - 70/s(64 levels) Preset: 0.5° - 140/s(64 levels)	
Horizontal Minimum Moving Angle	0.02°	
Vertical Rotation Angle	-5° - 185° (Digital Flip)	
Vertical Rotation	Manual/Program	

## Specifications

	SPD-1000N	SPD-1000P
Vertical Rotation Speed	Manual: 0.5° - 50°/s(64 levels) Preset: 0.5° - 100°/s(64 levels)	
Vertical Minimum Moving Angle	0.02°	
Preset Position	Max 128 points	
Area Masking	Max 4 locations	
Alarm	2 Alarm Inputs	
	1 Alarm Outputs (Relay: NC/NO/COM, 0.5A 125VAC, 2A 30VDC Max)	
Operating Temperature	-10°C - +50°C	
Operating Humidity	20% ~ 75%(Except for dew condensation)	
Storage Temperature	-20°C - +60°C	
Storage Humidity	20% ~ 95%(Except for dew condensation)	
Power, Voltage	DC 12V±10%	
Consumption Electricity	Operation 6 Watts	
Dimension	Ø140 X 134.8mm	
Weight	Less than 0.8kg	
Option	• Wall Mount Bracket : STB-280PW    • Wall Mount Bracket : STB-230PW • Dome Housing : STH-1000PI        • Outdoor Housing : STH-1000PO	

\* The product design and dimensions may change without previous notice for improvement of performance.

- The copyright of this manual belongs to Samsung Techwin Co. Ltd.
- Parts or the whole of this manual cannot be reproduced or transmitted by any electric, mechanic or audio method without the authorized written approval of Samsung Techwin.
- The contents of this manual may be changed for an improvement of functions.

## DECLARATION OF CONFORMITY

Application of Council Directive(s)	EMC-Directive 89/336 EEC and its amendments
Manufacturer's Name	SAMSUNG TECHWIN CO., LTD
Manufacturer's Address	SAMSUNG TECHWIN CO., LTD 42, SUNGJU-DONG CHANGWON-CITY, KYUNGNAM, KOREA, 641-120
European Representative Name	
European Representative Address	
Equipment Type/Environment	Dome Camera
Model Name	SPD-1000
Beginning Serial NO.	S7700001
Year of Manufacture	2007. 07. 10
Conformance to	EN 55022 : 1994 +A1 : 1995 +A2 : 1997 EN 50130-4 : 1995 +A1 : 1998

We, the undersigned, hereby declare that the equipment specified above conforms to the above Directive(s).

Manufacturer	SAMSUNG TECHWIN CO., LTD	Legal Representative in Europe
Signature	<i>Han Seug Kim</i>	Signature
Full Name	HAN SEUG KIM	Full Name
Position	QUALITY CONTROL MANAGER	Position
Place	CHANGWON, KOREA	Place
Date	2007. 07. 10	Date



## Free Manuals Download Website

<http://myh66.com>

<http://usermanuals.us>

<http://www.somanuals.com>

<http://www.4manuals.cc>

<http://www.manual-lib.com>

<http://www.404manual.com>

<http://www.luxmanual.com>

<http://aubethermostatmanual.com>

Golf course search by state

<http://golfingnear.com>

Email search by domain

<http://emailbydomain.com>

Auto manuals search

<http://auto.somanuals.com>

TV manuals search

<http://tv.somanuals.com>