

ENGLISH

Video Camcorder

8mm

VP-W80U/W80/W87/W87D

8 VP-W80U

Hi 8 VP-W80/W87/W87D

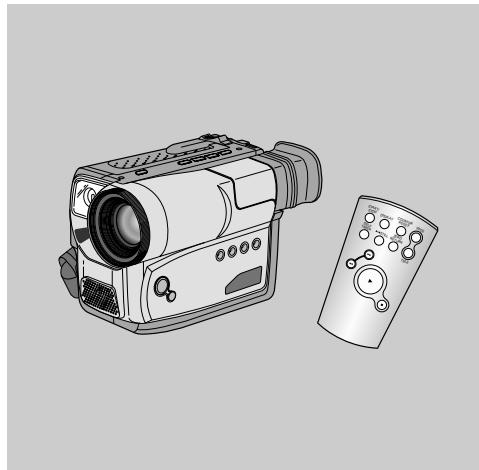

Owner's Instruction Book

Before operating the unit, please read this instruction book thoroughly, and retain it for future reference.



ELECTRONICS



This product meets the intent of Directive 89/336 CEE, 73/23 CEE, 93/68 CEE.

GB

Table of Contents

Precautions and Safety Instructions

Getting to Know Your Camcorder

Features	8
Descriptions	
■ Front View/Side View/Rear View	9, 10, 11
■ OSD (On Screen Display)	12
Accessories Supplied with Camcorder.....	14
Remote Control (VP-W87/W87D only).....	15
■ Self Recording with the Remote Control	15

Preparing

Adjusting the Hand Strap and Shoulder Strap	16
Lithium Battery Installation	17
Connecting a Power Source.....	18
■ To use the AC Power Adapter.....	18
■ To use the Battery Pack.....	19
Using the Battery Pack.....	20
■ Table of approximate continuous recording time.....	20
■ Battery Level display	21
Inserting and Ejecting a Cassette	22

Basic Shooting

Making the First recording.....	23
Tips for Stable Image Shooting	25
■ Recording with the Viewfinder	25
Adjusting the Focus of the VIEWFINDER	25
Reviewing a recording	26
■ Viewing a Still Picture	27
■ Picture Search	27

Advanced Shooting

Zooming In and Out	28
Digital Zoom	29
EASY mode (for beginners)	31
CUSTOM-Creating your own customized recording settings.....	32

Table of Contents (continued)

DIS (Digital Image Stabilizer, VP-W87/W87D only)	33
MF/AF (Manual Focus/Auto Focus).....	34
BLC.....	35
Program AE (Automatic Exposure)	36
DSE (Digital Special Effects) in CAMERA mode	38
Setting and Recording the DATE/TIME	40
Selecting and Recording a Title	42
Fade In and Out	44
PIP (VP-W87/W87D only)	45
Snap Shot (VP-W87/W87D only)	46
White Balance	47
Demonstration	48
Setting the Date/TITLE Colour	49
Lighting Techniques.....	50

Playing back the Tape

To watch on a TV monitor.....	51
Various Functions in PLAYER mode	53
DSE in PLAYER mode	54

Maintenance

Cleaning and Taking care of the Camcorder.....	54
■ Cleaning the Viewfinder	54
■ Cleaning the Video Heads	55
■ Storing the Camcorder.....	55

Using Your Camcorder Abroad.....56

Troubleshooting Check

Self Diagnosis Display.....	57
Checking.....	58
Moisture Condensation	60

Specifications.....61

Index.....62

Power Sources (United Kingdom Only).....64

Precautions and Safety Instructions

Taking care of the battery pack

- ⚠ Do not allow any metal objects to touch the terminals, as this can cause a short circuit and damage the battery pack.

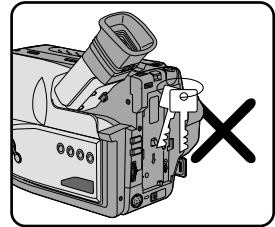

Keep the terminals clean.

- ⚠ The camera, adapter or battery pack will not work properly if the terminals are dirty. Check them before use, and wipe them with a dry cloth or tissue if necessary.

Precautions regarding the LENS

- ⚠ Do not let the LENS point toward the sun. Direct sunlight can damage the CCD.
(*CCD: Charge Coupled Device)

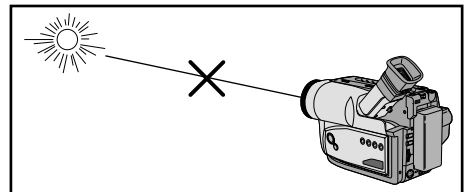

Precautions and Safety Instructions

Precautions regarding electronic viewfinder

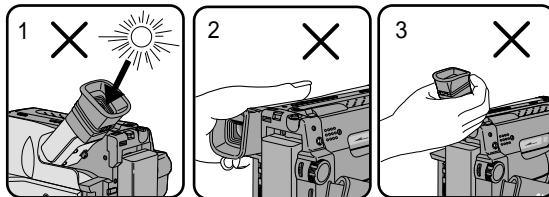

- 1) Do not place the camcorder such that the viewfinder is pointing towards the sun.
Direct sunlight can damage the inside of the viewfinder. Be careful when placing the camcorder in direct sunlight or by a window.
- 2) Do not pick up the camcorder by the viewfinder.
- 3) Do not over rotate the viewfinder as this could damage it.



Precautions regarding moisture condensation

- 1) A sudden change in air temperature may cause moisture to form inside the camcorder.

for example:

- When you take the camcorder from cold temperatures outside to warm temperatures inside during the winter.
 - When you take the camcorder from cool temperatures inside to hot temperatures outside during the summer.
- 2) If the “DEW ()” protection feature activates, leave the camcorder in a dry and warm room with the cassette compartment open and the battery removed.
 - 3) If the “DEW ()” protection feature activates unexpectedly, and you want to override it, disconnect and reconnect both the battery pack and the lithium battery.
Make sure that any moisture or condensation has disappeared completely before you use the camera. (see page 60)

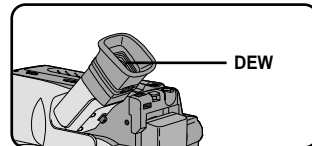

Precautions and Safety Instructions

Precautions regarding the battery pack

- ⌘ Make sure that the battery pack is charged before shooting outdoors.
- ⌘ To preserve battery power, keep your camcorder turned off when you are not operating it.
- ⌘ When your camcorder is in CAMERA mode, if it is left in STANDBY for more than 5 minutes without operation, it will automatically turn off to protect against unnecessary battery discharge.
- ⌘ Make sure that the battery pack is locked in place before carrying.
Dropping the battery pack might damage it.
- ⌘ When the battery reaches the end of its life please contact your local dealer. The batteries have to be dealt with as chemical waste.

Precautions regarding the Lithium battery

Warning: Keep the LITHIUM BATTERY out of the reach of children. Should the battery be swallowed, consult a doctor immediately.

- ⌘ The lithium battery maintains the clock function, TITLE, CUSTOM function and preset contents memory; even if the battery pack or AC power adapter is removed.
- ⌘ The lithium battery for the camcorder lasts about 8–10 months under normal operation from time of installation.
- ⌘ When the lithium battery becomes weak or dead, the date/time indicator flashes about 5 seconds when you set the power switch to CAMERA. In this case, replace the lithium battery with type CR2025. (see page 17)

WARNING:

LITHIUM BATTERY MUST BE
RECYCLED OR DISPOSED
OF PROPERLY.



*When the lithium battery becomes weak or dead please contact your local dealer. The batteries have to be disposed of as chemical waste.

Precautions and Safety Instructions

Precautions regarding the hand strap

- ⌘ It is very important to adjust the hand strap correctly to ensure the camera can be held steady. (see page 16)
- ⌘ Do not insert your hand in the hand strap forcibly, as it may result in damage to the buckle.

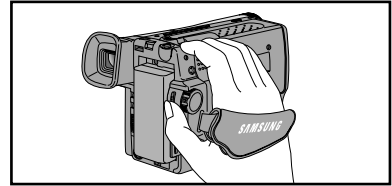

Precautions when cleaning the video heads

- ⌘ To ensure normal recording and clear pictures, ensure that the heads are kept clean. When playing back the pictures, if they are noisy or hardly visible, the video heads may be dirty. If this happens, clean the video heads with a dry type cassette cleaner.
- ⌘ Do not use a wet type cassette cleaner. It may damage the video heads. (see page 55)

Auto-off function in STANDBY mode

- ⌘ To protect against tape and head-drum wear, your camcorder will automatically turn off if it is left in STANDBY mode without operation for more than 5 minutes.

Getting to Know Your Camcorder

Features

Your camcorder has many features available when recording or during playback.

Snap Shot (VP-W87/W87D only)

The Snap Shot function allows you to record an object at a standstill for a limited time in CAMERA mode. (see page 46)

PIP (VP-W87/W87D only)

The PIP function shows where the centre of the image is while zoomed in on a subject. (see page 45)

BLC

When you shoot a subject with the light source behind the subject or a subject with a light background, the BLC function should be switched on. (see page 35)

DSE (Digital Special Effects)

The DSE allows a creative look to your films by adding various special effects. (see page 38)

Program AE (Auto Exposure)

The Program AE allows the shutter speed and aperture to be adjusted to the type of subject being filmed. (see page 36)

DIS (VP-W87/W87D only)

The DIS compensates for unstable images caused by hand shake, particularly at high magnification. (see page 33)

22x High ratio zoom lens

Zooming is a recording technique that lets you change the size of the subject in the picture. For more professional recordings, use the zoom function. (see page 28)

Digital Zoom

Zooms more than 22x are performed digitally. (see page 29)

Macro

The macro function allows you to shoot your subject at close range. You have to adjust the zoom fully wide for macro shooting. (see page 28)

EASY

This mode enables even the beginner to easily make a recording. (see page 31)

Getting to Know Your Camcorder

Front View

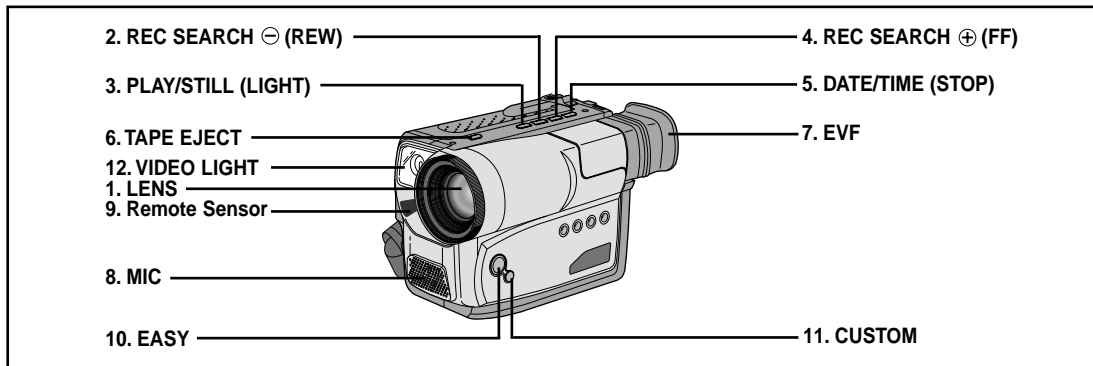

1. **Lens** (see page 61)
2. **REC SEARCH ⊖ (REW)**
REC SEARCH ⊖ works in STANDBY mode.
(see page 24)
REW works in PLAYER mode. (see page 53)
3. **PLAY/STILL (LIGHT)** (see page 52)
PLAY/STILL works in PLAYER mode.
LIGHT works in Camera mode.
(VP-W87/W87D only)
4. **REC SEARCH ⊕ (FF)**
REC SEARCH ⊕ works in STANDBY mode.
(see page 24)
FF works in PLAYER mode. (see page 53)
5. **DATE/TIME (STOP)**
DATE/TIME works in CAMERA mode. (see page 40)
STOP works in PLAYER mode. (see page 52)
6. **TAPE EJECT** (see page 22)
Used to eject the tape.
7. **EVF (Electronic Viewfinder)**
8. **MIC**
MIC works in CAMERA mode.
9. **Remote sensor**
(VP-W87/W87D only, see page 15)
10. **EASY**
EASY works in CAMERA mode.
11. **CUSTOM**
CUSTOM works in CAMERA mode.
12. **VIDEO LIGHT (VP-W87/W87D only)**

Getting to Know Your Camcorder

Side View

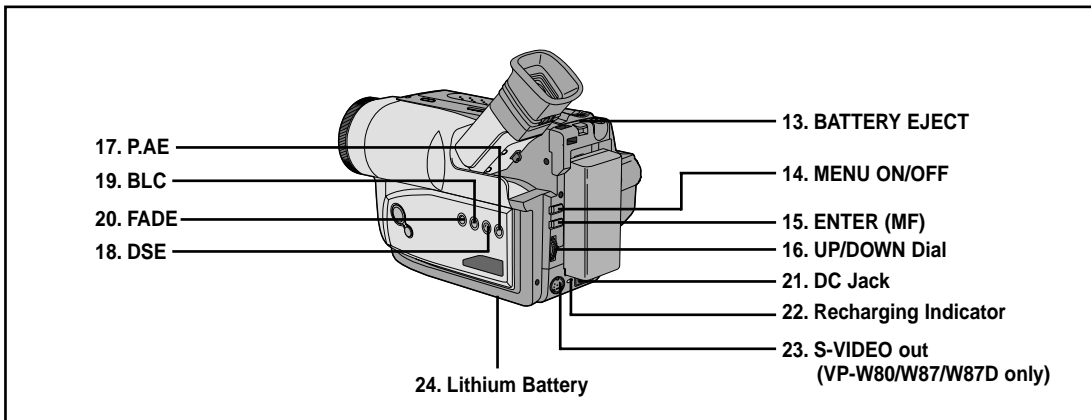
**13. BATTERY EJECT**

14. MENU ON/OFF (see page 30)
MENU ON/OFF works in CAMERA and PLAYER mode.

15. ENTER (MF) (see page 30)
ENTER works in MENU mode.
MF works in CAMERA mode.

16. UP/DOWN dial (see page 30)
UP/DOWN dial works in MENU mode.

17. PROGRAM AE (see page 36)
PROGRAM AE (Auto Exposure) works in CAMERA mode.

18. DSE (see page 38)
DSE works in CAMERA and PLAYER mode.

19. BLC (see page 35)
BLC works in CAMERA mode.

20. FADE (see page 44)
FADE works in CAMERA mode.

21. DC Jack (see page 18)

22. Recharging Indicator (see page 19)

23. S-VIDEO out (VP-W80/W87/W87D only)

24. Lithium Battery (see page 17)

Getting to Know Your Camcorder

Rear View

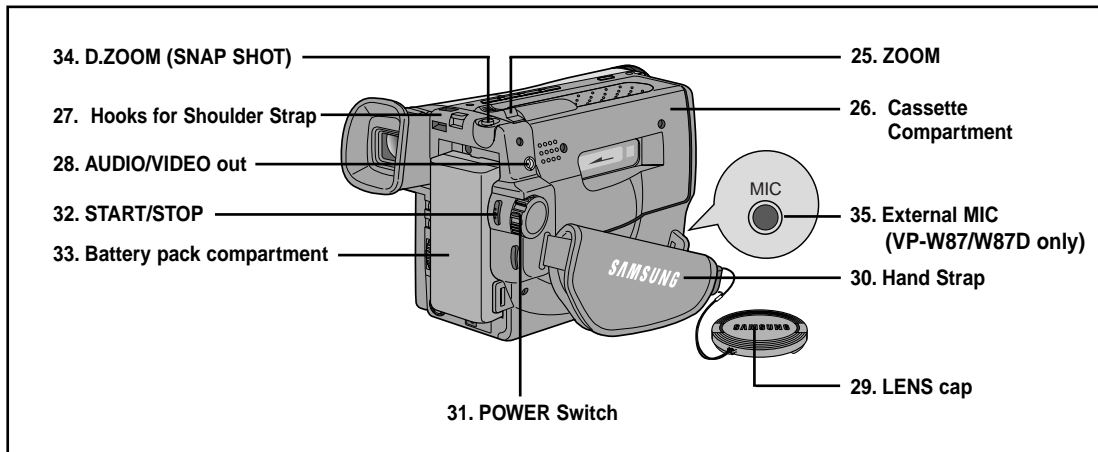

25. ZOOM (see page 28)

26. Cassette Compartment

27. Hooks for Shoulder Strap (see page 17)

28. AUDIO/VIDEO out (see page 51)

29. LENS cap

30. Hand Strap (see page 16)

31. POWER Switch (see page 18)

- CAMERA : Select to record.
- OFF : Select to turn off the camcorder.
- PLAYER : Select to playback.

32. START/STOP (see page 23)

START/STOP works in CAMERA mode.

33. Battery pack compartment (see page 19)

34. D.ZOOM (SNAP SHOT)

D.ZOOM works in CAMERA mode.
 (VP-W80U/W80 only, see page 30)
 SNAP SHOT works in CAMERA mode.
 (VP-W87/W87D only, see page 46)

35. External MIC (see page 61)
(VP-W87/W87D only)

Getting to Know Your Camcorder

OSD (On Screen Display)

- ☞ You can turn the OSD on/off by setting the Display menu on/off.
- ☞ The TITLE, DATE/TIME, EASY and CUSTOM functions can be operated even after the OSD is turned off.
- ☞ The OSD is displayed in the viewfinder and the monitor.

a. Zoom position (see page 29)

Indicates zoom position.

b. DIS (VP-W87/W87D only) (see page 33)

Indicates DIS is activating.

c. Battery level (see page 21)

Indicates the power left in the battery.



d. Manual Focus (see page 34)

Indicates manual focus is on.
Auto Focus is not displayed.

e. BLC (see page 35)

Indicates BLC is activating.

f. Program AE (see page 36)

Indicates Program AE mode is activating.



g. Self record waiting timer. (VP-W87/W87D only) (see page 15)

Indicates 10 seconds timer.

h. Self record recording timer. (VP-W87/W87D only) (see page 15)

(30 seconds or END).

i. Date (see page 40)

Displays the date of the recording.

OSD in CAMERA mode

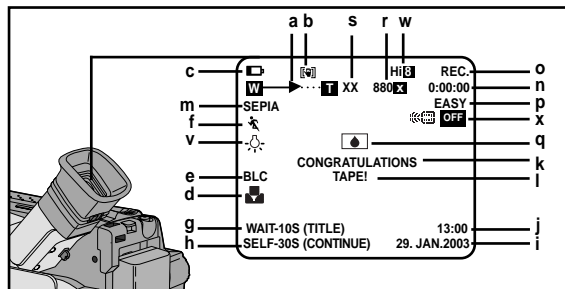

OSD in PLAYER mode

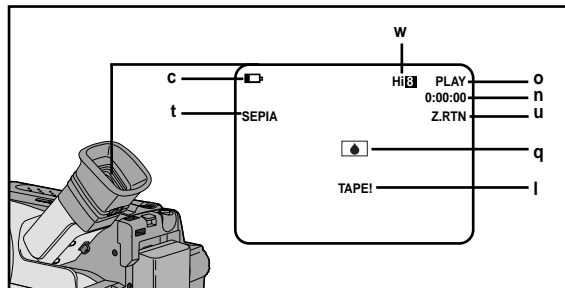

Getting to Know Your Camcorder

OSD (On Screen Display)

- j. **Time (see page 40)**
Shows the time of the recording.
- k. **Title (see page 42)**
Shows the title of the recording.
It is superimposed on the scene.
- l. **Self diagnosis (see page 57)**
(TAPE!, TAPE END!, PROTECTION!) Checks the operation of the Camcorder.
- m. **DSE (Digital Special Effect) (see page 38)**
Indicates the DSE mode is active.
The operation modes are GHOST, STROBE, SEPIA, B&W, NEG., MIRROR, ART, MOSAIC, 16:9 (WIDE) and CINEMA.
- n. **Tape counter**
Shows amount of the tape used.
- o. **Operation mode**
Indicates depending on which operating mode is active.
The operation modes are STBY, REC (●), STOP, PLAY(▶), FF(▶▶), REW(◀◀), EJECT.
- p. **EASY & CUSTOM**
Shows when the EASY or CUSTOM mode is active.
- q. **DEW ([]) condensation (see page 60)**
Visible if moisture or condensation is detected within the camera.
- r. **Digital zoom (see page 29)**
Shows the digital zoom is active.
- s. **Snap Shot (VP-W87/W87D only) (see page 46)**
Shows the remaining available time for Snap Shot recording.
- t. **PB DSE (see page 54)**
Shows that the PB DSE mode is active.
- u. **Zero return (VP-W87/W87D only) (see page 53)**
Shows that the zero return function is active.
- v. **White Balance mode (see page 47)**
Shows which White Balance mode is active.
The White Balance modes are AUTO, INDOOR(☀), and OUTDOOR(☀).
- w. **Hi8 (VP-W80/W87/W87D only)**
Indicates the use of the Hi8 tape in CAMERA or PLAYER modes.
In case of not being tape, display Hi8 on the screen in CAMERA or PLAYER modes.
- x. **Remocon ([] OFF) (VP-W87/W87D only)**
Indicates the remocon off mode is activated.





Getting to Know Your Camcorder

Accessories Supplied with Camcorder

Make sure that the following basic accessories are supplied with your camcorder.

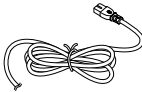
Basic Accessory

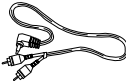
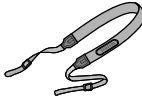
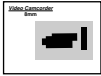
1. AC Power Adapter. (see page 18)
2. AC cord. (see page 18)
3. Battery Pack. (see page 19)
4. Audio/Video Cable. (see page 51)
5. Shoulder strap. (see page 17)
6. Instruction Book.
7. Remote Control.
8. Lithium Battery for Remote Control.
(VP-W87/W87D only, see page 15)
8. Lithium Battery for Clock.
(VP-W87/W87D only, see page 15)
- Lithium Battery for Clock.
(TYPE: CR2025, see page 17)

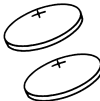
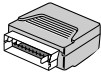
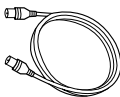
<p>1. AC Power Adapter</p> 	<p>2. AC cord</p> 	<p>3. Battery Pack</p> 
<p>4. AUDIO/VIDEO Cable</p> 	<p>5. Shoulder Strap</p> 	<p>6. Instruction Book</p> 
<p>7. Remote Control</p> 	<p>8. Lithium Batteries</p> 	
<p>9. Scart adapter</p> 	<p>10. S-VIDEO Cable</p> 	

Optional Accessory

9. Scart adapter. (see page 51)
10. S-VIDEO cable
(VP-W80/W87/W87D only, see page 52)

Note: Optional accessories may be included with the camcorder, depending on the country in which it is purchased.

Getting to Know Your Camcorder

Remote Control (VP-W87/W87D only)

Description of Parts

1. Start/Stop (see page 23)
2. Self Timer
3. Still (see page 53)
4. WIDE (see page 28)
5. TELE (see page 28)
6. Display (see page 12)
7. ► (Play) (see page 52)
8. ►► (FF) (see page 53)
9. ◀◀ (REW) (see page 53)
10. ■ (Stop) (see page 52)
11. Counter Reset (see page 53)
12. Zero Return (see page 53)

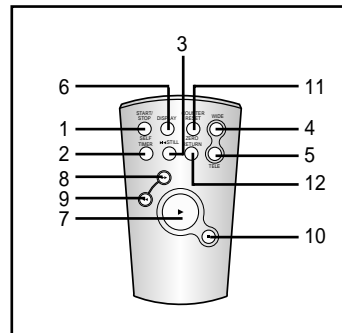

Battery Installation to the Remote Control

- ⚠ You must insert or replace this battery when:
 - You purchase the camcorder.
 - The remote control doesn't work.
- ⚠ Insert Lithium Battery, following the + and - markings.
- ⚠ Be careful not to reverse the polarity of the battery.

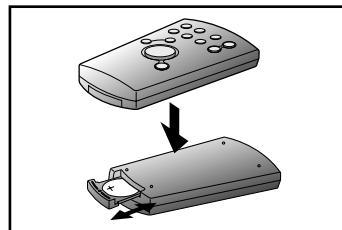

Self Recording with the Remote Control

- ⚠ The Self Timer function on the remote control allows you to start and stop recording automatically.

Example: recording yourself

- ⚠ Two options are available
 - WAIT-10S/SELF-30S: wait 10 seconds, followed by 30 seconds of recording.
 - WAIT-10S/SELF-END: wait 10 seconds, followed by recording until you press the START/STOP button again.

Preparing

1. Set power switch to CAMERA.

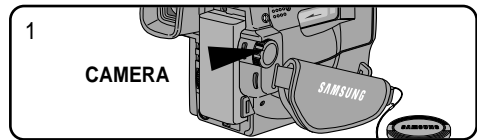

2. Press Self Timer button until the appropriate indicator is displayed on the Viewfinder:

- WAIT-10S/SELF-30S
- WAIT-10S/SELF-END

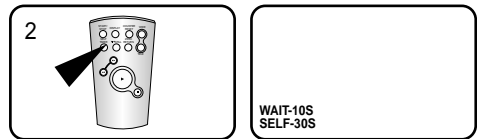

3. Press START/STOP button to start the timer.

:After approximately 10 seconds, recording starts.

:If you have selected SELF-30S, recording stops automatically after 30 seconds.

:If you have selected SELF-END, press the START/STOP again when you wish to stop recording.

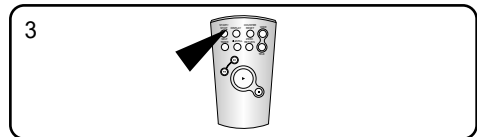

Note: When using the timer, pressing the START/STOP button again, cancels the function.

Adjusting the Hand Strap and Shoulder Strap

Hand Strap

- ⚙ It is very important to adjust the hand strap correctly to ensure the camera can be held securely.
- ⚙ The hand strap enables you to:
 - Hold the camcorder in a stable, comfortable position.
 - Press the Zoom and the red Record button without having to change the position of your hand.

1. Pull open the Hand Strap cover and release the Hand Strap, adjust its length and stick it back onto the Hand Strap cover.
2. Close the Hand Strap cover when finished.

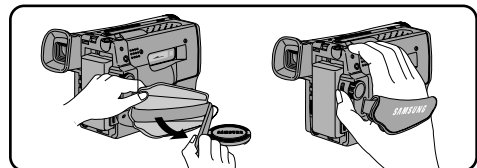

Preparing

Shoulder Strap

⌘ The Shoulder Strap allows you to carry your camcorder with complete safety.

1. Insert each end of the strap into the hooks on the camcorder.
2. Put the end of each strap through the buckle, adjust the length of the strap, then pull it tight in the buckle.

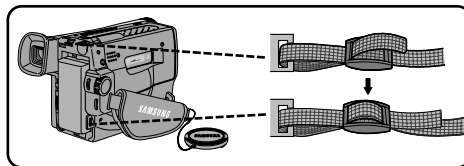

Lithium Battery Installation

- ⌘ The lithium battery maintains the clock function, title and preset contents of the memory; even if the battery pack or AC power adapter is removed.
- ⌘ The lithium battery for the camcorder lasts about 8~10 months from the time of installation under normal operation.
- ⌘ When the lithium battery becomes weak or dead, the date/time indicator flashes about 5 seconds when you set the power switch to CAMERA.
In this case, replace the lithium battery with type CR2025 Lithium button cell.

1. Remove the Lithium battery holder from the base of the camera.
2. Insert the ⊕ side of the lithium battery toward the bottom of the holder.
3. Reinsert the lithium battery holder into the slot on the base of the camera.

Note: The battery holder will only fit one way to avoid possible incorrect insertion.

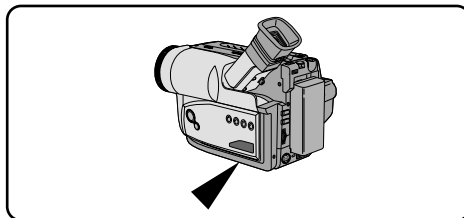

Warning: Keep LITHIUM BATTERIES out of the reach of the children. Should any battery be swallowed, consult a doctor immediately.

Preparing

Connecting a Power Source

- ⌘ There are two types of power source available.
- Using the AC Power Adapter : used for indoor recording.
 - Using the Battery Pack: used for mobile recording.

To use the AC Power Adapter

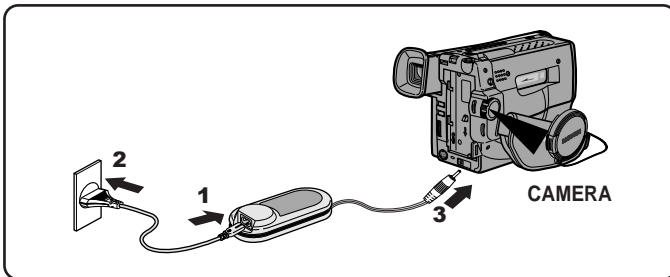

1. Connect the AC Power Adapter to a AC cord.
2. Connect the AC cord to a wall socket.
Note: The plug and wall socket type can be different according to the regional conditions.
3. Connect the other end of the DC cable to DC jack of the camcorder.
4. To set the camcorder to CAMERA mode.
 - a. Hold down the tab of the power switch and push the switch to CAMERA mode.
 - b. Make sure that the Lens Cap is opened.
 - c. Make sure that the image appears in the Viewfinder.

Note: If the adapter is used next to the TV or the camcorder, it may cause the TV or camcorder to emit noise. Move the adapter away from the TV, camcorder or the antenna cable.

Preparing

To use the Battery Pack

How long will the battery last for recording?

⌘ Depends on how often you are likely to use the zoom feature during recording.

Recharging the Battery Pack

1. Attach the battery pack to the camcorder.

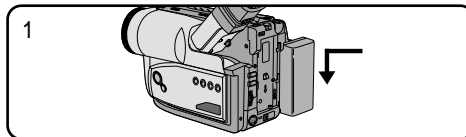

2. Connect the AC Power Adapter to a AC cord and plug the AC cord into a wall socket.

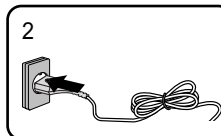

3. Connect the DC cable to the camcorder.

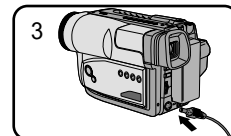

4. Turn the power off on the camcorder, and the recharging indicator will start flashing, indicating the battery is charging.

- Flashing once a second : the battery is less than 50% charged.
- Flashing twice a second : the battery is between 50% ~ 75% charged.
- Flashing three times a second : the battery is between 75% ~ 100% charged.
- Constantly stays on : Charging is complet.
- On for a second and off for a second : there is an error and the charger needs to be reset.

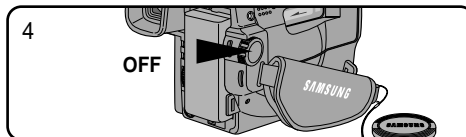

5. If recharging is completed, separate the camcorder, AC power adapter, and battery pack.

- Even if the power is turned off, the battery will still discharged over time if left connected to the camera.

Note: Battery pack may be charged a little at the time of purchase.

Preparing

Using the Battery Pack

Table of approximate continuous recording time based on model and battery type

Model Battery Type	VP-W80U/W80	VP-W87/W87D
SB-L110A	Approximately 150 minutes	Approximately 125 minutes
SB-L160	Approximately 220 minutes	Approximately 180 minutes
SB-L320	Approximately 430 minutes	Approximately 370 minutes

⌘ The continuous recording times given in the table are approximate. Actual recording time may differ dependent on camera settings and usage.

Notes:

- ⌘ The battery pack should be recharged in a room temperature that is between 0°C and 40°C. It should never be charged in a room temperature that is below 0°C.
- ⌘ The life and capacity of the battery pack will be reduced if it is used in temperatures below 0°C, even when it is fully recharged.
- ⌘ The life and capacity of the battery pack will be reduced if the battery pack is left in temperatures above 40°C for a long period, even when it is fully recharged.
- ⌘ Do not put the battery pack near any heat source (fire or flames, for example), or left in direct sunlight.

Preparing

Battery Level display

⌘ The battery level display indicates the amount of power remaining in the battery pack.

1. Fully charged
2. 10~45% consumed
3. 45~70% consumed
4. 70~90% consumed
(prepare a charged one)
5. 90~95% consumed
(change the battery)
6. 100% consumed
(camcorder will turn off soon, change the battery as soon as possible)

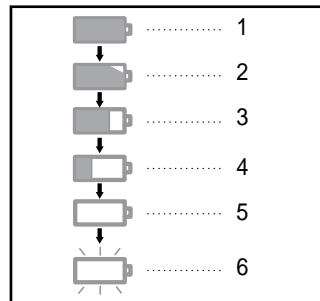

⌘ Please refer to the table on page 20 for approximate continuous recording times.

⌘ The recording time is affected by environmental temperature and conditions. The recording time becomes very short in a cold environment. The continuous recording time in the operating instructions is measured using a fully charged battery pack in 77°F(25°C). As environmental temperatures and conditions may be different when you actually use the camcorder, the remaining battery time may not be the same as the approximate continuous recording times given in these instructions.

Tips for Battery Identification.

A charge mark is provided on the battery pack to help you remember whether it has been charged or not.

Two colours are provided (red and black)-you may choose which one indicates charged and which indicates discharged.

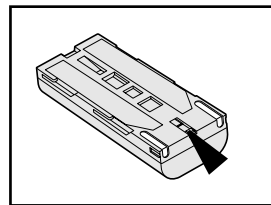

Preparing

Inserting and Ejecting a Cassette

- ⚠ There are several cassette types, depending on:
- Colour system used
 - Recording/Playback time
 - Hi8/8mm (VP-W80/W87/W87D is Hi8)

Inserting and Ejecting a Cassette

- ⚠ Check to see if the battery pack is in place or AC adapter is connected.
1. **Press the EJECT button for Ejecting the Cassette Holder.**
 - The compartment opens automatically.
 - Insert the cassette with the transparent window facing outward and the protection tab toward the top.
 2. **Press the are labelled 'PUSH' until the compartment clicks into place.**

Note: When you have recorded a cassette that you wish to keep, you can protect it from being accidentally erased.

a. Protecting a recording:

Slide the red tab on the cassette so that it covers the hole.

b. Unprotecting a recording:

If you no longer wish to keep the recording on the cassette, slide the red tab back so that it no longer covers up the hole.

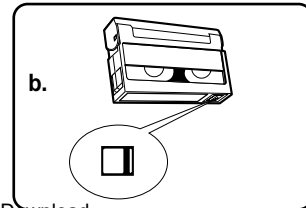
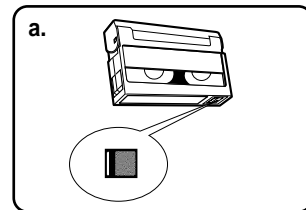
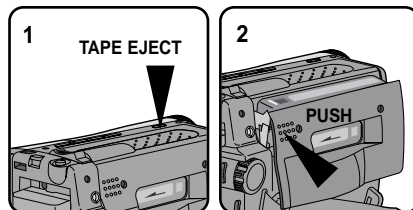

Basic Shooting

Making the First Recording

Please check the following before recording.

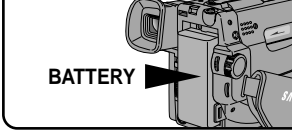
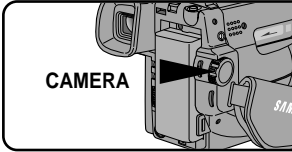
- Have you connected a power source?
(Battery Pack or AC Power Adapter)
- 
- Have you set the power switch to the CAMERA position?
- 
- Have you inserted a cassette? (see page 22)
 - Make sure that STANDBY is displayed in the OSD (if the red tab of the cassette is covering the hole, STANDBY will not be displayed)
 - Have you removed the LENS CAP?
 - Make sure that the image you want to record is visible in the Viewfinder.
 - Make sure that there is enough remaining power for the expected recording time. (see page 21)
 - We recommend that beginners, who are using the camcorder for the first time, switch the EASY mode on.
- a. To start recording, press the red START/STOP button.
Recording starts and REC is displayed in the Viewfinder.

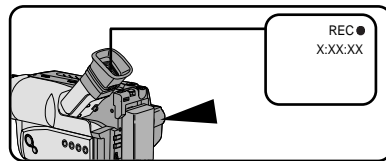

Basic Shooting

- b. To stop recording, press the red START/STOP button again.
When recording stops, STANDBY will be displayed on the Viewfinder.

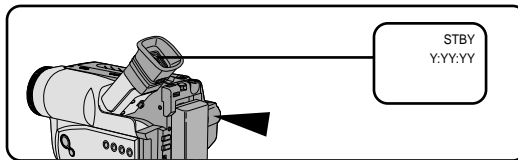

When a cassette is loaded and the camcorder is left in STANDBY mode for over 5 minutes without being used, it will turn off automatically. To use it again, push the red START/STOP button or set power switch to OFF and then back to CAMERA. This Auto Power Off feature is designed to save battery power and to protect the Tape Head and tapes.

REC SEARCH

- ⌘ You can view a recorded picture with REC SEARCH ⊕, ⊖ function in STANDBY mode. REC SEARCH ⊖ allows you to reverse and REC SEARCH ⊕ allows you to forward, for as long as you keep the button pressed.
- ⌘ If you press REC SEARCH ⊖ button briefly in STANDBY mode, your camcorder will playback in reverse for 3 seconds and return to the original position automatically.

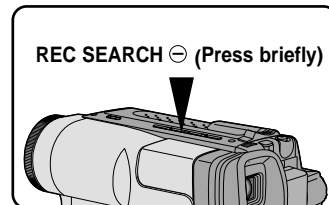
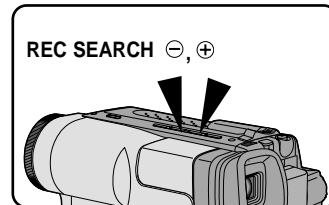

Basic Shooting

Tips for Stable Image Shooting

- While recording, it is very important to hold the camcorder correctly.
- To avoid the risk of the lens cap appearing in your shot, always clip it onto the hand strap. (refer to figure)

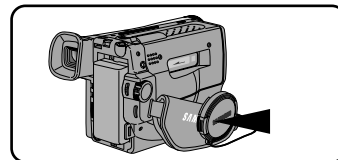

Recording with the Viewfinder

1. Hold the camcorder firmly with the hand strap. (see page 16)
2. Place your right elbow against your side.
3. Place your left hand under the camcorder to support it.
Be sure to not touch the built-in microphone.
4. Choose a comfortable, stable position for the shots.
You can lean against a wall or on a table for greater stability.
Do not forget to breathe gently.
5. Put your eye firmly against the eyepiece.
6. Use the viewfinder frame as a guide to determine the horizontal plane.
7. Whenever possible, use a tripod.

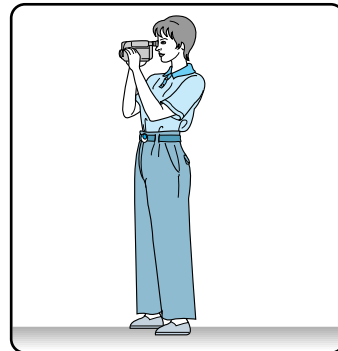

Adjusting the Focus of the VIEWFINDER

Focus:

Slide the focus adjustment knob on the bottom of the VIEWFINDER to focus the image.

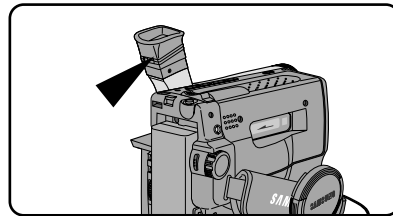

Basic Shooting

Reviewing a recording

☞ You can review your recording on the Viewfinder.

1. Hold down the tab of the power switch and select PLAYER mode.
2. Insert the tape you wish to view.
3. Make sure that STOP is displayed in the OSD.
4. Press the ◀◀ (REW) button to rewind the tape to the beginning.
 - To stop REWIND, press the ■ (STOP) button.
 - Camcorder stops automatically after rewinding.
5. Press the ▶▶ (PLAY/STILL) button to start playback.
 - You can see the video you shot in the Viewfinder.
 - To stop the PLAY operation, press the ■ (STOP) button.

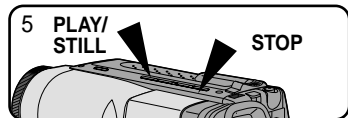
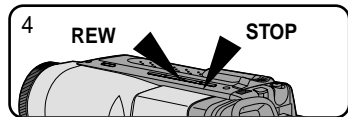
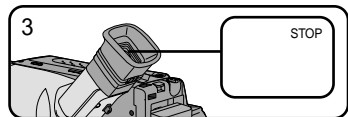
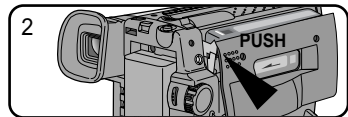
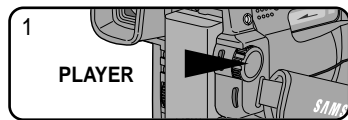

Note: You can also watch it on a TV screen, once connecting the camcorder to a TV or VCR. (see page 51)

Basic Shooting

Viewing a Still Picture

- Press ►|| (PLAY/STILL) button during playback.
- To resume playback, press the ►|| (PLAY/STILL) button again.

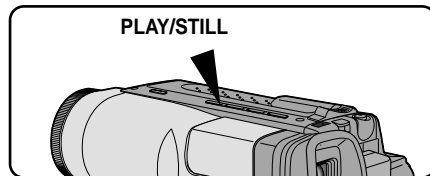

Picture Search

- Press and hold ►► (FF) or ◀◀ (REW) button during playback.
- To resume normal playback, release the button.

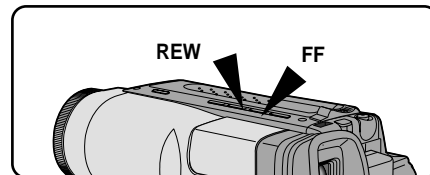

Advanced Shooting

Zooming In and Out

- ⌘ Zoom works in CAMERA mode only.
 - ⌘ Zooming is a technique that allows you to increase or decrease the size of the subject in the picture.
For a more professional looking recording, don't use the zoom function too often.
 - ⌘ You can also choose from two zoom speeds to suit different needs:
 - Gradual zoom (9~12 seconds from WIDE/TELE to WIDE/TELE)
 - High-Speed zoom (3~6 seconds from TELE/WIDE to WIDE/TELE)
 - ⌘ Use these features for different shots; Please note that over use of the zoom feature can lead to a reduction of battery pack usage time.
1. Move the zoom lever a little for a gradual zoom, move it further for a high-speed zoom.
Your zooming is monitored on the OSD.

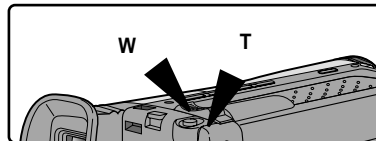

2. T (Telephoto) side:
Subject appears closer.

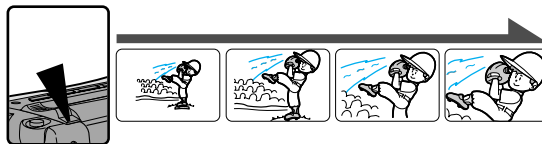

3. W (Wide angle) side:
Subject appears further away.



Note: MACRO

If you cannot get a sharp focus in telephoto zoom, move the lever to the "W" side until the focus is sharp. You can shoot a subject that is at least 1 mm away from the lens surface in the wide angle position.

Advanced Shooting

Digital Zoom

- ⌘ Digital Zoom works in CAMERA mode only.
- ⌘ Zooming more than 22x is achieved using digital technology.
- ⌘ The picture quality deteriorates as you go towards the “T” side.
- ⌘ It is recommended that you use the DIS (VP-W87/W87D) feature with the DIGITAL ZOOM for picture stability. (see page 33)

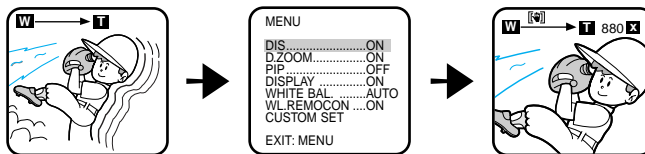

1. Set the power switch to CAMERA mode.
2. Make sure that the DIGITAL ZOOM feature is switched on. (see page 30)
3. When you move the ZOOM lever to “T” side, the picture will increase in size upto a maximum of 880 times. (VP-W87D: 990x)

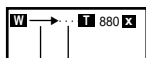

- shows the digital zoom area
- shows the optical zoom area

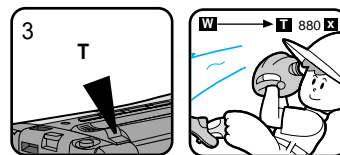

4. If you do not want to use the DIGITAL ZOOM, set the DIGITAL ZOOM function to OFF in the MENU list. (see page 30)

Advanced Shooting

Setting the DIGITAL ZOOM ON/OFF (VP-W87/W87D)

⌘ The DIGITAL ZOOM feature is explained on page 29.

1. Set power switch to CAMERA mode.
2. Press the MENU ON/OFF button.
 - The MENU list will appear.
3. Turn the UP/DOWN dial to D. ZOOM.
4. Press ENTER.
 - The DIGITAL ZOOM setting will change.
5. Press the MENU ON/OFF button to end setting.

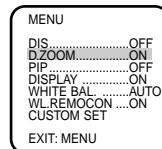
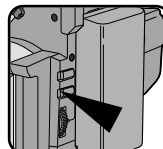
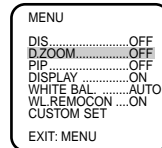
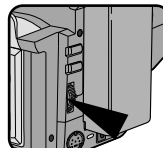
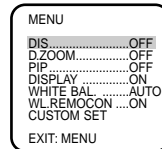
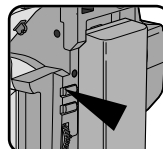

In case of VP-W80U/W80

1. Set the power switch to CAMERA mode.
2. Press the D. ZOOM ON/OFF button.
 - The DIGITAL ZOOM will be displayed on the screen, and the DIGITAL ZOOM function will operate.
3. To deactivate DIGITAL ZOOM function, press the D.ZOOM button again.
 - The DIGITAL ZOOM indicators disappear from the screen.

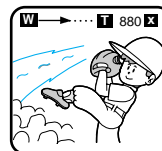
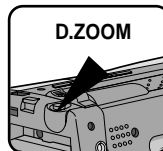

Note: The D. ZOOM ON/OFF function will not operate in EASY mode.

Advanced Shooting

EASY Mode (for Beginners)

- ⌘ Even a beginner can easily make a recording using the EASY mode.
 - The EASY mode only operates in CAMERA mode.
1. Set the power switch to CAMERA mode.
 2. By pressing the EASY button, all the functions of the camera will be set to off and the recording settings will be set to the following basic mode.
 - Battery level, recording mode, counter, date/time, DIS ([EASY]) will be displayed as the camcorder starts to run.
 - The word "EASY" will appear in the Viewfinder at the same time. However, the Date/Time will only be seen if it has been previously set. (DIS ([EASY]) will be displayed on VP-W87/W87D only)
 3. Press the START/STOP button to start recording.
 - Recording will begin using the basic automatic environment settings.
 4. Pressing the EASY button again turns the EASY mode off.
 - The camera will return to the settings that were set prior to the EASY mode being switched on.

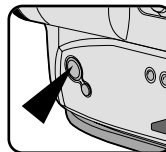
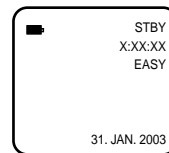
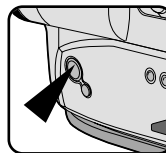

Notes:

- In the EASY mode, the MENU, MF, DSE, P.AE and BLC functions are not available.
- If you want to use these functions, you must first switch the EASY mode off.
- The EASY settings will be stored in the camera (providing a good lithium battery has been installed).

Advanced Shooting

CUSTOM-Creating your own customized recording settings

- ☞ You can customize the settings and save them for future use.
 - The CUSTOM function only operates in CAMERA mode.
1. Set the power switch to CAMERA mode.
 2. Press the MENU ON/OFF button, to bring up the MENU list.
 3. Turn the UP/DOWN dial until CUSTOM SET is highlighted.
 4. Press the ENTER button, the CUSTOM menu will appear.
 - Set the status of each item to what you want.
 5. To exit the menu, press the MENU ON/OFF button twice.
 6. By pressing the CUSTOM button, the CUSTOM settings will come up.
 - Date/Time and Title will only appear if these have been set in advance.
 - The word "CUSTOM" will be displayed on the Viewfinder at the same time.

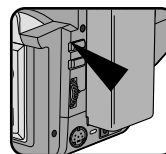

```

MENU
DIS.....OFF
D.ZOOM.....OFF
PIP.....OFF
DISPLAY.....ON
WHITE BAL.....AUTO
WL.REMOCON...ON
CUSTOM SET
EXIT: MENU
    
```

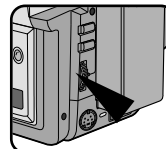

```

MENU
DIS.....OFF
D.ZOOM.....OFF
PIP.....OFF
DISPLAY.....ON
WHITE BAL.....AUTO
WL.REMOCON...ON
CUSTOM SET
EXIT: MENU
    
```

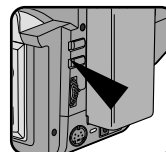

```

CUSTOM SETTING
DIS.....ON
PIP.....OFF
D.ZOOM.....OFF
WHITE BAL.....AUTO
DATE/TIME.....OFF
PROGRAM AE.....OFF
DSE SELECT.....OFF
EXIT: MENU
    
```

Example: When the CUSTOM SET is set as follows;

```

CUSTOM SETTING
DIS .....ON
PIP .....ON
D.ZOOM .....ON
WHITE BAL.....INDOOR ☆
DATE/TIME .....DATE/TIME
PROGRAM AE .....
DSE SELECT .....B&W
EXIT: MENU
    
```

Pressing the CUSTOM button,
displays

```

[ ] Hi8 STBY
880x 0:00:02
B&W CUSTOM
[ ]
[ ] CONGRATURATION
TITLE 0:00
CONTINUE 1.JAN.2003
    
```

7. Press the START/STOP button to start recording.
 - Recording will begin using the new CUSTOM settings.
8. To switch Custom off, press the CUSTOM button once.
 - The camera will revert to the settings that were set prior to the CUSTOM mode being switched on.

Notes: ■ The CUSTOM settings will be stored in the camera (providing a good lithium battery has been installed).

Advanced Shooting

DIS (Digital Image Stabilizer, VP-W87/W87D only)

- ⌘ The DIS function works in CAMERA mode only.
- ⌘ DIS (Digital Image Stabilizer) is a handshake compensation function that compensates for any shaking or moving of the hand holding the camcorder (within reasonable limits).
- ⌘ It provides more stable pictures when:
 - Recording with the Zoom.
 - Recording a small object close-up
 - Recording and walking at the same time
 - Recording through the window of a vehicle

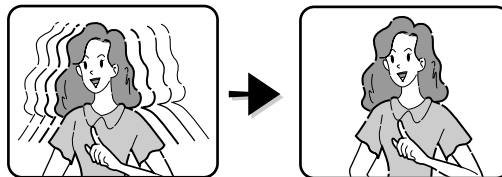

1. Set the power switch to CAMERA mode.
2. Press the MENU ON/OFF button.
 - The MENU list will appear.
3. Turn the UP/DOWN dial until DIS is highlighted.
4. Press ENTER.
 - The DIS setting will change.
5. Press MENU ON/OFF button to end the setting.
 - When the DIS is set, the DIS mark () will displayed on the OSD.

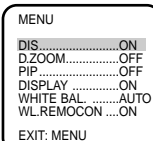
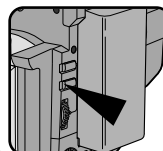
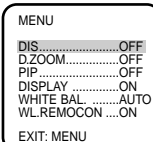
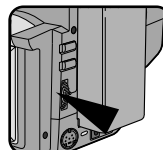
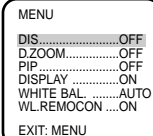
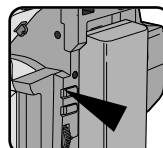

- Notes:**
1. It is recommended to deactivate the DIS function when using a tripod.
 2. The DIS function will not operate in DSE mode.
 3. The MENU ON/OFF function will not operate in EASY mode.

Advanced Shooting

MF/AF (Manual Focus/Auto Focus)

- ⌘ The MF/AF function works in CAMERA mode only.
- ⌘ In most situations, it is better to use the Automatic Focus feature, as it enables you to concentrate on the creative side of your shooting.
- ⌘ Manual focusing may be necessary under certain conditions that make automatic focusing inadequate.

Auto Focusing

- ⌘ The AF (Auto Focus) mode is set automatically when you switch on the Power switch.
- ⌘ If you are inexperienced with camcorders, we recommend that you use the Auto Focus mode.

Manual Focusing

- ⌘ In the following situations, you should obtain better results by adjusting the focus manually.
 - a. A picture containing several objects, some close to the camcorder, others further away.
 - b. A person enveloped in fog or surrounded by snow.
 - c. Very shiny or glossy surfaces like a car.
 - d. People or objects moving constantly or quickly like an athlete or crowd.
1. Set the power switch to CAMERA mode.
 2. Press the MF button.
The MF symbol will appear in the viewfinder.
 3. Zoom in on the subject to be shot by pushing the ZOOM tab to the "T" side.

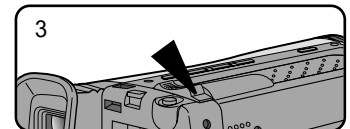
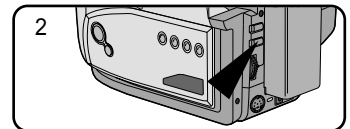

Advanced Shooting

4. Turn the UP/DOWN dial up or down until the object is focused.
5. If the picture won't focus, zoom out until it becomes clear.

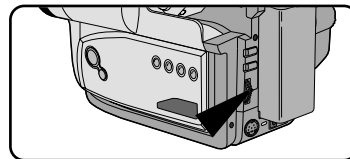

6. To return to AF(Auto Focus), press the MF button again.
The MF symbol will disappear from the viewfinder.

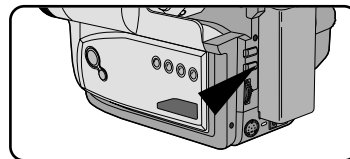

Note: The MF function will not operate in EASY mode.

BLC

BLC works in CAMERA mode.

Back lighting exists when the subject is darker than the background, such as when:

- The subject is placed in front of a window.
- The person to be shot is wearing white or shiny clothes and is placed against a bright background; the person's face is too dark to distinguish their features.
- The subject is outdoors and the background is overcast.
- The light source is too bright.
- The subject is against a snowy background.

* BLC off

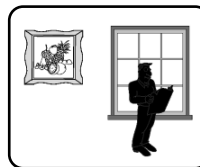

* BLC on

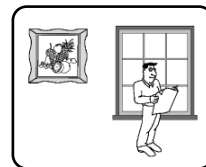

1. Set the power switch to CAMERA mode and press the BLC button.
 - Normal - BLC - Normal (BLC enhances only the subject).

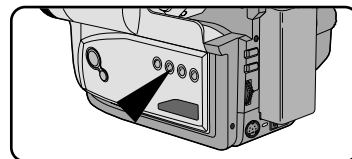

Note: BLC function will not operate in P.AE or EASY mode.

Advanced Shooting

PROGRAM AE (Automatic Exposure)

- ⌘ The PROGRAM AE function works in CAMERA mode only.
- ⌘ The PROGRAM AE modes allow you to adjust shutter speeds and apertures to suit different recording conditions.
- ⌘ There are 6 automatic exposure modes.

1. AUTO mode

- Auto balance between the subject and the background.
- Used in normal conditions.
- The shutter speed automatically varies from 1/50 to 1/250 second, depending on the picture.

2. SPORTS mode ()

- For shooting people or objects moving quickly; you should be able to play back the picture in slow motion on an 8 mm VCR or stop on a given image with very little blur.

3. PORTRAIT mode ()

- For focusing on the subject and not the background.
The PORTRAIT mode is most effective when used outdoors.
- The shutter speed automatically varies from 1/50 to 1/1000 second, depending on the picture.

4. SPOTLIGHT mode ()

- To shoot correctly when there is only light on the subject and not the rest of the picture.
- The shutter speed is 1/50 second.

5. SAND/SNOW mode ()

- For shooting when the people or objects are darker than the background because of reflected light from sand or snow.
- The shutter speed automatically varies from 1/50 to 1/250 second, depending on the picture.

6. HSS (High Speed Shutter) mode ()

- For shooting fast-moving subjects such as the players in golf or tennis games.
- You may need to light the shooting area.

Advanced Shooting

Setting the PROGRAM AE (Automatic Exposure) mode

1. Set the power switch to CAMERA mode.
2. Press the P.AE button, the () symbol will be displayed.
3. Press the P.AE button until the appropriate symbol is displayed.

( →  →  →  → )

■ No Display : Full Auto mode.

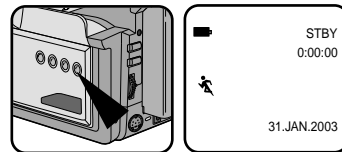

Notes:

- The P.AE mode chosen will be recorded on the tape.
- To end the P.AE function, press the P.AE button once or several times, until the P.AE Icon is no longer displayed.
- The P.AE function will not operate in EASY or CUSTOM mode.
- The BLC function will not operate in P.AE mode.

Advanced Shooting

DSE (Digital Special Effects) in CAMERA mode

- ⌘ The digital effects enable you to give a creative look to your recording by adding various special effects.
- ⌘ Select the appropriate digital effect for the type of picture that you wish to shoot and the effect that you wish to give.
- ⌘ There are several DSE modes. (VP-W80U/W80: 8 modes, VP-W87/W87D: 10 modes)

1. Normal picture: This mode uses a normal image without DSE effect .
2. GHOST: This mode gives the image a dragging effect. (VP-W87/W87D only)
3. STROBE: This mode works by inserting cutting effect on the image. As a reference, there are 50 fields in the normal picture. (VP-W87/W87D only)
4. SEPIA: This mode gives the image a reddish brown pigment.
5. B&W(Black & White): This mode makes the image black and white.
6. NEG.(Negative): This mode reverses the colour of the image creating a negative picture affect.
7. MIRROR: This mode cuts the image in half, using a mirror effect.
8. ART: Adds a paint-like effect, called solarization, to the image.
9. MOSAIC: This mode gives the image a checkered design.
10. 16:9(WIDE): This mode provides 16:9(WIDE) television display.
11. CINEMA: This mode covers upper/lower portion of the screen to give a movie-like effect.

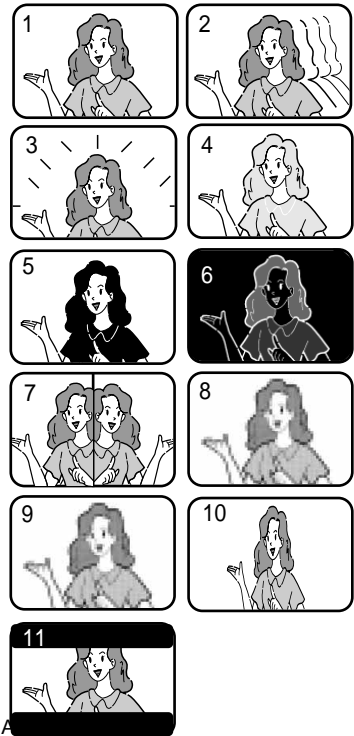

Note: DSE function will not operate in EASY mode.

Advanced Shooting

Selecting and recording DSE effects

1. Set the power switch to CAMERA mode.
2. Press the DSE button, GHOST or SEPIA will be displayed.
3. Keep pressing the DSE button, until the desired mode is displayed.
4. Press the START/STOP button to start recording.
5. To exit the DSE functions, press the DSE button once or several times until no DSE mode is displayed on the Viewfinder.

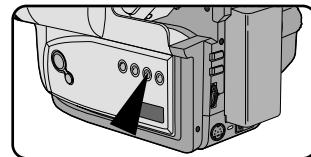
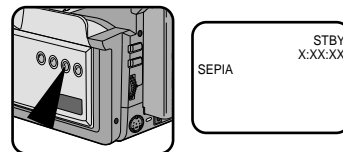

- Notes:**
- It is recommended that you set the DSE mode in STBY mode.
 - DSE functions will not operate in EASY mode.

Advanced Shooting

Setting and Recording the DATE/TIME

- ⌘ Setting and recording the date/time feature works in CAMERA mode only.
- ⌘ You can record the date/time on your recording, so you know when it was made. The date and time are recorded whenever they are displayed in the viewfinder.

Setting a DATE/TIME

- ⌘ Setting DATE/TIME is possible in STANDBY of CAMERA mode only.
1. Make sure that you have installed the LITHIUM BATTERY. (see page 17)
The LITHIUM BATTERY is needed to maintain the clock.
 2. Set the power switch to CAMERA mode.
 3. Press the MENU ON/OFF button, then the MENU list will appear.
 4. Turn the UP/DOWN dial until CLOCK SET is highlighted.
 5. Press ENTER.
 - The DATE and TIME is displayed.
 - The area BLINKING indicates which part will be changed. The year will be the first to blink.
 6. Turn the UP/DOWN dial to set a desired year.

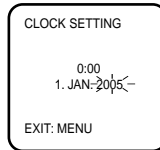
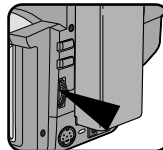
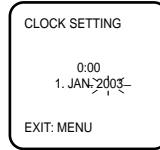
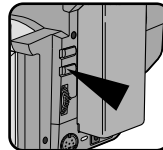
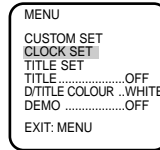
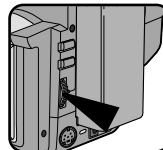
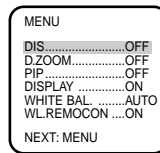
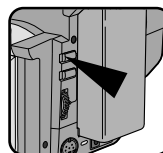

Advanced Shooting

7. Press ENTER.
 - The month setting will blink.
8. Turn the UP/DOWN dial to set the desired month.
9. Press ENTER.
 - The day setting will blink.
10. You set the year, hours and minutes by following the same procedures used for setting the year and month.
11. Press ENTER after setting the minutes, the clock setting screen will disappear. The entered date and time will then be displayed.

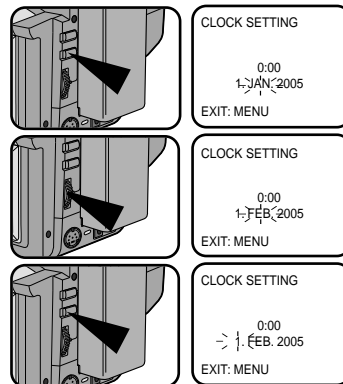

Recording a DATE/TIME

1. Make sure that you have set the DATE/TIME.
2. Set the power switch to CAMERA mode.
3. Press the DATE/TIME button.
 - To record the date only, press the DATE/TIME button once.
 - To record the date and time, press the DATE/TIME button twice.
4. Press the START/STOP button to start recording.

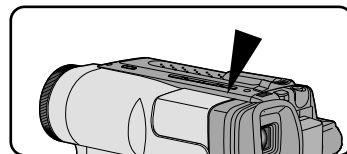

Notes:

- If your date and time settings are not maintained in the camcorder, it means the LITHIUM BATTERY is discharged and should be replaced. (see page 17)
- You cannot hide the recorded date or time during playback.
- The DATE/TIME function will not operate in EASY or CUSTOM mode.

Advanced Shooting

Selecting and Recording a Title

- ⌘ Selecting and recording a TITLE is possible in the CAMERA mode only.
- ⌘ The TITLE feature allows you to select a preset title stored in the camcorder's memory.
- ⌘ You can also select the language of the titles.

Selecting a Language and Setting a Title

- ⌘ Selecting a language is possible in both STANDBY in CAMERA modes.
- ⌘ The factory default language is ENGLISH but you can change the language.

1. Make sure that you have installed the LITHIUM BATTERY or have the adapter attached.
2. Set the power switch to CAMERA mode.
3. Press the MENU ON/OFF button.
The MENU list will be displayed.
4. Turn the UP/DOWN dial until TITLE SET is highlighted.
5. Press ENTER.
 - A list of available languages will appear.

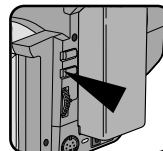
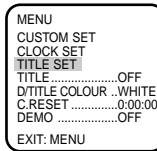
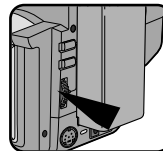
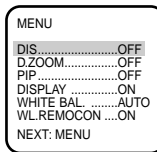
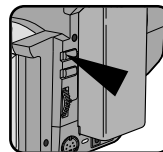

Advanced Shooting

6. Turn the UP/DOWN dial to select the appropriate language.
 - You may select from ENGLISH/FRENCH/GERMAN/ITALIAN/SPANISH/RUSSIAN.
7. Press ENTER.
 - Then, the title list in the language you chose will appear.
8. Turn the UP/DOWN dial to highlight the TITLE you desire.
9. Press ENTER.
 - The selected title will appear on the screen for 2 ~ 3 seconds and will then disappear. At the same time the camcorder will return to the menu mode.

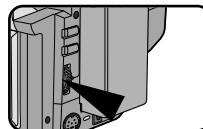

ENGLISH [HAVING FUN]
 FRENCH
 GERMAN
 ITALIAN
 SPANISH
 RUSSIAN

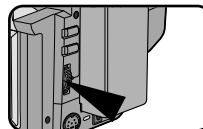

ANNIVERSARY
 CONGRATULATIONS
 GRADUATION
 HAPPY BIRTHDAY
 HAPPY NEW YEAR
 HAVING FUN

Recording a Title

Note: ■ Make sure that you have selected a TITLE.

1. Set the power switch to CAMERA mode.
2. Press MENU.
3. Turn the UP/DOWN dial until TITLE.....OFF is highlighted.
4. Press ENTER to choose between OFF, AUTO-10S and CONTINUE.
5. Press the START/STOP button to record the title with your recording.
 - If you want to change the title recording time, select title recording time. Select from: (OFF, AUTO-10S, CONTINUE) on MENU.

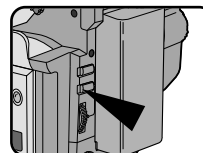

MENU
 CUSTOM SET
 CLOCK SET
 TITLE SET
 TITLE.....CONTINUE
 D/TITLE COLOUR ..WHITE
 DEMOOFF
 EXIT: MENU

- Notes:** ■ The title moves horizontally from the right side to the left side 10 seconds after you turn on the title.
 ■ The MENU ON/OFF function will not operate in EASY or REC mode.

Advanced Shooting

Fade In and Out

- ⌘ The FADE function works in CAMERA mode only.
- ⌘ You can give your films a professional look by using special effects such as fading in and out at the beginning or end of a sequence.

To Start Recording

1. Before recording, hold down the FADE button. The picture and sound gradually disappear (fade out).
2. Press the START/STOP button and at the same time release the FADE button. Recording starts and the picture and sound gradually appear (fade in).

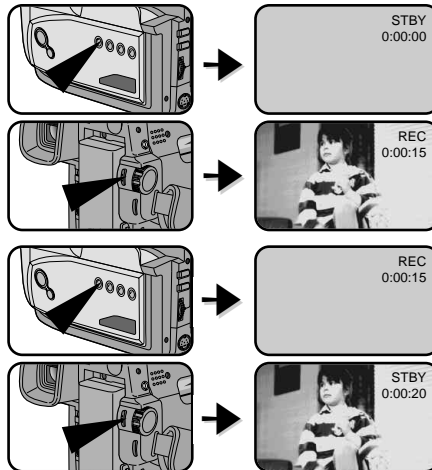

To Stop Recording (using FADE IN / FADE OUT)

3. When you wish to stop recording, hold down the FADE button. The picture and sound gradually disappear (fade out).
4. When the picture has disappeared, press the START/STOP button to stop recording.

a. FADE OUT

(Approx. 4 seconds)

Press the FADE button

a. FADE OUT

Gradual disappearance



Gradual appearance

b. FADE IN

Release the FADE button

b. FADE IN

(Approx. 4 seconds)

Advanced Shooting

PIP (Picture-in-Picture; VP-W87/W87D only)

- ⌘ The PIP(Picture-in-Picture) feature works in combination with the DIGITAL ZOOM function by using a small, super imposed screen to show an image that is wider than the image being shot. This should help you to get a more clear idea of what you are shooting.

- The PIP function works in CAMERA mode only.

1. Set the power switch to CAMERA mode.
2. Turn on the DIGITAL ZOOM facility. (see page 29)
3. Press the MENU ON/OFF button, the MENU List will be displayed.
4. Turn the UP/DOWN dial until PIP.....OFF is highlighted.
5. Press ENTER, the PIP ON and a small screen should appear.
6. Check which part you are shooting on the PIP screen, and move the Zoom button to the "T" position to activate the DIGITAL ZOOM.
7. Setting PIP.....ON to OFF in the MENU will make the small screen disappear and switch the PIP mode off.

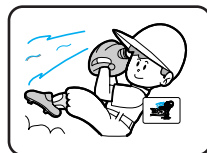
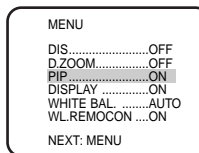
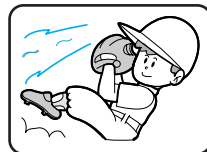
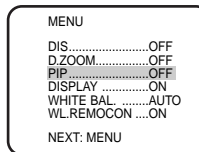
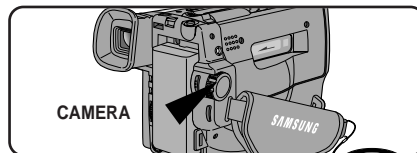

- Notes:**
- The PIP screen will be recorded if it is activated while recording.
 - The MENU ON/OFF function will not operate in EASY or REC mode.
 - PIP function will not operate in DSE mode.

Advanced Shooting

Snap Shot (VP-W87/W87D only)

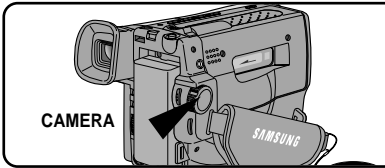
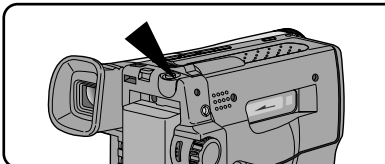
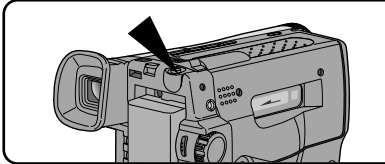
- ⌘ With the SNAP SHOT feature, your camcorder can function like a normal film camera, allowing you to take single still pictures.
 - The SNAP SHOT function only operates in the CAMERA mode.
1. Set the power switch to CAMERA mode.
 2. Press the SNAP SHOT button when you have the picture you wish to capture.
 - At this time, be careful not to shake your camcorder because the image will be indistinctly recorded.
 3. Once the SNAP SHOT button has been pressed, your camcorder will automatically return to STANDBY mode after approximately 6 seconds.
 - You can check the remaining available SNAP SHOT space by looking at the time displayed on the screen.
 - To stop SNAP SHOT shooting, press the SNAP SHOT button again.

Notes:

- If the camcorder is knocked or shaken while taking a SNAP SHOT, the image may be blurred.
- The SNAP SHOT is activated in recording.
- When the SNAP SHOT button is pressed in CAMERA mode with no tape installed, a still image will be displayed in the viewfinder.

Advanced Shooting

White Balance

- ☞ WHITE BALANCE is a recording function that preserves the unique colour of the object in any shooting condition.
- ☞ You may select the appropriate WHITE BALANCE mode to obtain good quality colour of the image.
 - AUTO: This mode is generally used to control the WHITE BALANCE automatically.
 - INDOOR (☼): It controls WHITE BALANCE according to the indoor ambience.
 - OUTDOOR (☀): It controls WHITE BALANCE according to the outdoor ambience.

Setting a White Balance Mode

1. Set the power switch to CAMERA mode.
2. Press the MENU ON/OFF button, then the MENU list will be displayed.
3. Turn the UP/DOWN dial until WHITE BAL.AUTO is highlighted.
4. Press ENTER.
 - You can set it to INDOOR or OUTDOOR by pressing the ENTER button.
5. Press MENU ON/OFF button to exit the WHITE BALANCE setting screen.

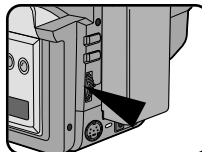

MENU

DIS.....OFF
 D.ZOOM.....OFF
 PIP.....OFF
 DISPLAY.....ON
 WHITE BAL.....AUTO
 WL.REMOCON...ON

EXIT: MENU

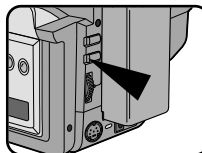

MENU

DIS.....OFF
 D.ZOOM.....OFF
 PIP.....OFF
 DISPLAY.....ON
 WHITE BAL.....OUTDOOR☀
 WL.REMOCON...ON

EXIT: MENU

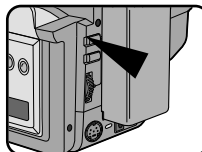

Hi8 STBY
 0:00:00



Note: The MENU ON/OFF function will not operate in EASY or REC mode.

Advanced Shooting

Demonstration

- ⌘ Demonstration automatically shows you the major functions that are included with your camcorder so that you may use them more easily.
- ⌘ The DEMO function is only available in CAMERA mode when tape is not in the camcorder.
- ⌘ The Demonstration operates repeatedly until the POWER switch is set to OFF.

1. Set the POWER switch to CAMERA mode.
2. Press MENU ON/OFF button, then the MENU list will appear.

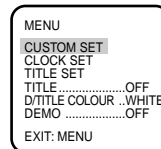
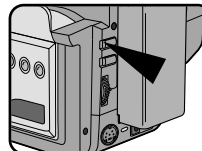

3. Turn the UP/DOWN dial so that DEMO is highlighted.

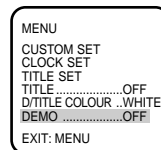
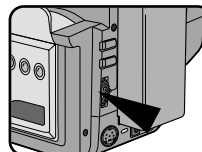

4. Press ENTER to select ON.
 - Demonstration will start.

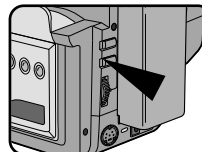

5. Set the POWER switch to OFF to end the Demonstration.

Note: The MENU ON/OFF function will not operate in EASY or REC mode.

Setting the Date/Title Colour

1. Set the power switch to CAMERA mode. (see page 22)
2. Press the MENU ON/OFF button.
 - The MENU list will appear.
3. Turn the UP/DOWN dial to D/TITLE COLOUR.....WHITE.
4. Press ENTER.
 - A list of available colour will appear.
5. Turn the UP/DOWN dial to select the appropriate colour.
6. Press ENTER.
7. Press the MENU ON/OFF button to end setting.
 - The title and Date/Time will appear in the colour you chose .

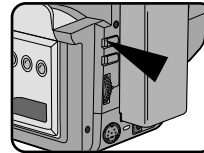

```
MENU
CUSTOM SET
CLOCK SET
TITLE SET
TITLE .....OFF
D/TITLE COLOUR ..WHITE
C.RESET .....0:00:00
DEMO .....OFF
EXIT: MENU
```

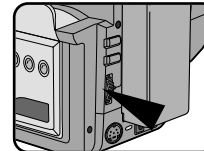

```
MENU
CUSTOM SET
CLOCK SET
TITLE SET
TITLE .....OFF
D/TITLE COLOUR ..WHITE
C.RESET .....0:00:00
DEMO .....OFF
EXIT: MENU
```

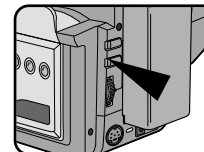

```
DATE/TITLE COLOUR SELECT
[WHITE]
WHITE
YELLOW
CYAN
MAGENTA
RED
GREEN
BLUE
EXIT: MENU
```

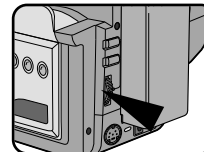

```
DATE/TITLE COLOUR SELECT
[YELLOW]
WHITE
YELLOW
CYAN
MAGENTA
RED
GREEN
BLUE
EXIT: MENU
```

Advanced Shooting

Lighting Techniques

- ⌘ When you use your camcorder, there are normally only two main recording environments.
 - You will be shooting outdoors (Normal recording or through an ND (Neutral Density) filter).
 - You will be shooting indoors (Video light recommended or required).
- ⌘ The single greatest influence on picture quality is the level of brightness, measured in lux.
- ⌘ The following table lists a few common situations, the corresponding level of brightness and any associated recommendations.

Situations	Brightness (lux)	Recommendations
◆ Snow-covered mountains or fields.	100,000	ND filter recommended.
◆ Sandy beach on a hot summer's day.	100,000	
◆ On a sunny day in the middle of the afternoon.	35,000	Normal recording.
◆ On a gloomy day, an hour after the sunrise.	2,000	
◆ Office with fluorescent lighting near to a window.	1,000	
◆ On a sunny day, an hour before the sunset.	1,000	
◆ Department store counter.	500 to 700	
◆ Room lit by two 30W fluorescent lights.	300	Video light recommended.
◆ Arcade at night.	150 to 200	Video light required.
◆ Candle light.	10 to 15	

After Shooting

1. Eject the tape that you have shot. (see page 22)
2. If you want to protect the tape against accidental erasing, move the red tab on the cassette to cover the hole.
3. Set the POWER switch to OFF.
4. Close the LENS cover.
5. Remove the BATTERY PACK from the camcorder.

Playing back the Tape

- ⌘ To view a tape that you have recorded.
- ⌘ Playback function works in PLAYER mode only.
 - Watch on a TV monitor: recommended for indoor use.

To watch on a TV monitor

- ⌘ It is better to use a TV monitor to view tapes indoors.
- ⌘ To play a tape back, the TV must feature a compatible colour system. (see page 56)

Connecting to a TV which has an Audio and Video input jack

- ⌘ Use the Audio/Video cable supplied with your camcorder.
 - The yellow one: Video
 - The white one: Audio(L)
- ⌘ You can use a SCART adapter, supplied optionally.
- ⌘ A provided SCART adapter will be one of the following two types.
 - Stereo type
 - Mono type

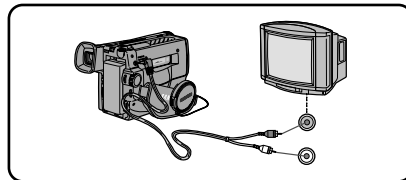

Connecting to a TV which has no Audio and Video input jack

- ⌘ You can connect your camcorder to a TV through a VCR.
 - Set the input selector on the VCR to LINE.
 - The yellow one: Video
 - The white one: Audio(L)
 - You can use a SCART adapter (supplied optionally).
- ⌘ To view the cassette on the television screen, select the channel reserved for your VCR on the television. (Refer to your VCR or television instruction book.)

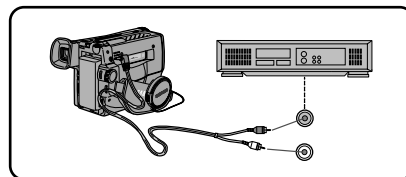

Playing back the Tape

Note:

- VP-W80U/W80/W87/W87D feature a monaural audio system.
If your TV or VCR are stereo, connect the audio cable to the input marked "L" of the TV or VCR.
- You can use the S-VIDEO cable to obtain better quality pictures if you have the S-VIDEO connector on your TV.

Playback

1. Use the TV/VIDEO button to select VIDEO on your TV.
2. Connect a power source (battery or AC Power Adapter) to the camcorder.
Set the power switch to PLAYER mode.
3. Insert the tape you want to watch.
 - Make sure that STOP is displayed.
4. Press the **▶||** (PLAY/STILL) button.
 - The recorded pictures should appear on the TV after 2 to 3 seconds.
 - Press **■** (STOP) to stop playing.
 - If the tape reaches its end during playback, the tape will rewind automatically.

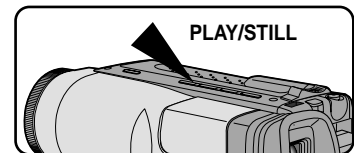
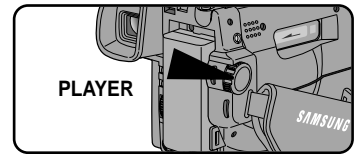
**Note:**

- This camcorder does not support LP recording and playback.
- The playback system (Hi8/8mm) is selected automatically, depending on the tape format.
- VP-W80/W87/W87D can playback both Hi8 and 8mm.

Various Functions in PLAYER mode

To view a STILL picture (Playback pause)

- Press ►|| (PLAY/STILL) button during playback.
- To resume playback, press ►|| (PLAY/STILL) button again.

Note: Your camcorder will automatically stop if it is left for more than 5 minutes in STILL mode without operation in order to prevent tape and head wear.

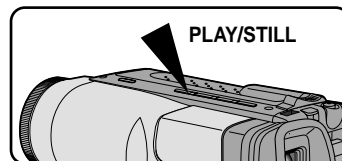

To locate a scene (picture search)

- Press ►► (FF) or ◀◀ (REW) buttons during playback. To resume normal playback, release the buttons.

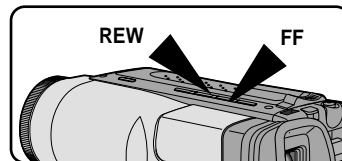

Zero RETURN (VP-W87/W87D only)

- ☼ The ZERO RETURN function works in STOP of PLAYER mode.
- ☼ You can Fast Forward or Rewind to 0:00:00 automatically.

1. Set power switch to PLAYER mode.
 - Make sure that STOP is displayed.
2. Press ZERO RETURN button.
 - Z.RETURN should displayed.
 - FF or REW works automatically.

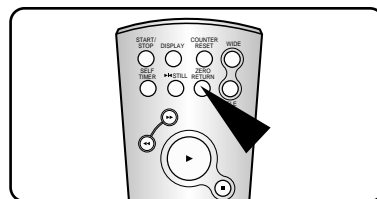

Note: The ZERO RETURN button does not work when the TAPE COUNTER reads 0:00:00.

- Notes:**
- Set the COUNTER RESET to "C.RESET 0:00:00" in MENU mode at the start of the cassette or the required sequence.
 - When you wish to find this point on the tape again, press Z.RTN button when playback is stopped.

Playing back the Tape

DSE in PLAYER mode

- ⌘ The procedure for using DSE in PLAYER mode is the same as the procedure for using DSE in CAMERA mode, except that the power switch must be set to PLAYER instead of CAMERA.

Please refer to pages 36 and 37.

Note: The GHOST, STROBE, NEG., MIRROR, MOSAIC, CINEMA and 16:9(WIDE) effects will not operate when your camcorder is in PLAYER mode.

- ⌘ Pressing the DSE button will scroll through the available settings. Stop at the one you require.

Maintenance

Cleaning and Taking care of the Camcorder

Cleaning the Viewfinder

◆ Releasing the Eyepiece

1. Pull the viewfinder up and then turn the screw counter-clock-wise.
2. Pull the EYEPIECE away from the viewfinder.
3. Clean the EYEPIECE and the VIEWFINDER screen with a soft cloth and cotton swab or a blower.

◆ Reattaching the Eyepiece

4. Reposition the EYEPIECE back on the VIEWFINDER.
5. Insert and tighten the screw.

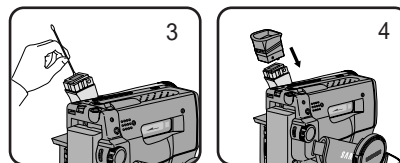
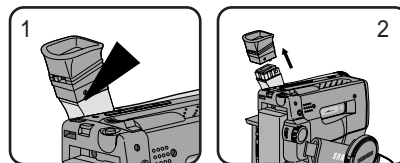

Cleaning the Video Heads

- ⚙ To ensure normal recording and clear pictures, clean the video heads.
- ⚙ When the playback pictures are noisy or hardly visible, the video heads may be dirty.

- a. Normal Picture
b, c. Noisy Picture

If this happens, clean the video heads with a dry type cassette cleaner.

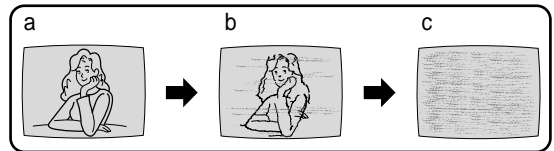

1. Set the power switch to PLAYER mode.
2. Insert the cleaning tape.
3. Press the ►|| (PLAY/STILL) button.
4. Press the ■ (STOP) button after about 30 seconds.

Check the quality of the picture using a known good video cassette.

If it is still bad, repeat the operation.

If the problem continues, contact your local authorized service centre.

Storing the Camcorder

1. You must detach the BATTERY PACK from the camcorder when not in use.
2. Keep the camcorder in a ventilated, dry/warm place.
3. Store the camcorder where temperature changes will be minimal. (avoid places such as a garage, loft space or car.)
4. Store the camcorder on a stable surface.

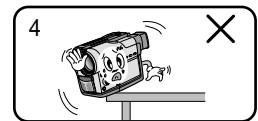
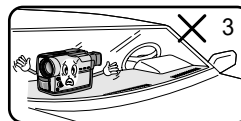
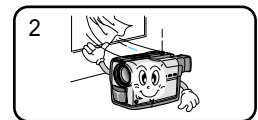
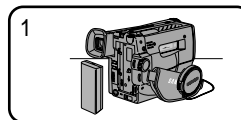

Using Your Camcorder Abroad

Using Your Camcorder Abroad

- ⌘ Each country or area has its own electric and TV colour system.
- ⌘ Before using your camcorder abroad, check the following:

Power sources

- You can use your camcorder in any country or area that uses 100V to 240V, 50/60 Hz.
- Where necessary, use a commercially available AC plug adapter, depending on the style of plug used.

Colour system

- You can always view your recordings on the Viewfinder.
However, to view a recording on a television or to make a copy to a video cassette recorder, the television or VCR must be PAL: VP-W80U/W80/W87/W87D- compatible and have the appropriate audio/video jacks.

❖ PAL-compatible area

Australia, Austria, Belgium, Bulgaria, China, CIS, Czech Republic, Denmark, Egypt, Finland, France, Germany, Greece, Great Britain, Holland, Hong Kong, Hungary, India, Iran, Iraq, Kuwait, Libya, Malaysia, Mauritius, Rumania, Saudi Arabia, Singapore, Slovak Republic, Spain, Sweden, Switzerland, Syria, Thailand, Tunisia, etc.

❖ NTSC-compatible area



Bahamas, Canada, Central America, Japan, Mexico, Philippines, Korea, Taiwan, United States, etc.

Note: You can make recordings with your camcorder anywhere in the world.

Troubleshooting Check

- ⚠ Before contacting a service centre, perform the following simple checks. They might save you the time and the expense of an unnecessary call.

Self Diagnosis Display

Display	Blinking	Inform that...	Action
	slow	the battery pack is almost discharged.	Exchange it with a charged one.
	fast	the battery pack is fully discharged.	Exchange it with a charged battery.
TAPE END!	slow	the tape has almost reached its end.	Prepare a new one.
TAPE END!	no	the tape reached its end.	Change to a new one.
TAPE!	slow	there is no tape in the camcorder.	Insert a tape.
PROTECTION!	slow	the tape is protected from recording.	Check the red tab, on the tape.
D.EMG C.EMG R.EMG L.EMG	slow	the camcorder has some mechanical fault.	<ol style="list-style-type: none"> 1. Eject the tape. 2. Set to OFF 3. Detach the battery. 4. Reattach the battery. * Please contact your local authorized service centre if the problem continues.
	slow	moisture condensation has formed in the camcorder.	see page 60.

Troubleshooting Check

Checking

- ☞ If you run into any problem using the camcorder, use the following table to try and resolve the problem.
- ☞ If these instructions do not allow you to solve the problem, take a note of:
 - The model and serial number marked on the bottom of the camcorder.
 - Your warranty, if applicable.
- ☞ Then contact your nearest authorized service centre.

Symptom	Explanation/Solution
You cannot switch the camcorder on.	<ul style="list-style-type: none"> ◆ Check the battery pack (see page 19) or the AC power adapter. (see page 18)
Start/Stop does not operate while shooting.	<ul style="list-style-type: none"> ◆ Check the POWER set it to CAMERA. ◆ You have reached the end of the cassette. ◆ Check the record protection tab on the cassette. (see page 22)
The camcorder goes off automatically.	<ul style="list-style-type: none"> ◆ You have left the camcorder set to STANDBY for more than 5 minutes without using it.(see page 24) ◆ The battery pack is fully used up. (see page 21)
The battery pack is quickly exhausted.	<ul style="list-style-type: none"> ◆ The atmospheric temperature is too low. (see page 21) ◆ The battery pack has not been charged fully.(see page 19) ◆ The battery pack is completely dead, and cannot be recharged. Use another battery pack.
You cannot eject the cassette from the compartment.	<ul style="list-style-type: none"> ◆ The battery pack is fully discharged. ◆ A mechanical fault may have occurred. (see page 57)
The DATE/TIME indicator flashes more than 2 times when you set the camcorder to CAMERA.	<ul style="list-style-type: none"> ◆ The lithium battery is not installed or is fully used up. (see page 17)
The playback picture is in poor quality.	<ul style="list-style-type: none"> ◆ The video heads might be dirty. (see page 55)
You can do nothing with the camcorder.	<ul style="list-style-type: none"> ◆ A mechanical fault may have occurred. (see page 57)

Troubleshooting Check

Symptom	Explanation/Solution
A vertical strip appears when you shoot a bright subject against a dark background. (candle flame, for example)	<ul style="list-style-type: none"> ◆ The contrast between the subject and the background is too great for the camcorder to operate normally. Make the background bright to reduce the contrast or use the BLC function while you are shooting. (see page 35)
The image in the viewfinder is blurred.	<ul style="list-style-type: none"> ◆ The view finder lens has not been adjusted. Turn the viewfinder focus ring until the screen comes into sharp focus. (see page 25)
The tape does not move when you press the play, Fast Forward or Rewind buttons.	<ul style="list-style-type: none"> ◆ Set the POWER switch to PLAYER. ◆ You have reached the beginning or end of the cassette.
The Date Time or Title disappeared even though you had it set.	<ul style="list-style-type: none"> ◆ The lithium battery is not installed or is fully used up. (see page 17)

Troubleshooting Check

Moisture Condensation

⚠ If the camcorder is brought directly from a cold place to a warm place, moisture may form inside the camcorder, on the surface of the tape, or on the lens. In this condition, the tape may stick to the head drum and be damaged or the unit may not operate correctly.

To prevent possible damage under these circumstances, the camcorder has the built-in moisture sensor.

⚠ If there is moisture inside the camcorder, "DEW ()" is displayed. If this happens, none of the functions except cassette ejection will work. Open the cassette compartment and remove the battery for at least two hours in a warm dry room.

⚠ If the DEW protection feature unexpectedly activated and you want to override it: (Please make sure that the condensation has disappeared completely.)

1. Take the battery pack out.

2. Take the lithium battery out.

3. Put the lithium battery back.

4. Put the battery pack back.

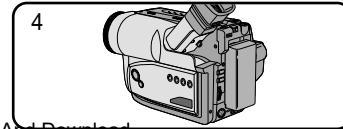
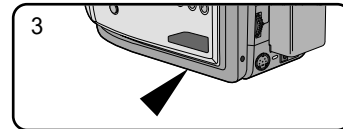
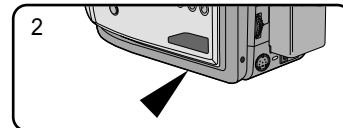
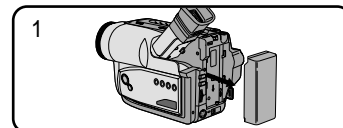
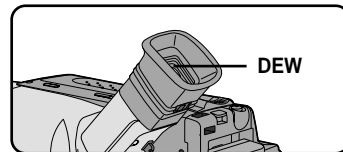

Specifications

⚠ These technical specifications and design may be changed without notice.

System	VP-W80U/W80/W87/W87D
Recording system Video signal Usable cassette Tape speed Speed mode Recording time FF or REW time Image device Optical zoom ratio Focal length: f F Filter diameter Focus system Macro Min. Illumination	Video: 2 rotary heads Helical scanning FM Audio: FM monaural system PAL colour, CCIR standard VP-W80U: 8mm VP-W80/W87/W87D: Hi8 or 8mm SP: 20.051 mm/sec Record: SP only Playback: SP only P5-120: 120 min. P5-120: approx. 8 min. CCD (Charge Coupled Device) 22x 3.6 ~ 79.2 mm 1.6 46 mm Inner Auto wide macro 0.3 lux (visible)
Connectors	
Video out Audio out External mic	Mini jack, 1 Vp-p, 75 ohms, Unbalanced Mini jack, 7.7 dBs, imp.: less than 820 ohms Monaural ø3.5 (VP-W87/W87D)
General	
Power requirement Power consumption Built-in mic Operating temperature Dimension (W*H*D) Weight	DC 8.4 V (1.5 A) VP-W80U/W80: 3.3 W, VP-W87/W87D: 3.8 W Condenser mic, omni-directional 0°C to 40°C (32°F to 104°F) 101*104*174 (mm) 690g

Index

- A -

ABROAD	56
AC POWER ADAPTER	18
AF	34
AUDIO	51
AUTO FOCUSING	34
AUTO MODE	36
AUTO POWER OFF	24

- B -

BATTERY	19
BATTERY LEVEL	21
BATTERY PACK	19
BLC	35

- C -

CAMERA	18
CASSETTE	22
CASSETTE HOLDER	11
CLEANING	55
CONTENTS	2
CUSTOM	32

- D -

DATE	40
DATE/TIME	40
DC CABLE	18
DEMO	48
DEW	60
DIGITAL ZOOM	29
DIMENSION	61
DIS	33
DISPLAY	12
DSE	38

- E -

EASY	31
EJECT	22

- F -

FADE IN	44
FADE OUT	44
FF (FAST FORWARD)	53
FILTER DIAMETER	61
FOCAL LENGTH	61

- G -

GHOST	38
-------------	----

- H -

HAND STRAP	16
Hi8	52

- L -

LENS	9
LITHIUM BATTERY	17

- M -

MIRROR	38
MOISTURE	60
MONAURAL AUDIO	51
MOSAIC	38

- N -

ND FILTER	50
NEG	38
NTSC	56

Index

- O -

OPERATION MODE	13
OSD	12

- P -

PAL	56
PIP	45
PLAY	52
PLAYER	52
PORTRAIT MODE	36
POWER CONSUMPTION	61
POWER REQUIREMENT	61
POWER SWITCH	18
PROGRAM AE	36

- R -

RECHARGING	19
RECORDING	23
REC SEARCH	24
REMOTE CONTROL	15
REW (REWIND)	53

- S -

SAFETY INSTRUCTION	4
SAND/SNOW MODE	36
SELF-30S	15
SELF-END	15
SELF DIAGNOSIS	57
SELF RECORD	15
SELF TIMER	15
SEPIA	38
SHOULDER STRAP	17
SNAP SHOT	46
SPECIFICATION	61
SPORTS MODE	36
SPOTLIGHT MODE	36

START/STOP	23
STILL	53
STOP	52
STROBE	38
SYSTEM	61
S-VIDEO	52

- T -

TAPE COUNTER	13
TAPE EJECT	22
TAPE END	57
TIME	40
TITLE	42
TROUBLE CHECK	58
TV MONITOR	51

- V -

VIDEO	51
VIDEO HEAD	55

- W -

WAIT-10S	15
WEIGHT	61

- Z -

ZERO RETURN	53
ZOOM	28

Power Sources (United Kingdom Only)

The mains lead on the power adapter is supplied with a molded plug incorporating a fuse.

The value of the fuse is indicated on the pin face of the plug and, if it requires replacing, a fuse approved to BS1362 of the same rating must be used.

Never use the plug with the fuse cover omitted if the cover is detachable.

If a replacement fuse cover is required, it must be of the same colour as the pin face of the plug.

Replacement covers are available from your dealer.

If the fitted plug is not suitable for the power points in your house or the cable is not long enough to reach a power point, you should obtain a suitable safety approved extension lead or consult your dealer for assistance.

However, if there is no alternative to cutting off the plug, remove the fuse and then safely dispose of the plug.

Do NOT connect the plug to a mains socket as there is a risk of shock hazard from the bared flexible cord.

IMPORTANT

The wires in the mains lead are coloured in accordance with the following code:

BLUE = NEUTRAL

BROWN = LIVE

As these colours may not correspond to the coloured markings identifying the terminals in your plug, proceed as follows:

The wire coloured BLUE must be connected to the terminal marked with the letter N or coloured BLUE or BLACK.

The wire coloured BROWN must be connected to the terminal marked with the letter L or coloured BROWN or RED.

WARNING

Do not connect either wire to the earth terminal marked with the letter E or the earth symbol, , or coloured GREEN or GREEN and YELLOW.

NOTE

This page is applicable to Great Britain only.

THIS CAMCORDER IS MANUFACTURED BY:



***Samsung Electronics' Internet Home Page**

United Kingdom <http://www.samsungelectronics.co.uk>

AD68-00606F

Free Manuals Download Website

<http://myh66.com>

<http://usermanuals.us>

<http://www.somanuals.com>

<http://www.4manuals.cc>

<http://www.manual-lib.com>

<http://www.404manual.com>

<http://www.luxmanual.com>

<http://aubethermostatmanual.com>

Golf course search by state

<http://golfingnear.com>

Email search by domain

<http://emailbydomain.com>

Auto manuals search

<http://auto.somanuals.com>

TV manuals search

<http://tv.somanuals.com>