



SAMSUNG

User Manual

High Definition Digital Camcorder





www.samsung.com/register

HMX-E10WN
HMX-E10BN
HMX-E10ON

before reading this user manual

SAFETY WARNINGS

What the icons and signs in this user manual mean:

Safety Icon	Meaning
 WARNING	There is a potential risk of death or serious injury.
 CAUTION	There is a potential risk of personal injury or damage to the product.
 CAUTION	To reduce the risk of fire, explosion, electric shock, or personal injury when using your camcorder, follow these basic safety precautions.
	Here are hints or page number references that contain information you will find helpful when you operate the camcorder.
PRECHECK	Settings required before using a function.

These warning signs are here to prevent injury to you and others. Please follow them explicitly. After reading this section, keep it in a safe place for future reference.

PRECAUTIONS

Warning!

- When using the AC power adapter with your camcorder, connect the adapter to an outlet with protective grounding.
- Do not expose the camcorder battery to direct sunlight, heaters, radiators, fire, or any other source of excessive heat.

Caution

If you replace the battery with the wrong battery, you can cause an explosion. Replace only with the same battery or an equivalent type.

If you plug the AC adapter into a 240V AC outlet, be sure to use a suitable plug adapter.

IMPORTANT INFORMATION ON USE

About this user manual



Thank you for purchasing this Samsung Camcorder. Please read this user manual carefully before you use the camcorder and keep it handy for future reference. Should your camcorder fail to operate correctly, refer to Troubleshooting.

This User Manual covers HMX-E10WN, HMX-E10BN, HMX-E10ON models.



- Illustrations of model HMX-E10WN are used in this user manual.
- The displays in this user manual may not be exactly the same as those you see on the LCD screen.
- Designs and specifications of the camcorder and other accessories are subject to change without any notice.
- In this user manual, the icon or symbol in the parenthesis appearing in a description of a submenu item indicates it will appear on the screen when you set the corresponding item.

Ex) Submenu item of “**Video Resolution**”

↳ page 44

- “**1080/30p**” (): Records in the HD (1920x1080 30p) format. If set, corresponding icon () appears on the screen.

The following terms are used in this manual:

- ‘Scene’ refers to the point where you touch the **Recording Start** () tab to start recording until you touch the **Recording stop** () tab to pause the recording.
- The terms ‘photo’ and ‘still image’ are used interchangeably and have the same meaning.

Before using this camcorder

- **This camcorder records video in H.264 (MPEG4/AVC) format.**
- **Please note that this camcorder is not compatible with other digital video formats.**
- **Before recording important video, make a trial recording.**
Play back your trial recording to make sure the video and audio have been recorded properly.
- **We can not compensate you for damage to or loss of your recorded contents:**
 - Samsung cannot compensate you for any damage caused when a recording cannot be played back because of a defect in the camcorder or memory card.
 - Samsung cannot be responsible for your recorded video and audio.
 - Recorded contents may be lost due to a mistake when handling the camcorder or memory card, etc. Samsung will not provide compensation for damages due to the loss of recorded contents.
- **Make a backup of important recorded data.**
Protect your important recorded data by copying the files to a PC. We also recommend you copy them from your PC to other recording media for storage. Refer to the software installation and USB connection guide.



before reading this user manual

- **Copyrights: Please note that this camcorder is intended for individual use only.**
Data recorded on the storage media in this camcorder using other digital/analog media or devices is protected by the copyright act and cannot be used without permission of the owner of the copyright, except for personal enjoyment. Even if you record an event such as a show, performance, or exhibition for personal enjoyment, we strongly recommend that you obtain permission beforehand.
- For Open Source License information, refer to the "OpenSource-E10.pdf" in the provided CD-ROM.

Notes regarding trademarks

- All the trade names and registered trademarks mentioned in this manual or other documentation provided with your Samsung product are trademarks or registered trademarks of their respective holders.
- The micro SD logo is a trademark. The micro SDHC logo is a trademark.
- Microsoft®, Windows®, Windows Vista®, Windows® 7, and DirectX® are either registered trademarks or trademarks of the Microsoft Corporation in the United States and/or other countries.
- Intel®, Core™, and Pentium® are the registered trademarks or trademarks of the Intel Corporation in the United States and other countries.
- Macintosh, Mac OS are either registered trademarks or trademarks of Apple Inc. in the United States and/or other countries.
- YouTube is a trademark of Google Inc.
- Flickr™ is a trademark of Yahoo.
- Facebook is a trademark of Facebook Inc.
- HDMI, the HDMI logo and High-Definition Multimedia Interface are trademarks or registered trademarks of HDMI Licensing LLC.
- Adobe, the Adobe logo, and Adobe Acrobat are either registered trademarks or trademarks of Adobe Systems Incorporated in the United States and/or other countries.
- All the other product names mentioned here in may be the trademark or registered trademarks of their respect companies. Furthermore, "™" and "®" are not mentioned in each case in this manual.

important safety instructions

	CAUTION RISK OF ELECTRIC SHOCK DO NOT OPEN	
CAUTION: TO REDUCE THE RISK OF ELECTRIC SHOCK, DO NOT REMOVE COVER (OR BACK). NO USER-SERVICEABLE PARTS INSIDE REFER SERVICING TO QUALIFIED SERVICE PERSONNEL.		



This symbol indicates that dangerous voltage consisting a risk of electric shock is present within this unit.



This symbol indicates that there are important operating and maintenance instructions in the literature accompanying this unit.

Warning

To Reduce The Risk Of Fire Or Electric Shock, Do Not Expose This Apparatus To Rain Or Moisture.

Caution

Apparatus shall not be exposed to dripping or splashing and no objects filled with liquids, such as vases, shall be placed on the apparatus.

To disconnect the apparatus from the mains, the plug must be pulled out from the mains socket, therefore the mains plug shall be readily operable.

1. Read these instructions.
2. Keep these instructions.
3. Heed all warnings.
4. Follow all instructions.
5. Do not use this apparatus near water.
6. Clean only with dry cloth.
7. Do not block any ventilation openings. Install in accordance with the manufacturer's instructions.
8. Do not install near any heat sources such as radiators, heat registers, stoves, or other apparatus (including amplifiers) that produce heat.
9. Do not defeat the safety purpose of the polarized or grounding-type plug. A polarized plug has two blades with one wider than the other. A grounding type plug has two blades and a third grounding prong. The wide blade or the third prong are provided for your safety. If the provided plug does not fit into your outlet, consult an electrician for replacement of the obsolete outlet.
10. Protect the power cord from being walked on or pinched particularly at plugs, convenience receptacles, and the point where they exit from the apparatus.
11. Only use attachment/accessories specified by the manufacturer.
12. Use only with the cart, stand, tripod, bracket, or table specified by the manufacturer, or sold with the apparatus. When a cart is used, use caution when moving the cart/apparatus combination to avoid injury from tip-over.
13. Unplug this apparatus during lightning storms or when unused for long periods of time.
14. Refer all servicing to qualified service personnel. Servicing is required when the apparatus has been damaged in any way, such as power-supply cord or plug is damaged, liquid has been spilled or objects have fallen into the apparatus, the apparatus has been exposed to rain or moisture, does not operate normally, or has been dropped.



important safety instructions

15. Apparatus shall not be exposed to dripping or splashing and no objects filled with liquids, such as vases, shall be placed on the apparatus.

16. VENTILATION:

Slots and openings in the cabinet are provided for ventilation to ensure reliable operation of the CAMCORDER and to protect it from overheating. These openings must not be blocked or covered. Never place your CAMCORDER on a bed, sofa, rug, or other similar surface: on or near a radiator or heat register. This CAMCORDER should not be placed in a built-in installation such as a bookcase or rack unless proper ventilation is provided or the manufacturer's instructions have been adhered to.

17. POWER SOURCES:

The CAMCORDER should be operated only from the type of power source indicated on the label. If you are not sure of the type of power supply at your home, consult your appliance dealer or local power company. A CAMCORDER is intended to be operated from battery power, or other sources, refer to the operating instructions.

18. GROUNDING OR POLARIZATION:

This CAMCORDER may be equipped with either a polarized 2-wire AC line plug (a plug having one blade wider than the other) or a 3-wire grounding type plug, a plug having a third (grounding) pin. If you are unable to insert the plug fully into the outlet, try reversing the plug. If the plug still fails to fit, contact your electrician to replace your outlet. Do not defeat the safety purpose of the polarized plug.

19. POWER-CORD PROTECTION:

Power-supply cords should be routed so that they are not likely to be walked on or pinched by items placed upon or against them, paying particular attention to cords or plugs, convenient receptacles, and the point where they exit from the unit.

20. OUTDOOR ANTENNA GROUNDING:

CAMCORDER, be sure the antenna or cable system is grounded to provide some protection against voltage surges and built-up static charges. Section 810 of the National Electrical Code, ANSI/NFPA No. 70-1984, provides information with respect to proper grounding of the mast and supporting structure, grounding of the lead-in wire and supporting structure, grounding of the mast and supporting structure, grounding of the lead-in wire to an antenna discharge unit, size of grounding to conductors, location of antenna-discharge unit, connection to grounding electrodes and requirements for the grounding electrode. See figure below.

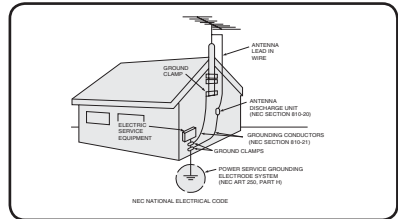

21. LIGHTNING:

For added protection of this CAMCORDER during a lightning storm or when it is left unattended and unused for long periods of time, unplug it from the wall outlet and disconnect the antenna or cable system. This will prevent damage to the CAMCORDER due to lightning and powerline surges.

22. POWER LINES:

An outside antenna system should not be located in the vicinity of overhead power lines or other electric light or power circuits where it can fall into such power lines or circuits. When installing an outside antenna system, extreme care should be taken to keep from touching such power lines or circuits as contact with them might be fatal.

23. OVERLOADING:

Do not overload wall outlets and extension cords as this can result in a risk of fire or electric shock.

24. OBJECTS AND LIQUIDS:

Never push objects of any kind into this CAMCORDER through openings as they may touch dangerous voltage points or short out a part that could result in a fire or electric shock. Never spill liquids of any kind onto the CAMCORDER. Should spillage occur, unplug unit and have it checked by a technician before use.

25. SERVICING:

Do not attempt to service this CAMCORDER yourself. Opening or removing covers may expose you to dangerous voltage or other hazards. Refer all servicing to qualified service personnel.

26. DAMAGE REQUIRING SERVICE:

Unplug this CAMCORDER from the wall outlet and refer servicing to qualified service personnel under the following conditions:

- a. When the power-supply cord or plug is damaged.
- b. If any liquid has been spilled onto, or objects have fallen into the CAMCORDER.
- c. If the CAMCORDER has been exposed to rain or water.
- d. If the CAMCORDER does not operate normally by following the operating instructions, adjust only those controls that are covered by the operating instructions. Improper adjustment of other controls may result in damage and will often require extensive work by a qualified technician to restore the CAMCORDER to its normal operation.
- e. If the CAMCORDER has been dropped or the cabinet has been damaged.
- f. When the CAMCORDER exhibits a distinct change in performance, this indicates a need for service.

27. REPLACEMENT PARTS:

When replacement parts are required, be sure the service technician has used replacement parts specified by the manufacturer and having the same characteristics as the original part. Unauthorized substitutions may result in fire, electric shock or other hazards.

28. SAFETY CHECK:

Upon completion of any service or repairs to this CAMCORDER, ask the service technician to perform safety checks to determine that the CAMCORDER is in safe operating order.

29. To prevent damage which may result in fire or shock hazard, do not expose this appliance to rain or moisture.

30. If this power supply is used at 240V ac, a suitable plug adaptor should be used.

important safety instructions

USER INSTALLER CAUTION:

Your authority to operate this FCC certified equipment could be voided if you make changes or modifications not expressly approved by this party responsible for compliance to part 15 FCC rules.

NOTE:

 LAMP(S) INSIDE THIS PRODUCT CONTAIN MERCURY AND MUST BE RECYCLED OR DISPOSED OF ACCORDING TO LOCAL, STATE OR FEDERAL LAWS. For details see lamprecycle.org, eiaa.org, or call 1-800-Samsung (7267864)

CALIFORNIA USA ONLY

This Perchlorate warning applies only to primary CR (Manganese Dioxide) Lithium coin cells in the product sold or distributed ONLY in California USA

“ Perchlorate Material - special handling may apply, See www.dtsc.ca.gov/hazardouswaste/perchlorate.”

NOTE:

This equipment has been tested and found to comply with the limits for a Class B digital device, pursuant to part 15 of the FCC rules.

These limits are designed to provide reasonable protection against harmful interference in a residential installation.

This equipment generates, uses and can radiate radio frequency energy and, if not installed and used in accordance with the instructions, may cause harmful interference to radio communications.

However, there is no guarantee that interference will not occur in a particular installation.

If this equipment does cause harmful interference to radio or television reception, which can be determined by turning the equipment off and on, the user is encouraged to try to correct the interference by one or more of the following measures:

- Reorient or relocate the receiving antenna.
- Increase the separation between the equipment and receiver.
- Connect the equipment into an outlet on a circuit different from that to which the receiver is connected.
- Consult the dealer or an experienced radio/TV technician for help and for additional suggestions. The user may find the following booklet prepared by the Federal Communications Commission helpful: “How to Identify and Resolve Radio-TV Interference Problems.” This Booklet is available from the U.S. Government Printing Office, Washington, D.C. 20402, Stock No. 004-000-00345-4.

FCC Warning

The user is cautioned that changes or modifications not expressly approved by the manufacturer could void the user’s authority to operate the equipment.

This device complies with Part 15 of FCC Rules. Operation is subject to the following two conditions;

- (1) This device may not cause harmful interference, and
- (2) This device must accept any interference received, including interference that may cause undesired operation.

safety information

The safety precautions illustrated below are to prevent personal injury or material damages. Heed all instructions carefully.



WARNING

Means that there is a potential risk of serious personal injury.



Prohibited action.



Do not touch the product.



CAUTION

Means that there is a potential risk of personal injury or damage to the product.



Do not disassemble the product.



This precaution must be kept.



WARNING



Using the camcorder at temperatures over 60°C (140°F) may result in fire. Keeping the battery at a high temperature may cause an explosion.



Do not allow water or metal and inflammable matter to enter the camcorder. Doing so may pose a fire hazard.

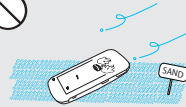

No sand or dust! Fine sand or dust entering the camcorder could cause malfunctions or defects.



No oil! Oil entering the camcorder could cause electric shock, malfunctions, or defects.



Do not aim the camcorder directly into the sun. Doing so could cause eye injuries, as well as lead to malfunctioning of internal parts of the product.



Do not dispose of the battery in a fire as it may explode.

safety information

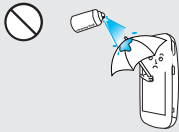

Never use cleaning fluid or similar chemicals to clean the camcorder. Do not spray cleaners directly on the camcorder.



Keep the camcorder away from water when using it near the beach or pool or when it rains. There is a risk of malfunction or electric shock.



Keep the used lithium battery or memory card out of the reach of children. If the lithium battery or memory card is swallowed by a child, consult physician immediately.

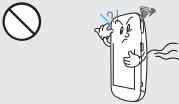

If the camcorder emits an abnormal sound or smell, or smokes, immediately detach the battery from the camcorder and request service from a Samsung service center. There is a risk of fire or personal injury.



If the camcorder malfunctions, immediately detach the battery from the camcorder. There is a risk of fire or injury.

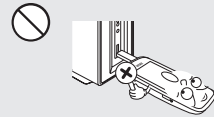

Connect the USB plug to a USB jack on a PC or an adaptor. Do not insert the plug forcibly if it does not match the jack. You can break the plug.



Do not touch the USB cable or plug with wet hands. There is a risk of electric shock.

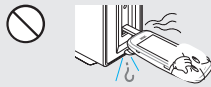

If the USB cable gets hot or the camcorder emits an abnormal sound or smell when charging or when sending data, unplug the power cord immediately and request service from a Samsung service center. There is risk of fire or personal injury.

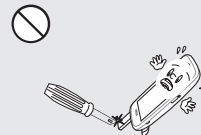

Don't disassemble or attempt to repair the USB cable. There is a risk of fire or electric shock.

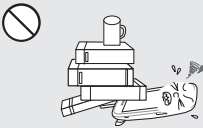

Do not place heavy objects on the USB cable. Heavy objects can cause the cable to break or disconnect from the camcorder.

! CAUTION

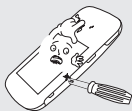

Do not press the surface of the LCD with force, or hit it with a sharp object. If you push the LCD surface, display unevenness may occur.



Do not drop or expose the camcorder, battery or other accessories to severe vibrations or impact. This may cause a malfunction or injury.



Do not use the camcorder on a tripod (not supplied) in a place where the tripod is subject to severe vibrations or impact.



Do not use the camcorder in direct sunlight or near heating equipment. The heat may cause a malfunction or injury.



Do not leave the camcorder in a closed vehicle for a long time, where the temperature is very high.



Do not expose the camcorder to soot or steam. Thick soot or steam could damage the camcorder case or cause a malfunction.



Do not use the camcorder near dense exhaust gas generated by gasoline or diesel engines, or near a corrosive gas such as hydrogen sulphide. Doing so may corrode the external or internal terminals, disabling normal operation.



Do not expose the camcorder to insecticide. Insecticide entering the camcorder could cause the product to operate abnormally. Turn the camcorder off and cover it with vinyl sheet, etc. before using insecticide.



Do not expose the camcorder to sudden changes in temperature or high humidity. There is also a risk of defect or electric shock when using outdoors during lightning storms.

safety information



Do not wipe the camcorder body with benzene or thinner. The exterior coating could peel off or the case surface could deteriorate.

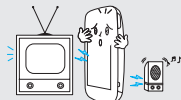

Do not use the camcorder near a TV or radio. It can cause distortion on the TV screen or interference on the radio.

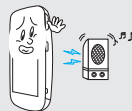

Do not use the camcorder near sources of strong radio waves or magnetism such as speakers or large motors. Noise from these sources could distort the video or audio you are recording.

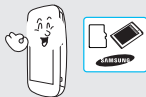

Use Samsung-approved accessories only. Using products from other manufacturers may cause overheating, fire, explosion, electric shock, or personal injuries caused by abnormal operation.



Place the camcorder on a stable surface that is well ventilated.



Keep important data separately. Samsung is not responsible for data loss.

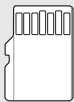

Manufacturers of unauthorized accessories compatible with this camcorder are responsible for their own products. Use the optional accessories according to their safety instructions. Samsung is not responsible for any malfunctions, for fires or electric shocks, or for damage caused by unauthorized accessories.

contents

QUICK START GUIDE

06

GETTING TO KNOW THE CAMCORDER

- 10 What's included with your camcorder
- 11 Location of controls
- 13 Identifying the screen displays

10

GETTING STARTED

- 17 Using the battery
- 19 Checking the battery state

17

BASIC OPERATION OF THE CAMCORDER

- 22 Turning your camcorder on/off
- 23 Setting the operating modes
- 24 Using the touch panel

22

FIRST TIME SETTINGS

- 25 Turning the power on for the first time and setting the date and time
- 26 Selecting the OSD language

25

contents

GETTING READY TO START RECORDING

27

- 27 Inserting/ejecting a memory card (not supplied)
- 28 Selecting a suitable memory card (not supplied)
- 30 Recordable time and capacity
- 31 Using the hand strap
- 31 Using the lens

BASIC RECORDING

32

- 32 Recording videos
- 34 Recording photos
- 35 Capturing photos during video recording (dual recording)
- 36 Zooming in and out

BASIC PLAYBACK

37

- 37 Changing the playback mode
- 38 Playing videos
- 41 Viewing photos

ADVANCED RECORDING

43

- 43 Using the menu tab in the record mode
- 43 Recording menu items
- 44 Video Resolution
- 45 Photo Resolution
- 46 Smart Filter
- 48 Panorama
- 49 Quick View

ADVANCED PLAYBACK

50

- 50 Using the menu tab in the play mode
- 50 Playback menu items
- 51 Deleting files
- 52 Protection from accidental erasure
- 53 Share Mark

SYSTEM SETTING

54

- 54 Using the setting menu tab
- 55 Setting menu items
- 55 Storage Info
- 56 File No.
- 56 Date/Time Set
- 57 Date/Time Display
- 57 LCD Brightness
- 58 Auto LCD Off
- 59 Beep Sound
- 59 Shutter Sound
- 60 Auto Power Off
- 61 PC Software
- 62 Format
- 63 Default Set
- 63 Language
- 64 Demo

USING WITH A WINDOWS COMPUTER

65

- 65 What you can do with a windows computer
- 66 Using the intelli-studio program
- 72 Using as a removable storage device

CONNECTING TO OTHER DEVICES

74

- 74 Connecting to a TV
- 75 TV image displays

TROUBLESHOOTING

- 76 Warning indicators and messages
- 78 Symptoms and solutions

MAINTENANCE & ADDITIONAL INFORMATION

- 84 Maintenance
- 85 Using your camcorder abroad

SPECIFICATIONS

- 86 Specifications

quick start guide

This quick start guide introduces the basic operation and features of your camcorder. See the reference pages for more information.

You can record videos in H.264 format!

You can record videos in the H.264 format that are convenient to email and share with your friends and family. You can also take photos with your camcorder.

STEP 1: Get ready

1. Pull to open the battery cover in the direction of the arrow as shown in the figure. ↪page 17
2. Insert a memory card.
 - You can use commercially available micro SDHC (SD High Capacity) or micro SD memory cards with this camcorder. ↪page 28
3. Insert the battery into the battery slot.
4. Charge the battery fully by using the built-in USB plug of the camcorder.
 - ↪page 18
 - The battery is fully charged when the CHG (charging) indicator light turns green.

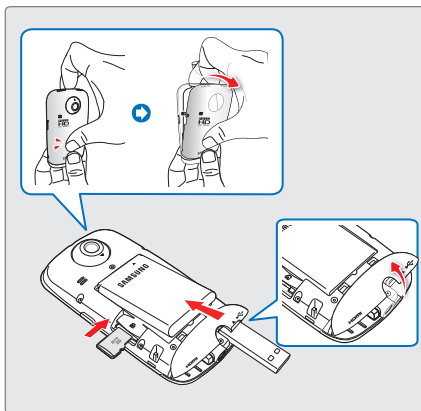

STEP 2: Record with your camcorder

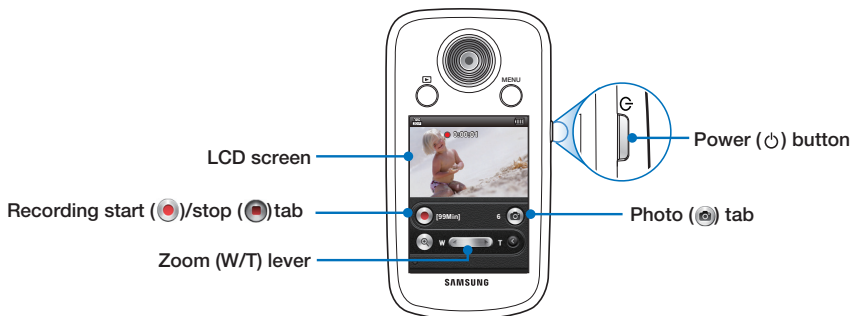

Recording videos

Your camcorder uses advanced H.264 compression technology to give you the clearest video quality.

1. Press the **Power** (**⏻**) button.
2. While in the STBY mode, touch the **Recording start** (**⏻**) tab on the LCD screen to start recording.
 - To stop recording, touch the **Recording stop** (**⏻**) tab.

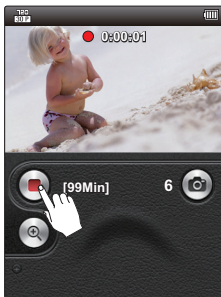

Recording photos

Your camcorder can record high quality photos with a 4:3 or 16:9 aspect ratio.

1. Press the **Power** (**⏻**) button.
2. Frame the subject to be recorded, and touch the **Photo** (**📷**) tab on the LCD screen.
3. When you release the **Photo** (**📷**) tab, a photo is recorded.

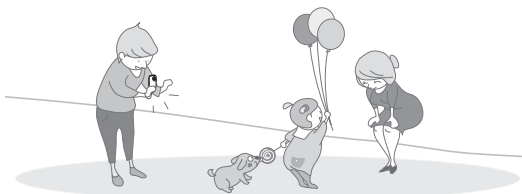

- Your camcorder is compatible with the H.264 recording format, which achieves efficient coding of high quality video using less memory capacity.
- The default setting is "720/30p". You can select the resolution for video recordings. ↪ page 44
- You can take photos while you are recording videos. ↪ page 35

quick start guide

STEP 3: Play back videos or photos

Viewing videos or photos on the LCD screen

You can find recordings quickly by using the thumbnail index view.

1. Press the **Mode** (▶) button to select the play mode.
2. Touch the video or photo thumbnail (📷 / 📹) tab, and then touch the thumbnail of the video or photo you want to view.
 - The recorded videos or photos appear in the thumbnail index view.
 - The thumbnail of the latest created or played file is highlighted.

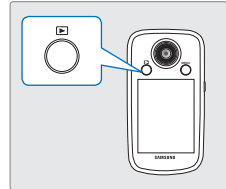

You can switch from the play mode to the record mode by pressing the **Mode** (▶) button.

Viewing on a high definition TV

You can enjoy HD (High Definition) videos on a connected HDTV. ➔page 74

STEP 4: Save recorded videos or photos

Simple and fun! Enjoy the various features of the built-in Intelli-studio program on your Windows computer.

Using the Intelli-studio program built into your camcorder, you can import videos/photos into your computer and edit or share the videos/photos with your friends. ➔pages 66~71

Importing videos/photos from your camcorder and viewing them on your PC

1. Start the Intelli-studio program by connecting the built-in USB plug of the camcorder to the PC.
 - A new file saving screen appears with the Intelli-studio main window. Click **"Yes."** The uploading procedure starts.
2. Any new files are saved to your PC and registered to **"Contents Manager"** in the Intelli-studio program.
 - You can arrange the files by different options such as Face, Date, Location, etc.
3. Double-click the file you would like to play back.

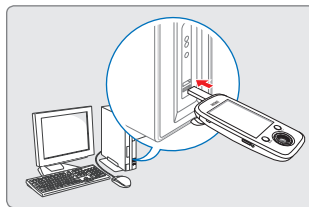

Contents Manager Saved files into your PC

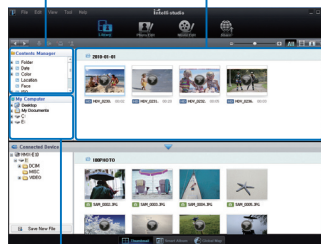

Folders directory on your PC

Sharing videos/photos on Youtube/Flickr/FaceBook

Share your contents with the world, by uploading videos and photos directly to a web site with a single click. Click **"Share"** → **"Upload"** on the browser. ↪ page 69



Intelli-studio runs automatically after you've connected your camcorder to a Windows computer if you have set **"PC Software: On"**. ↪ page 61

STEP5: Delete videos or photos

If the camcorder's storage media is full, you cannot record new videos or photos. Delete videos or photos you've saved to your computer from the camcorder's storage media. Then you can record new videos or photos in the newly freed-up space.

Press the Mode (📺) button to switch to the play mode → Press the MENU button → Touch the "Delete" 🗑️ tab on the LCD screen. ↪ page 51

getting to know the camcorder

WHAT'S INCLUDED WITH YOUR CAMCORDER

Your new camcorder comes with the following accessories. If any of these items are missing from your box, call Samsung's Customer Care Center.



Model name	Color	Memory card slot	LCD screen	Lens
HMX-E10WN	White	Yes	Color	Digital zoom: x2
HMX-E10BN	Black			
HMX-E10ON	Orange			

- The shape is the same for all models. Only the color is different.

Checking your accessories



Battery (BP90A)
(AD43-00198A)

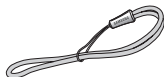

Hand strap
(AD63-05498A)



User manual CD
(AD46-00357A)

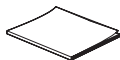

Quick start guide
(AD68-05495A)

Optional accessories



Mini HDMI cable
(AD39-00159A)



- The contents may vary depending on the sales region.
- Parts and accessories can be purchased after consulting with your local Samsung dealer. SAMSUNG is not responsible for reduced built-in battery life time or malfunctions caused by any unauthorized use of accessories such as the battery.
- A memory card is not included. See page 28 for memory cards compatible with your camcorder.
- Your camcorder includes the user manual CD and printed quick start guide.

LOCATION OF CONTROLS

Rear & Right side

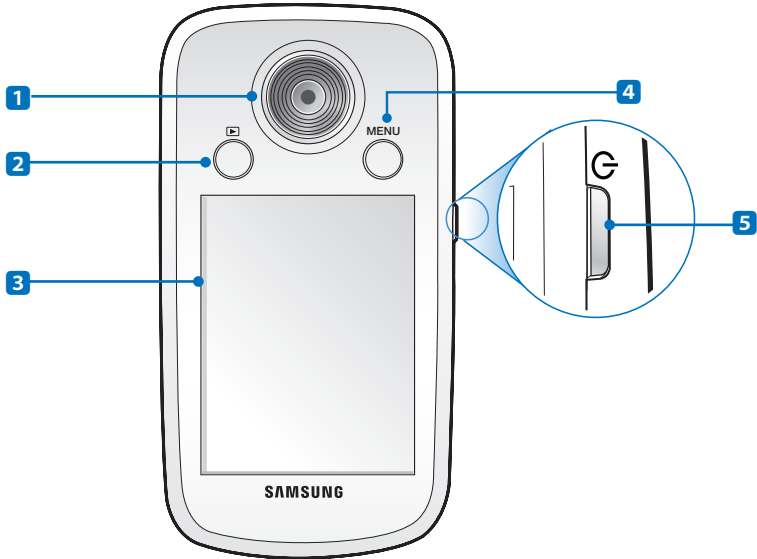

1 Lens

2 Mode (▶) button

3 LCD screen

4 MENU button

5 Power (⏻) button

getting to know the camcorder

Front/Right/Bottom side

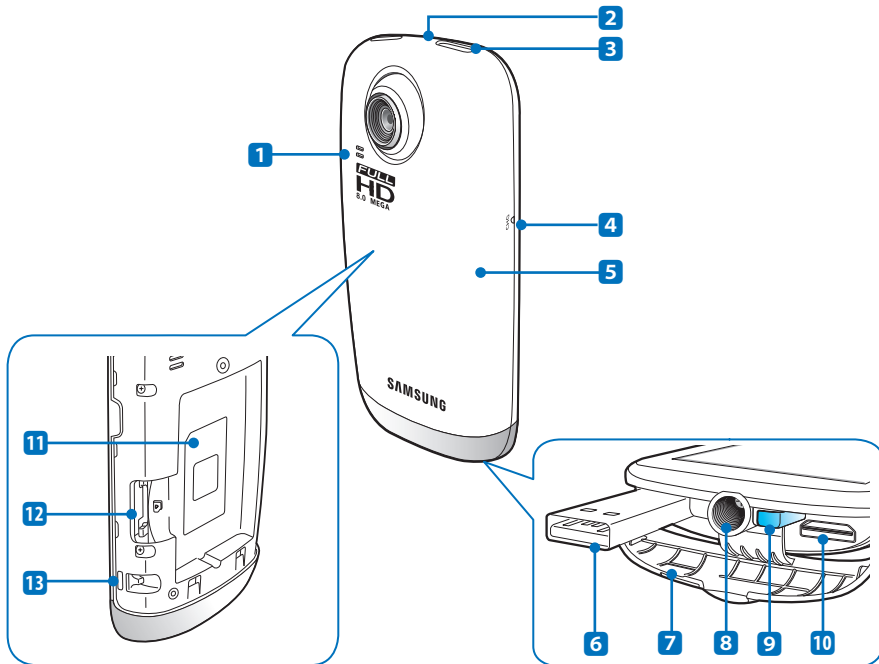

1 Built-in speaker

2 Battery cover open hole

3 Internal microphone

4 CHG (Charging) indicator

5 Battery cover

6 Built-in USB plug

7 Jack cover

8 Tripod receptacle

9 Built-in USB eject button

10 HDMI jack

11 Battery slot

12 Memory card slot

13 Hand strap hook



IDENTIFYING THE SCREEN DISPLAYS

The available functions vary depending on the operation mode you've selected. Different indicators appear depending on the setting values.

PRECHECK!

- This On Screen Display (OSD) is shown only when the camcorder is in Video Record mode.
- Select the Record mode by pressing the **Mode** (▶) button. ▶ page 23

Video Record mode

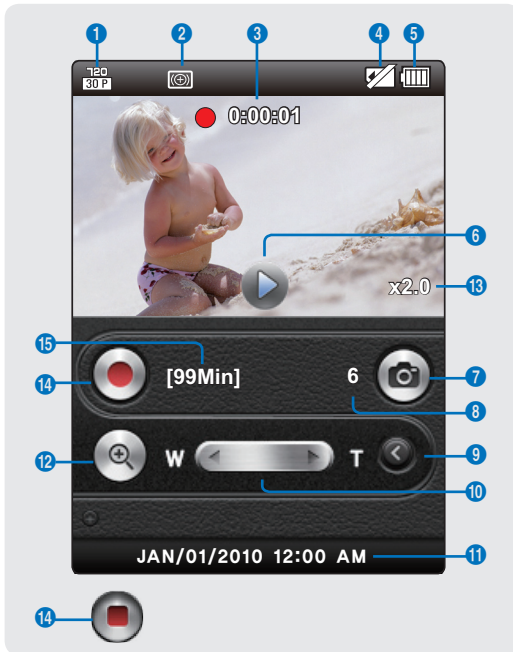

- 1 Video resolution
- 2 Smart Filter
- 3 Operating mode (**STBY** (Standby) / ● 0:00:01 (Recording/Recording time))
- 4 Storage media (Memory card)
- 5 Battery info. (remaining charge level)
- 6 Quick view
- 7 Photo tab
- 8 Photo Remain Counter (total number of recordable photos)
- 9 Close zoom tab
- 10 Zoom lever
- 11 Date/Time display
- 12 Open/Close zoom tab
- 13 Zoom ratio
- 14 Recording start (●) tab / Recording stop (●) tab
- 15 Remaining recordable time



- The on-screen indicators are based on an 8GB micro SDHC memory card.
- The screen above is an example and may differ from the actual display.
- For enhanced performance, the display indications and order are subject to change without a prior notice.
- This camcorder provides one combined video and photo record mode. You can easily record videos or photos in the same mode without having to change it.
- The total number of recordable photos is based on available space on the storage media.
- The largest number the photo counter can display is 9999.
- For warning indicators and messages, see pages 76~77.

getting to know the camcorder

PRECHECK!

- This On Screen Display (OSD) is shown only when the camcorder is in Photo Record mode.
- Select the Record mode by pressing the **Mode** (▶) button. → page 23

Photo Record mode



- 1 Photo resolution
- 2 Smart Filter
- 3 Half shutter
- 4 Storage media (Memory card)
- 5 Battery info. (remaining charge level)
- 6 Auto focus frame
- 7 Quick view/shutter display
- 8 Photo tab
- 9 Photo counter (total number of recordable photos)
- 10 Date/Time display

PRECHECK!

- This On Screen Display (OSD) is shown only when the camcorder is in Video Play mode.
- Select the Play mode by pressing the **Mode** (▶) button, and then touch the Video (📺) tab. ↪page 23

Video play mode : Thumbnail View



- 1 Video Play mode
- 2 Battery info. (remaining charge level)
- 3 Error File
- 4 Scroll bar
- 5 Share mark
- 6 Next page tab
- 7 Now/ Total page number
- 8 Previous page tab
- 9 Erase protection
- 10 Highlight

Video play mode : Single View

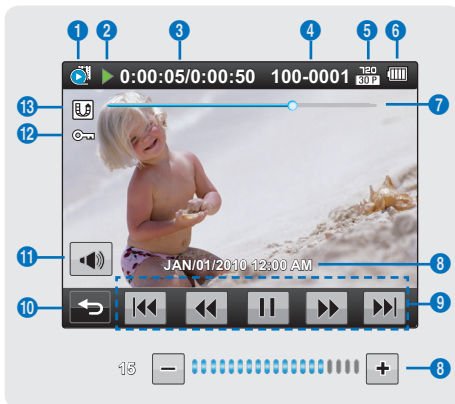

- 1 Video Play mode
- 2 Operating status (play/pause)
- 3 Time code (elapsed time/recorded time)
- 4 File name (file number)
- 5 Video resolution
- 6 Battery info. (remaining charge level)
- 7 Playback progress bar
- 8 Recorded date/time display/ Volume control tabs (−) / (+)
- 9 Playback control tabs
 - a (⏮): Reverse skip
 - b (⏪): Reverse search
 - c (▶/⏸): Play/Pause
 - d (⏩): Forward search
 - e (⏭): Forward skip
- 10 Return tab
- 11 Volume tab
- 12 Erase protection
- 13 Share mark

getting to know the camcorder

PRECHECK!

- This On Screen Display (OSD) is shown only when the camcorder is in Photo Play mode.
- Select the Play mode by pressing the **Mode** (▶) button, and then touch the Photo (📷) tab. ▶page 23

Photo play mode : Thumbnail View



- 1 Photo play mode
- 2 Battery info. (remaining charge level)
- 3 Error File
- 4 Scroll bar
- 5 Next page tab
- 6 Now/ Total page number
- 7 Previous page tab
- 8 Erase protection
- 9 Highlight

Photo play mode : Single View



- 1 Photo play mode
- 2 Slide show
- 3 Photo image counter (current image/ total number of recorded images)
- 4 File name (file number)
- 5 Photo Resolution
- 6 Battery info. (remaining charge level)
- 7 Recorded date/time display
- 8 (◀): Previous image tab
- 9 (▶): Slide show start tab
- 10 (▶▶): Next image tab

getting started

USING THE BATTERY

Purchase extra batteries to allow continuous use of your camcorder.

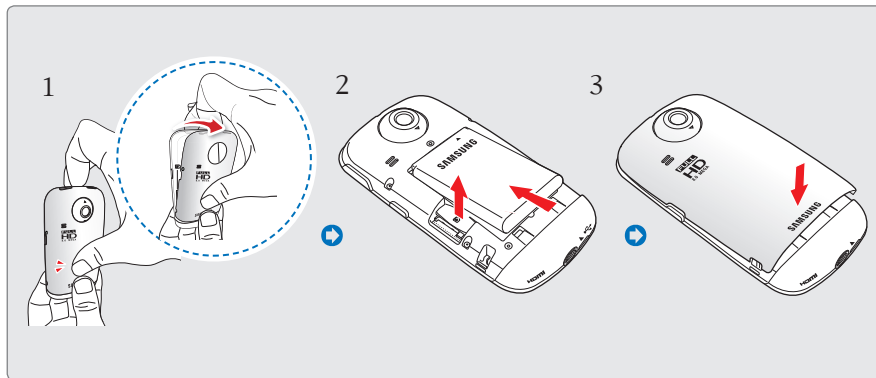

Inserting the battery

1. Pull the battery cover in the direction of the arrow as shown in the figure to open.
2. Push in the battery in the direction of the arrow as shown in the figure.
 - Align the triangle mark of the battery to the battery contacts when you insert the battery as shown in the figure.
3. Close the battery cover.

Ejecting the battery

1. Pull the battery cover in the direction of the arrow as shown in the figure to open.
2. Pull out the battery in the direction of the arrow as shown in the figure.
3. Close the battery cover.



- Use only Samsung-approved batteries. If you use batteries from other manufacturers, there is a danger of overheating, fire, or explosion.
- Samsung is not responsible for problems caused by unapproved batteries.

getting started

Charging the battery

PRECHECK!

- Be sure to charge the battery before you start using your camcorder.
- You can charge the camcorder's battery with the built-in USB plug of the camcorder or the USB charger (not supplied).

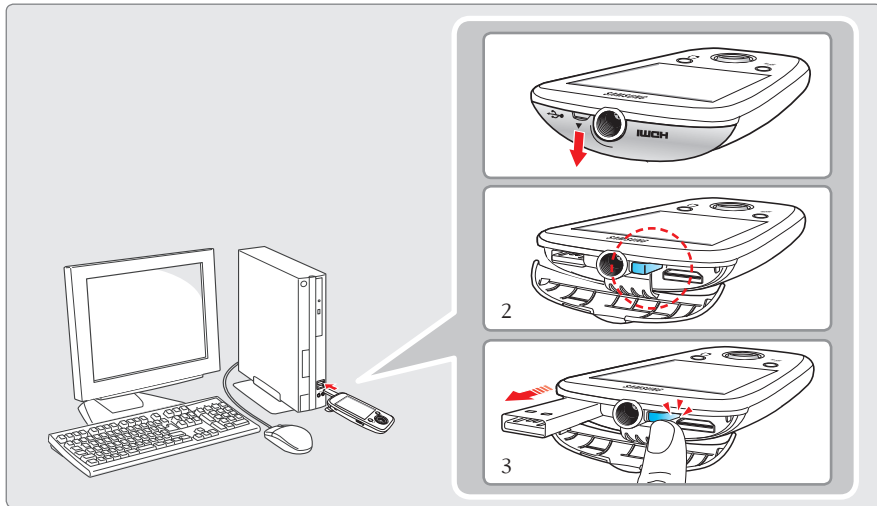

1. Press the **Power** (⏻) button to turn off the camcorder.
2. Open the Jack cover and press the [USB eject] button to pop out the built-in USB plug.
3. Connect the built-in USB plug of the camcorder to the USB port of a PC.
 - The charging (CHG) indicator lights up and charging starts. After the battery is fully charged, the charging (CHG) indicator turns green. →page 19
4. When the charging is completed, detach the USB plug from the computer, and then push in the built-in USB plug while pressing the [USB eject] button.



- You can charge the camcorder with the USB charger (not supplied).
- Do not push the Built-in USB plug forcibly.
- This camcorder has a built-in USB plug which pops out at the press of a single button.
- Depending on your computer environment, you can attach an external USB cable (not supplied) to the camcorder's USB plug and your computer's USB port to charge the camcorder.
- The camcorder will be charging if its built-in USB plug is connected to a PC even when it is turned on.

CHECKING THE BATTERY STATE

You can check the charging state and remaining battery capacity.

To check the charging state

The color of the LED indicates the power or charging state.

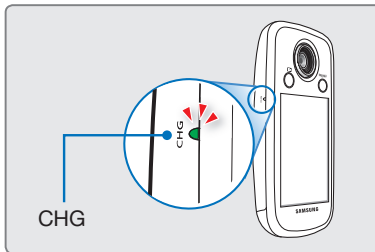







Charging (CHG) indicator

The color of the charging indicator shows the charging state.

Charging state	Charging	Fully charged	Error
LED color	 (Orange)	 (Green)	 (Orange Blink)

Battery level display

The battery level display shows the amount of battery power remaining in the battery.

Battery level indicator	State	Message
	Fully charged	-
	25~50% used	-
	50~75% used	-
	75~95% used	-
	95~98% used	-
	Exhausted (flickers): The device will be forced to turn off after 3 minutes. Change the battery as soon as possible.	-
	After 3 seconds, the camcorder turns off.	“Low Battery”

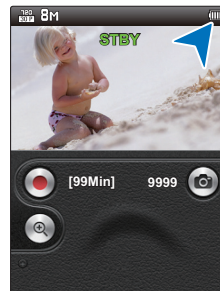

The figures above are based on a fully charged battery operating at normal temperature. Low ambient temperature may decrease the use time.

getting started

Available running time for the battery

Battery type		BP90A
Charging time		Approx. 190 min. (Use the Built-in USB plug)
Mode Resolution	Continuous recording time	Playback time
1080/30P	Approx. 80 min.	Approx. 140 min.
720/30P	Approx. 90 min.	Approx. 150 min.

- Charging time: Approximate time in minutes (min.) required to fully charge a completely exhausted battery.
- Recording/Playback time: Approximate time available when you have fully charged the battery.
- The times are only for reference. Figures shown above are measured in Samsung's test environment. Your times may differ depending on your usage and conditions.
- The recording and playback times will be shorter when you use your camcorder in low temperatures.

Continuous Recording (without zoom)

The continuous recording time above shows the available recording time when you record without using any other function after recording starts. The battery pack may discharge 2-3 times faster than this reference if you use the record start/stop frequently and the zoom functions, and then playback your recordings. Prepare additional charged battery pack(s) to cover the time you are planning to record on the camcorder.



- The charging time will vary depending on the remaining battery level.
- Depending on your PC specifications, the charging time can be prolonged.

About the battery

• Battery Properties

A lithium-ion battery is small-sized and has a high capacity. Low ambient temperature (below 50° F/10° C) may shorten its life-span and affect its function. Before recording in low temperatures, put the battery into your pocket to warm it, then install it in the camcorder.

- **Charge an extra battery before using the camcorder outdoors.**
 - The cold temperature may shorten the length of time you can use the battery before needing to recharge it.
- **Check whether the battery terminal is damaged if the battery falls or is dropped.**
 - If you install a battery with the damaged terminal into the camcorder, you can damage the camcorder.
- **Throw away the dead battery into a recycling bin.**
- **The battery lifetime is limited.**
 - Battery capacity decreases over time and through repeated use. If decreased usage time between charges becomes significant, it is probably time to replace the battery with a new one.
 - Each battery's life is affected by storage, operating, and environmental conditions.
- A USB connection by itself can not operate the camcorder. You must install the battery.
- If you use a USB charger, the charger should provide 500mA at a minimum of 5V and a maximum of 6V.

Maintaining the battery

- **Make sure to store the battery separately after use.**
 - A small amount of battery power is consumed when the battery is stored in the camcorder even if the camcorder power is off.
 - If the battery is installed and left in the camcorder for a long time, the battery discharges. If this occurs, you may not be able to use the battery, even if you charge it fully.
 - Keep the battery out of reach of children.
 - To store the battery for a long time, we recommend you keep the battery charged at about half of its full capacity and charge the battery once every 3 months.
- **Remove the battery and the memory card from the camcorder after use.**
 - Store the battery in a stable, cool, and dry place.
(Recommended temperature : 59°F ~ 77°F (15C°~ 25C°), recommended humidity: 40%~ 60%)
 - Temperatures that are too high or too low shorten the battery lifetime.
 - The battery terminals can become rusty or malfunction if the battery is stored in a smoky or dusty location.

About the battery life

- Battery capacity decreases over time and through repeated use. If decreased usage time between charges becomes significant, it is probably time to replace the battery with a new one.
- When the battery reaches the end of its life, please contact your local Samsung dealer for a replacement.

basic operation of the camcorder

This chapter introduces you to the basic operation procedures of this camcorder, such as turning the power on/off and switching modes.

TURNING YOUR CAMCORDER ON/OFF

You can turn the power on or off by pressing the **Power** (⏻) button.

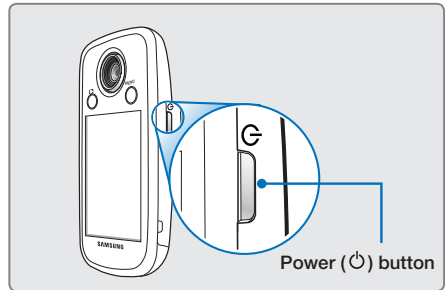

- This camcorder provides one record mode for both video and photo recordings. You can easily record videos or photos in the same mode without having to switch modes.
- When the camcorder is turned on, the self-diagnosis function operates and a message may appear. If this occurs, refer to "Warning indicators and messages" (on pages 76-77) and take corrective action.

When using this camcorder for the first time

When you use your camcorder for the first time or reset it, the date and time set screen appears as the start-up display. Set the date and time. ➔page 25

SETTING THE OPERATING MODES

You switch the operating mode in the following order each time you press the **Mode (▶)** button:

Record mode ↔ Play mode

- You can choose the video or photo thumbnail view display options by touching the Video (📹) or Photo (📷) tab on the LCD screen.
- When switching to play mode, you can enjoy landscape playback by rotating the camcorder from a vertical to a horizontal position.

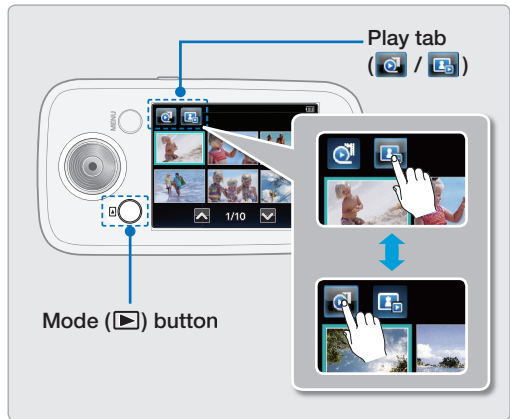

Mode	Functions
Record mode	To record videos or photos.
Play mode	To play videos or photos.

🔍 Record mode

Easy one-handed recording and button operations.

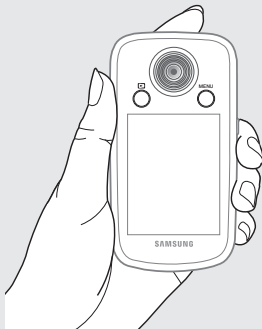

🔍 Playback mode

When switching to the play mode, you can enjoy a landscape playback by rotating the camcorder.

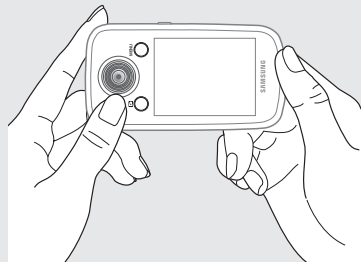

basic operation of the camcorder

USING THE TOUCH PANEL

The touch panel lets you play back and record with a simple touch of your finger. Hold the camcorder firmly in one hand to support it. Then, touch the items displayed on the screen.



Touch

Slightly touch the items or functions to select or execute with your finger.



Drag

Drag the image left or right on the LCD screen to go to the previous or next file.



- Do not place a protective film on the LCD screen.
- If you leave a film attached to the LCD screen for a long time, strong adhesion between the film and the surface of the screen may cause the touch panel to malfunction.





- Be careful not to accidentally press the buttons near the LCD panel while using the touch panel.
- The tabs and indicators that appear on the LCD screen depend on the current recording/playback status of your camcorder.
- The camcorder does not recognize touches if you touch more than two points on the screen at the same time. Touch one point at a time.
- Do not use a sharp tipped item such as pen or pencil when using a tool to touch the screen.

first time settings

TURNING THE POWER ON FOR THE FIRST TIME AND SETTING THE DATE AND TIME

Set the date and time of your local area when you turn on the camcorder for the first time.

1. Press the **Power** (⏻) button to turn on the camcorder.
 - When you turn on your camcorder for the first time, the Date/Time Set screen appears.
2. Set the date and time by touching the corresponding item or dragging the Up (↑) or Down (↓) tabs.
3. Touch the (OK) tab.
 - The message “Date/Time Set” appears.

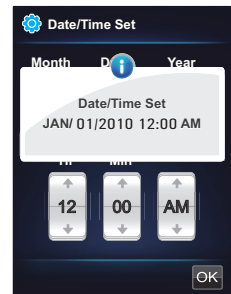

- The year can be set up to 2040.
- Set “Date/Time Display” to On. ➔ page 57

Built-in rechargeable battery

- Your camcorder includes a built-in rechargeable battery that retains the date and time settings even after the power is turned off.
- If the battery is depleted, the current date/time values are reset to the default values. You need to recharge the built-in rechargeable battery (see below), and then re-set the current date and time.

Charging the built-in rechargeable battery

- The built-in battery is always recharged while the built-in USB plug of the camcorder is connected to a PC or while the battery is inserted.
- If you have not used the camcorder for about **2 months** and have not connected it to a computer using its USB plug or inserted the removable battery, the built-in battery fully discharges. If this occurs, charge the built-in battery by connecting the built-in USB plug to a computer for 24 hours.

first time settings

SELECTING THE OSD LANGUAGE

You can select the language in which the camcorder displays the menu screen and the messages. The language setting is retained when the camcorder is powered off.

1. Press the **MENU** button, and then touch the Setting (⚙️) tab.
2. Drag up/down or touch the Previous (⏪) or Next (⏩) tab until “**Language**” is displayed.
3. Touch “**Language**,” and then touch the desired OSD language.
 - The menu screen and messages are displayed in the language you selected.
4. To exit the menu, touch the Return (⏪) tab.

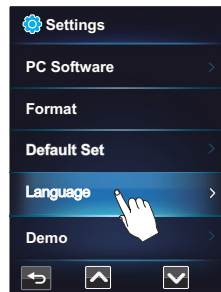
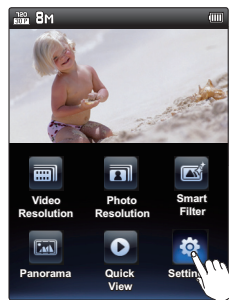

Submenu items

“English” → “한국어” → “Français” → “Deutsch” → “Italiano”
→ “Español” → “Português” → “Русский” → “中文” → “ایرانی”



- “**Language**” options may be changed without a prior notice.
- The camcorder retains the language you select even when the removable battery is not inserted.
- The date and time format may change depending on the language you selected.

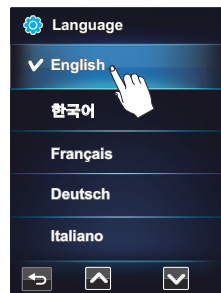

getting ready to start recording

INSERTING/EJECTING A MEMORY CARD (NOT SUPPLIED)

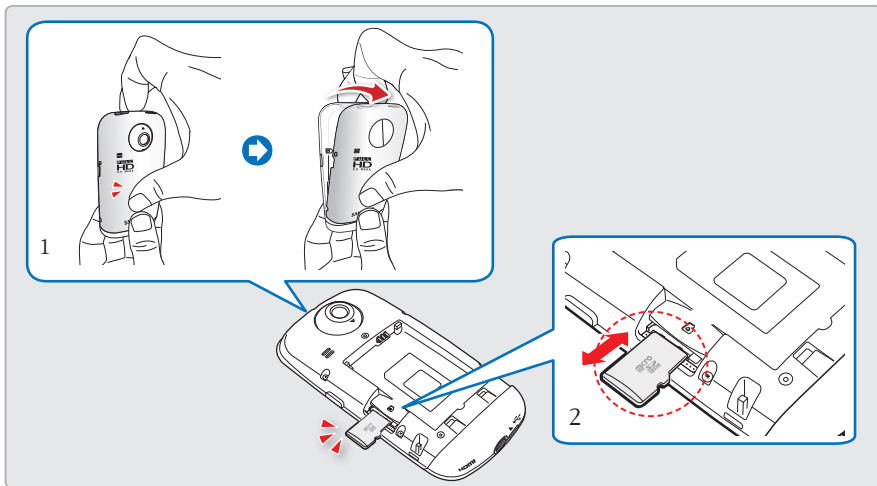

To insert a memory card

1. Pull the battery cover in the direction of the arrow as shown in the figure to open.
2. Insert the memory card into the card slot until it softly clicks.
 - Make sure that the terminal portion is facing down and the camcorder is placed as shown in the figure.
3. Close the battery cover.

To eject a memory card

1. Pull the battery cover in the direction of the arrow as shown in the figure to open.
2. Gently push the memory card to eject it.
3. Close the battery cover.



- To avoid the data loss, turn off the camcorder by pressing the **Power** (⏻) button before inserting or ejecting the memory card.
- Be careful not to push the memory card too hard. The memory card may suddenly pop out.



Your camcorder supports only micro SD (micro Secure Digital) and micro SDHC (micro Secure Digital High Capacity) cards. The compatibility with the camcorder may vary depending on the manufacturer and the type of memory card. ➔ page 28

getting ready to start recording

SELECTING A SUITABLE MEMORY CARD (NOT SUPPLIED)

Compatible memory cards

- Use micro SD (micro Secure Digital) and micro SDHC (micro Secure Digital High Capacity) cards with this camcorder. We recommend you use a micro SDHC (Secure Digital High Capacity) card. The camcorder supports micro SD cards up to 2GB. We can not guarantee normal operation with micro SD cards bigger than 2GB.
- Compatible memory card capacity:
micro SD card : 1GB ~ 2GB
micro SDHC card : 4GB ~ 32GB
- Use compatible memory card brands. Others are not guaranteed to work. A list of compatible brands is below:
 - Panasonic, SanDisk, TOSHIBA
- For video recording, use a memory card that supports faster write speeds (above micro SDHC Class 6).

Micro SDHC (Micro Secure Digital High Capacity) cards

- Micro SDHC (Secure Digital High Capacity) memory cards
 - A micro SDHC card is a higher version (Ver. 2.00) of the micro SD card and supports capacities above 4GB.
 - Use micro SD cards only with micro SD enabled host devices.

Common cautions for memory cards

- Damaged data may not be recovered. We recommend you make a back-up of important data separately on the hard disk of your PC.
- Turning the power off or removing a memory card during an operation such as formatting, deleting, recording, and playback may cause data loss.
- After you modify the name of a file or folder stored in the memory card using your PC, your camcorder may not recognize the modified file.
- The micro memory card does not support any data recovery mode. So care must be taken lest that the memory card should be damaged when making record.

Usable memory card (1GB~32GB)

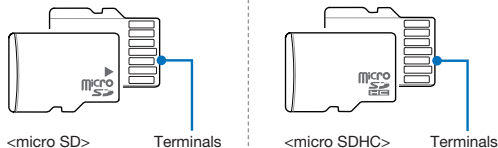

Handling a memory card

- We recommend that you power off before inserting or removing the memory card to avoid data loss.
- You have to format newly-purchased memory cards, memory cards with data that your camcorder cannot recognize or with data saved by other devices. Note that formatting erases all data on the memory card and deleted data cannot be recovered.
- A memory card has a certain life span. If you cannot record new data, you have to purchase a new memory card.
- Do not bend, drop, or subject the card to strong impacts.
- Do not place foreign substances on the memory card terminals. Use a soft dry cloth to clean the terminals if required.
- Do not paste anything other than label provided with the card on the label pasting section.
- Be careful to keep the memory card out of the reach of children, who might swallow it.
- Make sure to format the memory card on this camcorder. If the memory card had been formatted by a PC or other device, using it on this camcorder without formatting may find trouble with recording and/or playback. Samsung is not responsible for damage of recorded contents caused by such reasons.

The camcorder supports micro SD and micro SDHC memory cards, giving you a wider choice of cards!

The data storage speed may differ, depending on the manufacturer and production system.

- SLC (Single Level Cell) system: faster write speed enabled.
- MLC (Multi Level Cell) system: only lower write speed is supported.

For best results, we recommend using a memory card that supports a faster write speed. Using a lower write speed memory card for recording video may cause difficulties when storing. You may even lose your video data during the recording.

In an attempt to preserve every bit of the recorded video, the camcorder forcibly stores the video on the memory card and displays a warning:

“Low speed card. Please record at a lower resolution.”

If you are unavoidably using a low speed memory card, the resolution of the recording may be lower than the value you set. ➔ page 44

The higher the resolution and quality, the more memory the camcorder uses.

Using the memory card adaptor

This camcorder uses micro SD/micro SDHC memory cards.

To use a micro SD/micro SDHC directly with a computer or a card reader you must attach it to or insert it into an adaptor.



- Samsung is not responsible for data loss due to misuse.
- We recommend using a memory card case to avoid data loss caused by motion or static electricity.
- After a period of use, the memory card may get warm. This is normal and is not a malfunction.

getting ready to start recording

RECORDABLE TIME AND CAPACITY

- The following tables show the camcorder's maximum recording time and number of images by video or photo resolution and memory card capacity.
- Please note the approximate maximum limits for recording videos and photos.

Recordable time for videos

Media Capacity Resolution	Memory Card					
	1GB	2GB	4GB	8GB	16GB	32GB
1080/30p	6 min	13 min	27 min	55 min	112 min	223 min
720/30p*	12 min	24 min	49 min	100 min	201 min	400 min

(Unit: Approximate minutes of recording)

Recordable number of photos

Media Capacity Resolution	Memory Card					
	1GB	2GB	4GB	8GB	16GB	32GB
8M (3264x2448)*	484	968	1986	3987	8037	9999
6M (3264x1840)	645	1289	2643	5305	9999	9999
5M (2592x1944)	768	1536	3150	6323	9999	9999
2M (1920x1080)	1868	3733	7655	9999	9999	9999

(Unit: Approximate number of images)

1GB \approx 1,000,000,000 bytes : Actual formatted capacity may be less as the internal firmware uses a portion of the memory.



- Actual recording times may differ depending on the recording conditions and the subject.
- The higher the resolution settings, the more memory is used.
- High resolution images occupy more memory space than low resolution images. If you select higher resolutions, there is less space to record videos in the memory.
- When recording complex videos with a lot of action and color, the file size will be larger.
- Memory cards bigger than 32GB may not work properly.
- When a video file exceeds 1.8GB, a new video file is created automatically.
- You can store up to 9999 videos and photos in one folder.
- The above items marked with * indicate the default setting.

USING THE HAND STRAP

Attach the strap and place your hand through the loop to prevent the camcorder from being dropped.

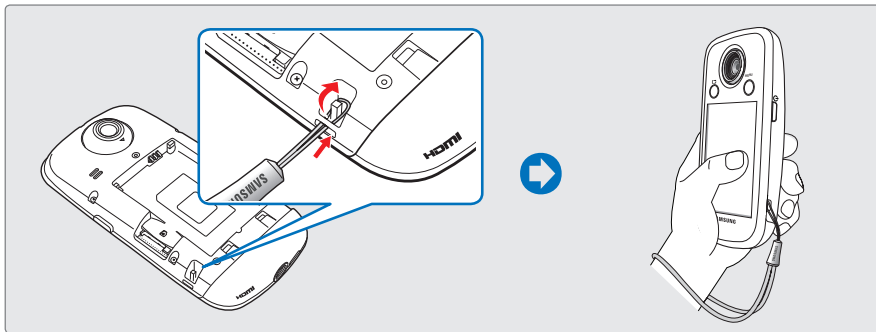

You can easily attach the strap through the loop when holding the very end of the strap.

USING THE LENS

You can easily record images of yourself or others from various angles by using the 270° rotating lens.

1. Align your subject in the frame.
2. By turning the lens, the 270° rotating lens adjusts freely to your desired recording angle.

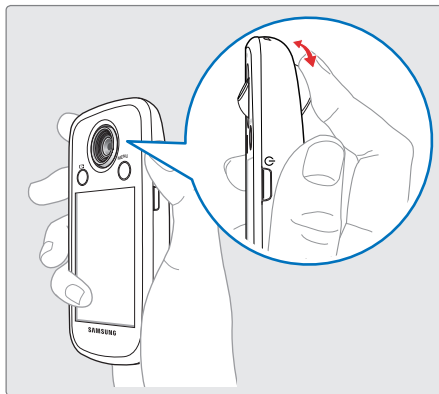

- Excessive rotation may damage the connective hinge between the lens and the camcorder.
- Do not wipe the lens with your fingers during operation. Use a soft, dry cloth to clean the lens if required.

basic recording

RECORDING VIDEOS

- This camcorder supports High Definition (HD) image resolution. Set the resolution you want before recording. ↪page 44
- This camcorder provides one record mode which combines the video and photo record modes. You can easily record videos or photos in the same mode without having to change it.

PRECHECK!

- Insert a memory card. ↪page 27
- Select the record mode by pressing the **Mode** (📷) button. ↪page 23

1. Select a subject to record.
 - Adjust the 270° rotating lens to the best angle for recording.
 - Touch the **Zoom** lever on the LCD screen to adjust the of the subject. ↪page 36
2. Touch the **Recording start** (●) tab on the LCD screen.
 - The recording (●) indicator appears, and recording starts.
 - The number of recordable photos appears next to the **Photo** (📷) tab on the LCD screen. ↪page 35
3. To stop recording, touch the **Recording stop** (⏹) tab.
 - The Quick View icon (▶) appears on the LCD screen.
4. Touch the Quick View (▶) icon to view the most recently recorded video.
 - After the Quick View finishes, your camcorder returns to the STBY mode. You can also touch the Return (⏪) tab.

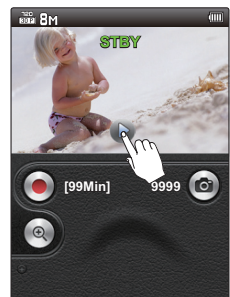
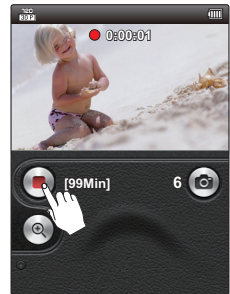



- If the power is off or any error occurs during recording, the camcorder may not record the video.
 - Samsung is not responsible for any damage resulting from a failure of normal recording or playback operation caused by memory card error.
 - Do not turn off the camcorder or remove the memory card while accessing the storage media. Doing so may damage the storage media or the data in the storage media. Note that damaged data cannot be recovered.
 - While you are rotating the lens, a black shadow on the LCD screen can be recorded.
-



- Videos are compressed in the H.264 (MPEG-4,AVC) format.
 - Eject the battery when you have finished recording to prevent unnecessary battery power consumption.
 - For the on-screen information display, see page 13.
 - For approximate recording time, see page 20.
 - Sound is recorded by the internal stereo microphone above the lens. Make sure that the microphone is not blocked.
 - Before recording an important video, make sure to test the recording function to see if there are any problems with audio or video recording.
 - You can adjust the brightness of the LCD screen in the menu options. Adjusting the LCD screen does not affect the image being recorded. ➔page 57
 - For the various functions available during recording, see "Recording menu items." ➔pages 43~49
 - The menu setting tabs shown on the LCD screen do not affect the image you are recording.
 - In the record mode, you can set the Quick View menu option. The Quick View icon appears when you have set the Quick View menu option to On. ➔page 49
 - Recording videos in a quiet environment increases microphone sensitivity that may record surrounding ambient noise.
-

basic recording







RECORDING PHOTOS

You can take photos and store them in the storage media. Set the resolution you want before recording.

↳ page 45

PRECHECK!

- Insert a memory card. ↳ page 27
- Select the record mode by pressing the **Mode** () button. ↳ page 23

1. Select a subject to record.
 - Adjust the 270° rotating lens to the best angle for recording.
 - Touch the **Zoom** lever on the LCD screen to adjust the size of the subject. ↳ page 36
2. Adjust the view so that the subject is at the center of the LCD screen, and then touch the **Photo** () tab on the LCD screen.
 - Your camcorder adjusts to the ideal focus automatically.
 - When the focus is set, the focusing indicator () and frame appear on the LCD screen.
 - If you fail to focus the subject, a red frame can be showed on the LCD screen.
3. When you release the **Photo** () tab, the camcorder records a photo.
 - The camcorder emits a shutter sound (when “**Shutter Sound: On**” is set). The photo indicator () appears on the screen, and the camcorder records the photo image.
 - To continue taking photos, wait until the camcorder saves the current photo completely on the storage media.
 - When the photo is recorded on the storage media, the Quick View icon () appears on the screen.
4. Touch the Quick View () icon to view the most recently recorded photo.
 - To return to the STBY mode, touch the Return () tab.



While you are rotating the lens, a black shadow on the LCD screen can be recorded.



- The recordable number of photos varies depending on the photo resolution. ↳ page 30
- The camcorder does not record audio when you take photos.
- Do not turn off the camcorder or remove the memory card when taking photos. This can damage the storage media or data.
- For the on-screen display information, see page 14.
- Adjust the brightness of the LCD screen using the menu. Adjusting the brightness does not affect the recorded image. ↳ page 57
- Photo files conform to the DCF (Design rule for Camera File system) standard, established by JEITA (Japan Electronics and Information Technology Industries Association).

CAPTURING PHOTOS DURING VIDEO RECORDING (DUAL RECORDING)

Your camcorder can capture photos without interrupting video recording. It is convenient to record a video and photo at the same time without switching modes.

1. Touch the **Recording start** (●) tab on the LCD screen in STBY mode.
 - The recording (●) indicator appears, and video recording starts.
 - The number of recordable capturing photos appear next to the **Photo** (📷) tab on the LCD screen.
2. Aim the camcorder at the scene you want, and then touch the **Photo** (📷) tab.
 - The camcorder records the photo image without a shutter sound.
 - The maximum number of photos you can take per video recording is six.
 - The photo capture icon (📷) appears on the LCD screen. As you capture photos, the number of recordable photos is reduced. When you have reached the six photo limit, the **Photo** (📷) tab is grayed out.
 - The camcorder continues to record video, even while you are taking photos.
 - To stop recording, touch the **Recording stop** (⏹) tab.

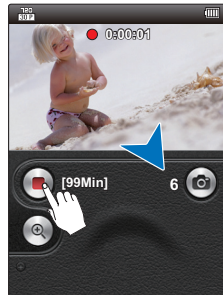

- A preview is available for recorded videos only, even if you have captured still images while recording.
- The camcorder does not produce the shutter sound when capturing a still image during a video recording.
- You can take up to 6 still images per one video recording.
- The resolution of the captured photos depends on the resolution of the video as follows:

Video resolution	Resolution of captured photo
1080/30p	1920x1072 (2M)
720/30p	1280x720 (1M)

basic recording

ZOOMING IN AND OUT

- Use the zoom function for close-up or wide-angle recording.
- Using the **Zoom** lever, you can record with digital zoom.

To zoom in

Slide the **Zoom** lever () towards **T** (telephoto).

- The distant subject is gradually magnified.
- This camcorder provides the zoom magnification as follows.
 - **Digital zoom: x2**

To zoom out

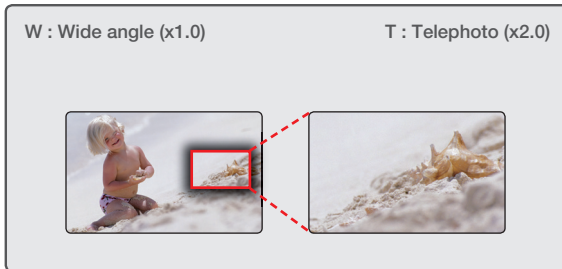

Slide the **Zoom** lever () towards **W** (wide angle).

- The subject appears smaller and further away.
- The smallest zoom ratio is the subject's original size in the zoom-out.



Understanding how to use the zoom lever



1. Touch the Open/Close Zoom () tab on the LCD screen.
2. The Zoom lever screen appears.
3. To close the Zoom lever, touch the Close Zoom () tab on the right side or the Open/Close Zoom () tab.



- Note that the image quality decreases when you use the Digital Zoom. The image quality may deteriorate depending on how much you zoom in on the subject.
- Frequent use of the Zoom function consumes more power.
- The minimum focal length between the camcorder and the subject is about 8 inches (20 cm).
- If you use the zoom while recording, the camcorder may record the noises the camcorder makes when the zoom operates.

basic playback

CHANGING THE PLAYBACK MODE

- You can set the record mode and the play mode in turn with the **Mode** (▶) button.
- When you shift to the play mode, the most recently created file is highlighted in the thumbnail view.
- The camcorder automatically selects the thumbnail display options depending on the STBY mode you used the last time. However, you can choose the video or photo thumbnail view display options by touching the Video (📺) or Photo (📷) tab on the LCD screen.



Understanding how to change the operation modes

- You can easily change the operation modes by touching the LCD screen or using the buttons as shown in the following figure.
- When switching to the play mode, you can enjoy landscape playback by rotating the camcorder 90 degrees clockwise.



Mode (▶) button → “Play Mode” → “Video” ↔ “Photo”

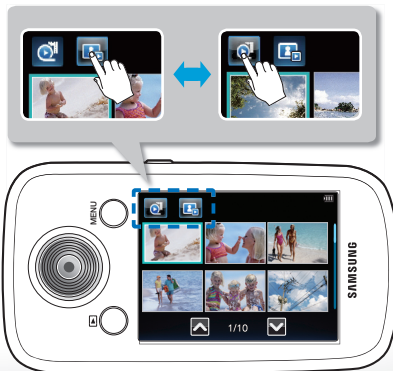

basic playback

PLAYING VIDEOS

You can find the videos you want quickly using the thumbnail index view.

PRECHECK!

- Insert a memory card. ↗page 27
- Select the play mode by pressing the **Mode** (▶) button. ↗page 23

1. Touch the Video (📺) tab.
 - Video thumbnails appear on the screen.
 - To change the current thumbnail page, drag up/down or touch the Previous (⏪) or Next (⏩) tab.
2. Touch the thumbnail of the video you want to play.
 - The camcorder plays the selected video and playback control tabs appear briefly. They reappear when you touch anywhere on the screen.
 - To stop playback and return to the thumbnails, touch the Return (⏪) tab.

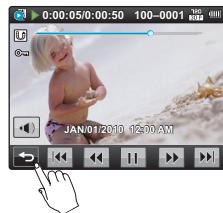

Using the Touch Screen

Drag the thumbnail index view up or down on the LCD screen to go to the previous or next page.

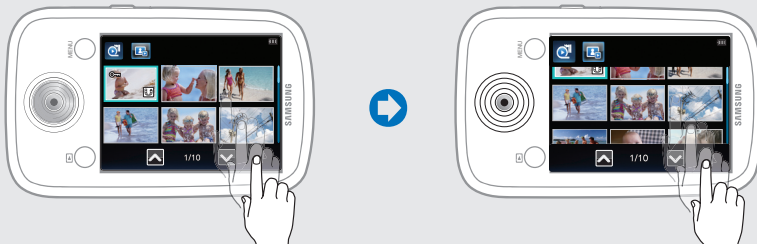



Do not power off or eject the memory card during video playback. Doing so may damage the recorded data.



- The following video files may not play back on the camcorder:
 - Video files with formats that are not supported by the camcorder.
- When you connect the HDMI cable to the camcorder while playing a video, the display will switch to the thumbnail index view automatically.
- You can play back recorded video on a TV or a PC. ↪ pages 75, 68
- You can upload recorded videos or photos to YouTube, Flickr, or FaceBook using Intelli-studio. ↪ page 69
- For various functions available during playback, see "Playback menu items." ↪ pages 50-53
- Loading time may vary depending on the resolution of the selected video.

To adjust the volume during video playback

You can hear the sound through the built-in speaker of the camcorder while the video is playing back on the LCD screen.

1. Touch the Volume (🔊) tab on the LCD screen.
 - Volume control bar appears on the screen.
2. Adjust the volume by touching the Volume Control tabs ([-]/[+]) on the LCD screen.

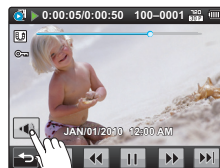

You can adjust the sound level between "0-19." When the level is at "0," you cannot hear sound.

basic playback

Various playback operations

Playback / Pause (▶/⏸)

- Playback and pause alternates when you touch the Play (▶) / Pause (⏸) tab during playback.
- Touch the Return (⏪) tab to stop playback and return to the thumbnail.



Search playback (⏮/⏭)

During playback, each touch of the Reverse search (⏮) / Forward search (⏭) tab increases the play speed:

- RPS (Reverse Playback Search) rate: x2→x4→x8→x16→x32→x2
- FPS (Forward Playback Search) rate: x2→x4→x8→x16→x32→x2



Skip playback (⏮/⏭)

Touch the Reverse skip (⏮) / Forward skip (⏭) tab during playback.

- Touching the Forward skip (⏭) tab plays the next video.
- Touching the Reverse skip (⏮) plays the beginning of the scene. If reverse skip (⏮) is touched within 3 seconds from the start of the file, the previous video is played.
- Place and hold your finger on the Reverse skip (⏮) / Forward skip (⏭) tab to search for a video quickly. When you lift off your finger, the camcorder plays the selected video.



- Touch the Play (▶) tab to play back at normal speed.
- You can hear sound only when the playback is at normal speed.

VIEWING PHOTOS

You can view recorded photos using various playback functions.

PRECHECK!

- Insert a memory card. →page 27
- Select the play mode by pressing the **Mode** (▶) button. →page 23

1. Touch the Photo (📷) tab.
 - Photo thumbnails appear on the screen.
 - To change the current thumbnail page, drag up/down or touch the Previous (⏪) or Next (⏩) tab.
2. Touch the thumbnail of the photo you want to display.
 - The camcorder displays the selected photo in full screen and playback control tabs appear briefly. They reappear when you touch anywhere on the screen.
 - Touch Previous image (⏪)/ Next image (⏩) tab to view the previous and next photo.
 - Place and hold your finger on the Previous Image (⏪)/Next Image (⏩) tab to search for a photo quickly. When you lift off your finger, the camcorder displays the selected photo.
3. To return to the thumbnails, touch the Return (⏪) tab.



Using the Touch Screen

Drag the thumbnail index view up or down on the LCD screen to go to the previous or next page.



Drag the image left or right on the LCD screen to go to the previous or next file.



basic playback



Do not power off or eject the memory card during photo playback. Doing so may damage the recorded data.





- **Your camcorder may not play back the following photo files normally:**
 - A photo with a file format not supported by this camcorder (it does not conform to DCF standards).
 - Loading time may vary depending on the resolution of the photo you selected.
 - This camcorder can support the JPEG file format. (However, note that all JPEG files are not always played back.)

Viewing a slide show

You can view a photo slide show.

Touch the Slide Show () tab during photo playback.

- The () indicator is displayed. The slide show starts from the current selected photo.
- To stop the slide show, touch the Return () tab.



advanced recording

USING THE MENU TAB IN THE RECORD MODE

- You can change the menu settings to customize your camcorder.
- Access the desired menu screen by following the steps below, and then change the various settings.

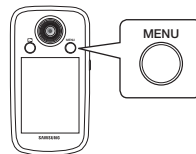

PRECHECK!

- Press the **Power** (⏻) button to turn on the camcorder. ↪page 22
- Select the Record mode by pressing the **Mode** (▶) button. ↪page 23

Using the Menu Tab: An Example

1. Press the **MENU** button in STBY mode.
 - The menu screen appears.
2. Touch the "**Video Resolution** [1080 30P] ." (The Video Resolution function is used here as an example.)
3. Touch the desired option.
4. Press the **MENU** button to exit the menu.



- The camcorder applies the menu item you selected and displays the appropriate indicator.
- There are some functions you cannot activate simultaneously in the menu. Also, you cannot select grayed-out menu items. Refer to Troubleshooting for examples of unworkable combinations of functions and menu items. ↪page 83

RECORDING MENU ITEMS

- The menu items you can access depend on the operation mode.
- For operation details, see the page listed under Page in the table below. ● : available, X : not available

Operation mode	Video	Photo	Default value	Page
Video Resolution	●	X	720x30p	44
Photo Resolution	X	●	[8M] 3264x2448 (4:3)	45
Smart Filter	●	●	Normal	46
Panorama	X	●	Off	48
Quick View	●	●	On	49



These items and default values may be changed without notice.

advanced recording

Video Resolution

You can select the resolution of the video to be recorded.

PRECHECK!

Select the Record mode by pressing the **Mode** (▶) button. ↪ page 23

1. Press the **MENU** button.
2. Touch the "Video Resolution" icon.
 - Touch the desired submenu item.
3. Press the **MENU** button to exit the menu.

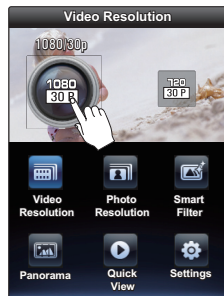
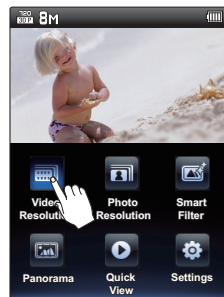

Submenu items

- **1080/30p** (1080 30p): Records in the HD (1920x1080 30p) format.
- **720/30p** (720 30p): Records in the HD (1280x720 30p) format.



<HDTV>
1920x1080 30p
1280x720 30p



<PC/Web/Mobile device>
1280x720 30p





- "30p" indicates the camcorder records in progressive scan mode at 30 frames per second.
- Recorded files are encoded using Variable Bit Rate (VBR). VBR is an encoding system that automatically adjusts the bit rate according to the recording image.
- High resolution images occupy more memory space than low resolution images. If you select the higher resolution, there is less space to record videos in the memory.
- The recording time available depends on the resolution you selected. ↪ page 30

Photo Resolution

You can select the resolution of the photo to be recorded.



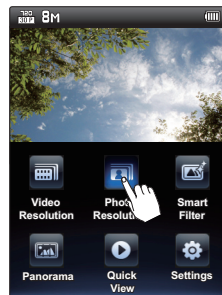

PRECHECK!

Select the Record mode by pressing the **Mode** () button. ↪ page 23

1. Press the **MENU** button.
2. Touch the "**Photo Resolution**  ."
 - You can move to the desired item by touching the  tab.
 - Touch the desired submenu item.
3. Press the **MENU** button to exit the menu.



Submenu items

- **3264x2448** (): Records in 3264x2448 resolution with 4:3 aspect ratio.
- **3264X1840** (): Records in 3264x1840 resolution with 16:9 aspect ratio.
- **2592x1944** (): Records in 2592x1944 resolution with 4:3 aspect ratio.
- **1920X1080** (): Records in 1920x1080 resolution with 16:9 aspect ratio.



- For photo development, the higher the resolution, the finer the image quality.
- The number of recordable images varies depending on the recording environment.
- High resolution images occupy more memory space than low resolution images. If you select a higher resolution, there is less space to store photos in the memory.
- For detailed information on image capacity, see page 30.

advanced recording

Smart Filter

By applying special effects, you can add fun and character to an image. You can apply various filter effects to create unique images.

PRECHECK!

Select the Record mode by pressing the **Mode** (▶) button. ▶page 23

1. Press the **MENU** button.
2. Touch the "**Smart Filter**  ."
 - You can move to the desired item by touching the ◀▶ tab.
 - Touch the desired submenu item.
3. Press the **MENU** button to exit the menu.



Submenu items

- **Normal:** Without any smart filter effect, the camcorder displays a normal, natural image during recording or playback.
- **Miniature:** Make a photo of a life-size location or an object look like a miniature scale image. Blurring parts of the photo makes the scene seem much smaller than it actually is.
- **Vignetting:** Apply the retro-looking colors, high contrast, and strong vignette effect of lomo cameras.
- **Sketch:** Sketch effect mimics a pencil sketch.
- **Defog:** Expressly emphasize blue tones for the sky and reflective objects such as show windows.



Smart Filter Examples



Normal



Miniature



Vignetting



Sketch



Defog



- If you apply the Miniature filter when recording a video, recording starts with a guide message displayed. For such recorded video, its playback time is shorter than the time consumed for recording it.
- If you apply the Miniature filter when recording a video, the camcorder does not record sound.
- If you apply the Smart Filter effect when recording a video, the camcorder automatically records the video in a resolution of **“640x480 15P”** regardless of the resolution setting.
- The following functions cannot be used when the camcorder is in the Smart filter mode:
 - Digital zoom, **“Video Resolution”**, **“Photo Resolution”**
- If you set the Smart Filter to any setting but **“Normal”**, the camcorder sets the photo size to 5M (2592x1944) regardless of the actual resolution setting.

advanced recording

Panorama

The Panorama function lets you capture a wide landscape or tall building in a single picture by holding the Photo tab down and moving or turning the camcorder slowly in one direction.

PRECHECK!

Select the Record mode by pressing the **Mode** (▶) button. →page 23

1. Press the **MENU** button.
2. Touch the "Panorama" icon → "On"
 - Press the **MENU** button to return to the STBY mode.
3. Touch the **Photo** (📷) tab to start recording.
4. Turn or move the camcorder slowly in one direction, while touching the **Photo** (📷) tab.
 - On the center of the LCD screen, the angle guide appears.
 - A recording progress bar appears on the LCD screen.
 - The Panorama function supports recording in one direction only.
5. When you release the **Photo** (📷) tab, a photo is recorded.
 - It aborts taking panorama if moving direction changes or moving speed is too fast.

Submenu items

- **Off:** Disables the function.
- **On:** Move your camcorder in one direction while touching the **Photo** (📷) tab to take a panorama image.



- This function is available only in the photo record mode.
- When you take a picture of yourself in the Panorama mode, an error can occur.
- If recording a panorama has failed due to improper moving speed or moving in the wrong direction, the recorded image is saved in the aspect ratio as same to a general image.
- For panorama photos, the Photo Resolution is set to 1M regardless of the resolution setting.
- You can take up to 4 continuous panorama images in series.
- Once a panorama image has been taken, the camcorder continues in Panorama mode until you change the setting. To take normal images, turn off the Panorama function.
- The following function is automatically set to Off in the Panorama mode:
 - "Smart filter"

Q Panorama mode example

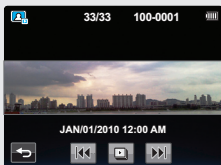

<Panorama mode recording>



<Normal recording>



Quick View

Using the Quick View function, you can view the most recently recorded video and photo images as soon as the recording is finished.

PRECHECK!

Select the Record mode by pressing the **Mode** (▶) button. →page 23

1. Press the **MENU** button.
2. Touch the "Quick View" icon.
 - Touch the desired submenu item.
3. Press the **MENU** button to exit the menu.



Submenu items

- **Off:** Quick View icon does not appear on the screen after you finish the recording. Quick View is off.
- **On:** Quick View icon (▶) appears on the screen as soon as you finish the recording. Touch the Quick View icon to view the most recent video or photo you have recorded. After the Quick View is completed, your camcorder switches back to the STBY mode.



Deleting a file after the Quick View

If you touch the delete (🗑️) tab during Quick View, the file is deleted.



The Quick View function is not available under the following conditions:

- If the mode has been changed after the recording.
- If you have connected the built-in USB plug of the camcorder to a PC.
- If the camcorder has been restarted after the recording.
- After playing Quick View
- After recording Panorama

advanced playback

USING THE MENU TAB IN THE PLAY MODE

- You can change the menu settings to customize your camcorder.
- Access the desired menu screen by following the steps below, and then change the various settings.

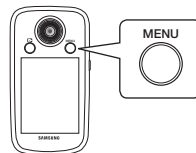

PRECHECK!

- Press the **Power** (⏻) button to turn on the camcorder. ↪page 22
- Select the Play mode by pressing the **Mode** (▶) button. ↪page 23

Using the Menu Tab: An Example

1. Touch the Video (📹) or Photo (📷) tab.
 - Touch the desired image.
2. Press the **MENU** button.
 - The menu screen appears.
3. Touch the “Delete .”
(The Delete function is used here as an example.)
4. Touch the desired option.
5. Press the **MENU** button to exit the menu.



- The camcorder applies the menu item you selected and displays the appropriate indicator.
- There are some functions you cannot activate simultaneously in the menu. Also, you cannot select grayed-out menu items. Refer to Troubleshooting for examples of unworkable combinations of functions and menu items. ↪page 83

PLAYBACK MENU ITEMS

- The menu items you can access depend on the operation mode.
- For operation details, see the page listed under Page in the table below.

● : available, X : not available

Items	Operation mode	Video		Photo		Default value	Page
		Thumbnail	Single	Thumbnail	Single		
Delete		●	●	●	●	-	51
Protect		●	●	●	●	-	52
Share Mark		●	●	X	X	-	53
Settings		●	●	●	●	-	54

- These items and default values may be changed without prior notice.
- You can not select and adjust all menu items in all modes.
Before selecting a menu item, set the appropriate operation mode first. ↪page 23

DELETING FILES

You can erase your recordings one by one, or all at once.

PRECHECK!

- Insert a memory card. ↪page 27
- Select the Play mode by pressing the **Mode** (▶) button, and then touch the Video (📹) or Photo (📷) tab. ↪page 23

1. Press the **MENU** button.

2. Touch the “**Delete**” and then the desired submenu item.

- If you touch “**Select Files**”, you will see image thumbnails. Go to Step 3.
- If you touch “**All Files**”, you will see the message that corresponds to that option. Go to Step 4.

3. Touch the thumbnails of the files you want to delete. After you have selected all the files you want to delete, touch the (OK) tab.

- See Submenu items below for additional details.

4. Touch “**Yes**.”

- If you selected “**All Files**”, the camcorder deletes all the files in the storage media, except for those that are protected.
- If you selected “**Select Files**”, the camcorder deletes the files you selected.

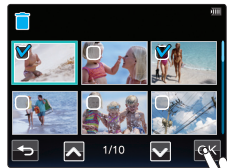
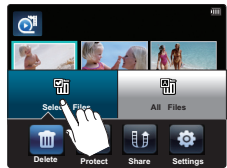

Submenu items

- **Select Files:** Deletes individual images. Touch the images you want to delete. The (✓) indicator is displayed on the selected images. Touching the thumbnail image toggles the image between being selected (✓) or not selected. Touch the (OK) tab after you have selected all the files you want to delete.
- **All Files:** Deletes all images.

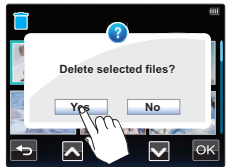

- You can not recover deleted images.
- Do not eject a memory card or power off while deleting videos or photos recorded on the storage media. Doing so may damage the storage media or data.



- You can also operate this function in the full and single image display mode. ↪page 50
- To protect important images from accidental erasure, activate the image protection function in advance. ↪page 52
- You can not delete protected files. Cancel the protect (🔒) function first. ↪page 52
- The delete function does not work if the battery charge is insufficient. Make sure the battery is charged enough so it does not become exhausted during the delete operation.
- You can also format the storage media to delete all the images at once. Be aware that all files and data including protected files will be erased. ↪page 62

advanced playback

PROTECTION FROM ACCIDENTAL ERASURE

You can protect important recordings from accidental erasure. You can not delete the protected videos and photos unless you cancel the protection or format the storage medium.

PRECHECK!

- Insert a memory card. ↪page 27
- Select the Play mode by pressing the **Mode** (▶) button, and then touch the Video (📹) or Photo (📷) tab. ↪page 23

1. Press the **MENU** button.
2. Touch the **Protect** (🔒) and then the desired submenu item.
 - If you touch **"Select Files"**, you will see image thumbnails. Go to Step 3.
 - If you touch **"All On"** or **"All Off"**, you will see the message that corresponds to that option. Go to Step 4.
3. Touch the thumbnails of the files you want to protect. After you have selected all the files you want to protect, touch the (OK) tab.
 - See Submenu items below for additional details.
4. Touch **"Yes."**
 - If you selected **"All On"**, the (🔒) indicator appears on all files. If you selected **"All Off"**, the (🔒) indicator disappears from all protected files.
 - If you selected **"Select Files"**, the (✔) indicator appears on the files you selected for protection and disappears from the files you removed protection from.
 - The protection indicator (🔒) is displayed on the selected files.

Submenu items

- **Select Files:** Protects individual images. Touch the images you want to protect from erasure. The (✔) indicator appears on the selected images. Touching the thumbnail image toggles the image between being selected (✔) or not selected. Touch the (OK) tab after you have selected all the files you want to protect.
- **All On:** Protects all images.
- **All Off:** Releases the protected images all at once.

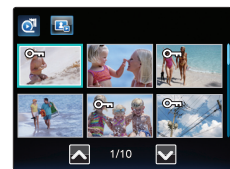
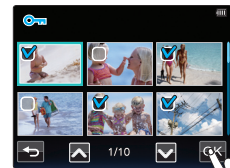

You can also operate this function in the full and single image display mode.

Share Mark

You can set the share mark on a video and directly upload the marked file to the YouTube site.

PRECHECK!

- Insert a memory card. ↪ page 27
- Select the Play mode by pressing the **Mode** (▶) button, and then touch the Video (📹) tab. ↪ page 23

1. Press the **MENU** button.
2. Touch the “**Share Mark** (📺)” and then the desired submenu item.
 - If you touch “**Select Files**”, you will see image thumbnails. Go to Step 3.
 - If you touch “**All On**” or “**All Off**”, you will see the message that corresponds to that option. Go to Step 4.
3. Touch the thumbnails of the files you want to share mark. After you have selected all the files you want to share mark, touch the (OK) tab.
 - See Submenu items below for additional details.
4. Touch “**Yes.**”
 - If you selected “**All On**”, the (📺) indicator appears on all files. If you selected “**All Off**”, the (📺) indicator disappears from all share marked files.
 - If you selected “**Select Files**”, the (✔) indicator appears on the files you selected for share marking and disappears from the files you removed the share mark from.
 - The share mark indicator (📺) is displayed on the videos you selected.

Submenu items

- **Select Files:** Share marked individual images.
Touch the images you want to Share mark.
The (✔) indicator appears on the selected images.
Touching the thumbnail image toggles the image between being selected (✔) or not selected.
Touch the (OK) tab after you have selected all the files you want to share mark.
- **All On:** Share marked all images.
- **All Off:** Releases the Share marked images all at once.



- You can also operate this function in the full and single image display mode.
- By using the Intelli-studio software embedded in the camcorder, you can easily upload videos marked with share marks. ↪ page 70
- This function is available only in the video play mode.
- If the total video recording time is more than 10 minutes, you can not set the share mark on the video.

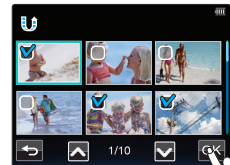

system setting

USING THE SETTING MENU TAB



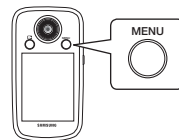

- You can change the menu settings to customize your camcorder.
- Access the desired menu screen by following the steps below, and then change the various settings.



PRECHECK!

Insert a memory card. → page 27

Using the Menu Tab: An Example

1. Press the **MENU** button in the record or the play mode.
 - The menu screen appears.
2. Touch the "**Settings**  ."
3. Drag up/down or touch the Previous () or Next () tab until the desired option is displayed and then touch the desired option.
 - The submenu items for the option you selected appear.
 - Touch the desired submenu item.
4. To exit the menu, touch the Return () tab.



SETTING MENU ITEMS

- You can setup the date/time, OSD language, and display settings of the camcorder.
- For operation details, see the page under Page in the table below.

Items	Default value	Page
Storage Info	-	55
File No.	Series	56
Date/Time Set	JAN/01/2010 12:00 AM	56
Date/Time Display	Off	57
LCD Brightness	Normal	57
Auto LCD Off	On	58
Beep Sound	On	59
Shutter Sound	On	59
Auto Power Off	5 Min	60
PC Software	On	61
Format	-	62
Default Set	-	63
Language	English	63
Demo	On	64



- These items and default values may be changed without notice.
- There are some functions you cannot activate simultaneously in the menu. Also, you cannot select grayed-out menu items. Refer to Troubleshooting for examples of unworkable combinations of functions and menu items. ↪page 83

Storage Info

This function displays the storage information for the memory card in your camcorder, such as the used or the available memory space, etc.

PRECHECK!

Insert a memory card. ↪page 27

1. Press the **MENU** button.
2. Touch the "Settings"  → "Storage Info."
 - Used memory space, memory space available for use, and the recordable time depend on the video resolution you have selected.
3. To exit the menu, touch the Return  tab.

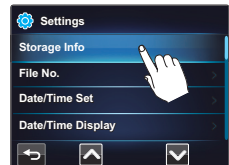



- The actual capacity may be less than the capacity displayed on the LCD screen because the camcorder's system files occupy a part of the capacity.
- If there is no memory card in your camcorder, you can not select Storage Info. It will be dimmed in the menu.

system setting

File No.

The camcorder assigns file names (numbers) are assigned to recorded images according to the option you select.

1. Press the **MENU** button.
2. Touch the "Settings"  → "File No."
 - Touch the desired submenu item.
3. To exit the menu, touch the Return  tab.



Submenu items

- **Series** : Assigns file numbers in sequence even if you replace the memory card with another one, format the card, or delete all files. The file number is reset only when a new folder is created.
- **Reset** : Resets the file number to 0001 after you format the memory card, delete all files, or insert a new memory card.



When you set "File No." to "Series," each file is assigned a different number to avoid duplicating file names. This numbering scheme is very useful when you want to manage your files on a computer.

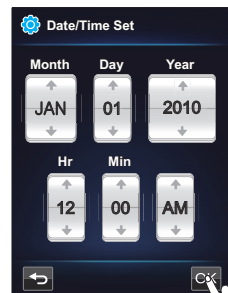

Date/Time Set

By setting the date and time, you can display the date and time of the recording during playback.  page 25



Date/Time Display

You can set the Date/Time Display function so that the date and time appear on the LCD screen. Before you use the "Date/Time Display" function, you must set the date and time. ➔ page 25

1. Press the **MENU** button.
2. Touch the "Settings"  → "Date/Time Display."
 - Touch the desired submenu item.
3. To exit the menu, touch the Return  tab.
 - The date/time is displayed on the LCD screen according to the selected option.

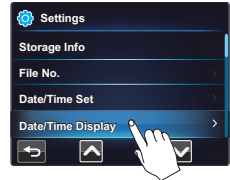

Submenu items



- **Off** : Current date/time information is not displayed.
- **Date** : Displays the current date.
- **Time** : Displays the current time.
- **Date & Time** : Displays the current date and time.



The date/time will appear as "JAN/01/2010 12:00 AM" in the following case:
- When the built-in rechargeable battery is depleted.

LCD Brightness

You can adjust the brightness of the LCD screen to compensate for ambient lighting conditions.

1. Press the **MENU** button.
2. Touch the "Settings"  → "LCD Brightness."
 - Touch the desired submenu item.
3. To exit the menu, touch the Return  tab.





Submenu items

- **Normal**: Standard brightness.
- **Bright**: Brightens the LCD screen.

system setting

Auto LCD Off

To reduce power consumption, the camcorder automatically dims the brightness of the LCD screen if the camcorder is idle for a period of time.

1. Press the **MENU** button.
2. Touch the "Settings"  → "Auto LCD Off."
 - Touch the desired submenu item.
3. To exit the menu, touch the Return () tab.



Submenu items

- **Off** : Disables the function.
- **On** : When the camcorder is idle for more than 2 minutes in the STBY mode, or for more than 5 minutes when recording a video, the power saving mode starts by dimming the LCD screen.

For example, LCD screen is automatically darkened.



< In the STBY mode >

After 2 minutes



<LCD screen is darkened>



<During recording>

After 5 minutes





<LCD screen is darkened>



- If the "Auto LCD Off" function is enabled and the LCD screen dims, you can press any button or touch the LCD screen on the camcorder to return the LCD screen's brightness to normal.
- **Auto LCD Off is temporarily disabled in the following cases:**
 - If you have connected the built-in USB plug of the camcorder to a PC.
 - While the Demo function is in operation.

Beep Sound

You can set the beep sound on or off. If you hear a beep sound when operating the menu settings, Beep Sound is turned on.

1. Press the **MENU** button.
2. Touch the "Settings"  → "Beep Sound."
 - Touch the desired submenu item.
3. To exit the menu, touch the Return () tab.

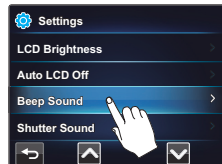

Submenu items

- **Off:** The beep sound is off.
- **On:** You will hear a beep sound when operating buttons or tabs on the LCD screen.





The Beep Sound function is temporarily disabled in the following cases:

- During recording and playing.
- When the camcorder has a cable connection. (Mini HDMI cable)

Shutter Sound

You can turn the shutter sound that plays when you touch the **Photo** () tab on or off.

1. Press the **MENU** button.
2. Touch the "Settings"  → "Shutter Sound."
 - Touch the desired submenu item.
3. To exit the menu, touch the Return () tab.

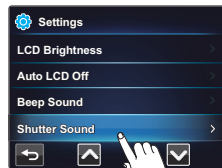

Submenu items

- **Off:** The shutter sound is off.
- **On:** The shutter sounds each time you touch the **Photo** () tab.





The Shutter Sound is temporarily disabled under the following conditions:

- When you touch the **Photo** () tab while recording a video.

system setting

Auto Power Off

To save battery power, you can set the "Auto Power Off" function to 5 Min. This setting turns off the camcorder if there is no operation for five minutes.

1. Press the **MENU** button.
2. Touch the "Settings"  → "Auto Power Off."
 - Touch the desired submenu item.
3. To exit the menu, touch the Return () tab.



Submenu items



- **Off:** The camcorder does not turn off automatically.
- **5 Min:** The camcorder automatically turns off if there is no operation for 5 minutes in STBY mode or in thumbnail index view.



- **Auto Power Off is temporarily disabled in the following cases:**
 - When the camcorder is connected using its built-in USB plug.
 - While the Demo function is in operation.
 - While the camcorder is recording, playing (except when in pause), or running a photo slide show.
- To operate the camcorder again, press the **Power** () button.

PC Software

If you set PC Software to On, you can use the built-in video and photo management software (Intelli-studio) by connecting the built-in USB plug on the camcorder to your PC. With this software, you can download stored video and photo images from the camcorder to your PC's hard disk and edit the video and photo files on your PC's screen.

1. Press the **MENU** button.
2. Touch the "**Settings**  " → "**PC Software.**"
 - Touch the desired submenu item.
3. To exit the menu, touch the Return () tab.



Submenu items

- **Off:** Disables the function.
- **On:** You can use the PC software by connecting the built-in USB plug of the camcorder to your PC.



The PC software is compatible with Windows operating systems only.

system setting

Format

The format function deletes all files (including protected files) and options on the storage media. You can also use this function if you want to correct problems with the storage media.

PRECHECK!

Insert a memory card. ↪ page 27

1. Press the **MENU** button.
2. Touch the "Settings"  → "Format."
 - A message appears asking for your confirmation.
3. Touch the "Yes" → "Yes."
 - The camcorder formats the storage media and displays a formatting message.

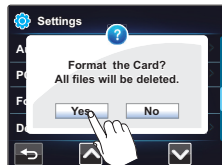

- Do not remove the storage media or perform any other operation (such as turning off the power) during formatting. Also, be sure the battery is sufficiently charged. The storage media can be corrupted if the battery becomes exhausted during formatting.
- If the storage media becomes corrupted, format it again.



- **Do not format the storage media on a PC or other device.** Make sure to format the storage media on this camcorder.
- If there is no memory card in your camcorder, you can not select Format. It will be dimmed in the menu.
- You must format storage media you used in other devices or newly purchased memory cards with this camcorder before using them. This enables stable speeds and operation when the camcorder accesses the storage media.
- Be aware that formatting erases all files and data including protected files.

Default Set

You can re-set your camcorder's settings to the factory defaults (initial settings at the factory).

1. Press the **MENU** button.
2. Touch the "Settings"  → "Default Set."
 - A message appears asking for your confirmation.
3. Touch "Yes" if you want all the settings returned to the default.
4. Set the date and time again. ↪page 25

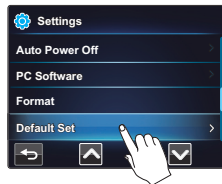

- Do not turn off the power while initializing the settings.
 - The "Default Set" function does not affect the files recorded on the storage media.
-

Language

You can select a language in which to display the menu and messages. ↪page 26

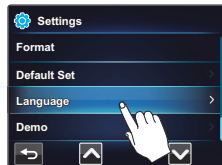



- "Language" options may be changed without a prior notice.
 - The camcorder retains the language you select even when turn off the power.
 - The date and time format may change depending on the language you selected.
-

system setting

Demo

Demo mode automatically shows you the major functions that are included in your camcorder so that you can use them more easily.

1. Press the **MENU** button.
2. Touch the "Settings"  → "Demo."
 - Touch the desired submenu item.
3. To exit the menu, touch the Return () tab.

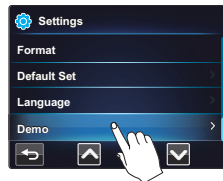

Submenu items

- **Off:** Disables the function.
- **On:** Enables the Demo function.

Using the Demo function

The Demo mode is canceled in the following cases:

- If you touch the LCD screen.
 - If you press any button. (**MENU** button, **Mode** () button, etc.)
- However, the camcorder enters the Demo mode automatically after 5 minutes in STBY mode if it is idle for 5 minutes without an operation. If you don't want the Demo function to start, set "**Demo**" to "Off".

Using the SHOP mode

In STBY mode, holding the **MENU** button for 5 seconds activates Demonstration mode which starts a demo immediately without your setting "**Demo: on.**"



The Demo function does not operate in the following case:

- If "**Auto Power Off**" is set to "**5 Min**", the Auto Power Off function turns the camcorder off before Demo can run. ↪ page 60

using with a Windows computer

WHAT YOU CAN DO WITH A WINDOWS COMPUTER

You can perform the following functions by connecting your camcorder to your Windows computer with the built-in USB plug and using the Intelli-studio software built into your camcorder.

Main functions

- Intelli-studio editing software main functions:
 - Playing back recorded videos or photos. ➔page 68
 - Editing recorded videos or photos. ➔page 68
 - Uploading the recorded videos and photos to Youtube, Flickr, FaceBook, etc. ➔page 69
- You can also transfer or copy the files (videos and photos) saved on your storage media into your computer. (the mass storage function) ➔page 72

System requirements

The following requirements must be satisfied to use the built-in editing software (Intelli-studio):

Items	Requirement
OS	Microsoft Windows XP SP2, Vista, or Windows 7
CPU	Intel® Core 2 Duo® 1.66 GHz or higher is recommended AMD Athlon™ X2 Dual-Core 2.2 GHz or higher is recommended (Notebook: Intel Core2 Duo 2.2GHz or AMD Athlon X2 Dual-Core 2.6GHz or higher is recommended)
RAM	1GB or higher is recommended
Video Card	NVIDIA GeForce 8500 or higher, ATI Radeon HD 2600 series or higher
Display	1024 x 768, 16-bit color or higher (1280 x 1024, 32-bit color recommended)
USB	USB 2.0
Direct X	DirectX 9.0c or higher
Memory Card	A micro SDHC card of Class 6 or above



- System requirements listed above are minimum requirements. Even on a system that satisfies the requirements, Intelli-studio may not operate optimally.
- On a slower than recommended computer, video playback may skip frames or operate erratically.
- If the version of DirectX on your computer is lower than 9.0c, install DirectX 9.0c or higher.
- We recommend transferring recorded videos to a PC before playing back or editing them.
- To run Intelli-studio, a laptop computer requires faster and better components than a desktop PC.
- The built-in software on your camcorder, 'Intelli-studio', is not Macintosh compliant.

using with a Windows computer

USING THE Intelli-studio PROGRAM

Using the Intelli-studio program built into your camcorder, you can transfer video and photo files to your PC and edit them on your PC screen. Intelli-studio offers the most convenient way for you to manage your video and photo files.

Step 1. Connecting the USB plug

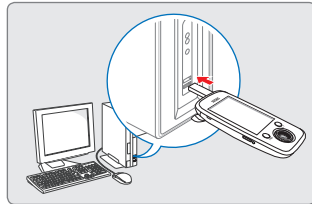

1. Set **"PC Software: On."** → page 61
 - This is the default setting.
2. Connect the built-in USB plug of the camcorder to the USB port of the PC.
 - A new file saving window appears along with the Intelli-studio main window.
 - Depending on your version of Windows, the removable disk window also appears.
3. Click **"Yes"** in the file saving window. The uploading procedure starts. Click **"Yes"** to confirm.
 - If you do not want to save new files, select **"No."**

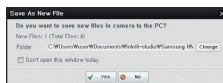

To disconnect the USB plug

To disconnect the USB plug after completing the file transfer, you must follow these steps:

1. Click the **"Safely Remove Hardware icon"** on the taskbar.
2. Select **"USB Mass Storage Device,"** and then click **"Stop."**
3. If the **"Stop a Hardware device"** window appears, click **"OK."**
4. Disconnect the camcorder's built-in USB plug from the PC.



- Make sure you insert the USB plug into the USB port with the plug facing in the correct direction.
- When the built-in USB plug is connected, turning the camcorder on or off may cause the PC to malfunction.
- If you disconnect the camcorder's built-in USB plug from the PC while transferring files, the data transmission will stop and the data may be damaged.
- If you connect the built-in USB plug to a PC via a USB HUB or simultaneously connect the built-in USB plug along with other USB devices, the camcorder may not work properly. If this occurs, remove all USB devices from the PC, and then reconnect the camcorder.
- Intelli-studio may not automatically run. If this occurs, access My Computer or Windows Explorer, open the drive that corresponds to your camcorder, find Intelli-studio, and then run IStudio.exe.
- The camcorder is turned off when its USB plug is departed from the USB port of the computer.

Step 2. About the Intelli-studio main window

When Intelli-studio starts up, thumbnails of videos and photos are displayed in the main window.

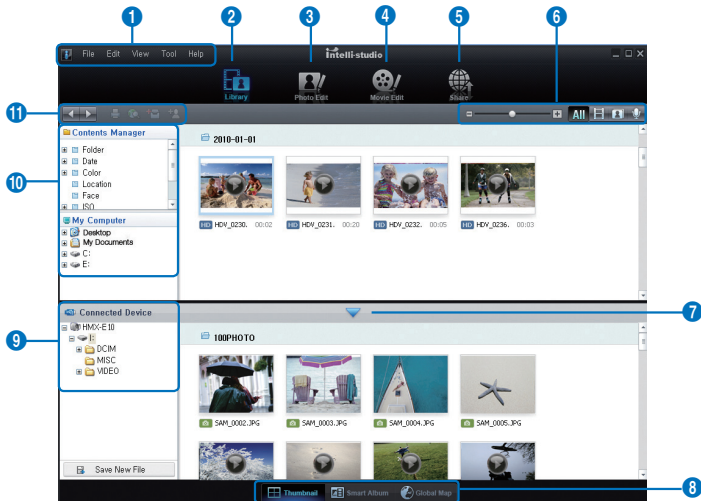

1. Menu items
2. Switches to Library of the computer and connected camcorder.
3. Switches to Photo Edit mode.
4. Switches to Movie Edit mode.
5. Switches to Share mode.
6. Changes the size of thumbnails.
 - Displays all files (videos and photos).
 - Displays video files only.
 - Displays photo files only.
 - Displays voice files only.
7. Minimizes the Connected Device screen.
8. Displays videos and photos in various ways.
 - Thumbnails: Displays video and photo thumbnails.
 - Smart Album: Arranges multiple videos and photos by various classifications.
 - Global Map: Displays locations where you shot photos on a map.
9. Selects the connected device.
10. Shows Contents Manager and My Computer directories.
 - Contents Manager: You can classify and manage videos and photos on your computer.
 - My Computer: You can view videos and photos saved in selected directories of your computer.
11. Shortcut icons
 - Navigates files (previous and next).
 - Prints selected photo(s).
 - Using GPS information, displays location where selected photo(s) were taken.
 - Registers to Contents Manager.
 - Manages the registry of faces in the selected photo.



- Intelli-studio is a program commonly used in Samsung camcorders or digital cameras. Some functions listed above may not work, depending on the product you purchased.
- This product is designed for home use. It is not designed for precision production or industrial purposes. The Intelli-studio built in the camcorder is for home use. For accurate and professional editing, it is recommended to use a professional editing software.

using with a Windows computer

Step 3. Playing back videos or photos

You can play back recordings conveniently using the Intelli-studio application.

1. Run the Intelli-studio program. ↪ page 66
2. Click the desired folder to display your recordings.
 - Video or photo thumbnails appear on the screen, depending on the folder you selected.
3. Choose the video or photo that you want to play.
 - You can view the file information by moving the mouse over the thumbnail.
 - If you click a video thumbnail once, the video plays back inside the thumbnail frame, allowing you to search for a desired scene with ease.
4. Once you select the desired video or photo, double-click to play back.
 - Playback starts and playback controls appear.





Intelli-studio supports the following file formats:

- Video formats: MP4 (Video: H.264, Audio: AAC), WMV (WMV 7/8/9)
- Photo formats: JPG, GIF, BMP, PNG, TIFF

Step 4. Editing videos or photos

With Intelli-studio, you can edit videos or photos in various ways.

(For example, Change Size, Fine-Tune, apply Image Effect, Insert Frame, etc.)

- Before editing a video or photo in Intelli-studio, make a backup copy of the file by copying the video or photo file to your computer using My Computer or Windows Explorer.
- To begin editing a file, select the file, and then click the “Edit ( / )” icon.
- You can not copy edited files (videos and photos) on a PC to the camcorder in any way.

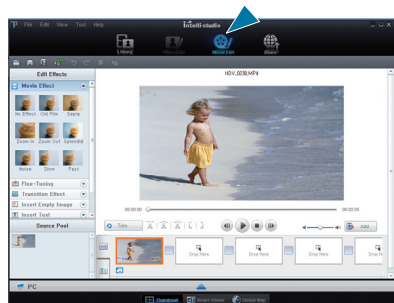

Step 5. Sharing the videos/photos online

Share your contents with the world by uploading photos and videos directly to a web site with one click.

1. Select the videos or photos you want to share.
2. Click **“Share”** on the Intelli-studio browser.
 - The selected file appears on the sharing window.
3. Click the web site you would like to upload files to.
 - You can choose **“YouTube,” “Flickr,”** **“Facebook,”** or another web site you want to use for your uploading management.
4. Click **“Upload”** to start uploading.
 - A pop-up window appears asking for your ID and password.
5. Enter your ID and password to access.
 - Access to the web site contents can be limited depending on your web access environment.

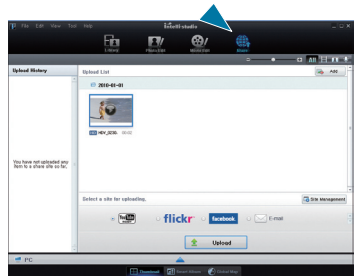

For more information about using Intelli-studio, open the Help Guide by clicking **“Help.”**

flickr

- Flickr is an image hosting website, web services suite, and online community platform. In addition to being a popular website for users to share personal photographs, the service is widely used by bloggers as a photo repository.
- <http://www.flickr.com/>

facebook

- Facebook is a global social networking website that is operated and privately owned by Facebook, Inc. Users can add friends and send them messages, and update their personal profiles to notify friends about themselves. Additionally, users can join networks organized by city, workplace, school, and region.
- <http://www.facebook.com/>

YouTube
READY

- YouTube is a video sharing website. Users can upload, view, and share personalized video clips. The San Bruno-based service uses Adobe Flash technology to display a wide variety of users-generated contents including video clips, TV clips and music videos, as well as amateur contents such as video blogging and short original videos.
- <http://www.youtube.com/>

using with a Windows computer

Upload your videos directly to YouTube !

The One-Touch Share tab lets you directly upload and share your videos on YouTube. Just touch the Share tab while your camcorder is connected to a Windows computer using the built-in USB plug.

Step 1

On the camcorder, select a video you want to upload in the video thumbnail index view using the Share () tab in the menu. ↪ page 53 Repeat for each video you want to upload.

- The Share mark () appears on each video.
- You can also operate this function in the full and single image display mode.

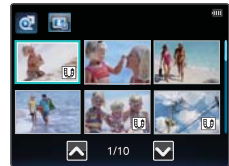

Step 2

Connect the built-in USB plug of the camcorder to the USB port of the PC.

- If you have set "PC Software: On", Intelli-studio runs automatically on a Windows computer after you've connected the camcorder.

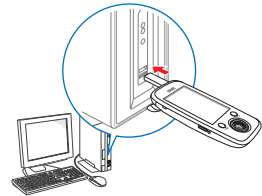

Step 3

Touch the Share () tab on the LCD screen while your camcorder is connected to a Windows computer.

- A pop-up sharing window displaying the videos with Share marks appears on the screen.
- Click "Yes" on the PC screen to begin uploading your videos to YouTube.
- If you want to upload directly without showing a pop-up sharing window, check "Intelli-studio does not show a list of share marked files from the connected device."

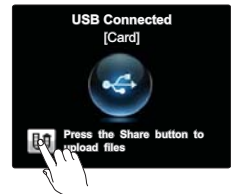

- As part of the uploading process, the videos you marked are converted into a format playable by YouTube before actually uploading. Time spent uploading may vary depending on such conditions as file size, computer performance, and network speed.
- There is no guarantee the uploading operation will work in all environments. YouTube server-side changes in the future may disable this function.
- For more information on YouTube, visit the YouTube website: <http://www.youtube.com/>
- This product's YouTube uploading functionality is provided under the license from YouTube LLC. The presence of the YouTube uploading functionality in this product is not an endorsement of or recommendation for the product by YouTube LLC.
- If you do not have an account on a specified website, you must register first before you can upload.
- According to YouTube's policy, direct video uploading may not be available in your nation / region.

Installing Intelli-studio on a Windows computer

- The Intelli-studio application will run faster if you install it on your Windows computer. Also, if you install it on your computer, it can be updated automatically.
- Follow these directions to install Intelli-studio onto your Windows computer: Click **"Tool"** → **"Install Intelli-studio on PC"** on the Intelli-studio screen, and then follow the steps below.

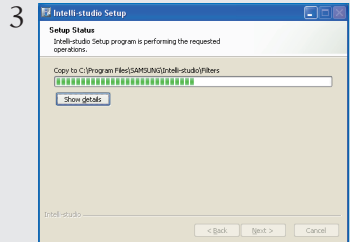
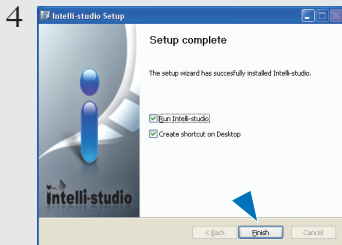
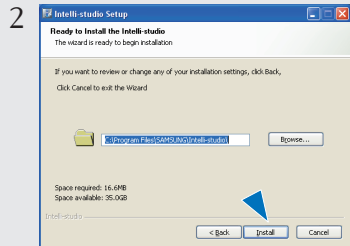
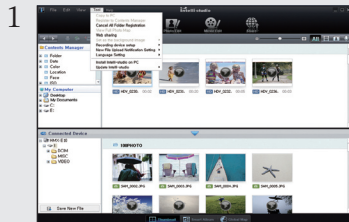

using with a Windows computer

USING AS A REMOVABLE STORAGE DEVICE

You can transfer or copy recorded data from the camcorder to a Windows computer by connecting the camcorder's built-in USB plug to the computer's USB port.

Viewing the contents of the storage media

1. Set **"PC Software: Off."** ↪ page 61
2. Insert a memory card.
3. Connect the built-in USB plug of the camcorder to the USB port of the PC. ↪ page 66
 - The "Removable Disk" or "Samsung" window appears on the PC's screen after a moment.
 - Select "Open folder to view files using Windows Explorer", and then click "OK."
4. The folders in the storage media appear.
 - Different file types are stored in different folders.
5. Select the desired folder or files to copy, then drag and drop them into the destination folder.
 - The folder or files are copied from the storage media to the PC.

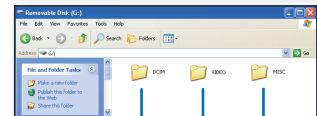

Photos Videos
Setting data



- If the "Removable Disk" window does not appear, confirm the connection (↪ page 66) or perform Steps 1 through 4 again.
- If the removable disk does not appear automatically, open the removable disk folder in My Computer.
- If the connected camcorder's disk drive does not open or the context menu that appears when you right click your mouse (open or browse) appears broken, your computer may be infected by an Autorun virus. Please update your anti-virus software to its latest version, and then scan your disk drives.
- The camcorder is turned off when its USB plug is departed from the USB port of the computer.

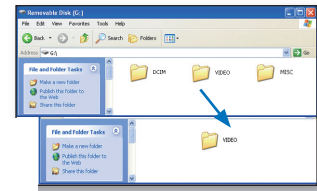

Structure of folders and files on the storage media

- The folder and file structure for storage media is below.
- File naming follows DCF (Design rule for Camera File System) rules.

Video file (H.264) ①

- The HD-quality (1920x1080 30p or 1280x720 30p) videos have an HDV_####.MP4 format.
- The file number automatically increases when a new video file is created.
- Up to 9,999 files can be stored in one folder. The camcorder creates a new folder when the number of files in a folder exceeds 9,999.

Photo file ②

- As with video files, the file number automatically increases when a new photo file is created.
- The maximum number of files per folder is the same as with video files. The photos have an SAM_####.JPG format.
- The folder names increase in this order: 100PHOTO → 101PHOTO etc.
- Up to 9,999 files can be stored in one folder. The camcorder creates a new folder when the number of files in a folder exceeds 9,999.

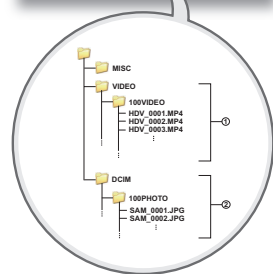
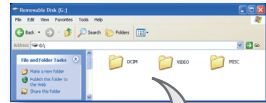

Image format

Video files

- Videos are compressed in H.264 format. The file extension is ".MP4."
- Refer to page 44 for video resolution.

Photo files

- Photos are compressed in JPEG (Joint Photographic Experts Group) format. The file extension is ".JPG."
- Refer to page 45 for photo resolution.



- When the 9,999th file (i.e. HDV_9999.MP4) is created in the 999th VIDEO folder on a memory card, no more folders can be created on that memory card. Backup your files to a PC and format the storage media, then reset the file numbering from the menu.
- Do not modify the name of a video file recorded by the camcorder. Proper playback by the camcorder requires the original folder and file name.

connecting to other devices

CONNECTING TO A TV

You can view videos and photos you recorded on a large screen by connecting the camcorder to an HDTV or Standard TV that supports HDMI.

PRECHECK!

Insert a memory card. ↪page 27

Using a mini HDMI cable (not supplied)

To play back the HD-quality (1080/30p or 720/30p) videos, you need an HDTV (high definition TV).

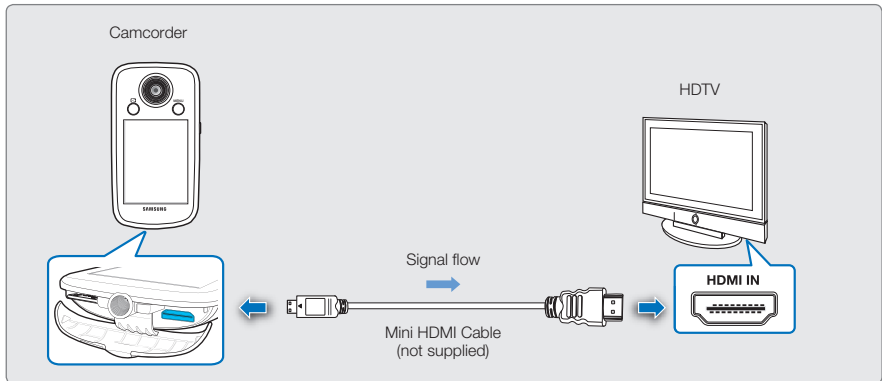

1. Turn on the camcorder, and then connect a mini HDMI cable (not supplied) from the camcorder to the HDMI In jack on your TV.
2. Turn on your TV and set the TV's input selector to the Input your camcorder is connected to.
 - Refer to the TV's instruction manual to see how to select the TV input.
3. Select the playback mode on your camcorder, and then start to play back videos.
↪page 38

Understanding the HDMI cable





HDMI (High Definition Multimedia Interface) is a compact audio/video interface for transmitting uncompressed digital data.



- You can use only a C to A type mini HDMI cable with this camcorder.
- The HDMI jack on the camcorder provides output only.
- Use only HDMI 1.3 cable when connecting to the HDMI jack of this camcorder. If you connect using HDMI cable that is not version 1.3 compatible, the screen display may not work.
- Do not use excessive force when connecting the cables.
- When the camcorder is connected to a TV, you cannot control the volume of the TV from the camcorder.

TV IMAGE DISPLAYS

Image appearance depends on the TV screen aspect ratio (16:9 or 4:3)

Recording ratio	Wide (16:9) TV	4:3 TV
Images recorded in a 16:9 ratio		
Images recorded in a 4:3 ratio		

troubleshooting







Before contacting a Samsung authorized service center, perform the following simple checks. They may save you the time and expense of an unnecessary call.

WARNING INDICATORS AND MESSAGES

Power source

Message	Icon	Informs that ...	Action
Low Battery	-	The battery is almost discharged.	<ul style="list-style-type: none">• Charge the battery by attaching the camcorder to a PC using the built-in USB plug.
Check the authenticity of this battery	-	The battery can not pass authenticity check.	<ul style="list-style-type: none">• Check whether the battery is authentic. Change to an authentic Samsung battery.• We recommended you use only genuine Samsung batteries in this camcorder.

Storage media

Message	Icon	Informs that ...	Action
Insert Card		There is no memory card inserted in the card slot.	<ul style="list-style-type: none">• Insert a memory card.
Card Full		There is not enough space to record on the memory card.	<ul style="list-style-type: none">• Delete unnecessary files on the memory card.• Back-up files to your PC or another storage media, and then delete files.• Format the memory card.• Change to another memory card which has enough free space.
Card Error		The memory card has a problem and the camcorder can't recognize it.	<ul style="list-style-type: none">• Eject and re-insert the memory card. If the problem persists, replace the memory card with a new one.
Not Supported Card		The memory card is not supported by this camcorder.	<ul style="list-style-type: none">• Eject and re-insert the memory card. If the problem persists, replace the memory card with a recommended card.
Not Formatted		The memory card is not formatted.	<ul style="list-style-type: none">• Eject and re-insert the memory card. If the problem persists, format the memory card using the camcorder.
Not Supported Format		The memory card was formatted by another device and may still have images on it.	<ul style="list-style-type: none">• The camcorder cannot play the files because it does not support the memory card's file format. Format the card using the camcorder or install and format a new card.
Low speed card. Please record at a lower resolution.	-	The memory card does not have enough speed to record.	<ul style="list-style-type: none">• Change the memory card to a faster one. →page 29• Change to a lower resolution.

Recording

Message	Icon	Informs that ...	Action
Write Error	-	Problems occurred while writing data to the storage media.	<ul style="list-style-type: none"> Back up important files on the storage media to your PC, and then format the storage media using the camcorder.
Cannot record video on panorama mode.	-	This function is not supported by this camcorder.	<ul style="list-style-type: none"> This function is available only in the photo record mode.
Camera moved too quickly, or subject is too close. Move camera more slowly.	-	Cannot trace the subject since the subject is too close or the camcorder is moving too fast.	<ul style="list-style-type: none"> Please move the camcorder slowly to allow perceiving the subject's movement.
Shooting aborted as shot direction changed.	-	You need to move the camcorder in one direction only when taking a panorama.	<ul style="list-style-type: none"> Sweep the camcorder in one direction.
The number of video files is full. Cannot record video.	-	Folder and files have reached their maximum capacity and you can not record.	<ul style="list-style-type: none"> Back up important files on the storage media to your PC, and then format the storage media using the camcorder. Set "File No." to "Reset."
The number of photo files is full. Cannot take a photo.	-	Folder and files have reached their maximum capacity and you cannot take a photo.	<ul style="list-style-type: none"> Back up important files on the storage media to your PC, and then format the storage media using the camcorder. Set "File No." to "Reset."

Playback

Message	Icon	Informs that ...	Action
Read Error	-	Problems occurred during data read from storage media.	<ul style="list-style-type: none"> Back up important files on the storage media to your PC, and then format the storage media using the camcorder.

troubleshooting

SYMPTOMS AND SOLUTIONS

If these instructions do not solve your problem, contact your nearest Samsung authorized service center.

Power

Symptom	Explanation/Solution
The camcorder does not turn on.	<ul style="list-style-type: none">• Charge the battery by attaching the camcorder to a PC using the built-in USB plug.
The power automatically turns off.	<ul style="list-style-type: none">• Is "Auto Power Off" set to "5 Min"? If no button is pressed for about 5 minutes, the camcorder automatically turns off. To disable this option, change "Auto Power Off" to "Off." ↳ page 60• The battery is almost discharged. Charge the battery by attaching the camcorder to a PC using the built-in USB plug.
The battery discharges quickly.	<ul style="list-style-type: none">• The temperature is too low.• The battery is not fully charged. Recharge the battery.• The battery reached the end of its lifespan and cannot be recharged. Contact your nearest Samsung authorized service center to purchase a replacement.

Display

Symptom	Explanation/Solution
The recorded image is wider or narrower than the original image.	<ul style="list-style-type: none">• You should check the resolution before you record. ↳ pages 45
Unknown indicator appears on the screen.	<ul style="list-style-type: none">• A warning indicator or message appears on the screen. ↳ pages 76, 77
The image on the LCD screen looks dark.	<ul style="list-style-type: none">• Ambient light is too bright. Adjust the brightness and angle of the LCD. ↳ pages 57

Storage Media

Symptom	Explanation/Solution
Memory card functions are not operable.	<ul style="list-style-type: none"> • Insert a memory card into your camcorder properly. ↪page 27 • If you are using a memory card formatted on a computer, format it again directly on your camcorder. ↪page 62
Image cannot be deleted.	<ul style="list-style-type: none"> • You cannot delete protected images. Remove protection from the image. ↪page 52
You cannot format the memory card.	<ul style="list-style-type: none"> • Copy all important recorded files to your PC before formatting. Samsung is not responsible for any loss of data. (We recommend that you copy the data to your PC or other storage media.) • The memory card is not supported on your camcorder or card has some problems.
The data file name is not indicated correctly.	<ul style="list-style-type: none"> • The file may be corrupted. • The file format is not supported by your camcorder. • The camcorder does not display the file name correctly if the directory structure does not comply with the international standard.

Recording

Symptom	Explanation/Solution
Touching the Recording start (●) tab does not start recording.	<ul style="list-style-type: none"> • There is not enough free space to record on the storage media. • The internal temperature of your camcorder is unusually high. Turn off your camcorder and leave it for a while in a cool place. • Your camcorder is damp and moist inside (condensation). Turn off your camcorder, remove the battery, and leave both in a dry place for at least 1 hour.
The actual recording time is less than the estimated time.	<ul style="list-style-type: none"> • The estimated recording time may vary depending on the subjects you record and the features you use. • Recording a fast-moving subject increases the bit rate and consequently the amount of storage space required for the recording, which can lead to a shorter available recording time.

troubleshooting

Recording

Symptom	Explanation/Solution
The recording stops automatically.	<ul style="list-style-type: none">• There is no more free space for recording on the storage media. Back up important files on your PC and format the storage media or delete unnecessary files.• If you use a memory card with a low write speed, the camcorder automatically stops recording videos and the corresponding message appears on the LCD screen.
When recording a subject illuminated by bright light, vertical lines appear.	<ul style="list-style-type: none">• The camcorder is unable to record at these levels of brightness. Record in an area that is not as bright.
When the screen is exposed to direct sunlight during recording, the screen turns red or black for an instant.	<ul style="list-style-type: none">• This is not a malfunction. Do not expose the camcorder to direct sunlight.
You don't hear the beep sound.	<ul style="list-style-type: none">• Set the "Beep Sound" to "On." ↪page 59• The beep sound is temporarily off while recording videos.
There is a time difference between the point where you touch Recording start (●) /stop (■) tab and the point where the recorded video starts/stops.	<ul style="list-style-type: none">• On your camcorder, there may be a slight time delay between the time when you touch Recording start (●) /stop (■) tab and the actual time when the recorded video starts/stops. This is not an error.
You cannot record a photo.	<ul style="list-style-type: none">• Set your camcorder to Record mode. ↪page 23• The storage media is full. Use a new memory card or format the storage media. ↪page 56 Or delete unnecessary images. ↪page 51

Adjusting the image during recording

Symptom	Explanation/Solution
It is out of focus.	<ul style="list-style-type: none">• This camcorder has no user-adjustable focus control function.• The minimum focal length between the camcorder and the subject is 20 cm (about 7.87 inches).

Playback on your camcorder

Symptom	Explanation/Solution
Playback (play/pause) function does not work.	<ul style="list-style-type: none">• Press the Mode (▶) button to set the Play mode.• Image files recorded on another camcorder may not play on your camcorder.• Check the memory card compatibility. ↪page 28
The skip or search function does not work properly.	<ul style="list-style-type: none">• If the temperature inside the camcorder is too high, it cannot function properly. Turn the camcorder off, wait for a few minutes, and turn it on again.

Playback on other devices (TV, etc.)

Symptom	Explanation/Solution
You cannot view the image or hear the sound on the connected device.	<ul style="list-style-type: none">• The mini HDMI cable is not connected properly. ↪page 74
The image appears distorted on your TV or PC.	<ul style="list-style-type: none">• The display mode of the recorded video does not match that of playback display device.• A video recorded in 16:9 wide mode should be played back on a TV or PC that supports 16:9 screen mode.

troubleshooting

Connecting to a computer

Symptom	Explanation/Solution
Your computer does not recognize your camcorder.	<ul style="list-style-type: none">• Disconnect the built-in USB plug of the camcorder from the PC, restart the PC, and then reconnect camcorder correctly.
Cannot play a video file properly on a PC.	<ul style="list-style-type: none">• You need a video codec to play the file recorded on your camcorder. Install or run the built-in editing software (Intelli-studio).• Check whether the built-in USB plug of the camcorder is connected in the proper direction.• Disconnect the built-in USB plug of the camcorder from the PC, restart the computer, and then reconnect the camcorder properly.• Your computer may not have the necessary performance specifications to play back a video file. Check the recommended computer specifications.
Intelli-studio does not function properly.	<ul style="list-style-type: none">• Exit the Intelli-studio application, and restart the Windows computer.• Intelli-studio is not Macintosh compliant.• Set "PC Software" to "On" in the Settings menu. ↪ page 61• The Intelli-studio program may not run automatically. If this occurs, access My Computer or Windows Explorer, open the drive that corresponds to your camcorder, find Intelli-studio, and then run IStudio.exe.
The image or sound on your camcorder is not played on your computer properly.	<ul style="list-style-type: none">• Video playback or sound may stop temporarily depending on your computer. The video or sound you have copied to your computer is not affected.• If your camcorder is connected to a computer that does not support Hi-speed USB (USB 2.0), the video or sound may not play back correctly. The video and sound you have copied to your computer are not affected.
The playback screen is paused or distorted.	<ul style="list-style-type: none">• Check the system requirements to play a video. ↪ page 65• Exit all other applications running on the computer.• The transfer speed between the camcorder and PC is too slow, causing the video to pause or distort. Please copy the file to your PC, and then play it back.

General operations

Symptom	Explanation/Solution
The date and time are incorrect.	<ul style="list-style-type: none">• Has the camcorder been left unused for a long period of time? The backup built-in rechargeable battery may be discharged. ↳ page 25

Menu

Symptom	Explanation/Solution
Menu items are grayed out	<ul style="list-style-type: none">• You cannot select grayed items in the current recording/playback mode.• If you have not inserted a memory card into the camcorder, all functions that require a memory card ("Storage Info", "Format", etc.) are dimmed in the menu and you will not be able to select them.

- The following functions cannot be used when the camcorder is in the Smart filter mode:
 - Digital zoom, "**Video Resolution**", "**Photo Resolution**"
- The following function is automatically set to Off in the Panorama mode:
 - "**Smart filter**"

maintenance & additional information

MAINTENANCE

Cautions when storing

- For safekeeping of the camcorder, turn off the camcorder.
 - Remove the battery. ↪page 17
 - Remove the memory card. ↪page 27

LCD screen

- Do not push the LCD screen too hard or strike it with anything.
- When you use the camcorder in cold conditions, an afterimage may appear on the LCD screen. This is not a malfunction.
- If you leave the power on for a long time, the surface around the LCD screen becomes hot.
- An LCD screen is manufactured using advanced technology which creates screens with pixel failure rates of less than 0.01%. However, a black or bright spot (red, blue, white) may appear in the center of the LCD screen and up to two spots may appear outside the center. These spots, which are sometimes incurred during the manufacturing process, do not affect the recorded images.

Lens

- Use an optional air blower to blow out dirt and other small objects. Do not wipe the lens with cloth or your fingers.
- When the lens gets frosty, turn the power off and leave it off for approximately an hour. When the temperature of the lens is similar to the ambient temperature, the frost will disappear.

When there is dew condensation, put the camcorder aside for a while before using

- What is dew condensation?
Dew condensation happens when a camcorder is moved to a location where there is a significant temperature difference from the previous location. The dew condenses on the external or internal parts of the camcorder, and on the reflection lens. If there is dew on or in your camcorder, it may cause the camcorder to malfunction or damage the camcorder when you turn the power on.
- Exactly when does dew condensation occur?
When you move the camera to a location with a higher temperature than the previous location, or when you move it to a hot area suddenly. Examples:
 - You record outside in cold weather during the winter and then move the camera in indoors.
 - You record outside in hot weather after being indoors or inside a car where the A/C was running.
- What can I do?
Turn the power off, detach the battery, and leave the camcorder in a dry area for 1~2 hours before using it.



- Use the camcorder after dew condensation has completely disappeared.
- Be sure to use the recommended accessories supplied with the camcorder. For service, contact your nearest Samsung authorized service center.

USING YOUR CAMCORDER ABROAD

- Each country or region has its own electric and color systems.
- Before using your camcorder abroad, check the following items.

On TV color systems

Your camcorder is an **NTSC** based camcorder.

If you want to view your recordings on a TV it must be an **NTSC** based TV and have an HDMI jack. Otherwise, you may need to use a separate video format transcoder (NTSC-PAL format converter) to convert the video signal.



The format transcoder is not provided by Samsung.

NTSC-compatible countries/regions

Bahamas, Canada, Central America, Japan, Korea, Mexico, Philippines, Taiwan, United States of America, etc.

PAL-compatible countries/regions

Australia, Austria, Belgium, Bulgaria, China, CIS, Czech Republic, Denmark, Egypt, Finland, France, Germany, Greece, Great Britain, Holland, Hong Kong, Hungary, India, Iran, Iraq, Kuwait, Libya, Malaysia, Mauritius, Norway, Romania, Saudi Arabia, Singapore, Slovak Republic, Spain, Sweden, Switzerland, Syria, Thailand, Tunisia, etc.



You can make recordings with your camcorder and view pictures on the LCD screen anywhere in the world.

specifications

Model name	HMX-E10WN/HMX-E10BN/HMX-E100N	
System	Video signal Picture compression format Audio compression format Image device Lens Focal length	NTSC H.264 (MPEG-4.AVC) AAC (Advanced Audio Coding) 1/3.2", 8M Pixel CMOS F2.2, Digital zoom: x2 4.9mm
LCD screen	Size/dot number LCD screen method	2.7 inch / 230k 4:3 TSP LCD
Connectors	HDMI output USB output	C type connector Built-in USB
General	Power source Power source type Power consumption (Recording) Operating temperature Operating humidity Storage temperature Dimensions (WxHxD) Weight Internal MIC Storage media	3.7V (Using Lithium Ion battery) Lithium Ion battery 2.1W (720 30P) 32°F~104°F (0°~40°C) Below 60% -4°F ~ 140°F (-20°C ~ 60°C) 2.26" x 4.27" x 0.66" (57.5 mm x 108.5 mm x 16.8 mm) 0.19 lb (88g, 3.10 oz) (Except for Lithium Ion battery) Omni-directional stereo microphone Memory card (micro SD/micro SDHC)

※ These technical specifications and design may be changed without notice.

SAMSUNG LIMITED WARRANTY

SAMSUNG Electronics America Inc. (SEA), warrants that this product is free from defective material and workmanship.

SEA further warrants that if product fails to operate properly within the specified warranty period and the failure is due to improper workmanship or defective material, SEA will repair or replace the product at it's option.

All warranty repairs must be performed by a SEA authorized service center. The name and address of the location nearest you can be obtained by calling toll free: 1-800 SAMSUNG (1-800-726-7864).

Labor

90 days carry-in

Parts

1 year

On carry-in models, transportation to and from the service center is the customer's responsibility.

The original dated sales receipt must be retained by the customer and is the only acceptable proof of purchase.

It must be presented to the authorized service center.

EXCLUSIONS (WHAT IS NOT COVERED)

This warranty does not cover damage due to accident, fire, flood and/or other acts of God; misuse, incorrect line voltage, improper installation, improper or unauthorized repairs, commercial use, or damage that occurs in shipping.

Exterior and interior finish, lamps, and glass are not covered under this warranty.

Customer adjustments which are explained in the instruction manual are not covered under the terms of this warranty.

This warranty will automatically be voided for any unit found with a missing or altered serial number. This warranty is valid only on products purchased in the United States and Puerto Rico.

Some States do not allow the exclusions or limitations of incidental or consequential damages, or allow limitations on how long an implied warranty lasts, so the above limitations or exclusions may not apply to you.

This warranty gives you specific legal rights, and you may also have other rights which vary from State to State.



QUESTIONS OR COMMENTS?

COUNTRY	CALL	OR VISIT US ONLINE AT	WRITE
IN THE US	1-800-SAMSUNG (726-7864)	www.samsung.com	Samsung Electronics America, inc. 85 Challenger Road Ridgefield Park, NJ 07660-2112



RoHS compliant

Our product complies with "The Restriction Of the use of certain

Hazardous Substances in electrical and electronic equipment", and we do not use the 6 hazardous materials- Cadmium(Cd), Lead (Pb), Mercury (Hg), Hexavalent Chromium (Cr +6), Poly Brominated Biphenyls (PBBs), Poly Brominated Diphenyl Ethers(PBDEs)- in our products.

Free Manuals Download Website

<http://myh66.com>

<http://usermanuals.us>

<http://www.somanuals.com>

<http://www.4manuals.cc>

<http://www.manual-lib.com>

<http://www.404manual.com>

<http://www.luxmanual.com>

<http://aubethermostatmanual.com>

Golf course search by state

<http://golfingnear.com>

Email search by domain

<http://emailbydomain.com>

Auto manuals search

<http://auto.somanuals.com>

TV manuals search

<http://tv.somanuals.com>