

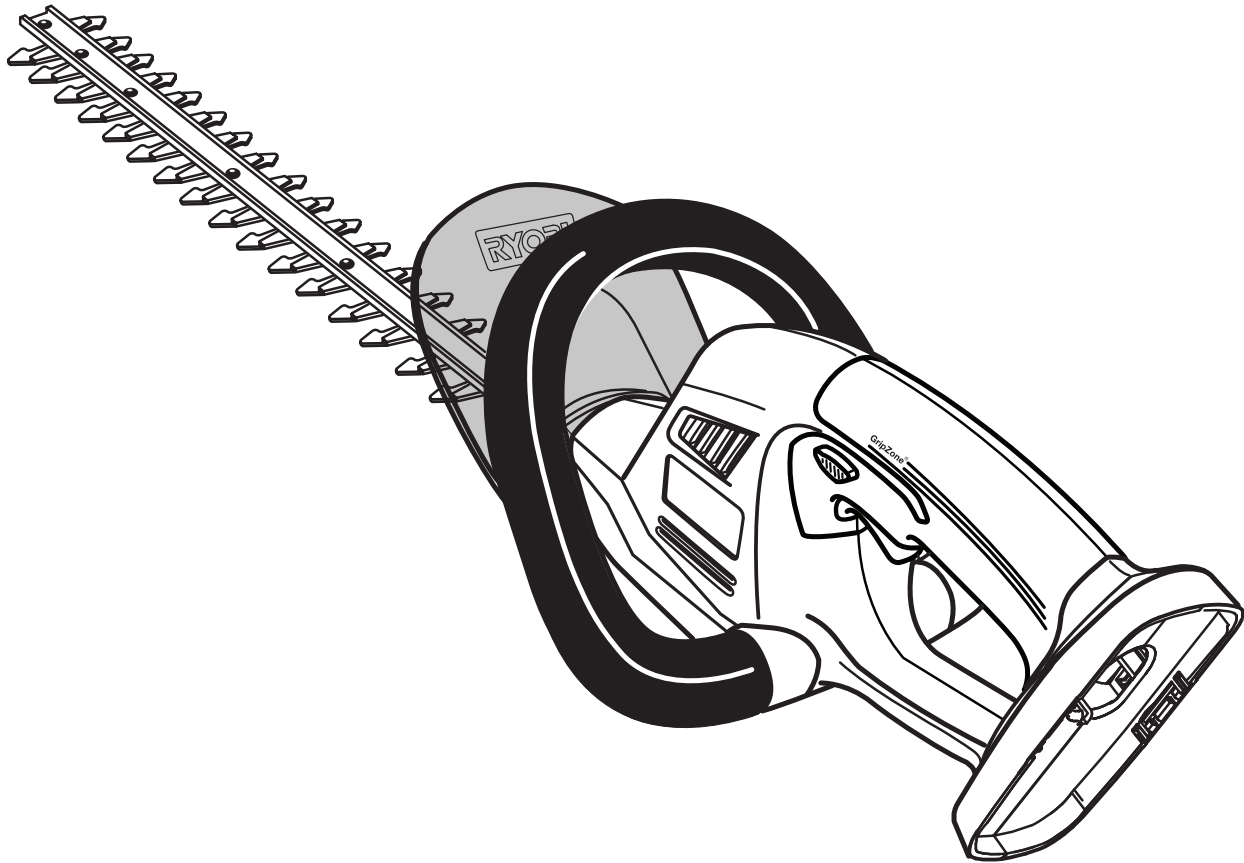

# OPERATOR'S MANUAL

## 18 VOLT HEDGE TRIMMER

### P2601



**ACCEPTS ALL ONE+ BATTERY PACKS**

**BATTERIES AND CHARGERS SOLD  
SEPARATELY**

Your hedge trimmer has been engineered and manufactured to our high standard for dependability, ease of operation, and operator safety. When properly cared for, it will give you years of rugged, trouble-free performance.

**⚠ WARNING:** To reduce the risk of injury, the user must read and understand the operator's manual before using this product.

Thank you for your purchase.

**SAVE THIS MANUAL FOR FUTURE REFERENCE**

# TABLE OF CONTENTS

■ Introduction .....	2
■ General Safety Rules .....	3
■ Specific Safety Rules .....	4
■ Symbols .....	5-6
■ Features .....	7
■ Assembly .....	8
■ Operation .....	8-10
■ Maintenance .....	11-14
■ Warranty .....	15
■ Parts Ordering / Service .....	Back Page

## INTRODUCTION

This product has many features for making its use more pleasant and enjoyable. Safety, performance, and dependability have been given top priority in the design of this product making it easy to maintain and operate.



### CALL US FIRST

For any questions about operating or maintaining your product, call the Ryobi® Help Line!

Your product has been fully tested prior to shipment to ensure your complete satisfaction.

# GENERAL SAFETY RULES

## **WARNING!**

Read and understand all instructions. Failure to follow all instructions listed below may result in electric shock, fire, and/or serious personal injury.

### **READ ALL INSTRUCTIONS**

- Know your tool. Read and understand the operator's manual and observe the warnings and instruction labels affixed to the tool.
- Stay alert, watch what you are doing and use common sense when operating a power tool. Do not use tool while tired or under the influence of drugs, alcohol, or medication. A moment of inattention while operating power tools may result in serious personal injury.
- Do not allow children or untrained individuals to use this unit.
- Wear safety glasses or goggles that are marked to comply with ANSI Z87.1 standards when operating this unit.
- Protect your lungs. Wear a face or dust mask if the operation is dusty. Following this rule will reduce the risk of serious personal injury.
- Dress properly. Do not wear loose clothing or jewelry. Contain long hair. Loose clothes, jewelry, or long hair can be caught in moving parts.
- Wear heavy long pants, boots, and gloves. Do not wear loose fitting clothing, short pants, or jewelry of any kind. Do not go barefoot.
- Secure long hair so it is above shoulder level to prevent entanglement in any moving parts.
- Keep all bystanders, children, and pets at least 50 feet away.
- Do not force tool. Use the correct tool for your application. The correct tool will do the job better and safer at the rate for which it is designed.
- Do not overreach. Keep proper footing and balance at all times. Proper footing and balance enables better control of the tool in unexpected situations. Do not use on a ladder or unstable support.
- Do not operate in poor lighting.
- Keep hands, face, and feet at a safe distance from moving parts. Do not touch or try to stop the cutting blades when they are moving.
- Do not use tool if switch does not turn it on or off. A tool that cannot be controlled with the switch is dangerous and must be repaired.
- Avoid accidental starting. Be sure switch is in the locked or off position before inserting battery pack. Carrying tools with your finger on the switch or inserting the battery pack into a tool with the switch on invites accidents.
- Avoid dangerous environments. Do not use the tool in damp or wet locations. Do not operate the hedge trimmer in rain.
- Maintain tools with care. Keep cutting tools sharp and clean. Properly maintained tools with sharp cutting edges are less likely to bind and are easier to control.
- Check for misalignment or binding of moving parts, breakage of parts, and any other condition that may affect the tool's operation. If damaged, have the tool serviced before using. A guard or any other part that is damaged should be carefully checked to determine that it will operate properly and perform its intended function. Many accidents are caused by poorly maintained tools.
- Keep the tool and its handle dry, clean and free from oil and grease. Always use a clean cloth when cleaning. Never use brake fluids, gasoline, petroleum-based products, or any strong solvents to clean your tool. Following this rule will reduce the risk of loss of control and deterioration of the enclosure plastic.
- To avoid the risk of electric shock, do not operate unit in damp or wet locations.
- Use only accessories that are recommended by the manufacturer for your model. Accessories that may be suitable for one tool may create a risk of injury when used on another tool.
- Tool service must be performed only by qualified repair personnel. Service or maintenance performed by unqualified personnel may result in a risk of injury.
- When servicing a tool, use only identical replacement parts. Follow instructions in the Maintenance section of this manual. Use of unauthorized parts or failure to follow Maintenance instructions may create a risk of shock or injury.

# SPECIFIC SAFETY RULES

- Before starting the hedge trimmer, make sure the blade is not in contact with any object.
- Stop the unit, remove the battery pack, and make sure the blade has stopped before setting the unit down.
- Never cut any material with a diameter larger than 3/8 in.
- **DANGER:** Risk of cut. Keep hands away from blades. Do not attempt to remove cut material or hold material to be cut when blades are moving. Keep both hands on handles when power is on. Make sure battery pack is removed and the trigger is released when clearing jammed material from blades. Do not grasp the exposed cutting blades or cutting edges when picking up or holding the unit.
- Blades coast after unit is turned off.
- Always stop the motor when cutting is delayed or when walking from one cutting location to another.
- Keep unit clean of grass clippings and other materials. They may become lodged in the cutting blades.
- Store the unit inside in a dry place, either locked up or up high to prevent unauthorized use or damage. Keep out of the reach of children or untrained individuals.
- Replace scabbard cover when unit is not in use.
- Never douse or squirt the unit with water or any other liquid. Keep handles dry, clean, and free from debris. Clean after each use; see **Storage** instructions.
- Secure the unit while transporting.

## BATTERY SAFETY













- Battery operated units do not have to be plugged into an electrical outlet; therefore, they are always in operating condition. Be aware of possible hazards even when unit is not operating.
- Remove the battery pack before making any adjustments, cleaning, storing, or removing material from the unit, or when not in use.
- A battery pack must be recharged only with the specified charger for the battery pack. A charger that may be suitable for one type of battery pack may create a risk of fire when used with another battery pack. Use battery pack only with charger listed.
- To reduce the risk of explosion and possible injury, **DO NOT** place battery units or their batteries near fire or heat.
- Do not mutilate the battery pack. Released electrolyte is corrosive and may cause damage to the eyes or skin. It may be toxic if swallowed.

MODEL	BATTERY PACK	CHARGER (P113)
P2601	(P104 Li-ion) 130429001, 130429002 130155001	140501001 140501005
	(P100 Ni-Cd) 130255004, 130224028	
	BATTERY PACK	CHARGER (P110)
	(P100 Ni-Cd) 130255004, 130224028	1423701, 140237021, 140237023

- Batteries can explode in the presence of a source of ignition, such as a pilot light. To reduce the risk of serious personal injury, never use any cordless product in the presence of open flame. An exploded battery pack can propel debris and chemical. If exposed, flush with water immediately.
- Do not charge unit in a damp or wet location. Following this rule will reduce the risk of electric shock.
- For best results, your battery unit should be charged in a location where the temperature is more than 50°F (10°C) but less than 100°F (38°C). Do not store outside or in vehicles.
- Under extreme usage or temperature conditions, battery pack leakage may occur. If liquid comes in contact with your skin, wash immediately with soap and water, then neutralize with lemon juice or vinegar. If liquid gets into your eyes, flush them with clean water for at least 10 minutes, then seek immediate medical attention.
- Do not crush, drop or damage battery pack. Do not use a battery pack or charger that has been dropped or received a sharp blow. A damaged battery is subject to explosion. Properly dispose of a dropped or damaged battery immediately.
- **Do not dispose of batteries in a fire.** The cell may explode. Batteries should be recycled. Consult your local waste authority for information regarding available recycling and/or disposal options.
- **When battery pack is not in use, keep it away from other metal objects like: paper clips, coins, keys, nails, screws, or other small metal objects that can make a connection from one terminal to another.** Shorting the battery pack terminals together may cause sparks, burns, or a fire.
- **Save these instructions.** Refer to them frequently and use them to instruct others who may use this tool. If you loan someone this tool, loan them these instructions also to prevent misuse of the product and possible injury.



# SYMBOLS

Some of the following symbols may be used on this product. Please study them and learn their meaning. Proper interpretation of these symbols will allow you to operate the product better and safer.

SYMBOL	NAME	EXPLANATION
V	Volts	Voltage
A	Amperes	Current
Hz	Hertz	Frequency (cycles per second)
W	Watt	Power
hrs	Hours	Time
~	Alternating Current	Type of current
==	Direct Current	Type or a characteristic of current
$n_0$	No Load Speed	Rotational speed, at no load
	Class II Construction	Double-insulated construction
.../min	Per Minute	Revolutions, strokes, surface speed, orbits etc., per minute
	Wet Conditions Alert	Do not expose to rain or use in damp locations.
	Safety Alert Symbol	Precautions that involve your safety.
	Read the Operator's Manual	To reduce the risk of injury, user must read and understand operator's manual before using this product.
	Eye Protection	Always wear safety goggles or safety glasses with side shields and, as necessary, a full face shield when operating this product.
	Keep Bystanders Away	Keep all bystanders at least 50 ft. away.
	Gloves	Wear non-slip, heavy-duty protective gloves when handling the blades.
	Operate With Two Hands	Hold and operate the hedge trimmer properly with both hands.
	Moving Parts	Keep hands away from moving parts.
	Electric Shock	Failure to use in dry conditions and to observe safe practices can result in electric shock.
	Kickback	DANGER! Beware of kickback.
	Sharp Blade	Sharp cutting blades. To prevent serious injury, do not touch cutting blades.

# SYMBOLS

The following signal words and meanings are intended to explain the levels of risk associated with this product.

SYMBOL	SIGNAL	MEANING
	<b>DANGER:</b>	Indicates an imminently hazardous situation, which, if not avoided, will result in death or serious injury.
	<b>WARNING:</b>	Indicates a potentially hazardous situation, which, if not avoided, could result in death or serious injury.
	<b>CAUTION</b>	Indicates a potentially hazardous situation, which, if not avoided, may result in minor or moderate injury.
	<b>CAUTION</b>	(Without Safety Alert Symbol) Indicates a situation that may result in property damage.

## SERVICE

Servicing requires extreme care and knowledge and should be performed only by a qualified service technician. For service we suggest you return the product to your nearest **AUTHORIZED SERVICE CENTER** for repair. When servicing, use only identical replacement parts.



### WARNING:

To avoid serious personal injury, do not attempt to use this product until you read thoroughly and understand completely the operator's manual. If you do not understand the warnings and instructions in the operator's manual, do not use this product. Call Ryobi customer service for assistance.



### WARNING:



The operation of any power tool can result in foreign objects being thrown into your eyes, which can result in severe eye damage. Before beginning power tool operation, always wear safety goggles or safety glasses with side shields, or a full face shield when needed. We recommend Wide Vision Safety Mask for use over eyeglasses or standard safety glasses with side shields. Always use eye protection which is marked to comply with ANSI Z87.1.

## SAVE THESE INSTRUCTIONS

# FEATURES

## PRODUCT SPECIFICATIONS

Motor.....	18 V DC	Cutting Capacity.....	3/8 in.
Blade Length.....	18 in.	Net Weight.....	4.8 lbs.

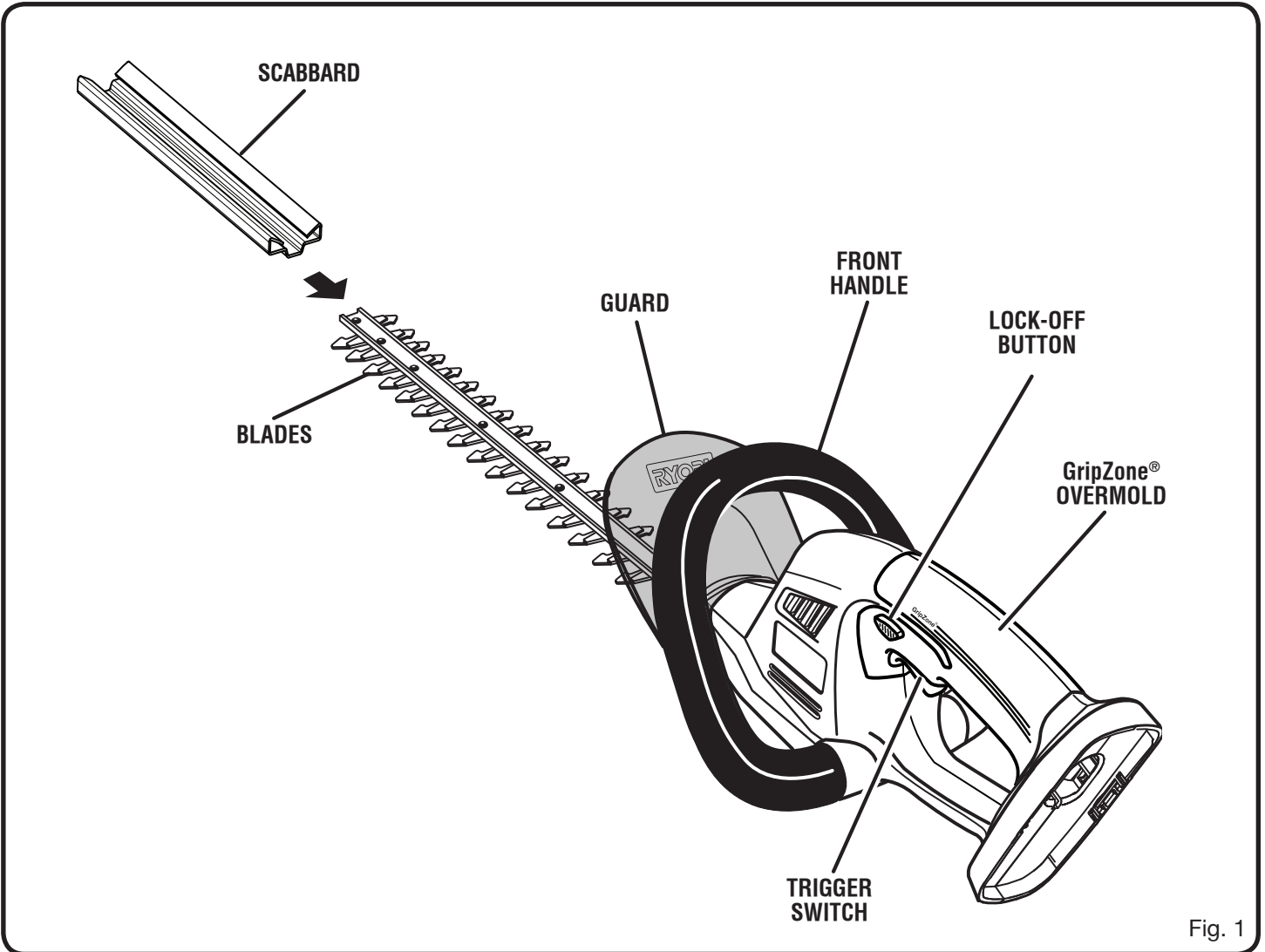

Fig. 1

## KNOW YOUR HEDGE TRIMMER

See Figure 1.

The safe use of this product requires an understanding of the information on the tool and in this operator's manual as well as a knowledge of the project you are attempting. Before use of this product, familiarize yourself with all operating features and safety rules.

### GripZone® OVERMOLD

GripZone® overmold provides added user comfort.

### GUARD

The guard helps to deflect chips or other debris away from the operator's hands.

### SCABBARD

The scabbard keeps the operator from coming in contact with the sharp blades when the tool is not in use. It also helps keep the blades from being nicked or damaged when the tool is in storage.

### LOCK-OFF BUTTON

The lock-off button prevents unintentional starting of the hedge trimmer.

# ASSEMBLY

## UNPACKING

This product has been shipped completely assembled.

- Carefully remove the product and any accessories from the box. Make sure that all items listed in the packing list are included.
- Inspect the product carefully to make sure no breakage or damage occurred during shipping.
- Do not discard the packing material until you have carefully inspected and satisfactorily operated the product.
- If any parts are damaged or missing, please call 1-800-860-4050 for assistance.

## PACKING LIST

Hedge Trimmer  
Scabbard  
Operator's Manual

### **WARNING:**

If any parts are damaged or missing do not operate this product until the parts are replaced. Failure to heed this warning could result in serious personal injury.

### **WARNING:**

Do not attempt to modify this product or create accessories not recommended for use with this product. Any such alteration or modification is misuse and could result in a hazardous condition leading to possible serious personal injury.

### **WARNING:**

To prevent accidental starting that could cause serious personal injury, always remove the battery pack from the product when assembling parts.

# OPERATION

### **WARNING:**

Do not allow familiarity with this product to make you careless. Remember that a careless fraction of a second is sufficient to inflict serious injury.

### **WARNING:**

Always wear safety goggles or safety glasses with side shields when operating power tools. Failure to do so could result in objects being thrown into your eyes resulting in possible serious injury.

### **WARNING:**

Do not use any attachments or accessories not recommended by the manufacturer of this product. The use of attachments or accessories not recommended can result in serious personal injury.

## APPLICATIONS

You may use this product for the purpose listed below:

- Trimming and shaping hedges and shrubbery

This product will accept Ryobi One+ 18 V lithium-ion battery packs and Ryobi One+ 18 V nickel-cadmium battery packs.

For complete charging instructions, refer to the Operator's Manual for the battery packs and chargers listed in the General Safety Rules.



# OPERATION

## TO INSTALL BATTERY PACK

See Figure 2.

- Place the battery pack in the hedge trimmer. Align the raised rib on the battery pack with groove in the hedge trimmer's battery port.
- Make sure the latches on each side of the battery pack snap in place and that the battery pack is secured in the hedge trimmer before beginning operation.

### CAUTION:

When placing battery pack in the tool, be sure raised rib on battery pack aligns with the bottom of the tool and latches into place properly. Improper installation of the battery pack can cause damage to internal components.

## TO REMOVE BATTERY PACK

See Figure 2.

- Locate the latches on the side of the battery pack and depress both sides to release the battery pack from the hedge trimmer.

### ⚠ WARNING:

Battery tools are always in operating condition. Therefore, switch should always be locked when not in use or carrying at your side.

## STARTING THE HEDGE TRIMMER

See Figure 3.

- Remove the scabbard.
- Press and hold the lock-off button.
- Depress the switch trigger.
- Release the lock-off button. Continue to depress the switch trigger for extended operation.

## STOPPING THE HEDGE TRIMMER

See Figure 3.

- Release the switch trigger to stop the hedge trimmer.
- Upon release of the switch trigger, the lock-off button will automatically reset to the locked position.

## HOLDING THE HEDGE TRIMMER

See Figure 4.

The unit has both a front and rear handle. With the blade directed away from you, hold the unit by both handles.

### ⚠ WARNING:

Always keep both hands on the hedge trimmer handles. Never hold shrubs with one hand and operate the hedge trimmer with the other. Failure to heed this warning may result in serious injury.

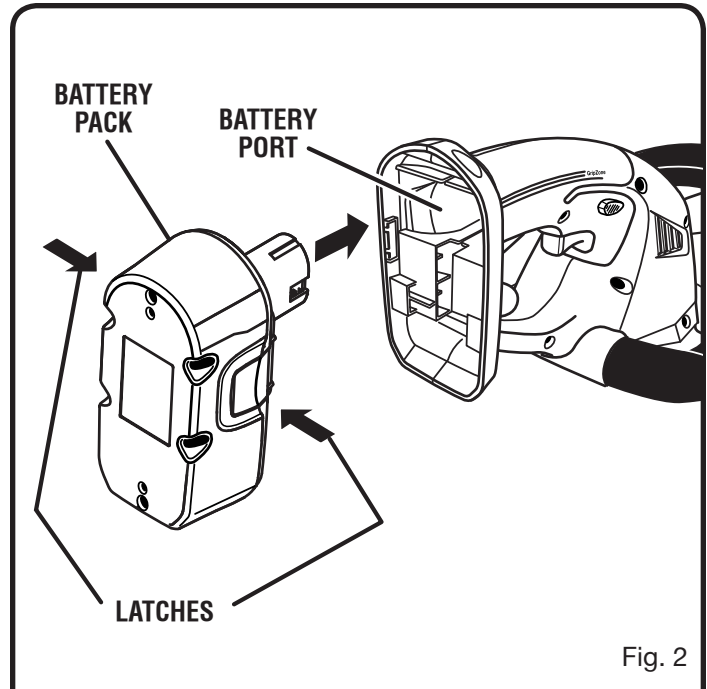

Fig. 2

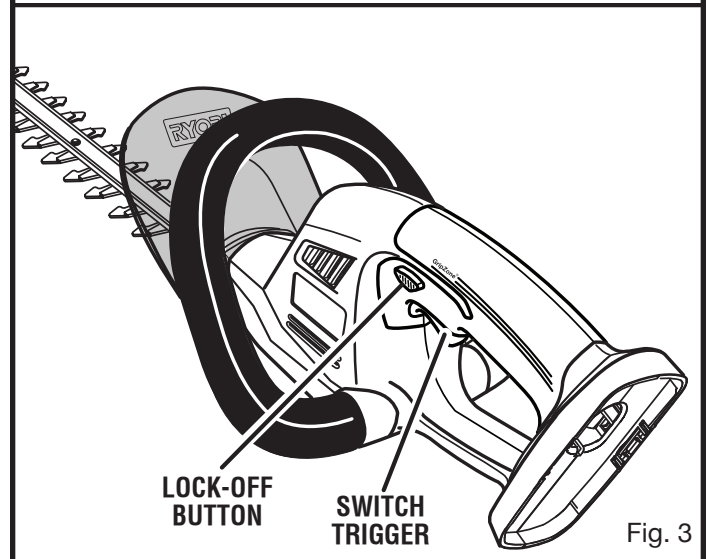

Fig. 3

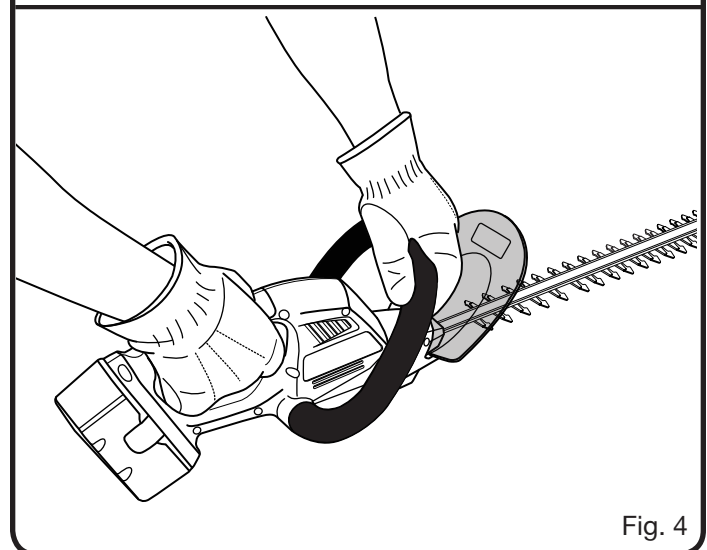

Fig. 4

# OPERATION

## OPERATING TIPS

See Figures 5 - 6.

### **⚠ DANGER:**

If blade jams on any electrical cord or line, DO NOT TOUCH THE BLADE! IT CAN BECOME ELECTRICALLY LIVE AND VERY DANGEROUS. Continue to hold the hedge trimmer by the insulated rear handle or lay it down and away from you in a safe manner. Disconnect the electrical service to the damaged line or cord before attempting to free the blade from the line or cord. Failure to heed this warning will result in serious personal injury or possible death.

### **⚠ WARNING:**

Clear the area to be cut before each use. Remove all objects such as cords, lights, wire, or loose string which can become entangled in the cutting blade and create a risk of serious personal injury.

- Before starting the hedge trimmer, hold the unit with both hands with the cutting blades directed away from you. Always use the hedge trimmer properly.
- Do not force the hedge trimmer through heavy shrubbery. This can cause the blades to bind and slow down. If the blades slow down, reduce the pace.
- Do not try to cut stems or twigs that are larger than 3/8 in. thick, or those obviously too large to feed into the cutting blade. Use a non-powered hand saw or pruning saw to trim large stems.
- If blades do become jammed, stop the motor, allow the blades to stop and remove the battery pack before attempting to remove the obstruction.
- If desired, you can use a string to help cut your hedge level. Decide how high you want the hedge. Then, stretch a piece of string along the hedge at this height. Trim the hedge just above this guide line of string. Trim the side of a hedge so that it will be slightly narrower at the top. More of the hedge will be exposed when shaped this way, and it will be more uniform.

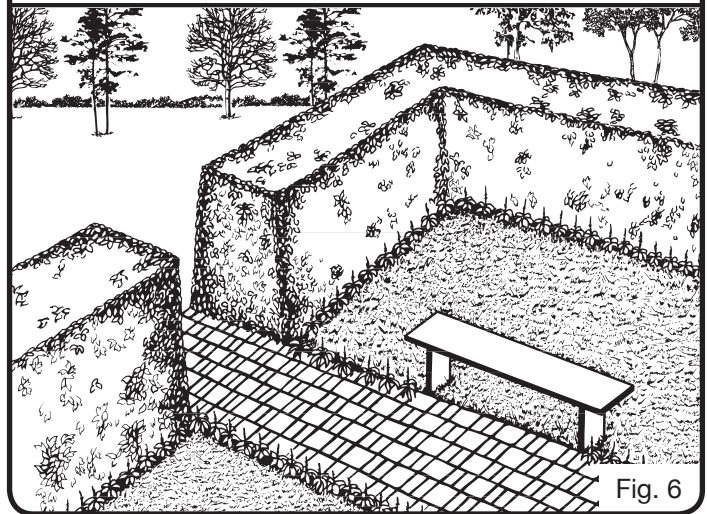
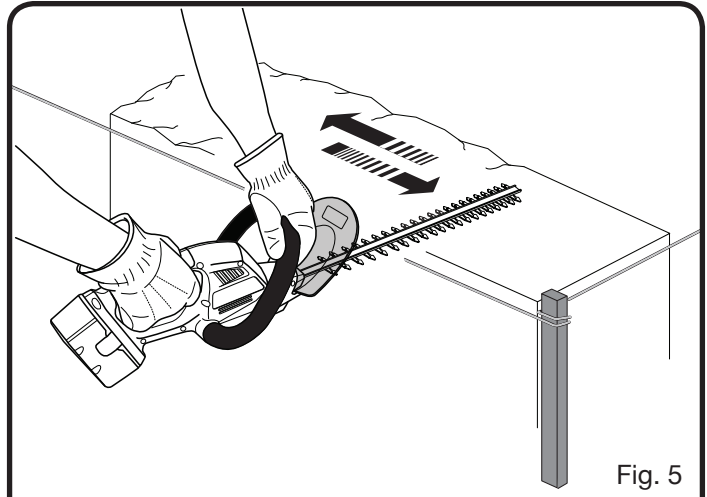

- Always hold hedge trimmer with both hands when operating. Use a firm grip on the handles. The unit is used for cutting in either direction in a slow, sweeping action from side to side.
- Wear gloves when trimming thorny or prickly growth.
- When trimming new growth, use a wide sweeping action, so that the stems are fed directly into the cutting blade. Older growth will have thicker stems and will be trimmed easiest by using a sawing movement.

# MAINTENANCE

## WARNING:

When servicing, use only identical replacement parts. Use of any other parts may create a hazard or cause product damage.

## WARNING:

Always wear safety goggles or safety glasses with side shields during power tool operation or when blowing dust. If operation is dusty, also wear a dust mask.

## WARNING:

To avoid serious personal injury, always remove the battery pack from the product before inspecting, cleaning or performing any maintenance.

## GENERAL MAINTENANCE

Avoid using solvents when cleaning plastic parts. Most plastics are susceptible to damage from various types of commercial solvents and may be damaged by their use. Use clean cloths to remove dirt, dust, oil, grease, etc.

## BATTERIES

This product will accept Ryobi One+ 18 V lithium-ion battery packs and Ryobi One+ 18 V nickel-cadmium battery packs. Length of service from each charging will depend on the type of work you are doing.

The batteries for this product have been designed to provide maximum trouble-free life. However, like all batteries, they will eventually wear out. Do not disassemble battery pack and attempt to replace the batteries. Handling of these batteries, especially when wearing rings and jewelry, could result in a serious burn.

To obtain the longest possible battery life, we suggest the following:

### For lithium-ion batteries:

- Remove the battery pack from the charger once it is fully charged and ready for use.

For battery pack storage longer than 30 days:

- Store the battery pack where the temperature is below 80°F and away from moisture.
- Store battery packs in a 30%-50% charged condition.
- Every six months of storage, charge the pack as normal.

### For nickel-cadmium batteries:

- Remove the battery pack from the charger once it is fully charged and ready for use.

For battery pack storage longer than 30 days:

- Store the battery pack where the temperature is below 80°F.
- Store battery packs in a “discharged” condition.

## WARNING:

Do not at any time let brake fluids, gasoline, petroleum-based products, penetrating oils, etc., come in contact with plastic parts. Chemicals can damage, weaken or destroy plastic which may result in serious personal injury.

Only the parts shown on the parts list are intended to be repaired or replaced by the customer. All other parts should be replaced at an Authorized Service Center.

## TRANSPORTING AND STORING

- Always place the scabbard on the blade before storing or transporting the hedge trimmer. Use caution to avoid the sharp teeth of the blade.
- Clean the hedge trimmer thoroughly before storing. Store the hedge trimmer indoors, in a dry place that is inaccessible to children. Keep away from corrosive agents such as garden chemicals and de-icing salts.

## BLADE REPLACEMENT

When replacing the blade on this unit, use only replacement blade part no. 3013214.

## BATTERY PACK REMOVAL AND PREPARATION FOR RECYCLING



To preserve natural resources, please recycle or dispose of batteries properly.

This product uses nickel-cadmium and lithium-ion batteries. Local, state or federal laws may prohibit disposal of batteries in ordinary trash.

Consult your local waste authority for information regarding available recycling and/or disposal options.

## WARNING:

Upon removal, cover the battery pack's terminals with heavy-duty adhesive tape. Do not attempt to destroy or disassemble battery pack or remove any of its components. Lithium-ion and nickel-cadmium batteries must be recycled or disposed of properly. Also, never touch both terminals with metal objects and/or body parts as short circuit may result. Keep away from children. Failure to comply with these warnings could result in fire and/or serious injury.

# MAINTENANCE

## WARNING:

Blades are sharp. When handling the blade assembly, wear non-slip, heavy-duty protective gloves. Do not place your hand or fingers between blades or in any position where they could get pinched or cut. NEVER touch blades or service unit with battery pack installed.

## REPLACING BLADES

See Figures 7 - 8.

Periodically inspect the blades for damage and wear. Always use the manufacturer's specified replacement blades.

### Removing the blade:

- Remove the battery pack from the hedge trimmer.
- Place the hedge trimmer upside down on a workbench and remove the four (4) blade cover screws.
- Remove the blade cover.
- Remove the bar plate from the two pins.
- Remove the retaining ring, washer, and retaining plate.
- Align the cams.

**NOTE:** The yokes cannot be lifted unless they clear the lip of the cams.

- Remove the four (4) blade screws.
- Each blade has an oval yoke attached at one end. Slide the blades into position so the yokes align. Remove the blade from the housing.

### Installing a new blade:

Before installing a new blade, apply a lithium-based grease to the areas indicated.

- Align the cams.
- Place the new blade on the housing and align the yokes to drop into place. Rotate the blade so that it drops past the lower cam.

**NOTE:** When properly aligned, the blade assembly fits in the recessed slot in the motor housing.

- Reinstall the four (4) blade screws and tighten securely.
- Reinstall the retaining plate, washer, and retaining ring.
- Reinstall the bar plate over the two pins.
- Install the blade cover using the four (4) blade cover screws. Tighten securely.

## WARNING:

Make sure the bottom plate is replaced before inserting the battery pack and starting the hedge trimmer. Failure to do so will expose internal parts, which could cause an accident or electrical shock, resulting in serious injury.

**NOTE:** If binding occurs after replacing the blade assembly, repeat the steps under **Removing the Blade** and **Installing a New Blade**.

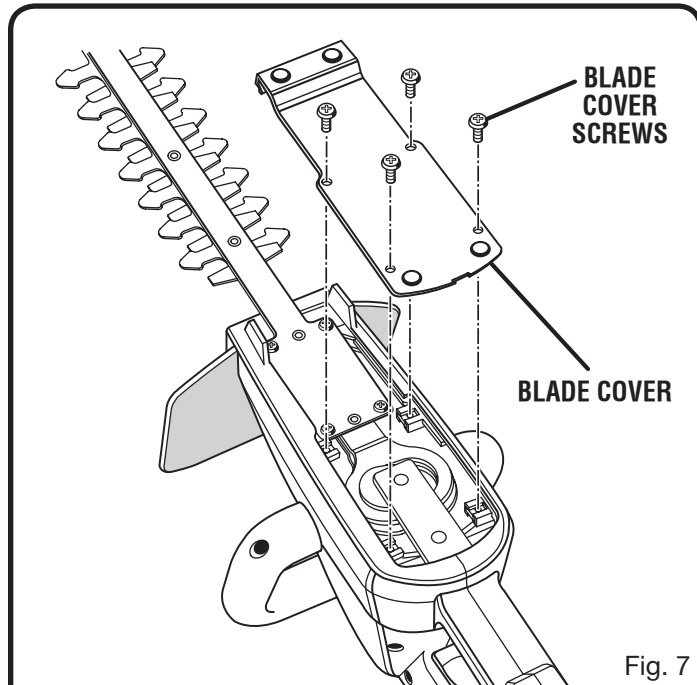

Fig. 7

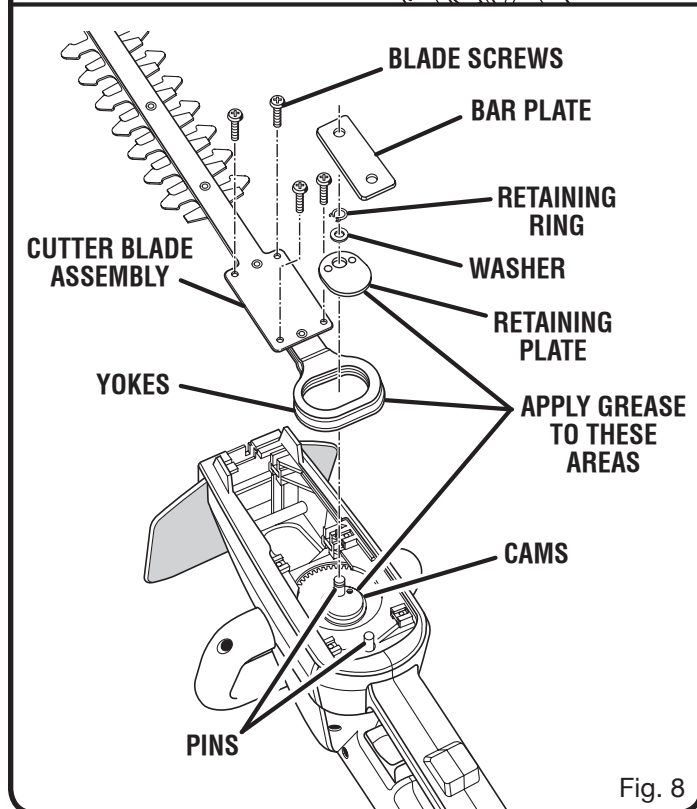

Fig. 8

# MAINTENANCE

## LUBRICATING THE BLADE

See Figure 9.

For easier operation and longer blade life, lubricate the hedge trimmer blade before and after each use.

- Remove the battery pack from the hedge trimmer.
- Lay the hedge trimmer on a flat surface. Apply light weight machine oil along the edge of the top blade.

If you will be using the hedge trimmer for an extended period, it is advisable to oil the blade during use.

**NOTE:** Do not oil while the hedge trimmer is running.

- Stop the hedge trimmer.
- Remove the battery pack.
- Lubricate the hedge trimmer as described above.
- Reinstall the battery pack and resume use.

## SHARPENING THE BLADE

See Figure 10.

- Allow the blades of the hedge trimmer to come to a stop in the position shown. This will allow clearance for the file between the cutter teeth and the guard teeth.
- Remove the battery pack from the hedge trimmer.
- Clamp the blade assembly in a vise and file the exposed cutting surface of each blade tooth with an 8 in. smooth round file, 1/4 in. or 7/32 in. in diameter. Be sure to retain the original angle of the tooth when filing.
- Remove the hedge trimmer from the vise, replace the battery pack, and restart the hedge trimmer. Allow the blades of the hedge trimmer to come to a stop so that the unsharpened edges of the cutter blade teeth are exposed.
- Remove battery pack from hedge trimmer and repeat the sharpening procedure as described above.

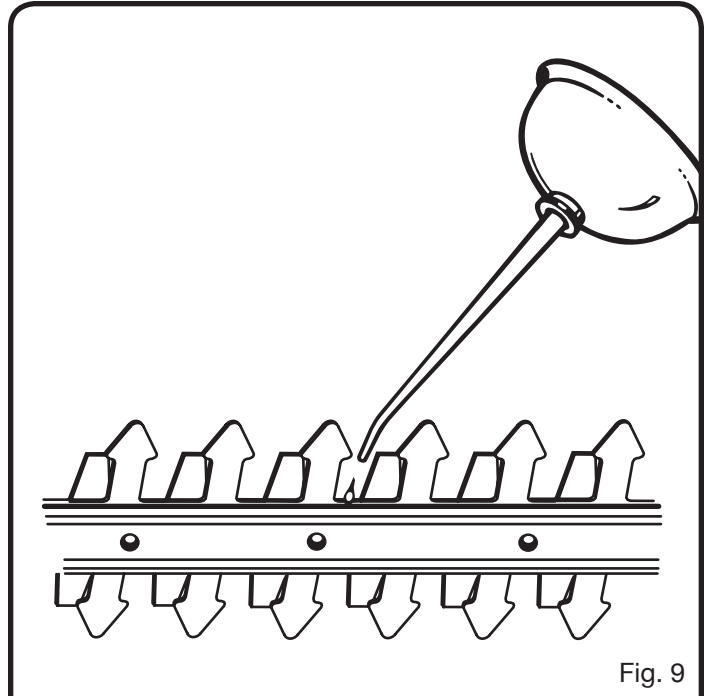

Fig. 9

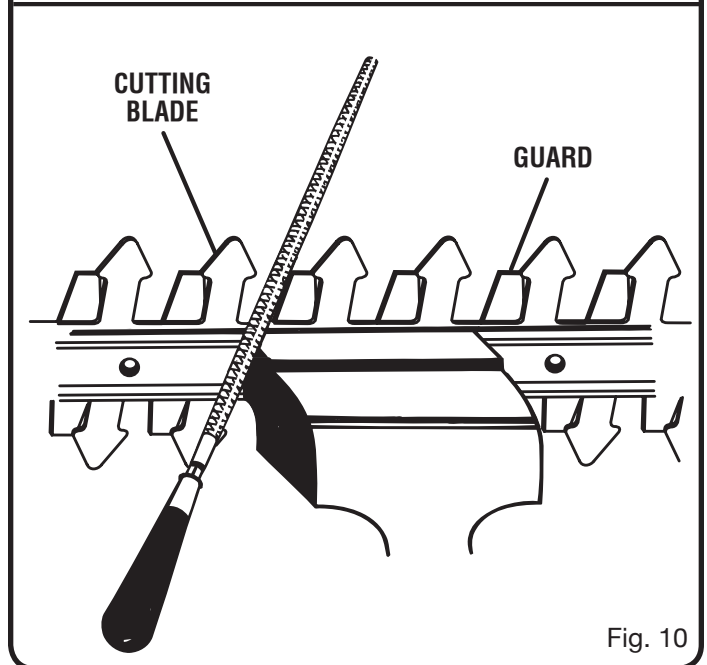

Fig. 10

# MAINTENANCE

## CLEANING THE HEDGE TRIMMER

- Slide the scabbard over the blade.
- Remove the battery pack.
- Clean dirt and debris from the body of the hedge trimmer, using a damp cloth with a mild detergent.

**NOTE:** Do not use any strong detergents on the plastic housing or the handle. They can be damaged by certain aromatic oils such as pine and lemon, and by solvents such as kerosene.

- Moisture can cause a shock hazard. Wipe off any moisture with a soft dry cloth.
- Use a small brush or the air discharge of a small vacuum cleaner brush to clear dust or debris from the air vents on the motor housing.

## STORING THE HEDGE TRIMMER

See Figure 11.

- Clean the hedge trimmer thoroughly before storing. Store the hedge trimmer in a dry, well-ventilated place that is inaccessible to children. Keep away from corrosive agents such as garden chemicals and de-icing salts.
- Always place the scabbard on the cutting blades before storing.

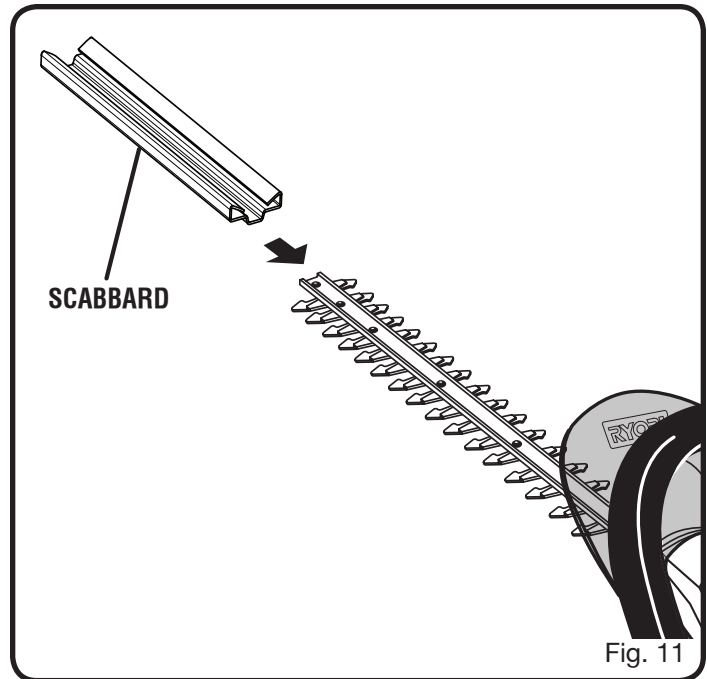

# WARRANTY

## LIMITED WARRANTY STATEMENT

Techtronic Industries North America, Inc., warrants to the original retail purchaser that this RYOBI® brand outdoor product is free from defect in material and workmanship and agrees to repair or replace, at Techtronic Industries North America, Inc.'s, discretion, any defective product free of charge within these time periods from the date of purchase.

- Two years if the product is used for personal, family or household use;
- 90 days, if used for any other purpose, such as commercial or rental.

This warranty extends to the original retail purchaser only and commences on the date of the original retail purchase.

Any part of this product found in the reasonable judgment of Techtronic Industries North America, Inc. to be defective in material or workmanship will be repaired or replaced without charge for parts and labor by an authorized service center for RYOBI® brand outdoor products (Authorized Ryobi Service Center).

The product, including any defective part, must be returned to an authorized Ryobi service center within the warranty period. The expense of delivering the product to the service center for warranty work and the expense of returning it back to the owner after repair or replacement will be paid by the owner. Techtronic Industries North America, Inc.'s, responsibility in respect to claims is limited to making the required repairs or replacements and no claim of breach of warranty shall be cause for cancellation or rescission of the contract of sale of any RYOBI® brand outdoor product. Proof of purchase will be required by the dealer to substantiate any warranty claim. All warranty work must be performed by an authorized service dealer.

This warranty is limited to ninety (90) days from the date of original retail purchase for any RYOBI® brand outdoor product that is used for rental or commercial purposes, or any other income-producing purpose.

This warranty does not cover any product that has been subject to misuse, neglect, negligence, or accident, or that has been operated in any way contrary to the operating instructions as specified in this operator's manual. This warranty does not apply to any damage to the product that is the result of improper maintenance or to any product that has been altered or modified. The warranty does not extend to repairs made necessary by normal wear or by the use of parts or accessories which are either incompatible with the RYOBI® brand outdoor product or adversely affect its operation, performance, or durability. In addition, this warranty does not cover:

- A. Tune-ups – Spark Plugs, Carburetor, Carburetor Adjustments, Ignition, Filters
- B. Wear items – Bump Knobs, Outer Spools, Cutting Lines, Inner Reels, Starter Pulleys, Starter Ropes, Drive Belts, Tines, Felt Washers, Hitch Pins, Mulching Blades, Blower Fans, Blower and Vacuum Tubes, Vacuum Bag and Straps, Guide Bars, Saw Chains

Techtronic Industries North America, Inc., reserves the right to change or improve the design of any RYOBI® brand outdoor product without assuming any obligation to modify any product previously manufactured.

ALL IMPLIED WARRANTIES ARE LIMITED IN DURATION TO THE STATED WARRANTY PERIOD. ACCORDINGLY, ANY SUCH IMPLIED WARRANTIES INCLUDING MERCHANTABILITY, FITNESS FOR A PARTICULAR PURPOSE, OR OTHERWISE, ARE DISCLAIMED IN THEIR ENTIRETY AFTER THE EXPIRATION OF THE APPROPRIATE TWO-YEAR, ONE-YEAR, OR NINETY-DAY WARRANTY PERIOD. TECHTRONIC INDUSTRIES NORTH AMERICA, INC.'S, OBLIGATION UNDER THIS WARRANTY IS STRICTLY AND EXCLUSIVELY LIMITED TO THE REPAIR OR REPLACEMENT OF DEFECTIVE PARTS AND TECHTRONIC INDUSTRIES NORTH AMERICA, INC., DOES NOT ASSUME OR AUTHORIZE ANYONE TO ASSUME FOR THEM ANY OTHER OBLIGATION. SOME STATES DO NOT ALLOW LIMITATIONS ON HOW LONG AN IMPLIED WARRANTY LASTS, SO THE ABOVE LIMITATION MAY NOT APPLY TO YOU. TECHTRONIC INDUSTRIES NORTH AMERICA, INC., ASSUMES NO RESPONSIBILITY FOR INCIDENTAL, CONSEQUENTIAL, OR OTHER DAMAGES INCLUDING, BUT NOT LIMITED TO, EXPENSE OF RETURNING THE PRODUCT TO AN AUTHORIZED RYOBI SERVICE CENTER AND EXPENSE OF DELIVERING IT BACK TO THE OWNER, MECHANIC'S TRAVEL TIME, TELEPHONE OR TELEGRAM CHARGES, RENTAL OF A LIKE PRODUCT DURING THE TIME WARRANTY SERVICE IS BEING PERFORMED, TRAVEL, LOSS OR DAMAGE TO PERSONAL PROPERTY, LOSS OF REVENUE, LOSS OF USE OF THE PRODUCT, LOSS OF TIME, OR INCONVENIENCE. SOME STATES DO NOT ALLOW THE EXCLUSION OR LIMITATION OF INCIDENTAL OR CONSEQUENTIAL DAMAGES, SO THE ABOVE LIMITATION OR EXCLUSION MAY NOT APPLY TO YOU.

This warranty gives you specific legal rights, and you may also have other rights which vary from state to state.

This warranty applies to all RYOBI® brand outdoor products manufactured by or for Techtronic Industries North America, Inc., and sold in the United States and Canada.

To locate your nearest Authorized Ryobi Service Center, dial 1-800-860-4050.





## Free Manuals Download Website

<http://myh66.com>

<http://usermanuals.us>

<http://www.somanuals.com>

<http://www.4manuals.cc>

<http://www.manual-lib.com>

<http://www.404manual.com>

<http://www.luxmanual.com>

<http://aubethermostatmanual.com>

Golf course search by state

<http://golfingnear.com>

Email search by domain

<http://emailbydomain.com>

Auto manuals search

<http://auto.somanuals.com>

TV manuals search

<http://tv.somanuals.com>